

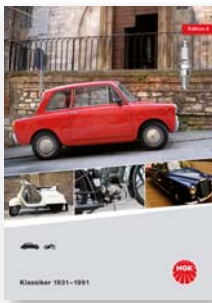

2015 – 2016

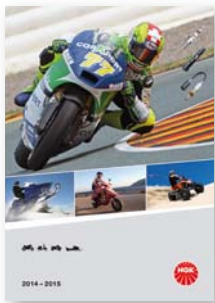



CONTENTS

GB 1-24



INHALTSVERZEICHNIS

D 1-24





# Contents

The spark plugs, glow plugs, and caps listed in our Catalogue can be used in the engines which we recommend in our catalogue. Recognizable mistakes, such as printing errors are subject to careful scrutiny by the user. NGK safeguards for accuracy and the mentioned characteristics in accordance with the current state of the art technology. Basic condition for this is the proper use of the NGK product. The seller's warranty period for faults in material or unsatisfactory performance is 24 months from the date of purchase, provided the prescribed interval changes from the vehicle manufacturer are adhered to. Excluded from this is normal wear and tear and any form of racing activities.

## Comments

1. This application list is only valid for type identification.
2. This catalogue supersedes all previous catalogues.
3. We do not accept any responsibility in respect of legal claims arising out of the contents of this list.
4. Spark Plug recommendations regarding FAA guidelines for aeroplane power units are not included in this edition.

<b>OE worldwide</b> .....	Ⓞ	<b>2</b>
<b>Tightening torques for spark plugs</b> .....	Ⓞ	<b>3</b>
<b>Tightening torques for glow plugs</b> .....	Ⓞ	<b>3</b>
<b>Symbols used on spark plugs</b> .....	Ⓞ	<b>4 – 5</b>
<b>Symbols used on glow plugs</b> .....	Ⓞ	<b>6 – 7</b>
<b>Spark plug comparison table</b> .....	Ⓞ	<b>8</b>
<b>V-Line</b> .....	Ⓞ	<b>9 – 13</b>
<b>LPG LaserLine</b> .....	Ⓞ	<b>14 – 17</b>
<b>D-Power</b> .....	Ⓞ	<b>18</b>
<b>Ceramic glow plugs</b> .....	Ⓞ	<b>19</b>
<b>D-Power overview</b> .....	Ⓞ	<b>20</b>
<b>Racing spark plugs</b> .....	Ⓞ	<b>21 – 23</b>
<b>Location of engine numbers</b> .....	Ⓞ	<b>24</b>

<b>Spark plug series</b> .....	<b>1 – 11</b>
<b>Glow plug series</b> .....	<b>12 – 36</b>
<b>Spark and glow plugs for automobiles from 1990</b> .....	<b>37 – 273</b>
<b>Comparison table</b> .....	<b>274 – 391</b>
<b>PS (HP) ↔ KW</b> .....	<b>392</b>

Deadline 21.05.2014

Subject to change  
2015 – 2016





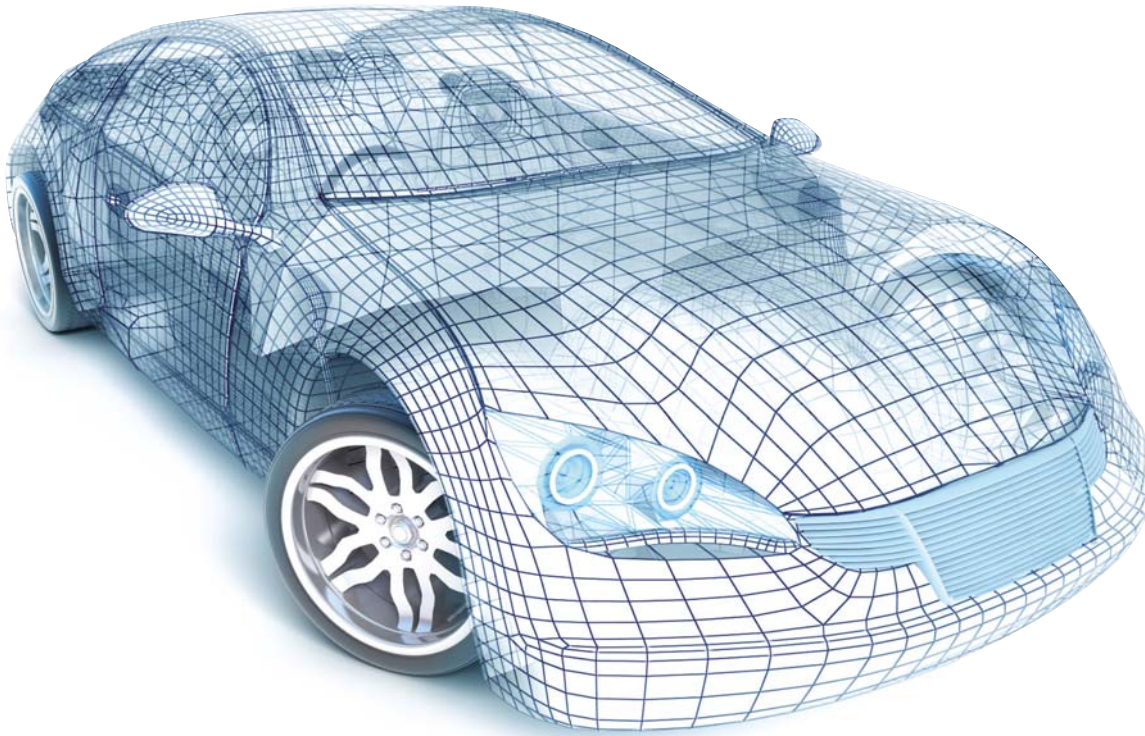

## NGK spark and glow plugs – OEM worldwide

Manufacturer	Spark plugs	Glow plugs
Alfa Romeo	●	●
AMG	●	
Aston Martin	●	
Audi	●	●
Bentley	●	
BMW	●	
Bugatti	●	
Chrysler	●	
Citroën	●	●
Daewoo	●	
Daihatsu	●	●
Ferrari	●	
Fiat	●	●
Ford	●	●
General Motors	●	
Honda	●	●
Hyundai	●	●
Isuzu	●	●
Jaguar	●	●
Kia	●	●
Lancia	●	●

Manufacturer	Spark plugs	Glow plugs
Land Rover	●	●
Lamborghini	●	
Lotus	●	
Maserati	●	
Mazda	●	●
Mercedes	●	●
Mitsubishi	●	●
Nissan	●	●
Opel	●	
Porsche	●	●
Peugeot	●	●
Renault	●	●
Saab	●	
Seat	●	●
Škoda	●	●
Smart	●	●
Subaru	●	●
Suzuki	●	●
Toyota	●	●
Volkswagen	●	●
Volvo	●	●





## Tightening torques for spark plugs

### Torques

A torque wrench is required for the professional installation of a spark plug. Even for professionals the estimation of the tightening torque is nearly impossible.

That is because a torque can be calculated from two sizes which are multiplied by one another: the force which is applied to the respective centre of rotation and the length of the handle.

Most spark plug failures can be traced back to an incorrect tightening torque. If it is set too low, there is a risk of compression losses and overheating. A break of the insulator or middle electrode as a result of vibrations is also feasible.

If the tightening torque is set too high, the spark plug can snap off. The casing can also expand or warp. Heat dissipation zones are disrupted, overheating and melting of the electrodes or even engine damage can occur.

Cylinder head material	Spark plug with flat seat (with gasket)				Spark plug with conical seat	
	Thread diameter				Thread diameter	
	18 mm	14 mm	12 mm	10 mm	18 mm	14 mm
Cast iron head	35-45 Nm	25-35 Nm	15-25 Nm	10-15 Nm	20-30 Nm	15-25 Nm
Aluminium head	35-40 Nm	25-30 Nm	15-20 Nm	10-12 Nm	20-30 Nm	10-20 Nm

The torques depend on the cylinder head material and the thread diameter.

## Tightening torques for spark plugs

### The correct torque

For the professional installation of a glow plug, the use of a torque wrench is recommended. Even for professionals the estimation of the tightening torque is nearly impossible.

That is because a torque can be calculated from two sizes which are multiplied by one another: the force which is applied to the respective centre of rotation and the length of the handle. If the incorrect torque is applied to

a glow plug, a compression loss can result. Based on the vibrations, it is also possible in the case of ceramic glow plugs that the ceramic will break.

The application of a tightening torque which is too great, in particular, can lead to the contraction of the annular gap between the metal case and glow tube. In this case the glow plug overheats and fails.

Tightening torque for glow plugs	
Thread diameter	Tightening torque
8 mm	8-15 Nm
10 mm	15-20 Nm
12 mm	20-25 Nm
14 mm	20-25 Nm
18 mm	20-30 Nm

Tightening torque for the connecting nuts	
Thread diameter	Tightening torque
4 mm (M4)	0,8-1,5 Nm
5 mm (M5)	3,0-4,0 Nm

Glow plugs will only function faultlessly when they are screwed in with the correct torques.

# Symbols used on spark plugs

The standard symbols are shown here. In addition, several special designations are used.

Thread dimensions / Hex. size		Structur		Resistor		Heat Rating	
<b>A</b>	18mm / 25.4	P	Projecting insulator type	R	Resistor	2	
<b>B</b>	14mm / 20.8	M	Small spark plug	Z	Inductive resistor type	4	
<b>C</b>	10mm / 16.0	U	Surface gap, Semi-surface discharge gap or Supplementary gap			5	
<b>D</b>	12mm / 18.0					6	
<b>E</b>	8mm / 13.0	7					
<b>AB</b>	18mm / 20.8	8					
<b>BC</b>	14mm / 16.0	9					
<b>BK</b>	14mm / 16.0	10					
<b>DC</b>	12mm / 16.0						

**B P R 5 E S - 11**

Thread length		Design features		Spark gap	
<b>E</b>	19.0 mm	<b>B</b>	Integral terminal CR8EB	None	motorcycle:0.7-0.8 mm car:0.8-0.9 mm
<b>EH</b>	19.0 mm, half-thread	<b>CM</b>	Oblique ground electrode Compact type (insulator length: 18.5 mm)	-8	0.8 mm
<b>H</b>	12.7 mm	<b>CS</b>	Oblique ground electrode Compact type (insulator length: 18.5 mm)	-9	0.9mm
<b>L</b>	11.2 mm	<b>G, GV</b>	Racing spark plug	-10	1.0mm
<b>F</b>	Tapered-seat type A-F---10.9 mm B-F---11.2 mm B-EF--17.5 mm BM-F--7.8 mm	<b>I</b>	Iridium spark plug	-11	1.1mm
		<b>IX</b>	Iridium IX spark plug	-13	1.3mm
		<b>J</b>	2-projecting-electrode	-14	1.4mm
		<b>K</b>	2-ground-electrode	-15	1.5mm
		<b>-L</b>	Medium heat rating		
None	Bantam type BM---9.5 mm BPM--9.5 mm CM---9.5 mm	<b>-LM</b>	Compact type (insulator length: 14.5mm)		
		<b>N</b>	Special ground electrode	-S	Special gasket
		<b>P</b>	Platinum spark plug	-E	Special resistance
		<b>Q</b>	4-ground-electrode		
		<b>S</b>	Standard type		
		<b>T</b>	3-ground-electrode		
		<b>U</b>	Semi-surface discharge gap		
		<b>VX</b>	VX spark plug		
		<b>Y</b>	V-grooved center electrode		
		<b>Z</b>	Special design		

# Symbols used on spark plugs

The standard symbols are shown here. In addition, several special designations are used.

Plug Type		Thread dimensions / Hex. size				
<b>D</b>	High ignitability plug : Double fine electrodes	KA	Ø12.0	19.0mm	Dichtring	14,0
<b>I</b>	Iridium spark plug	KB	Ø12.0	19.0 mm	Gasket	Bi-Hex 14.0
<b>L</b>	Long thread reach plug	MA	Ø10.0	19.0 mm	Gasket	14,0
<b>P</b>	Platinum spark plug	NA	Ø12.0	17.5 mm	Tapered-seat	14,0
<b>S</b>	High ignitability plug : Square tip type	F	Ø14.0	19.0 mm	Gasket	16,0
<b>Z</b>	Extended Gap	G	Ø14.0	19.0 mm	Gasket	20,8
Above alphabets are occasionally used in combination. Ex. ILFR..., PLZFR... "L", long thread reach, is prior to other letters which stand for thread reach. Ex. • Gasket type FR5AP-11;reach 19.0mm LFR5AP-11;reach 26.5mm • Tapered-seat type PTR5C-13;reach 17.5mm PLTR6A-10G;reach 25.0mm		J	Ø12.0	19.0 mm	Gasket	18,0
		K	Ø12.0	19.0 mm	Gasket	16,0
		L	Ø10.0	12.7 mm	Gasket	16,0
		M	Ø10.0	19.0 mm	Gasket	16,0
		T	Ø14.0	17.5 mm	Tapered-seat	16,0
		U	Ø14.0	11.2 mm	Tapered-seat	16,0
		W	Ø18.0	10.9 mm	Tapered-seat	20,8
		X	Ø14.0	9.5 mm	Gasket	20,8
		Y	Ø14.0	11.2 mm	Tapered-seat	16,0

P
F
R
5
A
- 11

Resistor		Heat Rating		Design	Spark gap		
<b>R</b>	Resistor	2		A,B,C... Suffix code	None	motorcycle:0.7-0.8mm car:0.8-0.9mm	
		4		- 7	0.7mm		
		5		- 9	0.9mm		
		6		I	One-side Iridium spark plug	-10	1.0mm
		7		P	One-side Platinum spark plug	-11	1.1mm
		8				-13	1.3mm
		9				-14	1.4mm
		10				-15	1.5mm
						-A	Non gasket
						-D	Metal shell plating spec change
					-E	Special resistance	
					-G	Copper core ground electrode	
					-H	Special thread type	
					-J	2-ground-electrode	
					-K	Vibration-resistant ground electrode	
					-N	Special ground electrode	
					-Q	4-ground-electrode	
					-S	Special gasket	
					-T	3-ground-electrode	



# Symbols used on metal glow plugs

Y - 2 0 4 T S 1

Model / Type		Tread Size		Battery Voltage		Serial Number	Heating Characteristics		Special Tube Material	Modification or Revision
Y/YS	Sheathed Type	1	10 mm	0-4	12 V		this figure is the serial number	A		
YD	Sheathed with non-body earth type	2	10 mm	5-9	24 V	J		SRM type		
		3	10 mm			R, M, U		QGS type		
		4	14 mm			T, V		Fast Heat or Rapid Glow type		
		5	10 mm			No Letter		Standard type		
		6	10 mm							
		7	10 mm							
		8	18 mm							
		9	12 mm							
						*Y- 109, Y- 159, Y- 171 for Caterpillar 3/8" (ca. 9.5mm)				<b>Declaration</b> AQGS => Advanced Quick Glow System  SRM Self Regulating metal Glow Plug  QGS Quick Glow System

Y 1 001 A S 1

Model / Type		Thread Size		Serial Number / Battery Voltage		Heating Characteristics	Special Tube Material	Modification or Revision	
Sheathed Type		1	10 mm	001-899	12 V				A
		2	12 mm	901-999	24 V	J	SRM type		
		4	14 mm			R, M, U	QGS type		
		8	8 mm			T, V	Fast Heat or Rapid Glow type		
		9	9 mm			No Letter	Standard type		
								<b>Declaration</b> AQGS => Advanced Quick Glow System  SRM Self Regulating metal Glow Plug  QGS Quick Glow System	

# Symbols used on metal glow plugs

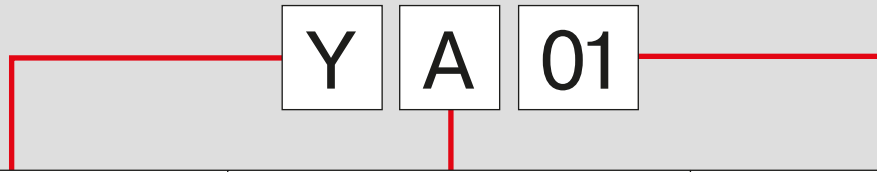

Sheathed Type	Standard type		Serial Number
	A	Standard type	Serial Number
Sheathed Type (Thread size: 8mm or 9mm)	E	QGS type or SRM type	



Type	Serial Number
Coil type	

# Symbols used on ceramic glow plugs

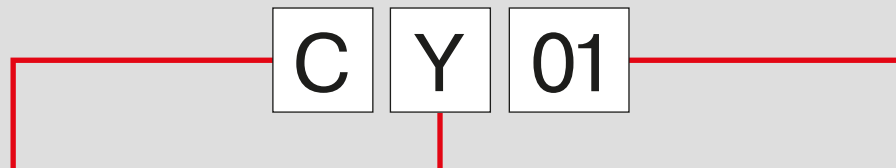

Model / Type	Heating Characteristics		Serial Number
Ceramic	X	Non-body earth type	Serial Number
	Y	<b>SRC Type</b> Self Regulating ceramic <b>Glow Plug</b> Self Regulating Type	
	Z	<b>QGS Type</b> Quick Glow System Body earth type	

## Notes about the table

- △ = only for automobiles with immobilizer
- ◆ = only for automobiles without immobilizer

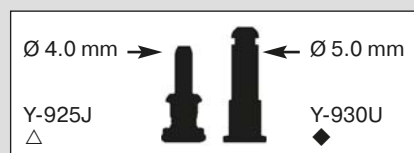

# Spark plug comparison table

V-LINE	NGK	BERU	BOSCH	BOSCH +
Nr. 1	BUR6ET	14GH-7DTUR	WR7LTC+	+2
Nr. 2	BPR6E	14R-6DU 14R-7DU	WR6DC+ WR7DC+	+12 +1
Nr. 3	BPR6H	14R-6BU 14R-7BU	WR6BC WR7BC+	+10
Nr. 4	BP6E	14-6DU 14-7DU	W6DC W7DC	
Nr. 5	BP6EF	14K-6DU 14K-7DU	H6DC H7DC	
Nr. 6	BPR5E	14R-8DU 14R-9DU	WR8DC+ WR9DC+	+3 +16
Nr. 7	BPR6EF	14KR-6DU 14KR-7DU	HR6DC+ HR7DC+	+18 +5
Nr. 8	BP5E	14-8DU 14-9DU	W8DC W9DC	
Nr. 9	BPR5EY	-	-	
Nr.10	BPR6EY-11	-	-	
Nr.11	BCPR6E-11	-	-	
Nr.12	BCPR6E	-	-	
Nr.13	BPR6ES-11	14R-6DUX 14R-7DUX	WR6DCX WR7DCX+	+21
Nr.14	BKR6E-11	14FR-6DUX 14FR-7DUX	FR6DCX FR7DCX+	+11
Nr.15	ZGR5A	14-8LUR	WR8LC+ WR9LC	+34
Nr.16	BCP5E	14F-8DU	F8DC	
Nr.17	BCP6E	14F-7DU	F6DC F7DC	
Nr.18	BP6H	14-6BU 14-7BU	W6BC W7BC	
Nr.19	BPR7E	14R-5DU	WR5DC+	+15
Nr.20	BKR6EK	14FR-6LDU 14FR-7LDU	FR6LDC FR7LDC+	+7
Nr.21	BUR5ET-10	14GH-8DTURX	WR8LTC+	+4
Nr.22	BUR5ET	14GH-8DTUR	W8LTCR 0.8	
Nr.23	BKR5EK	14FR-8LDUOX4	FLR8LDCU+	+9
Nr.24	BKUR6ET-10	14FGH7DTURX	F7LTCR	
Nr.25	PTR5A-13	14KR-8MPX 14KR-8MUV	HR7MPP302 HR8MCV+	+3
Nr.26	BKR6EKC	14FR-6LDUW	-	
Nr.27	BKUR6ET	14FGH-6DTUR	FR6KTC	
Nr.28	BKR6E	14FR-6DU 14FR-7DU	FR6DC+ FR7DC+	+13 +8
Nr.29	BKUR5ET	14FGH-8DTURW	F8KTCR	
Nr.30	BKR6EQUP	14FR-7DQUP7	FGR7DQP+	+48
Nr.31	PTR5D-10	-	HR8DPP22U	
Nr.32	BCPR5E	-	-	
Nr.33	BKR5E-11	14FR-8DUX	FR8DCX+	+19
Nr.34	PZFR5D-11	14F-7HPURX2	FR7HPP33+	+52
Nr.35	BKR5E	14FR-8DU	FR8DC+ FR9DC	+6
Nr.36	BKR5EZ	-	-	
Nr.37	PFR6Q	14F-7 DPUR02	FR7KPP33+	+50
Nr.38	BKR6EZ	-	FR7DE FR6KDC+ FR7KDC	+53
Nr.39	BKR5EYA-11	14FR8KU0U	FR8KCU	



# V-Line – a sales concept with many benefits

## 1. Numbering system:

Numbers from 1 to 39 make it easy to quickly find the right spark plug.

## 2. Attractive packaging:

Spontaneous buying, that increases sales.

## 3. Compact:

Less space demand by compact measurements.

## 4. High stock turnover:

39 types for 97% of all vehicles. This improves your profit.

## 5. Special trade distribution:

No competition with department stores and supermarkets.

## 6. Less costs:

Less costs for storing—more profit for you.

## 7. Protection of environment:

Higher ignition safety. Reduction in fuel consumption, exhaust emission and longer life for catalizer. More customer acceptance. Environmental carton packaging without blisterpack.

## 8. End consumer advertising:

NGK provides for increase in demand of your customers.



The complete assortment can be clearly represented in a floor display. An integrated application list makes it easy to quickly find the right spark plug.

# V-Line

## spark plugs offer benefits down the line

**NGK V-line spark plugs offer perfect ignition of the fuel/air mixture. Especially in modern low emission lean-burn engines, even under extreme operating conditions.**

### Technical Advantages

NGK Spark Plugs have a very wide heat range because they utilise superior insulator materials and a copper cored centre electrode. This ensures better cold starting and perfect ignition even under extreme engine operating conditions.



V-Line No. 1, 21, 22, 24, 27, 29

### **V-Line No. 1, 21, 22, 24, 27, 29 3 Ground Electrode Spark Plugs for VW/Audi**

NGK manufacture this type of spark plug specially for Volkswagen and Audi cars. Nearly all new models can be fitted with it (see NGK catalogue for full listing). They satisfy the service interval specified by the car manufacturer.



V-Line No. 2-12, 14-19, 28, 32,  
33, 35, 36, 38, 39

### **V-Line No. 2 - 12, 14 - 19, 28, 32, 33, 35, 36, 38, 39 NGK's patented V-grooved spark plugs**

The principle is technically simple but very effective. A V-groove is situated in the centre electrode of these V-Line spark plugs. This forces the spark to occur at the outer edge of the centre electrode where it is easier to ignite the fuel/air mixture.

In addition, the voltage required to produce a spark is reduced. These two features give the benefit of improved ignitability.



V-Line No. 20, 23

### **V-Line No. 20, 23**

The principle of the spark plug for BMW is to "catch" the current which is leaking away over the deposits and create a spark. Spark discharge occurs between insulator and ground electrode. The carbon deposits are removed and the fuel/air mixture will be ignited.

**V-Line No. 25**

NGK has developed the double platinum spark plug PTR5A-13 for FORD models powered by ZETEC engines. The benefit of the platinum electrodes is to lower the required ignition voltage. As a result it is possible to increase the gap between the electrodes to improve combustion and give good idle stability. Better

combustion also results in improved acceleration and lower emissions.



V-Line No. 25

**V-Line No. 26**

Together with FIAT, NGK has developed the spark plug BKR6EKC. The "C" identifies it as a special spark plug for engines from the FIAT Corporation. The BKR6EKC works perfectly even under the most adverse conditions – from stop, start city driving with low combustion temperatures to maximum cylinder temperature experienced

at full load. Test results show the specially designed double ground electrode plug guarantees superb ignition and satisfies Fiats service life requirements..



V-Line No. 26







V-Line No. 30

**V-Line No. 30**

This is the long-life spark plug BKR6EQUP developed in close cooperation between BMW and NGK, which is equipped with a platinum middle electrode and 4 earth electrodes together with state-of-the-art semi-surface gap spark plug.

The semi-surface gap spark plug requires a special design of the insulator tip. This ensures that the ignition spark always only jumps between the electrodes which offer the most favourable conditions for reliable ignition of the fuel/air mixture.

In view of the fact that the ignition spark slides over the insulator tip first before it can jump over the air gap between insulator tip and earth electrode, any deposits

accumulated here are removed immediately, reliably preventing any misfiring. This therefore guarantees optimum cold start behaviour at very low temperatures and greatest ignition reliability even when the vehicle is only driven for extremely short distances.

This new type of NGK spark plug is fitted in BMW engines from model year 1997. Retrospective approval has also been given for certain older BMW vehicles from model year 1987.



V-Line No. 31, 34, 37

**V-Line No. 31, 34, 37**

NGK has developed the double platinum spark plug PTR5D-10 for FORD models powered by ENDURA engines (V-Line No. 31). The benefit of the platinum electrodes is to lower the required ignition voltage. As a result it is possible to increase the gap between the electrodes to improve combustion and give

good idle stability. Better combustion also results in improved acceleration and lower emissions.

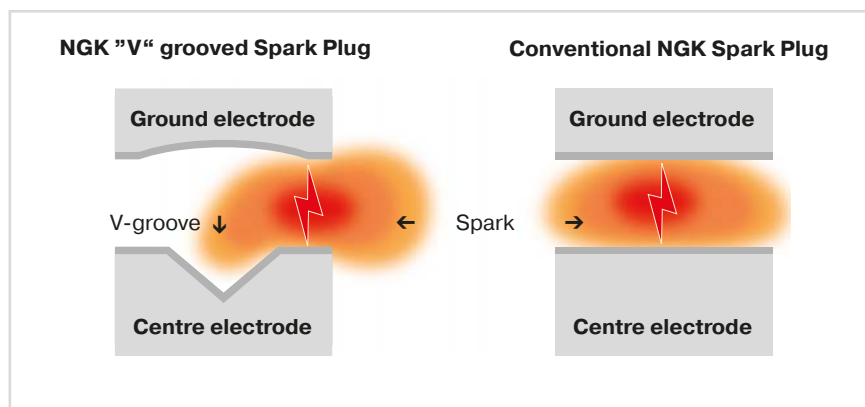

# V-Line overview

V-Line	Type	Automobile manufacturer
1	BUR6ET	AUDI, FIAT, LANCIA, SEAT, SKODA, VW
2	BPR6E	ALFA ROMEO, AUSTIN, AUTOBIANCHI, BEDFORD, BMW, CHEVROLET, CHRYSLER, DAEWOO, DAIHATSU, FIAT, FORD, HONDA, INNOCENTI, ISUZU, KIA, LADA, LANCIA, LAND ROVER, LOTUS, MAZDA, MERCEDES-BENZ, MG, MITSUBISHI, MORGAN, NISSAN, OPEL, PANTHER, PININFARINA, PORSCHE, PROTON, RENAULT, ROVER, SEAT, SUBARU, SUZUKI, TALBOT, TVR, VAUXHALL, VOLVO, ZASTAVA
3	BPR6H	BEDFORD, FORD, OPE
4	BP6E	ALFA ROMEO, ASTON MARTIN, AUDI, AUSTIN, AUTOBIANCHI, BEDFORD, BMW, BOND, CITROËN, FIAT, FORD, FSO, GLAS, INNOCENTI, ISUZU, LADA, LANCIA, LAND ROVER, MASERATI, MERCEDES-BENZ, MG, MITSUBISHI, MORGAN, NISSAN, OPEL, PEUGEOT, RENAULT, ROVER, SAAB, SEAT, SUBARU, TALBOT, TRABANT, TRIUMPH, VAUXHALL, VOLVO, VW, WARTBURG, ZASTAVA, ZAZ
5	BP6EF	ALPINE, AUSTIN, CITROËN, LAND ROVER, MERCEDES-BENZ, PEUGEOT, PUCH, RENAULT, ROVER, TALBOT, TRIUMPH, VOLVO
6	BPR5E	ASIA MOTORS, BEDFORD, DAIHATSU, FIAT, HONDA, MARUTI, MAZDA, MITSUBISHI, NISSAN, OPEL, PROTON, RENAULT, SEAT, SUZUKI, TOYOTA, TRIUMPH, VAUXHALL, ZASTAVA
7	BPR6EF	FORD, LANCIA, RENAULT, VOLVO
8	BP5E	BMW, DAIMLER, HYUNDAI, ISUZU, JAGUAR, LAND ROVER, MG, MITSUBISHI, NISSAN, PEUGEOT, RENAULT, TRIUMPH, VW
9	BPR5EY	DAIHATSU, HONDA, SUZUKI, TOYOTA, VW
10	BPR6EY-11	DAIHATSU, HONDA, TOYOTA
11	BCPR6E-11	ACURA, FORD, FORD USA, HONDA, LADA, MAZDA, MITSUBISHI, NISSAN, ROVER, SAAB, SUBARU
12	BCPR6E	ASTON MARTIN, AUTOBIANCHI, CHEVROLET, CHRYSLER, CITROËN, DAIMLER, FIAT, FORD, FSO, JAGUAR, LANCIA, MAZDA, MORGAN, NISSAN, PEUGEOT, PONTIAC, RENAULT, ROVER, SAAB, SKODA, TVR, VOLVO
13	BPR6ES-11	HYUNDAI, ISUZU, KIA, MAZDA, MITSUBISHI, NISSAN, OPEL, SUBARU
14	BKR6E-11	CHEVROLET, DAEWOO, DAIHATSU, HONDA, ISUZU, KIA, MAZDA, MITSUBISHI, NISSAN, PEUGEOT, PROTON, ROVER, SUBARU, SUZUKI
15	ZGR5A	BERTONE, BMW
16	BCP5E	CITROËN, DAEWOO, MERCEDES-BENZ, PEUGEOT, RENAULT, SAAB, SSANGYONG
17	BCP6E	ALFA ROMEO, CITROËN, MERCEDES-BENZ, NISSAN, PEUGEOT, PUCH, RENAULT, ROVER
18	BP6H	CITROËN, DACIA, DAF, FORD, MERCEDES-BENZ, OPEL, PORSCHE, RENAULT, SEAT, SKODA, TALBOT, TRABANT, VOLVO, WARTBURG
19	BPR7E	ALFA ROMEO, AUSTIN, AUTOBIANCHI, FIAT, FORD, LANCIA, LOTUS, MITSUBISHI, PININFARINA, PORSCHE, RENAULT, SUBARU, TALBOT, VOLVO
20	BKR6EK	ALPINA, BERTONE, BMW, CITROËN, DAEWOO, FIAT, LANCIA, MERCEDES-BENZ, OPEL, PEUGEOT, PORSCHE, SAAB, VAUXHALL, WIESMANN
21	BUR5ET-10	AUDI, SAAB, SEAT, VW
22	BUR5ET	AUDI, SEAT, VW
23	BKR5EK	CHEVROLET, CITROËN, DAEWOO, FIAT, LANCIA, NISSAN, OPEL, PEUGEOT, RENAULT, SAAB, VAUXHALL
24	BKUR6ET-10	AUDI, MERCEDES-BENZ, SEAT, SKODA, VW
25	PTR5A-13	CHEVROLET, FORD, HUMMER, MAZDA, MORGAN
26	BKR6EKC	DAIHATSU, FIAT, LANCIA, LOTUS
27	BKUR6ET	FIAT, LANCIA, SEAT, VW
28	BKR6E	AUDI, AUSTIN, CATERHAM, CHRYSLER, CITROËN, DACIA, FIAT, HYUNDAI, KIA, LADA, LAND ROVER, MAZDA, MERCEDES-BENZ, NISSAN, OPEL, PANTHER, PEUGEOT, PORSCHE, RENAULT, ROVER, SKODA, SUZUKI, VOLVO, VW
29	BKUR5ET	MERCEDES-BENZ, VW
30	BKR6EQUP	ALPINA, AUDI, BENTLEY, BMW, LAND ROVER, MINI, MORGAN, PORSCHE, ROLLS-ROYCE, VOLVO
31	PTR5D-10	FORD, MAZD
32	BCPR5E	CITROËN, PEUGEOT, RENAULT, SKODA
33	BKR5E-11	CHEVROLET, DAEWOO, DAIHATSU, HYUNDAI, INFINITI, KIA, MAZDA, MITSUBISHI, NISSAN, SUBARU
34	PZFR5D-11	FORD, SEAT, SKODA, VW
35	BKR5E	KIA, MAZDA, NISSAN, VW
36	BKR5EZ	CITROËN, FIAT, LANCIA, PEUGEOT, RENAULT
37	PFR6Q	AUDI, BENTLEY, SEAT, SKODA, VW
38	BKR6EZ	CITROËN, DACIA, FIAT, LANCIA, NISSAN, PEUGEOT, RENAULT
39	BKR5EYA-11	TOYOTA

# LPG LaserLine – A product line like no other

Until now, the market has lacked a special line of spark plugs for gas engines. NGK Spark Plug Europe has filled the gap.

- For gas operated engines: LPG/CNG
- Double precious metal design: laser welded
- Special coating protects and facilitates removal
- Easy installation: present spark gap
- 95% market coverage with only 8 part numbers

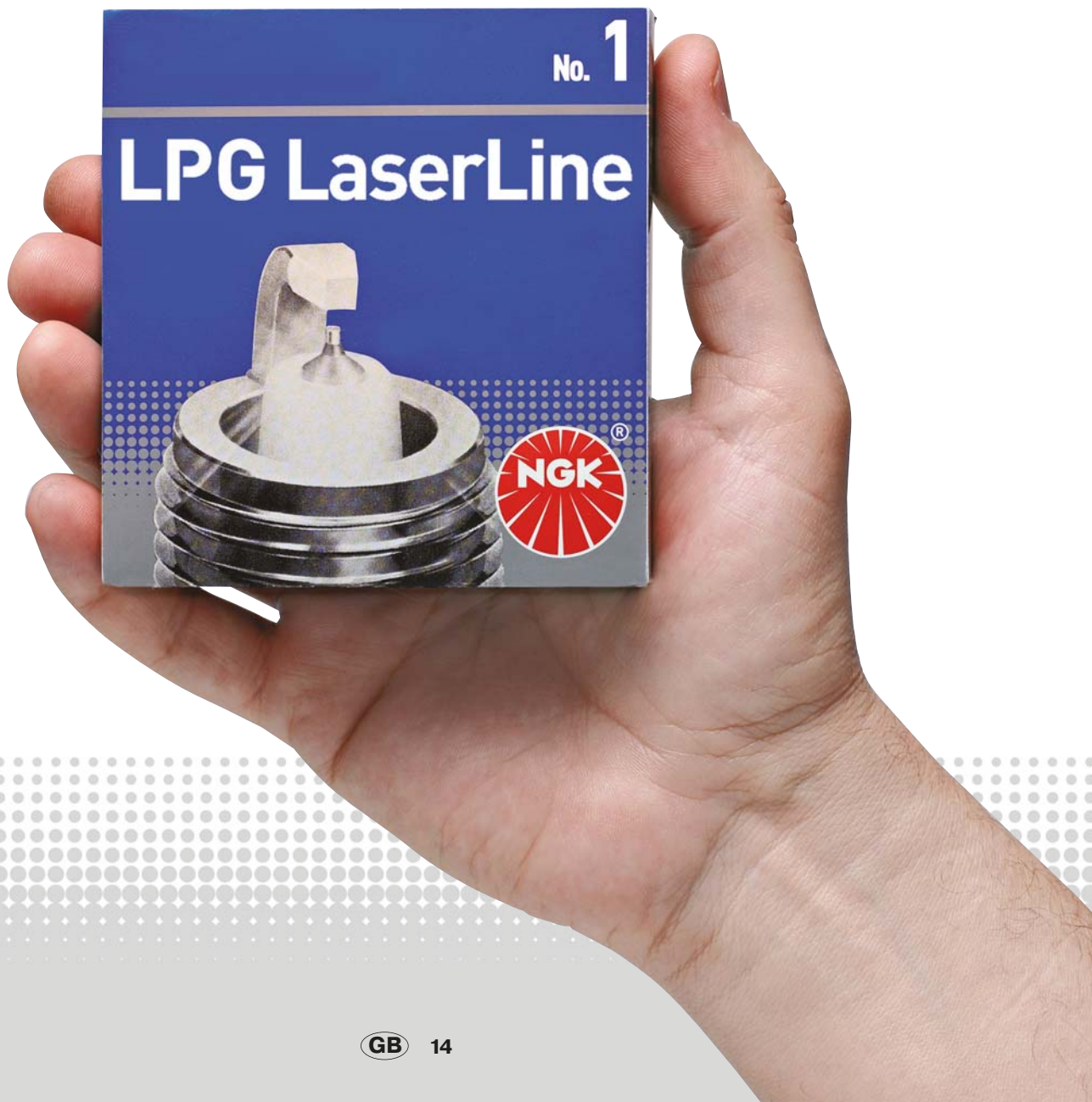



# LPG LaserLine – the best for gas operated engines

**LPG LaserLine gives retailers and repair shops a product line with spark plugs developed especially for gas operated engines. For both retailers and repair shops this makes conversion and servicing not only easier, but also more reliable.**

Drivers throughout Europe who convert their cars to gas operation benefit from substantially lower fuel prices, due to the lower taxes on gas. The number of conversions is increasing from year to year. Retailers and repair shops can profit from this development.

Choosing the right spark plug in the past involved many factors, which often meant extra work. Because the combustion of gas is very different from the combustion of gasoline: the gas/air mixture is more difficult to ignite. The required ignition voltage increases (see graph), together with the risk of failure for the ignition coils. Also, the gas/air mixture burns at a higher temperature.

Conventional electrode and housing materials corrode more quickly in this environment, and the spark plug also has to dissipate more heat. Until now, the best solution was to change

from standard spark plugs to precious metal spark plugs with a different heat range and to adjust the spark gap, in some cases.

**But now there is a better alternative:** special LPG LaserLine spark plugs. The product line covers more than 90 percent of conversion-capable automobiles in Europe and as many as 97 percent in some countries. Therefore, LPG LaserLine is the ideal spark plug for practically every European car that is converted.

Required ignition voltage increases in gas operated engines

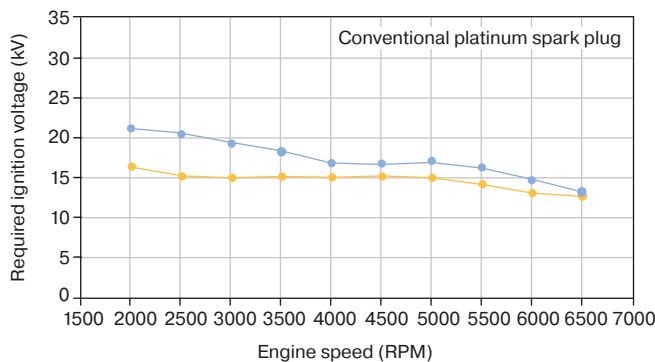

Super gasoline: — Spark gap 0.80 mm  
Liquid gas (LPG): — Spark gap 0.80 mm



# LPG LaserLine – Top technology for gas operated engines



## 1. High-tech electrodes

LPG LaserLine spark plugs have an iridium-tipped centre electrode and a shell electrode with a platinum chip. These precious metal chips are attached in a specially developed laser welding process patented by NGK. The advantage: the precious metals are resistant to the unfavorable conditions in gas operated engines. The spark gap remains virtually the same throughout the entire performance range.

## 2. Individual spark gap

The ideal gap between the center electrode and shell electrode of every LPG LaserLine type is preset for gas operated engines. Manual adjustment is no longer necessary.

## 3. Optimum thermal properties

A copper core in the shell electrode of every LPG LaserLine spark plug improves the temperature discharge, which helps to regulate the higher temperatures in gas operated engines. Design properties protect these spark plugs even better against fouling.

## 4. Heat shield for the housing

A special alloy coating covers the housing of every LPG LaserLine spark plug, protecting it from the higher temperatures and the increased risk of corrosion. No other manufacturer currently offers a similar coating.

## 5. Relief for the ignition coils

Studies conducted by NGK show that the required ignition voltage in gas operated engines increases by as much as 7,000 volts – an acid test for the ignition coils. The iridium center electrode of an LPG LaserLine spark plug, only 0.6 mm in diameter, provides a counter measure, since it requires very low ignition voltage. The shape of the electrode also facilitates optimum advance of the flame front.

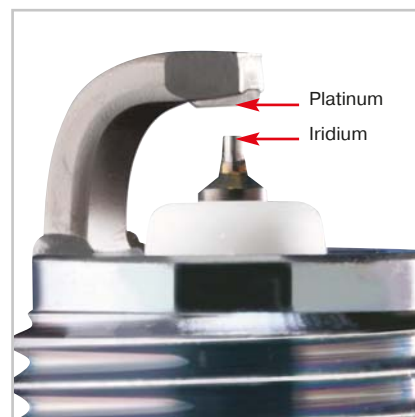

The iridium-tipped center electrode and the platinum chip in the shell electrode – both laser-welded – provide for maximum resistance and reliable ignition – throughout the entire performance range.

# LPG LaserLine – Optimum market coverage

**LPG LaserLine – 8 special spark plugs for the ignition of gas/air mixtures. For more than 90 percent of all conversion-capable automobiles on the European market.**

The table shows 8 sample applications for LPG LaserLine spark plug types. All applications are listed in the NGK spark plug

catalogue, in TecDoc and in the online product finder at [www.ngk-europe.com](http://www.ngk-europe.com)

Sample applications		
LPG-type	Automobile	Engine
LPG 1	Audi A6 2.4l V6	BDV
LPG 2	Volvo 940i 2.3l	B 230 FT
LPG 3	Saab 9-5 2.3l	B235L
LPG 4	Ford Focus 1.6l	FYDA Zetec SE
LPG 5	Ford Mondeo 2.0	CJBA Duratec HE
LPG 6	VW Multivan T5 2.8l	AXK
LPG 7	Peugeot 307 1.6l	TU5 JP4 NFU
LPG 8	Fiat Grande Punto 1.4	350A1000

## How a gas-powered engine functions

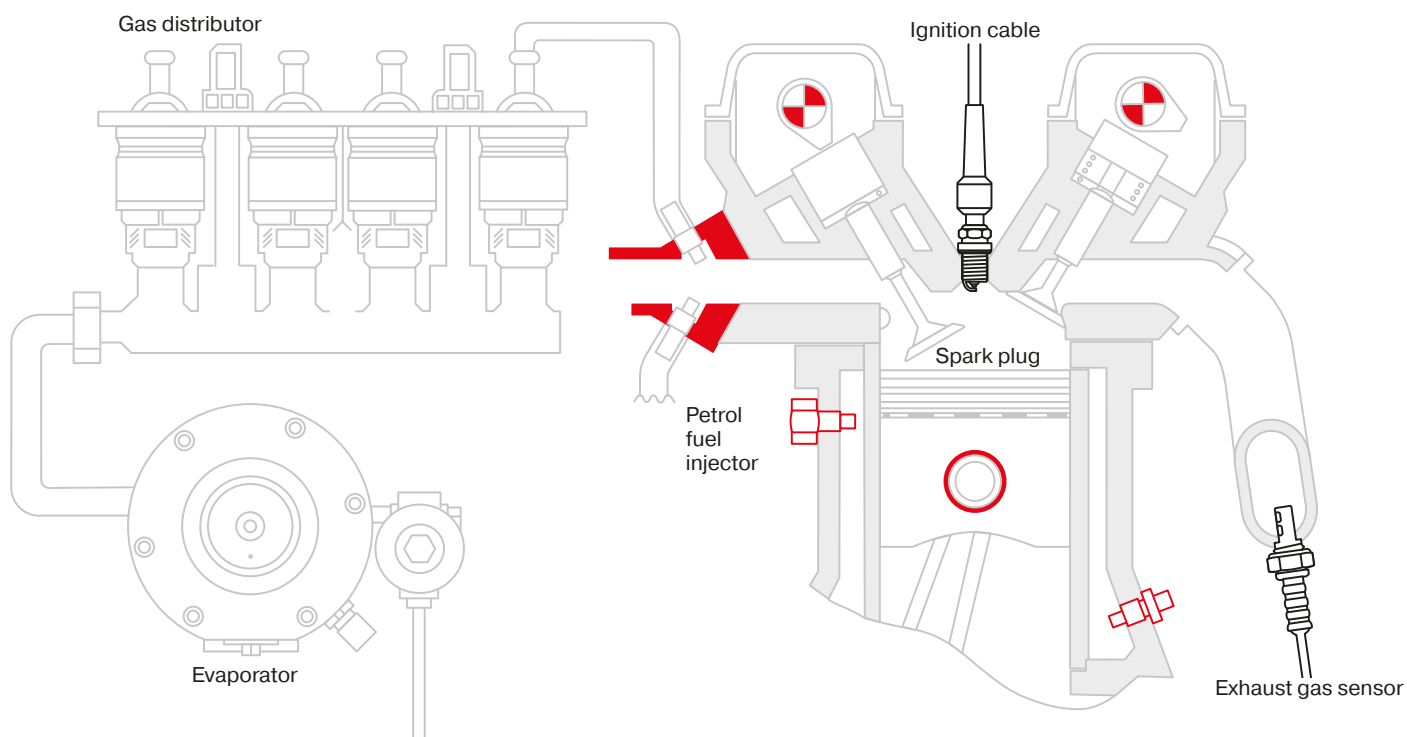

# D-POWER<sup>NGK</sup>



## D-Power: Current diesel technology in one assortment

The D-Power glow plug assortment comprises 62 glow plugs and always offers the ideal solution for nearly every vehicle application. In the process, around 90 % of the European diesel vehicle population is covered.

D-Power glow plugs ensure a fast and environmentally-friendly cold start even at the lowest outside temperatures. This is also because they provide the know-how of a leading glow plug supplier: In addition to standard metal rod glow plugs and ceramic

glow plugs, the assortment includes the NHTC glow plug with fully ceramic heating element, which is used by VW, Mercedes and Mitsubishi in series production. Glow plugs with Advanced Quick Glow System (AQGS) are also a part of the D-Power range. This technology is used in series production by manufacturers such as Fiat.

The time-tested short numbering system of NGK ensures that an optimal glow plug for every vehicle can be found quickly and re-ordered as needed.

### The assortment at a glance:

- Market coverage of around 90 %
- For nearly all vehicle models in TecDoc
- Quick location of the right glow plug thanks to the NGK short numbering system
- Easy stockkeeping and updating
- Ceramic and metal rod glow plugs in one assortment
- Many original equipment glow plugs







## Ceramic glow plugs

As opposed to a metal rod glow plug, the heating coil of a ceramic glow plug has an especially high melting point. It is also sheathed in silicon nitrite, an extremely rugged ceramic material. The combination of the heating coil and ceramic sheath enable higher temperatures and extremely short preheating times due to excellent thermal conductivity. Also, ceramic glow plugs have a more compact design. This is important, because there is very little free space in today's engines. In an SRC (Self Regulating Ceramic) glow plug the heating element is made of ceramic with a sintered metal heating coil. An HTC (High Temperature Ceramic) or NHTC (New High Temperature Ceramic) glow plug has a heating element and a heater made of ceramic.

The NHTC ceramic glow plug was specially developed by NGK to enable automobile manufacturers to comply with the Euro 4 and Euro 5 emissions standards. One of the goals of these standards is to reduce the compression ratio in diesel engines. NHTC glow plugs reach a temperature of 1,000 °C in less than two seconds and can after-glow for more than ten minutes at temperatures of up to 1,350 °C. Optimal combustion is assured even with low compression ratios. In addition, the NHTC glow plug can glow intermediately to prevent cooling of the particle filter in deceleration phases.

### **Ceramic glow plugs: the technical optimum**

For more than 20 years automobile manufacturers have been using NGK glow plugs as standard equipment. But can these glow plugs be replaced with comparatively less expensive metal glow plugs?

The answer: many things "can" be done, of course. The question is, what risk is involved. In cars that have NGK ceramic glow plugs installed at the factory, only NGK ceramic glow plugs should be used when it comes time to replace the glow plugs.

The reason: These glow plugs were developed in-house for the respective engines. Ceramic glow plugs from NGK guarantee a long service life and ensure a reliable and fast ignition, even at the lowest outside temperatures. At the same time, they reduce harmful emissions. Although they at first appear to be somewhat more expensive than metal glow plugs, one should consider the following: Metal glow plugs can make it difficult to start a car at extremely cold sub-zero temperatures.

### **Tip!**

When changing to metal glow plugs, all of the glow plugs have to be replaced, including those that are intact.

# D-Power overview

D-Power	Type	Stock-No.
DP 1	Y-924J	7906
DP 2	Y-918J	6285
DP 3	Y-910J	3617
DP 4	Y-732J	6001
DP 5	Y-937J	7503
DP 6	Y-916J	5906
DP 7	Y-506J	2419
DP 8	CY03	6160
DP 10	Y-503J	1009
DP 11	Y-745U	6346
DP 12	Y-516J	6416
DP 13	Y-733J	6592
DP 14	Y-748U	6649
DP 15	Y-913J	5317
DP 16	Y-925J	6848
DP 17	Y-730U	6704
DP 19	Y-927J	4916
DP 20	Y-741U	6943
DP 21	CY57	4994
DP 22	Y-740U	4818
DP 24	Y-504J	1441
DP 25	Y-933J	7947
DP 26	Y-747U	4694
DP 27	Y-524J	4520
DP 28	Y-711J	4467
DP 29	Y-928U	4389
DP 30	Y-930U	4275
DP 31	Y-501U	4187
DP 32	Y-507J	2691
DP 34	Y-729U	4119
DP 36	Y-534J	3413
DP 37	Y-523J	6298
DP 38	Y-746J	3078
DP 39	Y-701J	1566
DP 40	YE04	1684
DP 41	Y-929U	1749
DP 42	Y-541J	1983
DP 43	Y-939J	5059

D-Power	Type	Stock-No.
DP 44	Y-531J	5467
DP 45	Y-542J	5513
DP 46	Y-543J	5618
DP 47	Y-547AS	5968
DP 48	YE14	7768
DP 49	Y-609AS	5849
DP 50	Y-607AS	7560
DP 51	Y8002AS	6287
DP 52	CZ104	9826
DP 53	CZ106	9957
DP 54	CZ303	7865
DP 55	CZ304	9864
DP 56	Y1005J	7957
DP 57	Y1002AS	8888
DP 58	Y8001AS	8904
DP 59	Y1007J	3040
DP 60	Y-603J	8838
DP 61	Y-519J	93293
DP 62	Y8003J	97256
DP 63	Y1013J	94470
DP 64	Y8005J	96853
DP 65	Y1012J	92083
DP 66	Y-517J	91766
DP 67	Y-527J	96187
DP 68	CZ203	95232
DP 69	Y-526J1	93283
DP 70	Y1030J	90828
DP 71	Y1031J	95970
DP 72	Y9001AS	97719
DP 73	YE05	91322
DP 74	Y8008AS	91440
DP 75	Y-548J	94832
DP 76	CZ251	91238
DP 77	Y1035AS	94103
DP 78	Y9003AS	94251
DP 80	Y1039AS	91648
DP 81	Y-536J	95061



# NGK racing spark plugs





# Series of **NGK** racing spark plugs

Blue colour indicates resistor plugs.

Thread size (Hexagon size)	Spark plug type	Spark plug number	Heat rating	Terminal nut type	Firing end	Electrode material			
						Center	Ground		
φ 14×19mm (20.8Hex)	BP-E	R4304A-	<b>7,8,9,10</b>		A ①	Gold Palladium	Nickel Alloy		
	B-E	R6918B-	<b>7,8,9</b>		B ①	Platinum	Nickel Alloy		
		R6918C-	<b>9</b>		B ①	Platinum	Nickel Alloy		
		R6021E-	<b>8,9,10</b>		B ①	Nickel Alloy	Nickel Alloy		
		R7376-	<b>7,8,9,10</b>		C ①	<b>Iridium</b>	Platinum		
		R5649-	<b>9,10,11</b>		E ①	Nickel Alloy	—		
		R6712-	<b>9,10</b>		E ①	Nickel Alloy	—		
	Short	R6179A-P	<b>105,11</b>		C ②	Platinum	Platinum		
φ 14×22mm (20.8Hex)	Short	R6179C-PA	<b>105</b>		C ②	Platinum	Platinum		
		R7376B-	<b>9,10</b>		C ①	<b>Iridium</b>	Platinum		
φ 14×22mm (16.0Hex)	Short	R7282A-※2	<b>10,105,11</b>		C ③	<b>Iridium</b>	Platinum		
φ 14×19mm (16.0Hex)	Short	R7282-※2	<b>7,8,9,10,105,11</b>		C ③	<b>Iridium</b>	Platinum		
		R7282M-※2	<b>11,115</b>		C ③	<b>Iridium</b>	Platinum		
		R6888A-	<b>8,9,10</b>		F ⑫	Nickel Alloy	Nickel Alloy		
	BK-E(ISO)※1	R7433-	<b>8,9,10</b>		A ⑤	<b>Iridium</b>	Nickel Alloy		
		BC-E(ISO)※1	R7434-	<b>8,9,10</b>		C ⑤	<b>Iridium</b>	Platinum	
	R7279-		<b>10</b>		D ⑤	<b>Iridium</b>	Platinum		
	R6601-		<b>8,9,10,11</b>		E ⑤	Nickel Alloy	—		
	R6711-		<b>9,10</b>		E ⑤	Nickel Alloy	—		
	BCP-E(JIS)	R7435-	<b>8,9,10</b>		A ④	<b>Iridium</b>	Nickel Alloy		
	BC-E(JIS)	R7436-	<b>8,9,10</b>		C ④	<b>Iridium</b>	Platinum		
		R5883-	<b>9,10,11</b>		E ④	Nickel Alloy	—		
		R6690-	<b>9,10,11</b>		E ④	Nickel Alloy	—		
	φ 14×26.5mm (16.0Hex)	LFR	long reach	R7437-	<b>8,9,10</b>		A ⑭	<b>Iridium</b>	Nickel Alloy
			long reach	R7438-	<b>8,9,10</b>		C ⑭	<b>Iridium</b>	Platinum
	φ 14×12.7mm(20.8Hex)	B-H	R5525-	<b>7,8,9,10,11</b>		B ⑦	Gold Palladium	Nickel Alloy	
			R5530-	<b>8,9,10,11</b>		D ⑦	Gold Palladium	Platinum	
φ 14×21.5mm(20.8Hex)	Rotary RX-7	R6725-	<b>9,10,105,11,115</b>		D ⑥	Platinum	Platinum		
		R7420-	<b>9,10,105,11</b>		D ⑥	<b>Iridium</b>	Platinum		
φ 14×21mm(20.8Hex)	Rotary RX-8 L	R7440A-L	<b>9,10</b>		C ⑮	<b>Iridium</b>	Platinum		
φ 14×19mm(20.8Hex)	Rotary RX-8 T	R7440B-T	<b>10,11</b>		C ⑮	<b>Iridium</b>	Platinum		
φ 12×26.5mm(16.0Hex)	LKR-E	long reach	R2556B-	<b>8,9,10</b>		C ⑯	<b>Iridium</b>	Platinum	
φ 12×26.5mm(14.0Hex)	LKAR-E	long reach	R2558A-	<b>8,9,10</b>		C ⑰	<b>Iridium</b>	Platinum	
φ 12×19mm(16.0Hex)	DC-E	R2349-	<b>9,10,11</b>		E ⑧	Nickel Alloy	—		
		R2525-	<b>9,10,11</b>		C ⑧	Platinum	Nickel Alloy		
φ 10×26.5mm(14.0Hex)	LMAR-E	long reach	R0465B-	<b>10</b>		E ⑱	Nickel Alloy	—	
φ 10×19mm(16.0Hex)	C-E	R0373A-	<b>8,9,10</b>		C ⑨	<b>Iridium</b>	Platinum		
		R0045G-	<b>10,11</b>	GAP1.4	E ⑨	Nickel Alloy	—		
		R0045J-	<b>9,10,11,12</b>	GAP1.1	E ⑨	Nickel Alloy	—		
		R0045Q-	<b>10,11</b>	GAP1.1	E ⑨	Nickel Alloy	—		
φ 10×19mm Half thread (16.0Hex)	C-EH	R0409B-	<b>8,9,10</b>		C ⑲	<b>Iridium</b>	Nickel Alloy		
φ 10×12.7mm(16.0Hex)	C-H	R0161-	<b>9,10,11</b>		B ⑩	Nickel Alloy	Nickel Alloy		
φ 8×19mm Half thread (13.0Hex)	E-EH	R847-	<b>10,11</b>		E ⑪	Nickel Alloy	—		

※ 1 ISO : The length from gasket to terminal of ISO type spark plugs is 50.5mm which is 2.5mm shorter than BCP-E or BC-E type spark plugs.

※ 2 It's necessary to use special plug caps(Please refer to page 6)

※ 3 Resistor spark plugs are recommended for cars originally equipped with resistor spark plugs.

When nonresistor spark plugs are installed in such cars, there is some possibility that the electric devices in the car, such as the audio system or the engine management system, would be affected by noise.

NOTICE) = Solid post terminal

= Thread terminal with nut

= Thread terminal

# Appearance

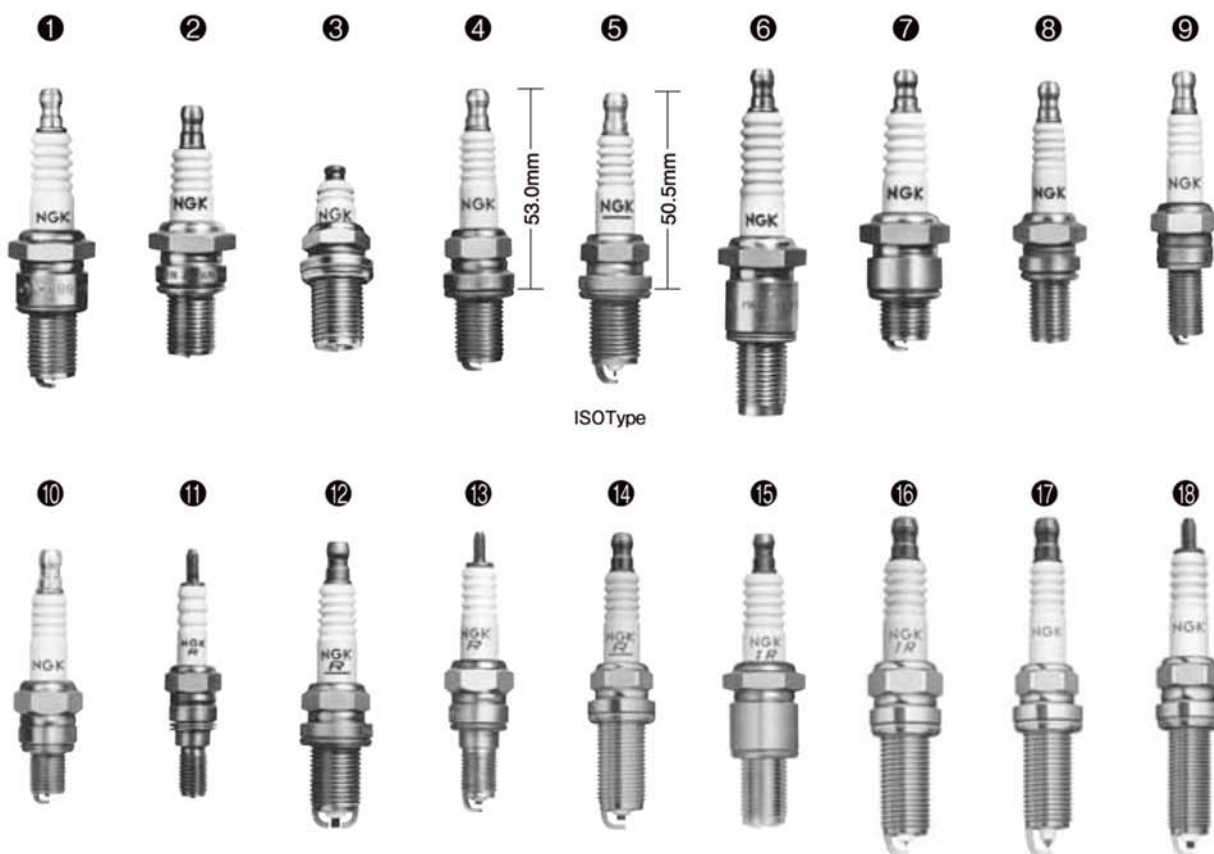

# Firing end



# Discontinued plug types

Blue colour indicates resistor plugs.

Old part number	New part number	Old part number	New part number
R016-, R017-	→ R0373A-	R5400-, R5400F-, R6337-	→ R7435-
R216-, R217-	→ R2525-	R5686-	→ R7435- or R7436-
R2270-, R2430-	→ R2349-	R5830-, R5687-	→ R7436-
R4630A-, R6385-P	→ R7376-	R7112-, R7113-	→ R7433-
R6120-	→ R7282-	R7114-, R7115-	→ R7433- or R7434-
R6120A-	→ R7282A-	R7116-, R7117-	→ R7434-
R6120C-	→ R7282C-	R7118-, R7119-	→ R7434-
R6120M-	→ R7282M-	R7232-, R7233-	→ R7435-
R6255-, R6255F-, R6326-	→ R7433-	R7234-, R7235-	→ R7435- or R7436-
R6205-, R6241-	→ R7433- or R7434-	R7236-, R7237-	→ R7436-
R6206-, R6242-	→ R7434-	R7238-, R7239-	→ R7436-



# Placing of motor identification numbers:

This information applies only to OE installations of the automobile manufacturer

<b>Alfa</b>	<b>identification plate, engine block</b>
<b>Audi</b>	service manual, engine block and <b>A2, A3, A4, A5, A6, A8</b> spare wheel pan, right <b>100/200</b> plate back side, inside left <b>Avant</b> bottom back in the middle <b>80/90, Audi V8</b> inside luggage space flap <b>Audi Coupé</b> luggage space right under insert of tray
<b>BMW</b>	engine block
<b>Citroën</b>	on the engine block
<b>Daihatsu</b>	operating instructions, engine block
<b>Fiat</b>	identification plate, engine block
<b>Ford</b>	engine block, identification plate
<b>Honda</b>	engine block at passing to transmission
<b>Hyundai</b>	engine block
<b>Jaguar</b>	engine block, identification plate
<b>Kia</b>	engine block, transmission side
<b>Lada</b>	engine block, left side
<b>Lancia</b>	engine block, identification plate
<b>Mazda</b>	engine block (place see operating instructions)
<b>Mercedes</b>	engine block
<b>Mitsubishi</b>	engine block, identification plate at the engine hood and service manual
<b>Nissan</b>	engine block
<b>Opel</b>	engine block in high of transmission
<b>Peugeot</b>	engine block (aluminium plate)
<b>Renault</b>	engine block (middle), resp. aluminium plate
<b>Rover</b>	engine block in front of right, high of cylinder head
<b>Saab</b>	engine block, below
<b>Seat</b>	engine block, from model 93 like VW
<b>Skoda</b>	engine block near ignition distributor
<b>Subaru</b>	engine block near toothed-belt plate
<b>Suzuki</b>	engine block at passing to transmission F = iron block G = aluminium block
<b>Toyota</b>	label at the toothed belt plate
<b>VW</b>	in service manual, engine block and <b>Käfer:</b> front plate, left <b>Lupo, Polo, Derby,</b> <b>Golf, Scirocco, Jetta</b> <b>Passat Limousine,</b> <b>Corrado, Vento, Bora:</b> back plate, inside left <b>Golf Cabrio:</b> cross-tie behind rear seat bench, left <b>Passat Variant:</b> spare wheel pan, back-side left <b>Transporter:</b> cross member gear shift pattern <b>LT:</b> B-column, left down <b>Ittis:</b> bottom plate left beside first-aid box <b>Taro:</b> cabin wall, inside left
<b>Volvo</b>	300, 700, 900, C, S and V serie: label on the front face cover all other models: label on valve cover



# Inhaltsverzeichnis

Die im Katalog aufgeführten Zündkerzen und Glühkerzen, können in den Motoren entsprechend unserer Katalogempfehlung verwendet werden. Erkennbarer Irrtum sowie offensichtliche Druckfehler unterliegen der Sorgfaltspflicht des Anwenders.

Für die Fehlerfreiheit und die zugesagten Eigenschaften leistet NGK Gewähr entsprechend dem jeweiligen Stand der Technik. Grundvoraussetzung dafür ist die sachgemäße Handhabung der NGK-Produkte.

Die Gewährleistungsfrist für Materialfehler oder mangelhafte Ausführung beträgt 24 Monate ab Kaufdatum, sofern die vom Fahrzeughersteller vorgeschriebenen Wechselintervalle nicht betroffen sind. Ausgenommen davon ist der normale Verschleiß sowie jeglicher Racingeinsatz.

## Anmerkungen

1. Diese Anwendungsliste dient nur der Typenauswahl.
2. Mit Veröffentlichung dieser Ausgabe verlieren alle vorhergehenden Anwendungslisten ihre Gültigkeit.
3. Ein Rechtsanspruch kann aus dem Inhalt nicht begründet werden.
4. Empfehlungen gemäß der FAA-Richtlinien für Luftfahrttriebwerke sind in dieser Ausgabe nicht enthalten.

<b>OE weltweit</b> .....	ⓓ	2
<b>Drehmomente Zündkerzen</b> .....	ⓓ	3
<b>Drehmomente Glühkerzen</b> .....	ⓓ	3
<b>Markierungszeichen Zündkerzen</b> .....	ⓓ	4 – 5
<b>Markierungszeichen Glühkerzen</b> .....	ⓓ	6 – 7
<b>Vergleichsliste Zündkerzen</b> .....	ⓓ	8
<b>V-Line</b> .....	ⓓ	9 – 13
<b>LPG LaserLine</b> .....	ⓓ	14 – 17
<b>D-Power</b> .....	ⓓ	18
<b>Keramikglühkerzen</b> .....	ⓓ	19
<b>D-Power Übersicht</b> .....	ⓓ	20
<b>Rennzündkerzen</b> .....	ⓓ	21 – 23
<b>Platzierung Motornummern</b> .....	ⓓ	24

<b>Zündkerzenserien</b> .....	1 – 11
<b>Glühkerzenserien</b> .....	12 – 36
<b>Zünd- und Glühkerzen für PKW 1990 – 2010</b> .....	37 – 273
<b>Vergleichsliste</b> .....	274 – 391
<b>PS (HP) ↔ KW</b> .....	392

Redaktionsschluss 21.05.2014

Änderungen vorbehalten  
2015 – 2016



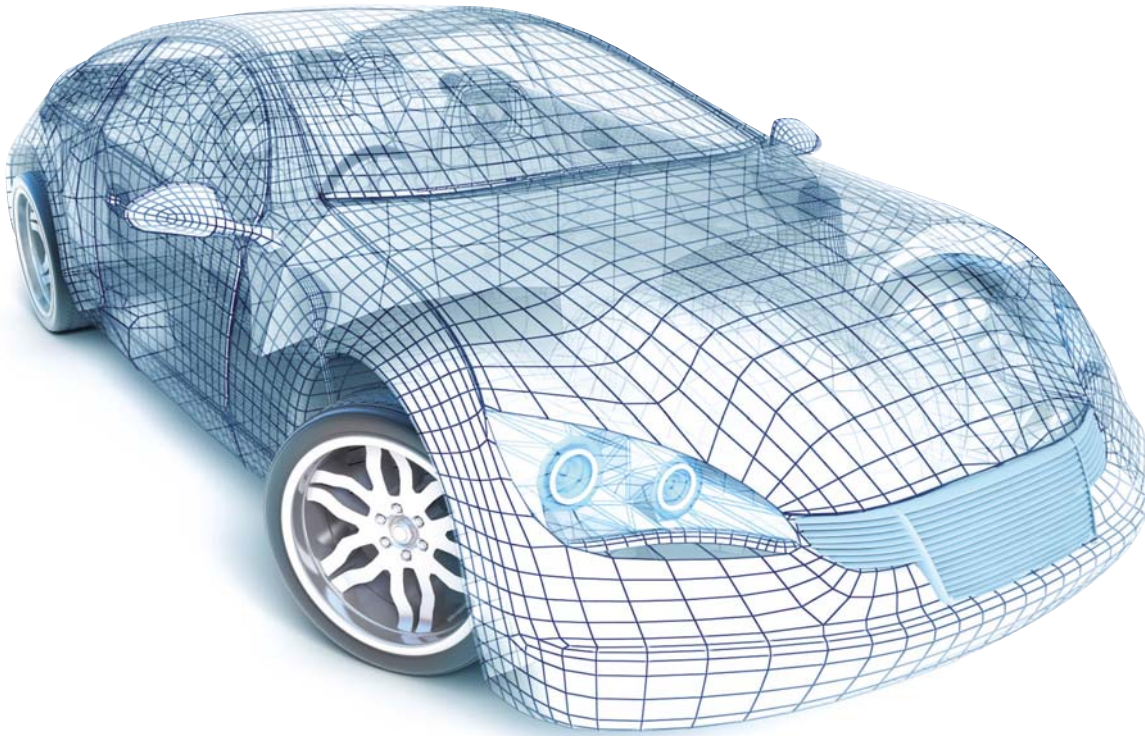

## NGK Zünd- und Glühkerzen – OEM weltweit

Hersteller	Zündkerzen	Glühkerzen
Alfa Romeo	●	●
AMG	●	
Aston Martin	●	
Audi	●	●
Bentley	●	
BMW	●	
Bugatti	●	
Chrysler	●	
Citroën	●	●
Daewoo	●	
Daihatsu	●	●
Ferrari	●	
Fiat	●	●
Ford	●	●
General Motors	●	
Honda	●	●
Hyundai	●	●
Isuzu	●	●
Jaguar	●	●
Kia	●	●
Lancia	●	●

Hersteller	Zündkerzen	Glühkerzen
Land Rover	●	●
Lamborghini	●	
Lotus	●	
Maserati	●	
Mazda	●	●
Mercedes	●	●
Mitsubishi	●	●
Nissan	●	●
Opel	●	
Porsche	●	●
Peugeot	●	●
Renault	●	●
Saab	●	
Seat	●	●
Škoda	●	●
Smart	●	●
Subaru	●	●
Suzuki	●	●
Toyota	●	●
Volkswagen	●	●
Volvo	●	●



## Drehmomente Zündkerzen

### Das richtige Drehmoment für Zündkerzen

Für die fachgerechte Montage einer Zündkerze ist ein Drehmomentschlüssel erforderlich. Denn selbst für Werkstattprofis ist das "Schätzen" des Anzugsdrehmomentes nahezu unmöglich.

Das liegt daran, dass sich ein Drehmoment aus zwei Größen errechnet, die miteinander multipliziert werden: der Kraft, die auf den jeweiligen Drehpunkt einwirkt, und der Länge des Hebels.

Die meisten Zündkerzenausfälle gehen auf ein falsches Anzugsdrehmoment zurück. Wird es zu niedrig gewählt, drohen Kompressionsverluste und Überhitzung. Auch ein Bruch von Isolator oder Mittelelektrode infolge von Vibrationen ist denkbar.

Wird das Drehmoment zu hoch gewählt, kann es zum Abreißen der Zündkerze führen. Auch kann das Gehäuse sich dehnen oder verdrehen. Die Wärmeabflusszonen werden gestört, es drohen Überhitzung und Verschmelzung der Elektroden bis hin zum Motorschaden.

Zylinderkopf-Material	Zündkerze mit flachem Sitz (mit Dichtung)				Zündkerze mit konischem Sitz	
	Gewindedurchmesser				Gewindedurchmesser	
	18 mm	14 mm	12 mm	10 mm	18 mm	14 mm
Gusseisenkopf	35-45 Nm	25-35 Nm	15-25 Nm	10-15 Nm	20-30 Nm	15-25 Nm
Aluminiumkopf	35-40 Nm	25-30 Nm	15-20 Nm	10-12 Nm	20-30 Nm	10-20 Nm

Die Drehmomente sind vom Zylinderkopfmateriale und dem Gewindedurchmesser abhängig.

## Drehmomente Glühkerzen

### Das richtige Drehmoment für den Einbau von Glühkerzen

Für die fachgerechte Montage einer Glühkerze empfiehlt sich die Verwendung eines Drehmomentschlüssels. Denn selbst für Werkstattprofis ist das „Schätzen“ des Anzugsdrehmomentes nahezu unmöglich.

Das liegt daran, dass sich ein Drehmoment aus zwei Größen errechnet, die miteinander multipliziert werden: der Kraft, die auf den jeweiligen Drehpunkt einwirkt, und der Länge des Hebels.

Wird bei einer Glühkerze ein falsches Drehmoment angewendet, kann es zu Kompressionsverlusten kommen. Aufgrund von Vibrationen ist bei keramischen Glühkerzen außerdem ein Bruch der Keramik möglich.

Auch kann insbesondere die Verwendung eines zu großen Zusammenziehen des Ringspalts zwischen Metallgehäuse und Glührohr führen. In diesem Fall überhitzt die Glühkerze und fällt aus.

Anzugsdrehmomente von Glühkerzen	
Gewindedurchmesser	Anzugsdrehmoment
8 mm	8-15 Nm
10 mm	15-20 Nm
12 mm	20-25 Nm
14 mm	20-25 Nm
18 mm	20-30 Nm

Anzugsdrehmomente von Anschlussmuttern	
Gewindedurchmesser	Anzugsdrehmoment
4 mm (M4)	0,8-1,5 Nm
5 mm (M5)	3,0-4,0 Nm

Nur wenn Glühkerzen mit den richtigen Drehmomenten eingeschraubt werden funktionieren diese einwandfrei



# Markierungszeichen Zündkerzen

Die Standard-Typenaufschrift ist hier aufgeführt. Es gibt außerdem noch einige besondere Bezeichnungen.

Gewindedurchmesser/ Sechskant		Struktur		Entstörwiderstand		Wärmewert	
<b>A</b>	18 mm / 25,4	<b>P</b>	vorgeschobene Isolatorspitze	<b>R</b>	Widerstand	2	<p>warme Type</p> <p>kalte Type</p>
<b>B</b>	14 mm / 20,8	<b>M</b>	Kompaktkerze	<b>Z</b>	induktiver Widerstand	4	
<b>C</b>	10 mm / 16,0	<b>U</b>	Gleitfunkentyp oder Zusatzfunkenstrecke			5	
<b>D</b>	12 mm / 18,0					6	
<b>E</b>	8 mm / 13,0	7					
<b>AB</b>	18 mm / 20,8	8					
<b>BC</b>	14 mm / 16,0	9					
<b>BK</b>	14 mm / 16,0	10					
<b>DC</b>	12 mm / 16,0						

**B P R 5 E S - 11**

Gewindelänge		Konstruktions- merkmale		Elektrodenabstand	
<b>E</b>	19,0 mm	<b>B</b>	feste SAE-Anschlussmutter (CR8EB)	leer	Motorrad: 0,7-0,8mm Auto: 0,8-0,9 mm
<b>EH</b>	19,0 mm, zur Hälfte ausgeführt	<b>CM</b>	schräg ausgeführte Massen-Elektrode Kompakt-Type (Isolatorlänge: 18.5 mm)	-8	0,8 mm
<b>H</b>	12,7 mm	<b>CS</b>	schräg ausgeführte Massen-Elektrode Kompakt-Type (Isolatorlänge: 18.5 mm)	-9	0,9 mm
<b>L</b>	11,2 mm	<b>G, GV</b>	Rennzündkerze	-10	1,0 mm
<b>F</b>	Kegeldichtsitz	<b>I</b>	Iridiumelektrode	-11	1,1 mm
	A-F--- 10,9 mm	<b>IX</b>	Iridium-Zündkerze	-13	1,3 mm
	B-F--- 11,2 mm	<b>J</b>	2 Massen-Elektroden (Spezialform)	-14	1,4 mm
	B-EF-- 17,5 mm	<b>K</b>	2 Massen-Elektroden	-15	1,5 mm
	BM-F-- 7,8 mm	<b>-L</b>	verringertes Wärmewert		
leer	Kompaktkerze	<b>-LM</b>	Kompakt-Type (Isolatorlänge: 14.5 mm)		
	BM--- 9,5 mm	<b>N</b>	spezielle Masse-Elektrode	-S	spezieller Dichtring
	BPM-- 9,5 mm	<b>P</b>	Platinelektrode	-E	spezieller Widerstand
	CM--- 9,5 mm	<b>Q</b>	4 Massen-Elektroden		
		<b>S</b>	Standard Type		
		<b>T</b>	3 Massen-Elektroden		
		<b>U</b>	Halbleitfunkentyp		
		<b>VX</b>	Platin-Zündkerze		
		<b>Y</b>	Mittелеlektrode mit V-Einkerbung		
		<b>Z</b>	spezielle Konstruktion		

# Markierungszeichen Zündkerzen

Die Standard-Typenaufschrift ist hier aufgeführt. Es gibt außerdem noch einige besondere Bezeichnungen.

Zündkerzentyp		Gewindedurchmesser / Sechskant				
<b>D</b>	besonders hohe Zündfähigkeit, doppelt ausgeführte, feine Elektroden	KA	Ø12.0	19,0mm	Dichtring	14,0
<b>I</b>	Iridiumkerze	KB	Ø12.0	19,0 mm	Dichtring	Bi-Hex 14.0
<b>L</b>	besonders langes Gewinde	MA	Ø10.0	19,0 mm	Dichtring	14,0
<b>P</b>	Platinkerze	NA	Ø12.0	17,5 mm	Kegeldichtsitz	14,0
<b>S</b>	besonders hohe Zündfähigkeit, quadratischer Platinchip	F	Ø14.0	19,0 mm	Dichtring	16,0
<b>Z</b>	vorgezogene Funkenlage	G	Ø14.0	19,0 mm	Dichtring	20,8
Oben angeführte Kennzeichen können kombiniert auftreten, z.B. ILFR..., PLZFR... "L", für besonders langes Gewinde, steht vor allen anderen Buchstaben der Längenkennzeichnung. z.B. • Kerze mit Dichtring FR5AP-11; Gewindelänge 19.0mm LFR5AP-11; Gewindelänge 26.5mm • Kerze mit Kegeldichtsitz PTR5C-13; Gewindelänge 17.5mm PLTR6A-10G; Gewindelänge 25.0mm		J	Ø12.0	19,0 mm	Dichtring	18,0
		K	Ø12.0	19,0 mm	Dichtring	16,0
		L	Ø10.0	12,7 mm	Dichtring	16,0
		M	Ø10.0	19,0 mm	Dichtring	16,0
		T	Ø14.0	17,5 mm	Kegeldichtsitz	16,0
		U	Ø14.0	11,2 mm	Kegeldichtsitz	16,0
		W	Ø18.0	10,9 mm	Kegeldichtsitz	20,8
		X	Ø14.0	9,5 mm	Dichtring	20,8
		Y	Ø14.0	11,2 mm	Kegeldichtsitz	16,0

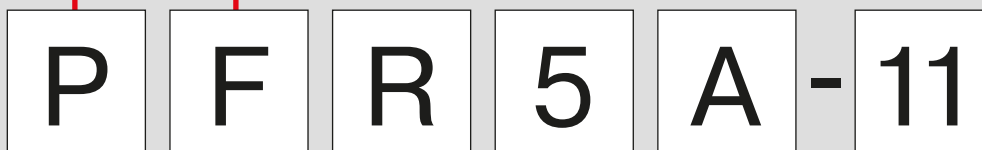

Entstörwiderstand		Wärmewert		Konstruktion		Elektrodenabstand	
<b>R</b>	Widerstand	2	warme Type	A,B,C... spezielle Merkmale	leer	Motorrad: 0.7-0.8 mm Auto: 0.8-0.9 mm	
		4			- 7	0,7 mm	
		5			- 9	0,9 mm	
		6		I Iridiumkerze	-10	1,0 mm	
		7		P Platinkerze	-11	1,1 mm	
		8			-13	1,3 mm	
		9			-14	1,4 mm	
		10		kalte Type		-15	1,5 mm
					-A	kein Dichtring	
					-D	spezielle Metallgehäusevergütung	
					-E	spezieller Widerstand	
					-G	Masse-Elektrode mit Kupferkern	
					-H	spezielles Gewinde	
					-J	2 Massen-Elektroden	
					-K	vibrationsgeschützte Massen-Elektrode	
					-N	spezielle Massen-Elektrode	
					-Q	4 Massen-Elektrode	
					-S	spezieller Dichtring	
					-T	3 Massen-Elektrode	

# Markierungszeichen Metallglühkerzen

Y - 2 0 4 T S 1

Ausführung / Type		Gewindedurchmesser		Batteriespannung		Seriennummer	Glühcharakteristik		Glühstabmaterial	Modifikationsnummer
Y/YS	Stabglühkerze	1	10 mm	0-4	12 V		Diese Ziffer ist die Seriennummer	A		
YD	Stabglühkerze mit doppeltem Isolato	2	10 mm	5-9	24 V	J		SRM Type		
		3	10 mm			R, M, U		QGS Type		
		4	14 mm			T, V		Schnellstart Type		
		5	10 mm			K oder kein Buchstabe		Standard Type		
		6	10 mm							
		7	10 mm							
		8	18 mm							
		9	12 mm							
						*Y-109, Y-159, Y-171 für Caterpillar/ Mitsubishi haben einen Gewindedurchmesser von 3/8" (ca. 9.5 mm)				<b>Erklärung</b> AQGS => Advanced Quick Glow System (Weiterentwickelte Schnellstartglühkerze)  SRM Self Regulating metal Glow Plug (selbstregulierende Metall-Glühkerze)  QGS Quick Glow System (Schnellstartglühkerze)

Y 1 001 A S 1

Ausführung / Type		Gewindedurchmesser		Seriennummer / Batteriespannung		Glühcharakteristik		Glühstabmaterial	Modifikationsnummer
Stabglühkerze		1	10 mm	001-899	12 V	A	AQGS Type		
		2	12 mm	901-999	24 V	J	SRM Type		
		4	14 mm			R, M, U	QGS Type		
		8	8 mm			T, V	Schnellstart Type		
		9	9 mm			K oder kein Buchstabe	Standard Type		
						<b>Erklärung</b> AQGS => Advanced Quick Glow System (Weiterentwickelte Schnellstartglühkerze)  SRM Self Regulating metal Glow Plug (selbstregulierende Metall-Glühkerze)  QGS Quick Glow System (Schnellstartglühkerze)			

# Markierungszeichen Metallglühkerzen

Y A 01

Stabglühkerze	Standard Type		Seriennummer
	A	Standard Type	Seriennummer
Gewindedurchmesser: 8 mm oder 9 mm	E	QGS Type (Schnellstartglühkerze) oder SRM Type (selbstregulierende Metall-Glühkerze)	

DG 183F

Type	Seriennummer
Type mit freiliegender Glühwendel	

# Markierungszeichen Keramikglühkerzen

C Y 01

Ausführung / Type	Glühcharakteristik		Seriennummer
Keramikglühkerze	X	Glühkerze mit doppeltem Isolator	Seriennummer
	Y	<b>SRC Type</b> Self Regulating ceramic Glow Plug (selbst regulierende Keramik-Glühkerze)	
	Z	<b>QGS Type</b> Quick Glow System (Schnellstartglühkerze)	

## Anmerkungen zur Tabelle

- △ = nur für Fahrzeuge mit Wegfahrsperre
- ◆ = nur für Fahrzeuge ohne Wegfahrsperre

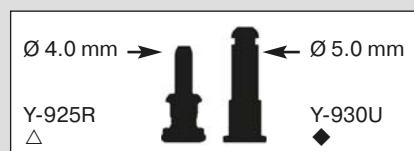



# Vergleichsliste Zündkerzen

V-LINE	NGK	BERU	BOSCH	BOSCH +
Nr. 1	BUR6ET	14GH-7DTUR	WR7LTC+	+2
Nr. 2	BPR6E	14R-6DU 14R-7DU	WR6DC+ WR7DC+	+12 +1
Nr. 3	BPR6H	14R-6BU 14R-7BU	WR6BC WR7BC+	+10
Nr. 4	BP6E	14-6DU 14-7DU	W6DC W7DC	
Nr. 5	BP6EF	14K-6DU 14K-7DU	H6DC H7DC	
Nr. 6	BPR5E	14R-8DU 14R-9DU	WR8DC+ WR9DC+	+3 +16
Nr. 7	BPR6EF	14KR-6DU 14KR-7DU	HR6DC+ HR7DC+	+18 +5
Nr. 8	BP5E	14-8DU 14-9DU	W8DC W9DC	
Nr. 9	BPR5EY	-	-	
Nr.10	BPR6EY-11	-	-	
Nr.11	BCPR6E-11	-	-	
Nr.12	BCPR6E	-	-	
Nr.13	BPR6ES-11	14R-6DUX 14R-7DUX	WR6DCX WR7DCX+	+21
Nr.14	BKR6E-11	14FR-6DUX 14FR-7DUX	FR6DCX FR7DCX+	+11
Nr.15	ZGR5A	14-8LUR	WR8LC+ WR9LC	+34
Nr.16	BCP5E	14F-8DU	F8DC	
Nr.17	BCP6E	14F-7DU	F6DC F7DC	
Nr.18	BP6H	14-6BU 14-7BU	W6BC W7BC	
Nr.19	BPR7E	14R-5DU	WR5DC+	+15
Nr.20	BKR6EK	14FR-6LDU 14FR-7LDU	FR6LDC FR7LDC+	+7
Nr.21	BUR5ET-10	14GH-8DTURX	WR8LTC+	+4
Nr.22	BUR5ET	14GH-8DTUR	W8LTCR 0.8	
Nr.23	BKR5EK	14FR-8LDUOX4	FLR8LDCU+	+9
Nr.24	BKUR6ET-10	14FGH7DTURX	F7LTCR	
Nr.25	PTR5A-13	14KR-8MPX 14KR-8MUV	HR7MPP302 HR8MCV+	+3
Nr.26	BKR6EKC	14FR-6LDUW	-	
Nr.27	BKUR6ET	14FGH-6DTUR	FR6KTC	
Nr.28	BKR6E	14FR-6DU 14FR-7DU	FR6DC+ FR7DC+	+13 +8
Nr.29	BKUR5ET	14FGH-8DTURW	F8KTCR	
Nr.30	BKR6EQUP	14FR-7DQUP7	FGR7DQP+	+48
Nr.31	PTR5D-10	-	HR8DPP22U	
Nr.32	BCPR5E	-	-	
Nr.33	BKR5E-11	14FR-8DUX	FR8DCX+	+19
Nr.34	PZFR5D-11	14F-7HPURX2	FR7HPP33+	+52
Nr.35	BKR5E	14FR-8DU	FR8DC+ FR9DC	+6
Nr.36	BKR5EZ	-	-	
Nr.37	PFR6Q	14F-7 DPUR02	FR7KPP33+	+50
Nr.38	BKR6EZ	-	FR7DE FR6KDC+ FR7KDC	+53
Nr.39	BKR5EYA-11	14FR8KU0U	FR8KCU	

# V-Line – ein Verkaufskonzept mit vielen Vorteilen

## 1. Nummernsystem

Zahlen von 1 bis 39 ermöglichen das schnelle Auffinden der richtigen Zündkerze.

## 2. Kompakt

Weniger Platzbedarf durch kompakte Abmessungen. Dadurch mehr Raum für zusätzliche Produkte.

## 3. Attraktive Verpackung

Signalcharakter führt zu Spontankäufen und forciert den Abverkauf.

## 4. Hohe Umschlag-Geschwindigkeit

Abdeckung für 95 % aller Pkw. Das verbessert Ihre Rendite.

## 5. Fachhandelsvertrieb

Kein Wettbewerb mit Kaufhäusern und Supermärkten.

## 6. Kostendämpfend

Geringe Lagerhaltungskosten optimieren Ihren Gewinn.

## 7. Umweltfaktor

Höhere Zündsicherheit. Dadurch Reduzierung von Kraftstoffverbrauch, Schadstoffausstoß und längere Lebensdauer für Katalysator. Dadurch hohe Kundenakzeptanz. Umweltfreundliche Kartonverpackung ohne Blister.

## 8. Endverbraucherwerbung

NGK sorgt für Nachfragesteigerung bei Ihren Kunden.



Das gesamte V-Line-Sortiment kann im Bodenaufsteller repräsentativ und übersichtlich angeboten werden. Eine integrierte Zuordnungsliste macht die Wahl der richtigen Zündkerze zum Kinderspiel!

# V-Line Zündkerzen bieten Vorteile auf der ganzen Linie

**Besonders bei modernen Motoren, deren Luft-/Kraftstoffgemisch aus Gründen der Schadstoff-Reduzierung sehr mager eingestellt wird, ist durch die NGK-Konstruktion eine absolut zuverlässige Gemischentflammung jederzeit gewährleistet, auch unter extremen Betriebsbedingungen!**

## Technische Vorteile

Die Verwendung von speziellem Isolatormaterial ermöglicht es, die Isolatorspitze zu verlängern. Außerdem wurde der Kupferkern im Innern der Mittelelektrode optimiert. Beide Maßnahmen führen zu noch besserer Wärmeableitung. Der dadurch vergrößerte Wärmebereich gewährleistet sicheren Start und zuverlässiges Zündverhalten auch unter extremen Motor- und Betriebsbedingungen.



### **V-Line Nr. 1, 21, 22, 24, 27, 29 Zündkerze mit 3 Masse-**

**Elektroden für die VW Gruppe**  
Speziell für die Fahrzeuge der VW Gruppe stellt NGK diesen Zündkerzentyp her.

V-Line Nr. 1, 21, 22, 24, 27, 29



### **V-Line Nr. 2 - 12, 14 - 19, 28, 32, 33, 35, 36, 38, 39**

Technologisch ist das Prinzip genial einfach – aber überaus wirksam: In der Mittelelektrode der V-Line-Zündkerze ist eine V-Einkerbung eingebracht. Patent-Nr. DE 2922 305 C2  
Dadurch springt der Zündfunke an der Außenkante der Mittelelektrode über. An dieser Stelle befindet

sich mehr zündfähiges Kraftstoff-/Luftgemisch als direkt zwischen den Elektroden. Und: Der Zündspannungsbedarf ist geringer. Somit erhöht sich die Zündsicherheit!

V-Line Nr. 2-12, 14-19, 28, 32, 33, 35, 36, 38, 39



### **Die V-Line Nr. 20, 23**

Das Prinzip dieser Zündkerzen für BMW: Im Falle von leitenden Ablagerungen auf der Isolatorspitze wird die abfließende Zündspannung „abgefangen“ und es entsteht ein Zündfunke zwischen Isolator und Masse-Elektrode. Hierbei werden die russartigen Ablagerungen abgetragen und es kommt zur sicheren Entflammung des Kraftstoff-Luft-Gemisches.

V-Line Nr. 20, 23

### Die V-Line Nr. 25

Für FORD-Modelle die mit ZETEC Motoren ausgerüstet sind, wurde von NGK die Doppel-Platin-Zündkerze PTR5A-13 entwickelt. Die Vorteile der Platin-Elektroden zeichnen sich durch einen geringeren Zündspannungsbedarf aus. Daher konnte der Elektrodenabstand vergrößert werden, um eine stabile Verbrennung und gute Leerlaufqualität zu erreichen.

Durch die verbesserten Entflammungseigenschaften können sowohl die Roh-Emissionen als auch das Drehmoment optimiert werden.



V-Line Nr. 25

### Die V-Line Nr. 26

In Zusammenarbeit mit FIAT wurde von NGK die Zündkerze BKR6EKC entwickelt. Das „C“ weist auf eine Spezial-Zündkerze für Motoren aus dem FIAT Konzern hin. Die BKR6EKC arbeitet auch unter schwierigsten Betriebsbedingungen einwandfrei – Stop and Go bei niedrigen Verbrennungstemperaturen bis hin zu höchster

Temperaturbelastung des Motors bei Vollast. Die Testergebnisse zeigen, dass das besondere Design der Zwei-Masse-Elektroden höchste Zündfähigkeit sowie die geforderte Lebensdauer der Zündkerzen innerhalb des von Fiat empfohlenen Zündkerzen-Wechselintervalls garantiert.



V-Line Nr. 26







V-Line Nr. 30

### Die V-Line Nr. 30

Hierbei handelt es sich um die in enger Zusammenarbeit zwischen BMW und NGK entwickelte Langzeitzündkerze BKR6EQUP, ausgestattet mit einer Platinmittelelektrode und 4-Masseelektroden sowie modernster Halbleitfunktentechnik.

Die Anwendung der Halbleitfunktentechnik erfordert ein spezielles Design der Isolatorspitze. Hierdurch wird sichergestellt, dass der Zündfunke immer nur zwischen den Elektroden überspringt, an denen die für eine sichere Entflammung des Kraftstoff-Luftgemisches günstigsten Bedingungen herrschen. Da jeder Zündfunke zunächst über die Isolatorspitze gleitet, bevor er den Luftspalt zwischen Isolatorspitze und Masseelektrode überspringen kann, werden eventuell dort angesammelte Ablagerungen

sofort beseitigt und Zündaussetzer sicher verhindert. Ein optimales Kaltstartverhalten bei Tiefsttemperaturen und größte Zündsicherheit auch bei extremem Kurzstreckenverkehr sind daher garantiert. Die hervorragenden, optimierten Entflammungseigenschaften der neuen Zündkerze sichern ein stabiles Leerlauf- und Beschleunigungsverhalten des Motors. Durch sicheres Entflammen, selbst unter kritischen Betriebspunkten, ist ein zusätzlicher Schutz für den Katalysator vorhanden, so dass eine hohe Langzeitstabilität der Emissionen sichergestellt ist. Dieser neue Zündkerzentyp wird ab dem Modelljahr 1997 in BMW-Motoren Verwendung verbaut. Eine rückwirkende Freigabe für bestimmte ältere BMW Fahrzeuge ab Baujahr 1987 wurde ebenfalls erteilt.



V-Line Nr. 31, 34, 37

### Die V-Line Nr. 31, 34, 37

Für FORD-Modelle die mit ENDURA Motoren ausgerüstet sind, wurde von NGK die Doppel-Platin-Zündkerze PTR5D-10 entwickelt (V-Line Nr. 31). Die Vorteile der Platin-Elektroden zeichnen sich durch einen geringeren Zündspannungsbedarf aus. Daher konnte der Elektrodenabstand vergrößert werden, um eine

stabile Verbrennung und gute Laufqualität zu erreichen. Durch die verbesserten Entflammungseigenschaften können sowohl die Roh-Emissionen als auch das Drehmoment optimiert werden.

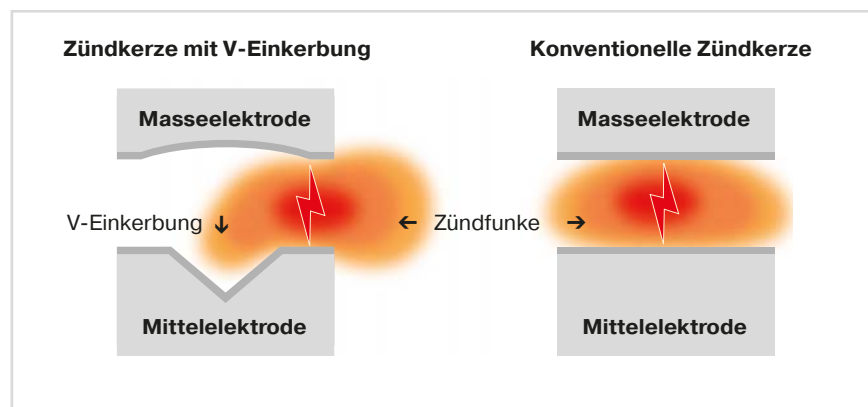



# V-Line Übersicht

V-Line	Type	Fahrzeughersteller
1	BUR6ET	AUDI, FIAT, LANCIA, SEAT, SKODA, VW
2	BPR6E	ALFA ROMEO, AUSTIN, AUTOBIANCHI, BEDFORD, BMW, CHEVROLET, CHRYSLER, DAEWOO, DAIHATSU, FIAT, FORD, HONDA, INNOCENTI, ISUZU, KIA, LADA, LANCIA, LAND ROVER, LOTUS, MAZDA, MERCEDES-BENZ, MG, MITSUBISHI, MORGAN, NISSAN, OPEL, PANTHER, PININFARINA, PORSCHE, PROTON, RENAULT, ROVER, SEAT, SUBARU, SUZUKI, TALBOT, TVR, VAUXHALL, VOLVO, ZASTAVA
3	BPR6H	BEDFORD, FORD, OPEL
4	BP6E	ALFA ROMEO, ASTON MARTIN, AUDI, AUSTIN, AUTOBIANCHI, BEDFORD, BMW, BOND, CITROËN, FIAT, FORD, FSO, GLAS, INNOCENTI, ISUZU, LADA, LANCIA, LAND ROVER, MASERATI, MERCEDES-BENZ, MG, MITSUBISHI, MORGAN, NISSAN, OPEL, PEUGEOT, RENAULT, ROVER, SAAB, SEAT, SUBARU, TALBOT, TRABANT, TRIUMPH, VAUXHALL, VOLVO, VW, WARTBURG, ZASTAVA, ZAZ
5	BP6EF	ALPINE, AUSTIN, CITROËN, LAND ROVER, MERCEDES-BENZ, PEUGEOT, PUCH, RENAULT, ROVER, TALBOT, TRIUMPH, VOLVO
6	BPR5E	ASIA MOTORS, BEDFORD, DAIHATSU, FIAT, HONDA, MARUTI, MAZDA, MITSUBISHI, NISSAN, OPEL, PROTON, RENAULT, SEAT, SUZUKI, TOYOTA, TRIUMPH, VAUXHALL, ZASTAVA
7	BPR6EF	FORD, LANCIA, RENAULT, VOLVO
8	BP5E	BMW, DAIMLER, HYUNDAI, ISUZU, JAGUAR, LAND ROVER, MG, MITSUBISHI, NISSAN, PEUGEOT, RENAULT, TRIUMPH, VW
9	BPR5EY	DAIHATSU, HONDA, SUZUKI, TOYOTA, VW
10	BPR6EY-11	DAIHATSU, HONDA, TOYOTA
11	BCPR6E-11	ACURA, FORD, FORD USA, HONDA, LADA, MAZDA, MITSUBISHI, NISSAN, ROVER, SAAB, SUBARU
12	BCPR6E	ASTON MARTIN, AUTOBIANCHI, CHEVROLET, CHRYSLER, CITROËN, DAIMLER, FIAT, FORD, FSO, JAGUAR, LANCIA, MAZDA, MORGAN, NISSAN, PEUGEOT, PONTIAC, RENAULT, ROVER, SAAB, SKODA, TVR, VOLVO
13	BPR6ES-11	HYUNDAI, ISUZU, KIA, MAZDA, MITSUBISHI, NISSAN, OPEL, SUBARU
14	BKR6E-11	CHEVROLET, DAEWOO, DAIHATSU, HONDA, ISUZU, KIA, MAZDA, MITSUBISHI, NISSAN, PEUGEOT, PROTON, ROVER, SUBARU, SUZUKI
15	ZGR5A	BERTONE, BMW
16	BCP5E	CITROËN, DAEWOO, MERCEDES-BENZ, PEUGEOT, RENAULT, SAAB, SSANGYONG
17	BCP6E	ALFA ROMEO, CITROËN, MERCEDES-BENZ, NISSAN, PEUGEOT, PUCH, RENAULT, ROVER
18	BP6H	CITROËN, DACIA, DAF, FORD, MERCEDES-BENZ, OPEL, PORSCHE, RENAULT, SEAT, SKODA, TALBOT, TRABANT, VOLVO, WARTBURG
19	BPR7E	ALFA ROMEO, AUSTIN, AUTOBIANCHI, FIAT, FORD, LANCIA, LOTUS, MITSUBISHI, PININFARINA, PORSCHE, RENAULT, SUBARU, TALBOT, VOLVO
20	BKR6EK	ALPINA, BERTONE, BMW, CITROËN, DAEWOO, FIAT, LANCIA, MERCEDES-BENZ, OPEL, PEUGEOT, PORSCHE, SAAB, VAUXHALL, WIESMANN
21	BUR5ET-10	AUDI, SAAB, SEAT, VW
22	BUR5ET	AUDI, SEAT, VW
23	BKR5EK	CHEVROLET, CITROËN, DAEWOO, FIAT, LANCIA, NISSAN, OPEL, PEUGEOT, RENAULT, SAAB, VAUXHALL
24	BKUR6ET-10	AUDI, MERCEDES-BENZ, SEAT, SKODA, VW
25	PTR5A-13	CHEVROLET, FORD, HUMMER, MAZDA, MORGAN
26	BKR6EKC	DAIHATSU, FIAT, LANCIA, LOTUS
27	BKUR6ET	FIAT, LANCIA, SEAT, VW
28	BKR6E	AUDI, AUSTIN, CATERHAM, CHRYSLER, CITROËN, DACIA, FIAT, HYUNDAI, KIA, LADA, LAND ROVER, MAZDA, MERCEDES-BENZ, NISSAN, OPEL, PANTHER, PEUGEOT, PORSCHE, RENAULT, ROVER, SKODA, SUZUKI, VOLVO, VW
29	BKUR5ET	MERCEDES-BENZ, VW
30	BKR6EQUP	ALPINA, AUDI, BENTLEY, BMW, LAND ROVER, MINI, MORGAN, PORSCHE, ROLLS-ROYCE, VOLVO
31	PTR5D-10	FORD, MAZDA
32	BCPR5E	CITROËN, PEUGEOT, RENAULT, SKODA
33	BKR5E-11	CHEVROLET, DAEWOO, DAIHATSU, HYUNDAI, INFINITI, KIA, MAZDA, MITSUBISHI, NISSAN, SUBARU
34	PZFR5D-11	FORD, SEAT, SKODA, VW
35	BKR5E	KIA, MAZDA, NISSAN, VW
36	BKR5EZ	CITROËN, FIAT, LANCIA, PEUGEOT, RENAULT
37	PFR6Q	AUDI, BENTLEY, SEAT, SKODA, VW
38	BKR6EZ	CITROËN, DACIA, FIAT, LANCIA, NISSAN, PEUGEOT, RENAULT
39	BKR5EYA-11	TOYOTA

# LPG LaserLine – Ein Sortiment wie kein zweites.

Ein spezielles Zündkerzensortiment für gasbetriebene Motoren (LPG/CNG) suchte man im Markt bislang vergebens. NGK Spark Plug Europe hat die Lücke gefüllt.

- Für gasbetriebene Motoren: LPG und CNG
- Doppel-Edelmetallausführung: Lasergeschweisst
- Spezielle Beschichtung: Schützt und erleichtert Ausbau
- Problemloser Einbau: Elektrodenabstand korrekt voreingestellt
- Mit nur 8 Typen: 95% Marktabdeckung

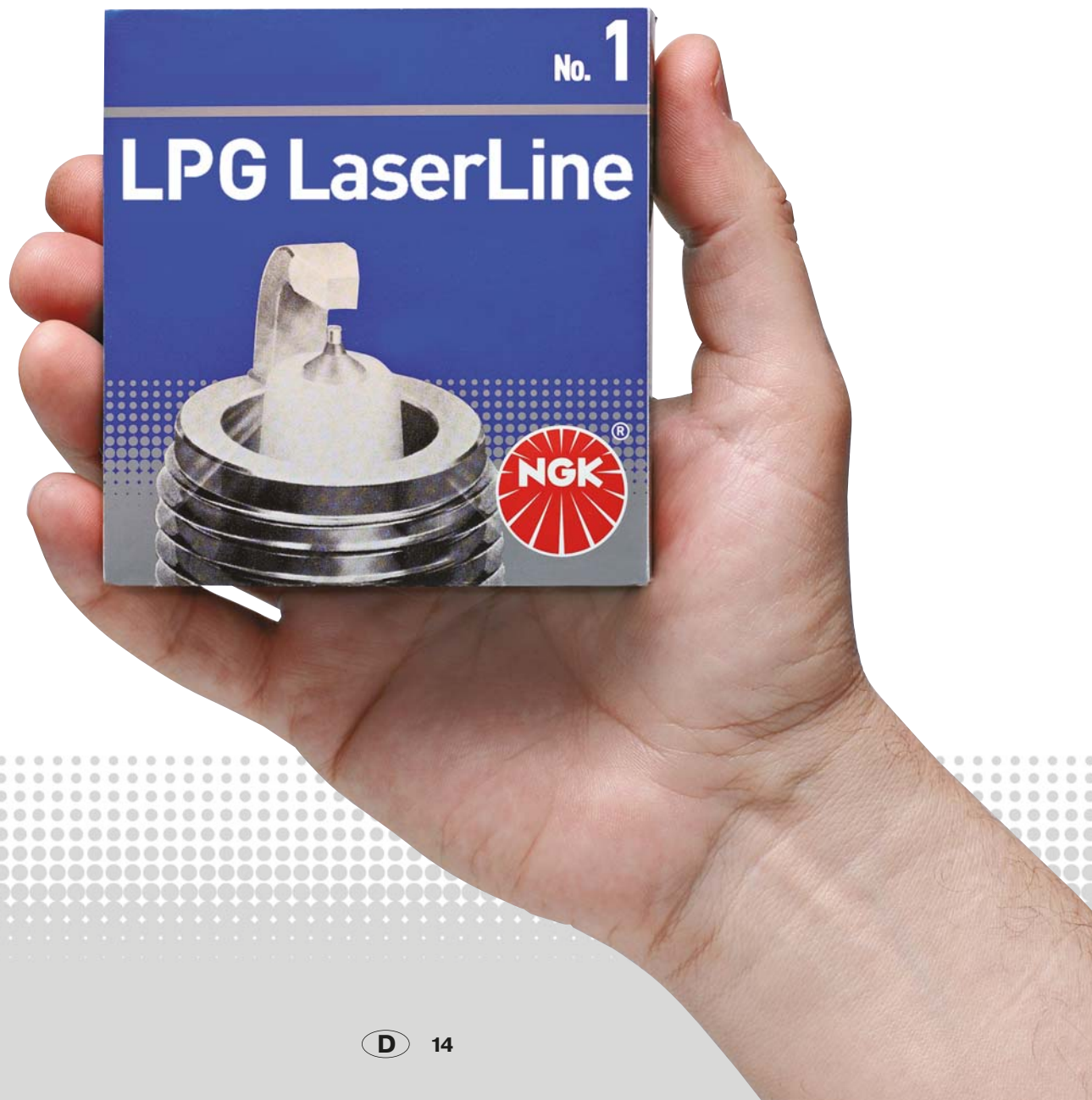

# LPG LaserLine – das Beste für gasbetriebene Motoren

**Mit LPG LaserLine steht Handel und Werkstatt erstmals ein Sortiment zur Verfügung, dessen Zündkerzen eigens für den Gasbetrieb entwickelt wurden. Für Handel und Werkstatt bedeutet das: Umrüstung und Service werden spürbar erleichtert und sicherer.**

Wer sein Auto auf den Betrieb mit Gas umrüsten lässt, profitiert europaweit von erheblich günstigeren Kraftstoffpreisen aufgrund der niedrigeren Besteuerung von Gas. Die Anzahl der Umrüstungen steigt daher von Jahr zu Jahr. Handel und Werkstatt können von dieser Entwicklung profitieren.

Bei der Wahl der richtigen Zündkerze galt es bislang allerdings, viele Faktoren im Auge zu behalten – was oft mit Mehrarbeit verbunden war. Denn die Verbrennung von Gas unterscheidet sich erheblich von der Verbrennung von Benzin: das Gas-Luft-Gemisch ist schwerer zu entflammen.

Der Zündspannungsbedarf steigt (siehe Grafik) und damit das Ausfallrisiko der Zündspulen. Hinzu kommt, dass das Gas-Luft-Gemisch heißer verbrennt.

Herkömmliche Elektroden- und Gehäusematerialien korrodieren in dieser Umgebung schneller, außerdem muss die Zündkerze mehr Hitze ableiten. Als beste

Lösung galt bislang, von Standard-Zündkerzen auf Edelmetall-Zündkerzen mit anderem Wärmewert umzustellen und in Einzelfällen den Elektrodenabstand anzupassen.

**Doch nun gibt es eine bessere Alternative:** die Spezial-Zündkerzen des **LPG LaserLine** Sortiments. Das Sortiment deckt mehr als 90 Prozent der umrüstfähigen Fahrzeuge in Europa ab, in einzelnen Ländern sogar bis zu 97 Prozent. Somit bietet **LPG LaserLine** eine ideale Zündkerze für annähernd jedes europäisches Auto, das umgerüstet wird.

Zündspannungsbedarf steigt im Gasbetrieb

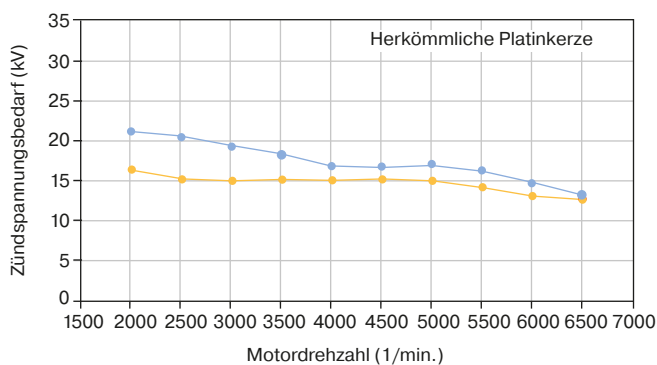

Super Benzin: —●— Elektrodenabstand 0,80 mm  
Flüssiggas (LPG): —●— Elektrodenabstand 0,80 mm



# LPG LaserLine – Spitzentechnik für den Gasbetrieb



## 1. Hightech-Elektroden

**LPG LaserLine** Zündkerzen verfügen über eine Mittelelektrode mit Iridiumspitze und eine Masseelektrode mit Platin-Chip. Diese Edelmetall-Chips werden in einem aufwendigen und eigens von NGK patentierten Verfahren mittels Laser eingearbeitet. Der Vorteil: Die Edelmetalle widerstehen den ungünstigeren Bedingungen im Gasbetrieb. Der Elektrodenabstand bleibt über die gesamte Laufleistung annähernd gleich.

## 2. Individueller Elektrodenabstand

Bei jeder **LPG LaserLine** Type wurde der für den Gasbetrieb ideale Abstand zwischen Mittel- und Masseelektrode voreingestellt. Das manuelle Anpassen entfällt also.

## 3. Optimales Wärmeverhalten

Ein Kupferkern in der Masseelektrode jeder **LPG LaserLine** Zündkerze verbessert den Temperaturabfluss und hilft so, das höhere Temperaturniveau bei der Gasverbrennung optimal zu regulieren. Konstruktive Eigenschaften schützen diese Zündkerzen noch besser vor einer Verrußung.

## 4. Hitzeschild fürs Gehäuse

Eine Beschichtung aus einer speziellen Legierung bedeckt das Gehäuse jeder **LPG LaserLine** Zündkerze. So ist es vor den höheren Temperaturen beziehungsweise der höheren Korrosionsgefahr geschützt. Eine ähnliche Beschichtung kann derzeit kein anderer Hersteller auf dem Markt bieten.

## 5. Entlastung der Zündspulen

Untersuchungen von NGK haben bewiesen: Im Gasbetrieb steigt der Zündspannungsbedarf um bis zu 7.000 Volt an – ein Härtestest für die Zündspulen. Die lediglich 0,6 mm starke Iridium-Mittellektrode einer **LPG LaserLine** Zündkerze wirkt dem entgegen. Sie kommt mit besonders wenig Zündspannung aus. Außerdem begünstigt ihre Form die optimale Ausbreitung der Flammenfront.

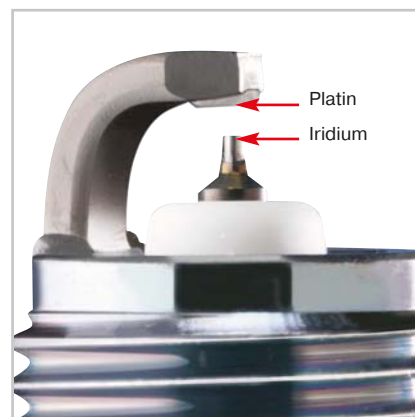

Die Mittelelektrode mit Iridium-Spitze und der Platinchip in der Masseelektrode – beide lasergeschweißt – sorgen für höchste Widerstandsfähigkeit und Zündsicherheit – über die gesamte Laufleistung.



# LPG LaserLine – Optimale Marktabdeckung

**LPG LaserLine – acht Spezialzündkerzen für die Entzündung von Gas-Luft-Gemischen. Für mehr als 90 Prozent aller umrüstfähigen Fahrzeuge im europäischen Markt.**

Die Tabelle zeigt Ihnen beispielhafte Anwendungsmöglichkeiten von LPG LaserLine Zündkerzen-Typen. Alle Anwendungen finden

Sie im NGK Zündkerzenkatalog, in TecDoc oder im Online-Produktfinder unter [www.ngk.de](http://www.ngk.de)

Anwendungsbeispiele		
LPG-Type	Fahrzeug	Motor
LPG 1	Audi A6 2.4l V6	BDV
LPG 2	Volvo 940i 2.3l	B 230 FT
LPG 3	Saab 9-5 2.3l	B235L
LPG 4	Ford Focus 1.6l	FYDA Zetec SE
LPG 5	Ford Mondeo 2.0	CJBA Duratec HE
LPG 6	VW Multivan T5 2.8l	AXK
LPG 7	Peugeot 307 1.6l	TU5 JP4 NFU
LPG 8	Fiat Grande Punto 1.4	350A1000

## Funktionsweise eines gasbetriebenen Motors

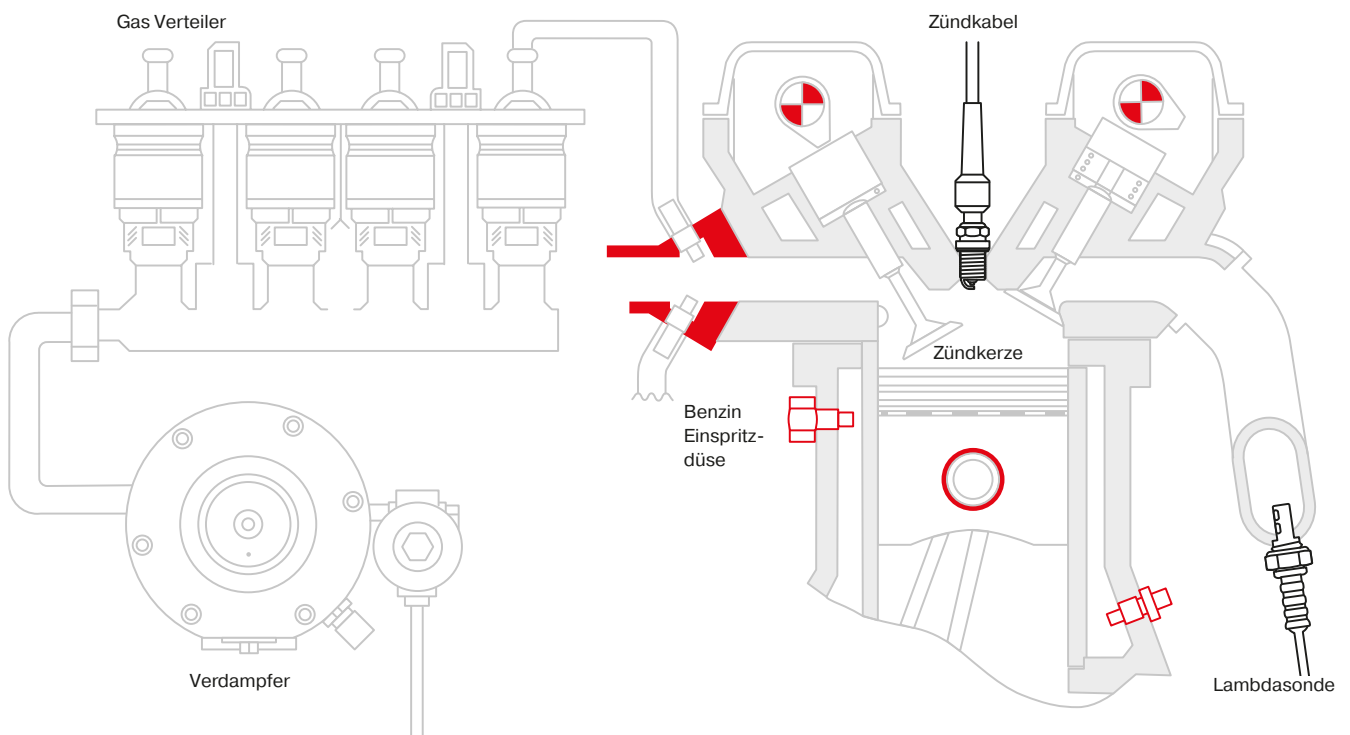



# D-POWER<sup>NGK</sup>



## D-Power: Aktuelle Dieseltechnologie in einem Sortiment

Das Glühkerzen-Sortiment bietet für nahezu alle Fahrzeuganwendungen stets eine ideale Lösung. Damit werden rund 90 % des europäischen Dieselfahrzeug-Bestandes abgedeckt.

D-Power Glühkerzen sorgen für einen schnellen und umweltfreundlichen Kaltstart selbst bei niedrigsten Außentemperaturen. Dies auch, weil sie das Know-how eines führenden Glühkerzen-Lieferanten bieten:

So findet sich im Sortiment neben Standard-Metallstabglühkerzen und Keramikglühkerzen beispielsweise die NHTC-Glühkerze mit vollkeramischem Heizelement, die von VW, Mercedes und Mitsubishi in Serie genutzt wird. Auch Glühkerzen mit Advanced Quick Glow System (AQGS) sind Teil der D-Power Range. Diese Technik wird etwa von Fiat in Serie eingesetzt.

Das bewährte Kurznummernsystem von NGK sorgt dabei dafür, dass für jedes Fahrzeug schnell eine optimale Glühkerze gefunden und bei Bedarf nachbestellt ist.

### Das Sortiment in Kürze:

- Marktabdeckung von rund 90 %
- Für nahezu alle Fahrzeugmodelle in TecDoc
- Schnelles Auffinden der passenden Glühkerze dank NGK Kurznummernsystem
- Einfache Bevorratung und Lagerpflege
- Keramik- und Metallstabglühkerzen in einem Sortiment
- Viele Glühkerzen aus der Erstausrüstung





## Keramikglühkerzen

Im Gegensatz zu einer Metallstabglühkerze besitzt die Heizwendel einer Keramikglühkerze einen besonders hohen Schmelzpunkt. Sie ist außerdem von Silikon-Nitrit umschlossen, einem extrem widerstandsfähigen, keramischen Werkstoff. Das Zusammenspiel von Heizwendel und Keramikmantel ermöglicht höhere Temperaturen und extrem kurze Vorglühzeiten dank hervorragender Wärmeleitfähigkeit. Außerdem können Keramikglühkerzen schmaler ausgelegt werden. Das ist wichtig, weil in modernen Motoren besonders wenig Platz zur Verfügung steht.

Bei einer SRC (Self Regulating Ceramic) Glühkerze besteht das Heizelement aus Keramik mit einer eingesinterten metallischen Heizwendel. Eine HTC (High Temperature Ceramic) bzw. NHTC (New High Temperature Ceramic) Glühkerze verfügt über ein Heizelement und einen Heizer aus Keramik.

Die NHTC-Keramikglühkerze hat NGK eigens entwickelt, um Automobilherstellern die Einhaltung der Euro 4 und Euro 5 Abgasnormen zu ermöglichen. Eines der Ziele der Norm ist, das Verdichtungsverhältnis bei Dieselmotoren herabzusetzen. NHTC-Glühkerzen erreichen in weniger als 2 Sekunden 1.000 °C und können mehr als 10 Minuten bei Temperaturen von bis zu 1.350 °C nachglühen. Selbst bei niedrigen Kompressionsverhältnissen ist eine optimale Entflammung gewährleistet. Darüber hinaus kann die NHTC-Glühkerze gezielt zwischenglühen, um in Schubphasen ein Auskühlen des Partikelfilters zu verhindern.

### **Keramische Glühkerzen: Das technische Optimum**

Seit mehr als 20 Jahren setzen Autohersteller keramische Glühkerzen von NGK in Serie ein. Doch kann man diese Glühkerzen gegen vergleichsweise günstigere Metallglühkerzen austauschen? Die Antwort: Natürlich „kann“ man vieles machen. Die Frage ist nur, welches Risiko man eingeht.

Wo ab Werk keramische Glühkerzen von NGK zu finden sind, sollten diese im Servicefall auch nur gegen keramische Glühkerzen von NGK ausgetauscht werden.

Der Grund: Diese Glühkerzen wurden eigens für die entsprechenden Motoren entwickelt. Keramische Glühkerzen von NGK garantieren eine lange Lebensdauer und stellen eine zuverlässige und schnelle Entflammung selbst bei niedrigsten Außentemperaturen sicher. Gleichzeitig sorgen sie für weniger schädliche Abgase. Zwar sind sie vordergründig betrachtet etwas teurer als Metallglühkerzen, aber: Metallglühkerzen können in den entsprechenden Motoren bei extremen Minusgraden zu Startproblemen führen.

### **Hinweis!**

Bei einem Umstieg auf Metall müssen alle Glühkerzen ausgetauscht werden – auch intakte.

# D-Power Übersicht

D-Power	Type	Stock-No.
DP 1	Y-924J	7906
DP 2	Y-918J	6285
DP 3	Y-910J	3617
DP 4	Y-732J	6001
DP 5	Y-937J	7503
DP 6	Y-916J	5906
DP 7	Y-506J	2419
DP 8	CY03	6160
DP 10	Y-503J	1009
DP 11	Y-745U	6346
DP 12	Y-516J	6416
DP 13	Y-733J	6592
DP 14	Y-748U	6649
DP 15	Y-913J	5317
DP 16	Y-925J	6848
DP 17	Y-730U	6704
DP 19	Y-927J	4916
DP 20	Y-741U	6943
DP 21	CY57	4994
DP 22	Y-740U	4818
DP 24	Y-504J	1441
DP 25	Y-933J	7947
DP 26	Y-747U	4694
DP 27	Y-524J	4520
DP 28	Y-711J	4467
DP 29	Y-928U	4389
DP 30	Y-930U	4275
DP 31	Y-501U	4187
DP 32	Y-507J	2691
DP 34	Y-729U	4119
DP 36	Y-534J	3413
DP 37	Y-523J	6298
DP 38	Y-746J	3078
DP 39	Y-701J	1566
DP 40	YE04	1684
DP 41	Y-929U	1749
DP 42	Y-541J	1983
DP 43	Y-939J	5059

D-Power	Type	Stock-No.
DP 44	Y-531J	5467
DP 45	Y-542J	5513
DP 46	Y-543J	5618
DP 47	Y-547AS	5968
DP 48	YE14	7768
DP 49	Y-609AS	5849
DP 50	Y-607AS	7560
DP 51	Y8002AS	6287
DP 52	CZ104	9826
DP 53	CZ106	9957
DP 54	CZ303	7865
DP 55	CZ304	9864
DP 56	Y1005J	7957
DP 57	Y1002AS	8888
DP 58	Y8001AS	8904
DP 59	Y1007J	3040
DP 60	Y-603J	8838
DP 61	Y-519J	93293
DP 62	Y8003J	97256
DP 63	Y1013J	94470
DP 64	Y8005J	96853
DP 65	Y1012J	92083
DP 66	Y-517J	91766
DP 67	Y-527J	96187
DP 68	CZ203	95232
DP 69	Y-526J1	93283
DP 70	Y1030J	90828
DP 71	Y1031J	95970
DP 72	Y9001AS	97719
DP 73	YE05	91322
DP 74	Y8008AS	91440
DP 75	Y-548J	94832
DP 76	CZ251	91238
DP 77	Y1035AS	94103
DP 78	Y9003AS	94251
DP 80	Y1039AS	91648
DP 81	Y-536J	95061



# NGK Racing Spark Plugs





# Series of NGK racing spark plugs

Blue colour indicates resistor plugs.

Thread size (Hexagon size)	Spark plug type	Spark plug number	Heat rating	Terminal nut type	Firing end	Electrode material			
						Center	Ground		
φ 14×19mm (20.8Hex)	BP-E	R4304A-	7,8,9,10		A ①	Gold Palladium	Nickel Alloy		
	B-E	R6918B-	7,8,9		B ①	Platinum	Nickel Alloy		
		R6918C-	9		B ①	Platinum	Nickel Alloy		
		R6021E-	8,9,10		B ①	Nickel Alloy	Nickel Alloy		
		R7376-	7,8,9,10		C ①	Iridium	Platinum		
		R5649-	9,10,11		E ①	Nickel Alloy	—		
		R6712-	9,10		E ①	Nickel Alloy	—		
	Short	R6179A-P	105,11		C ②	Platinum	Platinum		
φ 14×22mm (20.8Hex)	Short	R6179C-PA	105		C ②	Platinum	Platinum		
		R7376B-	9,10		C ①	Iridium	Platinum		
φ 14×22mm (16.0Hex)	Short	R7282A-※2	10,105,11		C ③	Iridium	Platinum		
φ 14×19mm (16.0Hex)	Short	R7282-※2	7,8,9,10,105,11		C ③	Iridium	Platinum		
		R7282M-※2	11,115		C ③	Iridium	Platinum		
	BK-E(ISO)※1	R6888A-	8,9,10		F ⑫	Nickel Alloy	Nickel Alloy		
		R7433-	8,9,10		A ⑤	Iridium	Nickel Alloy		
	BC-E(ISO)※1	R7434-	8,9,10		C ⑤	Iridium	Platinum		
		R7279-	10		D ⑤	Iridium	Platinum		
		R6601-	8,9,10,11		E ⑤	Nickel Alloy	—		
		R6711-	9,10		E ⑤	Nickel Alloy	—		
	BCP-E(JIS)	R7435-	8,9,10		A ④	Iridium	Nickel Alloy		
	BC-E(JIS)	R7436-	8,9,10		C ④	Iridium	Platinum		
		R5883-	9,10,11		E ④	Nickel Alloy	—		
		R6690-	9,10,11		E ④	Nickel Alloy	—		
	φ 14×26.5mm (16.0Hex)	LFR	long reach	R7437-	8,9,10		A ⑭	Iridium	Nickel Alloy
			long reach	R7438-	8,9,10		C ⑭	Iridium	Platinum
	φ 14×12.7mm(20.8Hex)	B-H	R5525-	7,8,9,10,11		B ⑦	Gold Palladium	Nickel Alloy	
			R5530-	8,9,10,11		D ⑦	Gold Palladium	Platinum	
φ 14×21.5mm(20.8Hex)	Rotary RX-7	R6725-	9,10,105,11,115		D ⑥	Platinum	Platinum		
		R7420-	9,10,105,11		D ⑥	Iridium	Platinum		
φ 14×21mm(20.8Hex)	Rotary RX-8 L	R7440A-L	9,10		C ⑮	Iridium	Platinum		
φ 14×19mm(20.8Hex)	Rotary RX-8 T	R7440B-T	10,11		C ⑮	Iridium	Platinum		
φ 12×26.5mm(16.0Hex)	LKR-E	long reach	R2556B-	8,9,10		C ⑯	Iridium	Platinum	
φ 12×26.5mm(14.0Hex)	LKAR-E	long reach	R2558A-	8,9,10		C ⑰	Iridium	Platinum	
φ 12×19mm(16.0Hex)	DC-E	R2349-	9,10,11		E ⑧	Nickel Alloy	—		
		R2525-	9,10,11		C ⑧	Platinum	Nickel Alloy		
φ 10×26.5mm(14.0Hex)	LMAR-E	long reach	R0465B-	10		E ⑱	Nickel Alloy	—	
φ 10×19mm(16.0Hex)	C-E	R0373A-	8,9,10		C ⑨	Iridium	Platinum		
		R0045G-	10,11	GAP1.4	E ⑨	Nickel Alloy	—		
		R0045J-	9,10,11,12	GAP1.1	E ⑨	Nickel Alloy	—		
		R0045Q-	10,11	GAP1.1	E ⑨	Nickel Alloy	—		
φ 10×19mm Half thread (16.0Hex)	C-EH	R0409B-	8,9,10		C ⑲	Iridium	Nickel Alloy		
φ 10×12.7mm(16.0Hex)	C-H	R0161-	9,10,11		B ⑩	Nickel Alloy	Nickel Alloy		
φ 8×19mm Half thread (13.0Hex)	E-EH	R847-	10,11		E ⑪	Nickel Alloy	—		

※ 1 ISO : The length from gasket to terminal of ISO type spark plugs is 50.5mm which is 2.5mm shorter than BCP-E or BC-E type spark plugs.

※ 2 It's necessary to use special plug caps(Please refer to page 6)

※ 3 Resistor spark plugs are recommended for cars originally equipped with resistor spark plugs.

When nonresistor spark plugs are installed in such cars, there is some possibility that the electric devices in the car, such as the audio system or the engine management system, would be affected by noise.

NOTICE) = Solid post terminal

= Thread terminal with nut

= Thread terminal



# Appearance

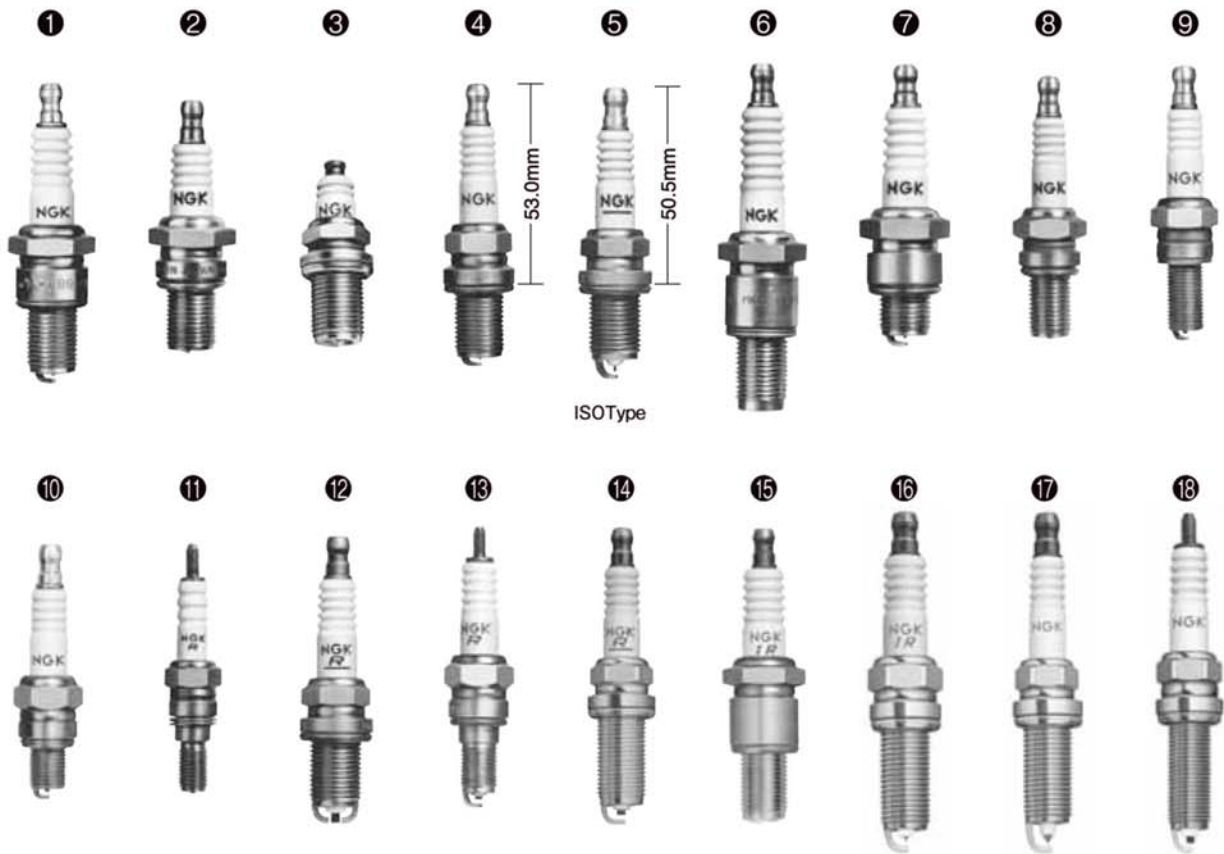

# Firing end



# Discontinued plug types

Blue colour indicates resistor plugs.

Old part number	New part number	Old part number	New part number
R016-○, R017-○	→ R0373A-○	R5400-○, R5400F-○, R6337-○	→ R7435-○
R216-○, R217-○	→ R2525-○	R5686-○	→ R7435-○ or R7436-○
R2270-○, R2430-○	→ R2349-○	R5830-○, R5687-○	→ R7436-○
R4630A-○, R6385-○P	→ R7376-○	R7112-○, R7113-○	→ R7433-○
R6120-○	→ R7282-○	R7114-○, R7115-○	→ R7433-○ or R7434-○
R6120A-○	→ R7282A-○	R7116-○, R7117-○	→ R7434-○
R6120C-○	→ R7282C-○	R7118-○, R7119-○	→ R7434-○
R6120M-○	→ R7282M-○	R7232-○, R7233-○	→ R7435-○
R6255-○, R6255F-○, R6326-○	→ R7433-○	R7234-○, R7235-○	→ R7435-○ or R7436-○
R6205-○, R6241-○	→ R7433-○ or R7434-○	R7236-○, R7237-○	→ R7436-○
R6206-○, R6242-○	→ R7434-○	R7238-○, R7239-○	→ R7436-○

# Platzierung Motornummern

Diese Informationen beziehen sich nur auf Erstausstattungsaggregate vom Fahrzeughersteller.

<b>Alfa</b>	<b>Typenschild, Motorblock</b>
<b>Audi</b>	Im Serviceheft, Motorblock, sowie: <b>A2, A3, A4, A5, A6, A8</b> Reserveradmulde rechts <b>100/200</b> Abschlußblech hinten, innen links <b>Avant</b> Boden hinten in der Mitte <b>80/90, Audi V8</b> Innenseite Gepäckraumklappe <b>Audi Coupé</b> Gepäckraum rechts unter dem Einsatz der Ablagemulde
<b>BMW</b>	Motorblock
<b>Citroën</b>	auf dem Motorblock
<b>Daihatsu</b>	Betriebsanleitung, Motorblock
<b>Fiat</b>	Typenschild, Motorblock
<b>Ford</b>	Motorblock, Typenschild
<b>Honda</b>	Motorblock am Übergang zum Getriebe
<b>Hyundai</b>	Motorblock
<b>Jaguar</b>	Motorblock, Typenschild
<b>Kia</b>	Motorblock, Getriebeseite
<b>Lada</b>	Motorblock links
<b>Lancia</b>	Motorblock, Typenschild
<b>Mazda</b>	Motorblock (Lage siehe Betriebsanleitung), Tür rechts, Federbeindom
<b>Mercedes</b>	Motorblock
<b>Mitsubishi</b>	Motorblock, Typenschild an der Motorhaube und Serviceheft
<b>Nissan</b>	Motorblock
<b>Opel</b>	Motorblock in Höhe Getriebe
<b>Peugeot</b>	Motorblock (Aluschild)
<b>Renault</b>	Motorblock (Mitte), bzw. Aluschild
<b>Rover</b>	Motorblock vorne rechts, in Höhe vom Zylinderkopf
<b>Saab</b>	Motorblock unten
<b>Seat</b>	Motorblock, ab '93er Modell wie VW
<b>Skoda</b>	Motorblock neben dem Verteiler
<b>Subaru</b>	Motorblock neben der Zahnriemenabdeckung
<b>Suzuki</b>	Motorblock am Übergang zum Getriebe F = Gußblock G = Alublock
<b>Toyota</b>	Aufkleber an der Zahnriemenabdeckung oder Ventildeckel/Stirnblech/Tür vorn links
<b>VW</b>	im Serviceheft, Motorblock, sowie: <b>Käfer:</b> Abschlußblech vorn links <b>Lupo, Polo, Derby, Golf, Scirocco, Jetta</b> <b>Passat Limousine, Corrado, Vento, Bora:</b> Abschlußblech hinten, innen links <b>Golf Cabrio:</b> Querholm hinter der Rücksitzbank, links <b>Passat Variant:</b> Reserveradmulden, hinten links <b>Transporter:</b> Querträger Schalttafel links <b>LT:</b> B-Säule, links unten <b>Ilitis:</b> Bodenblech links neben dem Verbandskasten <b>Taro:</b> Kabinenrückwand, innen links
<b>Volvo</b>	<b>300, 700, 900, C, S und V Serie</b> Aufkleber auf dem Stirndeckel <b>alle anderen Modelle</b> Aufkleber auf dem Ventildeckel

# SERIES OF NGK SPARK PLUGS

NGK ZÜNDKERZENSERIEN

SÉRIES DES BOUGIES NGK

SERIES DE BUJÍAS DE ENCENDIDO NGK TYPBETECKNINGAR FÖR NGK TÄNDSTIFT

## STANDARD TYPES

STANDARD AUSFÜHRUNGEN  
TIPOS ESTANDARES

TYPES STANDARDS  
STANDARDTYPER

	NON-RESISTOR NON-RÉSISTANCE ICKERESISTOR	OHNE WIDERSTAND NO-RESISTOR	RESISTOR RÉSISTANCE RESISTOR	MIT WIDERSTAND RESISTOR	
14mm $\phi$ $\times$ 9.5mm 20.8 Hex Fig. ①(a)	B-2 B-4 B6S B7S B8S		BR6S		
	Fig. ①(c)	BP-4 BP5S BP6S			
14mm $\phi$ $\times$ 19.0mm 20.8 Hex Fig. ②(a)	B4ES B5ES B6ES,-11 B7ES,-11 B8ES B9ES B10ES		BR4ES BR5ES BR6ES,-11 BR7ES BR8ES,-11 BR9ES BR10ES		
	Fig. ②(b)			BR6EB-L-11	
	Fig. ②(h)			BR8EYA BR9EYA BR10EYA	
	Fig. ②(c)	BP2ES, BP-2E BP4ES,-11 BP4ES-L-11 BP5ES,-11,-13 BP6ES,-11 BP7ES,-11 BP8ES BP9ES	BP5ESZ BP6ESZ	BPR2ES, BPR-2E BPR4ES,-11,-13 BPR5ES,-11,-13 BPR6ES,-11,-13 BPR7ES,-11 BPR8ES BPR9ES	
		Fig. ②(d)			BPR5EA BPR5EA-L,-11
	Fig. ③(e)			BPR6EKN BPR7EKN	
	Fig. ②(f)	BP4EY,-11 BP5EY,-11 BP6EY,-11 BP7EY			BPR4EY,-11 BPR5EY,-11 BPR6EY,-11 BPR7EY,-11
	Fig. ②(i)	BP5E BP6E			BPR4E,-11 BPR5E,-11 BPR6E,-11 BPR7E
	Fig. ④(g)	BP5ET,-10 BP6ET BP7ET			
	Fig. ⑤(i)			BPR5EJ	
14mm $\phi$ $\times$ 19.0mm 16.0 Hex Fig. ⑥(c)	BCP4ES,-11 BCP5ES,-11 BCP6ES,-11 BCP7ES,-11		BCPR4ES-11 BCPR5ES,-11 BCPR6ES,-11 BCPR7ES,-11 BCPR9ES-11		
	Fig. ⑧(g)	BCP5ET BCP6ET BCP7ET	BCPR5ET BCPR6ET BCPR7ET		
	Fig. ⑥(a)	BC6ES		BCR8ES	
	Fig. ⑦(c)	BK5ES	BK5ESZ	BKR4ES-11 BKR5ES,-11 BKR6ES,-11 BKR7ES-11	

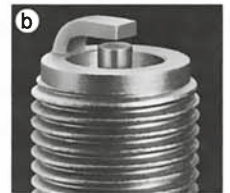
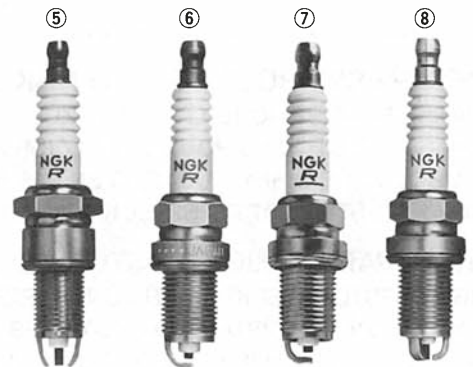
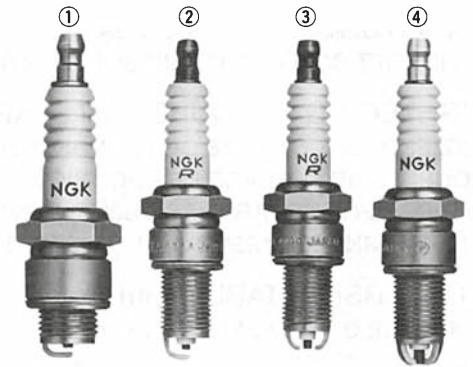

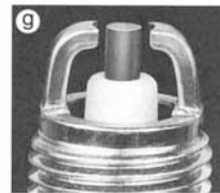
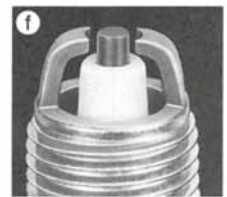
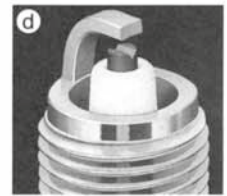
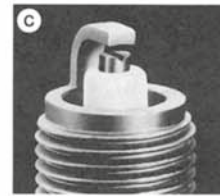
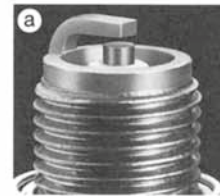

	NON-RESISTOR NON-RÉSISTANCE ICKERESISTOR	OHNE WIDERSTAND NO-RESISTOR	RESISTOR RÉSISTANCE RESISTOR	MIT WIDERSTAND RESISTOR
14mm $\phi$ $\times$ 19.0mm 16.0 Hex Fig. ①③		<b>BCP5EY-11</b>	<b>BCPR4EY-11</b> <b>BCPR5EY,-11,-N-11</b> <b>BCPR6EY,-11,-N-11</b> <b>BCPR7EY,-11,-N-11</b>	
	Fig. ②③ ISO		<b>BKR4EY,-11</b> <b>BKR5EY,-11 BKR5EYA,-11</b> <b>BKR6EY,-11 BKR6EYA,-11</b> <b>BKR7EY</b>	
	Fig. ①④	<b>BCP5E,-11</b> <b>BCP6E,-11</b> <b>BCP7E,-11</b>	<b>BCPR5E,-11</b> <b>BCPR6E,-11</b> <b>BCPR7E,-11</b>	
	Fig. ②④ ISO	<b>BK5E,-11</b> <b>BK6E,-11</b>	<b>BKR4E,-11</b> <b>BKR5E,-11,-N,-N-11 BKR5EZ</b> <b>BKR6E,-11,-N,-N-11 BKR6EZ</b> <b>BKR7E,-11,-N-11</b> <b>BKR8E-11</b>	
	Fig. ⑥① ISO		<b>BKR5EK</b> <b>BKR6EK</b>	
	Fig. ⑥② ISO		<b>BKR5EKB-11</b> <b>BKR6EKB-11</b> <b>BKR5EKC</b> <b>BKR6EKC,-N-11 BKR6EKE</b> <b>BKR7EKC,-N,-N-11</b>	
14mm $\phi$ $\times$ 26.5mm 16.0 Hex Fig. ⑧④			<b>LFR4A,-11 LFR4A-E</b> <b>LFR5A,-11</b> <b>LFR6A,-11</b>	
14mm $\phi$ $\times$ 11.2mm Conical seat 16.0 Hex Fig. ③①		<b>B7FS</b>	<b>BR5FS</b> <b>BR6FS,-15</b>	
	Fig. ③②	<b>BP4FS</b> <b>BP5FS</b> <b>BP6FS</b> <b>BP7FS</b>	<b>BPR4FS,-11,-15</b> <b>BPR5FS,-11,-15</b> <b>BPR6FS</b>	
	Fig. ③③	<b>BP5F</b> <b>BP6F</b>		
14mm $\phi$ $\times$ 17.5mm Conical seat 16.0 Hex Fig. ④①		<b>B6EFS</b> <b>B8EFS</b> <b>B9EFS</b>	<b>BR7EFS</b>	
	Fig. ④②		<b>BR6EF</b> <b>BR7EF</b>	
	Fig. ④③	<b>BP4EFS</b> <b>BP5EFS,-13</b> <b>BP6EFS,-13</b> <b>BP7EFS</b>	<b>BPR5EFS,-13</b> <b>BPR6EFS,-13,-15</b> <b>BPR7EFS-15</b>	
	Fig. ④④	<b>BP6EF</b>	<b>BPR6EF,-11,-13</b>	
14mm $\phi$ $\times$ 25.0mm Conical seat 16.0 Hex Fig. ⑦②			<b>TR5A-13</b> <b>TR5B-13</b> <b>TR6B-10,-13</b>	
14mm $\phi$ $\times$ 11.2mm 20.8 Hex Fig. ⑤①		<b>B-4L</b> <b>B-6L B6LY(Fig. ⑤②)</b>		





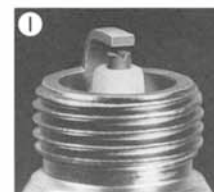
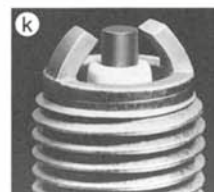
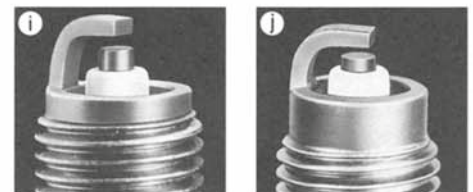
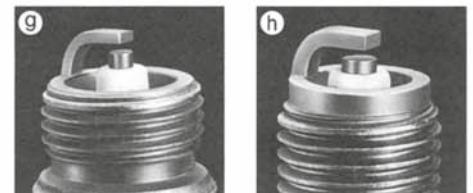
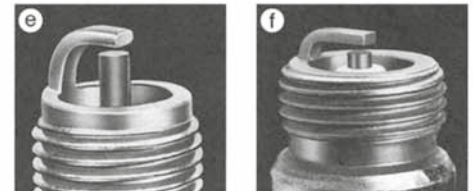
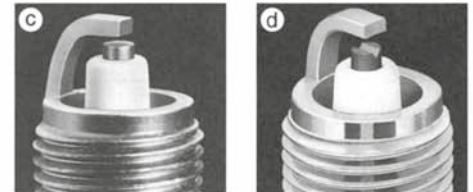
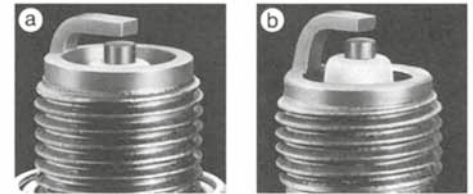

	NON-RESISTOR NON-RÉSISTANCE ICKERESISTOR	OHNE WIDERSTAND NO-RESISTOR	RESISTOR RÉSISTANCE RESISTOR	MIT WIDERSTAND RESISTOR
14mm $\phi$ × 12.7mm 20.8 Hex Fig. ①②		<b>B-2H</b> <b>B-4H,-10</b> <b>B5HS</b> <b>B6HS,-10</b> <b>B7HS,-10</b> <b>B8HS,-10</b> <b>B9HS,-10</b> <b>B10HS</b>		<b>BR4HS</b> <b>BR5HS</b> <b>BR6HS,-10</b> <b>BR7HS,-10</b> <b>BZ7HS-10</b> <b>BR8HS,-10</b> <b>BR9HS,-10</b>
	Fig. ①③	<b>BP2HS,-10</b> <b>BP-2H</b> <b>BP4HS,-10</b> <b>BP4HSA</b> <b>BP-4H</b> <b>BP5HS,-10</b> <b>BP6HS,-10</b> <b>BP6HSA</b> <b>BP6H</b> <b>BP7HS,-10</b> <b>BP7H</b> <b>BP8HS,-10,-15</b> <b>BP8HSA</b>	<b>BPR2HS</b> <b>BPR4HS,-10</b> <b>BPR4HSA</b> <b>BPR-4H</b> <b>BPR5HS</b> <b>BPR6HS,-10</b> <b>BPR6HSA</b> <b>BPR7HS,-10</b> <b>BPZ8H-N-10</b> <b>BPR8HS,-10</b> <b>BPR8HSA</b> <b>BPZ8HS-10,-15</b>	
	Fig. ①④	<b>BP4HA</b> <b>BP5HA</b>		
	Fig. ①⑤	<b>B6HSA</b> <b>B8HSA</b>		<b>BR4HSA,-9</b> <b>BR6HSA,-9</b> <b>BR8HSA,-9</b>
18mm $\phi$ × 10.9mm Conical seat 20.8 Hex Fig. ④⑥		<b>A6FS</b> <b>A7FS</b> <b>A8FS</b> <b>A9FS</b>		<b>AR6FS</b>
	Fig. ④⑦	<b>AP4FS</b> <b>AP5FS</b> <b>AP6FS</b> <b>AP7FS</b> <b>AP8FS</b> <b>AP9FS</b>		<b>APR5FS</b> <b>APR6FS</b>
	Fig. ④⑧	<b>AP6F</b>		<b>APR6F</b>
18mm $\phi$ × 12.0mm 20.8 Hex Fig. ⑤⑩		<b>AB-2</b> <b>AB-6</b> <b>AB-7</b> <b>AB-8</b>		
12mm $\phi$ × 19.0mm 18.0 Hex Fig. ⑥⑪		<b>D6EA</b> <b>D7EA</b> <b>D8EA</b> <b>D9EA</b> <b>D10EA</b>		<b>DR7EA</b> <b>DR7EB</b> <b>DR8EA</b> <b>DR8EB</b> <b>DR9EA</b>
	Fig. ⑥⑫	<b>DP6EA-9</b> <b>DP7EA-9</b> <b>DP8EA-9</b> <b>DP9EA-9</b>	<b>DPR5EA-9</b> <b>DPR6EA-9</b> <b>DPR6EB-9</b> <b>DPR7EA-9</b> <b>DPR8EA-9</b> <b>DPR9EA-9</b>	
	Fig. ⑥⑬	<b>J9A</b>		<b>JR8B</b> <b>JR9B</b> <b>JR10B</b>
	Fig. ⑥⑭			<b>JR8C</b> <b>JR9C</b>
12mm $\phi$ × 21.0mm 18.0 Hex Fig. ⑦⑮		<b>DP8Z</b>		<b>DPR7Z</b> <b>DPR8Z</b> <b>DPR9Z</b>
12mm $\phi$ × 19.0mm 16.0 Hex Fig. ⑧⑯		<b>DCP6E</b> <b>DCP7E</b>		<b>DCPR6E</b> <b>KR6A-10</b> <b>DCPR7E</b> <b>DCPR7E-N</b> <b>DCPR8E</b> <b>DCPR8E-N</b> <b>DCPR9E</b>
	Fig. ⑧⑰			<b>DCPR8EKC</b>
12mm $\phi$ × 26.5mm 16.0 Hex Fig. ⑨				<b>LKR6D-10</b> <b>LKR7C</b> <b>LKR7E</b>
12mm $\phi$ × 26.5mm 14.0 Hex Fig. ⑨				<b>LKAR8A-9,9S</b>

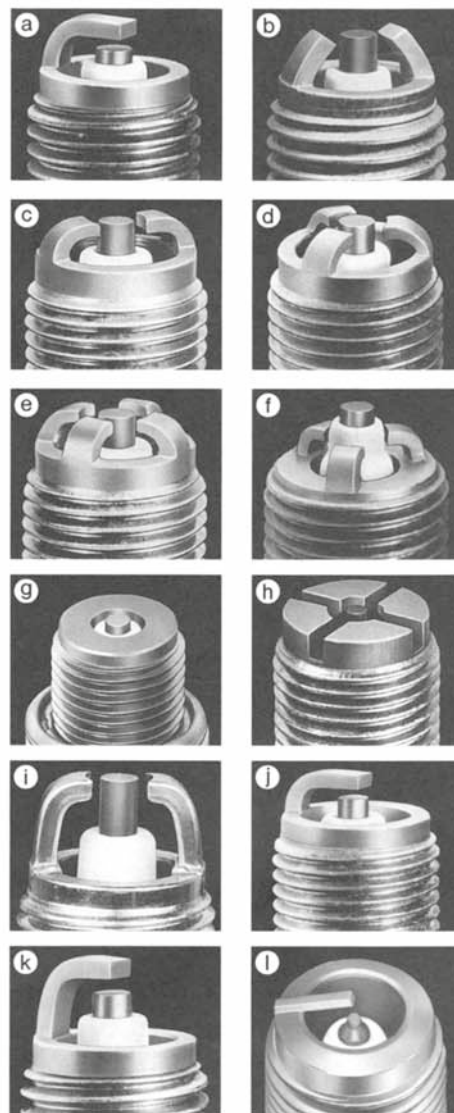

	NON-RESISTOR NON-RÉSISTANCE ICKERESISTOR	OHNE WIDERSTAND NO-RESISTOR	RESISTOR RÉSISTANCE RESISTOR	MIT WIDERSTAND RESISTOR
12mm $\phi$ $\times$ 12.7mm 18.0 Hex Fig. ①②	<b>D6HA</b> <b>D8HA</b>		<b>DR4HS</b> <b>DR5HS</b> <b>DR6HS</b> <b>DR8HS</b>	
10mm $\phi$ $\times$ 12.7mm 16.0 Hex Fig. ②③	<b>C2H</b> <b>C5HSA</b> <b>C6HSA</b> <b>C7HSA</b> <b>C8HSA</b>	<b>C4HSB</b> <b>C5HSB</b>	<b>CR4HSA</b> <b>CR5HSA</b> <b>CR6HSA</b> <b>CR7HSA</b> <b>CR8HSA</b>	<b>CR4HSB</b> <b>CR5HSB</b> <b>LR4C-E</b> <b>LR8A</b> <b>LR8B</b>
10mm $\phi$ $\times$ 19.0mm 16.0 Hex Fig. ③④	<b>C7E</b> <b>C8E</b> <b>C9E</b>		<b>CR6E</b> <b>CR7E</b> <b>CR8E</b> <b>CR9E</b> <b>CR10E</b>	<b>CR7EB</b> <b>CR8EB</b> <b>CR9EB</b>
	Fig. ③⑤		<b>CPR6EA-9S</b> <b>CPR7EA-9</b>	
10mm $\phi$ $\times$ 19.0mm 16.0 Hex Fig. ④⑥	<b>C7EH-9</b> <b>C8EH-9</b> <b>C9EH-9</b>		<b>CR5EH-9</b> <b>CR7EH-9</b> <b>CR8EH-9</b> <b>CR9EH-9</b> <b>CR10EH-9</b>	
10mm $\phi$ $\times$ 19.0mm 16.0 Hex Fig. ③⑦			<b>CR7EK</b> <b>CR8EK</b> <b>CR9EK</b> <b>CR10EK</b>	<b>CR7EKB</b> <b>CR8EKB</b> <b>CR9EKB</b>
	Fig. ③⑧		<b>CR7EKC</b>	
10mm $\phi$ $\times$ 19.0mm 14.0 Hex Fig. ⑧			<b>MAR9A-J</b> <b>MAR10A-J</b>	<b>MAR8B-JDS</b> <b>MAR9B-JDS</b>
10mm $\phi$ $\times$ 26.5mm 14.0 Hex Fig. ⑨			<b>LMAR6A-9</b> <b>LMAR7A-9</b> <b>LMAR8A-9,9S</b>	<b>LMAR6C-9</b>
	Fig. ⑧		<b>LMAR9D-J</b>	
8mm $\phi$ $\times$ 19.0mm 13.0 Hex Fig. ⑤⑩			<b>ER8EH, -N</b> <b>ER9EH, -N, -6N</b> <b>ER10EH</b>	



**FOR ROTARY ENGINE**  
**FÜR WANKELMOTOR**    **POUR MOTEUR ROTATIF**  
**PARA MOTOR ROTATIVO**    **TÄNDSTIFT FÜR WANKELMOTORER**

	NON-RESISTOR NON-RÉSISTANCE ICKERESISTOR	OHNE WIDERSTAND NO-RESISTOR	RESISTOR RÉSISTANCE RESISTOR	MIT WIDERSTAND RESISTOR
14mm $\phi$ $\times$ 19.5mm 20.8 Hex Fig. ⑥③	<b>B7EM</b>		<b>BR8EM</b>	
	Fig. ⑥④		<b>BR7ET</b> <b>BR8ET</b> <b>BR9ET</b> <b>BR10ET</b>	
	Fig. ⑥⑤		<b>BR7EQ-14</b> <b>BR8EQ,-14</b> <b>BR9EQ-14</b>	
14mm $\phi$ $\times$ 21.5mm 20.8 Hex Fig. ⑧⑨			<b>SD10A</b> <b>SD11A</b>	
	Fig. ⑧⑩		<b>BUR6EQ</b> <b>BUR7EQ</b> <b>BUR8EQ</b> <b>BUR9EQ</b>	<b>BUR7EQP</b> <b>BUR9EQP</b>
14mm $\phi$ $\times$ 21.0mm 20.8 Hex Fig. ⑨			<b>RE6C-L</b> <b>RE7C-L</b> <b>RE8C-L</b>	
14mm $\phi$ $\times$ 19.0mm 20.8 Hex Fig. ⑩①			<b>RE9B-T</b>	

**SEMI SURFACE DISCHARGE TYPES**  
**HALBGLEITFUNKENTYP TYPE À DÉCHARGE**  
**TIPO DE DESCARGA DE MEDIA SUPERFICIE**  
**STIFT MED YTGNIISTGAP**

	NON-RESISTOR NON-RÉSISTANCE ICKERESISTOR	OHNE WIDERSTAND NO-RESISTOR	RESISTOR RÉSISTANCE RESISTOR	MIT WIDERSTAND RESISTOR
14mm $\phi$ × 12.7mm 20.8 Hex Fig. ①a	<b>BU8H</b>		<b>BUZ8H</b>	
14mm $\phi$ × 19.0mm 20.8 Hex Fig. ②b	<b>BU6EA-11</b>		<b>BUR5EA-11</b> <b>BUR6EA-11</b> <b>BUR7EA-11</b>	
14mm $\phi$ × 19.0mm 20.8 Hex Fig. ②c			<b>BUR4EB-11</b> <b>BUR5EB-11</b> <b>BUR6EB-11</b> <b>BUR7EB-11</b>	
	Fig. ②d		<b>BUR5ET,-10</b> <b>BUR6ET</b>	
14mm $\phi$ × 19.0mm 20.8 Hex Fig. ③e	<b>BP5EK-A</b> <b>BP6EK-A</b>		<b>BPR5EK-A</b> <b>BPR6EK-A</b>	
	Fig. ③f		<b>BPR5EKU</b>	
14mm $\phi$ × 17.5mm Conical seat 16.0 Hex Fig. ④g	<b>BU6EFSZ</b>		<b>BUR6EFSZ</b>	
14mm $\phi$ × 19.0mm 16.0 Hex Fig. ⑥e ISO			<b>BKUR6EK,-9</b> <b>BKUR7EK</b>	
	Fig. ⑤d ISO		<b>BKUR5ET,-10</b> <b>BKUR5ETZ-10</b> <b>BKUR6ET,-10</b> <b>BKUR6ETB</b> <b>BKUR7ET</b>	
	Fig. ⑥f ISO	<b>BK7EKU</b>	<b>BKR5EKU</b> <b>BKR6EKU</b> <b>BKR7EKU</b>	
	Fig. ⑥h ISO		<b>BKR6EKUE</b>	
14mm $\phi$ × 22.0mm 16.0 Hex Fig. ⑦i			<b>BKR5EKUC</b> <b>BKR6EKUC</b>	
14mm $\phi$ × 19.0mm 16.0 Hex Fig. ⑥j			<b>BKR6EQUA</b>	

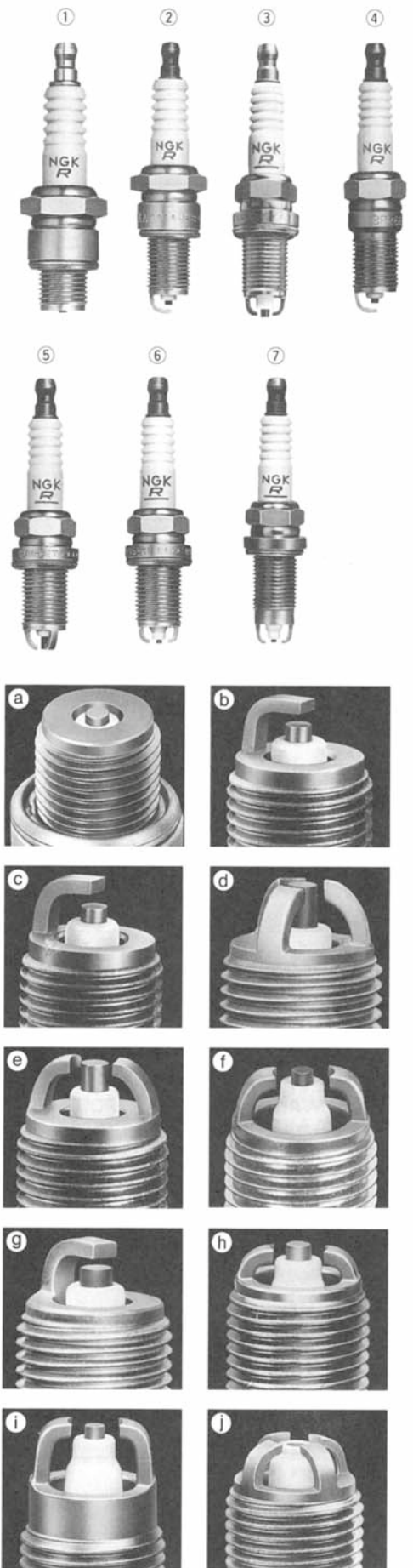



**PROJECTED GAP TYPES**  
**ZUNDKERZEN MIT VORSPRINGENDER FUNKENSTRECK**  
**TYPE À ÉCARTEMENT EN SAILLIE**  
**TIPOS DE ABERTURA DE CHISPA PROYECTADA**  
**STIFT MED FÖRLÄNGDA ELEKTRODER**

	NON-RESISTOR NON-RÉSISTANCE ICKERESISTOR	OHNE WIDERSTAND NO-RESISTOR	RESISTOR RÉSISTANCE RESISTOR	MIT WIDERSTAND RESISTOR
14mm $\phi$ × 19.0mm 20.8 Hex Fig. ①Ⓐ	<b>BE527Y-11</b> <b>BE529Y-11</b>		<b>BRE527Y-11</b> <b>BRE529Y-11</b>	
Fig. ②Ⓑ			<b>ZGR4A</b> <b>ZGR5A</b>	
14mm $\phi$ × 26.0mm 20.8 Hex Fig. ②Ⓓ	<b>ZG5D-11</b>			
14mm $\phi$ × 20.5mm 20.8 Hex Fig. ②Ⓑ			<b>ZGR5B,-11</b> <b>ZGR6B-11</b>	
14mm $\phi$ × 22.0mm 20.8 Hex Fig. ②Ⓒ			<b>ZGR5C</b>	
14mm $\phi$ × 19.0mm 16.0 Hex Fig. ③Ⓑ	<b>ZF6A-11</b>		<b>ZFR5A-11</b> <b>ZFR6A-11</b>	
Fig. ④Ⓑ			<b>ZFR4F-11</b> <b>ZFR5F-11</b> <b>ZFR6F-11,G</b> <b>ZFR7F-11</b>	<b>ZFR5J-11</b> <b>ZFR6J-11</b> <b>ZFR6U-11</b> <b>ZFR7J-11</b>
Fig. ③Ⓐ			<b>BCRE527Y</b>	
14mm $\phi$ × 20.5mm 16.0 Hex			<b>ZFR6K-11S</b>	
Fig. ③Ⓔ			<b>ZFR5G</b> <b>ZFR6G</b>	
14mm $\phi$ × 22.5mm 16.0 Hex Fig. ③Ⓒ			<b>ZFR4E-11</b> <b>ZFR5E-11</b> <b>ZFR6E-11</b>	
Fig. ③Ⓓ			<b>ZFR5D-11</b> <b>ZFR6D-11</b>	
14mm $\phi$ × 25.0mm Conical seat 16.0 Hex Fig. ⑤Ⓑ			<b>LZTR4A-11</b> <b>LZTR5A-13</b>	
12mm $\phi$ × 19.0mm 16.0 Hex			<b>ZKR7A-10</b>	
12mm $\phi$ × 26.5mm 16.0 Hex			<b>LZKR6B-10E</b>	
12mm $\phi$ × 26.5mm 14.0 Hex			<b>LZKAR6C-11</b>	
12mm $\phi$ × 26.3mm 14.0 Bi-Hex			<b>ZKBR7A-HTU</b>	

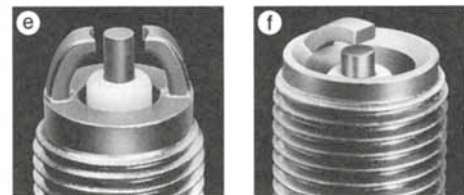
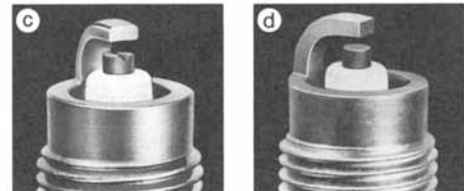
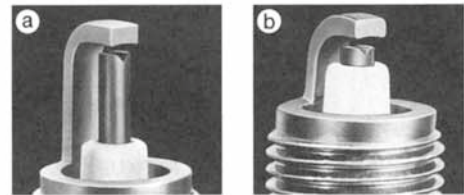

**COMPETITION TYPES**  
**WETTBEWERBS-TYPEN**      **TYPES COMPÉTITION**  
**TIPOS DE COMPETICIÓN**      **RACERSTIFT**

14mm $\phi$ × 12.7mm 20.8 Hex Fig. ⑥Ⓕ	<b>B7HCS</b> <b>B8HCS</b> <b>B9HCS</b>	<b>BR8HCS-10</b>
14mm $\phi$ × 19.0mm 20.8 Hex Fig. ⑦Ⓕ	<b>B7ECS</b> <b>B8ECS</b> <b>B9ECS</b>	<b>BR8ECS</b> <b>BR9ECS</b> <b>BR10ECS</b>
Fig. ⑧Ⓕ		<b>BR8ECM</b> <b>BR9ECM</b> <b>BR10ECM</b>



**PLATINUM, IRIIDIUM TIPPED TYPES**  
**TYPEN MIT PLATINELEKTRODENSPITZE, IRIIDIUMSPITZE**  
**TYPE[S] A EXTREMITÉ EN PLATINE, IRIIDIUM**  
**TIPOS CON PUNTA DE PLATINO, IRIIDIUM**  
**STIFT MED MITTELEKTRODÄNDA AV PLATINA OCH IRIIDIUM**

	RESISTOR MIT WIDERSTAND RÉSISTANCE RESISTOR RESISTOR
14mm $\phi$ $\times$ 19.0mm 20.8 Hex Fig. ①①	PGR5A,-11 PGR5C-11 BPR5EP-11,-13 PGR6A,-11 PGR6C-11 BPR6EP-8 PGR7A,-11 <b>IGR7A</b>
14mm $\phi$ $\times$ 19.0mm 20.8 Hex Fig. ①⑧	<b>IGR5C13</b>
14mm $\phi$ $\times$ 19.0mm 16.0 Hex Fig. ②③	PFR5A-11 PFR5K-11 BCPR5EP-8,-11,-13 PFR6A-11 PFR6H-10 PFR6K-11 BCPR6EP-8,N-8,-11,-N-11,-13 PFR7A-11 PFR7H-10
Fig. ③⑧ ISO	FR4AP-10,-11 FR4BP-11 FR5AP-10,-11 FR5BP-11 FR6AP-10,-11 FR6BP-11 FR7AP-11 <b>FR5AP-11E</b>
	<b>FR5EI-13</b>
	PFR4B-11 PFR4C-11 PFR5B,-9,-11,-11B PFR5C-11 PFR6B,-9,-11,-11B,-11C PFR6C-11 PFR6E-10 PFR7B,-9,-11,-11C PFR8B,-9
	PFR4G-11 PFR5G-11,-13E PFR5J-11 PFR6G,-9,-11,-13,-13E PFR6H-10 PFR6J,-11 PFR7G,-9,-11
	PFR5L-11 PFR5N-11,8DS PFR4P PFR6L-11,-13 PFR6N-11 PFR5P-11 PFR7N-D PFR6P-11 PFR6Q PFR7Q
	<b>PFR5R-11</b>
	<b>BKR5EP-8,-11</b> <b>BKR6EP-8,-11,-13,-N-8</b>
Fig. ④③ ISO	<b>BKR6EKPA</b>
Fig. ④④ ISO	<b>BKR5EKUP</b>
Fig. ④⑤ ISO	<b>BKR5EKPB-11,-13</b> <b>BKR6EKPB-11</b>
Fig. ④① ISO	<b>BKR5EQUPA</b> <b>BKR6EQUP BKR6EQUPA</b>
Fig. ③① ISO	PFR6M PFR6X-11 PFR7M PFR7S8EG
Fig. ③⑨ ISO	PZFR5B PZFR5F,-11,-13 IZFR5B IZFR5F11 IZFR5G IZFR5L11 PZFR6B PZFR6F,-11 IZFR6B IZFR6F11 PZFR7F
Fig. ③⑧ ISO	IFR5A11,-8N IFR5D10 IFR5E11 IFR6A11 IFR6C IFR6D10 IFR6E11 <b>IFR7F-D</b>
	IFR5G11 IFR5J11 IFR5N10 IFR5T-8N,11 IFR6J11 IFR6S IFR6T11 IFR7X7G
Fig. ③	<b>PZFR6H IZFR6J IZFR6N-E IZFR6Q</b>
Fig. ③①①	<b>PFR6W-TG</b>
Fig. ③①	<b>DIFR6D13</b>
	<b>ZFR5LP-13G</b>
14mm $\phi$ $\times$ 21.5mm 16.0 Hex	<b>PZFR6R,8EG</b>
14mm $\phi$ $\times$ 22.0mm 16.0 Hex Fig. ⑩①	<b>PZFR5C PZFR5D-11</b>
Fig. ⑩① ISO	<b>IZFR5C</b> <b>IZFR7E-D</b>
14mm $\phi$ $\times$ 25.0mm conical seat 16.0 Hex Fig. ⑥⑧	<b>PTR5A-13</b> <b>ILTR5D</b>

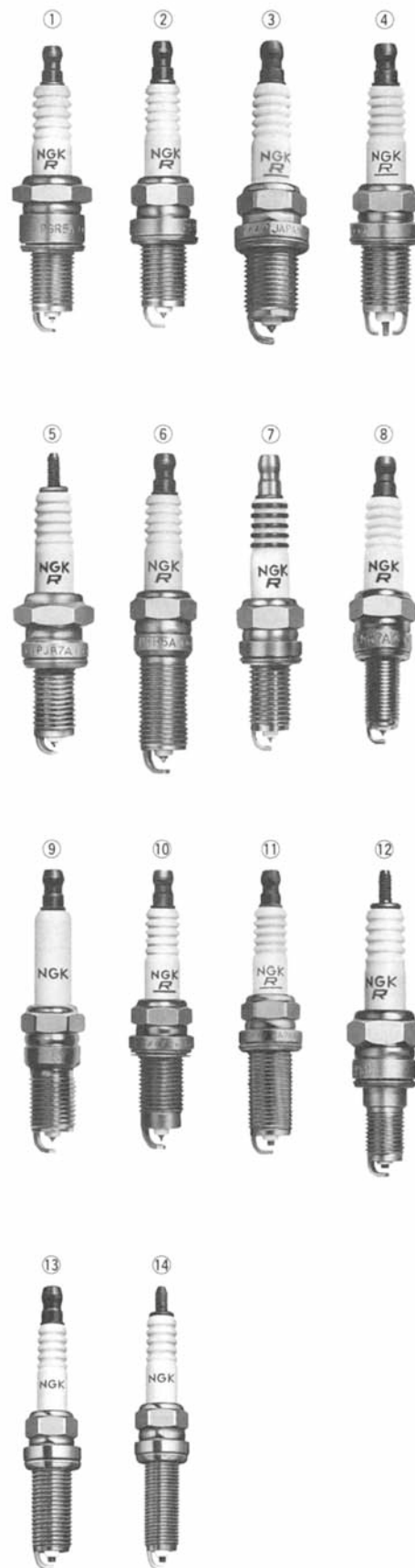

	RESISTOR MIT WIDERSTAND RÉSISTANCE RESISTOR RESISTOR
14mm $\phi$ $\times$ 17.5mm conical seat 16.0 Hex Fig. ⑨①	<b>PTR4B-15 PTR5C-13,-15</b> <b>ITR4A15 ITR5F13</b> <b>ITR6F13</b>
14mm $\phi$ $\times$ 17.5mm conical seat 16.0 Hex Fig. ③⑥	<b>PTR5D-10,-13</b> <b>PTR6D-13,-13G</b>
Fig. ⑨⑨	<b>PZTR5A-15</b>
14mm $\phi$ $\times$ 20.5mm 16.0 Hex Fig. ③⑫	<b>IZFR6K11,11E,13</b> <b>IZFR6K-11S,IZFR6K11NS PZFR7G-G</b>
14mm $\phi$ $\times$ 21.5mm 16.0 Hex Fig. ①①	<b>PZFR5N-11T</b>
14mm $\phi$ $\times$ 22.0mm 16.0 Hex Fig.	<b>PZFR6J-11</b>
14mm $\phi$ $\times$ 26.5mm 16.0 Hex Fig. ①①	<b>PLFR4A-11</b> <b>PLFR5A-9,-11 ILFR5T11 ILFR5B11 DILFR5A11 DILFR5C11 DILFR5E11</b> <b>PLFR6A-9,-11 ILFR6T11 ILFR6K8 ILFR6G,-E SILFR6A11</b> <b>PLFR7A-9</b> <b>PLZFR6A-11S ILZFR6A11 DILFR7B10G</b>
14mm $\phi$ $\times$ 28.0mm 16.0 Hex Fig. ①①	<b>LZFR5BI-11</b> <b>LZFR6AI</b>
14mm $\phi$ $\times$ 29.5mm 16.0 Hex Fig. ①①	<b>LZFR5AQP</b>
14mm $\phi$ $\times$ 25.0mm conical seat 16.0 Hex	<b>PLZTR4A-13</b> <b>PLZTR5A-13 ILTR5A-13G</b> <b>LTR6AP-11 ILTR6A-8G,-13G</b>
12mm $\phi$ $\times$ 19.0mm 18.0 Hex Fig. ⑤⑥	<b>PJR6A</b> <b>PJR7A IJR7A9</b> <b>PJR8A</b>
12mm $\phi$ $\times$ 19.0mm 16.0 Hex Fig. ⑦①	<b>PKR7A</b> <b>PKR9B</b> <b>KR7AI</b> <b>KR8AI</b> <b>KR9CI</b> <b>IKR6G11</b> <b>IKR9F8</b>
12mm $\phi$ $\times$ 19.0mm 16.0 Hex Fig. ⑦③	<b>DCPR8EKP</b>
12mm $\phi$ $\times$ 22.0mm 16.0 Hex	<b>IZKR7A</b>
12mm $\phi$ $\times$ 26.5mm 16.0 Hex	<b>PLKR7A PLKR7B8E</b> <b>ILKR7E6</b> <b>ILKR8E6</b> <b>LKR9CI-8</b>
Fig. ①①	<b>DILKR6A11</b> <b>DILKR7A11 DILKR7B6</b> <b>DILKR8B6</b>
Fig.	<b>SILKR8A-S</b>
12mm $\phi$ $\times$ 28.0mm 16.0 Hex	<b>ILZKR7B11,11GS,-11S SILZKR7A-S</b> <b>SILZKR6B11,10E</b> <b>SILZKR7B11</b>
12mm $\phi$ $\times$ 26.5mm 14.0 Hex Fig. ⑬	<b>ILKAR6C10</b> <b>ILKAR7A7 ILKAR7B11</b> <b>LKAR8AI-9 LKAR8BI9</b> <b>LKAR9BI9</b>
Fig. ⑬①①	<b>DILKAR8A8</b>
Fig. ⑬	<b>PLZKAR6A-11</b> <b>ILZKAR7A10 SILZKAR7B11</b>
12mm $\phi$ $\times$ 28.5mm 14.0 Hex Fig. ①①	<b>DILZKAR6A11</b>
10mm $\phi$ $\times$ 19.0mm 16.0 Hex Fig. ⑧①	<b>ZMR7AP*Reach 20.5mm</b> <b>PMR7A</b> <b>PMR8A</b> <b>PMR8B</b> <b>MR7BI-8</b> <b>MR9AI9</b> <b>CR8EIA-10</b> <b>CR8EIB-9</b> <b>CR9EIA-9</b>
Fig. ⑧	<b>DIMR8A10 DIMR8B10 SIMR8A9</b>
Fig. ⑧③	<b>MR8AP8HJS * Reach 22.0mm</b> <b>CR9EKPA</b>
10mm $\phi$ $\times$ 19.0mm 16.0 Hex Fig. ⑫	<b>IMR9B-9H IMR9C-9H,-9HE,-9HES</b> <b>IMR9D-9H IMR9E-9H</b>
10mm $\phi$ $\times$ 26.5mm 14.0 Hex Fig. ⑭	<b>LMAR8AI-8</b> <b>LMAR9AI-8</b> <b>SILMAR9A-9S</b>
12mm $\phi$ $\times$ 26.5mm Bi-Hex 14.0mm	<b>ILZKBR7A-8G</b> <b>PLZKBR7A-G</b>

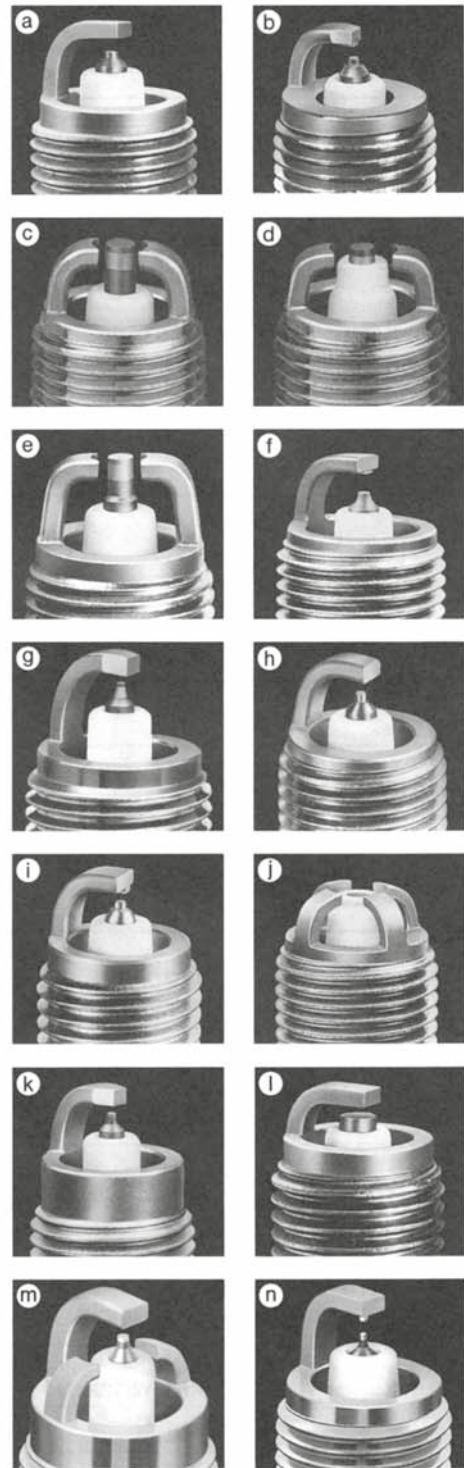

## COMPACT TYPES

KOMPAKT STIFT  
TIPOS COMPACTOS

TYPES CMPACTES  
KOMPACTE TYPEN

	NON-RESISTOR NON-RÉSISTANCE ICKERESISTOR	OHNE WIDERSTAND NO-RESISTOR	RESISTOR RÉSISTANCE RESISTOR	MIT WIDERSTAND RESISTOR
14mm $\phi$ $\times$ 9.5mm 19.0 Hex Fig. ①(a)	<b>BM4A</b> <b>BM6A</b> <b>BM7A</b>	<b>B2-LM *</b> <b>B4-LM *</b> <b>BM6 *</b> <b>BM7 *</b> *Hex.20.8mm	<b>BMR2A,-10</b> <b>BMR4A</b> <b>BMR6A</b> <b>BMR7A</b>	<b>BR2-LM *</b> <b>BR4-LM *</b>  *Hex.20.8mm
Fig. ①(b)	<b>BPM4A,-10</b> <b>BPM6A,-10</b> <b>BPM7A</b>		<b>BPMR4A,-10</b> <b>BPMR6A,-10</b> <b>BPMR7A,-9</b>	
14mm $\phi$ $\times$ 12.7mm 20.8 Hex Fig. ②(a)	<b>BL-6H</b>			
14mm $\phi$ $\times$ 7.8mm Conical seat 16.0 Hex Fig. ③(a)	<b>BM6F</b> <b>BM7F</b>	<b>BM6FY</b>	<b>BMR6F</b>	
Fig. ③(b)	<b>BPM6F</b> <b>BPM7F</b>		<b>BPMR6F</b>	
10mm $\phi$ $\times$ 8.6mm 14.0 Hex Fig. ④(a)	<b>CM-6</b>			
10mm $\phi$ $\times$ 9.5mm 16.0 Hex Fig. ⑧(a)			<b>CMR6A</b> <b>CMR7A</b>	
10mm $\phi$ $\times$ 12.7mm 16.0 Hex Fig. ⑧(c)			<b>CMR5H</b> <b>CMR6H</b> <b>CMR7H</b>	
14mm $\phi$ $\times$ 9.5mm 19.0 Hex Fig. ①(c)	<b>BPM6Y</b> <b>BPM7Y</b> <b>BPM8Y</b>		<b>BPMR6Y</b> <b>BPMR7Y</b> <b>BPMR8Y</b>	



## FARM EQUIPMENT TYPES

LANDMASCHINEN TYPEN  
TIPOS MÁQUINAS AGRÍCOLAS

TYPES MACHINES AGRICOLES  
FÖR JORDBRUKS-MASKINER

PF1/2" $\times$ 22.5mm 23.8 Hex Fig. ⑤(d)	<b>G-27</b> <b>G-2Z</b>
---	----------------------------

## SURFACE DISCHARGE TYPES

GLEITFUNKENTYPEN  
TIPO DESCARGA EN SUPERFICIE

TYPE À DÉCHARGE SUPERFICIELLE  
TÄNDSTIFT MED YTGNI-STGAP

14mm $\phi$ $\times$ 12.7mm 20.8 Hex Fig. ⑥(f)	<b>BUHX(Series gap)</b> <b>BUHXW-1(Series gap)</b>	
	<b>BUH</b>	
	<b>BUHW</b> <b>BUHW-2</b>	<b>BUZH</b> <b>BUZH-2</b>
14mm $\phi$ $\times$ 19.0mm 20.8 Hex Fig. ⑦(f)	<b>BUE</b>	

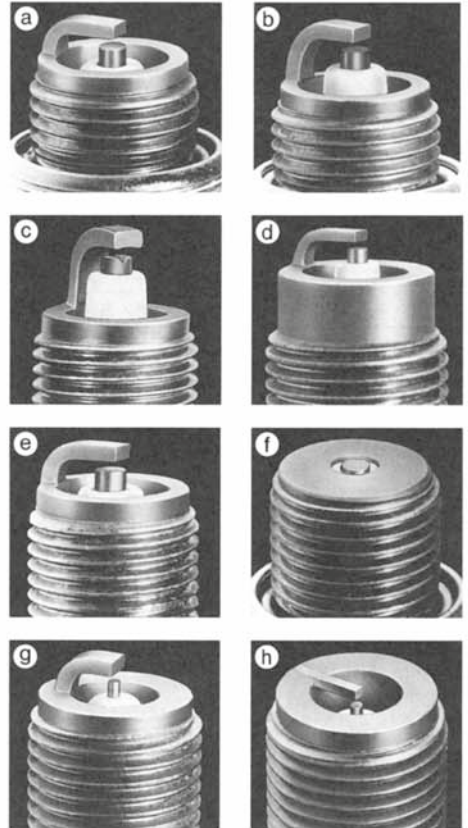

## RACING TYPES

RENN-TYPEN  
TIPOS DE CARRERAS

TYPES COURS  
RACERSTIFT

	Nickel electrode Nickel Elektrode Electrodo de nickel Electrodo de niquel Nickel elektrod	Precious metal electrode Elektrode mit sonde-redel metall Electrode en metal precieux Electrodo de metal precioso Ädelmetall elektrod	Platinum electrode Platinel Ektrode Electrode de platine Electrodo de platino Platina elektrod
14mm $\phi$ $\times$ 19.0mm 20.8 Hex	<b>B8EG</b> Fig. ⑨(g) <b>BR8EG*</b>  <b>B9EG</b> <b>BR9EG*</b>  <b>B10EG</b> <b>BR10EG*</b>  <b>B11EG</b>	Fig. ⑨(g) <b>B8EGV</b> <b>B85EGV</b> <b>B9EGV</b> <b>B95EGV</b> <b>B10EGV</b> <b>B105EGV</b> <b>B11EGV</b>	Fig. ⑨(h) <b>B8EGP</b> <b>B85EGP</b> <b>B9EGP</b> <b>B95EGP</b> <b>B10EGP</b>
*Resistor Type			



# IX TYPES

IX TYPEN TYPES IX  
TIPOS IX IX-STIFT

	RESISTOR RÉSISTANCE RESISTOR	MIT WIDERSTAND RESISTOR
18mm $\phi$ $\times$ 10.9mm 20.8 Hex Fig. ①a	<b>WR5IX</b>	
14mm $\phi$ $\times$ 19.0mm 20.8 Hex Fig. ②b		<b>GR4IX</b> <b>GR5IX</b>
		<b>BPR5EIX</b> , -11 <b>BPR6EIX</b> , -11 <b>BPR7EIX</b> <b>BPR8EIX</b> <b>BPR9EIX</b>
	Fig. ②c	<b>BR7EIX</b> <b>BR8EIX</b> <b>BR9EIX</b> <b>BR10EIX</b>
	Fig. ②d	<b>BR8ECSIX</b> <b>BR9ECSIX</b> , -5
Fig. ③d	<b>BR8ECMIX</b> <b>BR9ECMIX</b> <b>BR10ECMIX</b>	
14mm $\phi$ $\times$ 12.7mm 20.8 Hex Fig. ④b		<b>BPR6HIX</b> <b>BPR7HIX</b> <b>BPR8HIX</b>
	Fig. ④c	<b>BR6HIX</b> <b>BR7HIX</b> <b>BR8HIX</b> <b>BR9HIX</b> <b>BR10HIX</b>
14mm $\phi$ $\times$ 9.5mm 20.8 Hex Fig. ⑤a	<b>XR4IX</b> <b>XR5IX</b> <b>XR45IX</b>	
14mm $\phi$ $\times$ 19.0mm 16.0 Hex Fig. ⑥b		<b>BCPR7EDIX</b>
	Fig. ⑦b	<b>BCPR5EIX</b> , -11 <b>BCPR6EIX</b> , -11 <b>BCPR7EIX</b> , -11
	Fig. ⑧b	<b>BKR4EIX</b> <b>BKR5EIX</b> , -11 <b>BKR6EIX</b> , -11 <b>BKR7EIX</b> , -11 <b>BKR8EIX</b> <b>BKR9EIX</b>
Fig. ⑧e	<b>ZFR5FIX</b> -11 <b>ZFR6FIX</b> -11	
14mm $\phi$ $\times$ 26.5mm 16.0 Hex Fig. ⑨b	<b>LFR5AIX</b> -11 <b>LFR6AIX</b> -11 <b>LFR7AIX</b>	
14mm $\phi$ $\times$ 17.5mm Conical seat 16.0 Hex Fig. ⑩b		<b>BPR6EFIX</b> -10, -15
	Fig. ⑩a	<b>TR4IX</b> <b>TR5IX</b> <b>TR6IX</b> <b>TR7IX</b> <b>TR8IX</b>
14mm $\phi$ $\times$ 20.5mm Conical seat 16.0 Hex Fig. ⑪e	<b>TR5</b> -11X	<b>TR45</b> -11X <b>TR55</b> -11X
14mm $\phi$ $\times$ 11.2mm Conical seat 16.0 Hex Fig. ⑫c		<b>YR5IX</b> <b>YR55IX</b>
	Fig. ⑫a	<b>BR6FIX</b>
14mm $\phi$ $\times$ 25.0mm Conical seat 16.0Hex Fig. ⑬b		<b>LTR5IX</b> -11 <b>LTR6IX</b> -11 <b>LTR7IX</b> -11
	Fig. ⑬e	<b>LZTR4AIX</b> -11 <b>LZTR5AIX</b> -13 <b>LZTR6AIX</b> -13 <b>LZTR7AIX</b> -13

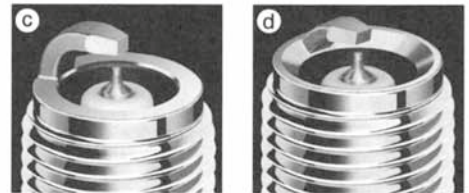
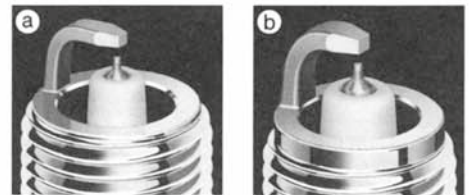
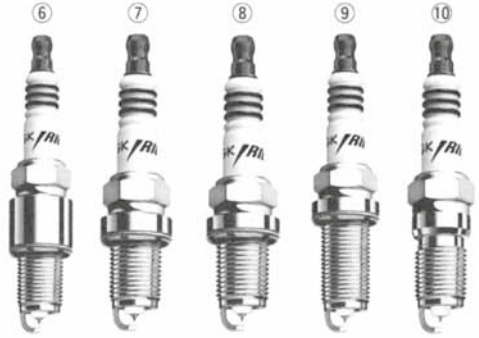



# IX TYPES

IX TYPEN TYPES IX  
TIPOS IX IX-STIFT

	RESISTOR RÉSISTANCE RESISTOR	MIT WIDERSTAND RESISTOR
12mm $\phi$ $\times$ 19.0mm 16.0 Hex Fig. ①(a)	<b>DCPR6EIX</b> <b>DCPR7EIX</b> <b>DCPR8EIX</b> <b>DCPR9EIX</b>	
Fig. ①(b)	<b>DCR7EIX</b> <b>DCR8EIX</b> <b>DCR9EIX</b>	
12mm $\phi$ $\times$ 19.0mm 18.0 Hex Fig. ②(a)	<b>DPR7EIX-9</b> <b>DPR8EIX-9</b> <b>DPR9EIX-9</b>	
Fig. ②(b)	<b>DR7EIX</b> <b>DR8EIX</b> <b>DR9EIX</b>	
12mm $\phi$ $\times$ 21.0mm 18.0 Hex Fig. ③(a)	<b>DPR8ZIX</b>	
12mm $\phi$ $\times$ 26.5mm Conical seat 14.0 Hex Fig. ④(d)	<b>ZNAR7AIX</b> <b>ZNAR6AIX-11</b>	
10mm $\phi$ $\times$ 19.0mm 16.0 Hex Fig. ⑤(a)	<b>CPR7EAIX-9</b>	
Fig. ⑤(c)	<b>CR7EIX</b> <b>CR8EIX</b> <b>CR9EIX</b> <b>CR10EIX</b>	
Fig. ⑥(b)	<b>CR8EHIX-9</b> <b>CR9EHIX-9</b>	
10mm $\phi$ $\times$ 12.7mm 16.0 Hex Fig. ⑦(b)	<b>CR5HIX</b> <b>CR6HIX</b> <b>CR7HIX</b> <b>CR8HIX</b> <b>CR9HIX</b>	
8mm $\phi$ $\times$ 19.0mm 13.0 Hex Fig. ⑧(e)	<b>ER8EHIX</b> <b>ER9EHIX</b>	

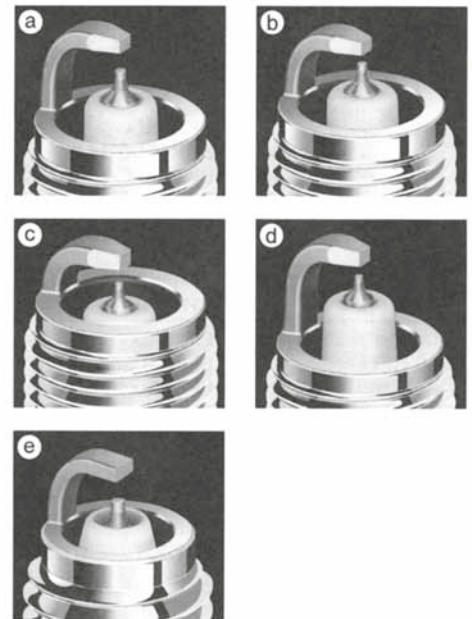
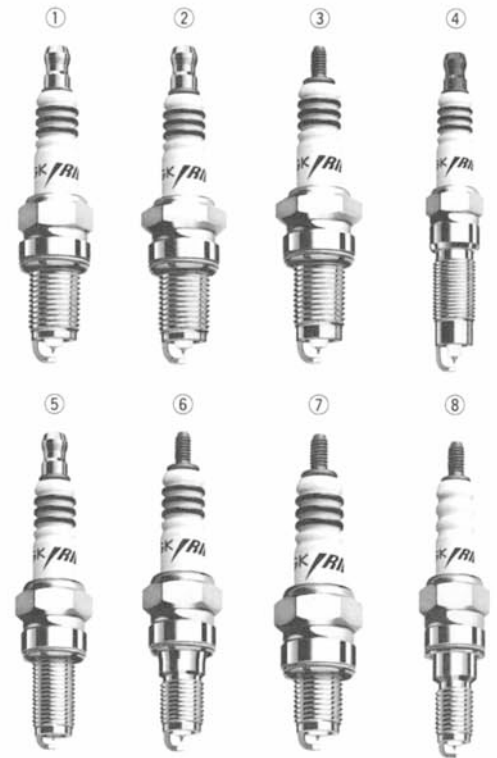

# SERIES OF NGK GLOW PLUGS

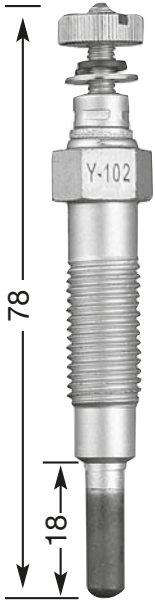

**Y-102**  
M 10 x 1.25  
12 Hex  
10,5 V

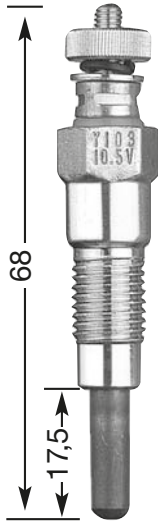

**Y-103**  
M 10 x 1.25  
12 Hex  
10,5 V

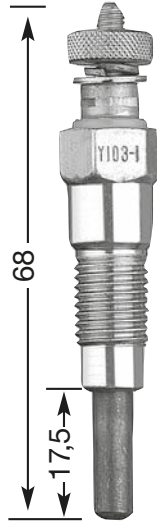

**Y-103-1**  
M 10 x 1.25  
12 Hex

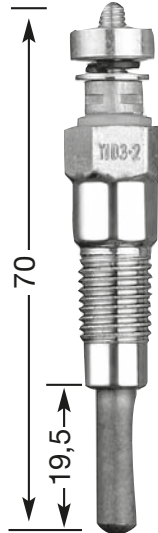

**Y-103-2**  
M 10 x 1.25  
12 Hex

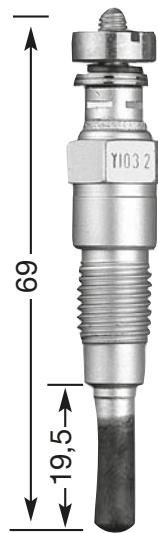

**Y-103-2A**  
M 10 x 1.25  
12 Hex



**Y-103 K**  
M 10 x 1.25  
12 Hex  
10,5 V

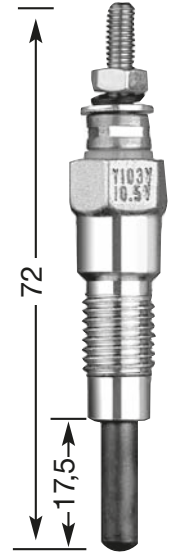

**Y-103 V**  
M 10 x 1.25  
12 Hex  
10,5 V

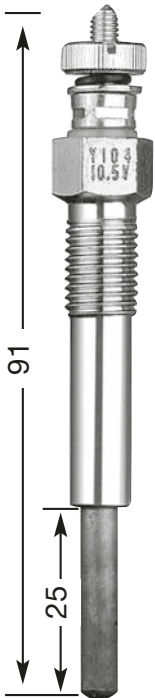

**Y-104**  
M 10 x 1.25  
12 Hex  
10,5 V



**Y-106-1**  
M 10 x 1.25  
12 Hex  
10,5 V

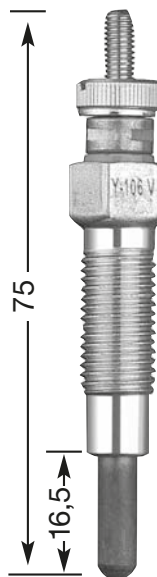

**Y-106 V**  
M 10 x 1.25  
12 Hex  
10,5 V

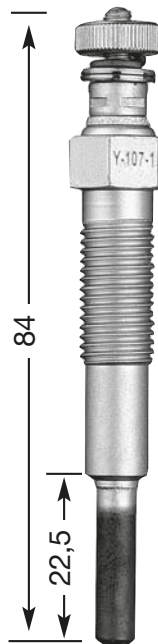

**Y-107-1**  
M 10 x 1.25  
12 Hex  
10,5 V

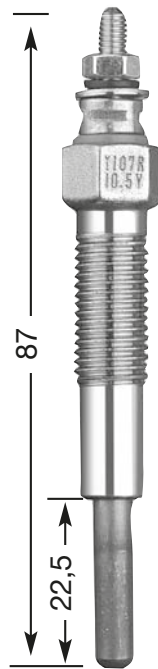

**Y-107 R**  
M 10 x 1.25  
12 Hex  
10,5 V

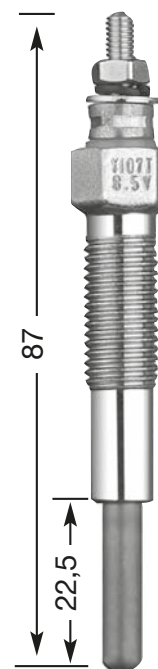

**Y-107 T**  
M 10 x 1.25  
12 Hex  
8,5 V

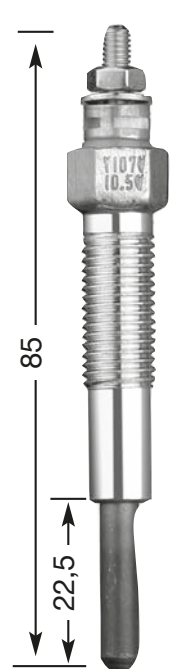

**Y-107 V**  
M 10 x 1.25  
12 Hex  
10,5 V

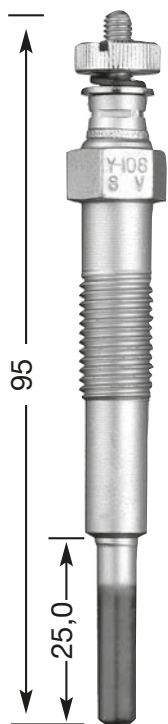

**Y-108**  
M 10 x 1.25  
12 Hex  
8 V

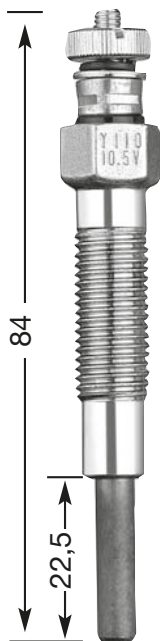

**Y-110**  
M 10 x 1.25  
12 Hex  
10,5 V

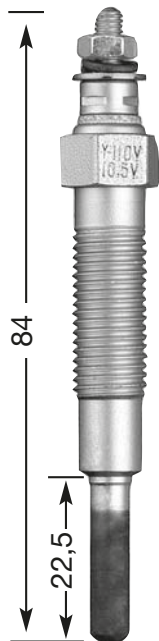

**Y-110 V**  
M 10 x 1.25  
12 Hex  
10,5 V

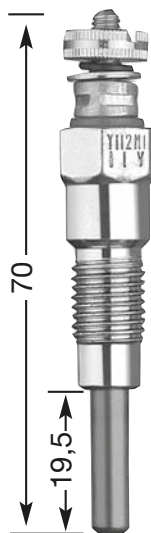

**Y-112 M1**  
M 10 x 1.25  
12 Hex  
11 V

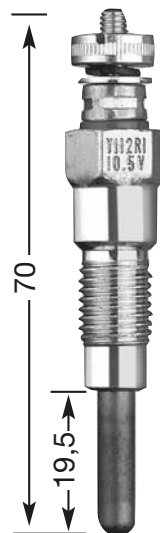

**Y-112 R1**  
M 10 x 1.25  
12 Hex  
10,5 V

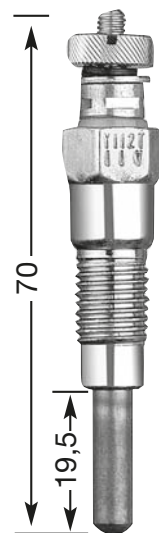

**Y-112 T**  
M 10 x 1.25  
12 Hex  
11 V

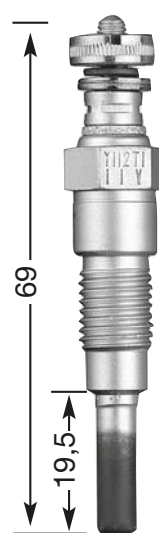

**Y-112 T1**  
M 10 x 1.25  
12 Hex  
11 V

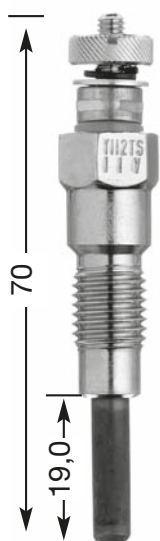

**Y-112 TS**  
M 10 x 1.25  
12 Hex  
11 V

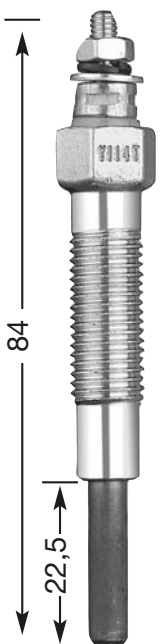

**Y-114 T**  
M 10 x 1.25  
12 Hex  
10,5 V

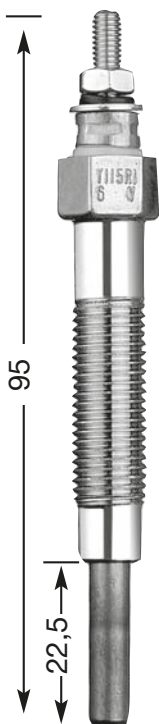

**Y-115 R1**  
M 10 x 1.25  
12 Hex  
6 V

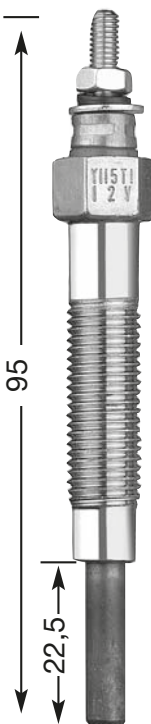

**Y-115 T1**  
M 10 x 1.25  
12 Hex  
12 V

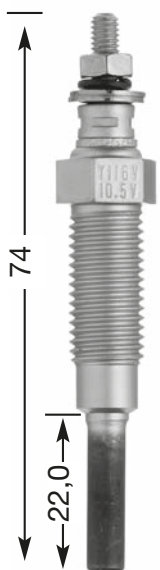

**Y-116 V**  
M 10 x 1.25  
12 Hex  
10,5 V

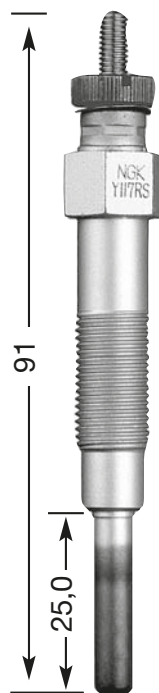

**Y-117 RS**  
M 10 x 1  
12 Hex  
6,5 V

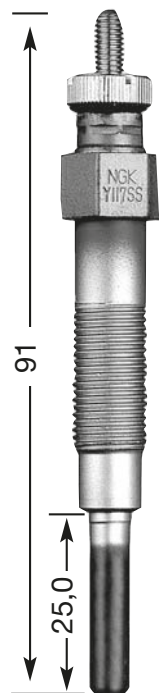

**Y-117 SS**  
M 10 x 1  
12 Hex  
8,5 V

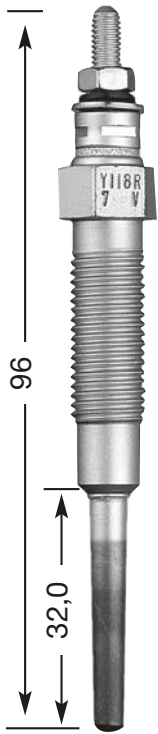

**Y-118 R**  
M 10 x 1.25  
12 Hex  
7 V

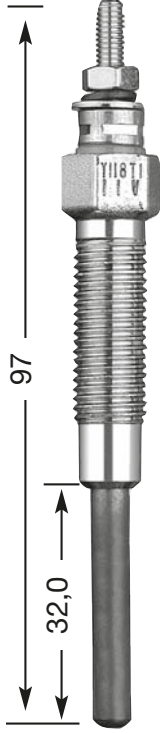

**Y-118 T1**  
M 10 x 1.25  
12 Hex  
11 V

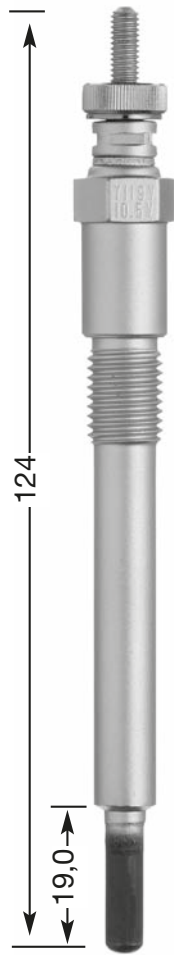

**Y-119 V**  
M 10 x 1.25  
12 Hex  
10,5 V

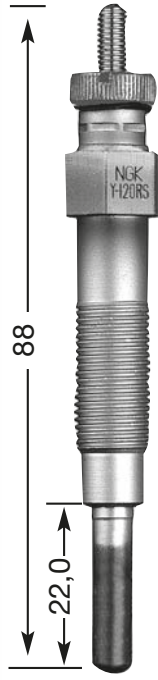

**Y-120 RS**  
M 10 x 1.0  
12 Hex  
6,5 V

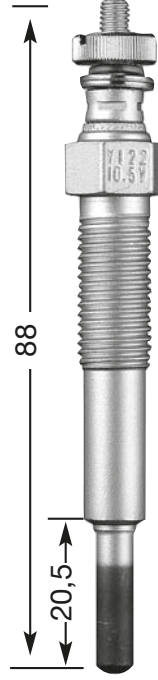

**Y-122**  
M 10 x 1.25  
12 Hex  
10,5 V

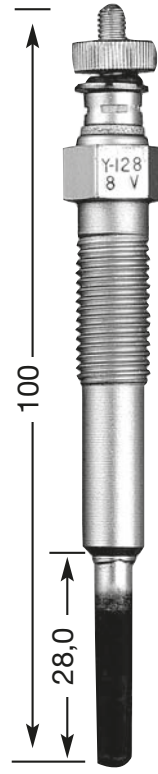

**Y-128**  
M 10 x 1.25  
12 Hex  
8 V

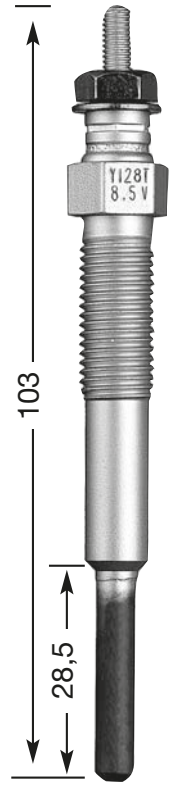

**Y-128 T**  
M 10 x 1.25  
12 Hex  
8,5 V

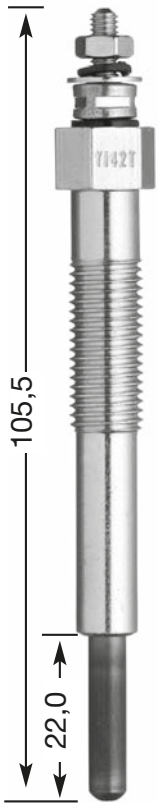

**Y-142 T**  
M 10 x 1.25  
12 Hex

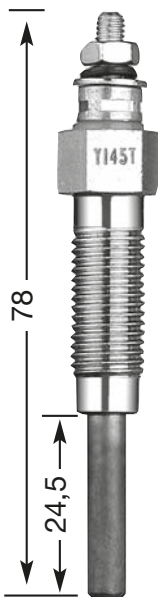

**Y-145 T**  
M 10 x 1.25  
12 Hex  
10,5 V

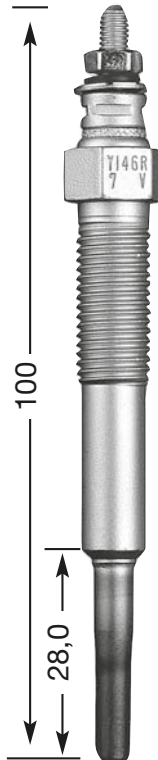

**Y-146 R**  
M 10 x 1.25  
12 Hex  
7 V

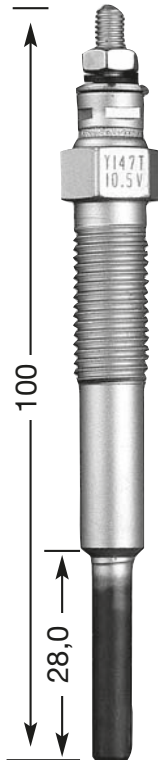

**Y-147 T**  
M 10 x 1.25  
12 Hex  
10,5 V

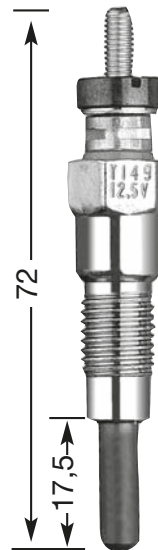

**Y-149**  
M 10 x 1.25  
12 Hex  
12,5 V

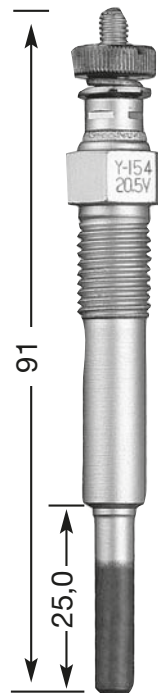

**Y-154**  
M 10 x 1.25  
12 Hex  
20,5 V

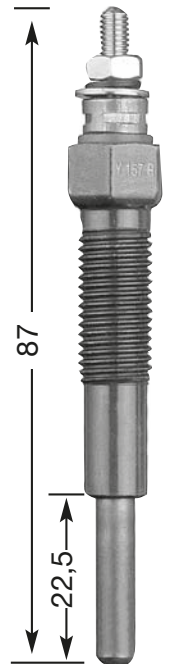

**Y-157 R**  
M 10 x 1.25  
12 Hex  
23 V



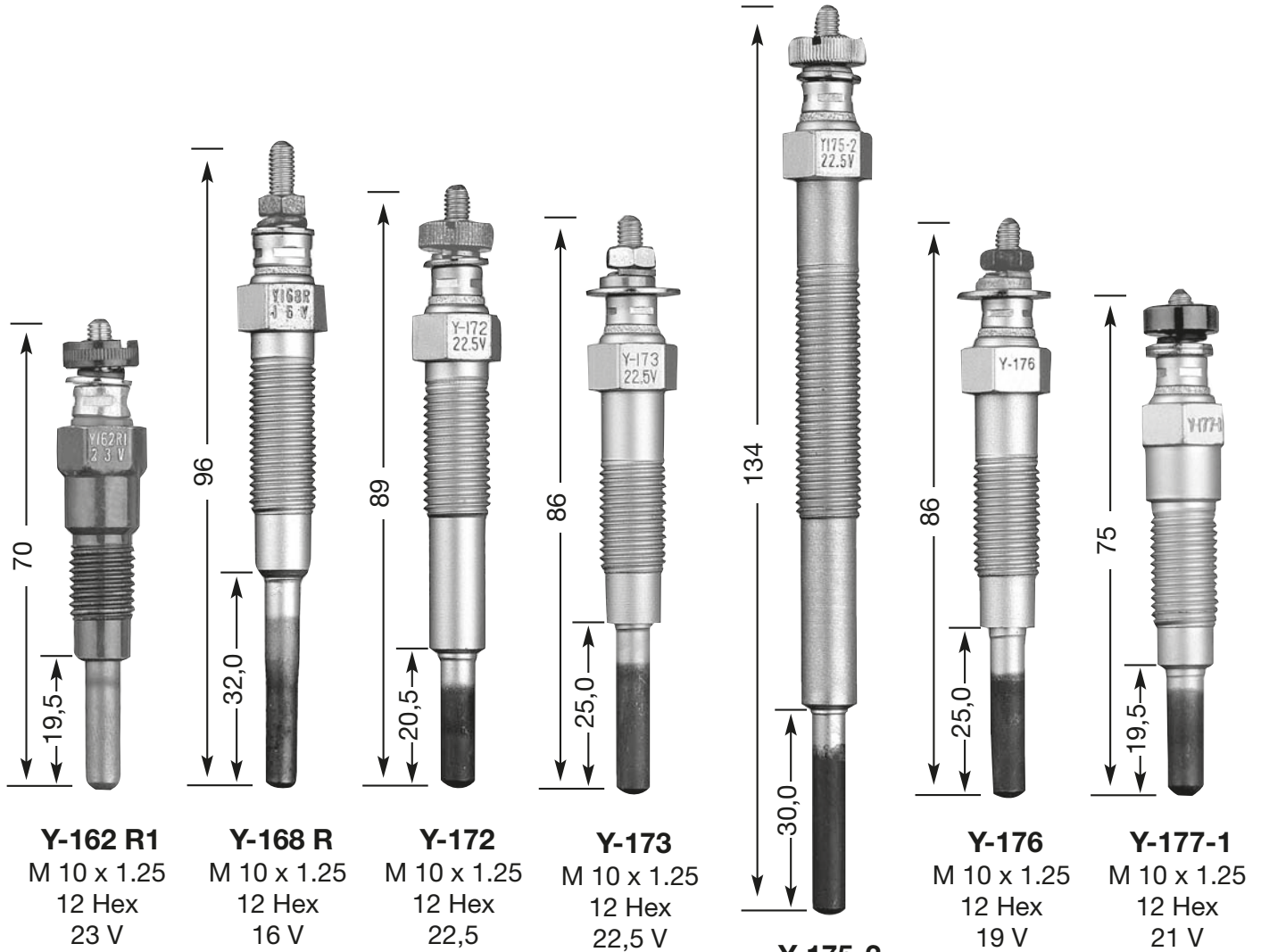

**Y-162 R1**  
M 10 x 1.25  
12 Hex  
23 V

**Y-168 R**  
M 10 x 1.25  
12 Hex  
16 V

**Y-172**  
M 10 x 1.25  
12 Hex  
22,5

**Y-173**  
M 10 x 1.25  
12 Hex  
22,5 V

**Y-175-2**  
M 10 x 1.25  
12 Hex  
22,5 V

**Y-176**  
M 10 x 1.25  
12 Hex  
19 V

**Y-177-1**  
M 10 x 1.25  
12 Hex  
21 V

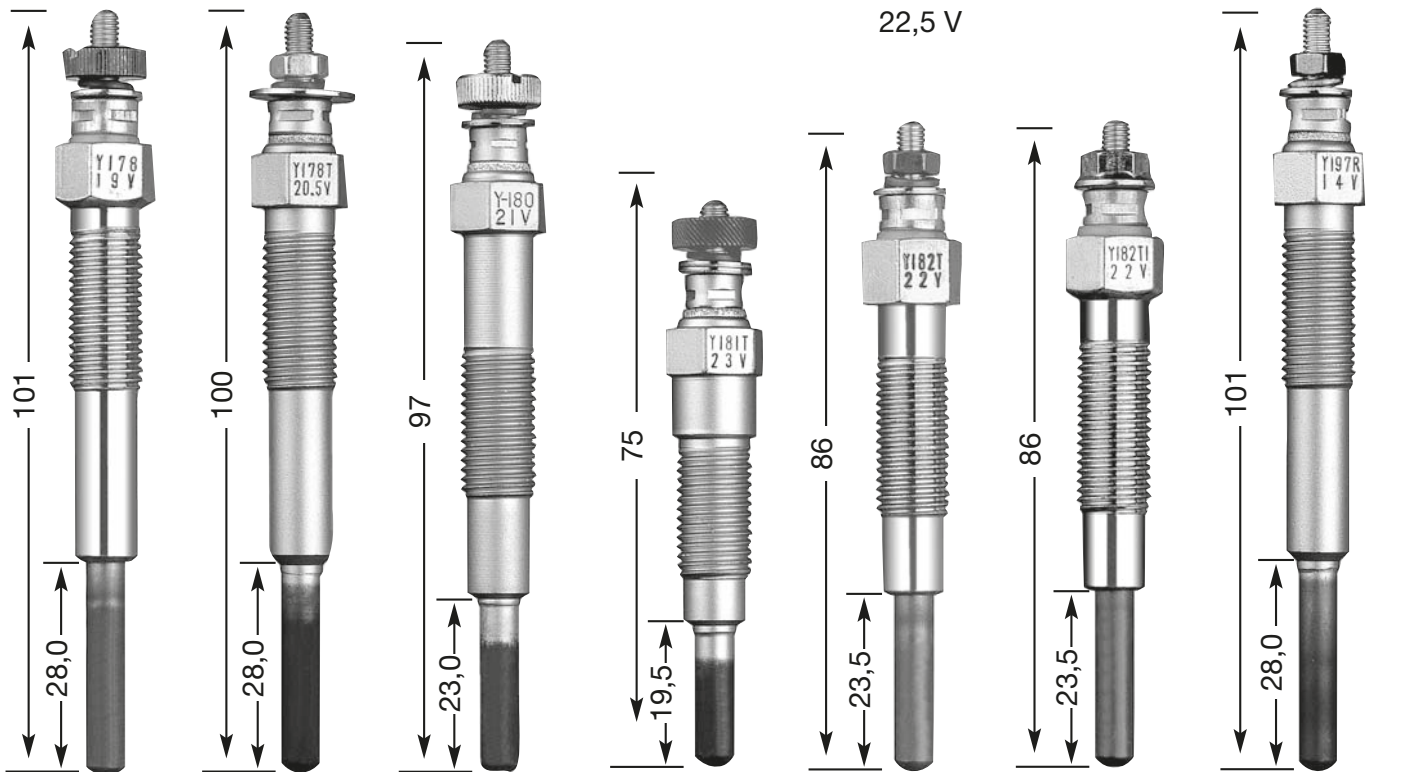

**Y-178**  
M 10 x 1.25  
12 Hex  
19 V

**Y-178 T**  
M 10 x 1.25  
12 Hex  
20,5 V

**Y-180**  
M 10 x 1.25  
12 Hex  
21 V

**Y-181 T**  
M 10 x 1.25  
12 Hex  
23 V

**Y-182 T**  
M 10 x 1.25  
12 Hex  
22 V

**Y-182 T1**  
M 10 x 1.25  
12 Hex  
22 V

**Y-197 R**  
M 10 x 1.25  
12 Hex  
14 V

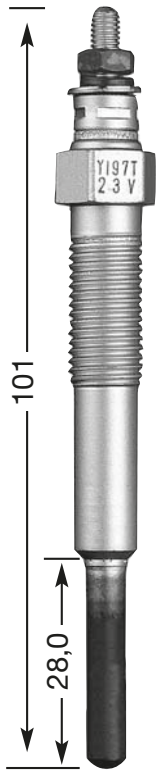

**Y-197 T**  
M 10 x 1.25  
12 Hex  
23 V

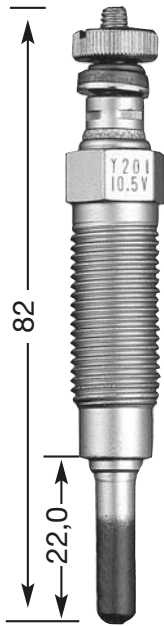

**Y-201**  
M 12 x 1.25  
12 Hex  
10,5 V

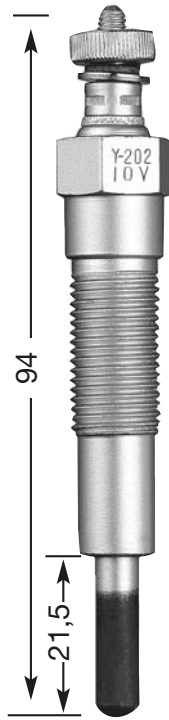

**Y-202**  
M 12 x 1.25  
14 Hex  
10 V

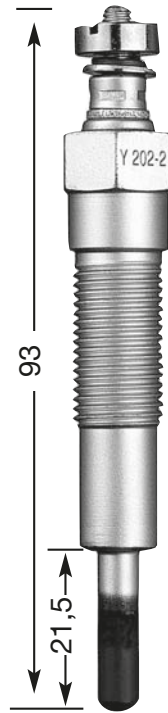

**Y-202-2**  
M 12 x 1.25  
14 Hex

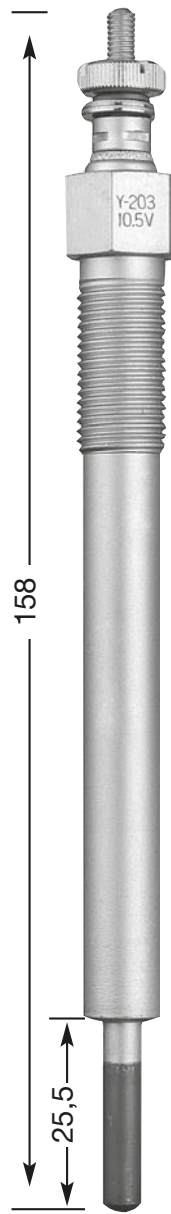

**Y-203**  
M 12 x 1.25  
14 Hex  
10,5 V

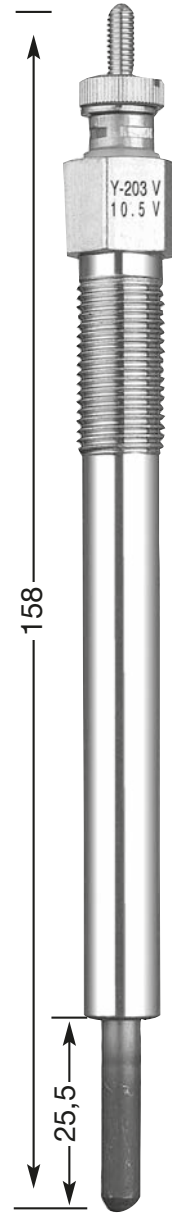

**Y-203 V**  
M 12 x 1.25  
14 Hex  
10,5 V

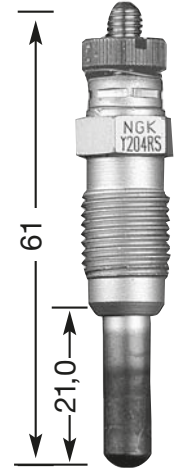

**Y-204 RS**  
M 12 x 1.25  
12 Hex  
6,5 V

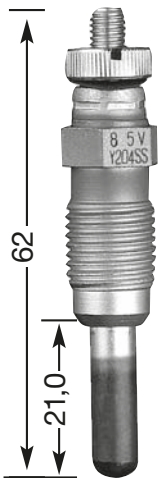

**Y-204 SS**  
M 12 x 1.25  
12 Hex  
8,5 V

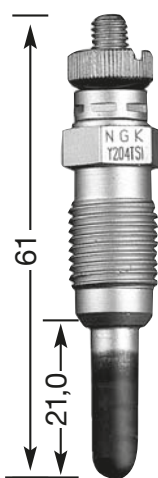

**Y-204 TS1**  
M 12 x 1.25  
12 Hex  
11 V

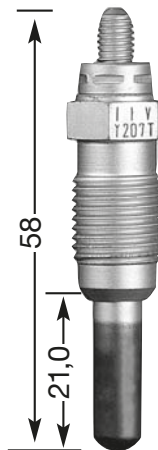

**Y-207 T**  
M 12 x 1.25  
12 Hex  
11 V

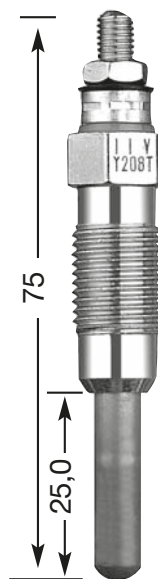

**Y-208 T**  
M 12 x 1.25  
12 Hex  
11 V

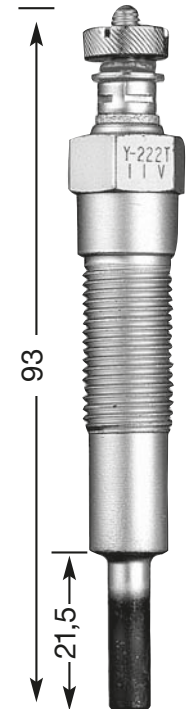

**Y-222 T**  
M 12 x 1.25  
14 Hex  
11 V

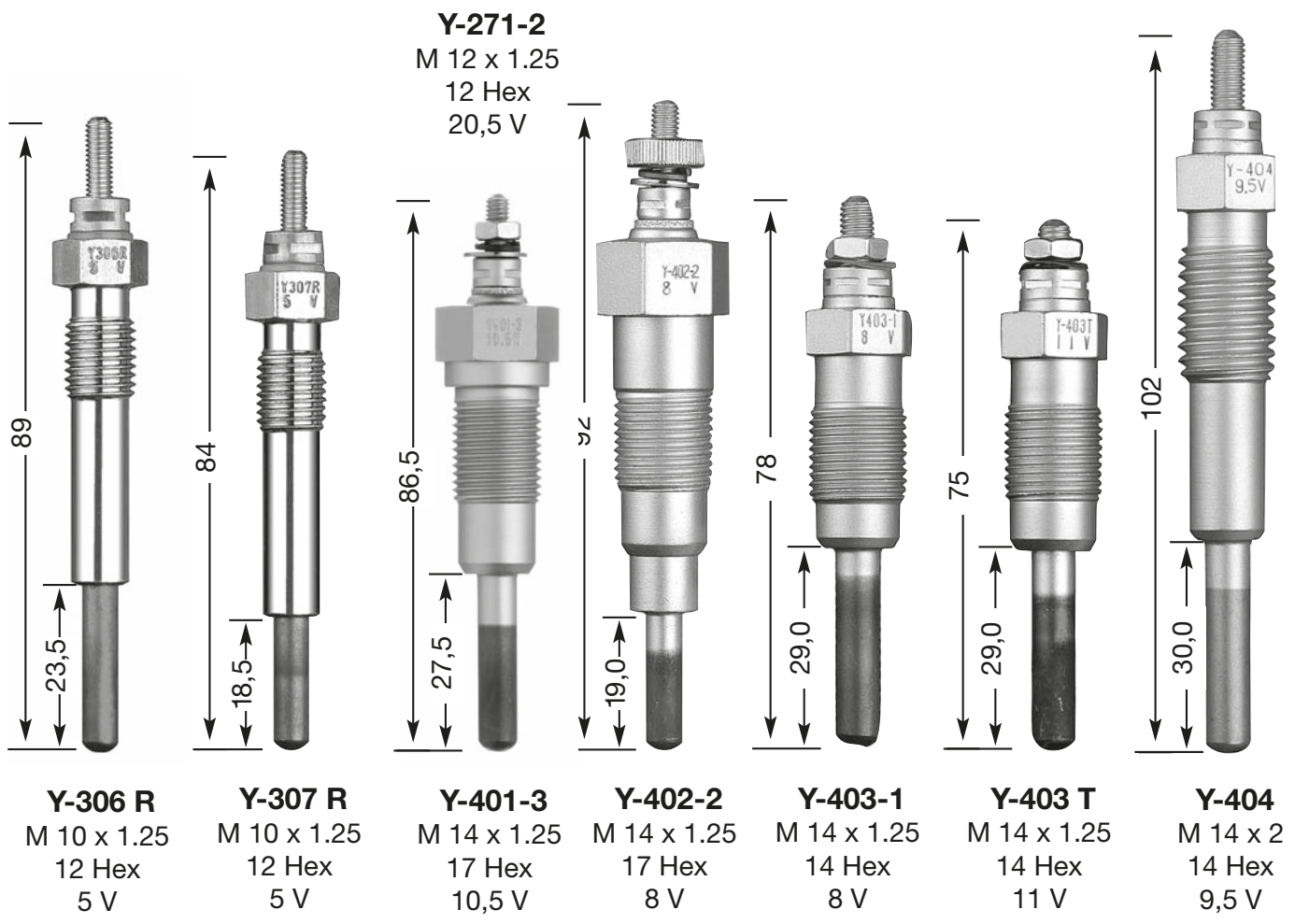
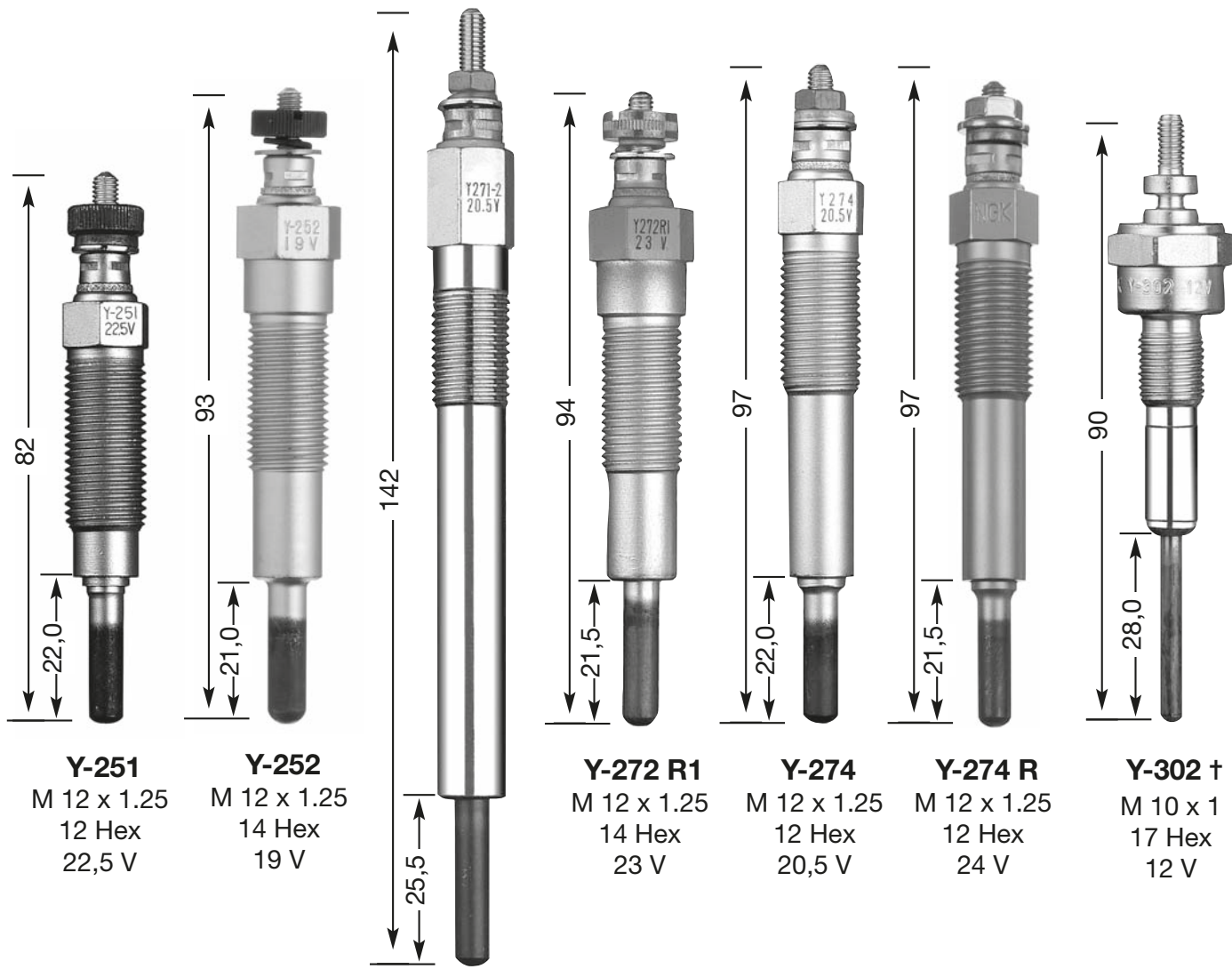



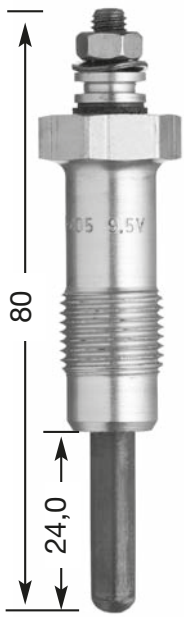

**Y-405**  
M 14 x 1.25  
17 Hex  
9,5 V

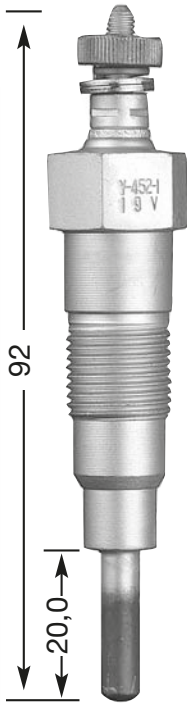

**Y-452-1**  
M 14 x 1.25  
17 Hex  
19 V

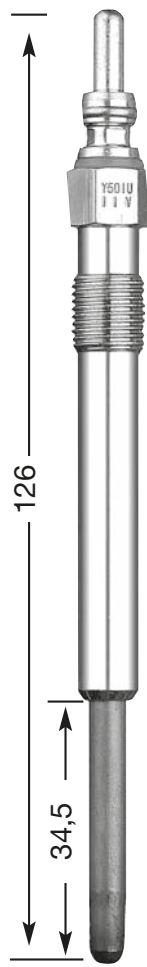

**Y-501-U**  
M 10 x 1.0  
10 Hex  
11 V  
**DP 31**

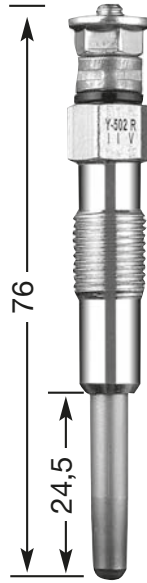

**Y-502 R**  
M 10 x 1.0  
10 Hex  
11 V

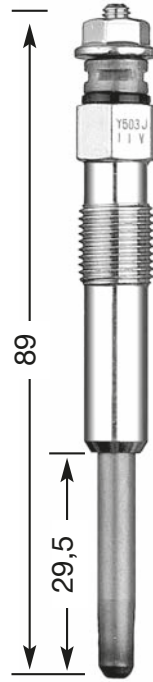

**Y-503 J**  
M 10 x 1.0  
10 Hex  
11 V  
**DP 10**

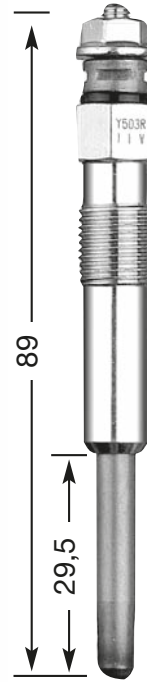

**Y-503 R**  
M 10 x 1.0  
10 Hex

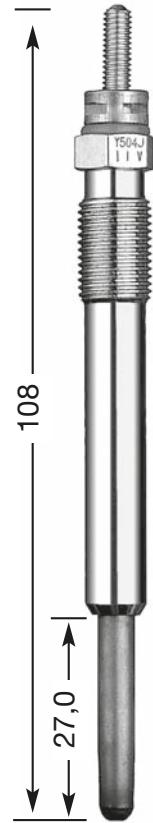

**Y-504 J**  
M 10 x 1.0  
10 Hex  
11 V  
**DP 24**

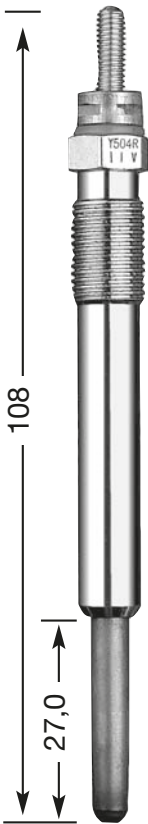

**Y-504 R**  
M 10 x 1.0  
10 Hex  
11 V

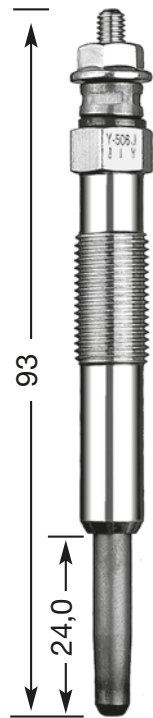

**Y-506 J**  
M 10 x 1.0  
10 Hex  
11 V  
**DP 7**

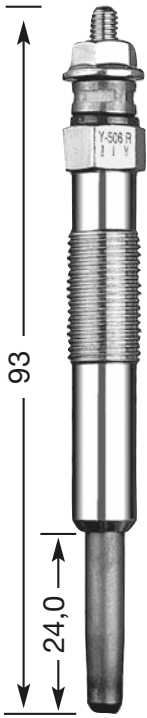

**Y-506 R**  
M 10 x 1.0  
10 Hex  
11 V

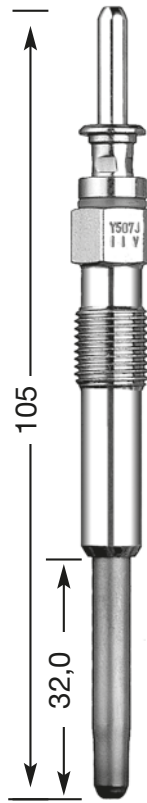

**Y-507 J**  
M 10 x 1.0  
10 Hex  
11 V  
**DP 32**

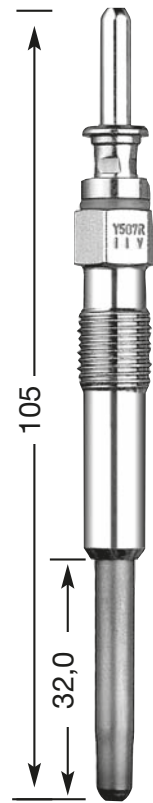

**Y-507 R**  
M 10 x 1.0  
10 Hex  
11 V

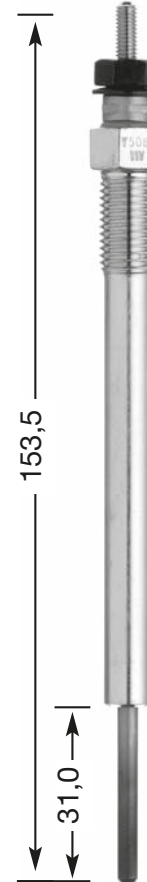

**Y-508 J**  
M 10 x 1.25  
12 Hex  
11 V



**Y-515 J**  
M 10 x 1.0  
10 Hex  
11 V  
**DP 18**





**Y-516 J**  
 M 10 x 1.0  
 10 Hex  
 11 V  
 DP 12



**Y-517 J**  
 M 10 x 1.0  
 10 Hex  
 11 V  
 DP 66

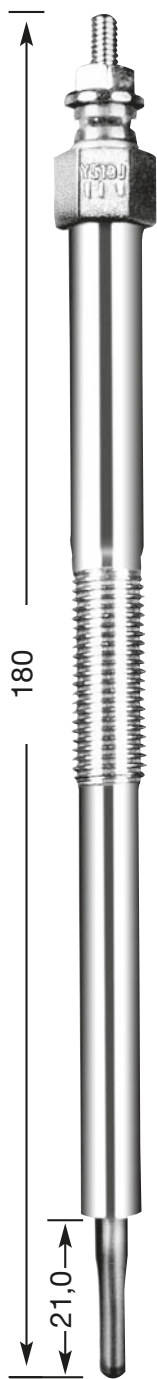

**Y-519 J**  
 M 10 x 1.25  
 10 Hex  
 11 V  
 DP 61

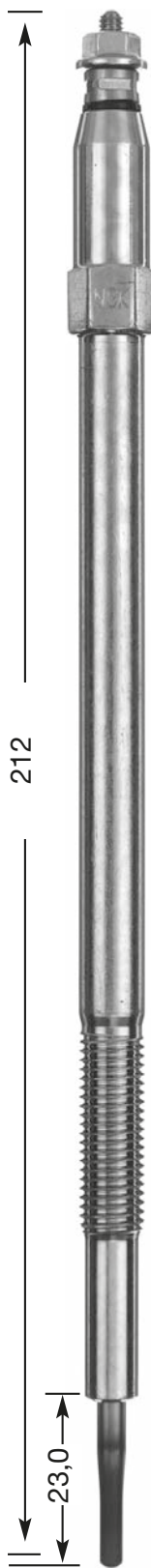

**Y-522 J**  
 M 10 x 1.25  
 12 Hex  
 11 V

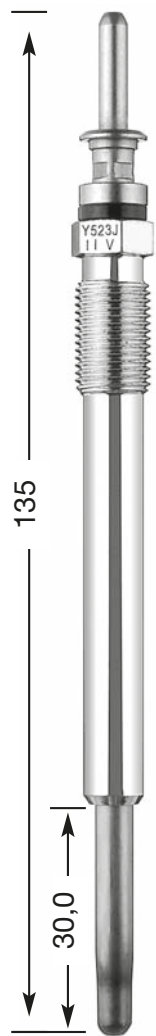

**Y-523 J**  
 M 10 x 1.0  
 10 Hex  
 11 V  
 DP 37



**Y-524 J**  
 M 10 x 1.0  
 10 Hex  
 10 V  
 DP 27

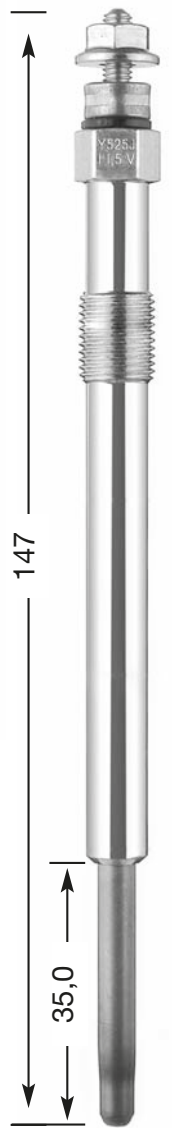

**Y-525 J**  
 M 10 x 1.0  
 10 Hex  
 11,5 V  
 DP 35

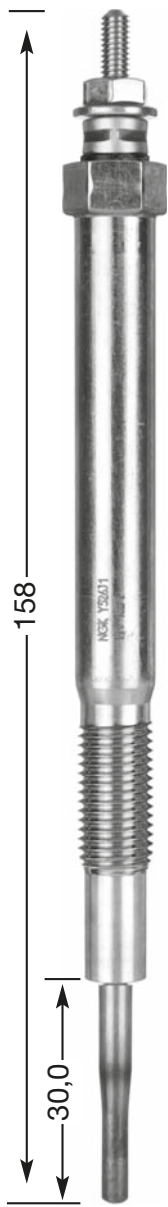

**Y-526 J1**  
M 10 x 1.25  
12 Hex  
11 V  
**DP 69**

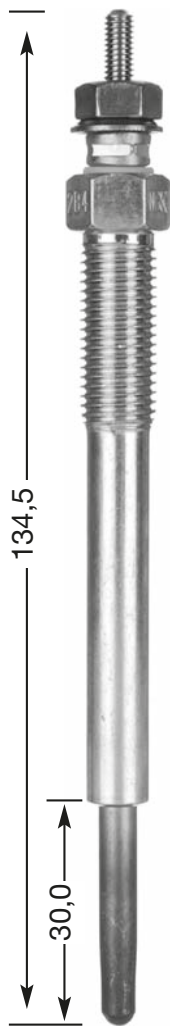

**Y-527 J**  
M 10 x 1.25  
12 Hex  
11 V  
**DP 67**

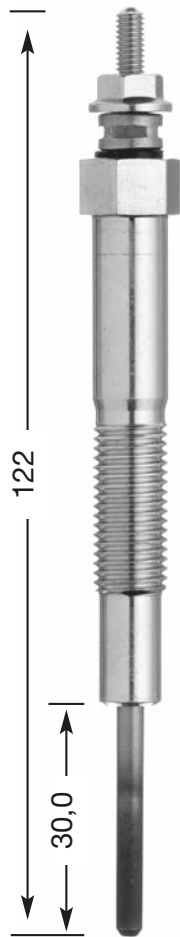

**Y-529 J**  
M 10 x 1.25  
12 Hex  
11 V

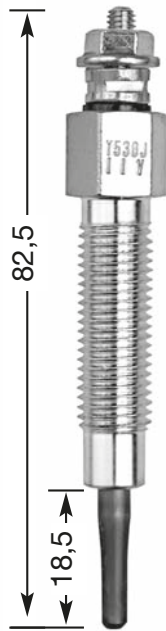

**Y-530 J**  
M 10 x 1.25  
12 Hex  
11 V

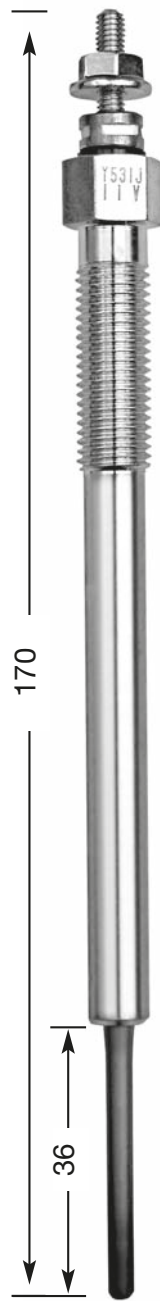

**Y-531 J**  
M 10 x 1.25  
12 Hex  
11 V  
**DP 44**

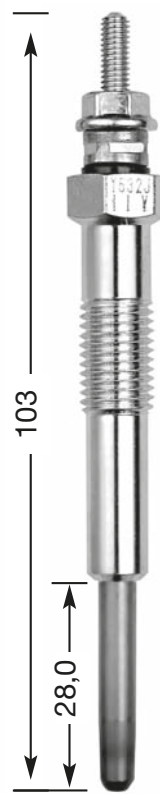

**Y-532 J**  
M 10 x 1.25  
12 Hex  
11 V

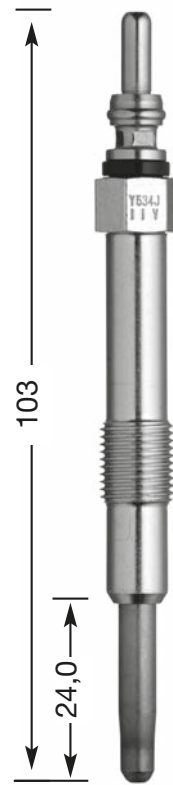

**Y-534 J**  
M 10 x 1.0  
10 Hex  
11 V  
**DP 36**

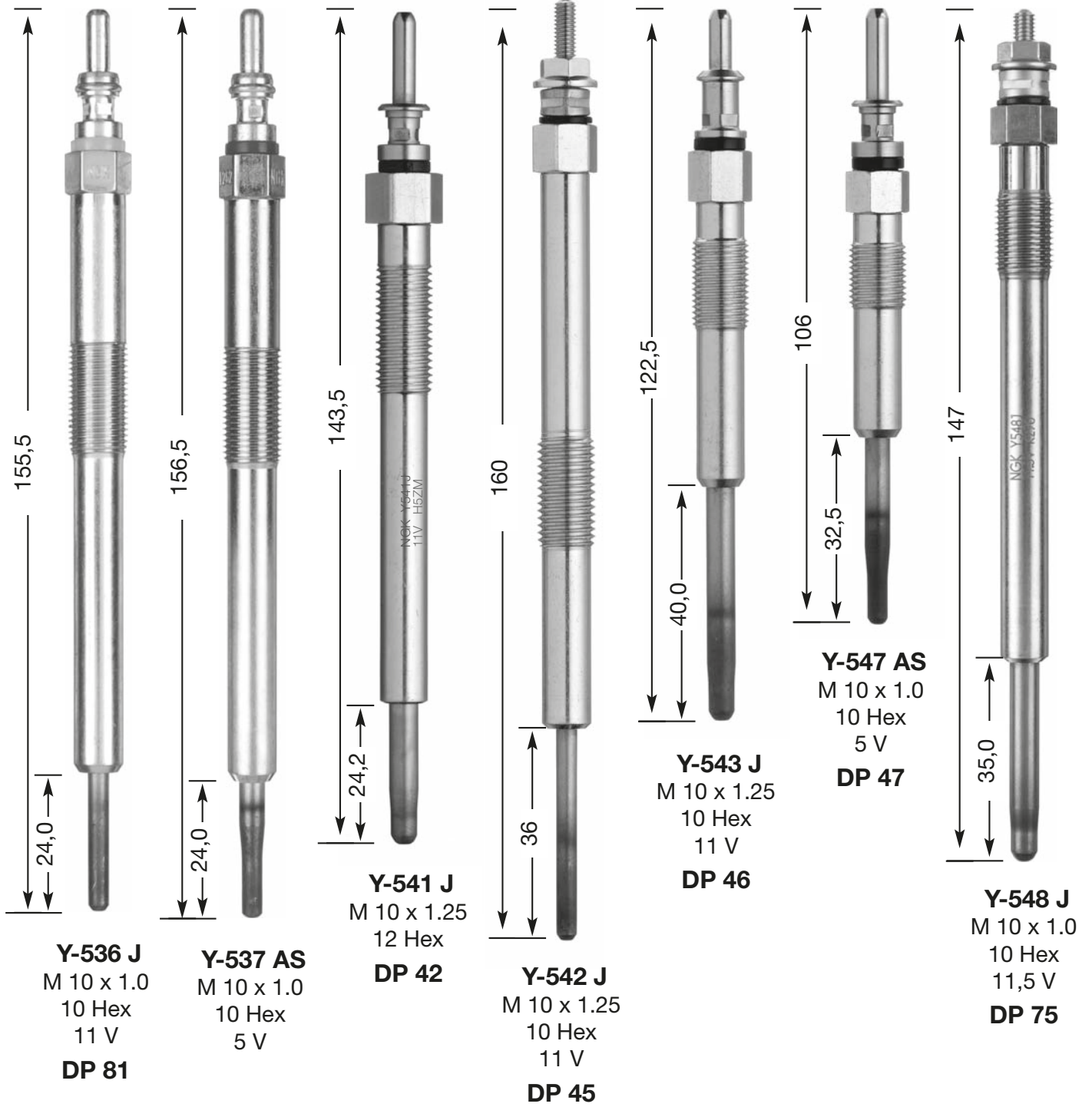



**Y-603 J**  
M 10 x 1.25  
12 Hex  
11 V  
**DP 60**



**Y-604 J**  
M 10 x 1.0  
10 Hex  
11 V

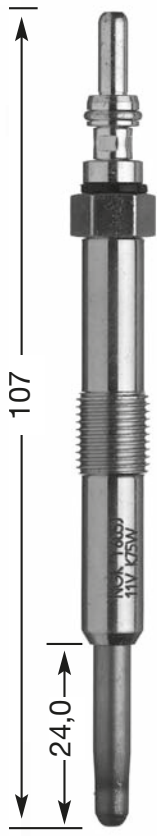

**Y-605 J**  
M 10 x 1.0  
10 Hex  
11 V

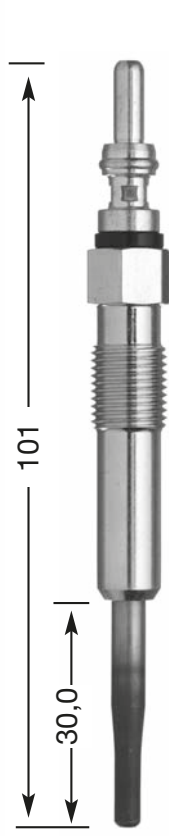

**Y-607 AS**  
M 10 x 1.0  
10 Hex  
5 V  
**DP 50**

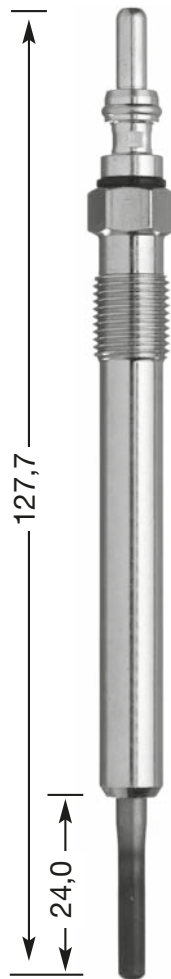

**Y-609 AS**  
M 10 x 1.0  
10 Hex  
4,4 V  
**DP 49**

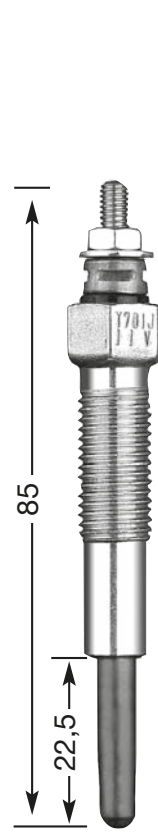

**Y-701 J**  
M 10 x 1.25  
12 Hex  
11 V  
**DP 39**

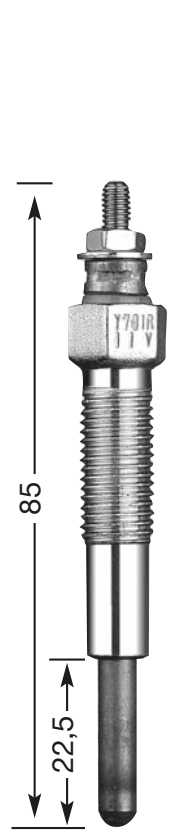

**Y-701 R**  
M 10 x 1.25  
12 Hex  
11 V

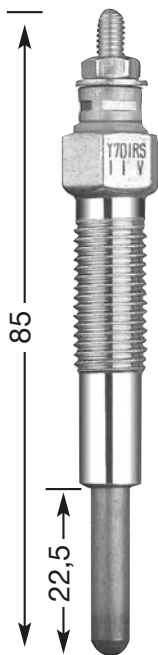

**Y-701 RS**  
M 10 x 1.25  
12 Hex  
11 V



**Y-701 U**  
M 10 x 1.25  
12 Hex  
10 V

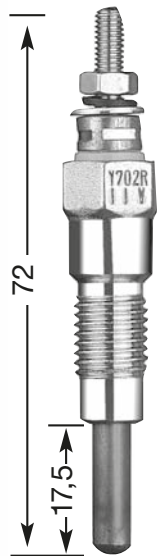

**Y-702 R**  
M 10 x 1.25  
12 Hex  
11 V

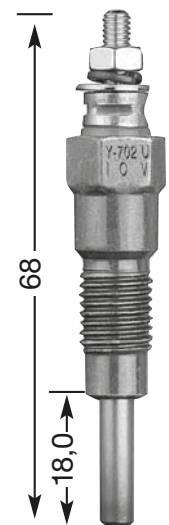

**Y-702 U**  
M 10 x 1.25  
12 Hex  
10 V

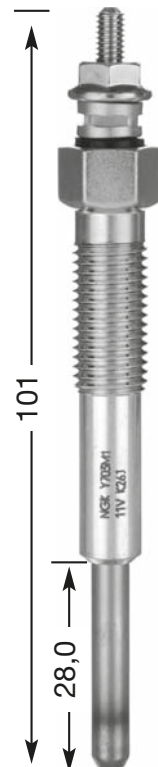

**Y-703 M1**  
M 10 x 1.25  
12 Hex  
11 V

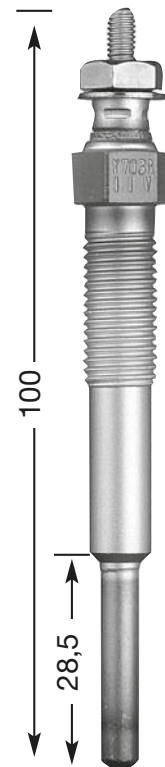

**Y-703 R**  
M 10 x 1.25  
12 Hex  
11 V



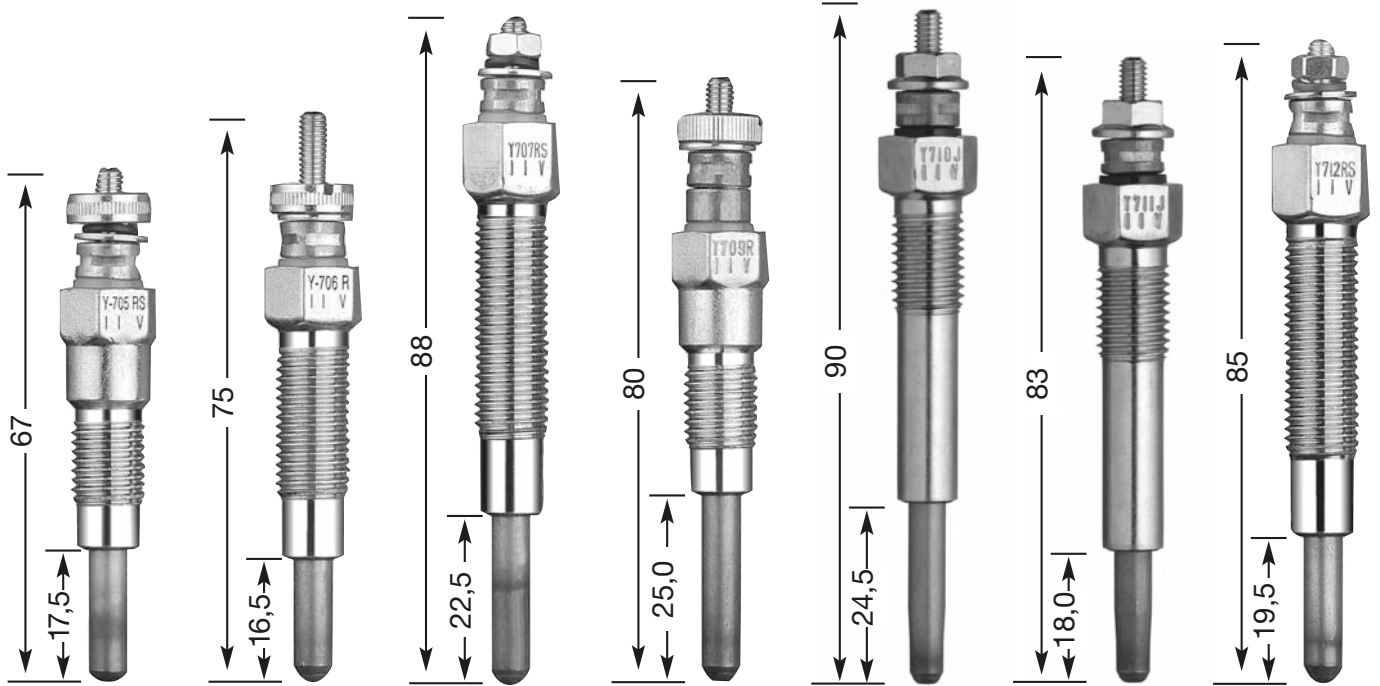

**Y-705 RS**  
M 10 x 1.25  
12 Hex  
11 V

**Y-706 R**  
M 10 x 1.25  
12 Hex  
11 V

**Y-707 RS**  
M 10 x 1.25  
12 Hex  
11 V

**Y-709 R**  
M 10 x 1.25  
12 Hex  
11 V

**Y-710 J**  
M 10 x 1.25  
12 Hex  
11 V

**Y-711 J**  
M 10 x 1.25  
12 Hex  
11 V

**Y-712 RS**  
M 10 x 1.25  
12 Hex  
11 V

**DP 28**

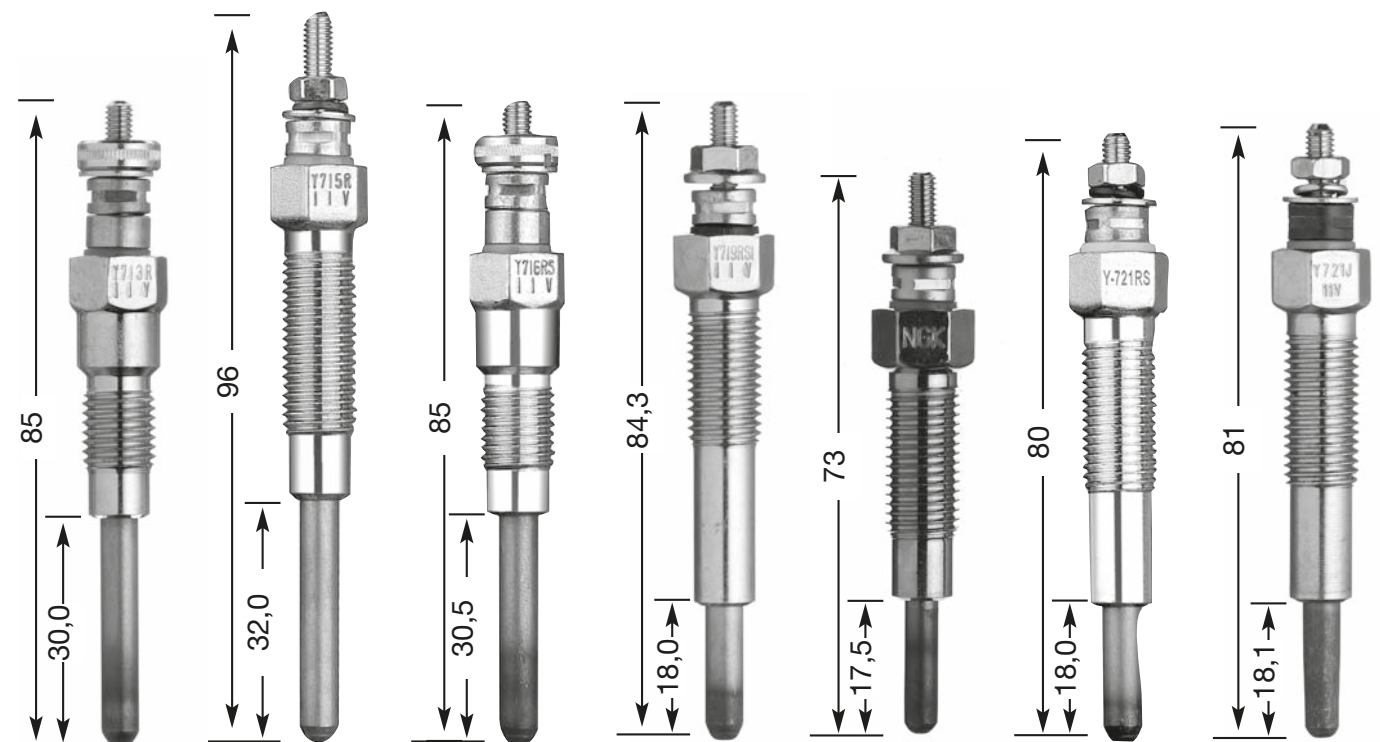

**Y-713 R**  
M 10 x 1.25  
12 Hex  
11 V

**Y-715 R**  
M 10 x 1.25  
12 Hex  
11 V

**Y-716 RS**  
M 10 x 1.25  
12 Hex  
11 V

**Y-719 RS 1**  
M 10 x 1.25  
12 Hex  
11 V

**Y-720 U1**  
M 12 x 1.25  
12 Hex  
10 V

**Y-721 RS**  
M 10 x 1.25  
12 Hex  
11 V

**Y-721 J**  
M 10 x 1.25  
12 Hex  
11 V

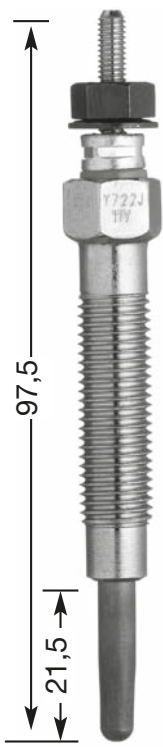

**Y-722 J**  
M 10 x 1.25  
12 Hex  
11 V

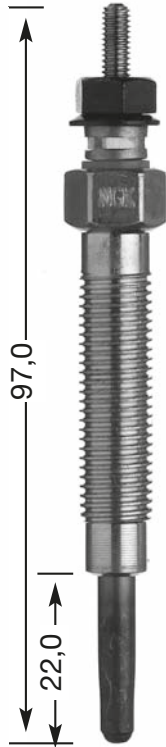

**Y-722 JS**  
M 12 x 1.25  
12 Hex  
11 V

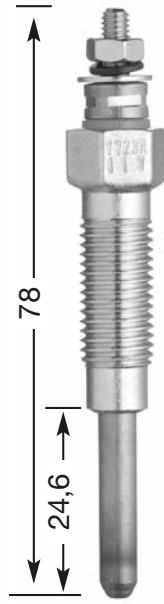

**Y-723 R**  
M 10 x 1.25  
12 Hex  
11 V

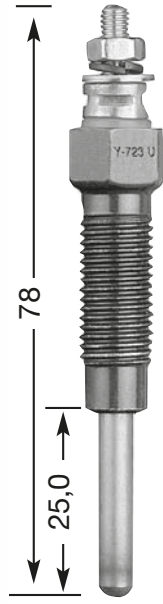

**Y-723 U**  
M 10 x 1.25  
12 Hex  
8 V

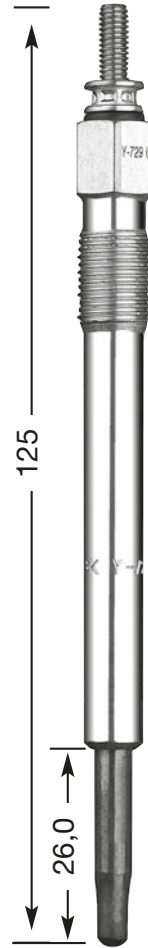

**Y-729 U**  
M 10 x 1.0  
10 Hex  
11,5 V  
DP 34

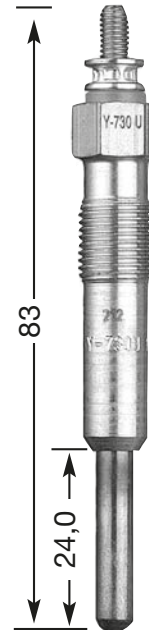

**Y-730 U**  
M 10 x 1.0  
10 Hex  
11 V  
DP 17

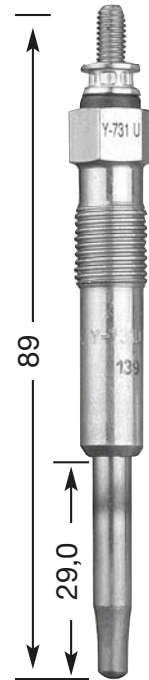

**Y-731 U**  
M 10 x 1.0  
10 Hex  
11 V  
DP 9



**Y-732 J**  
M 10 x 1.0  
10 Hex  
12 V  
DP 4

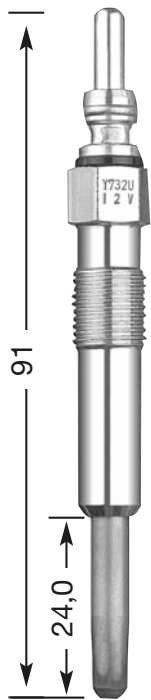

**Y-732 U**  
M 10 x 1.0  
10 Hex  
12 V  
DP 4

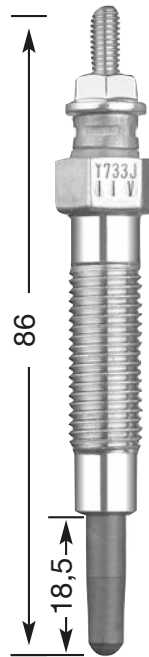

**Y-733 J**  
M 10 x 1.25  
12 Hex  
11 V  
DP 13

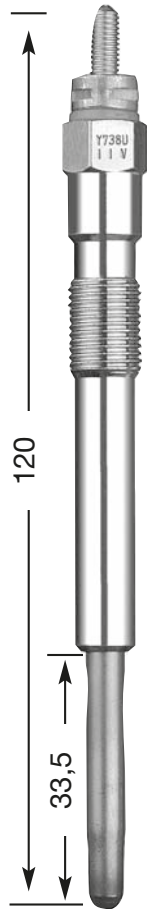

**Y-738 U**  
M 10 x 1.0  
10 Hex  
11 V

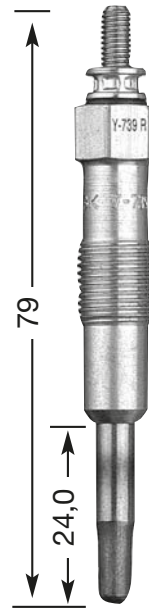

**Y-739 R**  
M 10 x 1.0  
10 Hex  
11 V

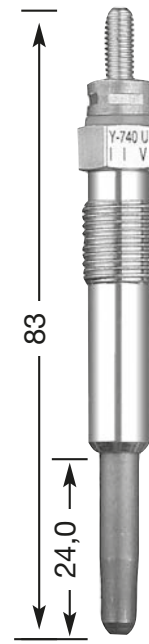

**Y-740 U**  
M 10 x 1.0  
10 Hex  
11 V  
DP 22

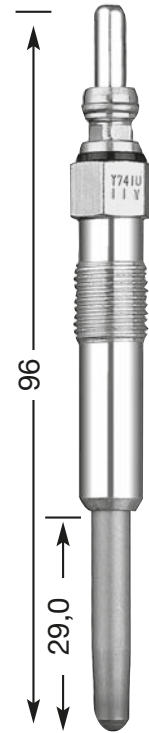

**Y-741 U**  
M 10 x 1  
10 Hex  
11 V  
DP 20

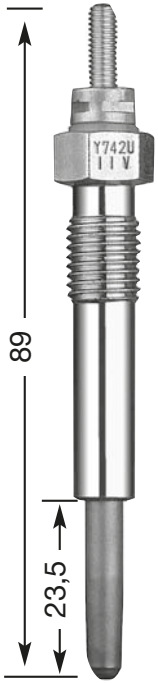

**Y-742 U**  
M 10 x 1.25  
12 Hex  
11 V

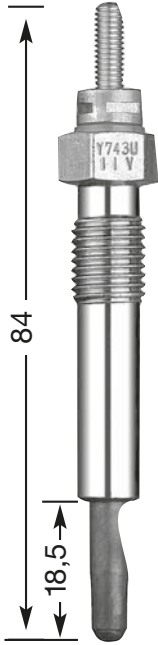

**Y-743 U**  
M 10 x 1.25  
12 Hex  
11 V

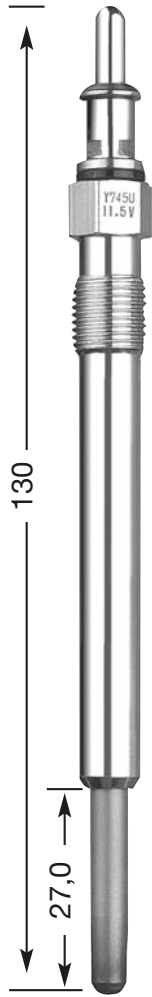

**Y-745 U**  
M 10 x 1.0  
10 Hex  
11,5 V  
**DP 11**

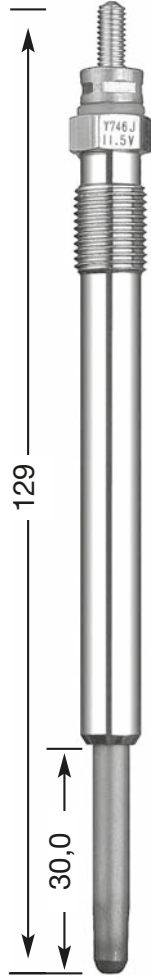

**Y-746 J**  
M 10 x 1.0  
10 Hex  
11,5 V  
**DP 38**

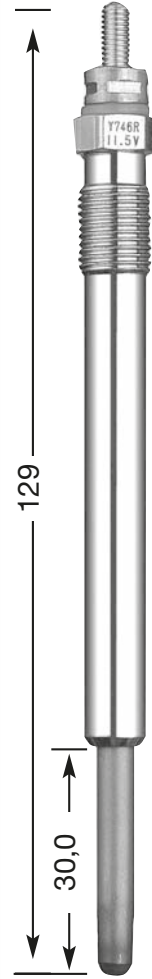

**Y-746 R**  
M 10 x 1.0  
10 Hex  
11,5 V

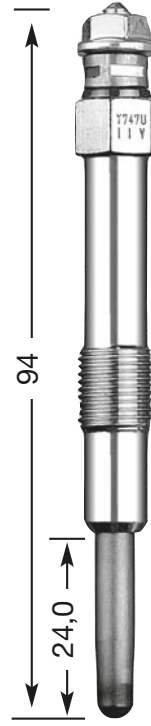

**Y-747 U**  
M 10 x 1  
10 Hex  
11 V  
**DP 26**

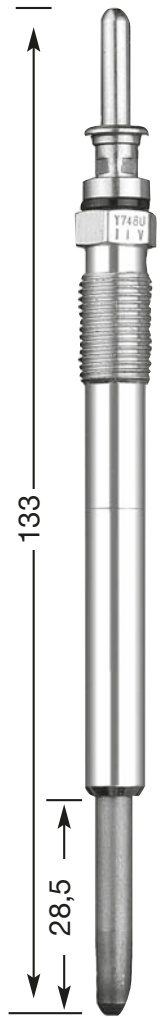

**Y-748 U**  
M 10 x 1  
10 Hex  
11 V  
**DP 14**



**Y-749 J**  
M 10 x 1.0  
10 Hex  
11 V

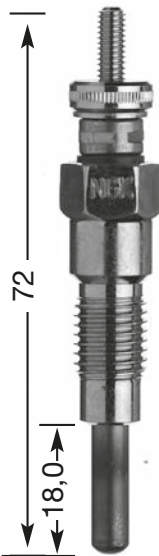

**Y-752 M**  
M 12 x 1.25  
12 Hex  
23 V

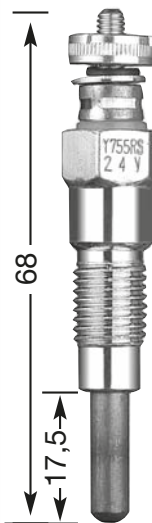

**Y-755 RS**  
M 10 x 1.25  
12 Hex  
24 V

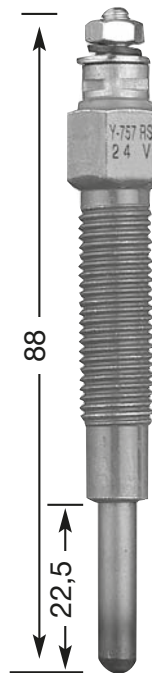

**Y-757 RS**  
M 10 x 1.25  
12 Hex  
24 V

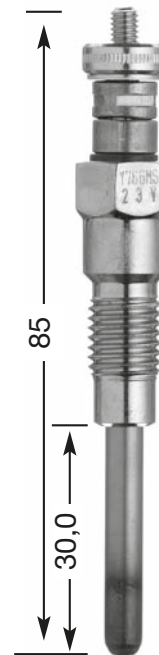

**Y-766 MS**  
M 10 x 1.25  
12 Hex  
23 V

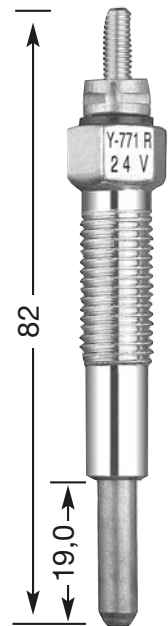

**Y-771 R**  
M 10 x 1.25  
12 Hex  
24 V

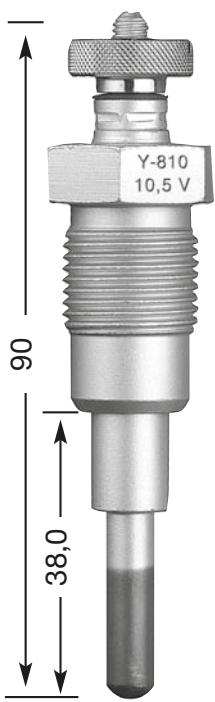

**Y-810**  
M 18 x 1.5  
20.6 Hex  
10,5 V

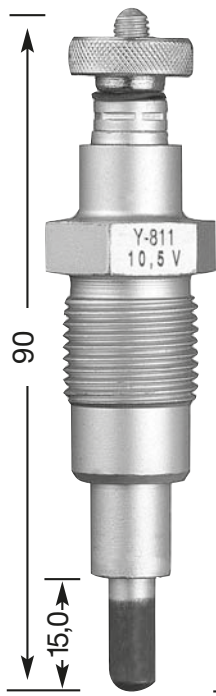

**Y-811**  
M 18 x 1.5  
20.6 Hex  
10,5 V

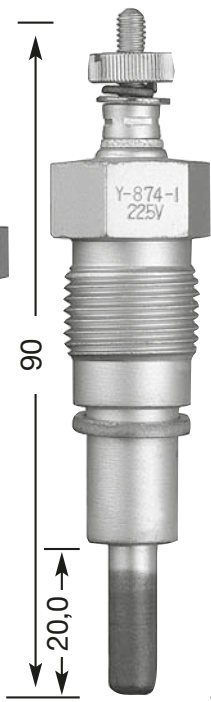

**Y-874-1**  
M 18 x 1.5  
19 Hex  
22,5 V

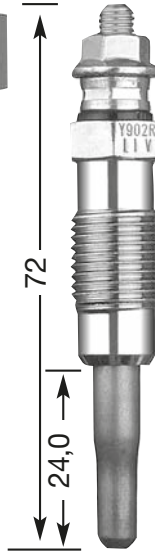

**Y-902 R**  
M 12 x 1.25  
12 Hex  
11 V

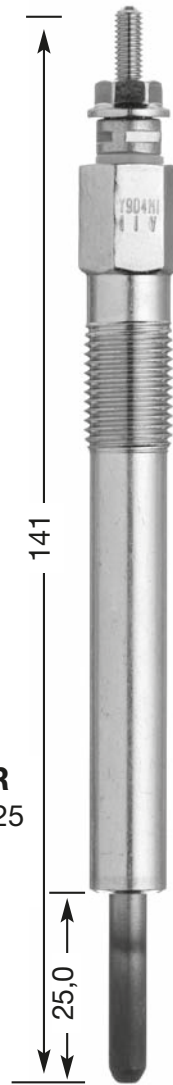

**Y-904 M1**  
M 12 x 1.25  
12 Hex  
11 V

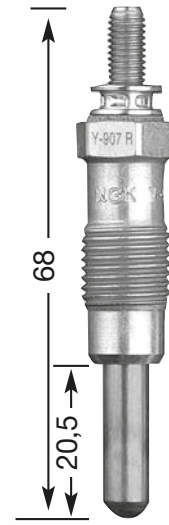

**Y-907 R**  
M 12 x 1.25  
12 Hex  
11,5 V

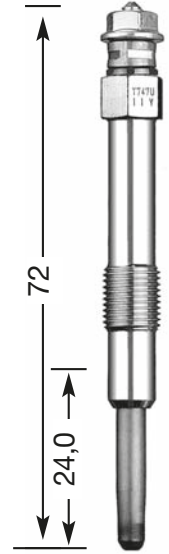

**Y-908 R**  
M 12 x 1.25  
12 Hex  
11 V

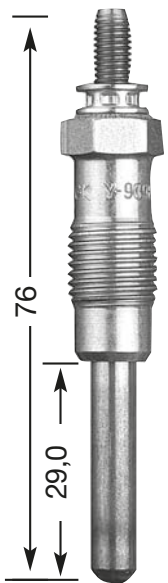

**Y-909 R**  
M 12 x 1.25  
12 Hex  
11 V

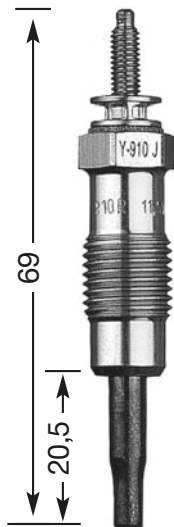

**Y-910 J**  
M 12 x 1.25  
12 Hex  
11,5 V  
**DP 3**

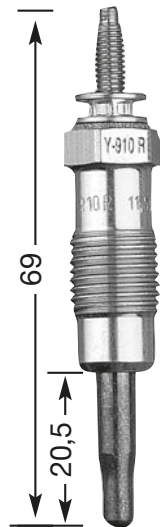

**Y-910 R**  
M 12 x 1.25  
12 Hex  
11,5 V

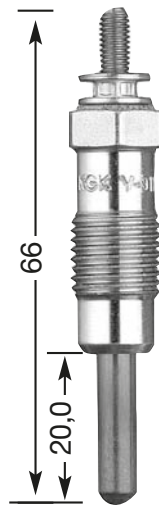

**Y-911 J**  
M 12 x 1.25  
12 Hex  
11 V  
**DP 33**

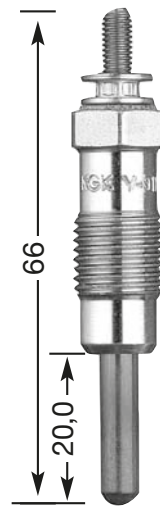

**Y-911 R**  
M 12 x 1.25  
12 Hex  
11 V

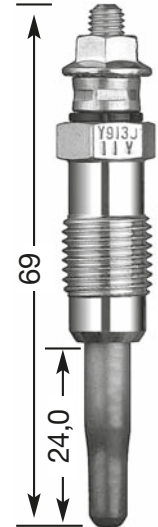

**Y-913 J**  
M 12 x 1.25  
12 Hex  
11 V  
**DP 15**

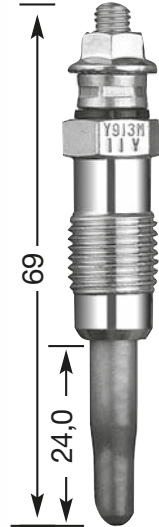

**Y-913 M**  
M 12 x 1.25  
12 Hex  
11 V





**Y-914 U**  
M 12 x 1.25  
12 Hex  
11 V

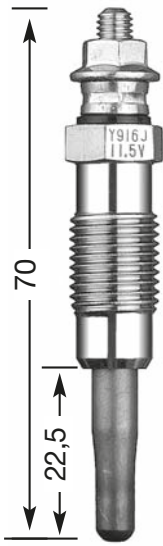

**Y-916 J**  
M 12 x 1.25  
12 Hex  
11,5 V  
**DP 6**

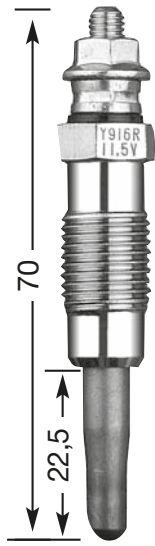

**Y-916 R**  
M 12 x 1.25  
12 Hex  
11,5 V

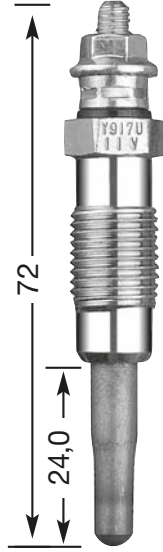

**Y-917 U**  
M 12 x 1.25  
12 Hex  
11 V

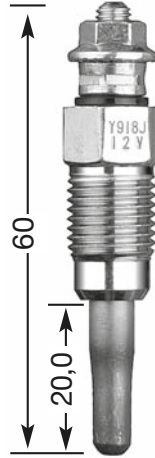

**Y-918 J**  
M 12 x 1.25  
12 Hex  
12 V  
**DP 2**

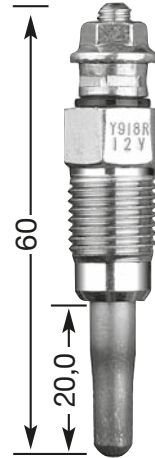

**Y-918 R**  
M 12 x 1.25  
12 Hex  
12 V

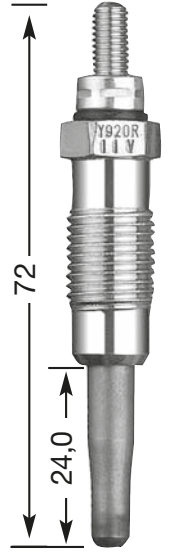

**Y-920 R**  
M 12 x 1.25  
12 Hex  
11 V

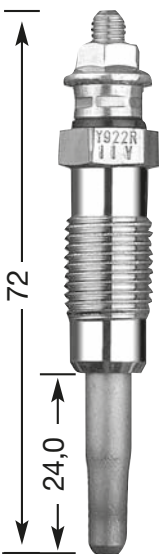

**Y-922 R**  
M 12 x 1.25  
12 Hex  
11 V

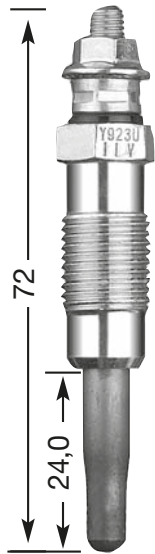

**Y-923 U**  
M 12 x 1.25  
12 Hex  
11 V

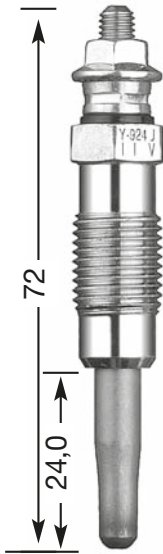

**Y-924 J**  
M 12 x 1.25  
12 Hex  
11 V  
**DP 1**

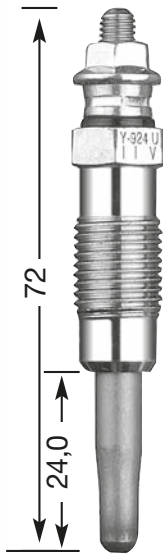

**Y-924 U**  
M 12 x 1.25  
12 Hex  
11 V

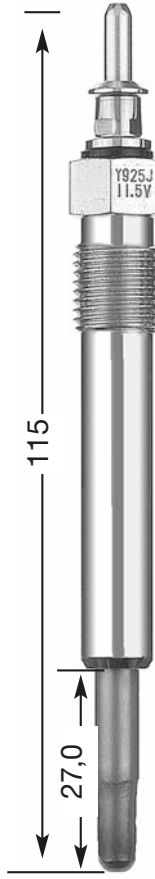

**Y-925 J**  
M 12 x 1.25  
12 Hex  
11,5 V  
**DP 16**

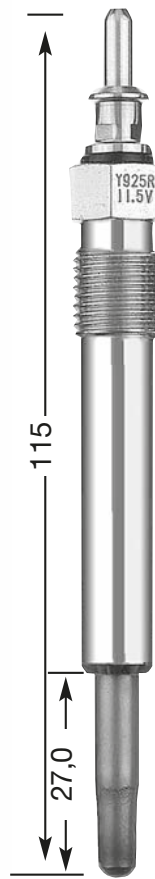

**Y-925 R**  
M 12 x 1.25  
12 Hex  
11,5 V

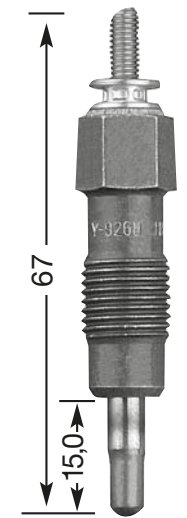

**Y-926 U**  
M 12 x 1.25  
12 Hex  
11 V

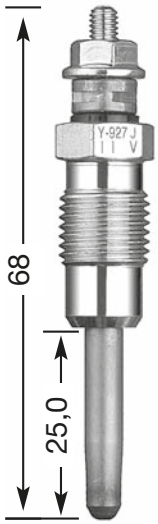

**Y-927 J**  
M 12 x 1.25  
12 Hex  
11 V  
**DP 19**

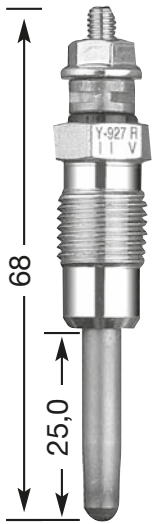

**Y-927 R**  
M 12 x 1.25  
12 Hex  
11 V

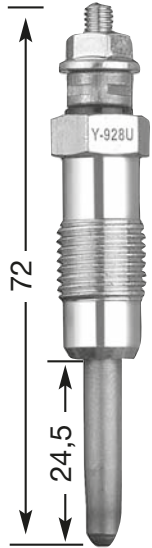

**Y-928 U**  
M 12 x 1.25  
12 Hex  
11 V  
**DP 29**

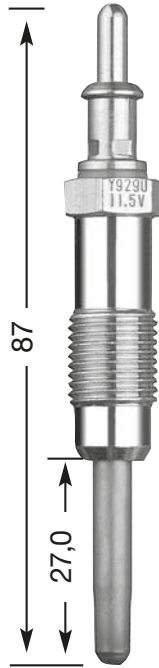

**Y-929 U**  
M 12 x 1.25  
12 Hex  
11,5 V  
**DP 41**

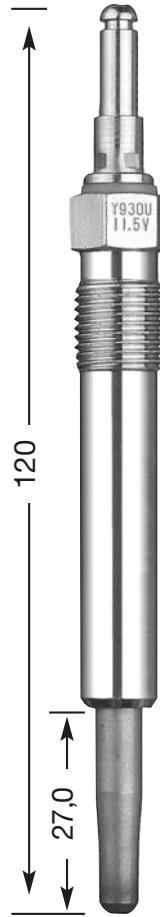

**Y-930 U**  
M 12 x 1.25  
12 Hex  
11,5 V  
**DP 30**

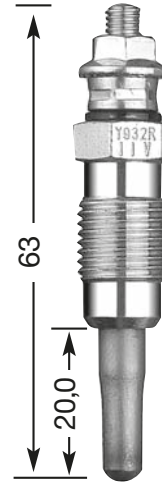

**Y-932 R**  
M 12 x 1.25  
12 Hex  
11 V

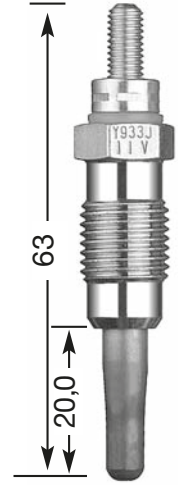

**Y-933 J**  
M 12 x 1.25  
12 Hex  
11 V  
**DP 25**

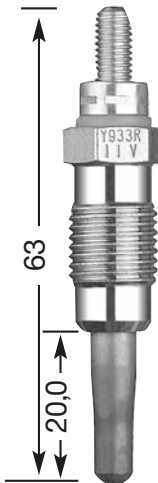

**Y-933 R**  
M 12 x 1.25  
12 Hex  
11 V

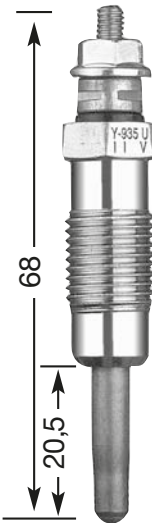

**Y-935 U**  
M 12 x 1.25  
12 Hex  
11 V  
**DP 23**

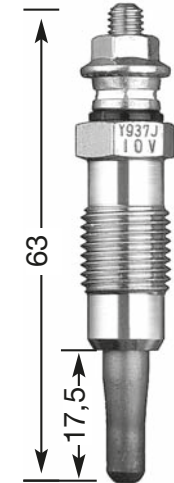

**Y-937 J**  
M 12 x 1.25  
12 Hex  
10 V  
**DP 5**

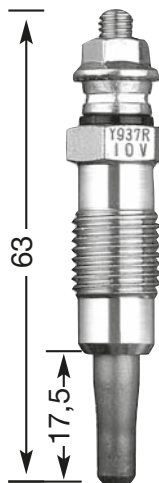

**Y-937 R**  
M 12 x 1.25  
12 Hex  
10 V

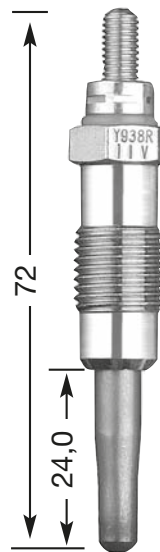

**Y-938 R**  
M 12 x 1.25  
12 Hex  
11 V

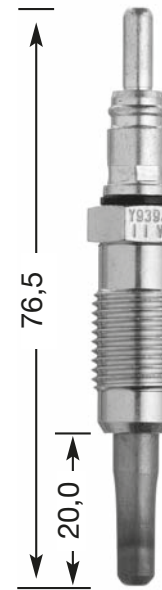

**Y-939 J**  
M 12 x 1.25  
12 Hex  
11 V  
**DP 43**

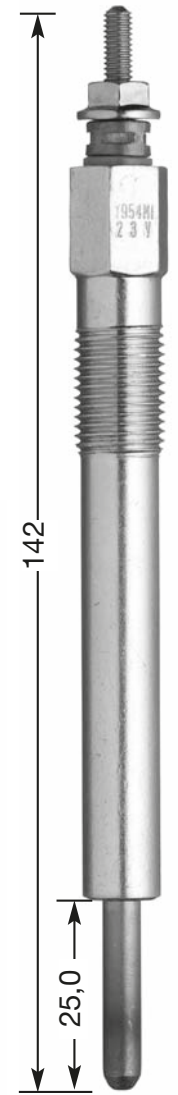

**Y-954 M1**  
M 12 x 1.25  
12 Hex  
23 V

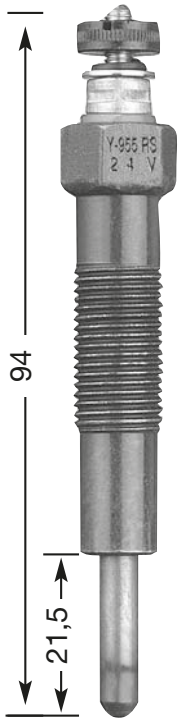

**Y-955 RS**  
M 12 x 1.25  
14 Hex  
24 V

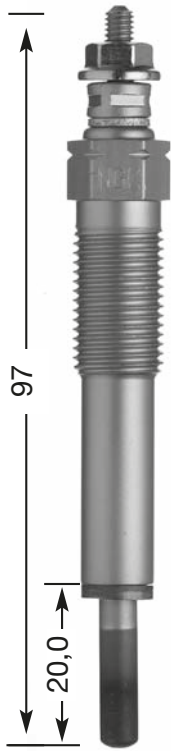

**Y-971 M**  
M 12 x 1.25  
12 Hex  
23 V

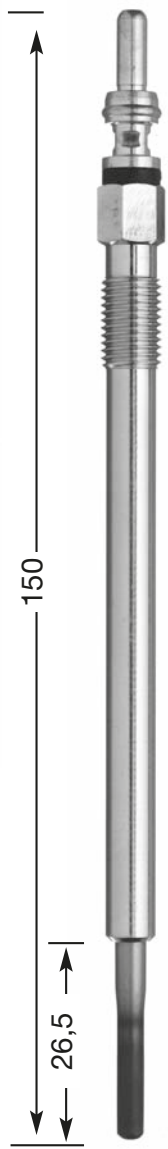

**Y-8002 AS**  
M 8 x 1.0  
8 Hex  
4,4 V  
**DP 51**

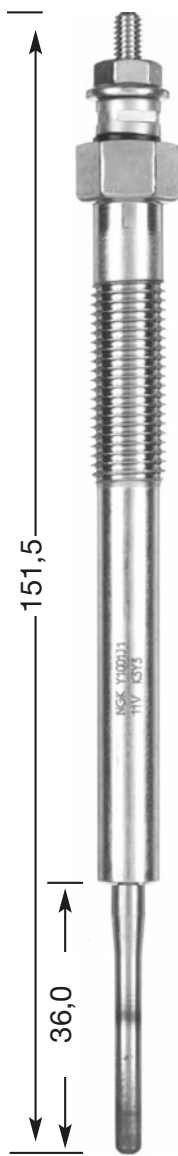

**Y1001 J1**  
M 10 x 1.25  
12 Hex  
11 V

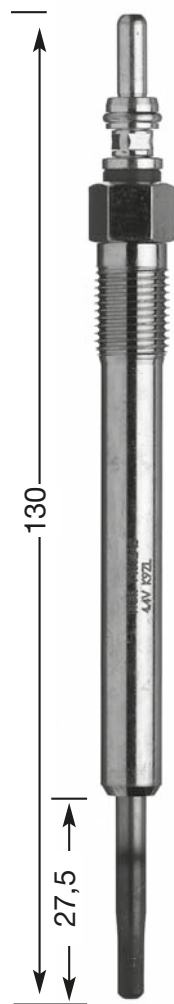

**Y1002 AS**  
M 10 x 1.0  
10 Hex  
4,4 V  
**DP 57**



**Y1003 AS**  
M 10 x 1.25  
10 Hex  
5 V



**Y1005 J**  
M 10 x 1.0  
10 Hex  
11 V  
**DP 56**

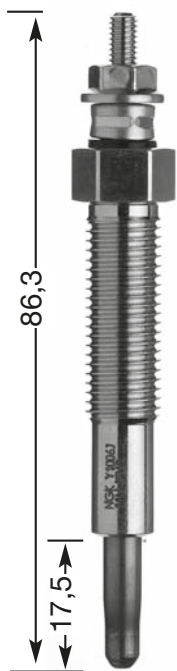

**Y1006 J**  
M 10 x 1.25  
12 Hex  
11 V



**Y1007 J**  
M 12 x 1.25  
12 Hex  
11 V  
**DP 59**

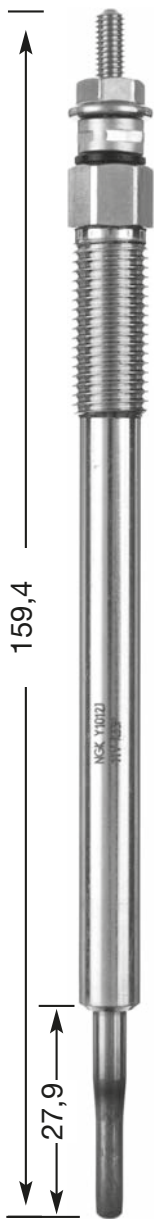

**Y1012 J**  
M 10 x 1.25  
10 Hex  
11 V  
**DP 65**



**Y1013 J**  
M 10 x 1.25  
12 Hex  
11 V  
**DP 63**

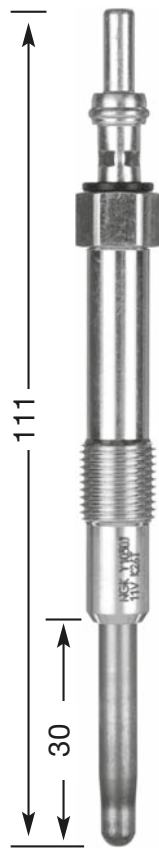

**Y1030 J**  
M 10 x 1.0  
10 Hex  
11 V  
**DP 70**

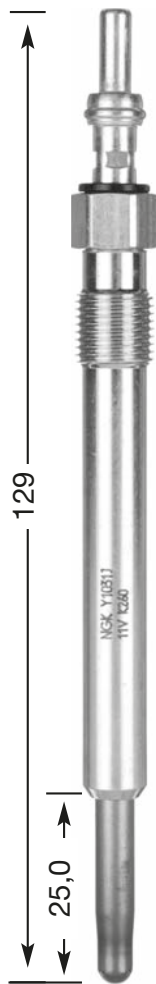

**Y1031 J**  
M 10 x 1.0  
10 Hex  
11 V  
**DP 71**

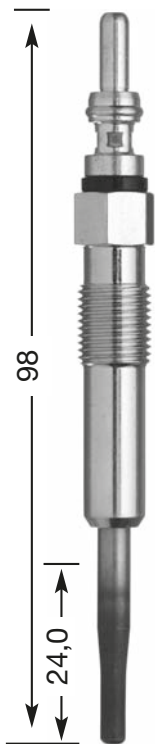

**Y1035 AS**  
M 10 x 1.0  
10 Hex  
4,4 V  
**DP 77**



**Y1036 AS**  
M 10 x 1.0  
10 Hex  
4,4 V

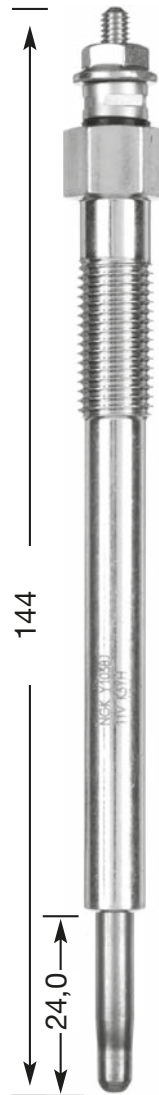

**Y1038 J**  
M 10 x 1.25  
12 Hex  
11 V

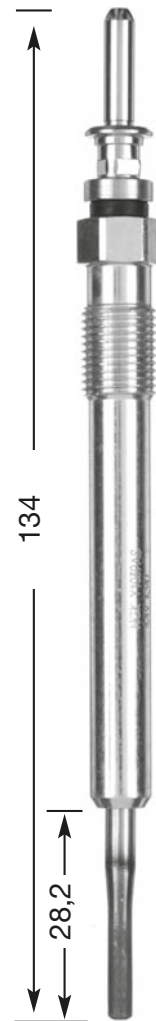

**Y1039 AS**  
M 10 x 1.0  
10 Hex  
4,4 V  
**DP 80**

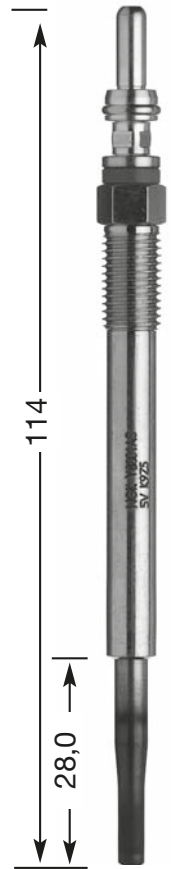

**Y8001 AS**  
M 8 x 1.0  
8 Hex  
5 V  
**DP 58**



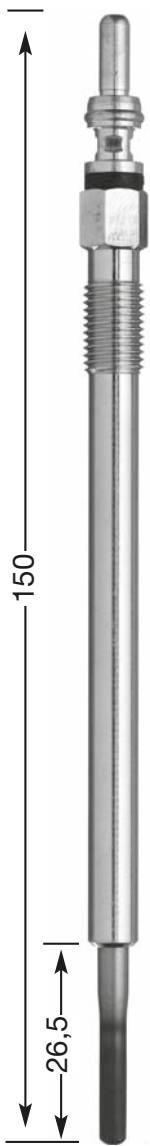

**Y8002 AS**  
 M 8 x 1.0  
 8 Hex  
 4,4 V  
**DP 51**

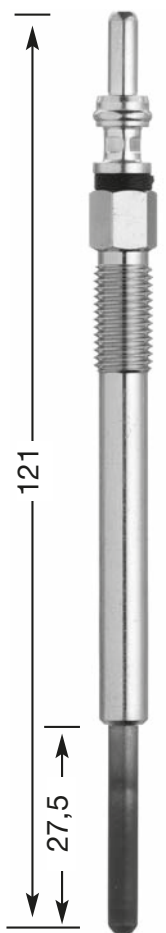

**Y8003 J**  
 M 8 x 1.0  
 8 Hex  
 11 V  
**DP 62**

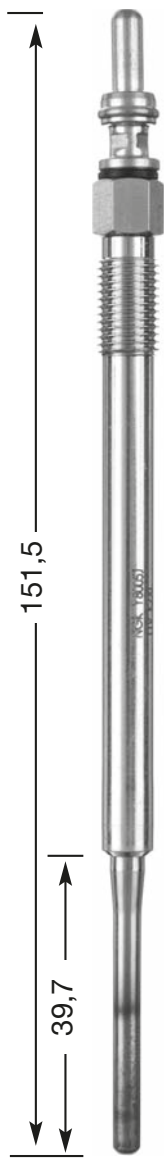

**Y8005 J**  
 M 8 x 1.0  
 8 Hex  
 11 V  
**DP 64**

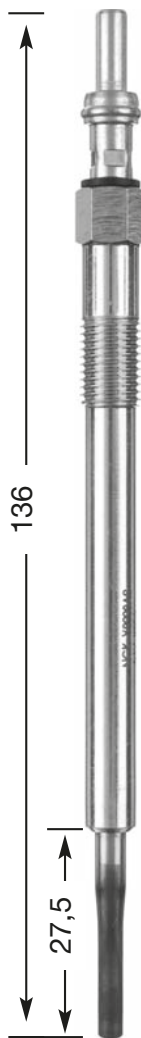

**Y8008 AS**  
 M 8 x 1.0  
 8 Hex  
 11 V  
**DP 74**



**Y 9001 AS**  
 M 9 x 1.0  
 9 Hex  
 4,3 V  
**DP 72**

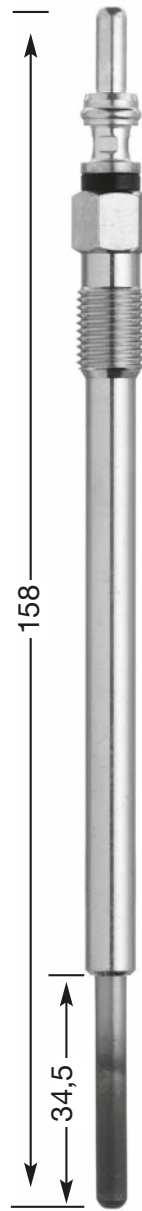

**Y-9003 AS**  
 M 9 x 1.0  
 9 Hex  
 4,4 V  
**DP 78**

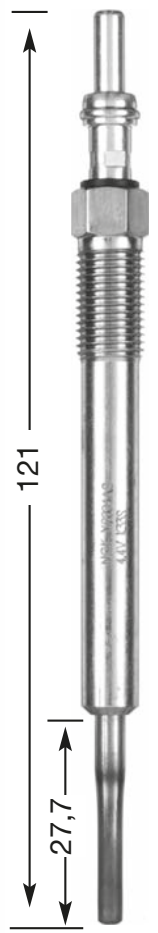

**Y9004 AS**  
 M 9 x 1.0  
 9 Hex  
 4,4 V

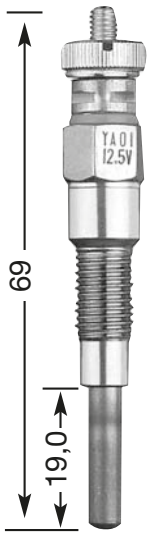

**YA 01**  
M 8 x 1.0  
10 Hex  
12,5 V

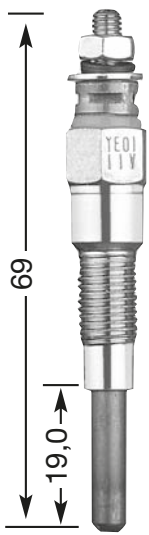

**YE 01**  
M 8 x 1.0  
10 Hex  
11 V

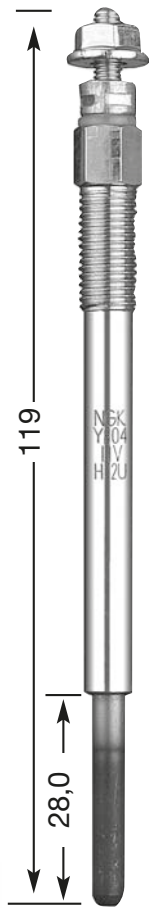

**YE 04**  
M 8 x 1.0  
8 Hex  
11 V  
**DP 40**

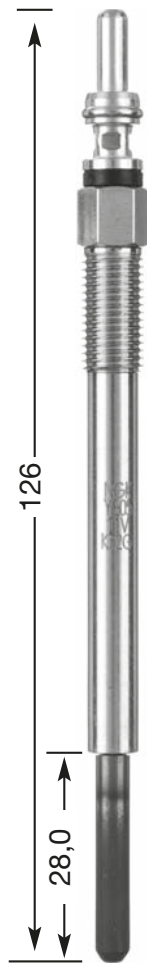

**YE 05**  
M 8 x 1.0  
8 Hex  
11 V  
**DP 73**

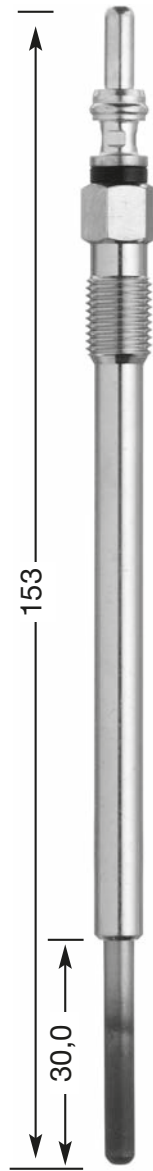

**YE 07**  
M 9 x 1.0  
9 Hex  
11 V

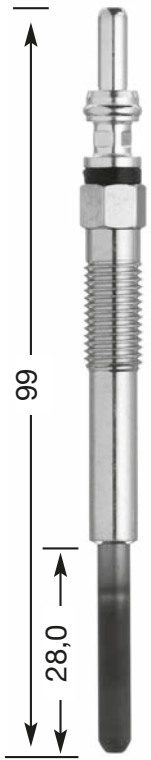

**YE 08**  
M 8 x 1.0  
8 Hex  
11 V

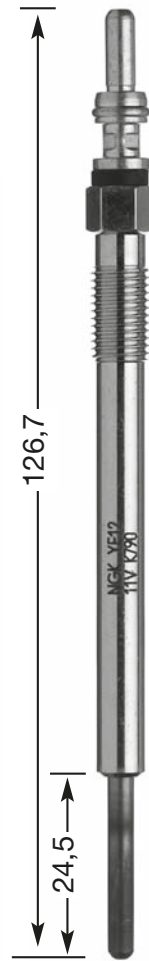

**YE 12**  
M 8 x 1.0  
8 Hex  
11 V

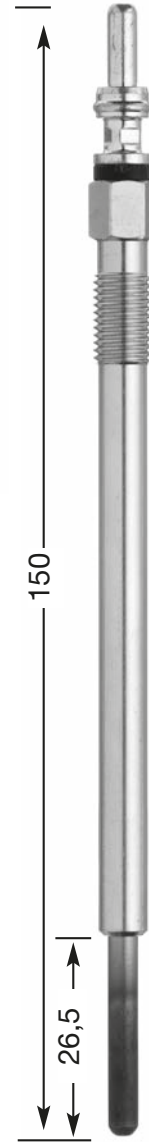

**YE 13**  
M 8 x 1.0  
8 Hex  
11,5 V

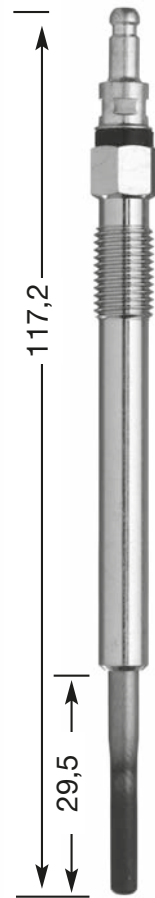

**YE 14**  
M 8 x 1.0  
8 Hex  
4,4 V  
**DP 48**

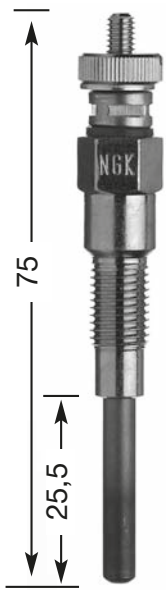

**YE 52**  
M 8 x 1.0  
10 Hex  
23 V

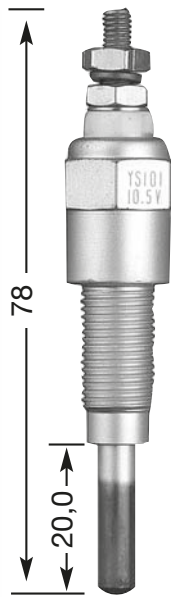

**YS 101**  
M 10 x 1.0  
14 Hex  
10,5 V

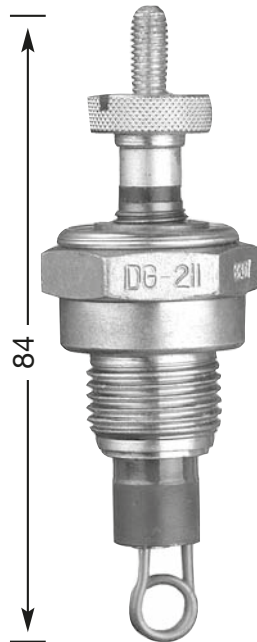

**DG-211**  
M 18 x 1.5  
25 Hex

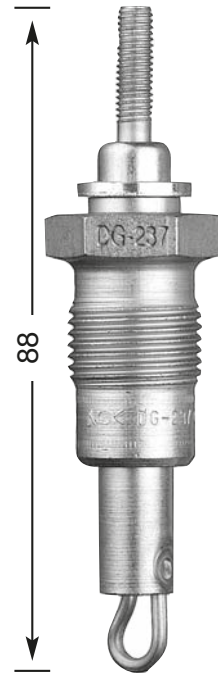

**DG-237**  
M 18 x 1.5  
21 Hex  
0,9 V

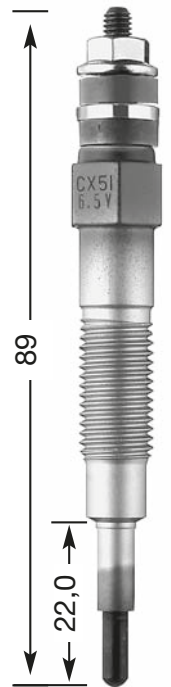

**CX 51**  
M 10 x 1.25  
10 Hex  
6,5 V

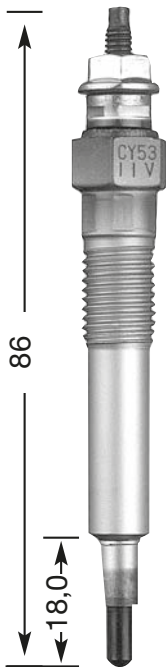

**CY 03**  
M 10 x 1.25  
12 Hex  
11 V  
**DP 8**

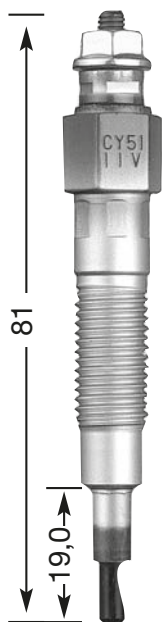

**CY 51**  
M 10 x 1.25  
12 Hex  
11 V

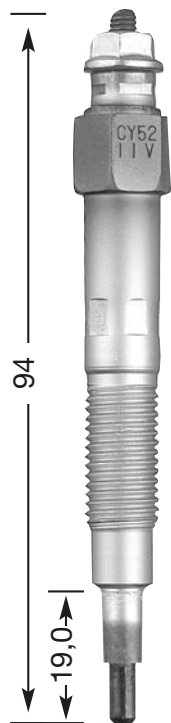

**CY 52**  
M 10 x 1.25  
12 Hex  
11 V

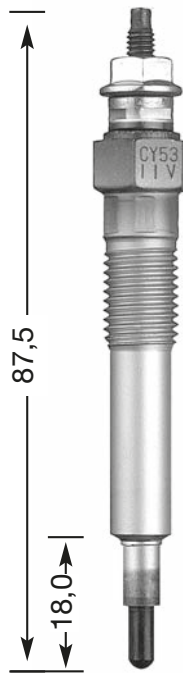

**CY 53 †**  
M 10 x 1.25  
12 Hex  
11 V

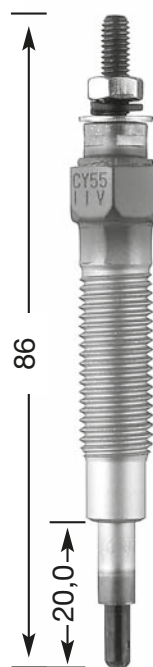

**CY 55**  
M 10 x 1.25  
12 Hex  
11 V

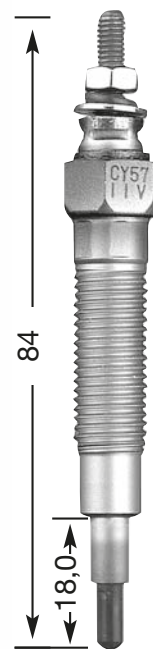

**CY 57**  
M 10 x 1.25  
12 Hex  
11 V

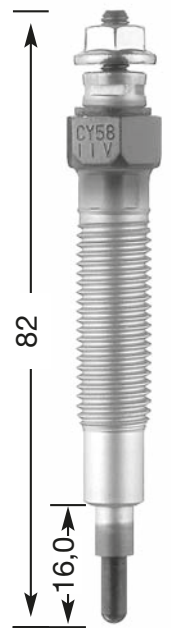

**CY 58**  
M 10 x 1.25  
12 Hex  
11 V

**DP 21**

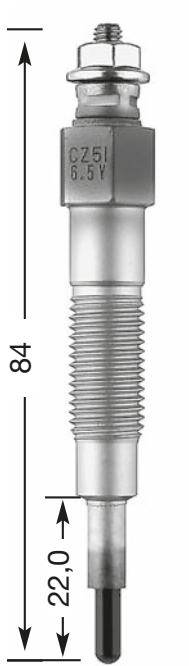

**CZ 51**  
M 10 x 1.25  
12 Hex  
6,5 V



**CZ 71 †**  
M 10 x 1.25  
12 Hex  
11 V

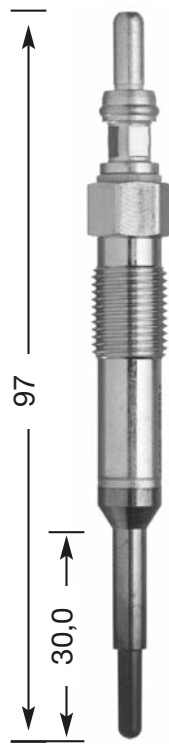

**CZ 104**  
M 10 x 1.0  
10 Hex  
7 V  
**DP 52**



**CZ 105**  
M 10 x 1.25  
10 Hex  
7 V

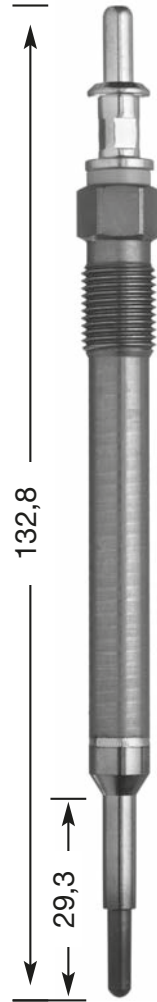

**CZ 106**  
M 10 x 1.0  
10 Hex  
7 V  
**DP 53**



**CZ 203**  
M 10 x 1.25  
12 Hex  
11 V  
**DP 68**

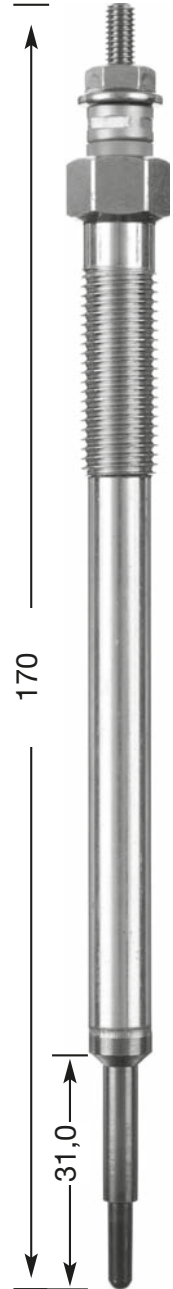

**CZ 251**  
M 10 x 1.25  
12 Hex  
11 V  
**DP 76**



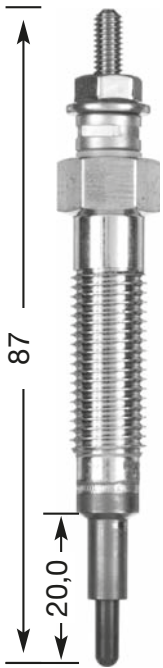

**CZ 256**  
M 10 x 1.25  
12 Hex  
11 V



**CZ 258**  
M 10 x 1.25  
12 Hex  
11 V

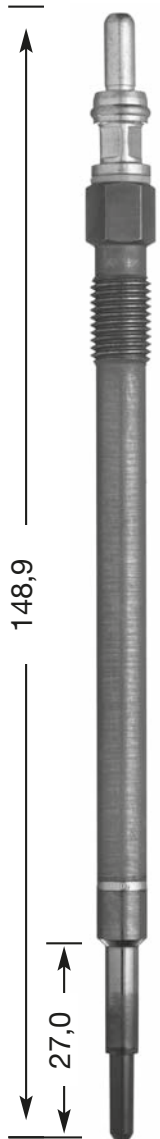

**CZ 303**  
M 8 x 1.0  
8 Hex  
7 V  
**DP 54**

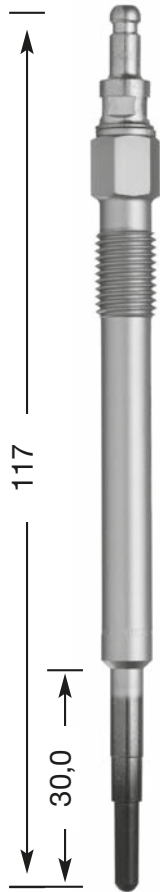

**CZ 304**  
M 8 x 1.0  
8 Hex  
7 V  
**DP 55**

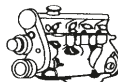

Code *l* kW

Cyl.



Stock-No.



LPG/CNG

**ABARTH**

500 1.4 T-Jet 16V		1.4	99	08 -		4	0,8	IKR9J8	93311		
500 Abarth		1.4	103	06.10 -		4	0,8	IKR9J8	93311		
Grande Punto 1.4 T-Jet 16V 180CV SS		1.4	132	09.09 -		4	0,8	IKR9J8	93311		
Grande Punto 1.4 T-Jet 16V		1.4	114	07 -	199A8000	4	0,8	IKR9J8	93311		
Punto EVO Abarth		1.4	120	06.10 -		4	0,8	IKR9J8	93311		

**ACURA**

RSX		2.0	147	02 - 03	K20A2	4	1,1	IFR7G-11KS	7746		
RSX		2.0		02 - 02	K20A3	4	1,1	IZFR6K11	6994		
SLX		3.2		96 - 97	6VD1	6	1,1	PFR5G-11	2647		
SLX		3.5		98 -	6VE1	6	1,1	PFR5G-11	2647		

**ALFA ROMEO****4C**

4C 1.8 Tbi		1.8	177	03.13 -	960A1000	4	0,6	ILKAR7D6G	93607		
------------	--	-----	-----	---------	----------	---	-----	-----------	-------	--	--

**33**

33 i.e		1.3	65	02.94 - 10.94	AR307.32	4	0,7	BP6ES	7811	4	LPG 2
33 i.e Sport Wagon		1.3	65	02.94 - 10.94	AR307.32-301.68	4	0,7	BP6ES	7811	4	LPG 2
33 - 1.3 L		1.3		87 - 01.94	AR305.02-86-87	4	0,7	BP6ES	7811	4	LPG 2
33 i.e.		1.4	66	01.92 - 12.93	AR307.53	4	0,7	BP6ES	7811	4	LPG 2
33 i.e.; Cat.		1.5	74	12.90 - 93	AR307.51	4	0,7	BP6ES	7811	4	LPG 2
33 - 1.5 L		1.5	77	84 - 93	AR307.34-305.88	4	0,7	BP6ES	7811	4	LPG 2
33 i.e. all 1.7 Ltr.cat.		1.7	77	90 - 93	AR307.46-47	4	0,9	PFR6B	3500		PFR7B
33 i.e. - 1.7 L		1.7	85	88 - 93	AR305.50	4	0,7	BP6ES	7811	4	LPG 2
33 i.e.- 1.7 Ltr.16V		1.7	95	01.88 - 12.93	AR307.36-37	4	0,9	PFR6B	3500		PFR7B
33 TD		1.8	55	09.86 - 03.94		4	█	Y-909R	4602		
33 TD		1.8	62	09.86 - 03.94	VM HR-392	3	█	Y-909R	4602		
33 TD		1.8	62	02.90 - 03.94	VM 82 A	4	█	Y-909R	4602		
33 TD Sport Wagon		1.8	62	01.90 - 03.94	VM 96 A	4	█	Y-909R	4602		

**75**

75 TD		2.0	70	05.85 - 02.92	VM 80 A	4	█	Y-909R	4602		
75 i.Twin Spark		2.0	106	01.87 - 02.92	AR061.66 Cat.-062.24	4	0,7	BCP6ES	4930	17	LPG 3
75 TD		2.4	81	10.88 - 02.92	VM 81 A	4	█	Y-909R	4602		
75 i. V6		2.5	110	09.85 - 02.92	AR016.46-019.11 Cat.	6	0,8	BP7ES	2412		BPR8EIX
75 i. V6		3.0	133	01.87 - 02.92	AR061.20-061.24 Cat.	6	0,7	BP6ES	7811	4	LPG 2
75 i. V6		3.0	139	02.90 - 02.92	AR061.503	6	0,7	PGR6A	4984		

**145**

145 i.e L		1.4	66	08.94 - 11.96	AR33.501	4	0,7	BP6ES	7811	4	LPG 2
145 i. 16V Twin Spark;L; Junior		1.4	76	04.97 - 12.01	AR33.503	4		BKR6EKPA	2513		
								+ PMR7A	+4259		
145 i.e L		1.6	76	08.94 - 11.96	AR33.201	4	0,7	BP6ES	7811	4	LPG 2
145 i. 16V Twin Spark L		1.6	88	04.96 - 12.01	AR67.601	4		BKR6EKPA	2513		
								+ PMR7A	+4259		
145 i.e 16V		1.7	95	08.94 - 11.96	AR33.401	4	0,9	PFR6B	3500		PFR7B
145 i. Twin Spark 16V- L		1.8	103	12.96 - 03.98	AR67.106	4		BKR6EKPA	2513		
								+ PMR7A	+4259		
145 i. 16V Twin Spark		1.8	106	03.98 - 12.01	AR32.201	4		BKR6EKPA	2513		
								+ PMR7A	+4259		
145 TD		1.9	66	04.94 - 09.96	AR67.501	4	█	Y-924J	7906	1	
145 TD		1.9	66	10.96 - 09.97	AR33.601	4	█	Y-924J	7906	1	

Code *l* kW

Cyl.



Stock-No.



LPG/CNG

**ALFA ROMEO****145**

145 JTD		1.9	77	11.99 - 01.01	AR32.302 dal n. motore 1716459 —>	4		Y-534J	3413	36	
145 JTD		1.9	77	02.99 - 10.99	AR32.302 fino a n. motore —>1716458	4		Y-747U	4694	26	
145 i. 16V T.S. Quadrifoglio		2.0	110	10.95 - 04.01	AR67.204	4		BKR6EKPA + PMR7A	2513 +4259		
145 16V T.S. (Brazil)		2.0	110	12.96 - 04.01		4		BKR6EKPA + PMR7A	2513 +4259		
145 i 2.0 16V T.S.		2.0	114	03.98 - 04.01	AR32.301	4		BKR6EKPA + PMR7A	2513 +4259		

**146**

146 i.e.		1.3	66	07.95 - 11.97	AR33.201	4	0,7	BP6ES	7811	4	LPG 2
146 i.e- L		1.4	66	08.94 - 02.97	AR33.501	4	0,7	BP6ES	7811	4	LPG 2
146 T.S.		1.4	76	11.96 - 12.01	AR33.503	4		BKR6EKPA + PMR7A	2513 +4259		
146 i Twin Spark 16V; L		1.4	76	02.97 - 03.98	AR33.503	4		BKR6EKPA + PMR7A	2513 +4259		
146 1.4i 16V Twin Spark; L; Junior		1.4	76	04.98 - 12.01	AR33.503	4		BKR6EKPA + PMR7A	2513 +4259		
146 i.e L		1.6	76	07.94 - 12.97	AR33.201	4	0,7	BP6ES	7811	4	LPG 2
146 i 16V Twin Spark L		1.6	88	04.96 - 12.01	AR67.601	4		BKR6EKPA + PMR7A	2513 +4259		
146		1.7	78	08.98 - 04.99	AR32.201	4		BKR6EKPA + PMR7A	2513 +4259		
146 i.e 16V		1.7	95	08.94 - 02.97	AR33.401	4	0,9	PFR6B	3500		PFR7B
146 i 16V Twin Spark L		1.8	103	02.97 - 12.01	AR67.106	4		BKR6EKPA + PMR7A	2513 +4259		
146 i. 16V Twin Spark		1.8	106	12.96 - 04.01	AR32.201	4		BKR6EKPA + PMR7A	2513 +4259		
146 TD		1.9	66	02.95 - 09.96	AR67 501	4		Y-924J	7906	1	
146 TD		1.9	66	10.96 - 09.97	AR33.601	4		Y-924J	7906	1	
146 JTD		1.9	77	11.99 - 01.01	AR32.302 dal n. motore 1716459 —>	4		Y-534J	3413	36	
146 JTD		1.9	77	02.99 - 10.99	AR32.302 fino a n. motore —>1716458	4		Y-747U	4694	26	
146 i. Twin Spark 16V- ti		2.0	110	02.96 - 04.01	AR67.204	4		BKR6EKPA + PMR7A	2513 +4259		
146 i 2.0 16V T.S.		2.0	114	03.98 - 12.01	AR32.301	4		BKR6EKPA + PMR7A	2513 +4259		

**147**

147 1.6 T.S. 16V 105CV		1.6	76	10.00 -	AR37.203	4		BKUR6ETB + CR7EKC	6992 +7004		
147 1.6 T.S. 16V		1.6	88	10.00 -	AR32.104	4		BKR6EKPA + PMR7A	2513 +4259		
147 1.9 JTD		1.9	74	11.00 - 05.03	182B9000	4		Y-534J	3413	36	
147 1.9 JTD		1.9	85	06.03 - 06.05	937A2000	4		Y-534J	3413	36	
147 1.9 JTDM		1.9	85	10.04 - 09.07	939A7000	4		Y1030J	90828	70	
147 1.9 JTDM 8V		1.9	88	07.05 -	937A3000	4		Y1030J	90828	70	
147 1.9 JTD 16V		1.9	93	09.03 - 05.05	937A4000	4		YE07	6092		

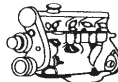

Code *l* kW

Cyl.



Stock-No.



LPG/CNG

**ALFA ROMEO****147**

147 1.9 JTD 16V		1.9	100	10.04 -	192B1000	4		YE07	6092		
147 1.9 JTD 16V		1.9	103	11.03 -	192A5000	4		YE07	6092		
147 1.9 JTD Mjet 16V		1.9	110	07.04 -	937A5000	4		YE07	6092		
147 2.0 T.S. 16V		2.0	110	10.00 -	AR 32310	4		BKR6EKPA + PMR7A	2513 +4259		
147 GTA		3.2	184	11.02 - 05.06	932A.000	6	0,9	PFR6B	3500		PFR7B

**155**

155 i.T.S.		1.7	86	02.92 - 04.93	AR67.103	4	0,7	BGP6ES	4930	17	LPG 3
155 i.T.S.		1.7	95	05.93 - 07.96	AR67.105	4	0,7	BGP6ES	4930	17	LPG 3
155 i.Twin Spark		1.8	93	02.92 - 07.96	AR67.102	4	0,7	BGP6ES	4930	17	LPG 3
155 i.T.S.		1.8	93	04.94 - 07.96	AR67.101-67.102	4	0,7	BGP6ES	4930	17	LPG 3
155 TD		1.9	68	04.93 - 04.96	AR67.501	4		Y-924J	7906	1	
155 TD		2.0	66	08.93 - 04.96	AR67.502	4		Y-924J	7906	1	
155 i.T.S.L		2.0	104	02.92 - 02.95	AR67.201-67.202	4	0,7	BGP6ES	4930	17	LPG 3
155 i.T.S.L		2.0	104	06.94 -		4	0,7	BGP6ES	4930	17	LPG 3
155 i.Twin Spark		2.0	106	02.92 - 02.95	AR67.202	4	0,7	BGP6ES	4930	17	LPG 3
155 i.16V T.S.		2.0	110	06.94 - 01.98	AR67.204	4		BKR6EKPA + PMR7A	2513 +4259		
155 i - Turbo- Turbo 4x4		2.0	137	08.92 - 04.98	AR67.203	4		BP6ET	1263		LPG 2
155 TD		2.5	92	04.93 - 04.95	VM 425 CLIEA	4		Y-924J	7906	1	
155 TD		2.5	92	05.95 - 10.97	VM 425 CLIEA	4		Y-741U	6943	20	
155 i.		2.5	120	02.92 -	AR67.301	6	0,8	BPR7ES	2023	19	BPR8EIX
155 i. V6		2.5	120	02.92 - 04.95	AR67.301	6	0,8	BPR7ES	2023	19	BPR8EIX
155 i. V6		2.5	120	05.95 - 02.97	AR67.301	6	0,7	BP6ES	7811	4	LPG 2

**156**

156 16V T.S.		1.6	88	12.97 - 05.06	AR32.101	4		BKR6EKPA + PMR7A	2513 +4259		
156 16V T.S.		1.8	106	12.97 - 05.06	AR32.201	4		BKR6EKPA + PMR7A	2513 +4259		
156 JTD		1.9	77	10.97 - 09.00	AR32.302	4		Y-747U	4694	26	
156 JTD		1.9	81	10.00 - 05.01	AR37.101	4		Y-534J	3413	36	
156 JTD		1.9	85	05.01 - 05	937A2000	4		Y-534J	3413	36	
156 1.9 JTD 16V		1.9	103	11.02 - 09.05	192A5000	4		YE07	6092		
156 1.9 JTD 16V		1.9	110	07.04 - 09.05	937A5000	4		YE07	6092		
156 16V T.S		2.0	114	12.97 - 12.02	AR32.301	4		BKR6EKPA + PMR7A	2513 +4259		
156 16V T.S. Selespeed		2.0	114	05.99 - 12.02	AR32.301	4		BKR6EKPA + PMR7A	2513 +4259		
156 JTS		2.0	121	11.01 - 05.06	937A.1000	4		BKR6EKPA	2513		
156 JTD		2.4	100	10.97 - 09.00	AR32.501	5		Y-747U	4694	26	
156 JTD		2.4	103	10.00 - 02.02	839A6000	5		Y-534J	3413	36	
156 JTD		2.4	110	03.02 - 01.04	841C000	5		Y-534J	3413	36	
156 1.9 JTD 20V		2.4	129	11.03 - 05.06	841G000	5		YE07	6092		
156 24V		2.5	140	10.97 - 05.06	AR32.401	6	0,9	PFR6B	3500		PFR7B
156 GTA		3.2	184	11.02 - 05.06	932A.000	6	0,9	PFR6B	3500		PFR7B

**159**

159 1750 Tbi	939	1.8	147	05.09 - 11.11	939B1000	4	0,6	ILKAR7D6G	93607		
159 1.9 JTDM 8V	939	1.9	85	09.05 - 11.11	937A7000 / 939A7000	4		Y1030J	90828	70	
159 1.9 JTDM 8V	939	1.9	88	09.05 - 11.11	939A1000	4		Y1030J	90828	70	

Code *l* kW

Cyl.



Stock-No.



LPG/CNG

**ALFA ROMEO****159**

159 1.9 JTDM 16V	939	1.9	100	09.05 - 12.10	937A8000 / 939A8000	4		YE07	6092		
159 1.9 JTDm 16V	939	1.9	110	07.05 - 11.11	939A2000	4		YE07	6092		
159 1.9 JTS 16V	939	1.9	118	07.05 - 11.11	939A6000	4		FR5CP	6368		
159 2.0 JTDM	939	2.0	100	06.10 - 11.11	939B4000	4		Y9003AS	94251	78	
159 2.0 JTDM	939	2.0	120	05.09 - 11.11	844A2000	4		Y9003AS	94251	78	
159 2.0 JTDM	939	2.0	125	03.09 - 11.11	939B3000	4		Y9003AS	94251	78	
159 2.2 JTS 16V	939	2.2	136	07.05 - 11.11	939A5000	4		FR5CP	6368		
159 2.4 JTDm 20V	939	2.4	147	12.05 - 04.07	939A3000	5		YE07	6092		
159 2.4 JTDm 20V	939	2.4	154	05.07 - 12.08	939A9000	5		YE07	6092		

**164**

164 i.T.S.		2.0	102	06.87 - 09.92	AR064.16Cat-064.20	4	0,7	BCP6ES	4930	17	LPG 3
164 i.T.S Super / Super L		2.0	106	07.94 - 10.98	AR67.201-67202	4	0,7	BCP6ES	4930	17	LPG 3
164 i.e. Turbo		2.0	126	01.88 - 09.92	AR064.76	4	0,8	BPR7ES	2023	19	BPR8EIX
164 i. V6 turbo Super		2.0	148	03.91 - 10.98	AR64.102	6	0,8	BP7ES	2412		BPR8EIX
164 i.		2.0		03.91 -			0,8	BP7ES	2412		BPR8EIX
164 TD		2.5	85	06.87 - 08.92	VM 84 A	4		Y-909R	4602		
164 TD Super		2.5	92	09.92 - 04.95	VM 425-SLIRA	4		Y-924J	7906	1	
164 TD		2.5	92	05.95 - 10.98	VM 425 SLIRA	4		Y-741U	6943	20	
164 i. V6 Super		3.0	132	01.96 -		6	0,7	PGR6A	4984		
164 i. V6 12V		3.0	138	01.90 - 10.98	AR64.305	6	0,7	BP6ES	7811	4	LPG 2
164 i. V6 24V CF2		3.0	155	01.87 - 92	AR64.301	6	0,7	PGR6A	4984		
164 i. V6 12V		3.0	155	92 - 10.98	AR66.301	6	0,9	PFR6B	3500		PFR7B
164 i. V6 24V Super		3.0	155	07.94 - 10.98	AR64.304-64.308	6	0,9	PFR6B	3500		PFR7B
164 i. V6 QV		3.0	169	- 10.98	AR16.102	6	0,7	PGR6A	4984		
164 i. Q.4		3.0	171	01.90 - 10.98	AR64.304	6	0,9	PFR6B	3500		PFR7B
164 12V		3.0		06.87 - 09.93	06410, 06412	6	0,7	B7ES	1111		BR8EIX

**166**

166 2.0 T.S. 16V		2.0	114	11.98 - 06.06	AR34.103	4		BKR6EKPA + PMR7A	2513 +4259		
166 2.0 TS		2.0	125	11.03 - 06.06	AR36301	4		BKR6EKPA + PMR7A	2513 +4259		
166 2.0 V6 Turbo Super;Prog.Distint.		2.0	151	11.98 - 06.06	AR34.102	6	0,8	BP6E	5637	4	LPG 2
166 24V V6 (Brazil)		2.0	151	10.98 - 06.06			0,9	PFR6B	3500		PFR7B
166 2.4 JTD		2.4	100	10.98 - 10.00	AR34.202	5		Y-747U	4694	26	
166 2.4 JTD		2.4	103	11.00 - 03.02	839A600	5		Y-534J	3413	36	
166 2.4 JTD		2.4	110	04.02 - 10.03	841C000	5		Y-534J	3413	36	
166 2.4 JTD		2.4	129	10.03 - 06.08	841G000 / 841H000	5		YE07	6092		
166 2.4 JTD Mjet 20V		2.4	132	07.06 - 06.08	936B000 / 841M000	5		YE07	6092		
166 2.4 JTD Mjet 20V		2.4	136	07.05 - 06.08	936B000 / 841M000	5		YE07	6092		
166 2.5 I V6 24V		2.5	140	11.98 - 06.06	AR34.201	6	0,9	PFR6B	3500		PFR7B
166 3.0 I V6 24V		3.0	162	11.98 - 06.06	AR34.301	6	0,9	PFR6B	3500		PFR7B
166 3.2 V6 24V		3.2	176	11.03 - 06.06	936A6000	6	0,9	PFR6B	3500		PFR7B

**BRERA**

Brera 1750 Tbi		1.8	147	03.09 - 03.11	939B1000	4	0,6	ILKAR7D6G	93607		
Brera 2.0 JTDM		2.0	120	03.08 - 12.11	844A2000	4		Y9003AS	94251	78	
Brera 2.0 JTDM		2.0	125	03.09 - 03.11	939B3000	4		Y9003AS	94251	78	
Brera 2.2 JTS		2.2	136	09.05 - 03.11	939A5000	4		FR5CP	6368		
Brera 2.4 JTDm 20V		2.4	147	01.06 - 03.11	939A3000	5		YE07	6092		

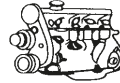
Code *l* kW

Cyl.

Stock-No.  
**VEFINE**  
E-FORPOWER

LPG/CNG

**ALFA ROMEO****GIULIETTA**

Giulietta 1.4 TB	940	1.4	77	04.11 -	940B1000	4	0,8	IKR9J8	93311		
Giulietta 1.4 TB	940	1.4	85	04.10 -	940A6000 / 198A6000	4	0,8	IKR9J8	93311		
Giulietta 1.4 TB	940	1.4	88	03.10 -	198A4000	4	0,8	IKR9J8	93311		
Giulietta 1.4 TB BiFuel	940	1.4	88	12.11 -	198A4000	4	0,8	IKR9J8	93311		
Giulietta 1.4 TB	940	1.4	120	04.10 -	955A8000	4	0,8	IKR9J8	93311		
Giulietta 1.4 TB	940	1.4	125	03.10 -	940A2000	4	0,8	IKR9J8	93311		
Giulietta 1,6 JTDM	940	1.6	77	03.10 -	940A3000	4		Y9003AS	94251	78	
Giulietta 1750 Tbi Quadrifoglio Verde	940	1.8	173	03.10 -	940A1000	4	0,6	ILKAR7D6G	93607		
Giulietta 2.0 JTDM	940	2.0	100	04.10 -	940A8000	4		Y9003AS	94251	78	
Giulietta 2.0 JTDM	940	2.0	103	04.10 -	940A5000	4		Y9003AS	94251	78	
Giulietta 2.0 JTDM	940	2.0	120	04.10 -	940A7000	4		Y9003AS	94251	78	
Giulietta 2.0 JTDM	940	2.0	125	03.10 -	940A4000	4		Y9003AS	94251	78	

**GT**

GT 1.8 16V TS		1.8	103	12.03 -	AR32205	4		BKR6EKPA	2513		
								+ PMR7A	+4259		
GT 1.9 JTDm 16V		1.9	110	12.03 -	937A5000	4		YE07	6092		
GT 1.9 JTDM 16V		1.9	125	05.08 -	937A6000	4		YE07	6092		
GT 2.0 JTS		2.0	121	12.03 -	937A1000	4		BKR6EKPA	2513		
GT		3.2	176	12.03 - 12.04	936A.6000	6	0,9	PFR6B	3500		PFR7B

**GTV**

GTV i 16V Twin Spark		1.8	106	06.98 - 06.02	AR32.201	4		BKR6EKPA	2513		
								+ PMR7A	+4259		
GTV T.S. 16V		2.0	110	04.95 - 05.98	AR16.201	4		BKR6EKPA	2513		
								+ PMR7A	+4259		
GTV 2.0 L Twin Spark -16V		2.0	110	06.98 -	AR32.301	4		BKR6EKPA	2513		
								+ PMR7A	+4259		
GTV 2.0 JTS 16V		2.0	121	06.03 -	937A.1000	4		BKR6EKPA	2513		
GTV V6 Turbo		2.0	147	04.95 - 05.98	AR16.202	6	0,8	BP7ES	2412		BPR8EIX
GTV 2.0 L V6 turbo L		2.0	148	06.98 - 12.99	AR16.202	6	0,9	BPR6E	6464	2	LPG 2
GTV V6 12V		2.0	151	09.97 - 12.00		6	0,8	BPR7ES	2023	19	BPR8EIX
GTV V6 24V- L		3.0	160	11.96 - 12.00	AR16.102	6	0,9	PFR6B	3500		PFR7B
GTV V6 24V		3.0	162	02.97 - 05.98	AR67.601	6	0,9	PFR6B	3500		PFR7B
GTV V6 24V		3.2	176	06.03 -	936A.6000	6	0,9	PFR6B	3500		PFR7B

**MITO**

MITO 0.9 Twin Air	955	0.9	63	07.11 -	312A2000	2	0,8	ILKR9G8	97168		
MITO 0.9 Twin Air	955	0.9	77	04.13 -	199B6000	2	0,8	ILKR9G8	97168		
MITO 1.3 JTDM 16V Eco	955	1.3	62	01.11 -	199B4000	4		Y9001AS	97719	72	
MITO 1.3 JTDM	955	1.3	66	08.08 - 12.11	199A3000	4		Y8003J	97256	62	
MITO 1.3 JTDM 16V	955	1.3	70	10.09 -	199B1000	4		Y9001AS	97719	72	
MITO 1.4	955	1.4	51	05.11 -	955A9000	4	1,0	ZKR7A-10	1691		LPG 8
MITO 1.4	955	1.4	57	03.11 -	350A1000	4	1,0	ZKR7A-10	1691		LPG 8
MITO 1.4	955	1.4	58	09.08 -	955A1000	4	1,0	ZKR7A-10	1691		LPG 8
MITO 1.4	955	1.4	70	09.08 -	199A6000	4	1,0	ZKR7A-10	1691		LPG 8
MITO 1.4 16V Multiair	955	1.4	77	10.09 -	955A6000	4	1,0	DCPR7E-N-10	4983		LPG 8
MITO 1.4 T-Jet	955	1.4	88	09.08 -	198A4000	4	0,8	IKR9J8	93311		
MITO 1.4 T-Jet Bifuel LPG	955	1.4	88	10.09 -	198A4000	4	0,8	IKR9J8	93311		
MITO 1.4 TB 16V Multiair	955	1.4	99	08.09 -	955A2000 / 955A7000	4	0,8	IKR9J8	93311		
MITO 1.4 T-Jet	955	1.4	110	09.08 - 06.11	198A1000	4	0,8	IKR9J8	93311		
MITO 1.4 TB	955	1.4	114	09.08 -	199A8000	4	0,8	IKR9J8	93311		

Code *l* kW

Cyl.



Stock-No.



LPG/CNG

**ALFA ROMEO****MITO**

MITO 1.4 TB	955	1.4	120	10.09 -	955A8000	4	0,8	IKR9J8	93311		
MITO 1.4 TB	955	1.4	125	12.09 -	940A2000	4	0,8	IKR9J8	93311		
MITO 1.6 JTDM 16V	955	1.6	85	08.08 -	955A4000	4	<input checked="" type="checkbox"/>	Y9003AS	94251	78	
MITO 1.6 JTDM 16V	955	1.6	88	08.08 -	955A3000	4	<input checked="" type="checkbox"/>	Y9003AS	94251	78	

**SPIDER**

Spider 16V T.S.		1.8	106	05.98 - 03.01	AR32.201	4		BKR6EKPA	2513		
								+ PMR7A	+4259		
Spider 1750 TBi		1.8	147	03.09 -	939B1000	4	0,6	ILKAR7D6G	93607		
Spider i.		2.0	86	01.90 - 12.94	AR015.44-88-90 Cat.	4	0,7	BP6ES	7811	4	LPG 2
Spider 16V T.S.		2.0	110	04.95 - 05.98	AR16.201	4		BKR6EKPA	2513		
								+ PMR7A	+4259		
Spider 16V T.S.		2.0	114	06.98 -	AR32.301	4		BKR6EKPA	2513		
								+ PMR7A	+4259		
Spider 2.0 JTDM		2.0	120	04.09 - 12.11	844A2000	4	<input checked="" type="checkbox"/>	Y9003AS	94251	78	
Spider 2.0 JTS 16V		2.0	121	06.03 -	937A.1000	4		BKR6EKPA	2513		
Spider 2.0 JTDM		2.0	125	03.09 - 12.11	939B3000	4	<input checked="" type="checkbox"/>	Y9003AS	94251	78	
Spider i V6 turbo		2.0	147	06.98 - 12.99	AR16.202	6	0,9	BPR6E	6464	2	LPG 2
Spider 2.2 JTS		2.2	136	01.06 -	939A5000	4		FR5CP	6368		
Spider 2.4 JTDm		2.4	147	02.06 -	939A3000	5	<input checked="" type="checkbox"/>	YE07	6092		
Spider 2.4 JTDm		2.4	154	03.08 -	939A9000	5	<input checked="" type="checkbox"/>	YE07	6092		
Spider i V6 12V		3.0	140	04.95 - 05.98	AR16.101-16.199	6	0,8	BPR6ES	7822	2	LPG 2
Spider 3.0 V6 24V		3.0	165	06.98 - 04	AR16.102	6	0,9	PFR6B	3500		PFR7B
Spider 3.2 V6 24V		3.2	176	06.03 -	936A6000	6	0,9	PFR6B	3500		PFR7B

**SZ**

SZ V6 / RZ V6		3.0	152	03.90 - 05.96	AR64.304	6	0,7	PGR6A	4984		
---------------	--	-----	-----	---------------	----------	---	-----	-------	------	--	--

**ALPINA****B 3**

B 3	E36	E36	3.0	184	04.93 - 03.96	M50B30	6		BKR6EK	2288	20	LPG 1
B 3	E36	E36	3.2	195	04.96 - 03.99	S52B32	6		BKR6EK	2288	20	LPG 1
B 3 3.2	E36 Cabrio	E36	3.2	195	04.96 - 03.99	S52B32	6		BKR6EK	2288	20	LPG 1
B 3 3.3	E46	E46	3.3	206	03.99 - 01.05	S52B33	6		BKR6EQUP	3199	30	LPG 1
B 3 S	E46	E46	3.3	224	08.02 - 01.06	S52B33	6		BKR6EQUP	3199	30	LPG 1

**B 5**

B 5	E60	E60	4.4	368	03.05 -	S62B44 H1/2	8	0,6	PFR7B	4853		
B 5 Biturbo	F10	F10	4.4	373	10 -	M1	8	0,8	SIZKBR8A8HS	1555		
B 5 S	E60	E60	4.4	390	07 -	S62B44 H1/2	8	0,6	PFR7B	4853		

**B 6**

B 6	E64 Cabrio	E64	4.4	368	10.05 -	S62B44 H1/2	8	0,6	PFR7B	4853		
B 6 S	E64 Cabrio	E64	4.4	390	07 -	S62B44 H1/2	8	0,6	PFR7B	4853		

**B 7**

B 7	E65	E65	4.4	368	03.05 -	S62B44 H1/2	8	0,6	PFR7B	4853		
B 7 Biturbo	F01	F01	4.4	373	05.09 -	M1	8	0,8	SIZKBR8A8HS	1555		

**B 8**

B 8	E36	E36	4.6	245	01.95 - 11.98	M62B46	8		BKR6EK	2288	20	LPG 1
-----	-----	-----	-----	-----	---------------	--------	---	--	--------	------	----	-------

**B10**

B 10 3.2	E39	E39	3.2	191	08.97 - 12.98	S52B32	6		BKR6EK	2288	20	LPG 1
----------	-----	-----	-----	-----	---------------	--------	---	--	--------	------	----	-------



Code *l* kW

Cyl.



Stock-No.

**ALPINA****B 10**

B 10 3.3	E39	E39	3.3	206	02.99 - 10.03	S52B33	6		BKR6EQU	3199	30	LPG 1
B 10 3.5	E34	E34	3.5	187	04.88 - 12.92	B11/3	6	0,8	BPR6ES	7822	2	LPG 2
B 10 3.5	E34 Biturbo	E34	3.5	265	08.89 - 03.94	B7/5	6	0,8	BPR6ES	7822	2	LPG 2
B 10 4.0	E34	E34	4.0	232	04.93 - 08.95	F1	8		BKR6EQU	3199	30	LPG 1
B 10 4.6	E34	E34	4.6	250	03.94 - 04.96	F2	8		BKR6EQU	3199	30	LPG 1
B 10 V8	E39	E39	4.6	250	12.96 - 10.98	M62B46	8		BKR6EK	2288	20	LPG 1
B 10 V8	E39	E39	4.6	255	10.98 - 08.00	M62B46	8		BKR6EQU	3199	30	LPG 1
B 10 V8S	E39	E39	4.8	276	01.02 - 12.03	M62B48	8		BKR6EQU	3199	30	LPG 1

**B 12**

B 12	E38 5.7 E-Kat	E38	5.7	285	12.95 - 09.98	M73B57	12		BKR6EK	2288	20	LPG 1
B 12	E38 6.0 E-Kat	E38	6.0	316	06.99 - 07.01	M73B60	12		BKR6EQU	3199	30	LPG 1

**D 3**

D 3	E90	E90	2.0	147	02.07 -	N47D20 L1	4		Y-547AS	5968	47	
-----	-----	-----	-----	-----	---------	-----------	---	--	---------	------	----	--

**ROADSTER**

Roadster S	E85	E85	3.4	221	07.03 - 12.05	E5/2	6		BKR6EQU	3199	30	LPG 1
Roadster V8	E52	E52	4.8	280	06.02 - 10.03	S62 B48	8		BKR6EQU	3199	30	LPG 1

**ARO**

Spartana			1.2	40	97 -	C3GD7	4	0,9	BP5ESZ	4691		LPG 2
----------	--	--	-----	----	------	-------	---	-----	--------	------	--	-------

**ASIA MOTORS**

Rocsta			1.8	57	02.94 - 12.97	F8	4	0,9	BPR5ES	7422	6	LPG 2
Rocsta			2.2		03.94 - 12.97	R2	4		Y-107R	1229		

**ASTON MARTIN**

DB7			3.2	250	09.94 - 06.99	DOHC	6	0,8	BCPR7ES	3330		BCPR7EIX
DB7			5.9		07.99 - 11.00	DOHC	12	1,3	PTR6D-13	5598		LPG 5
DB7			5.9		11.00 -	DOHC	12	1,3	PTR5D-13	6644		
Turbo 24V Coupé, Cabriolet			3.2	246	95 -		6	0,7	BCPR7ES	3330		BCPR7EIX
48V V12			6.0	420	04.00 -		12	1,0	PTR5D-10	3784	31	LPG 5
Vanquish			5.9		06.01 -	AM 702	12	1,3	PTR6D-13	5598		LPG 5
Vantage			5.3	410	08.93 -	10.2:1Comp(Zagato)	8	0,8	BCR8ES	5430		
Virage / Volante			5.3		02.90 - 01.98	V8 32V	8	0,8	BCPR6E	1269	12	LPG 3

**AUDI****80 4**

80 (4) 1.6	B4		1.6	52	08.91 - 06.94	ABM	4		BUR5ET	3377	22	LPG 2
80 (4) 1.6	B4		1.6	74	06.93 - 07.95	ADA	4		BUR6ET	3172	1	LPG 2
80 (4) 1.9 TD	B4		1.9	55	09.91 - 07.95	AAZ	4		Y-918J	6285	2	
80 (4) 1.9 TDI	B4		1.9	66	09.91 - 07.95	1Z	4		Y-732J	5605	4	
80 (4) 2.0	B4		2.0	66	09.91 - 06.95	ABT	4		BUR6ET	3172	1	LPG 2
80 (4) 2.0 E	B4		2.0	85	09.91 - 07.95	ABK	4		BUR6ET	3172	1	LPG 2
80 (4) 2.0 E 16V	B4		2.0	103	08.92 - 07.95	ACE	4		BKUR7ET	7873		
80 (4) 2.3 E	B4		2.3	98	09.91 - 12.94	NG	5		BPR5EKU	5685		LPG 2
80 (4) 2.6 E	B4		2.6	110	07.92 - 07.95	ABC	6		BKUR6ET-10	2397	24	LPG 1
80 (4) 2.8 E	B4		2.8	128	09.91 - 07.95	AAH	6		BKUR6ET-10	2397	24	LPG 1
80 (4) S2 quattro	B4		2.2	169	02.93 - 07.95	ABY	5	0,6	PFR7B	4853		

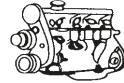
Code *l* kW

Cyl.



Stock-No.



10-15-20-25-30-35-40-45-50-55-60-65-70-75-80-85-90-95-100-105-110-115-120-125-130-135-140-145-150-155-160-165-170-175-180-185-190-195-200-205-210-215-220-225-230-235-240-245-250-255-260-265-270-275-280-285-290-295-300-305-310-315-320-325-330-335-340-345-350-355-360-365-370-375-380-385-390-395-400-405-410-415-420-425-430-435-440-445-450-455-460-465-470-475-480-485-490-495-500-505-510-515-520-525-530-535-540-545-550-555-560-565-570-575-580-585-590-595-600-605-610-615-620-625-630-635-640-645-650-655-660-665-670-675-680-685-690-695-700-705-710-715-720-725-730-735-740-745-750-755-760-765-770-775-780-785-790-795-800-805-810-815-820-825-830-835-840-845-850-855-860-865-870-875-880-885-890-895-900-905-910-915-920-925-930-935-940-945-950-955-960-965-970-975-980-985-990-995-1000

LPG/CNG

**AUDI****80 4**

80 (4) avant RS2 quattro	B4	2.2	232	03.94 - 07.95	ADU	5	0,6	PFR7B	4853		
--------------------------	----	-----	-----	---------------	-----	---	-----	-------	------	--	--

**100 4**

100 (4) 2.0	4A/C4	2.0	74	12.90 - 07.94	AAE	4		BUR6ET	3172	1	LPG 2
100 (4) 2.0 E	4A/C4	2.0	85	12.90 - 12.92	AAD	4		BUR6ET	3172	1	LPG 2
100 (4) 2.0 E	4A/C4	2.0	85	01.93 - 07.94	ABK	4		BUR6ET	3172	1	LPG 2
100 (4) 2.0 E 16V	4A/C4	2.0	103	01.92 - 07.94	ACE	4		BKUR7ET	7873		
100 (4) 2.2 S4 quattro	4A/C4	2.2	169	08.91 - 07.94	AAN	5	0,6	PFR7B	4853		
100 (4) 2.3 E	4A/C4	2.3	98	12.90 - 06.94	AAR	5		BPR5EKU	5685		LPG 2
100 (4) 2.4 D	4A/C4	2.4	60	12.90 - 07.94	AAS	5	☑	Y-918J	6285	2	
100 (4) 2.5 TDI	4A/C4	2.5	85	12.90 - 07.94	AAT	5	☑	Y-732J	5605	4	
100 (4) 2.5 TDI	4A/C4	2.5	85	12.90 - 07.92	ABP	5	☑	Y-732J	5605	4	
100 (4) 2.6 E	4A/C4	2.6	110	03.92 - 07.94	ABC	6		BKUR6ET-10	2397	24	LPG 1
100 (4) 2.8 E	4A/C4	2.8	128	12.90 - 07.94	AAH	6		BKUR6ET-10	2397	24	LPG 1
100 (4) 4.2 V8 S4 quattro	4A/C4	4.2	206	10.92 - 07.94	ABH	8	0,8	BUR6EFSZ	6837		
100 (4) 4.2 V8 S4 quattro	4A/C4	4.2	213	03.94 - 06.94	AEC	8	0,8	BUR6EFSZ	6837		

**A 1**

A 1 1.2 TFSI	8X1/8XA	1.2	63	05.10 -	CBZA	4	0,7	IZFR6P7	97153		
A 1 1.4 TFSI	8X1/8XA	1.4	90	05.10 -	CAXA	4	0,9	PZFR6R	5758		
A 1 1.4 TFSI COD	8X1/8XA	1.4	103	04.12 -	CPTA	4	0,8	PZKER7A8EGS	94968		
A 1 1.4 TFSI	8X1/8XA	1.4	136	11.10 -	CAVG	4	0,8	SIZFR6B8EG	96209		
A 1 1.6 TDI	8X1/8XA	1.6	66	11.10 -	CAYB	4	☑	Y1002AS	8888	57	
A 1 1.6 TDI	8X1/8XA	1.6	77	05.10 -	CAYC	4	☑	Y1002AS	8888	57	
A 1 2.0 TDI	8X1/8XA	2.0	100	05.12 -	CFHB	4	☑	Y1002AS	8888	57	
A 1 2.0 TDI	8X1/8XA	2.0	105	08.11 -	CFHD	4	☑	Y1002AS	8888	57	
A 1 quattro 2.0 TFSI	8X1	2.0	188	03.12 -	CDLH	4	0,8	PFR7S8EG	1675		PFR8S8EG

**A 2**

A 2 1.2 TDI	8Z0	1.2	45	03.01 - 08.05	ANY	3	☑	Y-741U	6943	20	
A 2 1.4	8Z0	1.4	55	06.00 - 04.02	AUA	4		BKUR6ET-10	2397	24	LPG 1
A 2 1.4	8Z0	1.4	55	05.02 - 08.05	BBY	4		BKUR6ET-10	2397	24	LPG 1
A 2 1.4 TDI	8Z0	1.4	55	06.00 - 08.03	AMF	3	☑	Y-741U	6943	20	
A 2 1.4 TDI	8Z0	1.4	55	09.03 - 08.05	BHC	3	☑	Y-741U	6943	20	
A 2 1.4 TDI	8Z0	1.4	66	11.03 - 08.05	ATL	3	☑	Y-607AS	7560	50	
A 2 1.6 FSI	8Z0	1.6	81	05.02 - 08.05	BAD	4		ZFR6S-Q	6449		

**A 3 1**

A 3 (1) 1.6	8L1	1.6	74	09.96 - 06.01	AEH	4		BKUR6ET-10	2397	24	LPG 1
A 3 (1) 1.6	8L1	1.6	74	08.97 - 06.03	AKL	4		BKUR6ET-10	2397	24	LPG 1
A 3 (1) 1.6	8L1	1.6	74	06.99 - 08.00	APF	4		BKUR6ET-10	2397	24	LPG 1
A 3 (1) 1.6	8L1	1.6	75	05.00 - 04.02	AVU	4		BKUR6ET-10	2397	24	LPG 1
A 3 (1) 1.6	8L1	1.6	75	05.02 - 06.03	BFQ	4		BKUR6ET-10	2397	24	LPG 1
A 3 (1) 1.8	8L1	1.8	92	09.96 - 08.00	AGN	4		BKUR6ET-10	2397	24	LPG 1
A 3 (1) 1.8	8L1	1.8	92	11.99 - 06.03	APG	4		BKUR6ET-10	2397	24	LPG 1
A 3 (1) 1.8 T	8L1	1.8	110	12.96 - 06.03	AGU	4	0,8	PFR6Q	6458	37	LPG 1
A 3 (1) 1.8 T	8L1	1.8	110	08.98 - 04.01	AQA	4	0,8	PFR6Q	6458	37	LPG 1
A 3 (1) 1.8 T	8L1	1.8	110	07.99 - 04.00	ARZ	4	0,8	PFR6Q	6458	37	LPG 1
A 3 (1) 1.8 T	8L1	1.8	110	09.00 - 06.03	ARX	4	0,8	PFR6Q	6458	37	LPG 1
A 3 (1) 1.8 T	8L1	1.8	110	05.00 - 06.03	AUM	4	0,8	PFR6Q	6458	37	LPG 1
A 3 (1) 1.8 T	8L1	1.8	132	11.98 - 08.00	AJQ	4	0,8	PFR6Q	6458	37	LPG 1
A 3 (1) 1.8 T	8L1	1.8	132	07.99 - 05.00	APP	4	0,8	PFR6Q	6458	37	LPG 1
A 3 (1) 1.8 T	8L1	1.8	132	09.00 - 06.03	ARY	4	0,8	PFR6Q	6458	37	LPG 1
A 3 (1) 1.8 T	8L1	1.8	132	05.00 - 06.03	AUQ	4	0,8	PFR6Q	6458	37	LPG 1
A 3 (1) 1.9 TDI	8L1	1.9	66	09.96 - 08.00	AGR	4	☑	Y-732J	5605	4	

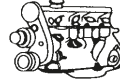
Code *l* kW

Cyl.



Stock-No.

V-TIME  
E-POWER  
LPG/CNG**AUDI****A 3 1**

A 3 (1) 1.9 TDI	8L1	1.9	66	08.97 - 06.01	ALH	4	☑	Y-732J	5605	4	
A 3 (1) 1.9 TDI	8L1	1.9	81	01.97 - 04.02	AHF	4	☑	Y-732J	5605	4	
A 3 (1) 1.9 TDI	8L1	1.9	81	09.99 - 06.01	ASV	4	☑	Y-732J	5605	4	
A 3 (1) 1.9 TDI Fgst → 8L-2-037-877	8L1	1.9	74	01.01 - 06.03	ATD	4	☑	Y-732J	5605	4	
A 3 (1) 1.9 TDI Fgst → 8L-2-037-877	8L1	1.9	74	11.01 - 06.03	AXR	4	☑	Y-732J	5605	4	
A 3 (1) 1.9 TDI Fgst → 8L-2-037-877	8L1	1.9	96	05.00 - 06.03	ASZ	4	☑	Y-732J	5605	4	
A 3 (1) 1.9 TDI Fgst 8L-2-037-878 →	8L1	1.9	74	01.01 - 06.03	ATD	4	☑	Y-741U	6943	20	
A 3 (1) 1.9 TDI Fgst 8L-2-037-878 →	8L1	1.9	74	11.01 - 06.03	AXR	4	☑	Y-741U	6943	20	
A 3 (1) 1.9 TDI Fgst 8L-2-037-878 →	8L1	1.9	96	05.00 - 06.03	ASZ	4	☑	Y-741U	6943	20	
A 3 (1) S 3	8L1	1.8	154	11.98 - 08.00	APY	4	0,8	PFR6Q	6458	37	LPG 1
A 3 (1) S 3	8L1	1.8	154	09.99 - 04.01	AUL	4	0,8	PFR6Q	6458	37	LPG 1
A 3 (1) S 3	8L1	1.8	154	09.00 - 04.02	AMK	4	0,8	PFR6Q	6458	37	LPG 1
A 3 (1) S 3	8L1	1.8	165	08.01 - 06.03	BAM	4	0,8	PFR6Q	6458	37	LPG 1

**A 3 2**

A 3 (2) 1.2 TFSI	8P1/8PA	1.2	77	03.10 - 08.12	CBZB	4	0,7	IZFR6P7	97153		
A 3 (2) 1.4 TFSI	8P1/8PA	1.4	92	09.07 - 08.12	CAXC	4	0,9	PZFR6R	5758		
A 3 (2) 1.4 TFSI	8P1/8PA	1.4	92	05.10 - 08.12	CMSA	4	0,9	PZFR6R	5758		
A 3 (2) 1.6	8P1/8PA	1.6	75	05.03 - 05.05	BGU	4		BKUR6ET-10	2397	24	LPG 1
A 3 (2) 1.6	8P1/8PA	1.6	75	06.05 - 08.12	BSE	4		BKUR6ET-10	2397	24	LPG 1
A 3 (2) 1.6	8P1/8PA	1.6	75	06.05 - 08.12	BSF	4		BKUR6ET-10	2397	24	LPG 1
A 3 (2) 1.6	8P1/8PA	1.6	75	07.08 - 08.12	CCSA	4		BKUR6ET-10	2397	24	LPG 1
A 3 (2) 1.6	8P1/8PA	1.6	75	05.10 - 08.12	CMXA	4		BKUR6ET-10	2397	24	LPG 1
A 3 (2) 1.6 FSI	8P1	1.6	85	08.03 - 05.04	BAG	4		ZFR6S-Q	6449		
A 3 (2) 1.6 FSI	8P1/8PA	1.6	85	06.04 - 12.04	BLP	4		ZFR6S-Q	6449		
A 3 (2) 1.6 FSI	8P1/8PA	1.6	85	01.05 - 05.07	BLF	4		ZFR6S-Q	6449		
A 3 (2) 1.6 TDI	8P1/8PA	1.6	66	05.09 - 08.12	CAYB	4	☑	Y1002AS	8888	57	
A 3 (2) 1.6 TDI	8P1/8PA	1.6	77	05.09 - 08.12	CAYC	4	☑	Y1002AS	8888	57	
A 3 (2) 1.8 TFSI	8P1/8PA	1.8	118	01.07 - 05.07	BYT	4	0,8	PFR7S8EG	1675		PFR8S8EG
A 3 (2) 1.8 TFSI	8P1/8PA	1.8	118	06.07 - 05.08	BZB	4	0,8	PFR7S8EG	1675		PFR8S8EG
A 3 (2) 1.8 TFSI	8P1/8PA	1.8	118	07.08 - 08.12	CDAA	4	0,8	PFR7S8EG	1675		PFR8S8EG
A 3 (2) 1.9 TDI	8P1/8PA	1.9	77	06.03 - 05.06	BKC	4	☑	Y-607AS	7560	50	
A 3 (2) 1.9 TDI	8P1/8PA	1.9	77	10.05 - 05.07	BLS	4	☑	Y-607AS	7560	50	
A 3 (2) 1.9 TDI	8P1/8PA	1.9	77	06.06 - 05.10	BXE	4	☑	Y-607AS	7560	50	
A 3 (2) 2.0 FSI	8P1	2.0	110	05.03 - 05.04	AXW	4		PZFR5N-11T	7742		
A 3 (2) 2.0 FSI	8P1/8PA	2.0	110	06.04 - 01.05	BLX	4		PZFR5N-11T	7742		
A 3 (2) 2.0 FSI	8P1/8PA	2.0	110	06.04 - 11.05	BLY	4	0,9	BKR6E	6962	28	LPG 1
A 3 (2) 2.0 FSI	8P1/8PA	2.0	110	01.04 - 01.05	BMB	4	0,9	BKR6E	6962	28	LPG 1
A 3 (2) 2.0 FSI	8P1/8PA	2.0	110	01.05 - 11.05	BLR	4		PZFR5N-11T	7742		
A 3 (2) 2.0 FSI	8P1/8PA	2.0	110	11.05 - 01.07	BVY	4		PZFR5N-11T	7742		
A 3 (2) 2.0 FSI	8P1/8PA	2.0	110	11.05 - 06.08	BVZ	4	0,9	BKR6E	6962	28	LPG 1
A 3 (2) 2.0 TDI	8P1/8PA	2.0	100	05.03 - 05.07	AZV	4	☑	YE14	7768	48	
A 3 (2) 2.0 TDI	8P1/8PA	2.0	100	04.08 - 05.10	CBAA	4	☑	Y-609AS	5849	49	
A 3 (2) 2.0 TDI	8P1/8PA	2.0	100	11.09 - 08.12	CFFA	4	☑	Y1002AS	8888	57	
A 3 (2) 2.0 TDI	8P1/8PA	2.0	103	05.03 - 05.07	BKD	4	☑	YE14	7768	48	
A 3 (2) 2.0 TDI bis Fgst.-Nr. 8P-6A138000 und bis 8P-6B019000	8P1/8PA	2.0	103	02.05 - 06.08	BMM	4	☑	CZ104	9826	52	
A 3 (2) 2.0 TDI ab Fgst.-Nr. 8P-6A138001 und bis 8P-6B019001	8P1/8PA	2.0	103	02.05 - 06.08	BMM	4	☑	Y-607AS	7560	50	
A 3 (2) 2.0 TDI	8P1/8PA	2.0	103	04.08 - 05.10	CBAB	4	☑	Y-609AS	5849	49	
A 3 (2) 2.0 TDI	8P1/8PA	2.0	103	11.09 - 08.12	CFFB	4	☑	Y1002AS	8888	57	
A 3 (2) 2.0 TDI	8P1/8PA	2.0	103	02.10 - 08.12	CLJA	4	☑	Y1002AS	8888	57	

Fgst = Chassis No.

Code *l* kW

Cyl.



Stock-No.



LPG/CNG

**AUDI****A 3 2**

A 3 (2) 2.0 TDI	8P1/8PA	2.0	120	06.06 - 05.07	BUY	4	█	CZ304	9864	55	
A 3 (2) 2.0 TDI	8P1/8PA	2.0	125	03.06 - 08.12	BMN	4	█	CZ304	9864	55	
A 3 (2) 2.0 TDI	8P1/8PA	2.0	125	07.08 - 05.10	CBBB	4	█	Y-609AS	5849	49	
A 3 (2) 2.0 TDI	8P1/8PA	2.0	125	05.10 - 08.12	CFGB	4	█	Y1002AS	8888	57	
A 3 (2) 2.0 TFSI	8P1/8PA	2.0	147	09.04 - 10.05	AXX	4	0,8	PFR7S8EG	1675		PFR8S8EG
A 3 (2) 2.0 TFSI	8P1/8PA	2.0	147	09.05 - 08.12	BWA	4	0,8	PFR7S8EG	1675		PFR8S8EG
A 3 (2) 2.0 TFSI	8P1/8PA	2.0	147	07.08 - 08.12	CBFA	4	0,8	PFR7S8EG	1675		PFR8S8EG
A 3 (2) 2.0 TFSI	8P1/8PA	2.0	147	07.08 - 08.12	CCZA	4	0,8	PFR7S8EG	1675		PFR8S8EG
A 3 (2) 2.0 TFSI	8P1/8PA	2.0	147	02.08 - 01.09	CAWB	4	0,8	PFR7S8EG	1675		PFR8S8EG
A 3 (2) 3.2 quattro	8P1	3.2	184	07.03 - 08.04	BDB	6	0,9	IZKR7B	7563		
A 3 (2) 3.2 quattro	8P1/8PA	3.2	184	09.04 - 10.05	BMJ	6	0,9	IZKR7B	7563		
A 3 (2) 3.2 quattro	8P1/8PA	3.2	184	11.05 - 05.09	BUB	6	0,9	IZKR7B	7563		
A 3 (2) S 3	8P1	2.0	188	02.07 - 08.12	BZC	4	0,8	PFR7S8EG	1675		PFR8S8EG
A 3 (2) S 3	8P1/8PA	2.0	188	07.08 - 08.12	CDLC	4	0,8	PFR7S8EG	1675		PFR8S8EG
A 3 (2) S 3	8P1/8PA	2.0	195	11.06 - 05.07	BHZ	4	0,8	PFR7S8EG	1675		PFR8S8EG
A 3 (2) S 3	8P1/8PA	2.0	195	07.08 - 08.12	CDLA	4	0,8	PFR7S8EG	1675		PFR8S8EG

**A 3 3**

A 3 (3) 1.2 TFSI	8V1/8VA	1.2	77	09.12 -	CJZA	4	0,8	PZKER7A8EGS	94968		
A 3 (3) 1.4 TFSI	8V1/8VA	1.4	90	04.12 -	CMBA	4	0,8	PZKER7A8EGS	94968		
A 3 (3) 1.4 TFSI COD	8V1/8VA/8VS	1.4	103	10.12 -	CPTA	4	0,8	PZKER7A8EGS	94968		
A 3 (3) 1.6 TDI	8V1/8VA	1.6	77	09.12 -	CLHA	4	█	Y1002AS	8888	57	
nur für Zylinder ohne Drucksensor											
A 3 (3) 2.0 TDI	8V1/8VA/8VS	2.0	81	01.13 -	CRFA	4	█	Y1002AS	8888	57	
nur für Zylinder ohne Drucksensor											
A 3 (3) 2.0 TDI	8V1/8VA/8VS	2.0	100	05.13 -	CRBD	4	█	Y1002AS	8888	57	
nur für Zylinder ohne Drucksensor											
A 3 (3) 2.0 TDI	8V1/8VA	2.0	105	09.12 -	CRFC	4	█	Y1002AS	8888	57	
nur für Zylinder ohne Drucksensor											
A 3 (3) 2.0 TDI	8V1/8VA/8VS	2.0	110	04.12 -	CRBC	4	█	Y1002AS	8888	57	
nur für Zylinder ohne Drucksensor											
A 3 (3) 2.0 TDI	8V1/8VA/8VS	2.0	110	04.12 -	CRLB	4	█	Y1002AS	8888	57	
nur für Zylinder ohne Drucksensor											
A 3 (3) 2.0 TDI	8V1/8VA	2.0	135	12.12 -	CUPA	4	█	Y1002AS	8888	57	
nur für Zylinder ohne Drucksensor											

**A 4 1**

A 4 (1) 1.6	8D2/8D5 B5	1.6	74	11.94 - 10.96	ADP	4		BKUR6ET-10	2397	24	LPG 1
A 4 (1) 1.6	8D2/8D5 B5	1.6	74	10.96 - 07.99	AHL	4		BKUR6ET-10	2397	24	LPG 1
A 4 (1) 1.6	8D2/8D5 B5	1.6	74	08.98 - 06.00	ANA	4		BKUR6ET-10	2397	24	LPG 1
A 4 (1) 1.6	8D2/8D5 B5	1.6	74	08.98 - 09.01	ARM	4		BKUR6ET-10	2397	24	LPG 1
A 4 (1) 1.6	8D2/8D5 B5	1.6	75	07.00 - 11.00	ALZ	4		BKUR6ET-10	2397	24	LPG 1
A 4 (1) 1.8	8D2/8D5 B5	1.8	85	07.95 - 12.98	AFY	4		BKUR6ET-10	2397	24	LPG 1
A 4 (1) 1.8	8D2/8D5 B5	1.8	92	11.94 - 04.99	ADR	4		BKUR6ET-10	2397	24	LPG 1
A 4 (1) 1.8	8D2/8D5 B5	1.8	92	07.98 - 09.01	ARG	4		BKUR6ET-10	2397	24	LPG 1
A 4 (1) 1.8	8D2/8D5 B5	1.8	92	02.99 - 09.01	APT	4		BKUR6ET-10	2397	24	LPG 1
A 4 (1) 1.8	8D2/8D5 B5	1.8	92	06.00 - 09.01	AVV	4		BKUR6ET-10	2397	24	LPG 1
A 4 (1) 1.8 T	8D2/8D5 B5	1.8	110	01.96 - 12.98	AEB	4	0,8	PFR6Q	6458	37	LPG 1
A 4 (1) 1.8 T	8D2/8D5 B5	1.8	110	08.98 - 09.01	APU	4	0,8	PFR6Q	6458	37	LPG 1
A 4 (1) 1.8 T	8D2/8D5 B5	1.8	110	07.98 - 07.99	ARK	4	0,8	PFR6Q	6458	37	LPG 1
A 4 (1) 1.8 T	8D2/8D5 B5	1.8	110	05.99 - 06.00	ANB	4	0,8	PFR6Q	6458	37	LPG 1
A 4 (1) 1.8 T	8D2/8D5 B5	1.8	110	06.00 - 09.01	AWT	4	0,8	PFR6Q	6458	37	LPG 1

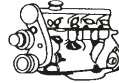

Code *l* kW

Cyl.

Stock-No.  
**VEMO**  
BY-POMPEL\*\*

LPG/CNG

**AUDI****A 4 1**

A 4 (1) 1.8 T	8D2/8D5 B5	1.8	132	08.97 - 09.01	AJL	4	0,8	PFR6Q	6458	37	LPG 1
A 4 (1) 1.8 T USA	8D2/8D5 B5	1.8	110	08.99 - 05.00	ATW	4	0,8	PFR6Q	6458	37	LPG 1
A 4 (1) 1.9 TDI	8D2/8D5 B5	1.9	55	03.96 - 06.00	AFF	4	▣	Y-732J	5605	4	
A 4 (1) 1.9 TDI	8D2/8D5 B5	1.9	66	11.94 - 07.96	1Z	4	▣	Y-732J	5605	4	
A 4 (1) 1.9 TDI	8D2/8D5 B5	1.9	66	08.96 - 06.00	AHU	4	▣	Y-732J	5605	4	
A 4 (1) 1.9 TDI	8D2/8D5 B5	1.9	66	04.97 - 09.01	AHH	4	▣	Y-732J	5605	4	
A 4 (1) 1.9 TDI	8D2/8D5 B5	1.9	81	02.96 - 07.99	AFN	4	▣	Y-732J	5605	4	
A 4 (1) 1.9 TDI	8D2/8D5 B5	1.9	81	08.99 - 06.00	AVG	4	▣	Y-732J	5605	4	
A 4 (1) 1.9 TDI	8D2/8D5 B5	1.9	85	08.98 - 09.01	AJM	4	▣	Y-732J	5605	4	
A 4 (1) 1.9 TDI	8D2/8D5 B5	1.9	85	01.00 - 09.01	ATJ	4	▣	Y-732J	5605	4	
A 4 (1) 2.4 V6	8D2/8D5 B5	2.4	120	08.97 - 07.98	AJG	6		BKR6EKUB	3584		LPG 1
A 4 (1) 2.4 V6	8D2/8D5 B5	2.4	120	08.97 - 11.00	AMM	6		BKR6EKUB	3584		LPG 1
A 4 (1) 2.4 V6	8D2/8D5 B5	2.4	120	08.98 - 06.00	APZ	6		BKR6EKUB	3584		LPG 1
A 4 (1) 2.4 V6	8D2/8D5 B5	2.4	121	08.97 - 07.98	AGA	6		BKR6EKUB	3584		LPG 1
A 4 (1) 2.4 V6	8D2/8D5 B5	2.4	121	08.97 - 07.98	ALF	6		BKR6EKUB	3584		LPG 1
A 4 (1) 2.4 V6	8D2/8D5 B5	2.4	121	08.98 - 09.01	AML	6		BKR6EKUB	3584		LPG 1
A 4 (1) 2.4 V6	8D2/8D5 B5	2.4	121	08.98 - 06.00	ARJ	6		BKR6EKUB	3584		LPG 1
A 4 (1) 2.4 V6 China	8D2/8D5 B5	2.4	110	07.95 - 07.97	AFM	6		BKUR6ET-10	2397	24	LPG 1
A 4 (1) 2.4 V6 China	8D2/8D5 B5	2.4	121	08.98 - 09.01	APS	6		BKR6EKUB	3584		LPG 1
A 4 (1) 2.5 V6 TDI	8D2/8D5 B5	2.5	110	11.97 - 06.00	AFB	6	▣	Y-501U	3786	31	
A 4 (1) 2.5 V6 TDI	8D2/8D5 B5	2.5	110	07.98 - 09.01	AKN	6	▣	Y-501U	3786	31	
A 4 (1) 2.6 V6	8D2/8D5 B5	2.6	110	11.94 - 07.97	ABC	6		BKUR6ET-10	2397	24	LPG 1
A 4 (1) 2.6 V6 China / GUS	8D2/8D5 B5	2.6	102	06.94 - 10.97	ACZ	6		BKUR6ET-10	2397	24	LPG 1
A 4 (1) 2.8 V6	8D2/8D5 B5	2.8	128	11.94 - 07.97	AAH	6		BKUR6ET-10	2397	24	LPG 1
A 4 (1) 2.8 V6	8D2/8D5 B5	2.8	142	03.96 - 07.98	ACK	6		BKR6EKUB	3584		LPG 1
A 4 (1) 2.8 V6	8D2/8D5 B5	2.8	142	05.97 - 07.98	ALG	6		BKR6EKUB	3584		LPG 1
A 4 (1) 2.8 V6	8D2/8D5 B5	2.8	142	07.98 - 09.01	AMX	6		BKR6EKUB	3584		LPG 1
A 4 (1) 2.8 V6	8D2/8D5 B5	2.8	142	08.98 - 06.00	APR	6		BKR6EKUB	3584		LPG 1
A 4 (1) 2.8 V6	8D2/8D5 B5	2.8	142	08.98 - 06.00	AQD	6		BKR6EKUB	3584		LPG 1
A 4 (1) 2.8 V6 China, SA	8D2/8D5 B5	2.8	140	03.99 - 09.01	ATX	6		BKR6EKUB	3584		LPG 1
A 4 (1) 2.8 V6 USA	8D2/8D5 B5	2.8	128	08.94 - 07.98	AFC	6		BKUR6ET-10	2397	24	LPG 1
A 4 (1) avant RS 4 quattro	8D5 B5	2.7	280	06.00 - 10.00	ASJ	6		PFR7Q	7963		
A 4 (1) avant RS 4 quattro	8D5 B5	2.7	280	11.00 - 09.01	AZR	6		PFR7Q	7963		
A 4 (1) S 4 quattro	8D2/8D5 B5	2.7	169	07.98 - 08.00	AJK	6	0,8	PFR6Q	6458	37	LPG 1
A 4 (1) S 4 quattro	8D2/8D5 B5	2.7	184	07.98 - 12.98	APB	6	0,8	PFR6Q	6458	37	LPG 1
A 4 (1) S 4 quattro	8D2/8D5 B5	2.7	195	10.97 - 09.01	AGB	6	0,8	PFR6Q	6458	37	LPG 1
A 4 (1) S 4 quattro	8D2/8D5 B5	2.7	195	11.00 - 09.01	AZB	6	0,8	PFR6Q	6458	37	LPG 1

**A 4 2**

A 4 (2) 1.6	8E2/8E5	1.6	75	11.00 - 11.04	ALZ	4		BKUR6ET-10	2397	24	LPG 1
A 4 (2) 1.8 T	8E2/8E5	1.8	110	12.00 - 06.02	AVJ	4	0,8	PFR6Q	6458	37	LPG 1
A 4 (2) 1.8 T	8E2/8E5	1.8	120	07.02 - 11.04	BFB	4	0,8	PFR6Q	6458	37	LPG 1
A 4 (2) 1.8 T	8E2/8E5	1.8	120	07.02 - 12.04	BKB	4	0,8	PFR6Q	6458	37	LPG 1
A 4 (2) 1.8 T	8E2/8E5	1.8	140	11.02 - 12.04	BEX	4	0,8	PFR6Q	6458	37	LPG 1
A 4 (2) 1.9 TDI Fgst 8E-5-070251 →	8E2/8E5	1.9	85	06.04 - 12.05	BKE	4	▣	Y-607AS	7560	50	
A 4 (2) 1.9 TDI Fgst → 8E-2-148-697	8E2/8E5	1.9	74	04.01 - 05.04	AVB	4	▣	Y-732J	5605	4	
A 4 (2) 1.9 TDI Fgst → 8E-2-148-697	8E2/8E5	1.9	96	11.00 - 12.04	AVF	4	▣	Y-732J	5605	4	
A 4 (2) 1.9 TDI Fgst → 8E-2-148-697	8E2/8E5	1.9	96	12.00 - 06.03	AWX	4	▣	Y-732J	5605	4	
A 4 (2) 1.9 TDI Fgst 8E-2-148-698 →	8E2/8E5	1.9	74	04.01 - 05.04	AVB	4	▣	Y-741U	6943	20	
A 4 (2) 1.9 TDI Fgst 8E-2-148-698 →	8E2/8E5	1.9	96	11.00 - 12.04	AVF	4	▣	Y-741U	6943	20	
A 4 (2) 1.9 TDI Fgst 8E-2-148-698 →	8E2/8E5	1.9	96	12.00 - 06.03	AWX	4	▣	Y-741U	6943	20	
A 4 (2) 2.0	8E2/8E5	2.0	96	12.00 - 11.04	ALT	4		BKUR5ET-10	7553		LPG 1

Fgst = Chassis No.

Code *l* kW

Cyl.



Stock-No.



LPG/CNG

**AUDI****A 4 2**

A 4 (2) 2.0 FSI	8E2/8E5	2.0	110	07.02 - 12.04	AWA	4		PZFR5N-11T	7742		
A 4 (2) 2.4 V6	8E2/8E5	2.4	120	09.01 - 12.04	AMM	6		BKR6EKUB	3584		LPG 1
A 4 (2) 2.4 V6	8E2/8E5	2.4	125	09.01 - 12.04	BDV	6		BKR6EKUB	3584		LPG 1
A 4 (2) 2.5 V6 TDI	8E2/8E5	2.5	114	04.01 - 06.02	AYM	6	☑	Y-501U	3786	31	
A 4 (2) 2.5 V6 TDI	8E2/8E5	2.5	120	07.02 - 05.03	BFC	6	☑	Y-501U	3786	31	
A 4 (2) 2.5 V6 TDI	8E2/8E5	2.5	120	06.03 - 12.05	BCZ	6	☑	Y-501U	3786	31	
A 4 (2) 2.5 V6 TDI	8E2/8E5	2.5	120	06.03 - 10.04	BDG	6	☑	Y-501U	3786	31	
A 4 (2) 2.5 V6 TDI	8E2/8E5	2.5	132	12.00 - 05.03	AKE	6	☑	Y-501U	3786	31	
A 4 (2) 2.5 V6 TDI	8E2/8E5	2.5	132	06.03 - 12.04	BAU	6	☑	Y-501U	3786	31	
A 4 (2) 2.5 V6 TDI	8E2/8E5	2.5	132	06.03 - 12.04	BDH	6	☑	Y-501U	3786	31	
A 4 (2) 3.0 V6	8E2/8E5	3.0	160	04.01 - 10.04	BBJ	6		BKR6EKUB	3584		LPG 1
A 4 (2) 3.0 V6	8E2/8E5	3.0	162	12.00 - 12.05	ASN	6		BKR6EKUB	3584		LPG 1
A 4 (2) 3.0 V6	8E2/8E5	3.0	162	09.01 - 06.02	AVK	6	1,1	PFR6U-11G	5874		
A 4 (2) S 4 quattro	8E2/8E5	4.2	253	03.03 - 10.04	BBK	8		BKR6EQUA	6872		LPG 1

**A 4 3**

A 4 (3) 1.6	8EC/8ED	1.6	75	11.04 -	ALZ	4		BKUR6ET-10	2397	24	LPG 1
A 4 (3) 1.8 T	8EC/8ED	1.8	120	11.04 -	BFB	4		PFR6Q	6458	37	LPG 1
A 4 (3) 1.9 TDI	8EC/8ED	1.9	85	11.05 -	BRB	4	☑	CZ104	9826	52	
A 4 (3) 2.0	8EC/8ED	2.0	96	11.04 -	ALT	4		BKUR5ET-10	7553		LPG 1
A 4 (3) 2.0 TDI	8EC/8ED	2.0	89	01.06 - 09.06	BVG	4	☑	CZ304	9864	55	
A 4 (3) 2.0 TDI	8EC/8ED	2.0	93	11.05 - 11.06	BVF	4	☑	CZ304	9864	55	
A 4 (3) 2.0 TDI	8EC/8ED	2.0	100	11.04 - 10.05	BNA	4	☑	YE14	7768	48	
A 4 (3) 2.0 TDI	8EC/8ED	2.0	100	11.05 -	BRF	4	☑	CZ304	9864	55	
A 4 (3) 2.0 TDI	8EC/8ED	2.0	103	11.04 - 11.05	BLB	4	☑	YE14	7768	48	
A 4 (3) 2.0 TDI	8EC/8ED	2.0	103	11.04 -	BPW	4	☑	CZ104	9826	52	
A 4 (3) 2.0 TDI	8EC/8ED	2.0	103	10.05 -	BRE	4	☑	CZ304	9864	55	
A 4 (3) 2.0 TDI	8EC/8ED	2.0	120	06.06 -	BVA	4	☑	CZ304	9864	55	
A 4 (3) 2.0 TDI	8EC/8ED	2.0	125	06.06 -	BRD	4	☑	CZ304	9864	55	
A 4 (3) 2.0 TFSI	8EC/8ED	2.0	125	10.06 -	BYK	4	0,8	PFR7S8EG	1675		PFR8S8EG
A 4 (3) 2.0 TFSI	8EC/8ED	2.0	125	03.07 -	BPJ	4	0,8	PFR7S8EG	1675		PFR8S8EG
A 4 (3) 2.0 TFSI	8EC/8ED	2.0	147	11.04 - 03.08	BGB	4	0,8	PFR7S8EG	1675		PFR8S8EG
A 4 (3) 2.0 TFSI	8EC/8ED	2.0	147	09.05 -	BWE	4	0,8	PFR7S8EG	1675		PFR8S8EG
A 4 (3) 2.0 TFSI	8EC/8ED	2.0	162	06.05 -	BUL	4	0,8	PFR7S8EG	1675		PFR8S8EG
A 4 (3) 2.5 V6 TDI	8EC/8ED	2.5	120	11.04 - 05.06	BDG	6	☑	Y-501U	3786	31	
A 4 (3) 2.7 V6 TDI	8EC/8ED	2.7	120	11.05 - 06.08	BSG	6	☑	Y-609AS	5849	49	
A 4 (3) 2.7 V6 TDI	8EC/8ED	2.7	132	01.06 - 03.09	BPP	6	☑	Y-609AS	5849	49	
A 4 (3) 3.0 V6	8EC/8ED	3.0	160	11.04 - 07.06	BBJ	6		BKR6EKUB	3584		LPG 1
A 4 (3) 3.0 V6 TDI	8EC/8ED	3.0	150	11.04 - 03.09	BKN	6	☑	Y-609AS	5849	49	
A 4 (3) 3.0 V6 TDI	8EC/8ED	3.0	171	01.06 - 03.09	ASB	6	☑	Y-609AS	5849	49	
A 4 (3) 3.2 FSI	8EC/8ED	3.2	188	01.05 -	AUK	6		PFR7W-T	6840		
A 4 (3) RS 4 quattro	8EC/8ED	4.2	309	11.05 -	BNS	8		PFR7W-TG	5592		
A 4 (3) S 4 quattro	8EC/8ED	4.2	253	11.04 -	BBK	8		BKR6EQUA	6872		LPG 1
A 4 (3) S 4 quattro	8EC/8ED	4.2	253	03.06 -	BHF	8		BKR6EQUA	6872		LPG 1

**A 4 4**

A 4 (4) 1.8 TFSI	8K2/8K5	1.8	88	01.08 - 05.08	CABA	4	0,8	PFR7S8EG	1675		PFR8S8EG
A 4 (4) 1.8 TFSI	8K2/8K5	1.8	88	06.08 -	CDHA	4	0,8	PFR7S8EG	1675		PFR8S8EG
A 4 (4) 1.8 TFSI	8K2/8K5	1.8	118	11.07 - 05.08	CABB	4	0,8	PFR7S8EG	1675		PFR8S8EG
A 4 (4) 1.8 TFSI	8K2/8K5	1.8	118	06.08 -	CDHB	4	0,8	PFR7S8EG	1675		PFR8S8EG
A 4 (4) 2.0 TDI	8K2/8K5	2.0	88	06.08 -	CAGC	4	☑	Y-609AS	5849	49	

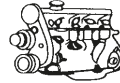
Code *l* kW

Cyl.

Stock-No.  
**VEINE****LP-G/CNG****AUDI****A 4 4**

A 4 (4) 2.0 TDI	8K2/8K5	2.0	100	11.07 -	CAGB	4	█	Y-609AS	5849	49	
A 4 (4) 2.0 TDI	8K2/8K5	2.0	100	11.10 -	CJCB	4	█	Y1002AS	8888	57	
A 4 (4) 2.0 TDI	8K2/8K5	2.0	105	11.07 -	CAGA	4	█	Y-609AS	5849	49	
A 4 (4) 2.0 TDI	8K2/8K5	2.0	105	05.10 -	CMEA	4	█	Y1002AS	8888	57	
A 4 (4) 2.0 TDI	8K2/8K5	2.0	120	08.08 -	CAHB	4	█	Y-609AS	5849	49	
A 4 (4) 2.0 TDI	8K2/8K5	2.0	125	08.08 -	CAHA	4	█	Y-609AS	5849	49	
A 4 (4) 2.0 TDI	8K2/8K5	2.0	130	11.11 -	CGLC	4	█	Y1002AS	8888	57	
A 4 (4) 2.0 TFSI	8K2/8K5	2.0	132	06.08 -	CAEA	4	0,8	PFR7S8EG	1675		PFR8S8EG
A 4 (4) 2.0 TFSI	8K2/8K5	2.0	132	06.08 -	CDNB	4	0,8	PFR7S8EG	1675		PFR8S8EG
A 4 (4) 2.0 TFSI flexible fuel	8K2/8K5	2.0	132	11.09 -	CFKA	4	0,8	PFR7S8EG	1675		PFR8S8EG
A 4 (4) 2.0 TFSI	8K2/8K5	2.0	155	06.08 -	CDNC	4	0,8	PFR7S8EG	1675		PFR8S8EG
A 4 (4) 2.7 V6 TDI	8K2/8K5	2.7	120	11.07 - 05.08	CAMB	6	█	Y-609AS	5849	49	
A 4 (4) 2.7 V6 TDI	8K2/8K5	2.7	140	11.07 - 05.08	CAMA	6	█	Y-609AS	5849	49	
A 4 (4) 3.0 V6 TDI	8K2/8K5	3.0	155	06.08 - 05.10	CCWB	6	█	Y-609AS	5849	49	
A 4 (4) 3.0 V6 TDI	8K2/8K5	3.0	176	11.07 - 05.08	CAPA	6	█	Y-609AS	5849	49	
A 4 (4) 3.0 V6 TDI	8K2/8K5	3.0	176	04.08 -	CCWA	6	█	Y-609AS	5849	49	
A 4 (4) 3.2 FSI	8K2/8K5	3.2	195	11.07 -	CALA	6	1,1	PFR6X-11	5757		
A 4 (4) S 4 quattro	8K2/8K5	3.0	245	03.09 -	CAKA	6	0,8	PFR8S8EG	94460		
A 4 (4) S 4 quattro	8K2/8K5	3.0	245	03.09 -	CCBA	6	0,8	PFR8S8EG	94460		

**A 5**

A 5 1.8 TFSI	8T3/8F7/8TA	1.8	118	05.09 -	CDHB	4	0,8	PFR7S8EG	1675		PFR8S8EG
A 5 1.8 TFSI	8T3/8F7/8TA	1.8	125	10.07 - 11.08	CABD	4	0,8	PFR7S8EG	1675		PFR8S8EG
A 5 2.0 TDI	8T3/8F7	2.0	100	09.09 -	CAGB	4	█	Y-609AS	5849	49	
A 5 2.0 TDI	8T3/8F7	2.0	105	09.09 -	CAGA	4	█	Y-609AS	5849	49	
A 5 2.0 TDI	8T3/8F7	2.0	105	05.10 -	CMEA	4	█	Y1002AS	8888	57	
A 5 2.0 TDI	8T3/8F7/8TA	2.0	120	08.08 -	CAHB	4	█	Y-609AS	5849	49	
A 5 2.0 TDI	8T3/8F7/8TA	2.0	125	08.08 -	CAHA	4	█	Y-609AS	5849	49	
A 5 2.0 TDI	8T3/8F7/8TA	2.0	130	10.11 -	CGLC	4	█	Y1002AS	8888	57	
A 5 2.0 TFSI	8T3/8F7/8TA	2.0	132	09.08 -	CDNB	4	0,8	PFR7S8EG	1675		PFR8S8EG
A 5 2.0 TFSI	8T3/8F7/8TA	2.0	132	03.09 -	CAEA	4	0,8	PFR7S8EG	1675		PFR8S8EG
A 5 2.0 TFSI	8T3/8F7/8TA	2.0	155	06.08 -	CAEB	4	0,8	PFR7S8EG	1675		PFR8S8EG
A 5 2.0 TFSI	8T3/8F7/8TA	2.0	155	06.08 -	CDNC	4	0,8	PFR7S8EG	1675		PFR8S8EG
A 5 2.7 V6 TDI	8T3/8F7/8TA	2.7	120	09.07 - 05.08	CAMB	6	█	Y-609AS	5849	49	
A 5 2.7 V6 TDI	8T3/8F7/8TA	2.7	120	05.08 -	CGKB	6	█	Y-609AS	5849	49	
A 5 2.7 V6 TDI	8T3/8F7/8TA	2.7	140	07.07 - 05.08	CAMA	6	█	Y-609AS	5849	49	
A 5 2.7 V6 TDI	8T3/8F7/8TA	2.7	140	05.08 -	CGKA	6	█	Y-609AS	5849	49	
A 5 3.0 V6 TDI	8T3/8F7/8TA	3.0	155	03.08 - 05.10	CCWB	6	█	Y-609AS	5849	49	
A 5 3.0 V6 TDI	8T3/8F7/8TA	3.0	176	03.08 -	CCWA	6	█	Y-609AS	5849	49	
A 5 3.0 V6 TDI	8T3/8F7/8TA	3.0	177	06.07 - 05.08	CAPA	6	█	Y-609AS	5849	49	
A 5 S 5 3.0 FSI quattro	8T3/8F7/8TA	3.0	245	05.09 -	CCBA	6	1,1	PFR6X-11	5757		
A 5 3.2 FSI	8T3/8F7/8TA	3.2	195	06.07 -	CALA	6	1,1	PFR6X-11	5757		
A 5 S 5 4.2 FSI quattro	8T3	4.2	260	06.07 -	CAUA	8		PFR6W-TG	5547		
A 5 RS 5 4.2 FSI quattro	8T3	4.2	331	03.10 -	CFSA	8	0,8	PFR7S8EG	1675		PFR8S8EG

**A 6 1**

A 6 (1) 1.8	4A/C4	1.8	92	10.95 - 10.97	ADR	4		BKUR6ET-10	2397	24	LPG 1
A 6 (1) 1.9 TDI	4A/C4	1.9	66	07.94 - 06.96	1Z	4	█	Y-732J	5605	4	
A 6 (1) 1.9 TDI	4A/C4	1.9	66	07.96 - 10.97	AHU	4	█	Y-732J	5605	4	
A 6 (1) 2.0	4A/C4	2.0	74	06.94 - 06.96	AAE	4		BUR6ET	3172	1	LPG 2
A 6 (1) 2.0 16V	4A/C4	2.0	103	06.94 - 10.97	ACE	4		BKUR7ET	7873		
A 6 (1) 2.0 E	4A/C4	2.0	85	06.94 - 06.96	ABK	4		BUR6ET	3172	1	LPG 2
A 6 (1) 2.3 E	4A/C4	2.3	98	06.94 - 06.96	AAR	5		BPR5EKU	5685		LPG 2

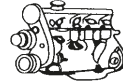
Code *l* kW

Cyl.



Stock-No.



LPG/CNG

**AUDI****A 6 1**

A 6 (1) 2.5 TDI	4A/C4	2.5	85	06.94 - 10.97	AAT	5		Y-732J	5605	4	
A 6 (1) 2.5 TDI	4A/C4	2.5	103	10.94 - 10.97	AEL	5		Y-732J	5605	4	
A 6 (1) 2.6 E	4A/C4	2.6	110	06.94 - 10.97	ABC	6		BKUR6ET-10	2397	24	LPG 1
A 6 (1) 2.8 E	4A/C4	2.8	128	06.94 - 10.97	AAH	6		BKUR6ET-10	2397	24	LPG 1
A 6 (1) 2.8 E	4A/C4	2.8	128	08.94 - 06.95	AFC	6		BKUR6ET-10	2397	24	LPG 1
A 6 (1) 2.8 E	4A/C4	2.8	142	10.95 - 07.98	ACK	6		BKR6EKUB	3584		LPG 1
A 6 (1) 2.8 E GUS	4A/C4	2.8	120	07.96 - 10.97	AEJ	6	0,8	PFR5B	5341		PFR6B
A 6 (1) S 6	4A/C4	2.2	169	06.94 - 07.97	AAN	5	0,6	PFR7B	4853		
A 6 (1) S 6 4.2	4A/C4	4.2	213	09.94 - 10.97	AEC	8	0,8	BUR6EFSZ	6837		
A 6 (1) S 6 Plus	4A/C4	4.2	240	06.96 - 10.97	AHK	8	0,8	BUR6EFSZ	6837		

**A 6 2**

A 6 (2) 1.8	4B/C5	1.8	92	12.97 - 07.99	AJP	4		BKUR6ET-10	2397	24	LPG 1
A 6 (2) 1.8	4B/C5	1.8	92	01.99 - 04.01	AQE	4		BKUR6ET-10	2397	24	LPG 1
A 6 (2) 1.8	4B/C5	1.8	92	01.99 - 04.01	ARH	4		BKUR6ET-10	2397	24	LPG 1
A 6 (2) 1.8 GUS	4B/C5	1.8	85	05.97 - 05.00	AFY	4		BKUR6ET-10	2397	24	LPG 1
A 6 (2) 1.8 T	4B/C5	1.8	110	04.97 - 01.99	AEB	4	0,8	PFR6Q	6458	37	LPG 1
A 6 (2) 1.8 T	4B/C5	1.8	110	11.98 - 05.01	APU	4	0,8	PFR6Q	6458	37	LPG 1
A 6 (2) 1.8 T	4B/C5	1.8	110	01.99 - 05.01	ANB	4	0,8	PFR6Q	6458	37	LPG 1
A 6 (2) 1.8 T	4B/C5	1.8	110	01.99 - 05.99	ARK	4	0,8	PFR6Q	6458	37	LPG 1
A 6 (2) 1.8 T	4B/C5	1.8	110	05.00 - 01.05	AWT	4	0,8	PFR6Q	6458	37	LPG 1
A 6 (2) 1.8 T	4B/C5	1.8	132	11.97 - 10.00	AJL	4	0,8	PFR6Q	6458	37	LPG 1
A 6 (2) 1.9 TDI	4B/C5	1.9	81	04.97 - 04.01	AFN	4		Y-732J	5605	4	
A 6 (2) 1.9 TDI	4B/C5	1.9	81	08.99 - 10.00	AVG	4		Y-732J	5605	4	
A 6 (2) 1.9 TDI	4B/C5	1.9	85	11.00 - 04.01	AJM	4		Y-741U	6943	20	
A 6 (2) 1.9 TDI	4B/C5	1.9	96	06.01 - 01.05	AVF	4		Y-732J	5605	4	
A 6 (2) 1.9 TDI	4B/C5	1.9	96	06.01 - 01.05	AWX	4		Y-741U	6943	20	
A 6 (2) 2.0	4B/C5	2.0	96	06.01 - 01.05	ALT	4		BKUR5ET-10	7553		LPG 1
A 6 (2) 2.4	4B/C5	2.4	99	08.97 - 01.99	ALW	6		BKR6EKUB	3584		LPG 1
A 6 (2) 2.4	4B/C5	2.4	100	02.99 - 05.00	ARN	6		BKR6EKUB	3584		LPG 1
A 6 (2) 2.4	4B/C5	2.4	100	06.00 - 01.05	ASM	6		BKR6EKUB	3584		LPG 1
A 6 (2) 2.4	4B/C5	2.4	120	04.97 - 01.99	AJG	6		BKR6EKUB	3584		LPG 1
A 6 (2) 2.4	4B/C5	2.4	120	11.98 - 05.01	APZ	6		BKR6EKUB	3584		LPG 1
A 6 (2) 2.4	4B/C5	2.4	120	06.00 - 04.01	AMM	6		BKR6EKUB	3584		LPG 1
A 6 (2) 2.4	4B/C5	2.4	121	04.97 - 01.99	AGA	6		BKR6EKUB	3584		LPG 1
A 6 (2) 2.4	4B/C5	2.4	121	06.97 - 01.99	ALF	6		BKR6EKUB	3584		LPG 1
A 6 (2) 2.4	4B/C5	2.4	121	04.98 - 05.01	APC	6		BKR6EKUB	3584		LPG 1
A 6 (2) 2.4	4B/C5	2.4	121	11.98 - 05.01	ARJ	6		BKR6EKUB	3584		LPG 1
A 6 (2) 2.4	4B/C5	2.4	121	06.00 - 05.01	AML	6		BKR6EKUB	3584		LPG 1
A 6 (2) 2.4	4B/C5	2.4	125	06.01 - 01.05	BDV	6		BKR6EKUB	3584		LPG 1
A 6 (2) 2.4 China	4B/C5	2.4	121	11.98 - 05.01	APS	6		BKR6EKUB	3584		LPG 1
A 6 (2) 2.5 TDI	4B/C5	2.5	110	04.97 - 05.00	AFB	6		Y-501U	3786	31	
A 6 (2) 2.5 TDI	4B/C5	2.5	110	10.98 - 05.01	AKN	6		Y-501U	3786	31	
A 6 (2) 2.5 TDI	4B/C5	2.5	114	06.01 - 06.02	AYM	6		Y-501U	3786	31	
A 6 (2) 2.5 TDI	4B/C5	2.5	120	07.02 - 08.03	BFC	6		Y-501U	3786	31	
A 6 (2) 2.5 TDI	4B/C5	2.5	120	02.03 - 08.05	BCZ	6		Y-501U	3786	31	
A 6 (2) 2.5 TDI	4B/C5	2.5	120	02.03 - 01.05	BDG	6		Y-501U	3786	31	
A 6 (2) 2.5 TDI	4B/C5	2.5	132	11.99 - 08.03	AKE	6		Y-501U	3786	31	
A 6 (2) 2.5 TDI	4B/C5	2.5	132	02.03 - 08.05	BAU	6		Y-501U	3786	31	
A 6 (2) 2.5 TDI	4B/C5	2.5	132	02.03 - 01.05	BDH	6		Y-501U	3786	31	
A 6 (2) 2.7 T	4B/C5	2.7	169	02.99 - 08.00	AJK	6	0,8	PFR6Q	6458	37	LPG 1



Code *ℓ* kW

Cyl.

Stock-No.  
**VEINE**  
B-POMPEZ\*

LPG/CNG

**AUDI****A 6 2**

A 6 (2) 2.7 T	4B/C5	2.7	169	09.00 - 05.01	AZA	6	0,8	PFR6Q	6458	37	LPG 1
A 6 (2) 2.7 T	4B/C5	2.7	184	05.00 - 06.02	ARE	6	0,8	PFR6Q	6458	37	LPG 1
A 6 (2) 2.7 T	4B/C5	2.7	184	07.02 - 08.05	BES	6	0,8	PFR6Q	6458	37	LPG 1
A 6 (2) 2.8	4B/C5	2.8	132	02.98 - 05.01	AGE	6		BKR6EKUB	3584		LPG 1
A 6 (2) 2.8	4B/C5	2.8	140	07.99 - 05.01	ATX	6		BKR6EKUB	3584		LPG 1
A 6 (2) 2.8	4B/C5	2.8	142	06.97 - 01.99	ALG	6		BKR6EKUB	3584		LPG 1
A 6 (2) 2.8	4B/C5	2.8	142	11.98 - 05.01	APR	6		BKR6EKUB	3584		LPG 1
A 6 (2) 2.8	4B/C5	2.8	142	11.98 - 05.01	AQD	6		BKR6EKUB	3584		LPG 1
A 6 (2) 2.8	4B/C5	2.8	142	06.00 - 05.01	AMX	6		BKR6EKUB	3584		LPG 1
A 6 (2) 2.8 USA	4B/C5	2.8	142	08.97 - 07.99	AHA	6		BKR6EKUB	3584		LPG 1
A 6 (2) 3.0	4B/C5	3.0	162	06.01 - 01.05	ASN	6		BKR6EKUB	3584		LPG 1
A 6 (2) 4.2 quattro	4B/C5	4.2	220	11.98 - 01.05	ARS	8		BKR6EQUA	6872		LPG 1
A 6 (2) 4.2 quattro	4B/C5	4.2	220	11.98 - 01.05	ASG	8		BKR6EQUA	6872		LPG 1
A 6 (2) 4.2 allroad	4B/C5	4.2	220	04.03 - 08.05	BAS	8		BKR6EQUA	6872		LPG 1
A 6 (2) RS 6 quattro	4B/C5	4.2	331	07.02 - 09.04	BCY	8		PFR7Q	7963		
A 6 (2) RS 6 plus quattro	4B/C5	4.2	353	04.04 - 01.05	BRV	8		PFR7Q	7963		

**A 6 3**

A 6 (3) 2.0 TDI	4F2/4F5	2.0	89	09.05 - 06.06	BVG	4	█	CZ304	9864	55	
A 6 (3) 2.0 TDI	4F2/4F5	2.0	100	07.04 - 11.05	BNA	4	█	YE14	7768	48	
A 6 (3) 2.0 TDI	4F2/4F5	2.0	100	09.05 -	BRF	4	█	CZ304	9864	55	
A 6 (3) 2.0 TDI	4F2/4F5	2.0	100	10.08 -	CAGB	4	█	Y-609AS	5849	49	
A 6 (3) 2.0 TDI	4F2/4F5	2.0	103	07.04 - 11.05	BLB	4	█	YE14	7768	48	
A 6 (3) 2.0 TDI	4F2/4F5	2.0	103	09.05 - 10.08	BRE	4	█	CZ304	9864	55	
A 6 (3) 2.0 TDI	4F2/4F5	2.0	120	04.09 -	CAHB	4	█	Y-609AS	5849	49	
A 6 (3) 2.0 TDI	4F2/4F5	2.0	125	11.08 -	CAHA	4	█	Y-609AS	5849	49	
A 6 (3) 2.0 TFSI	4F2/4F5	2.0	125	06.05 -	BPJ	4	0,8	PFR7S8EG	1675		PFR8S8EG
A 6 (3) 2.4	4F2/4F5	2.4	130	04.04 - 10.08	BDW	6	1,1	PFR6X-11	5757		
A 6 (3) 2.7 TDI	4F2/4F5	2.7	120	06.05 -	BSG	6	█	Y-609AS	5849	49	
A 6 (3) 2.7 TDI	4F2/4F5	2.7	120	10.08 -	CANB	6	█	Y-609AS	5849	49	
A 6 (3) 2.7 TDI	4F2/4F5	2.7	120	10.08 -	CAND	6	█	Y-609AS	5849	49	
A 6 (3) 2.7 TDI	4F2/4F5	2.7	132	11.04 - 10.08	BPP	6	█	Y-609AS	5849	49	
A 6 (3) 2.7 TDI	4F2/4F5	2.7	140	10.08 -	CANA	6	█	Y-609AS	5849	49	
A 6 (3) 2.7 TDI quattro	4F2/4F5	2.7	140	10.08 -	CANC	6	█	Y-609AS	5849	49	
A 6 (3) 2.8 FSI	4F2/4F5	2.8	140	10.08 -	CCDA	6	1,1	PFR6X-11	5757		
A 6 (3) 2.8 FSI	4F2/4F5	2.8	154	11.06 -	BDX	6	1,1	PFR6X-11	5757		
A 6 (3) 2.8 FSI	4F2/4F5	2.8	162	10.08 -	CCEA	6	1,1	PFR6X-11	5757		
A 6 (3) 3.0 quattro	4F2/4F5	3.0	160	06.01 - 05.06	BBJ	6		BKR6EKUB	3584		LPG 1
A 6 (3) 3.0 TDI	4F2/4F5	3.0	155	03.05 - 10.08	BNG	6	█	Y-609AS	5849	49	
A 6 (3) 3.0 TDI	4F2/4F5	3.0	155	10.08 -	CDYB	6	█	Y-609AS	5849	49	
A 6 (3) 3.0 TDI quattro	4F2/4F5	3.0	165	04.04 - 05.06	BMK	6	█	Y-609AS	5849	49	
A 6 (3) 3.0 TDI quattro	4F2/4F5	3.0	171	05.06 - 10.08	ASB	6	█	Y-609AS	5849	49	
A 6 (3) 3.0 TDI quattro	4F2/4F5	3.0	176	10.08 -	CDYA	6	█	Y-609AS	5849	49	
A 6 (3) 3.0 TDI quattro	4F2/4F5	3.0	176	10.08 -	CDYC	6	█	Y-609AS	5849	49	
A 6 (3) 3.0 TFSI	4F2/4F5	3.0	213	10.08 -	CAJA	6	0,8	PFR8S8EG	94460		
A 6 (3) 3.0 TFSI quattro	4F2/4F5	3.0	220	10.08 -	CCAA	6	0,8	PFR8S8EG	94460		
A 6 (3) 3.2 FSI	4F2/4F5	3.2	188	04.04 -	AUK	6		PFR7W-T	6840		
A 6 (3) 3.2 FSI	4F2/4F5	3.2	188	10.08 -	BKH	6	1,1	PFR6X-11	5757		
A 6 (3) 4.2 FSI quattro	4F2/4F5	4.2	257	05.06 -	BVJ	8		PFR6W-TG	5547		
A 6 (3) 4.2 quattro	4F2/4F5	4.2	246	04.04 - 05.06	BAT	8		BKR6EQUA	6872		LPG 1
A 6 (3) S 6 quattro	4F2/4F5	5.2	320	06.06 -	BXA	10		PFR6W-TG	5547		

Code *l* kW

Cyl.



Stock-No.



LPG/CNG

**AUDI****A 6 4**

A 6 (4) 2.0 TDI	4G2/4G5	2.0	100	01.12 -	CGLE	4	☑	Y1002AS	8888	57	
A 6 (4) 2.0 TDI	4G2/4G5	2.0	120	03.11 -	CGLD	4	☑	Y1002AS	8888	57	
A 6 (4) 2.0 TDI	4G2/4G5	2.0	130	04.11 -	CGLC	4	☑	Y1002AS	8888	57	
A 6 (4) 2.0 TDI	4G2/4G5	2.0	130	04.11 -	CMGB	4	☑	Y1002AS	8888	57	
A 6 (4) 2.0 TFSI	4G2/4G5	2.0	132	05.11 -	CDNB	4	0,8	PFR7S8EG	1675		PFR8S8EG
A 6 (4) 2.0 TFSI	4G2/4G5	2.0	155	03.11 -	CAEB	4	0,8	PFR7S8EG	1675		PFR8S8EG
A 6 (4) 2.0 TFSI Hybrid	4G2/4G5	2.0	155	11.11 -	CHJA	4	0,8	PFR7S8EG	1675		PFR8S8EG
A 6 (4) 3.0 TFSI quattro	4G2/4G5	3.0	220	04.11 -	CGWB	6	0,8	PFR8S8EG	94460		
A 6 (4) 3.0 TFSI quattro	4G2/4G5	3.0	228	03.11 -	CGWD	6	0,8	PFR8S8EG	94460		
A 6 (4) 3.0 TFSI quattro	4G2/4G5	3.0	228	03.11 -	CGXB	6	0,8	PFR8S8EG	94460		
A 6 (4) 3.0 TFSI quattro	4G2/4G5	3.0	228	03.11 -	CTUA	6	0,8	PFR8S8EG	94460		
A 6 (4) 3.0 V6 TDI	4G2/4G5	3.0	150	04.11 -	CLAA	6	☑	Y1002AS	8888	57	
A 6 (4) 3.0 V6 TDI	4G2/4G5	3.0	150	04.11 -	CLAB	6	☑	Y1002AS	8888	57	
A 6 (4) 3.0 V6 TDI	4G2/4G5	3.0	180	04.11 -	CDUC	6	☑	Y1002AS	8888	57	
A 6 (4) 3.0 V6 TDI quattro	4G2/4G5	3.0	230	11.11 -	CGQB	6	☑	Y1002AS	8888	57	

**A 7**

A 7 3.0 TDI Sportback	4GA	3.0	150	12.10 -	CLAA	6	☑	Y1002AS	8888	57	
A 7 3.0 TDI Sportback	4GA	3.0	150	11.10 -	CLAB	6	☑	Y1002AS	8888	57	
A 7 3.0 TDI Sportback	4GA	3.0	180	07.10 -	CDUC	6	☑	Y1002AS	8888	57	
A 7 3.0 TFSI Sportback	4GA	3.0	220	07.10 -	CGWB	6	0,8	PFR8S8EG	94460		
A 7 3.0 TFSI Sportback	4GA	3.0	228	05.11 -	CGXB	6	0,8	PFR8S8EG	94460		
A 7 3.0 TDI Sportback	4GA	3.0	230	11.11 -	CGQB	6	☑	Y1002AS	8888	57	

**A 8 1**

A 8 (1) 2.5 TDI	4D2	2.5	110	06.97 - 04.00	AFB	6	☑	Y-501U	3786	31	
A 8 (1) 2.5 TDI	4D2	2.5	110	11.97 - 09.02	AKN	6	☑	Y-501U	3786	31	
A 8 (1) 2.5 TDI	4D2	2.5	132	11.99 - 09.02	AKE	6	☑	Y-501U	3786	31	
A 8 (1) 2.8	4D2	2.8	120	07.95 - 03.96	AEJ	6	0,8	PFR5B	5341		PFR6B
A 8 (1) 2.8	4D2	2.8	128	06.94 - 03.96	AAH	6		BKUR6ET-10	2397	24	LPG 1
A 8 (1) 2.8	4D2	2.8	142	04.96 - 09.98	ACK	6		BKR6EKUB	3584		LPG 1
A 8 (1) 2.8	4D2	2.8	142	01.99 - 02.01	APR	6		BKR6EKUB	3584		LPG 1
A 8 (1) 2.8	4D2	2.8	142	01.99 - 02.01	AQD	6		BKR6EKUB	3584		LPG 1
A 8 (1) 2.8	4D2	2.8	142	05.00 - 09.02	AMX	6		BKR6EKUB	3584		LPG 1
A 8 (1) 2.8	4D2	2.8	142	10.97 - 12.98	ALG	6		BKR6EKUB	3584		LPG 1
A 8 (1) 3.3 TDI	4D2	3.3	165	12.99 - 09.02	AKF	8	☑	Y-501U	3786	31	
A 8 (1) 3.7	4D2	3.7	169	07.95 - 12.98	AEW	8	0,8	BUR6EFSZ	6837		
A 8 (1) 3.7	4D2	3.7	169	05.97 - 12.98	AKJ	8	0,8	BUR6EFSZ	6837		
A 8 (1) 4.2 quattro	4D2	4.2	180	06.94 - 07.96	AEM	8	0,8	BUR6EFSZ	6837		
A 8 (1) 4.2 quattro	4D2	4.2	220	06.97 - 12.98	AKG	8	0,8	BUR6EFSZ	6837		
A 8 (1) 4.2 quattro	4D2	4.2	220	06.94 - 05.99	ABZ	8	0,8	BUR6EFSZ	6837		
A 8 (1) 4.2 quattro	4D2	4.2	228	10.98 - 09.02	AQF	8		BKR6EQUA	6872		LPG 1
A 8 (1) 4.2 quattro	4D2	4.2	228	10.98 - 09.02	AUW	8		BKR6EQUA	6872		LPG 1
A 8 (1) 6.0 W12 quattro	4D2	6.0	309	03.01 - 09.02	AZC	12	1,1	PZFR6J-11	3586		LPG 6
A 8 (1) S 8 4.2 quattro	4D2	4.2	250	09.96 - 12.98	AHC	8	0,8	BUR6EFSZ	6837		
A 8 (1) S 8 4.2 quattro	4D2	4.2	250	08.97 - 12.98	AKH	8	0,8	BUR6EFSZ	6837		

**A 8 2**

A 8 (2) 2.8 FSI	4E	2.8	154	09.07 - 07.10	BDX	6	1,1	PFR6X-11	5757		
A 8 (2) 3.0	4E	3.0	160	07.03 - 05.06	BBJ	6		BKR6EKUB	3584		LPG 1
A 8 (2) 3.0	4E	3.0	162	07.03 - 05.05	ASN	6		BKR6EKUB	3584		LPG 1
A 8 (2) 3.0 TDI Fgst 4E-5-003 301 →	4E	3.0	155	11.03 - 07.10	BNG	6	☑	Y-609AS	5849	49	
A 8 (2) 3.0 TDI Fgst 4E-5-003 301 →	4E	3.0	171	01.04 - 07.10	ASB	6	☑	Y-609AS	5849	49	

Fgst = Chassis No.

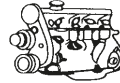
Code *l* kW

Cyl.

Stock-No.  
**V-TIME**  
B-POLYMER\*

LPG/CNG

**AUDI****A 8 2**

A 8 (2) 3.2 FSI	4E	3.2	191	06.05 - 07.10	BPK	6		PFR7W-T	6840		
A 8 (2) 3.7 quattro	4E	3.7	206	11.02 - 05.06	BFL	8		BKR6EQUA	6872		LPG 1
A 8 (2) 4.0 TDI quattro	4E	4.0	202	05.03 - 07.05	ASE	8	☑	Y-501U	3786	31	
A 8 (2) 4.2 FSI quattro	4E	4.2	257	06.06 - 07.10	BVJ	8		PFR6W-TG	5547		
A 8 (2) 4.2 quattro	4E	4.2	246	11.02 - 05.06	BFM	8		BKR6EQUA	6872		LPG 1
A 8 (2) 4.2 TDI quattro	4E	4.2	235	01.05 - 06.05	BMC	8	☑	Y-609AS	5849	49	
A 8 (2) 4.2 TDI quattro	4E	4.2	240	07.05 - 07.10	BVN	8	☑	Y-609AS	5849	49	
A 8 (2) 6.0 W12 quattro	4E	6.0	331	02.04 - 07.10	BHT	12	1,1	PZFR6J-11	3586		LPG 6
A 8 (2) S 8 5.2 quattro	4E	5.2	331	06.06 - 07.10	BSM	10		PFR6W-TG	5547		

**A 8 3**

A 8 (3) 2.0 TFSI Hybrid	4H	2.0	155	02.12 -	CHJA	4	0,8	PFR7S8EG	1675		PFR8S8EG
A 8 (3) 3.0 TDI quattro	4H	3.0	184	07.10 -	CDTA	6	☑	Y1002AS	8888	57	
A 8 (3) 3.0 TFSI quattro	4H	3.0	213	07.10 -	CGWA	6	0,8	PFR8S8EG	94460		
A 8 (3) 3.0 TFSI quattro	4H	3.0	213	07.10 -	CGXA	6	0,8	PFR8S8EG	94460		
A 8 (3) 3.0 TFSI quattro	4H	3.0	245	06.10 -	CMDA	6	0,8	PFR8S8EG	94460		
A 8 (3) 3.0 TFSI quattro	4H	3.0	245	05.11 -	CGXC	6	0,8	PFR8S8EG	94460		
A 8 (3) 4.2 FSI quattro	4H	4.2	273	11.09 -	CDRA	8		PFR6W-TG	5547		
A 8 (3) 4.2 TDI quattro	4H	4.2	258	11.09 -	CDSB	8	☑	Y-609AS	5849	49	
A 8 (3) 6.3 W12 quattro	4H	6.3	368	01.11 -	CEJA	12	0,8	ILZKR8A	94290		

**CABRIO**

Cabrio 1.8		1.8	92	04.97 - 08.00	ADR	4		BKUR6ET-10	2397	24	LPG 1
Cabrio 1.9 TDI		1.9	66	07.95 - 07.96	1Z	4	☑	Y-732J	5605	4	
Cabrio 1.9 TDI		1.9	66	07.96 - 08.00	AHU	4	☑	Y-732J	5605	4	
Cabrio 2.0 E		2.0	85	01.93 - 09.98	ABK	4		BUR6ET	3172	1	LPG 2
Cabrio 2.0 E 16V		2.0	103	05.95 - 07.96	ACE	4		BKUR7ET	7873		PFR7Q
Cabrio 2,3 E		2.3	98	06.91 - 07.94	NG	5		BPR5EKU	5685		LPG 2
Cabrio 2.6 E		2.6	110	01.94 - 08.00	ABC	6		BKUR6ET-10	2397	24	LPG 1
Cabrio 2.6 E China / GUS		2.6	102	05.95 - 12.99	ACZ	6		BKUR6ET-10	2397	24	LPG 1
Cabrio 2.8 E		2.8	128	11.92 - 08.00	AAH	6		BKUR6ET-10	2397	24	LPG 1

**COUPÉ**

Coupé 2.0 E		2.0	85	08.90 - 07.91	AAD	4		BUR6ET	3172	1	LPG 2
Coupé 2.0 E		2.0	85	08.91 - 12.95	ABK	4		BUR6ET	3172	1	LPG 2
Coupé 2.0 E 16V		2.0	101	03.90 - 07.92	6A	4		BKUR7ET	7873		PFR7Q
Coupé 2.0 E 16V		2.0	103	08.92 - 12.95	ACE	4		BKUR7ET	7873		PFR7Q
Coupé 2.2 S2		2.2	162	09.90 - 09.92	3B	5	0,6	PFR7B	4853		PFR8B
Coupé 2.2 S2		2.2	169	10.92 - 12.95	ABY	5	0,6	PFR7B	4853		PFR8B
Coupé 2.6 E		2.6	110	08.92 - 12.95	ABC	6		BKUR6ET-10	2397	24	LPG 1
Coupé 2.8 E		2.8	128	08.91 - 12.95	AAH	6		BKUR6ET-10	2397	24	LPG 1

**Q 3**

Q 3 2.0 TDI	8UB	2.0	100	09.11 -	CFFA	4	☑	Y1002AS	8888	57	
Q 3 2.0 TDI	8UB	2.0	103	09.11 -	CFFB	4	☑	Y1002AS	8888	57	
Q 3 2.0 TDI	8UB	2.0	120	06.11 -	CFGD	4	☑	Y1002AS	8888	57	
Q 3 2.0 TFSI	8UB	2.0	125	06.11 -	CCZC	4	0,8	PFR7S8EG	1675		PFR8S8EG
Q 3 2.0 TDI	8UB	2.0	130	06.11 -	CFGC	4	☑	Y1002AS	8888	57	
Q 3 2.0 TDI	8UB	2.0	130	06.11 -	CLLB	4	☑	Y1002AS	8888	57	
Q 3 2.0 TFSI	8UB	2.0	155	06.11 -	CPSA	4	0,8	PFR7S8EG	1675		PFR8S8EG

**Q 5**

Q 5 2.0 TDI	8R	2.0	100	08.09 -	CAGB	4	☑	Y-609AS	5849	49	
Q 5 2.0 TDI	8R	2.0	100	05.10 -	CJCB	4	☑	Y1002AS	8888	57	
Q 5 2.0 TDI	8R	2.0	105	08.09 -	CAGA	4	☑	Y-609AS	5849	49	

Fgst = Chassis No.

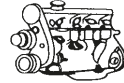
Code *l* kW

Cyl.



Stock-No.



LPG/CNG

**AUDI****Q 5**

Q 5 2.0 TDI	8R	2.0	105	05.10 -	CJCA	4		Y1002AS	8888	57	
Q 5 2.0 TDI	8R	2.0	110	05.13 -	CJCD	4		Y1002AS	8888	57	
nur für Zylinder ohne Drucksensor											
Q 5 2.0 TDI	8R	2.0	120	11.08 - 09.10	CAHB	4		Y-609AS	5849	49	
Q 5 2.0 TDI	8R	2.0	120	05.10 -	CGLA	4		Y1002AS	8888	57	
Q 5 2.0 TDI	8R	2.0	125	11.08 - 09.10	CAHA	4		Y-609AS	5849	49	
Q 5 2.0 TDI	8R	2.0	125	05.10 -	CGLB	4		Y1002AS	8888	57	
Q 5 2.0 TDI	8R	2.0	125	11.10 -	CMGA	4		Y1002AS	8888	57	
Q 5 2.0 TDI	8R	2.0	130	07.12 -	CGLC	4		Y1002AS	8888	57	
Q 5 2.0 TDI	8R	2.0	130	07.12 -	CGMB	4		Y1002AS	8888	57	
Q 5 2.0 TFSI	8R	2.0	130	09.09 -	CDNA	4	0,8	PFR7S8EG	1675		PFR8S8EG
Q 5 2.0 TFSI	8R	2.0	132	08.09 -	CDNB	4	0,8	PFR7S8EG	1675		PFR8S8EG
Q 5 2.0 TFSI	8R	2.0	155	11.08 -	CDNC	4	0,8	PFR7S8EG	1675		PFR8S8EG
Q 5 2.0 TFSI	8R	2.0	155	05.10 -	CAEB	4	0,8	PFR7S8EG	1675		PFR8S8EG
Q 5 2.0 TFSI Hybrid	8R	2.0	155	06.11 -	CHJA	4	0,8	PFR7S8EG	1675		PFR8S8EG
Q 5 3.0 V6 TDI	8R	3.0	155	11.08 -	CCWB	6		Y-609AS	5849	49	
Q 5 3.0 V6 TDI	8R	3.0	176	11.08 -	CCWA	6		Y-609AS	5849	49	
Q 5 3.0 V6 TDI	8R	3.0	180	06.12 -	CDUD	6		Y1002AS	8888	57	
Q 5 3.0 V6 TDI	8R	3.0	190	06.12 -	CTBA	6		Y1002AS	8888	57	
nur für Zylinder ohne Drucksensor											
Q 5 3.2 V6 FSI	8R	3.2	199	11.08 -	CALB	6	1,1	PFR6X-11	5757		

**Q 7**

Q 7 3.0 TDI	4L	3.0	155	03.06 -	BUN	6		Y-609AS	5849	49	
Q 7 3.0 TDI	4L	3.0	155	11.07 - 05.10	CASB	6		Y-609AS	5849	49	
Q 7 3.0 TDI	4L	3.0	171	03.06 -	BUG	6		Y-609AS	5849	49	
Q 7 3.0 TDI	4L	3.0	176	11.07 - 05.10	CASA	6		Y-609AS	5849	49	
Q 7 3.0 TDI	4L	3.0	180	05.11 -	CJGD	6		Y1002AS	8888	57	
Q 7 3.0 TDI	4L	3.0	180	05.11 -	CRCA	6		Y1002AS	8888	57	
Q 7 3.0 TFSI	4L	3.0	200	05.10 -	CJTC	6	0,8	PFR8S8EG	94460		
Q 7 3.0 TFSI	4L	3.0	200	07.10 -	CJWC	6	0,8	PFR8S8EG	94460		
Q 7 3.0 TFSI	4L	3.0	245	05.10 -	CJTB	6	0,8	PFR8S8EG	94460		
Q 7 3.0 TFSI	4L	3.0	245	07.10 -	CJWB	6	0,8	PFR8S8EG	94460		
Q 7 3.0 TFSI	4L	3.0	245	07.10 -	CNAA	6	0,8	PFR8S8EG	94460		
Q 7 3.6 FSI	4L	3.6	206	08.06 -	BHK	6	0,9	ILZKR7A	1961		
Q 7 4.2 FSI	4L	4.2	257	03.06 -	BAR	8		PFR6W-TG	5547		
Q 7 4.2 TDI	4L	4.2	230	03.07 -	BTR	8		Y-609AS	5849	49	
Q 7 4.2 TDI	4L	4.2	250	06.09 - 05.10	CCFA	8		Y-609AS	5849	49	
Q 7 6.0 TDI	4L	6.0	368	09.08 -	CCGA	12		Y-609AS	5849	49	

**R 8**

R 8 4.2		4.2	309	04.07 -	BYH	8		PFR7W-TG	5592		
R 8 5.2		5.2	386	04.09 - 09.10	BUJ	10		PFR7W-TG	5592		
R 8 5.2		5.2	386	09.10 -	BUJ	10	0,8	PFR7S8EG	1675		PFR8S8EG
R 8 5.2 GT		5.2	412	11.10 -	CMPA	10	0,8	PFR7S8EG	1675		PFR8S8EG

**TT 1**

TT (1) 1.8T	8N3/8N9	1.8	110	01.01 - 06.06	AUM	4	0,8	PFR6Q	6458	37	LPG 1
TT (1) 1.8T	8N3/8N9	1.8	120	09.05 - 06.06	BVP	4	0,8	PFR6Q	6458	37	LPG 1
TT (1) 1.8T	8N3/8N9	1.8	132	10.98 - 08.00	AJQ	4	0,8	PFR6Q	6458	37	LPG 1
TT (1) 1.8T	8N3/8N9	1.8	132	09.99 - 09.00	APP	4	0,8	PFR6Q	6458	37	LPG 1
TT (1) 1.8T	8N3/8N9	1.8	132	09.00 - 05.05	ARY	4	0,8	PFR6Q	6458	37	LPG 1

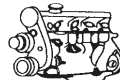

Code *l* kW

Cyl.



Stock-No.



LPG/CNG

**AUDI****TT 1**

TT (1) 1.8T	8N3/8N9	1.8	132	09.00 - 06.06	AUQ	4	0,8	PFR6Q	6458	37	LPG 1
TT (1) 1.8T USA	8N3/8N9	1.8	132	09.00 - 06.06	AWP	4	0,8	PFR6Q	6458	37	LPG 1
TT (1) 1.8T USA	8N3/8N9	1.8	165	03.00 - 08.02	AMU	4	0,8	PFR6Q	6458	37	LPG 1
TT (1) 1.8T quattro	8N3/8N9	1.8	140	09.05 - 06.06	BVR	4	0,8	PFR6Q	6458	37	LPG 1
TT (1) 1.8T quattro	8N3/8N9	1.8	165	10.98 - 08.01	APX	4	0,8	PFR6Q	6458	37	LPG 1
TT (1) 1.8T quattro	8N3/8N9	1.8	165	09.00 - 05.05	BAM	4	0,8	PFR6Q	6458	37	LPG 1
TT (1) 1.8T quattro	8N3/8N9	1.8	180	03.05 - 05.05	BFV	4	0,8	PFR6Q	6458	37	LPG 1
TT (1) 3.2 V6 quattro	8N3/8N9	3.2	184	07.03 - 06.06	BHE	6	0,9	IZKR7B	7563		

**TT 2**

TT (2) 1.8TFSI	8J3/8J9	1.8	118	06.08 -	CDA	4	0,8	PFR7S8EG	1675		PFR8S8EG
TT (2) 2.0 TDI quattro	8J3/8J9	2.0	125	06.08 -	CBBB	4		Y1002AS	8888	57	
TT (2) 2.0 TDI quattro	8J3/8J9	2.0	125	05.10 -	CFGB	4		Y1002AS	8888	57	
TT (2) 2.0 TDI quattro	8J3/8J9	2.0	125	06.08 - 06.10	CBBB	4		Y-609AS	5849	49	
TT (2) 2.0 TFSI	8J3/8J9	2.0	147	08.06 -	BWA	4	0,8	PFR7S8EG	1675		PFR8S8EG
TT (2) 2.0 TFSI	8J3/8J9	2.0	147	06.08 - 06.10	CCZA	4	0,8	PFR7S8EG	1675		PFR8S8EG
TT (2) 2.0 TFSI	8J3/8J9	2.0	155	05.10 -	CESA	4	0,8	PFR7S8EG	1675		PFR8S8EG
TT (2) 2.0 TFSI quattro	8J3/8J9	2.0	155	05.10 -	CETA	4	0,8	PFR7S8EG	1675		PFR8S8EG
TT (2) 2.0 TFSI quattro	8J3/8J9	2.0	195	05.08 -	CDLA	4	0,8	PFR7S8EG	1675		PFR8S8EG
TT (2) 2.0 TFSI quattro	8J3/8J9	2.0	195	05.10 -	CDMA	4	0,8	PFR7S8EG	1675		PFR8S8EG
TT (2) 2.0 TFSI quattro	8J3/8J9	2.0	200	05.08 -	CDLB	4	0,8	PFR7S8EG	1675		PFR8S8EG
TT (2) 3.2 V6 quattro	8J3/8J9	3.2	184	08.06 -	BUB	6	0,9	IZKR7B	7563		

**V8**

V8 3.6		3.6	184	10.88 - 11.93	PT	8	0,8	BUR6EFSZ	6837		
V8 4.2		4.2	206	08.91 - 11.93	ABH	8	0,8	BUR6EFSZ	6837		

**AUSTIN**

Austin TAXI				08.83 -		4		Y-208T	1250		
Metro 310		1.0		09.89 - 04.92		4	0,7	BP6ES	7811	4	LPG 2
Metro 310		1.3		09.89 - 04.92		4	0,8	BPR6ES	7822	2	LPG 2

**AUTOBIANCHI**

Y10 Fire		1.0	32	10.87 - 09.92	156A2.100 Cat.	4	0,8	BCPR6ES	2330	12	LPG 3
Y10 i.e Igloo		1.1	37	03.94 - 10.96	156C046	4	0,8	BCPR6ES	2330	12	LPG 3
Y10 i.e Junior		1.1	37	03.94 - 10.96	156C046	4	0,8	BCPR6ES	2330	12	LPG 3
Y10 i.e Mia		1.1	37	01.94 - 10.96	156C046	4	0,8	BCPR6ES	2330	12	LPG 3
Y10 i.e 4WD Sestrieres		1.1	37	03.94 - 10.96	156C046	4	0,8	BCPR6ES	2330	12	LPG 3
Y10 i.e Selectronic Ville		1.1	37	03.94 - 01.95	156C046	4	0,8	BCPR6ES	2330	12	LPG 3
Y10 i.e.		1.1	40	03.95 -		4	0,8	BCPR6ES	2330	12	LPG 3
Y10 Fire IE alle Modelle		1.1	41	01.89 - 10.96	156C000	4	0,8	BCPR6ES	2330	12	LPG 3
Y10 i.e GT/i.e GT Kat./Elite		1.3	53	11.87 - 09.92	156C5.046	4	0,8	BPR6ES	7822	2	LPG 2

**AVIA**

A21.1 D				10.90 -		4		Y-208T	1250		
---------	--	--	--	---------	--	---	--	--------	------	--	--

Code *l* kW

Cyl.



Stock-No.



LPG/CNG

**AZLK (MOSKWICZ)**

Aleko		1.8	70	12.86 - 12.00		4	0,8	BPR6ES	7822	2	LPG 2
Aleko		2.0	83	01.86 - 12.00	REN-F3R	4	0,9	BPR5ES	7422	6	LPG 2
Ish 2126		1.5		09.87 -		4	0,7	BP6ES	7811	4	LPG 2

**BEDFORD**

Astra Max D		1.6		02.85 -	16D OHC	4		Y-924J	7906	1	
Astra Van D		1.6		03.82 -	16D OHC	4		Y-924J	7906	1	
Brava Pickup 4x4		2.2		12.98 -				Y-306R	6244		
CF D		2.3		81 -		4		Y-924J	7906	1	
HA		1.3		81 -		4	0,7	BP6ES	7811	4	LPG 2

**BENTLEY**

Arnage		4.4	210	04.98 - 08.98	BMW M62B44	8		BKR6EK	2288	20	LPG 1
Arnage		4.4	210	08.98 -	BMW M62B44	8		BKR6EQUP	3199	30	LPG 1
Arnage Green Label V8 Biturbo		4.4	260	08.99 - 12.01		8		BKR6EQUP	3199	30	LPG 1
Arnage		4.4		09.99 - 01	BMW	8		BKR6EQUP	3199	30	LPG 1
Arnage Red Label V8 6.8 turbo		6.8		09.99 -	RR	8		BKR5EIX	6341		LPG 1
Arnage Le Mans		6.8		03.01 -	RR	8	0,9	BKR4EVX	4870		
Azure		6.8		03.95 -		8		BKR5EIX	6341		LPG 1
Azure Mulliner		6.8		03.99 -		8		BKR5EIX	6341		LPG 1
Brooklands		6.8		09.92 - 09.99		8		BKR5EIX	6341		LPG 1
Continental R		6.8		12.91 -		8		BKR5EIX	6341		LPG 1
Continental / Mulliner		6.8		02.97 -		8		BKR5EIX	6341		LPG 1
Continental R Mulliner		6.8		03.99 -		8		BKR5EIX	6341		LPG 1
Continental SC / Mulliner		6.8		03.99 - 09.00		8		BKR5EIX	6341		LPG 1
Continental R Le Mans		6.8		03.01 -		8		BKR5EIX	6341		LPG 1
Corniche 71—>02		6.8		07.93 - 08.95		8	0,9	BKR4EVX	4870		
Corniche 71—>02		6.8		09.95 -		8		BKR5EIX	6341		LPG 1
Mulsanne / S / Eight		6.8		07.93 -		8	0,9	BKR4EVX	4870		
Turbo R 85—>96		6.8		01.89 - 09.96		8		BKR5EIX	6341		LPG 1

**BERTONE**

Freeclimber 1.6i		1.6	74	02.92 -	M40 B16	4		BKR6EK	2288	20	LPG 1
Freeclimber 2.0i 4x4		2.0	95	01.91 -	M20 B20	6	0,8	ZGR5A	5839	15	
Freeclimber 2.7i 4x4		2.7	95	01.91 -	M20 B27	6	0,8	ZGR5A	5839	15	

**BMW  
1ER**

116i	E87	1.6	85	08.07 -	N45 B16	4		BKR6EQU	6002		LPG 1
116i	E81	1.6	90	08.07 -	N43 B16	4		ZKBR7A-HTU	91785		ZKBR7A-HTU
116i	E87	1.6	85	09.04 -	N45 B16	4		BKR6EQU	6002		LPG 1
116i	E87	1.6	90	08.07 -	N43 B16	4		ZKBR7A-HTU	91785		ZKBR7A-HTU
118 d	E87	2.0	90	09.04 -	M47 N204D4	4		Y-547AS	5968	47	
118 i	E81	2.0	95	04.07 -	N46 B20	4	1,1	IZFR6H11	4294		IZFR6H11
118 i	E81	2.0	105	05.07 -	N43 B20	4		ZKBR7A-HTU	91785		ZKBR7A-HTU
118 i	E87	2.0	95	09.04 -	N46 B20	4	1,1	IZFR6H11	4294		IZFR6H11
118 i	E87	2.0	105	05.07 -	N43 B20	4		ZKBR7A-HTU	91785		ZKBR7A-HTU
118 i Cabrio	E88	2.0	105	04.08 -	N43 B20	4		ZKBR7A-HTU	91785		ZKBR7A-HTU
120 i	E87	2.0	110	09.04 -	N46 B20	4	1,1	IZFR6H11	4294		IZFR6H11

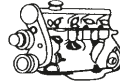
Code *l* kW

Cyl.



Stock-No.

BMW

LPG/CNG

**BMW****1ER**

120 d	E87	2.0	120	09.04 -	M47 N204D4	4	█	Y-547AS	5968	47	
120 i	E81	2.0	125	03.07 -	N43 B20	4		ZKBR7A-HTU	91785		ZKBR7A-HTU
120 i	E87	2.0	125	12.06 -	N43 B20	4		ZKBR7A-HTU	91785		ZKBR7A-HTU
120 i Cabrio	E88	2.0	125	04.08 -	N43 B20	4		ZKBR7A-HTU	91785		ZKBR7A-HTU
125 i Cabrio	E88	3.0	160	04.08 -	N52 B30	4	1,1	PLZFR6A11S	5987		
125 i Coupé	E82	3.0	160	09.07 -	N52 B30	6	1,1	PLZFR6A11S	5987		
130 i	E81	3.0	195	09.06 -	N52 B30	6	1,1	ILZFR6D11	1208		ILZFR6D11
130 i	E87	3.0	195	09.05 -	N52 B30	6	1,1	ILZFR6D11	1208		ILZFR6D11

**1ER F20**

114i	F20	1.6	75	11.11 -	N13B16A	4	0,8	PLZKBR7A-G	5843		
116i	F20	1.6	100	06.11 -	N13B16A	4	0,8	PLZKBR7A-G	5843		
118i	F20	1.6	125	06.11 -	N13B16A	4	0,8	PLZKBR7A-G	5843		

**3ER E36**

316 g Compact	E36	1.6	65	02.96 - 07.00	M43 B16	4		BKR6EK	2288	20	LPG 1
316 i	E36	1.6	73	05.91 - 08.93	M40 B16	4		BKR6EK	2288	20	LPG 1
316 i	E36	1.6	75	08.93 - 05.99	M43 B16	4		BKR6EK	2288	20	LPG 1
316 i Compact	E36	1.6	75	04.94 - 12.98	M43 B16	4		BKR6EK	2288	20	LPG 1
316 i Compact	E36	1.9	77	04.98 - 08.00	M43 B19	4		BKR6EK	2288	20	LPG 1
318 Tds	E36	1.8	66	11.94 - 02.98	M41 D18	4	█	Y-924J	7906	1	
318 i	E36	1.8	83	10.90 - 09.93	M40 B18	4		BKR6EK	2288	20	LPG 1
318 i	E36	1.8	85	08.93 - 09.99	M43 B18	4		BKR6EK	2288	20	LPG 1
318 i Touring	E36	1.8	85	09.94 - 09.99	M43 B18	4		BKR6EK	2288	20	LPG 1
318 iS	E36	1.8	103	10.91 - 03.96	M42 B18	4		BKR6EK	2288	20	LPG 1
318 ti Compact	E36	1.8	103	11.94 - 02.96	M42 B18	4		BKR6EK	2288	20	LPG 1
318 iS Coupe	E36	1.9	103	01.96 - 09.99	M44 B19	4		BKR6EK	2288	20	LPG 1
318 ti Compact	E36	1.9	103	02.95 - 12.98	M44 B19	4		BKR6EK	2288	20	LPG 1
320 i	E36	2.0	110	01.90 - 07.95	M50 B20	6		BKR6EK	2288	20	LPG 1
320 i	E36	2.0	110	09.94 - 09.99	M52 B20	6		BKR6EK	2288	20	LPG 1
320 i Touring	E36	2.0	110	04.94 - 05.99	M52 B20	6		BKR6EK	2288	20	LPG 1
323 i	E36	2.5	125	06.95 - 04.99	M52 B25	6		BKR6EK	2288	20	LPG 1
323 i Touring	E36	2.5	125	12.95 - 05.99	M52 B25	6		BKR6EK	2288	20	LPG 1
323 ti Compact	E36	2.5	125	10.97 - 12.98	M52 B25	6		BKR6EK	2288	20	LPG 1
325 i	E36	2.5	141	12.89 - 12.94	M50 B25	6		BKR6EK	2288	20	LPG 1
325 Td	E36	2.5	85	01.91 - 02.98	M51 D25	6	█	Y-924J	7906	1	
325 Tds	E36	2.5	105	06.93 - 05.99	M51 D25	6	█	Y-924J	7906	1	
328 i	E36	2.8	142	01.95 - 09.99	M52 B28	6		BKR6EK	2288	20	LPG 1
328 i Touring	E36	2.8	142	05.95 - 05.99	M52 B28	6		BKR6EK	2288	20	LPG 1
M3	E36	3.2	236	11.95 - 10.99	S50 B32	6	0,7	PKR7A	3641		PKR7A

**3ER E46**

316 Ci Coupé	E46	1.6	75	04.99 - 02.02	M43 B16	4		BKR6EQUP	3199	30	LPG 1
316 Ci Coupé	E46	1.8	85	03.02 - 02.04	N40 B18	4		BKR6EQUP	3199	30	LPG 1
316 Ci Coupé	E46	1.8	85	03.04 - 05.06	N45 B18	4	1,1	IZFR6H11	4294		IZFR6H11
316 i	E46	1.6	85	09.03 - 01.05	N45 B16	4	1,1	IZFR6H11	4294		IZFR6H11
316 i	E46	1.8	85	10.01 - 02.04	N42 B18	4		BKR6EQUP	3199	30	LPG 1
316 i	E46	1.8	85	09.03 - 01.05	N46 B18	4	1,1	IZFR6H11	4294		IZFR6H11
316 i	E46	1.9	77	01.99 - 09.01	M43 B19	4		BKR6EQUP	3199	30	LPG 1
316 i Touring	E46	1.8	85	10.01 - 02.04	N42 B18	4		BKR6EQUP	3199	30	LPG 1
316 i Touring	E46	1.8	85	10.03 - 07.05	N46 B18	4	1,1	IZFR6H11	4294		IZFR6H11
316 ti Compact	E46	1.8	85	05.01 - 02.04	N42 B18	4		BKR6EQUP	3199	30	LPG 1
316 ti Compact	E46	1.8	85	09.03 - 12.04	N46 B18	4	1,1	IZFR6H11	4294		IZFR6H11



Code

l kW



Cyl.



Stock-No.

VLINE  
BMW POWER

LPG/CNG

**BMW  
3ER E46**

318 Ci Cabrio	E46	2.0	105	12.00 - 03.05	N42 B20	4		BKR6EQUP	3199	30	LPG 1
318 Ci Cabrio	E46	2.0	110	04.05 - 08.06	N46 B20	4	1,1	IZFR6H11	4294		IZFR6H11
318 Ci Coupé	E46	1.9	87	09.99 - 08.01	M43 B19	4		BKR6EQUP	3199	30	LPG 1
318 Ci Coupé	E46	2.0	105	09.01 - 02.04	N42 B20	4		BKR6EQUP	3199	30	LPG 1
318 Ci Coupé	E46	2.0	110	10.03 - 05.06	N46 B20	4	1,1	IZFR6H11	4294		IZFR6H11
318 d	E46	2.0	85	09.01 - 11.03	M47 D20	4	☑	Y-507J	2691	32	
318 d	E46	2.0	85	08.02 - 01.05	M47 N D20	4	☑	Y-547AS	5968	47	
318 d Touring	E46	2.0	85	09.01 - 11.03	M47 D20	4	☑	Y-507J	2691	32	
318 d Touring	E46	2.0	85	08.02 - 07.05	M47 N D20	4	☑	Y-547AS	5968	47	
318 i	E46	1.9	87	04.98 - 08.01	M43 B19	4		BKR6EQUP	3199	30	LPG 1
318 i	E46	2.0	105	09.01 - 02.04	N42 B20	4		BKR6EQUP	3199	30	LPG 1
318 i	E46	2.0	105	10.03 - 02.05	N46 B20	4	1,1	IZFR6H11	4294		IZFR6H11
318 i Touring	E46	1.9	87	09.00 - 08.01	M43 B19	4		BKR6EQUP	3199	30	LPG 1
318 i Touring	E46	2.0	105	12.00 - 02.04	N42 B20	4		BKR6EQUP	3199	30	LPG 1
318 td Compact	E46	2.0	85	08.02 - 12.04	M47 N D20	4	☑	Y-547AS	5968	47	
318 ti Compact	E46	2.0	105	03.01 - 02.04	N42 B20	4		BKR6EQUP	3199	30	LPG 1
318 ti Compact	E46	2.0	105	09.03 - 12.04	N46 B20	4	1,1	IZFR6H11	4294		IZFR6H11
320 Cd	E46	2.0	110	03.03 - 05.06	M47 N D20	4	☑	Y-547AS	5968	47	
320 Cd Cabrio	E46	2.0	110	06.04 - 08.06	M47 N D20	4	☑	Y-547AS	5968	47	
320 Ci Cabrio	E46	2.2	125	02.00 - 08.06	M54 B22	6		BKR6EQUP	3199	30	LPG 1
320 Ci Coupé	E46	2.2	125	01.00 - 03.03	M54 B22	6		BKR6EQUP	3199	30	LPG 1
320 Ci Coupé	E46	2.0	110	11.98 - 08.01	M52 B20	6		BKR6EQUP	3199	30	LPG 1
320 d	E46	2.0	100	07.97 - 08.01	M47 D20	4	☑	Y-507J	2691	32	
320 d	E46	2.0	110	10.00 - 01.05	M47 N D20	4	☑	Y-547AS	5968	47	
320 d Touring	E46	2.0	100	02.99 - 08.01	M47 D20	4	☑	Y-507J	2691	32	
320 d Touring	E46	2.0	110	06.99 - 07.05	M47 N D20	4	☑	Y-547AS	5968	47	
320 i	E46	2.2	125	06.00 - 01.05	M54 B22	6		BKR6EQUP	3199	30	LPG 1
320 i	E46	2.0	110	07.97 - 07.01	M52 B20	6		BKR6EQUP	3199	30	LPG 1
320 i Touring	E46	2.2	125	05.01 - 07.05	M54 B22	6		BKR6EQUP	3199	30	LPG 1
320 i Touring	E46	2.0	110	05.98 - 08.01	M52 B20	6		BKR6EQUP	3199	30	LPG 1
320 td Compact	E46	2.0	110	05.00 - 12.04	M47 N D20	4	☑	Y-547AS	5968	47	
323 Ci Cabrio	E46	2.5	125	11.98 - 09.00	M52 B25	6		BKR6EQUP	3199	30	LPG 1
323 Ci Coupé	E46	2.5	125	03.98 - 08.00	M52 B25	6		BKR6EQUP	3199	30	LPG 1
323 i	E46	2.5	125	07.97 - 10.00	M52 B25	6		BKR6EQUP	3199	30	LPG 1
325 Ci Cabrio	E46	2.5	141	02.00 - 08.06	M54 B25	6		BKR6EQUP	3199	30	LPG 1
325 Ci Coupé	E46	2.5	141	01.00 - 05.06	M54 B25	6		BKR6EQUP	3199	30	LPG 1
325 i	E46	2.5	141	01.00 - 01.05	M54 B25	6		BKR6EQUP	3199	30	LPG 1
325 i Touring	E46	2.5	141	02.00 - 07.05	M54 B25	6		BKR6EQUP	3199	30	LPG 1
325 ti Compact	E46	2.5	141	03.00 - 12.04	M54 B25	6		BKR6EQUP	3199	30	LPG 1
325 Xi	E46	2.5	141	01.00 - 12.04	M54 B25	6		BKR6EQUP	3199	30	LPG 1
325 Xi Touring	E46	2.5	141	02.00 - 05.05	M54 B25	6		BKR6EQUP	3199	30	LPG 1
328 Ci Coupé	E46	2.8	142	03.98 - 06.00	M52 B28	6		BKR6EQUP	3199	30	LPG 1
328 i	E46	2.8	142	04.97 - 05.00	M52 B28	6		BKR6EQUP	3199	30	LPG 1
328 i Touring	E46	2.8	142	05.98 - 06.00	M52 B28	6		BKR6EQUP	3199	30	LPG 1
330 Cd Cabrio	E46	3.0	150	11.04 - 08.06	M57 N D30	6	☑	Y-547AS	5968	47	
330 Cd Coupé	E46	3.0	150	08.02 - 05.06	M57 N D30	6	☑	Y-547AS	5968	47	
330 Ci Cabrio	E46	3.0	170	12.99 - 08.06	M54 B30	6		BKR6EQUP	3199	30	LPG 1
330 Ci Coupé	E46	3.0	170	09.99 - 05.06	M54 B30	6		BKR6EQUP	3199	30	LPG 1
330 d	E46	3.0	135	09.00 - 11.03	M57 D30	6	☑	Y-507J	2691	32	
330 d	E46	3.0	150	03.03 - 02.05	M57 N D30	6	☑	Y-547AS	5968	47	
330 d Touring	E46	3.0	135	06.98 - 03.03	M57 D30	6	☑	Y-507J	2691	32	



Code *l* kW

Cyl.

Stock-No.  
**V-TUNE**  
E-FORWARD\*

LPG/CNG

**BMW****3ER E46**

330 d Touring	E46	3.0	150	09.02 - 07.05	M57 N D30	6	☑	Y-547AS	5968	47	
330 i	E46	3.0	170	09.99 - 01.05	M54 B30	6		BKR6EQUP	3199	30	LPG 1
330 i Touring	E46	3.0	170	09.99 - 07.05	M54 B30	6		BKR6EQUP	3199	30	LPG 1
330 Xd	E46	3.0	135	01.00 - 02.03	M57 D30	6	☑	Y-507J	2691	32	
330 Xd	E46	3.0	150	09.02 - 12.04	M57 N D30	6	☑	Y-547AS	5968	47	
330 Xd Touring	E46	3.0	150	08.02 - 05.05	M57 N D30	6	☑	Y-547AS	5968	47	
330 Xd Touring	E46	3.0	135	01.00 - 03.03	M57 D30	6	☑	Y-507J	2691	32	
330 Xi	E46	3.0	170	09.99 - 12.04	M54 B30	6		BKR6EQUP	3199	30	LPG 1
330 Xi Touring	E46	3.0	170	09.99 - 05.05	M54 B30	6		BKR6EQUP	3199	30	LPG 1
M3	E46	3.2	252	07.99 - 08.06	S54 B32	6		DCPR8EKP	7415		
M3 CSL	E46	3.2	265	09.02 - 12.03	S54 B32	6		DCPR8EKP	7415		

**3ER E90**

318 d	E90	2.0	90	09.05 - 09.07	M47 N204D4	4	☑	Y-547AS	5968	47	
318 i	E90	2.0	95	09.04 -	N46 B20	4	1,1	IZFR6H11	4294		IZFR6H11
318 i	E90	2.0	105	07.07 -	N43 B20	4		ZKBR7A-HTU	91785		ZKBR7A-HTU
320 d	E90	2.0	120	03.05 - 05.07	M47 N204D4	4	☑	Y-547AS	5968	47	
320 i	E90	2.0	110	03.05 -	N46 B20	4	1,1	IZFR6H11	4294		IZFR6H11
320 i	E90	2.0	125	05.07 -	N43 B20	4		ZKBR7A-HTU	91785		ZKBR7A-HTU
325 d	E90	3.0	145	03.06 -	M57 N2 D30	6	☑	Y-547AS	5968	47	
325 i	E90	2.5	160	03.05 -	N52 B25	6	1,1	ILZFR6D11	1208		ILZFR6D11
325 i	E90	3.0	160	09.07 -	N53 B30	6		ZKBR7A-HTU	91785		ZKBR7A-HTU
330 d	E90	3.0	170	01.06 -	M57 N2 D30	6	☑	Y-547AS	5968	47	
330 i	E90	3.0	190	03.05 -	N52 B30	6	1,1	ILZFR6D11	1208		ILZFR6D11
330 i	E90	3.0	200	07.07 -	N53 B30	6		ZKBR7A-HTU	91785		ZKBR7A-HTU
335 d	E90	3.0	210	09.06 -	M57 N2 D30	6	☑	Y-547AS	5968	47	
M3	E90	4.0	309	09.07 -	S65 B40	8		LKR8AP	4471		LKR8AP

**3ER E91**

318 d Touring	E91	2.0	90	09.05 - 09.07	M47 N204D4	4	☑	Y-547AS	5968	47	
318 i Touring	E91	2.0	105	09.07 -	N43 B20	4		ZKBR7A-HTU	91785		ZKBR7A-HTU
318 i Touring	E91	2.0	95	03.06 -	N46 B20	4	1,1	IZFR6H11	4294		IZFR6H11
320 d Touring	E91	2.0	120	09.05 - 11.07	M47 N204D4	4	☑	Y-547AS	5968	47	
320 i Touring	E91	2.0	110	10.05 -	N46 B20	4	1,1	IZFR6H11	4294		IZFR6H11
320 i Touring	E91	2.0	125	09.07 -	N43 B20	4		ZKBR7A-HTU	91785		ZKBR7A-HTU
325 d Touring	E91	3.0	145	03.06 -	M57 N2 D30	6	☑	Y-547AS	5968	47	
325 i Touring	E91	2.5	160	09.05 -	N52 B25	6	1,1	ILZFR6D11	1208		ILZFR6D11
325 i Touring	E91	3.0	160	09.07 -	N53 B30	6		ZKBR7A-HTU	91785		ZKBR7A-HTU
330 d Touring	E91	3.0	170	09.05 -	M57 N2 D30	6	☑	Y-547AS	5968	47	
330 i Touring	E91	3.0	190	09.05 -	N52 B30	6	1,1	ILZFR6D11	1208		ILZFR6D11
330 i Touring	E91	3.0	200	09.07 -	N53 B30	6		ZKBR7A-HTU	91785		ZKBR7A-HTU
335 d Touring	E91	3.0	210	09.06 -	M57 N2 D30	6	☑	Y-547AS	5968	47	

**3ER E92**

316 i Coupé	E92	2.0	90	08.07 -	N43 B16	4		ZKBR7A-HTU	91785		ZKBR7A-HTU
320 i Coupé	E92	2.0	115	10.06 -	N46 B20	4	1,1	IZFR6H11	4294		IZFR6H11
320 i Coupé	E92	2.0	125	03.07 -	N43 B20	4		ZKBR7A-HTU	91785		ZKBR7A-HTU
325 d Coupé	E92	3.0	145	03.06 -	M57 N2 D30	6	☑	Y-547AS	5968	47	
325 i Coupé	E92	2.5	160	09.06 -	N52 B25	6	1,1	ILZFR6D11	1208		ILZFR6D11
325 i Coupé	E92	3.0	160	09.07 -	N53 B30	6		ZKBR7A-HTU	91785		ZKBR7A-HTU
330 Cd	E92	3.0	170	09.06 -	M57 N2 D30	6	☑	Y-547AS	5968	47	
330 i Coupé	E92	3.0	200	09.06 -	N52 B30	6	1,1	ILZFR6D11	1208		ILZFR6D11
330 i Coupé	E92	3.0	200	09.07 -	N53 B30	6		ZKBR7A-HTU	91785		ZKBR7A-HTU

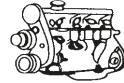
Code *l* kW

Cyl.



Stock-No.



LPG/CNG

**BMW  
3ER E92**

335 d Coupé	E92	3.0	210	09.06 -	M57 N2 D30	6		Y-547AS	5968	47	
M3	E92	4.0	309	03.07 -	S65 B40	8		LKR8AP	4471		LKR8AP

**3ER E93**

320 i Cabrio	E93	2.0	125	04.07 -	N46 B20	4	1,1	IZFR6H11	4294		IZFR6H11
325 i Cabrio	E93	2.5	160	04.07 -	N52 B25	6	1,1	ILZFR6D11	1208		ILZFR6D11
325 i Cabrio	E93	3.0	160	09.07 -	N53 B30	6		ZKBR7A-HTU	91785		ZKBR7A-HTU
330 d Cabrio	E93	3.0	170	04.07 -	M57 N2 D30	6		Y-547AS	5968	47	
330 i Cabrio	E93	3.0	200	04.07 -	N52 B30	6	1,1	ILZFR6D11	1208		ILZFR6D11
330 i Cabrio	E93	3.0	200	09.07 -	N53 B30	6		ZKBR7A-HTU	91785		ZKBR7A-HTU
M3	E93	4.0	309	09.07 -	S65 B40	8		LKR8AP	4471		LKR8AP

**5ER E34**

518 g Touring	E34	1.8	75	11.95 - 06.96	M43 B18	4		BKR6EK	2288	20	LPG 1
518 i	E34	1.8	83	09.89 - 04.94	M40 B18	4		BKR6EK	2288	20	LPG 1
518 i	E34	1.8	85	05.94 - 06.96	M43 B18	4		BKR6EK	2288	20	LPG 1
520 i	E34	2.0	95	01.88 - 08.91	M20 B20	6	0,8	ZGR5A	5839	15	
520 i	E34	2.0	110	03.89 - 06.96	M50 B20	6		BKR6EK	2288	20	LPG 1
524 Td	E34	2.4	85	03.88 - 08.91	M21 D24	6		Y-924J	7906	1	
525 Td	E34	2.5	85	06.92 - 06.96	M51 D25	6		Y-924J	7906	1	
525 Tds	E34	2.5	105	01.90 - 06.96	M51 D25	6		Y-924J	7906	1	
525 i	E34	2.5	125	01.88 - 08.91	M20 B25	6	0,8	ZGR5A	5839	15	
525 i	E34	2.5	141	01.89 - 06.96	M50 B25	6		BKR6EK	2288	20	LPG 1
525 iX	E34	2.5	141	01.92 - 09.95	M50 B25	6		BKR6EK	2288	20	LPG 1
530 i	E34	3.0	138	01.88 - 08.91	M30 B30	6	0,8	ZGR5A	5839	15	
530 i	E34	3.0	155	04.92 - 06.96	M60 B30	8		BKR6EK	2288	20	LPG 1
535 i	E34	3.5	155	01.88 - 08.92	M30 B35	6	0,8	ZGR5A	5839	15	
540 i	E34	4.0	210	03.92 - 06.96	M60 B40	8		BKR6EK	2288	20	LPG 1

**5ER E39**

520 d	E39	2.0	100	09.99 - 08.03	M47 D20	4		Y-507J	2691	32	
520 d Touring	E39	2.0	100	09.99 - 08.03	M47 D20	4		Y-507J	2691	32	
520 i	E39	2.0	110	01.96 - 08.98	M52 B20	6		BKR6EK	2288	20	LPG 1
520 i	E39	2.0	110	09.98 - 06.03	M52 B20	6		BKR6EQUP	3199	30	LPG 1
520 i Touring	E39	2.0	110	03.97 - 08.98	M52 B20	6		BKR6EK	2288	20	LPG 1
520 i Touring	E39	2.0	110	09.98 - 07.01	M52 B20	6		BKR6EQUP	3199	30	LPG 1
520 i	E39	2.2	125	08.00 - 09.03	M54 B22	6		BKR6EQUP	3199	30	LPG 1
520 i	E39	2.2	125	08.00 - 06.03	M54 B22	6		BKR6EQUP	3199	30	LPG 1
520 i Touring	E39	2.2	125	04.00 - 12.03	M54 B22	6		BKR6EQUP	3199	30	LPG 1
520 i Touring	E39	2.2	125	08.00 - 05.04	M54 B22	6		BKR6EQUP	3199	30	LPG 1
525 Tds	E39	2.5	105	03.95 - 10.00	M51 D25	6		Y-924J	7906	1	
525 d	E39	2.5	120	03.00 - 12.03	M57 D25	6		Y-507J	2691	32	
525 d Touring	E39	2.5	120	03.00 - 12.03	M57 D25	6		Y-507J	2691	32	
523 i	E39	2.5	125	12.95 - 08.98	M52 B25	6		BKR6EK	2288	20	LPG 1
523 i	E39	2.5	125	09.98 - 12.00	M52 B25	6		BKR6EQUP	3199	30	LPG 1
523 i Touring	E39	2.5	125	03.97 - 08.98	M52 B25	6		BKR6EK	2288	20	LPG 1
523 i Touring	E39	2.5	125	09.98 - 12.00	M52 B25	6		BKR6EQUP	3199	30	LPG 1
525 i	E39	2.5	141	11.99 - 11.03	M54 B25	6		BKR6EQUP	3199	30	LPG 1
525 i Touring	E39	2.5	141	04.00 - 12.03	M54 B25	6		BKR6EQUP	3199	30	LPG 1
528 i	E39	2.8	142	12.95 - 08.98	M52 B28	6		BKR6EK	2288	20	LPG 1
528 i	E39	2.8	142	09.98 - 11.00	M52 B28	6		BKR6EQUP	3199	30	LPG 1
528 i Touring	E39	2.8	142	03.97 - 08.98	M52 B28	6		BKR6EK	2288	20	LPG 1
528 i Touring	E39	2.8	142	09.98 - 12.00	M52 B28	6		BKR6EQUP	3199	30	LPG 1

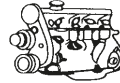
Code *l* kW

Cyl.

Stock-No.  
**VEFINE****B-Power**  
LPG/CNG**BMW****5ER E39**

530 d	E39	3.0	142	09.98 - 12.03	M57 D30	6	☑	Y-507J	2691	32	
530 d Touring	E39	3.0	142	02.99 - 03.04	M57 D30	6	☑	Y-507J	2691	32	
530 i	E39	3.0	170	04.00 - 06.03	M54 B30	6		BKR6EQUP	3199	30	LPG 1
530 i Touring	E39	3.0	170	11.99 - 12.03	M54 B30	6		BKR6EQUP	3199	30	LPG 1
535 i	E39	3.5	180	06.96 - 08.98	M62 B35	8		BKR6EK	2288	20	LPG 1
535 i	E39	3.5	180	09.98 - 09.03	M62 B35	8		BKR6EQUP	3199	30	LPG 1
540 i	E39	4.4	210	04.96 - 08.98	M62 B44	8		BKR6EK	2288	20	LPG 1
540 i	E39	4.4	210	09.98 - 11.03	M62 B44	8		BKR6EQUP	3199	30	LPG 1
540 i Touring	E39	4.4	210	03.97 - 08.98	M62 B44	8		BKR6EK	2288	20	LPG 1
540 i Touring	E39	4.4	210	09.98 - 12.03	M62 B44	8		BKR6EQUP	3199	30	LPG 1
M5	E39	5.0	294	09.98 - 07.03	S62 B50	8		BKR6EQUP	3199	30	LPG 1

**5ER E60**

520 d	E60	2.0	120	02.05 - 09.07	M47 N204D4	4	☑	Y-547AS	5968	47	
520 i	E60	2.0	125	05.07 -	N43 B20	4		ZKBR7A-HTU	91785		ZKBR7A-HTU
520 i	E60	2.2	125	02.02 - 02.05	M54 B22	6		BKR6EQUP	3199	30	LPG 1
523 i	E60	2.5	130	07.04 - 11.06	N52 B25	6	1,1	ILZFR6D11	1208		ILZFR6D11
525 d	E60	2.5	130	03.04 - 11.06	M57 N D25	6	☑	Y-547AS	5968	47	
523 i	E60	2.5	140	02.07 -	N53 B25	6		ZKBR7A-HTU	91785		ZKBR7A-HTU
525 i	E60	2.5	141	09.03 - 12.04	M54 B25	6		BKR6EQUP	3199	30	LPG 1
525 d	E60	2.5	145	12.06 -	M57 N2 D25	6	☑	Y-547AS	5968	47	
525 i	E60	2.5	160	09.04 -	N52 B25	6	1,1	ILZFR6D11	1208		ILZFR6D11
525 i	E60	2.5	160	03.07 -	N53 B25	6		ZKBR7A-HTU	91785		ZKBR7A-HTU
530 d	E60	3.0	160	08.02 - 10.05	M57 N D30	6	☑	Y-547AS	5968	47	
530 Xd	E60	3.0	160	10.05 -	M57 N D30	6	☑	Y-547AS	5968	47	
530 d	E60	3.0	170	02.05 -	M57 N2 D30	6	☑	Y-547AS	5968	47	
530 i	E60	3.0	170	07.03 - 12.04	M54 B30	6		BKR6EQUP	3199	30	LPG 1
530 i	E60	3.0	190	10.04 -	N52 B30	6	1,1	ILZFR6D11	1208		ILZFR6D11
530 i	E60	3.0	200	01.07 -	N53 B30	6		ZKBR7A-HTU	91785		ZKBR7A-HTU
535 d	E60	3.0	200	09.04 - 02.05	M57 N D30	6	☑	Y-547AS	5968	47	
535 d	E60	3.0	210	09.05 -	M57 N2 D30	6	☑	Y-547AS	5968	47	
540 i	E60	4.0	225	10.05 -	N62 B40	8	1,1	IZFR6H11	4294		IZFR6H11
545 i	E60	4.4	245	09.03 - 10.05	N62 B44	8		BKR6EQUP	3199	30	LPG 1
550 i	E60	4.8	270	02.05 -	N62 B48	8	1,1	IZFR6H11	4294		IZFR6H11
M5	E60	5.0	373	11.04 -	S85 B50	10		LKR8AP	4471		LKR8AP

**5ER E61**

520 d Touring	E61	2.0	120	11.05 -	M47 N204D4	4	☑	Y-547AS	5968	47	
523 i Touring	E61	2.5	130	03.05 -	N52 B25	6	1,1	ILZFR6D11	1208		ILZFR6D11
525 d Touring	E61	2.5	130	05.04 -	M57 N D25	6	☑	Y-547AS	5968	47	
523 i Touring	E61	2.5	140	03.07 -	N53 B25	6		ZKBR7A-HTU	91785		ZKBR7A-HTU
525 i Touring	E61	2.5	141	05.04 - 12.04	M54 B25	6		BKR6EQUP	3199	30	LPG 1
525 i Touring	E61	2.5	160	09.04 -	N52 B25	6	1,1	ILZFR6D11	1208		ILZFR6D11
525 i Touring	E61	2.5	160	03.07 -	N53 B25	6		ZKBR7A-HTU	91785		ZKBR7A-HTU
530 d Touring	E61	3.0	160	11.02 - 10.05	M57 N D30	6	☑	Y-547AS	5968	47	
530 d Touring	E61	3.0	173	02.05 -	M57 N2 D30	6	☑	Y-547AS	5968	47	
530 d Touring	E61	3.0	180	02.10 -	M57 N2 D30	6	☑	Y-547AS	5968	47	
530 i Touring	E61	3.0	190	10.05 -	N52 B30	6	1,1	ILZFR6D11	1208		ILZFR6D11
530 i Touring	E61	3.0	200	01.07 -	N53 B30	6		ZKBR7A-HTU	91785		ZKBR7A-HTU
535 d Touring	E61	3.0	200	09.04 -	M57 N D30	6	☑	Y-547AS	5968	47	
545 i Touring	E61	4.4	245	05.04 - 08.05	N62 B44	8		BKR6EQUP	3199	30	LPG 1
550 i Touring	E61	4.8	270	02.05 -	N62 B48	8	1,1	IZFR6H11	4294		IZFR6H11

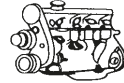
Code *l* kW

Cyl.



Stock-No.



LPG/CNG

**BMW****5ER F10**

523 i	F10	3.0	150	03.10 -	N53 B30	6		ZKBR7A-HTU	91785		
528 i	F10	3.0	190	03.10 -	N53 B30	6		ZKBR7A-HTU	91785		

**5ER F11**

523 i Touring	F11	3.0	150	08.10 -	N53 B30	6		ZKBR7A-HTU	91785		
528 i Touring	F11	3.0	190	08.10 -	N53 B30	6		ZKBR7A-HTU	91785		

**6ER E63**

630 Ci	E63	3.0	190	02.04 -	N52 B30	6	1,1	ILZFR6D11	1208		ILZFR6D11
630 Ci	E63	3.0	200	04.06 -	N53 B30	6		ZKBR7A-HTU	91785		ZKBR7A-HTU
635 Cd	E63	3.0	210	05.06 -	M57 N2 D30	6	<input checked="" type="checkbox"/>	Y-547AS	5968	47	
635 Ci	E63	3.6	200	09.04 -	N62 B36	8		BKR6EQUP	3199	30	LPG 1
645 Ci	E63	4.4	245	09.02 - 08.05	N62 B44	8		BKR6EQUP	3199	30	LPG 1
650 Ci	E63	4.8	270	10.05 -	N62 B48	8	1,1	IZFR6H11	4294		IZFR6H11
M6	E63	5.0	373	09.04 -	S85 B50	10		LKR8AP	4471		LKR8AP

**6ER E64**

630 Ci Cabrio	E64	3.0	190	09.04 -	N52 B30	6	1,1	ILZFR6D11	1208		ILZFR6D11
645 Ci Cabrio	E64	4.4	245	02.04 - 09.05	N62 B44	8		BKR6EQUP	3199	30	LPG 1
650 Ci Cabrio	E64	4.8	270	03.05 -	N62 B48	8	1,1	IZFR6H11	4294		IZFR6H11
M6 Cabrio	E64	5.0	373	07.05 -	S85 B50	10		LKR8AP	4471		LKR8AP

**7ER E32**

730 i	E32	3.0	136	09.86 - 08.92	M30 B30	6	0,8	ZGR5A	5839	15	
730 i	E32	3.0	160	04.92 - 09.94	M60 B30	8		BKR6EK	2288	20	LPG 1
735 i	E32	3.4	155	09.86 - 07.92	M30 B35	6	0,8	ZGR5A	5839	15	
740 i	E32	4.0	210	04.92 - 09.94	M60 B40	8		BKR6EK	2288	20	LPG 1
750 i	E32	5.0	220	09.87 - 09.94	M70 B50	12	0,7	ZFR5F	5165		LPG 6

**7ER E38**

725 Tds	E38	2.5	105	09.95 - 11.00	M51 D25	6	<input checked="" type="checkbox"/>	Y-924J	7906	1	
728 i	E38	2.8	142	09.95 - 08.98	M52 B28	6		BKR6EK	2288	20	LPG 1
728 i	E38	2.8	142	09.98 - 11.01	M52 B28	6		BKR6EQUP	3199	30	LPG 1
730 d	E38	3.0	142	09.98 - 12.01	M57 D30	6	<input checked="" type="checkbox"/>	Y-507J	2691	32	
730 i	E38	3.0	160	09.94 - 09.95	M60 B30	8		BKR6EK	2288	20	LPG 1
735 i	E38	3.5	175	03.96 - 08.98	M62 B35	8		BKR6EK	2288	20	LPG 1
735 i	E38	3.5	175	09.98 -	M62 B35	8		BKR6EQUP	3199	30	LPG 1
740 i	E38	4.0	210	09.94 - 05.95	M60 B40	8		BKR6EK	2288	20	LPG 1
740 i	E38	4.4	210	05.95 - 08.98	M62 B44	8		BKR6EK	2288	20	LPG 1
740 i	E38	4.4	210	09.99 - 11.01	M62 B44	8		BKR6EQUP	3199	30	LPG 1
750 i	E38	5.4	240	11.94 -	M73 B54	12		BKR6EQUP	3199	30	LPG 1

**7ER E65**

730 d	E65	3.0	150	11.01 - 02.05	M57 N D30	6	<input checked="" type="checkbox"/>	Y-547AS	5968	47	
730 d	E65	3.0	170	07.04 -	M57 N2 D30	6	<input checked="" type="checkbox"/>	Y-547AS	5968	47	
730 i	E65	3.0	170	10.02 - 02.05	M54 B30	6		BKR6EQUP	3199	30	LPG 1
730 i	E65	3.0	190	03.05 -	N52 B30	6	1,1	ILZFR6D11	1208		ILZFR6D11
735 i	E65	3.6	200	07.01 - 02.05	N62 B36	8		BKR6EQUP	3199	30	LPG 1
740 i	E65	4.0	225	01.05 -	N62 B40	8	1,1	IZFR6H11	4294		IZFR6H11
745 i	E65	4.4	245	07.01 - 02.05	N62 B44	8		BKR6EQUP	3199	30	LPG 1
750 i	E65	4.8	270	01.05 -	N62 B48	8	1,1	IZFR6H11	4294		IZFR6H11
760 i	E65	6.0	327	01.03 -	N73 B60	12		BKR6EQUP	3199	30	LPG 1

**8ER E31**

840 Ci	E31	4.0	210	12.93 - 02.96	M60 B40	8		BKR6EK	2288	20	LPG 1
--------	-----	-----	-----	---------------	---------	---	--	--------	------	----	-------



Code *l* kW

Cyl.



Stock-No.

V-TIME

E-FORWARD

LPG/CNG

**BMW****8ER E31**

840 Ci	E31	4.4	210	03.96 - 05.99	M62 B44	8		BKR6EK	2288	20	LPG 1
850 Ci	E31	5.0	220	05.89 - 10.94	M70 B50	12	0,7	ZFR5F	5165		LPG 6
850 Ci	E31	5.4	240	10.94 - 05.99	M73 B54	12		BKR6EQUP	3199	30	LPG 1
850 CSI	E31	5.6	280	02.93 - 11.96	S70 B56	12	0,7	ZFR5F	5165		LPG 6

**X1 E84**

X 1 Xdrive18i	E84	2.0	110	09.08 -	N46 B20	4	1,1	IZFR6H11	4294		IZFR6H11
X 1 Xdrive25i	E84	3.0	160	09.08 -	N52 B30	6	1,1	PLZFR6A11S	5987		
X 1 Xdrive28i	E84	3.0	190	09.08 -	N52 B30	6	1,1	PLZFR6A11S	5987		

**X3 E83**

X 3 xDrive20d 4x4	E83	2.0	110	09.04 -	M47 N D20	4	█	Y-547AS	5968	47	
X 3 xDrive20i 4x4	E83	2.0	110	09.05 -	N46 B20	4	1,1	IZFR6H11	4294		IZFR6H11
X 3 xDrive25i 4x4	E83	2.5	141	01.04 -	M54 B25	6		BKR6EQUP	3199	30	LPG 1
X 3 xDrive25i 4x4	E83	2.5	160	08.06 -	N52 B25	6	1,1	ILZFR6D11	1208		ILZFR6D11
X 3 xDrive30d 4x4	E83	3.0	150	01.03 - 09.05	M57 N D30	6	█	Y-547AS	5968	47	
X 3 xDrive30d 4x4	E83	3.0	160	10.04 -	M57 N2 D30	6	█	Y-547AS	5968	47	
X 3 xDrive30i 4x4	E83	3.0	170	01.04 -	M54 B30	6		BKR6EQUP	3199	30	LPG 1
X 3 xDrive30i 4x4	E83	3.0	200	06.06 -	N52 B30	6	1,1	ILZFR6D11	1208		ILZFR6D11
X 3 xDrive35d 4x4	E83	3.0	210	09.06 -	M57 N2 D30	6	█	Y-547AS	5968	47	

**X5 E53**

X 5d 4x4	E53	3.0	142	08.01 - 11.03	M57 D30	6	█	Y-507J	2691	32	
X 5d 4x4	E53	3.0	160	01.03 - 09.06	M57 N D30	6	█	Y-547AS	5968	47	
X 5i 4x4	E53	3.0	170	08.99 - 09.06	M54 B30	6		BKR6EQUP	3199	30	LPG 1
X 5i 4x4	E53	4.4	210	10.98 - 09.03	M62 B44	8		BKR6EQUP	3199	30	LPG 1
X 5i 4x4	E53	4.4	235	01.03 - 09.06	N62 B44	8		BKR6EQUP	3199	30	LPG 1
X 5 4.6 iS 4x4	E53	4.6	255	01.01 - 09.03	M62 B46	8		BKR6EQUP	3199	30	LPG 1
X 5 4.8 iS 4x4	E53	4.8	265	11.03 - 09.06	N62 B48	8	1,1	IZFR6H11	4294		IZFR6H11

**X5 E70**

X 5d 4x4	E70	3.0	173	07 -	M57 N2 D30	6	█	Y-547AS	5968	47	
X 5i 3.0 si 4x4	E70	3.0	200	02.07 -	N52 B30	6	1,1	ILZFR6D11	1208		ILZFR6D11
X 5 3.0 sd 4x4	E70	3.0	210	07 -	M57 N2 D30	6	█	Y-547AS	5968	47	
X 5 4.8 iS 4x4	E70	4.8	261	02.07 -	N62 B48	8	1,1	IZFR6H11	4294		IZFR6H11

**Z3 E36/7**

Z 3	E36/7	1.8	85	02.96 - 09.98	M43 B18	4		BKR6EK	2288	20	LPG 1
Z 3	E36/7	1.8	85	01.98 - 02.99	M43 B18	4		BKR6EQUP	3199	30	LPG 1
Z 3	E36/7	1.9	87	03.99 - 06.02	M43 B19	4		BKR6EQUP	3199	30	LPG 1
Z 3	E36/7	1.9	103	11.95 - 03.99	M44 B19	4		BKR6EK	2288	20	LPG 1
Z 3	E36/7	2.0	110	09.98 - 12.00	M52 B20	6		BKR6EQUP	3199	30	LPG 1
Z 3	E36/7	2.2	125	12.99 - 06.02	M54 B22	6		BKR6EQUP	3199	30	LPG 1
Z 3	E36/7	2.8	142	06.96 - 09.98	M52 B28	6		BKR6EK	2288	20	LPG 1
Z 3	E36/7	2.8	142	01.98 - 05.00	M52 B28	6		BKR6EQUP	3199	30	LPG 1
Z 3 Coupé	E36/7	2.8	142	01.98 - 12.00	M52 B28	6		BKR6EQUP	3199	30	LPG 1
Z 3	E36/7	3.0	170	09.99 - 06.02	M54 B30	6		BKR6EQUP	3199	30	LPG 1
Z 3 Coupé	E36/7	3.0	170	09.99 - 06.02	M54 B30	6		BKR6EQUP	3199	30	LPG 1
Z 3 M	E36/7	3.2	236	04.96 - 06.00	S50 B32	6	0,7	PKR7A	3641		PKR7A
Z 3 M	E36/7	3.2	239	03.00 - 05.02	S54 B32	6		DCPR8EKP	7415		
Z 3 M Coupé	E36/7	3.2	236	09.97 - 07.00	S50 B32	6	0,7	PKR7A	3641		PKR7A
Z 3 M Coupé	E36/7	3.2	239	03.00 - 05.02	S54 B32	6		DCPR8EKP	7415		

**Z4 E85**

Z 4	E85	2.0	110	09.04 -	N46 B20	4	1,1	IZFR6H11	4294		IZFR6H11
-----	-----	-----	-----	---------	---------	---	-----	----------	------	--	----------

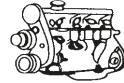
Code *l* kW

Cyl.



Stock-No.



LPG/CNG

**BMW****Z4 E85**

Z 4	E85	2.2	125	09.03 -	M54 B22	6		BKR6EQUP	3199	30	LPG 1
Z 4	E85	2.5	130	07 -	N52 B25	6	1,1	ILZFR6D11	1208		ILZFR6D11
Z 4	E85	2.5	141	04.03 -	M54 B25	6		BKR6EQUP	3199	30	LPG 1
Z 4si	E85	2.5	160	10.04 -	N52 B25	6	1,1	ILZFR6D11	1208		ILZFR6D11
Z 4	E85	3.0	170	04.03 -	M54 B30	6		BKR6EQUP	3199	30	LPG 1
Z 4 si	E85	3.0	195	10.05 -	N52 B30	6	1,1	ILZFR6D11	1208		ILZFR6D11
Z 4 M	E85	3.2	252	03.06 -	S54 B32	6		DCPR8EKP	7415		

**Z4 E86**

Z 4 si Coupé	E86	3.0	195	10.05 -	N52 B30	6	1,1	ILZFR6D11	1208		ILZFR6D11
Z 4 M Coupé	E86	3.2	252	10.05 -	S54 B32	6		DCPR8EKP	7415		

**Z4 E89**

Z 4 23i	E89	2.5	150	05.09 -	N52 B25	6	1,1	PLZFR6A11S	5987		
Z 4 30i	E89	3.0	190	05.09 -	N52 B30	6	1,1	PLZFR6A11S	5987		

**Z8 E52**

Z 8	E52	5.0	294	06.00 - 07.03	S62 B50	8		BKR6EQUP	3199	30	LPG 1
-----	-----	-----	-----	---------------	---------	---	--	----------	------	----	-------

**BUICK**

Century		2.2		93 - 94	4	4	1,0	TR4	3754		LPG 5
Century		2.2		95 - 96	4	4	1,5	TR55-1	2683		
Century		2.5		84 - 92	R	4	1,5	UR55	2248		
Century		2.8		83 -	X 2 bbl CID173	6	1,3	UR5	2771		UR6IX
Century		3.0		83 -	E 2 bbl CID181	6	1,5	UR45	6945		UR5IX
Century		3.1		94 - 99	M OHV V6	6	1,3	TR55IX	7164		LPG 5
Century		3.1		00 -	J OHV V6	6	1,3	TR55IX	7164		LPG 5
Century		3.3		89 - 93	N V6	6	1,5	TR55	3951		LPG 5
Century		3.8		86 -	B V6	6	1,0	TR5	2238		LPG 5
Lacrosse		3.6		05 -	V6 2 FI	6	1,5	TR55	3951		LPG 5
Lacrosse		3.6		05 -	V6 7 FI 217	6	1,0	PLTR6A-10G	3587		
LeSabre		3.0		86 -	L V6	6	1,0	TR5	2238		LPG 5
LeSabre		3.8		92 - 95	L V6	6	1,5	PTR4B-15	5146		LPG 5
LeSabre		3.8		96 - 01	K V6	6	1,5	PTR4B-15	5146		LPG 5
LeSabre		3.8		02 -	K V6	6	1,5	PTR4B-15	5146		LPG 5
LeSabre		4.4		81 -	J 2 bbl CID267	8	1,1	UR4	6630		UR5IX
Park Avenue		3.8		91 -	K V6	6	1,5	PTR4B-15	5146		LPG 5
Park Avenue		3.8		92 - 97	1 V6 Super Charged	6	1,5	PTR4B-15	5146		LPG 5
Park Avenue		3.8		02 -	V6 1 FI Supercharged	6	1,5	TR55	3951		LPG 5
Park Avenue		3.8		02 -	V6 K FI	6	1,5	TR55	3951		LPG 5
Regal		3.8		82 -	3 4 bbl CID231	6	1,5	UR45	6945		UR5IX
Regal		3.8		83 -	8 4 bbl CID231	6	1,5	UR45	6945		UR5IX
Regal		3.8		96 -	K V6 MFI	6	1,5	PTR4B-15	5146		LPG 5
Regal		3.8		96 -	SC V6 MFI 1	6	1,5	PTR4B-15	5146		LPG 5
Rivera		3.8		96 - 97	K V6 MFI	6	1,5	PTR4B-15	5146		LPG 5
Rivera		3.8		96 -	SC V6 MFI 1	6	1,5	PTR4B-15	5146		LPG 5
Riviera		3.8		83 -	8 4 bbl CID231	6	1,5	UR45	6945		UR5IX

**CADILLAC**

Allante		4.6		91 - 94	8 / 9 MFI	8	1,5	TR55	3951		LPG 5
BLS 1.9 D		1.9	110	04.06 -	Z19DTH	4		YE07	6092		

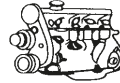
Code *l* kW

Cyl.

Stock-No.  
**V-TUNE**  
**16-POWER**

LPG/CNG

**CADILLAC**

Brougham		5.0		91 - 92	E TBI	8	1,1	UR4	6630		UR5IX
Brougham		5.7		91 - 92	7 TBI	8	1,3	UR5	2771		UR6IX
Brougham		5.7		93 -	7 TBI	8	1,1	UR4	6630		UR5IX
Catera		3.0		97 - 01	R DOHC MFI	6		BKR5EK	7956	23	LPG 1
Concours		4.6		94 - 94	Y SFI	8	1,5	TR55	3951		LPG 5
Concours		4.6		95 - 95	Y MFI	8	1,5	TR55	3951		LPG 5
Concours		4.6		96 - 98	9 MFI	8	1,5	TR55	3951		LPG 5
CTS-V		5.7	298	05 -		8	1,5	TR55	3951		LPG 5
De Ville		4.6		96 - 98	Y MFI	8	1,5	TR55	3951		LPG 5
De Ville		4.6		99 -	Y MFI	8	1,5	TR55	3951		LPG 5
De Ville		4.6		01 -	9 MFI	8	1,5	TR55	3951		LPG 5
De Ville		4.9		92 - 95	B MFI	8	1,5	TR55	3951		LPG 5
DeVille		6.0		81 -	9 EFI CID368	8	1,2	GR45	2822		GR5IX
Eldorado		4.6		93 - 93	9 / Y MFI	8	1,5	TR55	3951		LPG 5
Eldorado		4.6		94 - 98	9 MFI / SFI	8	1,5	TR55	3951		LPG 5
Eldorado		4.6		94 - 98	Y MFI / SFI	8	1,5	TR55	3951		LPG 5
Eldorado		4.6		99 -	V8 MFI 9	8	1,5	TR55	3951		LPG 5
Eldorado		4.6		99 -	V8 MFI Y	8	1,5	TR55	3951		LPG 5
Eldorado		4.9		92 - 93	B MFI	8	1,5	TR55	3951		LPG 5
Seville		4.6		99 -	V8 MFI 9	8	1,5	TR55	3951		LPG 5
Seville		4.6		99 -	V8 MFI Y	8	1,5	TR55	3951		LPG 5
SRX Sport Luxury		4.6	239	10.04 -	A V8 FI	8	1,5	TR55	3951		LPG 5
XLR		4.6	239	05 -	A V8 FI	8	1,5	TR55	3951		LPG 5

**CARBODIES**

FL2/R Hire Car				08.83 -				Y-208T	1250		
FX4R 2.25 Taxi		2.2		08.83 -				Y-208T	1250		

**CATERHAM**

Super Seven				85 -		4	0,6	B8ECS	2841		
Super Seven HPC		2.0	110	07.91 -	Opel 16V	4	0,8	BCPR7ES	3330		BCPR7EIX

**CHEVROLET**

<b>ALERO</b>											
Alero		3.4		03.99 -	LA1	6	1,5	TR55	3951		LPG 5

<b>AVEO</b>											
Aveo 1.2		1.2	53	02.05 - 08	F12S3	4	1,1	BPR5EY-11	3028		LPG 2
Aveo 1.2		1.2	55	04.08 - 12.11	B12D1	4	0,9	DCPR8E	4339		LPG 8
Aveo 1.2		1.2	62	04.08 -	B12D1	4	0,9	DCPR8E	4339		LPG 8
Aveo 1.4		1.4	69	02.05 - 08	F14D3	4	1,1	BKR6E-11	2756	14	LPG 1
Aveo 1.4		1.4	74	08 -	F14D4	4	1,1	ZFR6F-11	4291		LPG 6

<b>BLAZER</b>											
Blazer		4.3		95 - 05	V6 W EFI	6	1,3	UR5	2771		UR6IX
Blazer		4.3		96 - 02	V6 W EFI	6	1,0	TR5	2238		LPG 5
Blazer		4.3		03 - 03	V6 X EFI	6	1,0	TR5	2238		LPG 5
Blazer		5.7		87 - 93	V8 K EFI	8	1,3	UR5	2771		UR6IX
Blazer		5.7		87 - 93	V8 K TBI	8	1,3	UR5	2771		UR6IX
Blazer		5.7		94 - 94	V8 K EFI	8	1,3	UR6	7773		
Blazer		5.7		94 -	V8 K TBI	8	1,3	UR6	7773		

<b>CAMARO</b>											
Camaro		2.8		82 -	1 2 bbl CID173	6	1,3	UR5	2771		UR6IX

Code *l* kW

Cyl.



Stock-No.



LPG/CNG

## CHEVROLET CAMARO

Camaro		3.1		90 - 92	T V6 EFI	6	1,3	UR5	2771		UR6IX
Camaro		3.4		93 - 95	S V6 EFI	6	1,3	UR5	2771		UR6IX
Camaro		3.8		96 -	V6 MFI K	6	1,5	TR55	3951		LPG 5
Camaro		3.8		01 -		6	1,5	PTR4B-15	5146		LPG 5
Camaro		5.0		82 -	7 EFI CID305	8	1,1	UR4	6630		UR5IX
Camaro		5.0		83 -	S EFI CID305	8	1,1	UR4	6630		UR5IX
Camaro		5.0		85 - 92	F V8 EFI	8	1,1	UR4	6630		UR5IX
Camaro		5.0		88 - 92	E V8 EFI	8	1,1	UR4	6630		UR5IX
Camaro		5.7		87 - 92	V8 EFI Alu Heads	8	0,9	FR4	5188		
Camaro		5.7		87 - 92	V8 EFI Cast Iron Heads	8	1,1	UR4	6630		UR5IX
Camaro		5.7		93 - 97	P V8 EFI	8	1,5	TR55	3951		LPG 5
Camaro		5.7		98 - 02	G V8 EFI	8	1,5	TR55	3951		LPG 5
Caprice		3.8		83 -	9 2 bbl CID229	6	1,1	UR4	6630		UR5IX

## CAPTIVA

Captiva 2.0 D		2.0	93	10.06 -	Z20S	4		Y8009AS	96478		
Captiva 2.0 D		2.0	110	10.06 -	Z20S	4		Y8009AS	96478		
Captiva 2.4		2.4	100	09.06 -	Z24SED	4		BKR5EK	7956	23	LPG 1
Captiva 3.2		3.2	169	09.06 -	Z32SED	6	1,3	PTR5A-13	2467	25	LPG 4

## CORVETTE

Corvette		5.7	294	97 - 00	G V8 EFI	8	1,5	TR55	3951		LPG 5
Corvette		5.7		82 -	4, 6, 8, H, L, X 4 bbl, EFI CID350	8	1,1	UR4	6630		UR5IX
Corvette		5.7		90 - 92	J V8 EFI ZR1	8	1,5	TR55	3951		LPG 5
Corvette		5.7		92 - 96	P V8 EFI	8	1,5	TR55	3951		LPG 5
Corvette		5.7		93 - 95	J V8 EFI	8	1,5	TR55	3951		LPG 5
Corvette		5.7		96 - 96	5 V8 EFI	8	1,5	TR55	3951		LPG 5
Corvette		5.7		01 - 03	G V8 EFI	8	1,5	TR55	3951		LPG 5
Corvette		5.7		01 - 01	S V8 EFI	8	1,5	TR55	3951		LPG 5
Corvette		5.7		03 - 04	V8	8	1,5	PZTR5A-15	7862		
Corvette		6.0		05 -	V8	8	1,5	PZTR5A-15	7862		

## CRUZE

Cruze 1.6	J300 / J305	1.6	83	05.09 -	F16D4	4	1,1	ZFR6F-11	4291		LPG 6
Cruze 1.6	J300 / J305	1.6	91	05.09 -	F16D4	4	1,1	ZFR6F-11	4291		LPG 6
Cruze 1.8	J300 / J305	1.8	104	05.09 -	F18D4	4	1,1	ZFR6F-11	4291		LPG 6
Cruze 2.0 D	J300 / J305	2.0	92	05.09 - 05.11	Z20S1	4		Y8009AS	96478		
Cruze 2.0 D	J300 / J305	2.0	110	05.09 -	Z20S1	4		Y8009AS	96478		

## EPICA

Epica 2.0		2.0	106	06.06 -	XK	6		BKUR6ETB	6992		
Epica 2.0 D		2.0	110	01.07 -	Z20DMH	4		Y8009AS	96478		
Epica 2.5 V6		2.5	115	06.06 -		6	1,1	IFR6E11	6741		

## EVANDA

Evanda 2.0		2.0	96	02.05 -	T20SED DOHC 16v	4		BKR5EK	7956	23	LPG 1
------------	--	-----	----	---------	-----------------	---	--	--------	------	----	-------

## KALOS

Kalos 1.2		1.2	53	02.05 -	B12S1	4	1,1	BPR5EY-11	3028		LPG 2
Kalos 1.4		1.4	61	02.05 -	F14S3 SOHC	4	0,8	BPR6ES	7822	2	LPG 2
Kalos 1.4 16V SX		1.4	69	02.05 -	F14D3 DOHC	4	1,1	BKR6E-11	2756	14	LPG 1

## LACETTI

Lacetti 1.4		1.4	70	02.05 -	F14D3	4	1,1	BKR6E-11	2756	14	LPG 1
Lacetti 1.6		1.6	80	02.05 -	F16D3	4	1,1	BKR6E-11	2756	14	LPG 1
Lacetti 1.8		1.8	89	02.05 -	T18SED	4		BKR5EK	7956	23	LPG 1



Code *l* kW

Cyl.



Stock-No.



LPG/CNG

**CHEVROLET****LACETTI**

Lacetti 1.8		1.8	89	08.05 -	F18D3	4		BKUR6ETB	6992		
Lacetti 2.0 D		2.0	89	01.07 -	Z20DM	4	☑	Y8009AS	96478		

**LUMINA**

Lumina		3.8		98 -	V6 MFI K	6	1,5	PTR4B-15	5146		LPG 5
--------	--	-----	--	------	----------	---	-----	----------	------	--	-------

**MALIBU**

Malibu		2.4		97 - 99	T MFI DOHC	4	1,5	TR55	3951		LPG 5
Malibu		3.1		97 - 99	M V6 MFI	6	1,5	TR55	3951		LPG 5
Malibu		3.1		00 -	J V6 SFI	6	1,5	TR55	3951		LPG 5
Malibu		3.8		83 -	9 2 bbl CID229	6	1,1	UR4	6630		UR5IX
Malibu		3.8		83 -	9 V6 2Verg./Cab.	6	1,1	UR4	6630		UR5IX

**MATIZ**

Matiz 0.8		0.8	38	02.05 -	F8CV	3	1,1	BCPR5EY-11	4120		LPG 3
Matiz 1.0		1.0	47	02.05 -	B10S	4	1,1	BCPR5EY-11	4120		LPG 3

**METRO**

Metro 1.0		1.0		98 -	L3 TBI 6	3	1,1	BPR6ES-11	4824	13	LPG 2
Metro 1.3		1.3		98 -	L4 TBI 9	4	1,1	BKR6E-11	2756	14	LPG 1

**NUBIRA**

Nubira 1.6		1.6	80	02.05 -	A16DMS DOHC	4	1,1	BKR6E-11	2756	14	LPG 1
Nubira 1.8 CDX		1.8	89	02.05 -	T18SED	4		BKR5EK	7956	23	LPG 1
Nubira 1.8		1.8	89	08.05 -	F18D3	4		BKUR6ETB	6992		
Nubira 2.0 D		2.0	89	01.07 -	Z20DM	4	☑	Y8009AS	96478		

**PRIZUM**

Prizum		1.8		98 - 99	L4 MPI 8 DOHC	4		BKR5EKB-11	3967		
Prizum		1.8		00 -	L4 MPI 8 DOHC	4	1,1	IFR5T11	4996		

**REZZO / TACUMA**

Rezzo / Tacuma U100		1.6	77	02.05 -	A16DMS	4	1,1	BKR5E-11	6953	33	LPG 1
Rezzo / Tacuma		1.8	72	00 -	F18S2 SOHC	4	0,9	BPR5ES	7422	6	LPG 2
Rezzo / Tacuma U100		2.0	89	02.05 -	T20SED	4		BKR5EK	7956	23	LPG 1

**SPARK**

Spark 1.0 / 1.0 LPG	M300	1.0	50	03.10 -	B10D1	4	0,9	DCPR8E	4339		LPG 8
Spark 1.2 / 1.2 LPG	M300	1.2	60	03.10 -	B12D1	4	0,9	DCPR8E	4339		LPG 8

**TAHOE**

Tahoe		4.8		00 - 00	V F I V8	8	1,5	TR55	3951		LPG 5
Tahoe		4.8		01 -	V F I V8	8	1,5	TR55	3951		LPG 5
Tahoe		5.3	201	00 -	T F I V8	8	1,5	TR55	3951		LPG 5
Tahoe		5.3		02 - 03	Z FLEX V8	8	1,5	TR55	3951		LPG 5
Tahoe		5.3		04 -	Z F I V8	8	1,5	TR55	3951		LPG 5
Tahoe		5.3		05 -	Z FLEX V8 323	8	1,5	TR55	3951		LPG 5
Tahoe		5.7	147	04.96 - 00	R V8	8	1,5	TR55	3951		LPG 5
Tracker		1.6		98 -	L4 MFI 6	4	1,1	BKR6E-11	2756	14	LPG 1

**TRAIL BLAZER**

Trail Blazer 4.2 LTZ		4.2	201	02 - 03	S EFI	6	1,3	PTR5A-13	2467	25	LPG 4
Trail Blazer 5.3		5.3		03 -	V8 P EFI	8	1,5	TR55	3951		LPG 5

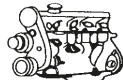
Code *l* kW

Cyl.



Stock-No.

V-

LPG/CNG

**CHEVROLET TRAX**

Trax 1.4 AWD		1.4	103	12.12 -	A14NET	4	0,7	IFR7X7G	91039		
Trax 1.6		1.6	85	12.12 -	A16XER	4	0,9	ZFR6V-G	8894		

**CHRYSLER 300**

300		2.7		05 -	V6 R FI Dir. Ign.	6	1,3	LZTR5A-13	4612		
-----	--	-----	--	------	-------------------	---	-----	-----------	------	--	--

**300 C**

300 C		2.7	142	01.05 -	V6	6	1,3	LZTR5A-13	4612		
300 C 3.0 CRD		3.0	160	09.05 - 12.10	M664	6		Y8002AS	6287	51	
300 C		3.5	183	07.04 -	V6 G FI	6	1,3	ZFR5LP-13G	7781		
300 C (Twin Spark)		5.7	250	07.04 - 08	V8 HEMI	8	1,1	LZTR4A-11	5444		
300 C SRT8 (Twin Spark)		6.1	316	06 -	W V	8	1,3	PLZTR5A-13	4998		

**300 M**

300 M		2.7	150	08.00 - 09.04	V6 EER	6	1,3	LZTR5A-13	4612		
300 M		3.5	189	09.99 -	V6 G FI	6	1,3	ZFR5LP-13G	7781		
300 M		3.5		03 -	V6 K FI Dir. Ign.	6	1,3	ZFR5LP-13G	7781		

**CIRRUS**

Cirrus		2.4		99 -	X DOHC	4	1,3	FR45	4636		
Cirrus		2.5		95 -	V6 MPI H DOHC	6	1,1	PFR5G-11	2647		

**CONCORDE**

Concorde		2.7		98 -	V6 MPI R DOHC	6	1,3	PTR5A-13	2467	25	LPG 4
Concorde		3.3		93 - 96	V6 MPI T	6	1,2	GR45	2822		GR5IX
Concorde		3.3		94 - 94	V6 FF U	6	1,2	GR45	2822		GR5IX
Concorde		3.5		93 - 97	V6 MPI F	6	0,9	FR5-1	7252		

**CROSSFIRE**

Crossfire		3.2	160	03 -	engine Mercedes SLK	6	1,0	IFR6D10	5344		LPG 1
-----------	--	-----	-----	------	---------------------	---	-----	---------	------	--	-------

**DODGE VIPER**

Dodge Viper		8.0		96 -	E MPI V10	10	0,9	FR5-1	7252		
-------------	--	-----	--	------	-----------	----	-----	-------	------	--	--

**NEON**

Neon		1.8		03.98 - 10.99		4	0,9	BKR6E	6962	28	LPG 1
Neon LE		2.0	98	01.95 -	ECB 16V	4	0,8	BCPR6ES	2330	12	LPG 3

**PT CRUISER**

PT Cruiser 2.0		2.0	104	06.00 -		4	1,1	LZTR4A-11	5444		
PT Cruiser 2.2 CRD		2.2	89	03.02 -	EDJ	4		Y-745U	6346	11	
PT Cruiser 2.2 CRD		2.2	110	08.05 -		4		Y-745U	6346	11	
PT Cruiser 2.4		2.4	105	08.05 -	EDZ	4	1,1	LZTR4A-11	5444		
PT Cruiser 2.4		2.4	110	06.00 -	EDZ	4	1,1	LZTR4A-11	5444		
PT Cruiser GT 2.4		2.4	164	08.03 -	EDV	4	1,1	LZTR4A-11	5444		

**SEBRING**

Sebring 2.0 CRD		2.0	103	07 -	engine by VW	4		Y-607AS	7560	50	
Sebring 2.0		2.0	104	06.01 -	EC4	4	1,1	LZTR4A-11	5444		
Sebring 2.0		2.0		95 - 99	L4 MPI Y DOHC	4	1,1	BKR6EIX-11	3764		LPG 1
Sebring 2.4		2.4		96 - 98	L4 MPI X DOHC	4	1,1	FR45	4636		
Sebring 2.4		2.4		01 -	4G64 SOHC	4	1,1	BKR5E-11	6953	33	LPG 1
Sebring 2.5		2.5		95 - 99	V6 MPI N DOHC	6	1,1	PFR5G-11	2647		

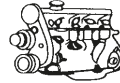
Code *l* kW

Cyl.

Stock-No.  
**V-TUNE**  
B-PROMOTER

LPG/CNG

**CHRYSLER****STRATUS**

Stratus 2.0		2.0	96	00 -		4	0,9	BKR6E	6962	28	LPG 1
Stratus 2.0		2.0	98	95 - 00	ECB 16V	4	0,8	BCPR6ES	2330	12	LPG 3
Stratus 2.5		2.5	120	04.95 -	EEB V6 MPI	6	1,1	PFR6B-11	4014		PFR7B

**VOYAGER 2**

Voyager 2		2.0	98	97 - 01.01	ECB C00	4	0,9	BKR6E	6962	28	LPG 1
Voyager 2		2.4	110	96 - 01.01	EDZ B00	4	1,1	ZFR5A-11	5084		LPG 6
Voyager 2		2.5	72	91 - 95	EDM	4	0,8	BPR6ES	7822	2	LPG 2
Voyager 2		2.5	88	04.92 - 04.95	VM 425 CLIRE	4	█	Y-924J	7906	1	
Voyager 2		2.5	88	04.92 - 04.95	VM HR-492	4	█	Y-924J	7906	1	
Voyager 2		2.5	88	05.95 - 01.01	VM HR425 CLIEE	4	█	Y-741U	6943	20	
Voyager 2		3.3	116	96 - 01.01	EGA V6 MPI R	6	0,9	GR4IX	7149		GR5IX
Voyager 2		3.3	120	91 - 95	EGA V6 MPI R	6	1,3	GR4	7038		GR5IX
Voyager 2		3.8	122	96 - 01.01	EGH V6 MPI	6	0,9	GR4	7038		GR5IX

**VOYAGER 3**

Voyager 3		2.4	108	03.01 -	EDZ	4	1,3	LZTR5A-13	4612		
Voyager 3		2.4	112	00 -		4	1,3	FR45	4636		

**VOYAGER 4**

Voyager 4 2.5 CRD	RG	2.5	88	08.05 - 05.07	EDK / ENJ	4	█	Y1031J	95970	71	
Voyager 4 2.5 CRD	RG	2.5	105	02.00 - 05.07	ENC	4	█	Y1031J	95970	71	
Voyager 4 2.8 CRD	RG	2.8	110	06.04 - 02.08	ENR	4	█	Y1031J	95970	71	
Voyager 4 3.3	RG	3.3	128	03.01 -	EGA	6	1,3	PLZTR5A-13	4998		

**CITROEN****AX**

AX 1.0i		1.0	30	10.86 -	TU9	4	0,7	BCP6ES	4930	17	LPG 3
AX 1.0i		1.0	37	07.92 -	TU9.M Cat.	4		BKR5EK	7956	23	LPG 1
AX 1.0i		1.0	37	03.95 -	TU9M CDZ	4		BKR5EK	7956	23	LPG 1
AX 1.0i		1.0		09.86 - 06.92	TU9 C1A	4	0,8	BCP5ES	7496	16	LPG 3
AX 1.0i		1.0		07.92 - 02.95	TU9M CDZ	4	0,8	BCPR5ES	6130	32	LPG 3
AX 1.1		1.1	44	07.92 - 06.95	TU1M HDZ Cat.	4	0,8	BCPR5ES	6130	32	LPG 3
AX 1.1i		1.1		09.86 - 06.92	TU1 H1A	4	0,8	BCP5ES	7496	16	LPG 3
AX 1.1i		1.1		07.92 - 06.95	TU1M HDZ	4	0,8	BCPR5ES	6130	32	LPG 3
AX 1.1i		1.1		07.95 -	TU1M HDZ	4		BKR5EK	7956	23	LPG 1
AX 1.3i Sport		1.3	69	02.87 - 12.92	TU24 M4A	4		BKUR7ET	7873		
AX D		1.4	39	09.88 - 09.94	TUD 3 L	4	█	Y-910J	3617	3	
AX 1.4i		1.4	55	07.92 -	TU3MC Cat.	4		BKR6EK	2288	20	LPG 1
AX 1.4i GT		1.4	55	07.92 -	TU3FM Cat.	4		BKR6EK	2288	20	LPG 1
AX 1.4i		1.4	55	07.94 -	TU3FM	4		BKR6EK	2288	20	LPG 1
AX 1.4		1.4		09.86 - 12.92	TU3 K1A, TU3A K1G	4	0,8	BCP5ES	7496	16	LPG 3
AX 1.4 GT		1.4		10.87 - 12.92	TU3S K2A	4	0,7	BCP6ES	4930	17	LPG 3
AX 1.4 Gti		1.4		09.91 - 12.92	TU3J2 K6B	4		BKR6EK	2288	20	LPG 1
AX 1.4i Gti		1.4		09.91 - 12.92	TU3FJ2Z	4		BKR6EK	2288	20	LPG 1
AX 1.4		1.4		07.92 -	TU3M Cat.	4	0,8	BCPR5ES	6130	32	LPG 3
AX 1.4 Gti		1.4		07.92 -	TU3J2 KFZ	4		BKR6EK	2288	20	LPG 1
AX 1.4i		1.4		07.92 - 06.95	TU3MC KDX	4	0,8	BCPR5ES	6130	32	LPG 3
AX 1.4i GT		1.4		07.92 - 06.95	TU3MC KDX	4	0,8	BCPR5ES	6130	32	LPG 3
AX 1.4i		1.4		07.95 -	TU3MC KDX	4		BKR6EK	2288	20	LPG 1
AX D		1.5	40	10.94 - 12.99	TUD 5 VJZ	4	█	Y-503J	1009	10	

Code *l* kW

Cyl.



Stock-No.



LPG/CNG

**CITROEN  
BERLINGO**

Berlingo 1.1i		1.1	44	07.96 -	TU1M HDZ	4		BKR6EK	2288	20	LPG 1
Berlingo 1.4i		1.4	55	07.96 - 12.99	TU3JP-KFX,KFW	4		BKR6EK	2288	20	LPG 1
Berlingo 1.4i		1.4	55	01.00 -	TU3JP KFX	4	0,9	BKR6EZ	4619	38	LPG 1
Berlingo Hdi		1.4	55	01.05 -	DV4TD	4	<input checked="" type="checkbox"/>	YE04	1684	40	
Berlingo 1.6 Hdi 75		1.6	55	04.08 -	DV6BUTED4	4	<input checked="" type="checkbox"/>	YE05	91322	73	
Berlingo 1.6 Hdi 75		1.6	55	04.08 -	DV6ETED / DV6ETEDM	4	<input checked="" type="checkbox"/>	Y8001AS	8904	58	
Berlingo 1.6 Hdi		1.6	66	07.06 -	DV6	4	<input checked="" type="checkbox"/>	YE04	1684	40	
Berlingo 1.6 Hdi 90		1.6	66	04.08 -	DV6ATED4	4	<input checked="" type="checkbox"/>	YE05	91322	73	
Berlingo 1.6 95 Vti		1.6	72	07.10 -	EP6CDTR	4	0,8	PLZKBR7A-G	5843		
Berlingo 1.6 Hdi 110		1.6	80	04.08 -	DV6TED4	4	<input checked="" type="checkbox"/>	YE05	91322	73	
Berlingo 1.6i 16V		1.6	80	02.01 -	TU5JP4 NFU	4	0,9	LFR6B	6677		LPG 7
Berlingo 1.6 Hdi 110		1.6	82	07.10 -	DV6C	4	<input checked="" type="checkbox"/>	Y8001AS	8904	58	
Berlingo 1.6 120 Vti		1.6	88	11.09 -	EP6C	4	0,8	PLZKBR7A-G	5843		
Berlingo 1.6 155 THP		1.6	115	04.08 -	EP6CDTR	4	0,8	PLZKBR7A-G	5843		
Berlingo		1.8	43	07.96 - 08.98	XUD7 A9A	4	<input checked="" type="checkbox"/>	Y-924J	7906	1	
Berlingo		1.8	43	09.98 - 03.99	XUD7 A9A	4	<input checked="" type="checkbox"/>	Y-924J	7906	1	
Berlingo		1.8	51	09.98 - 03.99	DW8 WJZ	4	<input checked="" type="checkbox"/>	Y-503J	1009	10	
Berlingo 1.8i		1.8	66	07.96 -	XU7JB LFX	4		BKR6EK	2288	20	LPG 1
Berlingo		1.8	66	09.98 - 03.99	DW8TD	4	<input checked="" type="checkbox"/>	Y-503J	1009	10	
Berlingo		1.9	51	07.96 - 09.98	XUD9A D9B / DJY	4	<input checked="" type="checkbox"/>	Y-924J	7906	1	
Berlingo		1.9	52	09.98 - 12.02	XUD9A	4	<input checked="" type="checkbox"/>	Y-924J	7906	1	
Berlingo HDI		2.0	66	10.99 -	DW10TD	4	<input checked="" type="checkbox"/>	Y-504J	1441	24	
Berlingo 2.0 Hdi		2.0	81	05.02 - 10.06	DW10ATED4	4	<input checked="" type="checkbox"/>	Y1005J	7957	56	
Berlingo 2.0 Hdi		2.0	88	11.06 -	DW10UTED4	4	<input checked="" type="checkbox"/>	Y1005J	7957	56	
Berlingo 2.0 Hdi		2.0	100	11.06 -	DW10BTED4	4	<input checked="" type="checkbox"/>	Y1005J	7957	56	
Berlingo Multispace 1.4i		1.4	55	01.97 - 12.99	TU3JP KFX, KFW	4		BKR6EK	2288	20	LPG 1
Berlingo Multispace 1.4i		1.4	55	01.00 -	TU3JP KFX, KFW	4	0,9	BKR6EZ	4619	38	LPG 1
Berlingo Multispace 1.6i		1.6	81	02.01 -	TU5JP4 NFU	4	0,9	LFR6B	6677		LPG 7
Berlingo Multispace 1.8i		1.8	66	07.97 -	XU7JB LFX	4		BKR6EK	2288	20	LPG 1
Berlingo Multispace		1.9	51	01.97 - 09.98	XUD9A D9B / DJY	4	<input checked="" type="checkbox"/>	Y-924J	7906	1	
Berlingo Multispace		1.9	51	09.98 - 12.02	DW8 WJZ	4	<input checked="" type="checkbox"/>	Y-503J	1009	10	
Berlingo Multispace Hdi		2.0	66	10.99 -	DW10TD	4	<input checked="" type="checkbox"/>	Y-504J	1441	24	

**BX**

BX 17 D		1.8	44	07.85 - 01.93	XUD 7	4	<input checked="" type="checkbox"/>	Y-924J	7906	1	
BX 17 TD, TRD		1.8	66	03.88 - 01.93	XUD 7 TE	4	<input checked="" type="checkbox"/>	Y-924J	7906	1	
BX 19 D, TD, TRD		1.9	51	03.87 -	XUD 9 A/L	4	<input checked="" type="checkbox"/>	Y-924J	7906	1	
BX 14		1.4	47	07.88 -	TU3.A	4	0,8	BCP5ES	7496	16	LPG 3
BX 15		1.5	59	07.87 - 06.92	XU5.1C	4	0,8	BCP5ES	7496	16	LPG 3
BX 16i Image, Millésime		1.6		07.92 -	XU5M BDY cat.	4	0,8	BCPR5ES	6130	32	LPG 3
BX 16		1.6	68	04.88 - 06.92	XU5.2C	4	0,7	BCP6ES	4930	17	LPG 3
BX 16 16V		1.6		07.87 - 06.92	XU9.J4	4		BCP6ET	4563		LPG 3
BX 16		1.6		07.92 -	XU5MZ BDZ Cat.	4	0,8	BCPR5ES	6130	32	LPG 3
BX 16 16V		1.6		07.92 -	XU9.J4 Cat.	4		BCPR6ET	2197		LPG 3
BX 19i Gti, Tri, Tzi / 4x4		1.9		07.86 - 06.92	XU9J2 D6A	4	0,7	BCP6ES	4930	17	LPG 3
BX 19i Gti 16S		1.9		07.87 - 06.92	XU9J4 D6C	4		BCP6ET	4563		LPG 3
BX 19i Gti 16S		1.9		07.92 -	XU9J4 DFW cat.	4		BCPR6ET	2197		LPG 3
BX 19		1.9	77	07.89 - 06.92	XU92C	4	0,7	BCP6ES	4930	17	LPG 3
BX 19		1.9	77	07.89 - 06.92	XU92C D2E	4	0,7	BCP6ES	4930	17	LPG 3
BX 19i Gti		1.9		07.88 - 06.92	XU9.J2	4	0,7	BCP6ES	4930	17	LPG 3
BX 19i		1.9		07.92 -	XU9.JA DKZ Cat.	4	0,8	BCPR5ES	6130	32	LPG 3

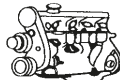

Code *l* kW

Cyl.



Stock-No.

V6/V6E

E-FORWARD

LPG/CNG

**CITROËN****C 1**

C1 I 1.0		1.0	50	06.05 -	1KR-FE	3	1,1	LFR6C-11	5788		
C1 I 1.4 Hdi		1.4	40	05.06 -	DV4	4	▣	YE04	1684	40	
C1 I 1.4 Hdi		1.4	50	06.05 -	DV4TD	4	▣	YE05	91322	73	

**C 15**

C15 D		1.8	44	10.84 - 05.95	XUD7	4	▣	Y-924J	7906	1	
C15 D		1.8	44	06.95 -	XUD7	4	▣	Y-924J	7906	1	
C15 D		1.9	44	12.00 -	DW8	4	▣	Y-503J	1009	10	
C15 E		1.0	33	09.88 -	TU9 C1A	4	0,8	BCP5ES	7496	16	LPG 3
C15 E		1.1	44	09.92 - 06.95	TU1.M HDZ Cat.	4	0,8	BCPR5ES	6130	32	LPG 3
C15 E		1.1		10.88 -	TU1 H1A	4	0,8	BCP5ES	7496	16	LPG 3
C15 E		1.4		10.87 -	TU3A K1G	4	0,8	BCP5ES	7496	16	LPG 3
C15E		1.1		07.95 -	TU1M HDZ	4		BKR5EK	7956	23	LPG 1

**C 2**

C2 1.1		1.1	45	08.03 -	TU1JP	4	0,9	BKR6EZ	4619	38	LPG 1
C2 1.4 Hdi		1.4	51	12.04 -	DV4TD	4	▣	YE05	91322	73	
C2 1.4		1.4	55	08.03 -	TU3JP	4	0,9	BKR6EZ	4619	38	LPG 1
C2 1.6 Phase 2		1.6	80	05.08 -	DV6TED4	4	▣	YE05	91322	73	
C2 1.6 16V		1.6	81	08.03 -	TU5JP4	4	0,9	LFR6B	6677		LPG 7
C2 1.6 16V		1.6	92	01.05 -	TU5JP4	4	0,9	LFR6B	6677		LPG 7

**C 3 1**

C3 1.1		1.1	44	04.02 -	TU1A-HFX	4	0,9	BKR6EZ	4619	38	LPG 1
C3 1.1		1.1	44	04.02 -	TU1JP-HFZ, HFY	4	0,9	BKR6EZ	4619	38	LPG 1
C3 1.4 Hdi		1.4	51	12.04 -	DV4TD	4	▣	YE05	91322	73	
C3 1.4 Hdi		1.4	52	03.02 - 12.04	DV4TD	4	▣	YE04	1684	40	
C3 1.4		1.4	55	04.02 -	TU3A-KFV	4	0,9	BKR6EZ	4619	38	LPG 1
C3 /Pluriel 1.4		1.4	55	04.02 -	TU3JP-KFX, KFV	4	0,9	BKR6EZ	4619	38	LPG 1
C3 / Pluriel 1.4		1.4	55	03 -	TU3JP	4	0,9	BKR6EZ	4619	38	LPG 1
C3 1.4		1.4	66	10.03 -	ET3J4~KFU	4	0,8	LZKAR7A	6799		
C3 1.4 Hdi 16V		1.4	68	03.02 - 12.04	DV4TED4	4	▣	YE04	1684	40	
C3 1.4 Hdi		1.4	68	12.04 - 08.05	DV4TED4	4	▣	YE05	91322	73	
C3 1.4 Hdi 16V X-TR		1.4	68	04 - 12.04	DV4ETD4	4	▣	YE04	1684	40	
C3 1.6 Hdi		1.6	66	10.05 -	DV6TED4	4	▣	YE05	91322	73	
C3 /Pluriel 1.6		1.6	81	04.02 -	TU5JP4-NFU	4	0,9	LFR6B	6677		LPG 7
C3 / Pluriel 1.6 16V		1.6	81	03 -	TU5JP4	4	0,9	LFR6B	6677		LPG 7
C3 1.6 Hdi		1.6	81	03.06 -	DV4TED6	4	▣	YE05	91322	73	

**C 3 2**

C3 II 1.0 PureTech VTi 68		1.0	50	03.12 -	EB0	3	1,0	LZKR6AI-10G	97999		
C3 II 1.1		1.1	44	11.09 -	TU1A	4	0,9	BKR6EZ	4619	38	LPG 1
C3 II 1.2 PureTech VTi 82		1.2	60	03.12 -	EB2	3	1,0	LZKR6AI-10G	97999		
C3 II 1.4 Hdi 70		1.4	50	11.09 -	DV4C / DV4TD	4	▣	YE05	91322	73	
C3 II 1.4		1.4	54	11.09 -	TU3A	4	0,9	BKR6EZ	4619	38	LPG 1
C3 II 1.4 95 VTi		1.4	72	11.09 -	EP3C	4	0,8	PLZKBR7A-G	5843		
C3 II 1.6 Hdi 90		1.6	66	11.09 -	DV6ATED4	4	▣	YE05	91322	73	
C3 II 1.6 Hdi		1.6	68	11.09 -	DV6DTEd	4	▣	YE05	91322	73	
C3 II 1.6 Hdi 110		1.6	82	11.09 -	DV6CTED4	4	▣	Y8001AS	8904	58	
C3 II 1.6 VTi 120		1.6	88	11.09 -	EP6C	4	0,8	PLZKBR7A-G	5843		

**C 3 PICASSO**

C3 Picasso 1.4 95 VTi		1.4	70	12.08 -	EP3	4	0,8	PLZKBR7A-G	5843		
-----------------------	--	-----	----	---------	-----	---	-----	------------	------	--	--

Code *l* kW

Cyl.



Stock-No.



LPG/CNG

**CITROEN  
C 3 PICASSO**

C3 Picasso 1.6 HdI 90		1.6	66	12.08 -	DV6ATED4	4		YE05	91322	73	
C3 Picasso 1.6 HdI 90		1.6	68	07.10 -	DV6DTEd	4		Y8001AS	8904	58	
C3 Picasso 1.6 HdI 110		1.6	80	12.08 -	DV6TED4	4		YE05	91322	73	
C3 Picasso 1.6 HdI 110		1.6	82	07.10 -	DV6C	4		Y8001AS	8904	58	
C3 Picasso 1.6 120 Vti		1.6	88	02.09 -	EP6	4	0,8	PLZKBR7A-G	5843		

**C 4**

C4 1.4 16V		1.4	65	11.04 -	ET3J4~KFU	4	0,8	LZKAR7A	6799		
C4 Coupé 1.6 HdI		1.6	68	12.04 -		4		YE04	1684	40	
C4 Coupé 1.6 HdI		1.6	80	12.04 - 06.06	DV6TED4	4		YE04	1684	40	
C4 1.6 16V		1.6	81	11.04 -	TU5JP4~NFU	4	0,9	LFR6B	6677		LPG 7
C4 1.6 Vti 120		1.6	88	06.08 -	EP6	4	0,8	PLZKBR7A-G	5843		PLZKBR7A-G
C4 1.6 16V		1.6	103	06.08 -	EP6DT	4	0,8	PLZKBR7A-G	5843		PLZKBR7A-G
C4 1.6 16V		1.6	110	06.08 -	EP6DT	4	0,8	PLZKBR7A-G	5843		PLZKBR7A-G
C4 2.0 16V		2.0	100	11.04 -	EW10J4~RFN	4	0,9	LFR6B	6677		LPG 7
C4 2.0 HdI		2.0	100	09.04 -	DW10BTED4	4		Y1005J	7957	56	
C4 2.0 16V		2.0	103	11.04 -	EW10A	4	0,9	LFR5B	7113		LPG 7
C4 2.0 HdI		2.0	103	07.08 -	DW10BTED4	4		Y1005J	7957	56	
C4 2.0 16V		2.0		11.04 -	EW10A	4	0,9	LFR5B	7113		LPG 7

**C 4 2**

C4 II 1.4 95 Vti		1.4	70	11.09 -	EP3C	4	0,8	PLZKBR7A-G	5843		
C4 II 1.6 HdI 90		1.6	68	11.09 -	DV6DTEd / DV6DTEdM	4		Y8001AS	8904	58	
C4 II 1.6 HdI 110		1.6	82	11.09 -	DV6C	4		Y8001AS	8904	58	
C4 II 1.6 120 Vti		1.6	88	11.09 -	EP6C	4	0,8	PLZKBR7A-G	5843		
C4 II 1.6 155 THP		1.6	115	11.09 -	EP6CDT	4	0,8	PLZKBR7A-G	5843		
C4 II 2.0 HdI		2.0	110	11.09 -	DW10CTED4	4		Y8001AS	8904	58	

**C 4 AIRCROSS**

C4 Aircross 1.6 HdI 115		1.6	84	04.12 -	DV6C	4		Y8001AS	8904	58	
C4 Aircross 1.6		1.6	86	04.12 -	4A92	4	1,1	DILFR5A11	93759		

**C 4 GRAND PICASSO**

C4 Grand Picasso 1.6 HdI 110		1.6	80	09.06 -	DV6TED4	4		YE05	91322	73	
C4 Grand Picasso 1.6 HdI 110		1.6	82	09.10 -	DV6C	4		Y8001AS	8904	58	
C4 Grand Picasso 1.6 120 Vti		1.6	88	06.08 -	EP6	4	0,8	PLZKBR7A-G	5843		
C4 Grand Picasso 1.6 16V		1.6	103	06.08 -	EP6DT	4	0,8	PLZKBR7A-G	5843		
C4 Grand Picasso 1.6 16V		1.6	110	06.08 -	EP6DT	4	0,8	PLZKBR7A-G	5843		
C4 Grand Picasso 1.6 155 THP		1.6	115	08.10 -	EP6CDT	4	0,8	PLZKBR7A-G	5843		
C4 Grand Picasso 1.8i 16V		1.8		09.06 -	EW7A	4	0,9	LFR5B	7113		LPG 7
C4 Grand Picasso 2.0 HdI		2.0	100	02.07 -	DW10BTED4	4		Y1005J	7957	56	
C4 Grand Picasso 2.0 HdI		2.0	102	09.06 -	DW10TD	4		Y-504J	1441	24	
C4 Grand Picasso 2.0		2.0	105	09.06 -	EW10A	4	0,9	LFR5B	7113		LPG 7
C4 Grand Picasso 2.0 HdI 150		2.0	110	06.09 -	DW10CTED4	4		Y8001AS	8904	58	
C4 Grand Picasso 2.0 HdI 165		2.0	120	11.10 -	DW10CTED4	4		Y8001AS	8904	58	
C4 Grand Picasso 2.0 16V		2.0		09.06 -	EW10A	4	0,9	LFR5B	7113		LPG 7

**C 4 PICASSO**

C4 Picasso 1.6 HdI		1.6	81	03.07 -	DV6TED	4		YE05	91322	73	
C4 Picasso 1.6 HdI		1.6	81	02.07 -	DV6TED4	4		YE05	91322	73	
C4 Picasso 1.6 HdI 110		1.6	82	09.10 -	DV6C	4		Y8001AS	8904	58	
C4 Picasso 1.6 120 Vti		1.6	88	06.08 -	EP6	4	0,8	PLZKBR7A-G	5843		
C4 Picasso 1.6 16V		1.6	103	06.08 -	EP6DT	4	0,8	PLZKBR7A-G	5843		

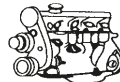
Code *l* kW

Cyl.



Stock-No.

V6  
E-POWER

LPG/CNG

**CITROËN****C 4 PICASSO**

C4 Picasso 1.6 16V		1.6	110	06.08 -	EP6DT	4	0,8	PLZKBR7A-G	5843		
C4 Picasso 1.6 155 THP		1.6	115	08.10 -	EP6CDT	4	0,8	PLZKBR7A-G	5843		
C4 Picasso 1.6 Hdi		1.6		12.08 -	DV6	4	☑	YE05	91322	73	
C4 Picasso 1.6 Hdi		1.6		12.08 -	DV6	4	☑	YE05	91322	73	
C4 Picasso 1.8i 16V		1.8		02.07 -	EW7A	4	0,9	LFR5B	7113		LPG 7
C4 Picasso 2.0 Hdi		2.0	100	10.06 -	DW10BTED4	4	☑	Y1005J	7957	56	
C4 Picasso 2.0 Hdi		2.0	102	02.07 -	DW10TD	4	☑	Y-504J	1441	24	
C4 Picasso 2.0		2.0	105	02.07 -	EW10A	4	0,9	LFR5B	7113		LPG 7
C4 Picasso 2.0 Hdi 150		2.0	110	06.09 -	DW10CTED4	4	☑	Y8001AS	8904	58	
C4 Picasso 2.0 Hdi 165		2.0	120	11.10 -	DW10CTED4	4	☑	Y8001AS	8904	58	
C4 Picasso 2.0 16V		2.0		02.07 -	EW10A	4	0,9	LFR5B	7113		LPG 7

**C 4 PICASSO 2**

C4 Picasso II 1.6 HDi 90		1.6	68	02.13 -	DV6DTEd	4	☑	Y8001AS	8904	58	
C4 Picasso II 1.6 e-HDi 115		1.6	85	02.13 -	DV6C	4	☑	Y8001AS	8904	58	
C4 Picasso II 1.6 VTi 120		1.6	88	02.13 -	EP6C	4	0,8	PLZKBR7A-G	5843		
C4 Picasso II 1.6 THP 155		1.6	115	02.13 -	EP6CDT	4	0,8	PLZKBR7A-G	5843		
C4 Picasso II 2.0 BlueHdi 150		2.0	110	13 -	DW10FD	4	☑	Y8001AS	8904	58	

**C 5**

C5 1.6 Hdi		1.6	81	03.06 -	DV6	4	☑	YE05	91322	73	
C5 1.8		1.8	86	06.02 -	EW7J4 6FZ	4	0,9	LFR5B	7113		LPG 7
C5 2.0 Hdi		2.0	66	06.02 -	DW10ATD	4	☑	Y-504J	1441	24	
C5 2.0 Hdi		2.0	81	02.01 -	DW10ATED	4	☑	Y-504J	1441	24	
C5 2.0		2.0	100	10.00 -	EW10J4-RFN	4	0,9	LFR5B	7113		LPG 7
C5 2.0 Hdi		2.0	100	09.04 -	DW10BTED4	4	☑	Y1005J	7957	56	
C5 2.0		2.0	105	09.04 -	EW10A	4	0,9	LFR5B	7113		LPG 7
C5 2.0 16V		2.0		09.04 -	EW10A	4	0,9	LFR5B	7113		LPG 7
C5 2.2 Hdi		2.2	98	09.04 - 08.05	DW12TED4	4	☑	Y1005J	7957	56	
C5 2.2 Hdi		2.2	100	10.00 - 08.04	DW12TED4	4	☑	Y1005J	7957	56	
C5 2.2 Hdi		2.2	100	02.01 -	DW12TED4	4	☑	Y-504J	1441	24	
C5 2.2 Hdi		2.2	125	05.06 -	DW12BTED4	4	☑	YE08	4966		
C5 3.0 V6		3.0	154	10.00 -	ES9J4S XFX	6	1,1	PLFR5A-11	6240		LPG 7

**C 5 3**

C5 III 1.6 HDi		1.6	80	02.08 -	DV6TED4	4	☑	YE05	91322	73	
C5 III 1.6 Hdi 110		1.6	82	07.10 -	DV6C	4	☑	Y8001AS	8904	58	
C5 III 1.6 Hdi 115		1.6	84	01.12 -	DV6C	4	☑	Y8001AS	8904	58	
C5 III 1.6 120 Vti		1.6	88	07.10 -	EP6C	4	0,8	PLZKBR7A-G	5843		
C5 III 1.6 155 THP		1.6	115	06.09 -	EP6CDT	4	0,8	PLZKBR7A-G	5843		
C5 III 1.8		1.8	92	02.08 -	EW7A	4	0,9	LFR5B	7113		LPG 7
C5 III 2.0 HDi		2.0	100	02.08 -	DW10BTED4	4	☑	Y1005J	7957	56	
C5 III 2.0		2.0	103	02.08 -	EW10A	4	0,9	LFR5B	7113		LPG 7
C5 III 2.0 HDi 140		2.0	103	04.09 -	DW10BTED4	4	☑	Y1005J	7957	56	
C5 III 2.0 HDi 165		2.0	120	04.09 -	DW10CTED4	4	☑	Y8001AS	8904	58	
C5 III 2.2 HDi		2.2	125	02.08 -	DW12BTED4	4	☑	YE08	4966		
C5 III 2.7 V6 HDi		2.7	150	02.08 -	DT17TED4	6	☑	YE12	7794		
C5 III 3.0 V6		3.0	155	02.08 -	ES9A	6	1,1	PLFR5A-11	6240		LPG 7

**C 6**

C6 2.2 Hdi		2.2	125	11.06 -	DW12BTED4	4	☑	YE08	4966		
C6 2.7 V6 Hdi		2.7	150	12.05 -	DT17	6	☑	YE12	7794		
C6 3.0 V6		3.0	155	08.05 -	ES9A / ES9J4S	6	1,1	PLFR5A-11	6240		LPG 7

**C 8**

C8 2.0 Hdi 16V		2.0	80	07.02 -	DW10TED4/RHT	4	☑	Y-504J	1441	24	
----------------	--	-----	----	---------	--------------	---	---	--------	------	----	--

Code *l* kW

Cyl.



Stock-No.



LPG/CNG

**CITROEN****C 8**

C8 2.0		2.0	102	06.02 -	EW10J4-RFN	4	0,9	LFR5B	7113		LPG 7
C8 2.0		2.0	104	09.05 -	EW10A	4	0,9	LFR5B	7113		LPG 7
C8 2.0 16V		2.0		09.05 -	EW10A	4	0,9	LFR5B	7113		LPG 7
C8 2.0 HdI		2.0	100	03.06 -	DW10BTED4	4	█	Y1005J	7957	56	
C8 2.0 HdI		2.0	79	04.02 - 08.07	DW10ATED4	4	█	Y1005J	7957	56	
C8 2.0 HdI		2.0	80	10.02 - 02.07	DW10UTED4	4	█	Y1005J	7957	56	
C8 2.0 HdI		2.0	81	04.02 -	DW10ATED4	4	█	Y1005J	7957	56	
C8 2.0 HdI		2.0	88	03.07 -	DW10UTED4	4	█	Y1005J	7957	56	
C8 2.0 HdI 160		2.0	120	04.10 -	DW10CTED4	4	█	Y8001AS	8904	58	
C8 2.2 HdI		2.2	94	04.02 - 07.06	DW12TED4	4	█	Y1005J	7957	56	
C8 2.2 HdI		2.2	96	02 -	DW12	4	█	Y-504J	1441	24	
C8 2.2		2.2	118	06.02 -	EW12J4-3FZ	4	0,9	LFR5B	7113		LPG 7
C8 2.2 HdI		2.2	125	06.06 -	DW12BTED4	4	█	YE08	4966		
C8 3.0 V6		3.0	150	10.02 -	ES9J4S	6	1,1	PLFR5A-11	6240		LPG 7

**C-CROSSER**

C-Crosser 2.2 HdI		2.2	115	06.07 -	DW12MTED4	4	█	YE08	4966		
C-Crosser 2.4		2.4	125	09.07 -	VUSFZC/VUSFZF/ VVSFZC/VVSFZF	4	0,8	FR5EI	1313		FR6EI

**C-ELYSEE**

C-Elysée 1.2 VTi 72		1.2	52	12 -	EB2M	3	1,0	LZKR6AI-10G	97999		
C-Elysée 1.6 HDi 92		1.6	68	12 -	DV6DTE4 / DV6DTE4M	4	█	Y8001AS	8904	58	

**DS 3**

DS3 1.2 PureTech VTi 82		1.2	60	11 -	EB2	3	1,0	LZKR6AI-10G	97999		
DS3 1.4 95 Vti		1.4	70	04.10 -	EP3C	4	0,8	PLZKBR7A-G	5843		
DS3 1.6 HdI 90		1.6	68	11.09 -	DV6C	4	█	Y8001AS	8904	58	
DS3 1.6 HdI 110		1.6	82	11.09 -	DV6CTED4	4	█	Y8001AS	8904	58	
DS3 1.6 120 Vti		1.6	88	04.10 -	EP6C	4	0,8	PLZKBR7A-G	5843		
DS3 1.6 155 THP		1.6	115	04.10 -	EP6DT / EP6CDT	4	0,8	PLZKBR7A-G	5843		

**DS 4**

DS4 1.6 e-Hdi 110		1.6	81	04.11 -	DV6C	4	█	Y8001AS	8904	58	
DS4 1.6 HdI 110		1.6	82	04.11 -	DV6C	4	█	Y8001AS	8904	58	
DS4 1.6 120 Vti		1.6	88	04.11 -	EP6C	4	0,8	PLZKBR7A-G	5843		
DS4 1.6 155 THP		1.6	115	04.11 -	EP6DT / EP6CDT	4	0,8	PLZKBR7A-G	5843		
DS4 1.6 200 THP		1.6	147	04.11 -	EP6CDTX	4	0,8	ILZKBR7A-8G	5992		
DS4 2.0 HdI 160		2.0	120	04.11 -	DW10CTED4	4	█	Y8001AS	8904	58	

**DS 5**

DS5 1.6 e-Hdi 110		1.6	82	11.11 -	DV6C	4	█	Y8001AS	8904	58	
DS5 1.6 155 THP		1.6	115	11.11 -	EP6CDT	4	0,8	PLZKBR7A-G	5843		
DS5 1.6 200 THP		1.6	147	11.11 -	EP6CDTX	4	0,8	ILZKBR7A-8G	5992		
DS5 2.0 HdI 165		2.0	120	11.11 -	DW10CTED4	4	█	Y8001AS	8904	58	
DS5 2.0 HdI 165 Hybrid4		2.0	120	11.11 -	DW10CTED4	4	█	Y8001AS	8904	58	

**EVASION**

Evasion 1.8		1.8	72	09.96 - 06.00	XU7JP LFW	4		BKR5EK	7956	23	LPG 1
Evasion 1.9 TD		1.9	66	03.94 - 08.98	XUD9TF	4	█	Y-923U	3380	1	
Evasion 1.9 TD		1.9	68	09.98 - 09.02	XUD9TF, XUD9BTF	4	█	Y-938R	5267	1	
Evasion 2.0 HdI		2.0	81	09.98 - 09.02	DW10ATED	4	█	Y-504J	1441	24	
Evasion 2.0		2.0	89	07.94 - 03.95	XU10J2 RFU	4	0,8	BCPR5ES	6130	32	LPG 3



Code *l* kW

Cyl.

Stock-No.  
**VEFINE**  
E-POWER\*

LPG/CNG

**CITROEN****EVASION**

Evasion 2.0		2.0	90	04.95 - 05.00	XU10J2 RFU	4		BKR5EK	7956	23	LPG 1
Evasion 2.0		2.0	101	06.00 -	EW10J4-RFR	4	0,9	LFR5B	7113		LPG 7
Evasion 2.0 Turbo		2.0	110	09.94 - 05.00	XU10J2TE RGX	4		BKR6EK	2288	20	LPG 1
Evasion 2.1 TD		2.1	80	05.96 - 04.97	XUD11BTE	4	☑	Y-924J	7906	1	
Evasion 2.1 TD		2.1	80	05.97 - 12.98	XUD11BTE	4	☑	Y-924J	7906	1	

**JUMPER**

Jumper 1.9 D		1.9	52	03.94 - 05.95	XUD9AU	4	☑	Y-923U	3380	1	
Jumper 1.9 D		1.9	52	06.95 -	XUD9AU	4	☑	Y-938R	5267	1	
Jumper 1.9 TD		1.9	68	03.94 - 08.98	XUD9TF	4	☑	Y-923U	3380	1	
Jumper 1.9 TD		1.9	68	09.98 -	XUD9TF	4	☑	Y-938R	5267	1	
Jumper 2.0 Hdi		2.0	66	09.98 -	DW10TD	4	☑	Y-504J	1441	24	
Jumper 2.0		2.0	81	04.95 -	XU10.J2U RFW	4		BKR6EK	2288	20	LPG 1
Jumper 2.2 Hdi		2.2	74	04.02 -	DW12TED	4	☑	Y-504J	1441	24	
Jumper 2.2 Hdi		2.2	76	09.98 -	DW10TED4	4	☑	Y-504J	1441	24	
Jumper 2.2 Hdi		2.2	100	09.98 -	DW12TED4	4	☑	Y-504J	1441	24	
Jumper 2.2 Hdi		2.2	74	02.02 - 06.06	DW12UTED	4	☑	Y1005J	7957	56	
Jumper 2.2 Hdi 100		2.2	74	04.06 -	4HV	4	☑	Y-548J	94832	75	
Jumper 2.2 Hdi 120		2.2	88	04.06 -	4HU	4	☑	Y-548J	94832	75	
Jumper 2.5 D		2.5	63	03.94 -	DJ5	4	☑	Y-923U	3380	1	
Jumper 2.5 TD		2.5	76	03.94 - 08.96	DJ5T	4	☑	Y-923U	3380	1	
Jumper 2.5 Tdi		2.5	78	09.96 -	DJ5TED	4	☑	Y-738U	5390		
Jumper 2.8 Hdi		2.8	93	09.00 - 04.02	4HY	4	☑	Y-502R	3852		
Jumper 3.0 Hdi 145		3.0	107	07.10 -	F30DT	4	☑	Y8005J	96853	64	
Jumper 3.0 Hdi 160		3.0	116	06.09 -	F30DT	4	☑	Y8005J	96853	64	

**JUMPY**

Jumpy 1.6		1.6	59	10.95 -	1580 SPI 220.A2.000	4	0,8	BCPR7ES	3330		BCPR7EIX
Jumpy 1.6 Hdi		1.6	66	02.07 -	DV6UTED4	4	☑	YE05	91322	73	
Jumpy 1.8 D		1.8	51	09.98 -	DW8	4	☑	Y-503R	4279	10	
Jumpy 1.9 D		1.9	51	01.96 - 08.98	XUD9A	4	☑	Y-923U	3380	1	
Jumpy 1.9 D		1.9	51	09.98 -	DW8	4	☑	Y-503R	4279	10	
Jumpy 1.9 D		1.9	51	09.98 -	XUD9A	4	☑	Y-938R	5267	1	
Jumpy 1.9 TD		1.9	68	01.96 - 08.98	XUD9TF/BTF	4	☑	Y-923U	3380	1	
Jumpy 1.9 TD		1.9	68	09.96 -	XUD9TF/BTF	4	☑	Y-938R	5267	1	
Jumpy 2.0 Hdi		2.0	70	02.00 -	DW10TED	4	☑	Y-504J	1441	24	
Jumpy 2.0 Hdi		2.0	70	02.00 -	DW10TED	4	☑	Y-504J	1441	24	
Jumpy 2.0 Hdi 95		2.0	72	07.11 -	DW10CE	4	☑	Y8001AS	8904	58	
Jumpy 2.0 Hdi		2.0	81	02.00 -	DW10ATED	4	☑	Y-504J	1441	24	
Jumpy 2.0 Hdi		2.0	81	02.00 -	DW10ATED	4	☑	Y-504J	1441	24	
Jumpy 2.0 Hdi		2.0	81	05.02 - 10.06	DW10ATED4	4	☑	Y1005J	7957	56	
Jumpy 2.0 Hdi		2.0	88	11.06 -	DW10UTED4	4	☑	Y1005J	7957	56	
Jumpy 2.0 Hdi		2.0	90	02.07 -		4	☑	YE05	91322	73	
Jumpy 2.0 Hdi 125		2.0	94	07.11 -	DW10CD	4	☑	Y8001AS	8904	58	
Jumpy 2.0		2.0	102	06.01 -	EW10J4-RFN	4	0,9	LFR5B	7113		LPG 7
Jumpy 2.0 Hdi		2.0	102	02.07 -		4	☑	YE05	91322	73	
Jumpy 2.0 16V		2.0	105	12.06 -	EW10A	4	0,9	LFR5B	7113		LPG 7
Jumpy 2.0 Hdi		2.0	100	11.06 -	DW10BTED4	4	☑	Y1005J	7957	56	
Jumpy 2.0 Hdi 165		2.0	120	07.10 -	DW10CTED4	4	☑	Y8001AS	8904	58	

**NEMO**

Nemo 1.3 Hdi 75		1.3	55	10.10 -	F13DTE5 (FHZ)	4	☑	Y9001AS	97719	72	
-----------------	--	-----	----	---------	---------------	---	---	---------	-------	----	--

Code *l* kW

Cyl.



Stock-No.



LPG/CNG

**CITROEN NEMO**

Nemo 1.4		1.4	54	02.08 -	KFV (TU3A)	4	0,9	BKR6EZ	4619	38	LPG 1
Nemo 1.4 Hdi		1.4	51	02.08 -	DV4TD	4		YE05	91322	73	

**SAXO 1**

Saxo 1 1.0		1.0	37	02.96 - 09.99	TU9M CDZ	4		BKR5EK	7956	23	LPG 1
Saxo 1 1.1		1.1	44	02.96 - 08.99	TU1M+ HDZ	4		BKR6EK	2288	20	LPG 1
Saxo 1 1.4		1.4	55	02.96 - 08.99	TU3JP KFW	4		BKR6EK	2288	20	LPG 1
Saxo 1 1.4		1.4	55	02.96 - 08.99	TU3JP+ KFX	4		BKR6EK	2288	20	LPG 1
Saxo 1 1.5 D		1.5	43	05.96 - 08.99	TUD 5	4		Y-503J	1009	10	
Saxo 1 1.6		1.6	66	07.98 - 08.99	TU5JP+ NFZ	4		BKR6EK	2288	20	LPG 1

**SAXO 2**

Saxo 2 1.0		1.0	37	09.99 - 12.00	TU9M CDZ	4		BKR5EK	7956	23	LPG 1
Saxo 2 1.1		1.1	44	09.99 -	TU1M+ HDZ	4		BKR6EK	2288	20	LPG 1
Saxo 2 1.1		1.1	44	06.00 -	TU1JP HFX	4	0,9	BKR6EZ	4619	38	LPG 1
Saxo 2 1.1		1.1	44	06.00 -	TU1JP HFX	4	0,9	BKR6EZ	4619	38	LPG 1
Saxo 2 1.4		1.4	55	09.99 -	TU3JP KFW	4	0,9	BKR6EZ	4619	38	LPG 1
Saxo 2 1.4		1.4	55	09.99 -	TU3JP+ KFX	4	0,9	BKR6EZ	4619	38	LPG 1
Saxo 2 1.5 D		1.5	43	09.99 - 05.03	TUD 5	4		Y-503J	1009	10	
Saxo 2 1.6		1.6	66	09.99 - 12.00	TU5JP+ NFZ	4	0,9	BKR6EZ	4619	38	LPG 1
Saxo 2 1.6		1.6	66	01.01 -	TU5JP NFT	4	0,9	BKR6EZ	4619	38	LPG 1
Saxo 2 1.6		1.6	88	03.01 - 04.02	TU5JP NFX	4		BKR6EK	2288	20	LPG 1

**XANTIA**

Xantia 1.6		1.6	66	06.93 - 05.95	XU5JP BFZ	4	0,8	BCPR5ES	6130	32	LPG 3
Xantia 1.6		1.6	66	06.95 -	XU5JP BFZ	4		BKR5EK	7956	23	LPG 1
Xantia 1.8		1.8	66	01.98 -	XU7JB LFX	4		BKR6EK	2288	20	LPG 1
Xantia 1.8		1.8	76	07.93 - 03.95	XU7JP LFZ	4	0,8	BCPR5ES	6130	32	LPG 3
Xantia 1.8		1.8	76	04.95 -	XU7JP LFZ	4		BKR5EK	7956	23	LPG 1
Xantia 1.8 16V		1.8	82	07.95 -	XU7JP4 LFY	4		BKR5EK	7956	23	LPG 1
Xantia 1.9 D		1.9	51	03.93 - 01.96	XUD 9 A/L	4		Y-924J	7906	1	
Xantia 1.9 D		1.9	55	05.94 -	XUD9A	4		Y-938R	5267	1	
Xantia 1.9 D		1.9	55	09.98 -	XUD9A/L	4		Y-938R	5267	1	
Xantia 1.9 TD		1.9	68	06.93 - 08.98	XUD9TF	4		Y-923U	3380	1	
Xantia 1.9 TD		1.9	68	09.98 - 12.00	XUD9BTF, XUD9BSD	4		Y-938R	5267	1	
Xantia 2.0 Hdi		2.0	66	10.98 -	DW10TD	4		Y-504J	1441	24	
Xantia 2.0 Hdi		2.0	81	10.98 - 12.01	DW10ATED	4		Y-504J	1441	24	
Xantia 2.0		2.0	90	03.93 - 05.95	XU10J2 RFX	4	0,8	BCPR5ES	6130	32	LPG 3
Xantia 2.0		2.0	90	06.95 -	XU10J2 RFX	4		BKR5EK	7956	23	LPG 1
Xantia 2.0 16V		2.0	99	06.95 -	XU10J4R RFV	4		BKR5EK	7956	23	LPG 1
Xantia 2.0 CT Turbo		2.0	110	07.96 -	XU10J2TE RGX	4		BKR6EK	2288	20	LPG 1
Xantia 2.016V		2.0	112	93 -	XU10J4D	4	0,8	BKR6ES	3783	28	LPG 1
Xantia 2.1 TD		2.1	80	06.95 - 08.98	XUD11BTE	4		Y-923U	3380	1	
Xantia 2.1 TD		2.1	80	09.98 -	XUD11BTF	4		Y-938R	5267	1	
Xantia 3.0 V6		3.0	142	03.97 -	ES9J4 XFZ	6		BKR6EK	2288	20	LPG 1

**XM**

XM 2.0		2.0	99	07.94 - 12.00	XU10J4R RFV	4		BKR5EK	7956	23	LPG 1
XM 2.0 CT Turbo		2.0	110	11.92 - 12.00	XU10J2TE RGX	4		BKR6EK	2288	20	LPG 1
XM 2.0 CT Turbo		2.0	110	96 -	XU10J2CTE	4		BKR6EK	2288	20	LPG 1
XM 2.0		2.0		05.89 - 12.92	XU102C-R2A	4	0,7	BCP6ES	4930	17	LPG 3
XM 2.0		2.0		05.89 - 12.92	XU10J2 R6A	4	0,8	BCPR6ES	2330	12	LPG 3

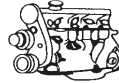
Code *l* kW

Cyl.

Stock-No.  
**V-TUNE**  
**16-POWER**

LPG/CNG

**CITROËN****XM**

XM 2.0		2.0		05.92 - 12.00	XU10J2 RFZ Cat.	4	0,8	BCPR5ES	6130	32	LPG 3
XM 2.0 16V		2.0		07.94 -		4	0,8	BCPR6ES	2330	12	LPG 3
XM 2.1 D 12D		2.1	60	05.89 - 06.94	XUD11A/L	4	█	Y-924J	7906	1	
XM 2.1 D 12TD		2.1	80	05.89 - 08.98	XUD11ATE/L/BTE	4	█	Y-923U	3380	1	
XM 2.1 D 12TD		2.1	80	09.98 - 12.00	XUD11ATE/L/BTE	4	█	Y-938R	5267	1	
XM 2.5 TD		2.5	96	07.94 - 12.00	DK5ATE	4	█	Y-923U	3380	1	
XM 3.0 V6 24V		3.0	140	01.97 - 12.00	ES9J4-XFZ	6		BKR6EK	2288	20	LPG 1
XM 3.0 V6		3.0		05.89 - 06.94	ZPJ-SFZ	6		BCPR6ET	2197		LPG 3
XM 3.0 V6		3.0		07.94 - 06.97	ZPJ-UFZ	6		BCPR6ET	2197		LPG 3
XM 3.0 V6 24V		3.0		07.94 - 07.97	ZPJ4-UKZ	6		BCPR7ET	2164		BCPR7EIX

**XSARA**

Xsara 1.4		1.4	55	09.97 - 08.00	TU3JP KFX	4		BKR6EK	2288	20	LPG 1
Xsara 1.5 D		1.5	43	09.97 - 08.00	TUD5	4	█	Y-503J	1009	10	
Xsara 1.6		1.6	66	09.97 - 08.00	TU5JP NFZ	4		BKR6EK	2288	20	LPG 1
Xsara 1.8 D		1.8	43	10.97 - 09.00	XUD7	4	█	Y-938R	5267	1	
Xsara 1.8		1.8	66	09.97 - 08.00	XU7JB LFX	4		BKR6EK	2288	20	LPG 1
Xsara 1.8 16V		1.8	75	09.97 - 08.00	XU7JP LFZ	4		BKR5EK	7956	23	LPG 1
Xsara 1.8 16V		1.8	82	09.97 - 08.00	XU7JP4 LFY	4		BKR5EK	7956	23	LPG 1
Xsara 1.9 D		1.9	50	09.97 - 09.00	XUD9A DJY	4	█	Y-938R	5267	1	
Xsara 1.9 D		1.9	51	06.99 - 08.00	DW8	4	█	Y-503R	4279	10	
Xsara 1.9 TD		1.9	66	10.97 - 09.00	XUD9TE DHY	4	█	Y-938R	5267	1	
Xsara 2.0 Hdi		2.0	66	04.99 - 08.00	DW10TD	4	█	Y-504J	1441	24	
Xsara 2.0 16V		2.0	120	09.97 - 08.00	XU10J4RS RFS	4		BKR6EK	2288	20	LPG 1
Xsara 2 1.4 Hdi		1.4	51	02.03 - 12.04	DV4TD	4	█	YE04	1684	40	
Xsara 2 1.4 Hdi		1.4	51	12.04 -	DV4TD	4	█	YE05	91322	73	
Xsara 2 1.4		1.4	55	09.00 -	TU3JP KFW	4	0,9	BKR6EZ	4619	38	LPG 1
Xsara 2 1.5 Hdi		1.5	43	09.00 -	TUD5	4	█	Y-503J	1009	10	
Xsara 2 1.6 16V		1.6	81	09.00 -	TU5JP4-NFU	4	0,9	LFR6B	6677		LPG 7
Xsara 2 1.8 16V		1.8	86	09.00 -	EW7J4 6FZ	4	0,9	LFR5B	7113		LPG 7
Xsara 2 1.9 D		1.9	52	09.00 -	DW8 WJZ	4	█	Y-503R	4279	10	
Xsara 2 2.0 Hdi		2.0	66	09.00 - 12.02	DW10TD RHY	4	█	Y-504J	1441	24	
Xsara 2 2.0 Hdi		2.0	81	05.01 -	DW10ATED RHZ	4	█	Y-504J	1441	24	
Xsara 2 2.0 16V		2.0	101	09.00 -	EW10J4-RFN	4	0,9	LFR5B	7113		LPG 7
Xsara 2 2.0i 16V VTS		2.0	123	09.00 -	XU10J4RS RFS	4	0,9	BKR5EZ	7642	36	LPG 1
Xsara Picasso 1.6		1.6	66	12.99 -	TU5JP NFZ, NFV	4	0,9	BKR6EZ	4619	38	LPG 1
Xsara Picasso 1.6 Hdi		1.6	66	09.05 -	DV6	4	█	YE05	91322	73	
Xsara Picasso 1.6 Hdi		1.6	81	05.04 - 06.06	DV6	4	█	YE04	1684	40	
Xsara Picasso 1.8i 16V		1.8	86	12.99 -	EW7J4-6FZ	4	0,9	LFR5B	7113		LPG 7
Xsara Picasso 2.0 Hdi		2.0	66	01.00 - 07	DW10TD	4	█	Y-504J	1441	24	
Xsara Picasso 2.0 Hdi		2.0	81	01.00 - 07	DW10TD	4	█	Y-504J	1441	24	
Xsara Picasso 2.0		2.0	101	09.00 -	EW10J4-RFM	4	0,9	LFR5B	7113		LPG 7

**ZX**

ZX 1.1		1.1	40	03.91 - 06.92	TU1	4	0,8	BCP5ES	7496	16	LPG 3
ZX 1.1		1.1	44	07.92 - 03.96	TU1M HDZ	4	0,8	BCPR5ES	6130	32	LPG 3
ZX 1.1		1.1	44	04.96 -	TU1M	4		BKR5EK	7956	23	LPG 1
ZX 1.1i		1.1	44	04.96 -	TU1M HDZ	4		BKR5EK	7956	23	LPG 1
ZX 1.4		1.4	55	03.91 - 12.92	TU32 K2C	4	0,8	BCP5ES	7496	16	LPG 3
ZX 1.4		1.4	55	03.91 - 06.97	TU3MC KDX	4	0,8	BCPR6ES	2330	12	LPG 3
ZX 1.4		1.4	55	07.92 - 06.97	TU3MC KDY Cat.	4		BKR6EK	2288	20	LPG 1

Code *l* kW

Cyl.



Stock-No.



LPG/CNG

**CITROEN****ZX**

ZX 1.4		1.4	55	07.97 -	TU3JP KFX	4		BKR6EK	2288	20	LPG 1
ZX 1.4		1.4	55	07.97 -	TU3JP-KFX	4		BKR6EK	2288	20	LPG 1
ZX 1.6		1.6	65	03.91 - 06.93	XU5M BDY Cat.	4	0,8	BCPR5ES	6130	32	LPG 3
ZX 1.6		1.6	66	07.93 - 06.95	XU5JP Cat.	4	0,8	BCPR5ES	6130	32	LPG 3
ZX 1.6i		1.6	66	07.93 - 06.95	XU5JP BFZ	4	0,8	BCPR5ES	6130	32	LPG 3
ZX 1.6		1.6	66	07.95 - 07.98	TU5JP	4		BKR5EK	7956	23	LPG 1
ZX 1.6i		1.6	66	07.95 - 07.98	XU5JP BFZ	4		BKR5EK	7956	23	LPG 1
ZX 1.8 Reflex D		1.8	44	03.91 -	XUD 7 A9A	4	☑	Y-924J	7906	1	
ZX 1.8 D		1.8	44	03.91 - 04.94	XUD 7 A9A	4	☑	Y-924J	7906	1	
ZX 1.8 D		1.8	44	05.94 - 07.98	XUD7	4	☑	Y-924J	7906	1	
ZX 1.8		1.8	76	07.92 - 06.95	XU7JP LFZ	4	0,8	BCPR5ES	6130	32	LPG 3
ZX 1.8		1.8	76	07.95 -	XU7JP Cat.	4		BKR5EK	7956	23	LPG 1
ZX 1.8i		1.8	76	07.95 -	XU7JP LFZ	4		BKR5EK	7956	23	LPG 1
ZX 1.8		1.8	82	07.97 -	XU7JP4 LFY	4		BKR5EK	7956	23	LPG 1
ZX 1.9 D		1.9	38	05.94 - 07.98	XUD9A/L	4	☑	Y-924J	7906	1	
ZX 1.9 D		1.9	47	03.91 - 04.94	XUD 9 A/L D9B	4	☑	Y-924J	7906	1	
ZX 1.9 TD		1.9	68	09.92 - 04.94	XUD 9 T/L D8A	4	☑	Y-924J	7906	1	
ZX 1.9 TD		1.9	68	05.94 - 07.98	XUD9T/L	4	☑	Y-924J	7906	1	
ZX 1.9		1.9	88	07.92 -	XU9JA DKZ Cat.	4	0,8	BCPR5ES	6130	32	LPG 3
ZX 1.9		1.9	96	03.91 - 06.92	XU9JA D6A	4	0,7	BCP6ES	4930	17	LPG 3
ZX 2.0		2.0	90	07.92 - 03.96	XU10J2C	4	0,8	BCPR5ES	6130	32	LPG 3
ZX 2.0i		2.0	90	07.92 - 03.96	XU10J2 RFX	4	0,8	BCPR5ES	6130	32	LPG 3
ZX 2.0		2.0	90	04.96 -	XU10J2C Cat.	4		BKR5EK	7956	23	LPG 1
ZX 2.0i		2.0	90	04.96 -	XU10J2 RFX	4		BKR5EK	7956	23	LPG 1
ZX 2.0		2.0	110	11.92 - 06.96	XU10J4D RFT Cat.	4		BKR6EK	2288	20	LPG 1
ZX 2.0		2.0	110	07.94 - 06.96	XU10J4D	4	0,8	BCPR6ES	2330	12	LPG 3
ZX 2.0		2.0	110	07.96 -	XU10J4RS RFS	4	0,9	BKR5EZ	7642	36	LPG 1

**DACIA****DOKKER**

Dokker 1.2 TCe		1.2	85	11.12 -	H5F 402	4	0,7	ILKAR7F7G	90061		
Dokker 1.5 dCi		1.5	55	11.12 -	K9K 612	4	☑	Y1035AS	94103	77	
Dokker 1.5 dCi		1.5	66	11.12 -	K9K 612	4	☑	Y1035AS	94103	77	
Dokker 1.6 16V		1.6	61	11.12 -	K7M 812	4		BKR6EK	2288	20	LPG 1
Dokker 1.6 16V LPG		1.6	61	11.13 -	K7M 812	4		BKR6EK	2288	20	LPG 1

**DUSTER 2**

Duster 1.2 TCe		1.2	92	10.13 -	H5F 402	4	0,7	ILKAR7F7G	90061		
Duster 1.5 dCi		1.5	63	04.10 -	K9K 796	4	☑	Y-732J	5605	4	
Duster 1.5 dCi 4x2		1.5	66	10.10 -	K9K 892	4	☑	Y1035AS	94103	77	
Duster 1.5 dCi 4x4		1.5	66	10.10 -	K9K 884	4	☑	Y-732J	5605	4	
Duster 1.5 dCi		1.5	79	06.10 -	K9K 896 / 898	4	☑	Y1035AS	94103	77	
Duster 1.5 dCi		1.5	81	06.10 -	K9K 898	4	☑	Y1035AS	94103	77	
Duster 1.6		1.6	77	03.10 -	K4M 690 / 696	4		BKR6EK	2288	20	LPG 1

**LODGY**

Lodgy 1.2 TCe		1.2	85	03.12 -	H5F 402	4	0,7	ILKAR7F7G	90061		
Lodgy 1.5 dCi		1.5	66	03.12 -	K9K 612	4	☑	Y1035AS	94103	77	
Lodgy 1.5 dCi		1.5	79	03.12 -	K9K 846	4	☑	Y1035AS	94103	77	
Lodgy 1.6		1.6	61	03.12 -	K7M 812	4		BKR6EK	2288	20	LPG 1

**LOGAN 1**

Logan I 1.4 MPI		1.4	55	09.04 -	K7J 710	4	0,9	BKR6E	6962	28	LPG 1
-----------------	--	-----	----	---------	---------	---	-----	-------	------	----	-------

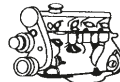

Code *l* kW

Cyl.



Stock-No.



LPG/CNG

**DACIA****LOGAN 1**

Logan I 1.5 dCi		1.5	48	09.05 -	K9K 790	4	☑	Y-732J	5605	4	
Logan I 1.5 dCi		1.5	50	01.06 -	K9K 792	4	☑	Y-732J	5605	4	
Logan I 1.5 dCi		1.5	55	05.10 -	K9K 892	4	☑	Y1035AS	94103	77	
Logan I 1.5 dCi		1.5	63	09.07 -	K9K 796	4	☑	Y-732J	5605	4	
Logan I 1.6 MPI		1.6	64	09.04 -	K7M 710	4	0,9	BKR6E	6962	28	LPG 1
					engine by renault						
Logan I 1.6 16V		1.6	77	02.06 -	K4M 690 / 696	4		BKR6EK	2288	20	LPG 1

**LOGAN 2**

Logan II 1.2 16V		1.2	55	11.12 -	D4F 732/734	4	0,9	LZKAR7B	5942		
Logan II 1.2 16V LPG		1.2	55	02.13 -	D4F 732/734	4	0,9	LZKAR7B	5942		
Logan II 1.5 dCi 75		1.5	55	11.12 -	K9K 612	4	☑	Y1035AS	94103	77	
Logan II 1.5 dCi 90		1.5	66	11.12 -	K9K 612	4	☑	Y1035AS	94103	77	

**SANDERO 1**

Sandero I 1.2 16V		1.2	55	11.08 -	D4F 732	4	0,9	LZKAR7B	5942		
Sandero I 1.2 16V Bifuel		1.2	55	11.08 -	D4F 732	4	0,9	LZKAR7B	5942		
Sandero I 1.4 Mpi		1.4	55	06.08 -	K7J 710	4	0,9	BKR6E	6962	28	LPG 1
Sandero I 1.5 dCi		1.5	50	11.08 -	K9K 792	4	☑	Y-732J	5605	4	
Sandero I 1.5 dCi		1.5	55	05.10 -	K9K 892	4	☑	Y1035AS	94103	77	
Sandero I 1.5 dCi		1.5	63	11.08 -	K9K 796	4	☑	Y-732J	5605	4	
Sandero I 1.5 dCi		1.5	65	05.10 -	K9K 892	4	☑	Y1035AS	94103	77	
Sandero I 1.6 Mpi 85		1.6	62	05.10 -	K7M 800	4		BKR6EK	2288	20	LPG 1
Sandero I 1.6 Mpi		1.6	64	06.08 -	K7M 710	4	0,9	BKR6E	6962	28	LPG 1
Sandero I 1.6 16V Bifuel		1.6	77	01.11 -	K4M 696	4		BKR6EK	2288	20	LPG 1

**SANDERO 2**

Sandero II 1.2 16V LPG		1.2	53	01.13 -	D4F 734	4	0,9	LZKAR7B	5942		
Sandero II 1.2 16V		1.2	55	01.13 -	D4F 732	4	0,9	LZKAR7B	5942		
Sandero II 1.5 dCi 75		1.5	55	01.13 -	K9K 838	4	☑	Y1035AS	94103	77	
Sandero II 1.5 dCi 90		1.5	66	01.13 -	K9K 612	4	☑	Y1035AS	94103	77	

**DAEWOO****ESPERO**

Espero 1.5		1.5	66	95 - 10.99	A15MF DOHC 16V	4	1,1	BKR6E-11	2756	14	LPG 1
Espero 1.8		1.8	66	02.95 - 10.99	C18LE	4	0,8	BPR6ES	7822	2	LPG 2
Espero 2.0		2.0	77	02.95 - 10.99	C20LE	4	0,8	BPR6ES	7822	2	LPG 2

**EVANDA**

Evanda 2.0		2.0	96	03 - 02.05	T20SED	4		BKR5EK	7956	23	LPG 1
------------	--	-----	----	------------	--------	---	--	--------	------	----	-------

**KALOS**

Kalos 1.2 SE		1.2	53	04.03 - 02.05	B12S1	4	1,1	BPR5EY-11	3028		LPG 2
Kalos 1.4 SE S100		1.4	61	09.02 - 02.05	F14S3	4	0,8	BPR6ES	7822	2	LPG 2
Kalos 1.4 SE		1.4	61	04.03 - 02.05	F14S3 SOHC	4	0,8	BPR6ES	7822	2	LPG 2
Kalos 1.4 SX		1.4	69	04.03 - 02.05	F14D3 DOHC	4	1,1	BKR6E-11	2756	14	LPG 1

**KORANDO**

Korando TD		2.3	74	04.00 -		4	☑	Y-916J	5906	6	
Korando TD, Cabriolet		2.9	88	04.00 -		5	☑	Y-916J	5906	6	
Korando		2.9		04.00 -		4	☑	Y-916J	5906	6	

**LACETTI**

Lacetti 1.4		1.4	68	09.03 - 02.05	F14D3	4	1,1	BKR6E-11	2756	14	LPG 1
-------------	--	-----	----	---------------	-------	---	-----	----------	------	----	-------

Code *l* kW

Cyl.



Stock-No.



LPG/CNG

**DAEWOO  
LANOS**

Lacetti 1.6		1.6	80	09.03 - 02.05	F16D3	4	1,1	BKR6E-11	2756	14	LPG 1
Lacetti 1.8		1.8	90	09.03 - 02.05	T18SED	4		BKR5EK	7956	23	LPG 1
Lanos 1.4		1.4	55	05.97 - 02.05	A14SMS SOHC	4	0,8	BPR6ES	7822	2	LPG 2
Lanos 1.5		1.5	63	05.97 - 02.05	A15SMS SOHC	4	0,8	BPR6ES	7822	2	LPG 2
Lanos 1.6		1.6	78	05.97 - 02.05	A16DMS DOHC	4	1,1	BKR6E-11	2756	14	LPG 1

**LEGANZA**

Leganza 2.0		2.0	100	07.97 - 12.02	X20SED DOHC	4		BKR5EK	7956	23	LPG 1
Leganza 2.2		2.2		07.97 - 12.02	T22SED DOHC	4		BKR6EK	2288	20	LPG 1

**MATIZ**

Matiz 0.8		0.8	38	06.98 - 02.05	F8CV	3	1,1	BCPR5EY-11	4120		LPG 3
Matiz 1.0		1.0	47	03.03 - 02.05	B10S	4	1,1	BCPR5EY-11	4120		LPG 3

**MUSSO**

Musso 2.0		2.0	100	09.96 -	M 161.940	4	0,8	BCP5ES	7496	16	LPG 3
Musso 2.3 SLTD		2.3	74	04.00 -		4	<input checked="" type="checkbox"/>	Y-916J	5906	6	
Musso 2.3 16V		2.3	110	11.96 -	M 161.970	4	0,8	BCP5ES	7496	16	LPG 3
Musso 2.9 SELTD		2.9	88	04.00 -		5	<input checked="" type="checkbox"/>	Y-916J	5906	6	
Musso 2.9		2.9		04.00 -		4	<input checked="" type="checkbox"/>	Y-916J	5906	6	
Musso 3.2 E32		3.2	162	05.96 -	Mercedes M162990	6	0,8	BCP5ES	7496	16	LPG 3

**NEW BROUGHAM**

New Brougham		2.0	85	01.96 - 02.97	SOHC	4	1,1	BPR5ES-11	4424		LPG 2
New Brougham		2.0	106	01.96 - 02.97	DOHC 16V	4		BKR5EK	7956	23	LPG 1
New Brougham		2.2	110	01.96 - 02.97	DOHC 16V	4		BKR5EK	7956	23	LPG 1

**NEW PRINCE**

New Prince		1.8	81	04.96 - 02.97	SOHC	4	1,1	BPR5ES-11	4424		LPG 2
New Prince		1.8	101	04.96 - 02.97	DOHC 16V	4		BKR5EK	7956	23	LPG 1
New Prince		2.0	85	04.96 - 02.97	SOHC	4	1,1	BPR5ES-11	4424		LPG 2
New Prince		2.0	106	04.96 - 02.97	DOHC 16V	4		BKR5EK	7956	23	LPG 1

**NEXIA**

Nexia 1.5		1.5	55	02.95 -	OHC	4	0,8	BPR6ES	7822	2	LPG 2
Nexia 1.5		1.5	66	02.95 -	DOHC 16V	4	1,1	BKR6E-11	2756	14	LPG 1
Nexia 1.8		1.8	74	12.95 - 10.96	C18LE SOHC	4	0,8	BPR6ES	7822	2	LPG 2

**NUBIRA**

Nubira 1.6		1.6	80	07.97 - 02.05	A16DMS DOHC	4	1,1	BKR6E-11	2756	14	LPG 1
Nubira 1.8 CDX		1.8	90	03 - 02.05	T18SED	4		BKR5EK	7956	23	LPG 1
Nubira 2.0		2.0	99	07.97 - 02.05	X20SED DOHC	4		BKR5EK	7956	23	LPG 1

**REZZO / TACUMA U100**

Rezzo / Tacuma U100		1.6	77	01 - 02.05	A16DMS	4	1,1	BKR5E-11	6953	33	LPG 1
Rezzo / Tacuma U100		2.0	89	01 - 02.05	T20SED	4		BKR5EK	7956	23	LPG 1

**TACUMA**

Tacuma 1.6		1.6		01 -	L4 DOHC	4	1,1	BKR6E-11	2756	14	LPG 1
Tacuma 1.8		1.8		01 -	L4 SOHC	4	0,9	BPR5ES	7422	6	LPG 2
Tacuma 2.0		2.0		01 -	L4 DOHC	4		BKR5EK	7956	23	LPG 1

**TOSCA**

Tosca 2.0 TDCi		2.0	110	02.06 -	Z20DMH	4	<input checked="" type="checkbox"/>	Y8009AS	96487		
----------------	--	-----	-----	---------	--------	---	-------------------------------------	---------	-------	--	--

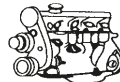
Code *l* kW

Cyl.



Stock-No.



LPG/CNG

**DAF**

400 Serie D		2.5	53	04.89 - 08.93		4		Y-924J	7906	1	
400 Serie TD		2.5	71	04.89 - 08.93		4		Y-924J	7906	1	

**DAIHATSU****CHARADE CL10,60**

Charade CL10,60		1.0	27	86 -	CL	4		Y-703R	3782		
Charade G10		1.0	38	81 -	CB20	3	0,8	BPR5EA-L	5823		LPG 2
Charade G11		1.0	38	83 -	CB22	3	0,8	BPR5EA-L	5823		LPG 2
Charade GTti G100		1.0	74	03.87 -	CB80	3	0,8	BPR6EKN	1128		
Charade CL50		1.0		86 -	CL	4		Y-703R	3782		
Charade G102		1.3	66	07.91 -	HC-E	4	1,1	BKR6E-11	2756	14	LPG 1
Charade G112 4WD		1.3	66	02.97 -	HC-E	4	1,1	BKR6E-11	2756	14	LPG 1

**COPEN L880K**

Copen L880K		0.66	50	09.03 -	JB-DET	4	1,1	IFR6J11	7658		
Copen L881		1.3	64	10.05 -	K3-VE	4	1,1	BKR6EY-11	4368		LPG 1

**CUORE**

Cuore L55		0.54	21		AB30	3	0,8	BPR6ES	7822	2	LPG 2
Cuore L60		0.61	22		AD10	3	0,8	BPR6ES	7822	2	LPG 2
Cuore L201		0.85	30		ED10	3	0,8	BPR6EY	6427		LPG 2
Cuore L80		0.85	32		ED10	3	0,8	BPR6EY	6427		LPG 2
Cuore L501		0.85	32	05.95 - 04.96	ED20	3	0,8	BPR6EY	6427		LPG 2
Cuore L501		0.85	32	05.96 -	ED20	3	1,1	BPR5EY-11	3028		LPG 2
Cuore L701		1.0	40	06.98 - 01	EJ-DE	3	1,1	BKR5E-11	6953	33	LPG 1
Cuore L701		1.0	43	07.01 -	EJ-VE	3		BKR5EKC	5216		LPG 1
Cuore L251		1.0	43	05.03 -	EJ-VE	3		BKR5EKC	5216		LPG 1
Cuore 1.0 Top L276		1.0	52	09.07 -	1KR-FE	3	1,1	ILFR6T11	4904		ILFR6T11

**ESSE**

Esse L235S		0.66		12.05 -	KF-VE	3	0,9	LKR7C	4472		
Esse L245S		0.66		12.05 -	KF-VE	3	0,9	LKR7C	4472		

**GRAN MOVE**

Gran Move L901		1.0	40	10.99 -	EJ-DE	3		BKUR6EK	2213		
Gran Move G303		1.5	66	04.97 -	HE-EG	4	1,1	BKR6E-11	2756	14	LPG 1
Gran Move G301		1.6	67	07.99 -	HD-EP	4	1,1	BKR6E-11	2756	14	LPG 1

**HIJET**

Hijet 1.0		1.0		86 -	CB42	3	0,8	BPR5EY	2828	9	LPG 2
Hijet 1.3		1.3	48	08.98 -	HC-ES	4		BKUR6EK	2213		

**MATERIA**

Materia 1.3		1.3	67	12.06 -	K3-VE	4		IKR7D	4759		
Materia 1.5		1.5	76	12.06 -	3SZ-VE	4		IKR7D	4759		

**MIRA**

Mira L235S		0.66		12.05 -	KF-VE	3	0,9	LKR7C	4472		
Mira L245S		0.66		12.05 -	KF-VE	3	0,9	LKR7C	4472		
Mira		0.85		01.93 - 97	ED10 (K)	3	0,9	BPR6EY	6427		LPG 2

**MOVE**

Move L235S		0.66		12.05 -	KF-VE	3	0,9	LKR7C	4472		
Move L245S		0.66		12.05 -	KF-VE	3	0,9	LKR7C	4472		
Move L601		0.85	31	97 - 10.00	ED20	3	1,1	BPR5EY-11	3028		LPG 2

Code *l* kW

Cyl.



Stock-No.



LPG/CNG

**DAIHATSU  
MOVE**

Move L901		1.0	40	10.99 - 09.02	EJ-DE	3		BKUR6EK	2213		
-----------	--	-----	----	---------------	-------	---	--	---------	------	--	--

**DAIHATSU  
ROCKY**

Rocky F80		2.0	65	04.84 - 04.93	3Y	4	0,8	BP5EY	7327		LPG 2
Rocky F85		2.0	65	04.84 - 04.93	3Y	4	0,8	BP5EY	7327		LPG 2
Rocky		2.8	54	02.85 -	DL	4		Y-146R	7492		
Rocky 4WD D		2.8	54	85 -	DL50	4		Y-146R	7492		
Rocky		2.8	67	12.87 - 04.93	DL51	4		Y-146R	7492		
Rocky TD		2.8	67	12.87 - 04.93	DL 51	4		Y-146R	7492		
Rocky TD		2.8	72	05.93 -	DL 52	4		Y-146R	7492		
Rocky TD		2.8	75	09.91 -	DL 52	4		Y-146R	7492		
Rocky 4WD		2.8		85 -	DL40	4		Y-128T	7227		

**SIRION 1**

Sirion 1 1.0	M100 / M110	1.0	40	06.98 - 00	EJ-DE	3		BKUR6EK	2213		
Sirion 1 1.0	M100 / M110	1.0	43	05.00 - 04	EJ-VE	3		BKR5EKC	5216		LPG 1
Sirion 1 1.3	M101 / M111	1.3	75	09.01 - 04	K3-VE2	4		BKUR6ETB-10	5742		

**SIRION 2**

Sirion 2 1.0	M300	1.0	51	01.05 -	1KR-FE	3	1,1	ILFR6T11	4904		ILFR6T11
Sirion 2 1.3	M301 / M311	1.3	64	07.07 -	K3-VE	4	0,9	DCPR7EA-9	6651		
Sirion 2 1.3	M301 / M311	1.3	64	01.05 - 06.07	K3-VE	4	1,1	BKR6EY-11	4368		LPG 1
Sirion 2 1.3	M301 / M311	1.3	67	03.08 -	K3-VE	4	0,9	DCPR7EA-9	6651		
Sirion 2 1.5	M303	1.5	76	03.08 -	3SZ-VE		0,9	DCPR7EA-9	6651		

**TERIOS 1**

Terios 1 1.3	J100	1.3	61	09.97 - 00	HC-EJ Aluengien	4		BKUR6EK	2213		
Terios 1 1.3	J102	1.3	63	05.00 - 12.05	K3-VE	4		BKUR6ETB-10	5742		

**TERIOS 2**

Terios 2 1.3	J211	1.3	63	11.05 -	K3-VE	4	1,1	BKR6EY-11	4368		LPG 1
Terios 2 1.5	J200 / J210	1.5	77	01.06 - 12.07	3SZ-VE	4		IKR7D	4759		IKR7D
Terios 2 1.5	J200 / J210	1.5	77	01.08 -	3SZ-VE	4	0,9	DCPR7EA-9	6651		

**TREVIS**

Trevis automatic		1.0	43	09.06 -	EJ-VE	4		BKR6EKC	2848	26	LPG 1
Trevis Schaltgetriebe		1.0	43	09.06 -	EJ-VE	4		BKUR6EK	2213		

**YRV**

YRV 1.0	M200	1.0	43	08.00 - 07.05	EJ-VE	4		BKR5EKC	5216		LPG 1
YRV 1.3	M201 / M211	1.3	64	01.01 - 07.05	K3-VE	4		BKUR6ETB-10	5742		
YRV 1.3 GTti	M201	1.3	95	07.02 - 07.05	K3-VT	4	0,8	BKR6EP-8	2215		LPG 1

**DAIMLER**

4.0 Litre		4.0	164	09.89 - 09.94	AJ6	6	0,8	BCPR6ES	2330	12	LPG 3
4.0 Super V8		4.0		09.97 - 03.00		8	1,3	PFR6G-13E	2341		
4.0 Super V8		4.0		03.00 - 03.02		8	1,1	PFR5G-11E	3000		
4.0 Super V8		4.0		03.02 -		8	1,0	IFR5N10	7866		
4.0 V8		4.0		09.97 - 09.98		8	1,3	BKR5EVXA-13	1188		
4.0 V8		4.0		09.98 - 03.00		8	1,3	PFR5G-13E	2761		
4.0 V8		4.0		03.00 - 03.02		8	1,1	PFR5G-11E	3000		
4.0 V8		4.0		03.02 -		8	1,0	IFR5N10	7866		
Century 4.0		4.0	180	10.95 - 09.96	AJ6	6	0,8	BCPR6ES	2330	12	LPG 3
Century 6.0		6.0		10.95 - 09.96	HE	12	0,6	BR6EF	3177		



Code *l* kW

Cyl.



Stock-No.



LPG/CNG

**DAIMLER**

Double Six			10.91 - 93	HE	12	0,6	BR7EF	3346		
Double Six		5.3	90 -	V12 HE	12	0,6	BR7EFS	1094		
Double Six		6.0	02.93 - 09.94	HE	12	0,6	BR7EFS	1094		
Double Six 6.0		6.0	93 -	HE	12	0,6	BR7EF	3346		
Double six		6.0	09.94 - 09.97	HE	12	0,6	BR6EF	3177		
Six 4.0		4.0	09.94 - 09.97	AJ6	6	0,8	BCPR6ES	2330	12	LPG 3
Sovereign 4.0		4.0	89 -			0,8	BCPR6ES	2330	12	LPG 3
4.0 Super V8		4.0	267 09.97 - 03.00	V8	8	1,3	PFR6G-13E	2341		
4.0 V8		4.0	09.97 - 09.98	AJ26	8	1,3	BKR5EVXA-13	1188		
4.0 V8		4.0	09.98 - 03.00	AJ26	8	1,3	PFR5G-13E	2761		
4.0 Super V8		4.0	03.00 - 03.02	AJ26	8	1,1	PFR5G-11E	3000		
4.0 V8		4.0	03.00 - 03.02	AJ26	8	1,1	PFR5G-11E	3000		
4.2 Super V8		4.2	03.02 -	AJ26	8	1,0	IFR5N10	7866		
4.2 V8		4.2	03.02 -	AJ26	8	1,0	IFR5N10	7866		

**DODGE****AVENGER**

Avenger 2.0		2.0	115	06.07 -		6	1,1	PZFR5F-11	4363		LPG 6
Avenger 2.0		2.0		95 - 99	L4 MPI Y DOHC	4	1,1	BKR6EIX-11	3764		LPG 1
Avenger 2.5		2.5		95 -	V6 MPI N DOHC	6	1,1	PFR5G-11	2647		
Avenger 2.7		2.7	138	06.07 -	V6	6	1,3	LZTR5A-13	4612		

**CALIBER**

Caliber 1.8		1.8	110	06 -		4	1,1	ZFR5F-11	2262		LPG 6
Caliber 2.0		2.0	115	06 -		4	1,1	ZFR5F-11	2262		LPG 6
Caliber 2.4		2.4	125	06 -		4	1,1	ZFR5F-11	2262		LPG 6

**CHARGER**

Charger SRT8 Twinspark		6.1		06 -	W V8 FI	8	1,3	PLZTR5A-13	4998		
------------------------	--	-----	--	------	---------	---	-----	------------	------	--	--

**COLT**

Colt 1.5		1.5		93 - 94	L4 MPI A	4	1,1	BPR5EIX-11	2115		LPG 2
Colt 1.8		1.8		92 - 94	L4 MPI C	4	1,1	BKR5EVX-11	5182		LPG 1
Colt 2.4		2.4		92 - 92	L4 MPI W	4	1,1	BPR5EIX-11	2115		LPG 2
Colt 2.4		2.4		93 - 94	L4 MPI G	4	1,1	BKR6EVX-11	3540		LPG 1

**INTREPID**

Intrepid 2.7		2.7		98 -	V6 MPI R DOHC	6	1,3	LZTR5A-13	4612		
Intrepid 3.3		3.3		93 - 97	V6 MPI T	6	1,2	GR45	2822		GR5IX
Intrepid 3.3		3.3		94 - 95	V6 FF U	6	1,2	GR45	2822		GR5IX
Intrepid 3.5		3.5		93 - 97	V6 MPI F	6	0,9	FR5-1	7252		

**MAGNUM**

Magnum SRT8		6.1		06 -	W V8 FI	8	1,3	LZTR5A-13	4612		
-------------	--	-----	--	------	---------	---	-----	-----------	------	--	--

**NEON**

Neon 2.0		2.0		95 - 99	L4 MPI Y DOHC	4	0,8	BKR6ES	3783	28	LPG 1
Neon 2.0		2.0		02 -	L4 MPI C SOHC	4	0,8	BKR6ES	3783	28	LPG 1

**NITRO**

Nitro 4.0 V6	KJ (UE86)	4.0	191	06.07 -	V 6	6	1,3	ZFR5LP-13G	7781		
--------------	-----------	-----	-----	---------	-----	---	-----	------------	------	--	--

**R1500-3500**

R1500-3500		3.9		94 - 96	MPI X	6	0,9	FR4	5188		
R1500-3500		3.9		97 - 99	MPI X	6	1,1	FR5-1	7252		
R1500-3500		5.2		94 - 96	MPI Y	8	0,9	FR4	5188		

Code  $\ell$  kWCyl.  $\cup$ 

Stock-No.



LPG/CNG

**DODGE**  
**R1500-3500**

R1500-3500		5.2		95 - 96	CNG T	8	0,9	FR4	5188		
R1500-3500		5.2		97 - 99	CNG T	8	1,1	FR5-1	7252		
R1500-3500		5.2		97 - 99	MPI Y	8	1,1	FR5-1	7252		
R1500-3500		5.9		94 - 97	MPI Z	8	0,9	FR4	5188		
R1500-3500		5.9		94 - 95	TBI 5	8	1,1	WR5	2438		
R1500-3500		5.9		97 - 97	MPI 5	8	0,9	FR4	5188		
R1500-3500		5.9		98 - 99	MPI 5	8	1,1	FR5-1	7252		
R1500-3500		5.9		98 - 99	MPI Z	8	1,1	FR5-1	7252		
R1500-3500		8.0		94 - 96	MPI W	10	1,1	PZFR5F-11	4363		LPG 6
R1500-3500		8.0		97 - 99	MPI W	10	1,1	PZFR5F-11	4363		LPG 6

**STEALTH**

Stealth		3.0		91 - 92	V6 MPI B DOHC	6	1,1	PFR6J-11	2743		
Stealth Turbo		3.0		91 - 92	V6 MPI C DOHC	6	1,1	PFR6J-11	2743		
Stealth		3.0		93 - 96	V6 MPI H SOHC	6	1,1	BPR5EIX-11	2115		LPG 2
Stealth		3.0		93 - 96	V6 MPI J DOHC	6	1,1	PFR6J-11	2743		
Stealth Turbo		3.0		93 - 96	V6 MPI K DOHC	6	1,1	PFR6J-11	2743		

**STRATUS**

Stratus 2.0		2.0		95 -	L4 MPI C SOHC	4	0,9	FR5	4876		
Stratus 2.4		2.4		95 - 00	L4 MPI X DOHC	4	1,1	FR45	4636		
Stratus 2.4		2.4		01 - 03	L4 FI X,G DOHC/TURBO	4	1,3	LZTR5A-13	4612		
Stratus 2.4		2.4		04 -	L4 FI X,G	4	1,1	LZTR4A-11	5444		
Stratus 2.5		2.5		95 -	V6 MPI H DOHC	6	1,1	PFR5G-11	2647		PFR6G-11

**VIPER**

Viper 8.0		8.0		92 - 02	E V10 MPI	10	0,9	FR5-1	7252		
Viper 8.3		8.3		03 - 03	Z V10	10	0,8	ZFR5N	3459		
Viper 8.3		8.3		04 - 06	Z V10	10	1,1	PZFR6F-11	3271		LPG 6

**FERRARI**

575 M Maranello / F1		5.7	379	02.02 - 06.06	F133E	12	0,7	DCPR9EIX	2316		
599 GTB FIORANO		6.0	456	05.06 -	F140C	12		PMR8B	6378		
612 Scaglietti		5.7	397	09.04 -	F133F	12	0,7	DCPR9EIX	2316		
Challenge Stradale		3.6	313	01.04 -	F131B	8		PMR8B	6378		
Enzo		6.0	485	02 -	F140B	12		PMR8B	6378		
F348 TB; TS		3.4	221	09.89 - 04.94	F119D040 Cat.	8	0,6	DR8EIX	6681		
348 GTB; GTS		3.4	221	04.90 - 03.93	F119F	8	0,7	DCPR9EIX	2316		
348 GTB; GTS		3.4	236	03.93 - 06.94	F119H	8	0,7	DCPR9EIX	2316		
F348 GTB; GTS / Spider		3.9	221	07.94 - 07.95	F119	8	0,7	DCPR9EIX	2316		
F355		3.5	280	05.94 - 01.96	F129C	8	0,7	PMR8A	5851		
F355 Berlinetta		3.5	280	07.94 -		8	0,6	CR8EIX	4218		
F355GTS		3.5	280	05.94 - 01.96	F129B	8	0,7	PMR8A	5851		
F355 Spider		3.5	280	07.95 -		8	0,7	PMR7A	4259		
F355GTS		3.5	280	02.96 -	F129C	8	0,7	PMR7A	4259		
F355 F1 berlinetta; GTS; Spider		3.5	280	11.97 -	F129C	8	0,7	PMR7A	4259		
Modena 360 - 360 F1		3.6	294	05.99 - 11.03	F131B	8	0,7	PMR8A	5851		
360 Spider / F1		3.6	294	09.00 - 11.03	F131B	8	0,7	PMR8A	5851		
360 Spider / F1		3.6	294	12.03 -	F131B	8		PMR8B	6378		
Coupè 360 Modena/F1		3.6	294	12.03 -	F131B	8		PMR8B	6378		
F40		2.9	353	01.88 - 05.92	F120A	8	0,5	C8E	7471		
F430 Coupé / F430 Spider / F430 Challenge		4.3	360	01.05 -	F136E	8		PMR8B	6378		
430 Scuderia		4.3	375	08 -	F136ED	8		PMR8B	6378		

Code *l* kW

Cyl.



Stock-No.

VEMO

E-Power

LPG/CNG

**FERRARI**

F456 GT		5.5	324	02.96 - 04.98	F116C	12	0,7	DCPR9EIX	2316		
F456 GTA		5.5	324	07.96 - 04.98	F116C.010	12	0,7	DCPR9EIX	2316		
456 M GTA		5.5	325	05.98 -	F116C.010	12	0,7	DCPR9EIX	2316		
465 M GT		5.5	325	05.98 -	F116C	12	0,7	DCPR9EIX	2316		
F50		4.7	361	05.95 -	F130B	12	0,7	PMR7A	4259		
512 TR		5.0	316	02.91 - 10.96	F113D	12	0,7	DCPR9EIX	2316		
Mondial T/ T Cabriolet		3.4	221	11.88 - 02.94	F119DL Cat	8	0,6	DR8EIX	6681		
F456 GT		5.5	324	04.93 - 01.96	F116B	12	0,7	DCPR9EIX	2316		
F550 Maranello		5.5	357	08.96 -	F133A	12	0,7	DCPR9EIX	2316		

**FIAT****126**

126 (650)		0.65	22	01.83 - 06.96	141A000		0,8	BPR6ES	7822	2	LPG 2
126 BIS		0.7	19	09.87 - 06.91	126A2000	2	0,8	BPR6ES	7822	2	LPG 2

**500**

500 0.9 Twin Air	312	0.9	63	07.10 -	312A2000	2	0,8	ILKR9G8	97168		
500 0.9 Twin Air	312	0.9	77	10.13 -	199B6000	2	0,8	ILKR9G8	97168		
500 1.0	312	1.0	48	09.12 -	312A4000	2	1,2	LKR7DI-12	90779		
500 1.2	312	1.2	51	07.07 -	169A4000	4	1,0	ZKR7A-10	1691		LPG 8
500 1.2 Easypower LPG Euro V	312	1.2	51	01.09 -	169A4000	4	0,8	ZKR7AI-8	92402		
500 1.3 D Mjet	312	1.3	56	07.07 -	169A1000	4	█	Y8003J	97256	62	
500 1.3 D Mjet	312	1.3	70	11.09 -	199B1000	4	█	Y9001AS	97719	72	
500 1.4 16V	312	1.4	74	07.07 -	169A3000	4	1,0	DCPR7E-N-10	4983		LPG 8
500 1.4 Abarth	312	1.4	99	08.08 -	312A1000	4	0,8	IKR9J8	93311		
500 1.4 Abarth	312	1.4	102	05.08 -	198A1000	4	0,8	IKR9J8	93311		
500 1.4 Abarth	312	1.4	132	08.08 -	312A3000	4	0,8	IKR9J8	93311		
500 1.4 Abarth	312	1.4	140	08.08 -	312A1000	4	0,8	IKR9J8	93311		

**500 L**

500 L 0.9	199	0.9	77	09.12 -	199B6000	2	0,8	ILKR9G8	97168		
500 L 1.3 16V Multijet	199	1.3	62	09.12 -	199B4000	4	█	Y9001AS	97719	72	
500 L 1.4	199	1.4	70	09.12 -	843A1.000	4	0,9	DCPR7E-N	4795		LPG 8
500 L 1.4 T-Jet	199	1.4	88	10.13 -	940B7000	4	0,8	IKR9J8	93311		
500 L 1.6 16V Multijet	199	1.6	77	09.12 -	199B5000	4	█	Y9001AS	97719	72	
500 L 1.6 16V Multijet	199	1.6	88	09.13 -	955A3000	4	█	Y9003AS	94251	78	

**ALBEA / SIENA**

Albea / Siena 1.2	178	1.2	44	09.01 - 12.12	178 C4066	4	0,9	BKR5EZ	7642	36	LPG 1
Albea / Siena 1.2 to engine no. 2533528	178	1.2	44	09.01 - 12.12	188 A4000	4	0,9	BKR5EZ	7642	36	LPG 1
Albea / Siena 1.2 from engine no. 2533529	178	1.2	44	09.01 - 12.12	188 A4000	4	1,0	DCPR7E-N-10	4983		LPG 8
Albea / Siena 1.2	178	1.2	54	09.98 - 12.02	178 B5000	4		BKR6EKC	2848	26	LPG 1
Albea / Siena 1.2	178	1.2	59	09.01 - 12.11	188 A5000	4	0,9	DCPR7E-N	4795		LPG 8
Albea / Siena 1.3 JTD	178	1.3	51	06.03 - 12.11	188 A9000	4	█	Y8003J	97256	62	
Albea / Siena 1.4	178	1.4	51	04.96 - 12.02	178 B2000 / 178 B2016	4	0,9	BKR5EZ	7642	36	LPG 1
Albea / Siena 1.4	178	1.4	57	10.05 - 12.12	199 A1000 / 834 A1000	4	0,9	BKR5EZ	7642	36	LPG 1
Albea / Siena 1.6	178	1.6	76	11.00 - 12.12	182 B6000	4	0,9	BKR5EZ	7642	36	LPG 1
Albea / Siena 1.6	178	1.6	78	07.97 - 06.99	178B3.000	4		BKR6EKC	2848	26	LPG 1
Albea / Siena 1.6	178	1.6	78	07.99 - 12.04	178B3.000	4	0,9	BKR5EZ	7642	36	LPG 1
Albea / Siena 1.7 TD	178	1.7	51	02.06 - 12.12	176 A3000	4	█	Y-924J	7906	1	
Albea / Siena 1.9 D	178	1.9	46	11.00 -	223 A6000	4	█	Y-939J	5059	43	

Code *l* kW

Cyl.



Stock-No.



LPG/CNG

**FIAT  
BARCHETTA**

Barchetta	183	1.8	96	04.95 - 07.00	183A1.000	4		BKR6EKC	2848	26	LPG 1
Barchetta	183	1.8	96	08.00 - 05.05	183A1.000	4	0,9	BKR6EZ	4619	38	LPG 1

**BRAVA**

Brava i.,80 16V Sx,Hsx	182	1.2	59	03.98 - 05.99	182B2.000	4		DCPR8EKC	7168		LPG 8
Brava ;80 16V; Trofeo,Steel Sx,Hsx	182	1.2	59	06.99 - 05.01	182B2.000	4	0,9	DCPR8E-N	5692		LPG 8
Brava i. 12V	182	1.4	55	10.95 - 02.98	182A5.000	4		BKR6EKC	2848	26	LPG 1
Brava - 12V- S,SX	182	1.4	59	10.95 - 05.01	182A3.000	4		BKR6EKC	2848	26	LPG 1
Brava 16V	182	1.6	66	10.95 - 05.01	182A6.000	4		BKR6EKC	2848	26	LPG 1
Brava i. 16V EL; aut. EL; ELX	182	1.6	76	10.95 - 06.96	182A4.000	4		BKR6EKC	2848	26	LPG 1
Brava i.,100 16V;Aut. Sx,Hsx,Elx	182	1.6	76	05.98 - 06.99	182A4.000	4		BKR6EKC	2848	26	LPG 1
Brava 100 16V Sx,Hsx,Elx;Aut.	182	1.6	76	07.99 - 05.01	182A4.000	4	0,9	BKR5EZ	7642	36	LPG 1
Brava 16V	182	1.8	83	10.95 - 05.01	182A2.000	4		BKR6EKC	2848	26	LPG 1
Brava / o D	182	1.9	55	09.95 - 10.96	160A7.000	4		Y-924J	7906	1	
Brava / o D; TD	182	1.9	55	04.96 - 11.99		4		Y-928U	4389	29	
Brava / o 1.9 JTD	182	1.9	74	09.00 - 10.01	182B9000	4		Y-534J	3413	36	
Brava / o 1,9 JTD	182	1.9	77	12.98 - 11.99	182B4.000 fino a n. motore —>1716458	4		Y-747U	4694	26	
Brava / o 1,9 JTD	182	1.9	77	12.99 - 09.00	182B4.000 dal n. motore 1716450 —>	4		Y-534J	3413	36	
Brava / o D	182	2.0	74	09.95 - 07.96		4		Y-924J	7906	1	

**BRAVO 1**

Bravo 1 i.,80 16V Sx;Trofeo;Steel	182	1.2	59	03.98 - 05.99	182B2000	4		DCPR8EKC	7168		LPG 8
Bravo 1 80 16V Sx Trofeo; Steel	182	1.2	59	06.99 - 05.01	182B2000	4	0,9	DCPR8E-N	5692		LPG 8
Bravo 1 i. 12V	182	1.4	55	10.95 - 02.98	182A5000	4		BKR6EKC	2848	26	LPG 1
Bravo 1 1.4i 12V S	182	1.4	59	03.98 - 05.01	182A3000	4		BKR6EKC	2848	26	LPG 1
Bravo 1 i. 16V	182	1.6	66	10.95 - 05.01	182A6000	4		BKR6EKC	2848	26	LPG 1
Bravo 1 100 16V EL;Aut.	182	1.6	76	10.95 - 06.01	182A4000	4		BKR6EKC	2848	26	LPG 1
Bravo 1 100 16V El,Sx,GT,Steel; Aut.	182	1.6	76	07.99 - 05.01	182A4000	4	0,9	BKR5EZ	7642	36	LPG 1
Bravo 1 1.8L - 16V GT	182	1.8	83	03.95 - 05.01	182A2000	4		BKR6EKC	2848	26	LPG 1
Bravo 1 i. 20V, 155 HGT	182	2.0	108	10.95 - 05.01	182A1000	5		BKR6EKC	2848	26	LPG 1
Bravo 1 155 20V	182	2.0	113	12.99 - 05.01	182A1000	4		BKR6EKC	2848	26	LPG 1

**BRAVO 2**

Bravo 2 1.4 16V	198	1.4	66	01.07 -	192B2000	4	1,0	DCPR7E-N-10	4983		LPG 8
Bravo 2 1.4 T-Jet	198	1.4	88	09.07 -	198A4000	4	0,8	IKR9J8	93311		IKR9J8
Bravo 2 1.4 T-Jet	198	1.4	103	03.08 -	198A7000	4	0,8	IKR9J8	93311		IKR9J8
Bravo 2 1.4 T-Jet	198	1.4	110	04.07 -	198A1000	4	0,8	IKR9J8	93311		IKR9J8
Bravo 2 1.6 D Mjet	198	1.6	66	03.08 -	198A3000	4		Y9003AS	94251	78	
Bravo 2 1.6 D Mjet	198	1.6	77	03.08 -	198A3000	4		Y9003AS	94251	78	
Bravo 2 1.6 D Mjet	198	1.6	85	11.08 -	955A4000	4		Y9003AS	94251	78	
Bravo 2 1.6 D Mjet	198	1.6	88	03.08 -	198A2000	4		Y9003AS	94251	78	
Bravo 2 1.9 D Mjet	198	1.9	66	04.07 - 12.08	192B5000	4		Y1030J	90828	70	
Bravo 2 1.9 D Mjet	198	1.9	85	04.07 - 06.08	192B4000 / 192A1000	4		Y1030J	90828	70	
Bravo 2 1.9 D Mjet	198	1.9	88	04.07 -	192A8000	4		Y1030J	90828	70	
Bravo 2 1.9 D Mjet	198	1.9	110	01.07 -	937A5000	4		YE07	6092		
Bravo 2 2.0 D Mjet	198	2.0	120	09.08 -	844A2000	4		Y9003AS	94251	78	
Bravo 2 2.0 D Mjet	198	2.0	121	09.08 -	198A5000	4		Y9003AS	94251	78	

**CINQUECENTO**

Cinquecento 700 ED	170	0.7	23	07.91 - 02.97	170A000	2	0,8	BPR6ES	7822	2	LPG 2
--------------------	-----	-----	----	---------------	---------	---	-----	--------	------	---	-------



Code *l* kW

Cyl.



Stock-No.

V-TUNE

E-POWER

LPG/CNG

**FIAT****CINQUECENTO**

Cinquecento 900	170	0.9	29	02.95 - 05.98	1170 A1046	4	0,8	BPR6ES	7822	2	LPG 2
Cinquecento i S,SX,SUITE	170	0.9	29	07.95 - 12.99		4	0,8	BPR6ES	7822	2	LPG 2
Cinquecento 900 -Van	170	0.9	29	04.96 - 05.98	1170.1046	4	0,8	BPR6ES	7822	2	LPG 2
Cinquecento	170	0.9	30	92 - 05.98	170A1000	4	0,8	BPR6ES	7822	2	LPG 2
Cinquecento 900	170	0.9	30	92 - 05.98	170A1046 Cat.	4	0,8	BPR6ES	7822	2	LPG 2
Cinquecento	170	1.1	40	10.94 - 05.98	176B2000	4	0,8	BCPR6ES	2330	12	LPG 3
Cinquecento Sporting Fire	170	1.1	40	94 - 05.98	176A6000	4	0,8	BCPR6ES	2330	12	LPG 3
Cinquecento Sport	170	1.2	55	04.96 - 05.98	176B2000	4	0,8	BCPR6ES	2330	12	LPG 3

**COUPÉ FIAT**

Coupé 1.8L 16V	FA/175	1.8	96	02.96 - 02.01	183A1000	4		BKR6EKC	2848	26	LPG 1
Coupé 2.0L 16V	FA/175	2.0	103	02.94 - 09.96	836A3000	4	0,8	BPR7ES	2023	19	BPR8EIX
Coupé 2.0L 20 V	FA/175	2.0	108	10.96 - 02.01	182A1000	5		BKR6EKC	2848	26	LPG 1
Coupé 2.0L 16V Turbo	FA/175	2.0	140	02.94 - 09.96	175A1000	4		BUR6ET	3172	1	LPG 2
Coupé 2.0L 20V Turbo	FA/175	2.0	162	- 12.96	175A3000	5		BKR6EKC	2848	26	LPG 1
Coupé 2.0L 20V Turbo	FA/175	2.0	162	10.96 - 02.01	175A3000	5		BKUR6ET	6437	27	LPG 1

**CROMA 1**

Croma TD (TDId)	154	1.9	69	07.90 - 98	154 C6.000; 154 D 1.000	4		Y-739R	6639		
Croma CHT- 2.0L	154	2.0	72	91 - 02.97	154.C5.000	4	0,8	BPR7ES	2023	19	BPR8EIX
Croma 2.0L	154	2.0	84	86 - 02.97	834.B.146	4	0,8	BPR7ES	2023	19	BPR8EIX
Croma 2.0L	154	2.0	85	07.91 - 02.97	154C3.046 Cat.	4	0,8	BPR7ES	2023	19	BPR8EIX
Croma 2.0L - .S	154	2.0	85	04.95 - 99		4	0,8	BPR7ES	2023	19	BPR8EIX
Croma I 2.0L	154	2.0	86	91 - 02.97	154.C3.000	4	0,8	BPR7ES	2023	19	BPR8EIX
Croma 16V- 2.0L	154	2.0	101	91 - 02.97	154E1.000	4	0,8	BPR7ES	2023	19	BPR8EIX
Croma 2.0L - 16V	154	2.0	101	04.95 - 06.00		4	0,8	BPR7ES	2023	19	BPR8EIX
Croma Ti Turbo	154	2.0	110	86 - 02.97	154.C4.000	4		BP6ET	1263		LPG 2
Croma Ti Turbo	154	2.0	110	86 - 02.97	834.C.146	4		BP6ET	1263		LPG 2
Croma Turbo	154	2.0	110	91 - 02.97	154C4.046 /Cat.	4		BP6ET	1263		LPG 2
Croma Turbo 2.0L	154	2.0	110	04.95 - 06.00		4		BUR6ET	3172	1	LPG 2
Croma Turbo	154	2.0	114	86 - 02.97	154.A2.000	4		BP6ET	1263		LPG 2
Croma Td	154	2.5	85	02.89 - 12.92	8144.97.200/.2200	4		Y-924J	7906	1	
Croma TD	154	2.5	85	01.94 - 99		4		Y-926U	7119		
Croma	154	2.5	90	01.93 - 12.93		4		Y-924J	7906	1	
Croma 2.5L	154	2.5	90	01.94 - 98		4		Y-924J	7906	1	
Croma V6- 2.5L	154	2.5	117	93 - 02.97	834G.000	6	0,8	BPR7ES	2023	19	BPR8EIX
Croma V6- 2.5L	154	2.5	117	04.95 - 99		6	0,8	BPR7ES	2023	19	BPR8EIX

**CROMA 2**

Croma 1.8 16V	194	1.8	103	06.05 - 12.11	939A4000	4	1,1	ZFR5F-11	2262		LPG 6
Croma 1.9 D Mjet	194	1.9	85	06.05 - 08.06	939A7000	4		Y-534J	3413	36	
Croma 1.9 D Mjet	194	1.9	85	09.06 - 12.11	939A7000	4		Y1030J	90828	70	
Croma 1.9 D Mjet	194	1.9	88	06.05 - 08.06	939A1000	4		Y-534J	3413	36	
Croma 1.9 D Mjet	194	1.9	88	09.06 - 12.11	939A1000	4		Y1030J	90828	70	
Croma 1.9 D Mjet	194	1.9	100	10.05 - 10.07	939A8000	4		YE07	6092		
Croma 1.9 D Mjet 16V	194	1.9	110	06.05 - 12.11	939A2000	4		YE07	6092		
Croma 2.2 16V	194	2.2	108	06.05 - 12.13	194A1000	4		LTR6B-10T	5948		LTR6B-10T
Croma 2.4 D Mjet 20V	194	2.4	147	06.05 - 12.11	939A3000	5		YE07	6092		

**DOBLÒ 1**

Doblò	119	1.2	48	11.00 - 12.04	223A5000	4	0,9	BKR5EZ	7642	36	LPG 1
-------	-----	-----	----	---------------	----------	---	-----	--------	------	----	-------

Code *l* kW

Cyl.



Stock-No.



LPG/CNG

**FIAT  
DOBLÒ 1**

Doblò	119	1.2	48	12.04 - 02.05	223A5000	4	1,0	DCPR7E-N-10	4983		LPG 8
Doblò MJ	119	1.3	51	11.03 - 12.05	188A9000	4		Y8003J	97256	62	
Doblò 1.3 D Mjet	119	1.3	55	08.05 -	199A2000	4		Y8003J	97256	62	
Doblò 1.3 D Mjet	119	1.3	62	11.05 -	223A9000	4		Y8003J	97256	62	
Doblò	119	1.4	56	09.05 -	350A1000	4	1,0	ZKR7A-10	1691		LPG 8
Doblò 1.6	119	1.6	76	11.00 - 06.05	182B6000	4	0,9	BKR5EZ	7642	36	LPG 1
Doblò Natural Power	119	1.6	76	11.00 -	182B6000	4		BKR6EKC	2848	26	LPG 1
Doblò 1,9 D	119	1.9	46	11.00 - 04.04	223A6000	4		Y-939J	5059	43	
Doblò 1.9 JTD	119	1.9	74	10.01 - 06.03	182B9000 / 223B2000	4		Y-534J	3413	36	
Doblò 1.9 JTD	119	1.9	77	07.03 - 09.05	223A7000 / 223B1000	4		Y-534J	3413	36	
Doblò 1.9 D Mjet	119	1.9	88	10.05 -	186A9000	4		Y1030J	90828	70	

**DOBLÒ 2**

Doblò 1.3 D Mjet	152	1.3	66	02.10 -	199A3000 / 263A2000	4		Y8003J	97256	62	
Doblò 1.4	152	1.4	70	02.10 -	843A1000	4	1,0	DCPR7E-N-10	4983		LPG 8
Doblò 1.4 T-Jet	152	1.4	88	10.11 -	198A4000	4	0,8	IKR9J8	93311		IKR9J8
Doblò 1,4 T-Jet Natural Power	152	1.4	88	02.10 -	198A4000	4	0,8	IKR9J8	93311		IKR9J8
Doblò 1.6 D Mjet	152	1.6	66	02.10 -	263A4000	4		Y9003AS	94251	78	
Doblò 1.6 D Mjet	152	1.6	74	02.10 -	263A3000	4		Y9003AS	94251	78	
Doblò 1.6 D Mjet	152	1.6	77	02.10 -	198A3000	4		Y9003AS	94251	78	
Doblò 2.0 D Mjet	152	2.0	99	02.10 -	263A1000	4		Y9003AS	94251	78	

**DUCATO**

Ducato 10D D		1.9	51	03.94 -		4		Y-914U	2643	1	
Ducato 10TD		1.9	59	03.94 -	Kat.	4		Y-922R	4356	1	
Ducato 10TD		1.9	60	03.94 -		4		Y-914U	2643	1	
Ducato 14 TD		1.9	60	01.90 - 02.94	280A1000	4		Y-914U	2643	1	
Ducato 10 D		2.0	52	02.87 -	149B1000	4		Y-924J	7906	1	
Ducato 14		2.0	55	01.86 - 01.94	170BXN1T/170DXN 1TA	4	0,7	BP6ES	7811	4	LPG 2
Ducato 10 TD		2.0	60	01.90 - 02.94	280A1000	4		Y-914U	2643	1	
Ducato 10		2.0	62	06.88 -	170D XN 1TA	4	0,7	BP6ES	7811	4	LPG 2
Ducato 10-14 Maxi		2.0	80	01.94 -	RFW	4	0,7	BP6ES	7811	4	LPG 2
Ducato 115 Mjet 2.0 D		2.0	85	06.11 -	250A1000	4		Y9003AS	94251	78	
Ducato 100 Mjet 2.2 D		2.2	74	07.06 -	4HV	4		Y-548J	94832	75	
Ducato 120 Mjet 2.3 D		2.3	88	04.02 -	F1AE0481C / F1AE0481D / F1AE0481N	4		Y8005J	96853	64	
Ducato 14 TD		2.4	68	01.86 - 02.94	8144.21.220	4		Y-908R	4585	1	
Ducato 14 D		2.4		01.86 - 02.94		4		Y-908R	4585	1	
Ducato 10 D		2.5	53	01.86 - 02.94	8144.67	4		Y-908R	4585	1	
Ducato 14 D		2.5	55	01.86 - 02.94	8144.67.220	4		Y-908R	4585	1	
Ducato 14 D 4x4		2.5	55	01.89 - 02.94	8144.67.220	4		Y-908R	4585	1	
Ducato TD		2.5	68	01.86 - 02.94		4		Y-908R	4585	1	
Ducato 14 TD 4x4		2.5	68	01.89 - 02.94	8144.21.220	4		Y-914U	2643	1	
Ducato 14 TDi		2.5	81	03.94 -	8140.47.2280 Kat.			Y-910J	3617	3	
Ducato 18 Maxi D		2.5	55	01.86 - 02.94				Y-910J	3617	3	
Ducato 18 Maxi TD		2.5	68	01.86 - 02.94	8144.21.220	4		Y-908R	4585	1	
Ducato (230) 2,8D		2.8	64	02.98 -				Y-502R	3852		
Ducato 160 Mjet 3.0 D		3.0	115	06 -	F1CE0481D	4		Y8005J	96853	64	

**FIORINO**

Fiorino D		1.3	33	06.90 - 08.93	146B1000	4		Y-924J	7906	1	
-----------	--	-----	----	---------------	----------	---	--	--------	------	---	--

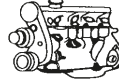
Code *l* kW

Cyl.

Stock-No.  
**VEFINE****B-FORMER\***  
LPG/CNG**FIAT****FIORINO**

Fiorino		1.4	51	01.93 -	160.A1.046	4	0,9	BPR5ES	7422	6	LPG 2
Fiorino		1.5	55	01.90 - 08.93	149C1000 Cat.	4	0,8	BPR6ES	7822	2	LPG 2
Fiorino D		1.7	42	01.88 -	149 B4.046	4	█	Y-924J	7906	1	
Fiorino D		1.7	43	12.87 -	149B3000	4	█	Y-924J	7906	1	
Fiorino 1.3 D Mjet EURO IV	225	1.3	55	02.08 -	199A2000	4	█	Y8003J	97256	62	
Fiorino 1.3 D Mjet EURO V	225	1.3	55	02.08 -	199A2000	4	█	Y9001AS	97719	72	
Fiorino 1.3 D Mjet	225	1.3	70	07.09 -	199B1000	4	█	Y9001AS	97719	72	
Fiorino 1.4	225	1.4	54	02.08 -	KFT / KFV	4	0,9	BKR6EZ	4619	38	LPG 1
Fiorino 1.4 Natural Power	225	1.4	57	10.09 -	350A1000	4	1,0	ZKR7A-10	1691		LPG 8

**FREEMONT**

Freemont 2.0 JTD	JC	2.0	100	08.11 -	940A5000	4	█	Y9003AS	94251	78	
Freemont 2.0 JTD	JC	2.0	103	08.11 -	940A5000	4	█	Y9003AS	94251	78	
Freemont 2.0 JTD	JC	2.0	120	08.11 -	940A4000	4	█	Y9003AS	94251	78	
Freemont 2.0 JTD	JC	2.0	125	08.11 -	940A4000 / 939B5000	4	█	Y9003AS	94251	78	

**GRANDE PUNTO**

Grande Punto 1.2	199	1.2	48	09.05 -	199A4000	4	1,0	ZKR7A-10	1691		LPG 8
Grande Punto 1.3 D Mjet	199	1.3	55	09.05 -	199A2000	4	█	Y8003J	97256	62	
Grande Punto 1.3 D Mjet	199	1.3	66	12.05 -	199A3000	4	█	Y8003J	97256	62	
Grande Punto 1.3 D Mjet	199	1.3	62	04.10 -	223A9000	4	█	Y8003J	97256	62	
Grande Punto 1.3 D Mjet	199	1.3	62	04.10 -	199B4000	4	█	Y9001AS	97719	72	
Grande Punto 1.4	199	1.4	55	06.06 -	199A7000	4	1,0	ZKR7A-10	1691		LPG 8
Grande Punto 1.4	199	1.4	57	09.05 -	350A1000	4	1,0	ZKR7A-10	1691		LPG 8
Grande Punto 1.4 NATURAL POWER	199	1.4	57	09.08 -	350A1000	4	1,0	ZKR7A-10	1691		LPG 8
Grande Punto 1.4 LPG	199	1.4	57	02.09 -		4	1,0	ZKR7A-10	1691		LPG 8
Grande Punto 1.4 16V	199	1.4	70	09.05 - 08	199A6000	4	1,0	ZKR7A-10	1691		LPG 8
Grande Punto 1.4 T-Jet	199	1.4	88	06.07 -	198A4000	4	0,8	IKR9J8	93311		
Grande Punto 1.4 Abarth	199	1.4	114	12.07 - 06.10	199A8000	4	0,8	IKR9J8	93311		
Grande Punto 1.4 Abarth	199	1.4	132	04.09 -	199A8000	4	0,8	IKR9J8	93311		
Grande Punto 1.9 D Mjet	199	1.9	85	06.06 -	939A7000	4	█	Y1030J	90828	70	
Grande Punto 1.9 D Mjet	199	1.9	88	10.05 -	939A1000	4	█	Y1030J	90828	70	
Grande Punto 1.9 D Mjet	199	1.9	96	10.05 -	199A5000	4	█	Y1030J	90828	70	

**IDEA**

Idea 1.2 16V	350	1.2	59	12.03 - 12.10	188A5.000	4	1,0	DCPR7E-N-10	4983		LPG 8
Idea 1.3 D Mjet	350	1.3	51	06.03 - 12.11	188A9000	4	█	Y8003J	97256	62	
Idea 1.3 D Mjet	350	1.3	66	04.05 - 12.10	199A3000	4	█	Y8003J	97256	62	
Idea 1.3 D Mjet EURO V	350	1.3	68	04.09 -	199B1000	4	█	Y9001AS	97719	72	
Idea 1.4	350	1.4	57	09.05 - 12.12	350A1000	4	1,0	ZKR7A-10	1691		LPG 8
Idea 1.4 LPG	350	1.4	57	03.09 - 12.12	350A1000	4	1,0	ZKR7A-10	1691		LPG 8
Idea 1.4	350	1.2	66	12.03 - 12.10	192B2000	4	1,0	DCPR7E-N-10	4983		LPG 8
Idea 1.4	350	1.4	70	10.03 - 02.05	843A1.000	4	0,9	DCPR7E-N	4795		LPG 8
Idea 1.4 16V	350	1.4	70	02.05 - 12.12	843A1.000	4	1,0	DCPR7E-N-10	4983		LPG 8
Idea 1.6 D Mjet	350	1.6	88	07.08 - 12.12	350A2000	4	█	Y9003AS	94251	78	
Idea 1.9 JTD	350	1.9	74	10.03 - 12.10	188B2000	4	█	Y-534J	3413	36	

**LINEA**

Linea 1.4	323	1.4	57	06.07 -	350A1000	4	1,0	ZKR7A-10	1691		LPG 8
Linea 1.4 T-Jet	323	1.4	88	09.07 -	198A4000	4	0,8	IKR9J8	93311		
Linea 1.3 D Mjet	323	1.3	66	06.07 -	199A3000	4	█	Y8003J	97256	62	
Linea 1.3 D Mjet	323	1.3	70	09.09 -	199A3000	4	█	Y9001AS	97719	72	
Linea 1.6 D Mjet	323	1.6	77	06.09 -	198A3000	4	█	Y9003AS	94251	78	

Code *l* kW

Cyl.



Stock-No.

V-*LINE*  
10-15-20-25-30-35-40-45-50-55-60-65-70-75-80-85-90-95-100-105-110-115-120-125-130-135-140-145-150-155-160-165-170-175-180-185-190-195-200-205-210-215-220-225-230-235-240-245-250-255-260-265-270-275-280-285-290-295-300-305-310-315-320-325-330-335-340-345-350-355-360-365-370-375-380-385-390-395-400-405-410-415-420-425-430-435-440-445-450-455-460-465-470-475-480-485-490-495-500-505-510-515-520-525-530-535-540-545-550-555-560-565-570-575-580-585-590-595-600-605-610-615-620-625-630-635-640-645-650-655-660-665-670-675-680-685-690-695-700-705-710-715-720-725-730-735-740-745-750-755-760-765-770-775-780-785-790-795-800-805-810-815-820-825-830-835-840-845-850-855-860-865-870-875-880-885-890-895-900-905-910-915-920-925-930-935-940-945-950-955-960-965-970-975-980-985-990-995-1000

LPG/CNG

**FIAT  
MAREA**

Marea i.;80 16V ,Weekend	185	1.2	59	03.98 - 05.99	182B2000	4		DCPR8EKC	7168		LPG 8
Marea 80 16V Sx,Hsx; Weekend	185	1.2	60	12.98 - 12.00	182B2000	4	0,9	DCPR8E-N	5692		LPG 8
Marea i. 12 V; Weekend	185	1.4	55	10.96 - 02.98	182A3000	4		BKR6EKC	2848	26	LPG 1
Marea i. 16V; Weekend	185	1.6	76	09.96 - 04.98	182A4000	4		BKR6EKC	2848	26	LPG 1
Marea i. 16V Sx Bipower	185	1.6	76	11.97 - 12.03	182A4000	4		BKR6EKC	2848	26	LPG 1
Marea 100 16V,Sx,Elx,Aut., Weekend	185	1.6	76	12.98 - 12.03	182A4000	4	0,9	BKR5EZ	7642	36	LPG 1
Marea 16V Sx,Elx,Aut., Weekend	185	1.6	76	05.98 - 11.98	182A4000	4	0,9	BKR5EZ	7642	36	LPG 1
Marea i. 16 V, Weekend	185	1.8	83	09.96 - 11.98	182A2000	4		BKR6EKC	2848	26	LPG 1
Marea 115 16V; Weekend	185	1.8	83	12.99 - 01.01	182A2000	4		BKR6EKC	2848	26	LPG 1
Marea	185	1.9	55	09.96 - 12.00	182A8000	4	☑	Y-928U	4389	29	
Marea	185	1.9	74	09.96 - 12.00	182A7000	4	☑	Y-928U	4389	29	
Marea JTD	185	1.9	74	01.01 - 12.01	182B9000	4	☑	Y-534J	3413	36	
Marea / Marengo JTD	185	1.9	77	04.99 - 11.99	182B4000 fino a n.motore →1713819	4	☑	Y-747U	4694	26	
Marea JTD	185	1.9	77	12.99 - 01.01	182B4000 dal n. motore 1713820 →	4	☑	Y-534J	3413	36	
Marea / Marengo JTD	185	1.9	81	01.02 -	186A6000	4	☑	Y-534J	3413	36	
Marea 20V	185	2.0	108	09.96 - 11.98	182A1000	5		BKR6EKC	2848	26	LPG 1
Marea i. 155 20 V Weekend	185	2.0	108	10.96 - 12.03	182A1000	5		BKR6EKC	2848	26	LPG 1
Marea	185	2.4	91	09.96 - 12.00	185A2000	5	☑	Y-928U	4389	29	
Marea JTD	185	2.4	100	12.99 - 09.02	185A6000 dal n. motore 1713820 →	5	☑	Y-534J	3413	36	
Marea JTD	185	2.4	100	03.99 - 11.99	185A6000 fino a n. motore →1713819	5	☑	Y-747U	4694	26	

**MULTIPLA**

Multipla 100 16V Bluepower	186	1.6	70	01.99 - 12.04	186.A3.000	4		BKR6EKC	2848	26	LPG 1
Multipla 100 16V Bipower	186	1.6	76	01.99 - 12.04	186 A4.000	4		BKR6EKC	2848	26	LPG 1
Multipla 100 16V Sx	186	1.6	76	01.99 - 06.99	186 A4.000	4		BKR6EKC	2848	26	LPG 1
Multipla 100 16V Sx	186	1.6	76	07.99 - 12.04	186 A4.000	4	0,9	BKR5EZ	7642	36	LPG 1
Multipla 1.6 16V	186	1.6	76	09.04 -	182B6.000	4	0,9	BKR5EZ	7642	36	LPG 1
Multipla 1.6 16V NATURAL POWER	186	1.6	76	09.04 -	182B4.000	4		BKR6EKC	2848	26	LPG 1
Multipla 1.9 JTD	186	1.9	77	11.98 - 11.99	182B4000 fino a n. motore →1692991	4	☑	Y-747U	4694	26	
Multipla 1.9 JTD	186	1.9	77	12.99 - 02.01	82B4000 dal n. motore →1692992	4	☑	Y-534J	3413	36	
Multipla 1.9 JTD	186	1.9	81	02.01 - 07.02	186A6000	4	☑	Y-534J	3413	36	
Multipla 1.9 D Mjet EURO III	186	1.9	85	07.02 - 09.05	186A8000	4	☑	Y-534J	3413	36	
Multipla 1.9 D Mjet EURO IV	186	1.9	85	10.03 - 12.10	186A8000	4	☑	Y1030J	90828	70	
Multipla 1.9 D Mjet	186	1.9	88	04.02 -	186A9000	4	☑	Y1030J	90828	70	

**PALIO**

Palio 1,9 D	178	1.9	46	01 -	223 A6000	4	☑	Y-939J	5059	43	
Palio 8V	178	1.2	44	01.01 -	188A4.000	4	0,9	BKR5EZ	7642	36	LPG 1
Palio 65 1.2L	178	1.2	50	01.00 - 12.00	178 E2.000	4		BKR6EKC	2848	26	LPG 1
Palio 75 Weekend	178	1.2	54	11.97 - 12.00	178B5.000	4		BKR6EKC	2848	26	LPG 1
Palio 16V	178	1.2	59	09.01 - 11.02	188 A5.000	4	0,9	DCPR8E-N	5692		LPG 8
Palio 16V	178	1.2	59	12.02 -	188 A5.000	4	0,9	DCPR7E-N	4795		LPG 8
Palio 1.4L	178	1.4	51	09.97 -	178 B2.000	4	0,9	BKR5EZ	7642	36	LPG 1
Palio 1.5	178	1.5	62	02.02 - 01.12	178 E5022	4	0,8	BKR6ES	3783	28	LPG 1
Palio 1.6L 16V	178	1.6	74	96 - 06.99	182B6.000	4		BKR6EKC	2848	26	LPG 1

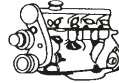

Code *l* kW

Cyl.



Stock-No.



LPG/CNG

**FIAT****PALIO**

Palio 100 16V Weekend	178	1.6	76	11.97 - 06.99	178B3.000	4		BKR6EKC	2848	26	LPG 1
Palio 100 16V Weekend	178	1.6	76	07.99 -	178B3.000	4	0,9	BKR5EZ	7642	36	LPG 1
Palio TD	178	1.7	51	97 -		4		Y-924J	7906	1	

**PANDA 1**

Panda 1 750 CLX -CL-L- Fire	141	0.75	24	01.86 - 12.96	156A...	4	0,8	BCPR6ES	2330	12	LPG 3
Panda 1 750 Young	141	0.75	25	01.86 - 12.96	141B000	4	0,8	BPR6ES	7822	2	LPG 2
Panda 1 900	141	0.9	29	- 12.96	1170A1046	4	0,8	BPR6ES	7822	2	LPG 2
Panda 1 i.	141	0.9	29	01.96 - 01.01		4	0,8	BPR6ES	7822	2	LPG 2
Panda 1 900- Jolly-Van	141	0.9	29	01.97 - 01.01	1170 A1046	4	0,9	BKR5EZ	7642	36	LPG 1
Panda 1 45 / 45 S / 4x4	141	0.9	33	- 12.96	146A..	4	0,8	BPR6ES	7822	2	LPG 2
Panda 1	141	1.1	40	09.00 -	187A1000	4	0,9	BKR5EZ	7642	36	LPG 1
Panda 1 1000	141	1.0	32	01.86 - 04.96	156A2048-	4	0,8	BCPR6ES	2330	12	LPG 3
					156A2146/246						
Panda 1 1.0 L- young-L- CLX	141	1.0	33	06.94 - 12.97	141C2000	4	0,8	BPR6ES	7822	2	LPG 2
Panda 1 Van	141	1.0	33	01.97 -	141C2000	4		BKR6EKC	2848	26	LPG 1
Panda 1 1100 Selecta	141	1.1	37	07.90 - 12.96	156C046 Cat.	4	0,8	BCPR6ES	2330	12	LPG 3
Panda 1 1100	141	1.1	40	02.95 - 12.96	176B2000	4	0,8	BCPR6ES	2330	12	LPG 3
Panda 1 4x4	141	1.1	40	02.95 - 12.96	176B2000	4	0,8	BCPR6ES	2330	12	LPG 3
Panda 1 4X4	141	1.1	40	01.96 - 08.00	156C046	4	0,8	BCPR6ES	2330	12	LPG 3
Panda 1 1100 Selecta Van	141	1.1	40	01.97 - 08.00	176B2000	4		BKR6EKC	2848	26	LPG 1

**PANDA 2**

Panda 2 1.1	169	1.1	40	09.03 - 12.04	187A1000	4	0,9	BKR5EZ	7642	36	LPG 1
Panda 2 1.1 Eco	169	1.1	40	12.04 - 12.12	187A1000	4	1,0	DCPR7E-N-10	4983		LPG 8
Panda 2 1.2 / 4x4	169	1.2	44	10.04 - 12.12	188A4000	4	1,0	DCPR7E-N-10	4983		LPG 8
Panda 2 1.2 Natural Power	169	1.2	44	06.06 - 12.09	188A4000	4	1,0	DCPR7E-N-10	4983		LPG 8
Panda 2 1.2 LPG	169	1.2	44	02.09 -		4	1,0	DCPR7E-N-10	4983		LPG 8
Panda 2 1.2	169	1.2	51	03.10 - 12.12	169A4000	4	1,0	ZKR7A-10	1691		LPG 8
Panda 2 1.2 Easypower LPG Euro V	169	1.2	51	11.10 -	169A4000	4	0,8	ZKR7AI-8	92402		ZKR7AI-8
Panda 2 1.3 D Mjet	169	1.3	51	09.03 - 12.12	188A8000	4		Y8003J	97256	62	
Panda 2 1.3 D Mjet	169	1.3	55	07.06 - 12.12	169A1000	4		Y8003J	97256	62	
Panda 2 1.3 D Mjet 4x4	169	1.3	55	03.10 - 12.12	169A1000	4		Y9001AS	97719	72	
Panda 2 1.4 Natural Power	169	1.4	57	01.10 - 12.12	350A1000	4	1,0	ZKR7A-10	1691		LPG 8
Panda 2 1.4 16V 100 HP	169	1.4	74	06.07 - 12.11	169A3000	4	1,0	DCPR7E-N-10	4983		LPG 8

**PANDA 3**

Panda 3 0.9	312	0.9	63	01.12 -	312A2000	2	0,8	ILKR9G8	97168		
Panda 3 0.9 Natural Power	312	0.9	63	07.12 -	312A2000 CNG	2	0,8	ILKR9G8	97168		
Panda 3 1.0	312	1.0	48	01.12 -	312A4000	2	1,2	LKR7DI-12	90779		
Panda 3 1.2	312	1.2	51	01.12 -	169A4000	4	1,0	ZKR7A-10	1691		LPG 8
Panda 3 1.3 D Mjet	312	1.3	55	01.12 -	169A1000 / 169A9000	4		Y9001AS	97719	72	

**PUNTO 1 (176)**

Punto 1 55	176	1.1	40	11.93 - 05.97	176A6000	4	0,8	BCPR6ES	2330	12	LPG 3
Punto 1 55 S; Sx; 6 Speed	176	1.1	40	06.97 - 09.99	176B2000	4	0,8	BCPR6ES	2330	12	LPG 3
Punto 1 60	176	1.2	43	06.94 - 05.98	176A7000	4	0,8	BCPR6ES	2330	12	LPG 3
Punto 1 60	176	1.2	44	11.93 - 05.97	176B1000	4	0,8	BCPR6ES	2330	12	LPG 3
Punto 1 60	176	1.2	44	06.97 - 09.99	176B4000	4	0,8	BCPR6ES	2330	12	LPG 3
Punto 1 75	176	1.2	54	11.93 - 05.98	176A8000	4	0,8	BCPR6ES	2330	12	LPG 3
Punto 1 85 16V	176	1.2	63	05.97 - 09.01	176B9000	4	0,9	DCPR8E	4339		LPG 8
Punto 1 GT Turbo	176	1.4	96	06.93 - 09.99	176 B000/ 176A4000	4		BCPR6ET	2197		LPG 3
Punto 1 90	176	1.6	65	01.94 - 05.97	176A9000	4	0,9	BCPR7ES	3330		BCPR7EIX

Code *l* kW

Cyl.



Stock-No.



LPG/CNG

**FIAT****PUNTO 1 (176)**

Punto 1 90 Cabrio ELX	176	1.6	65	06.94 - 05.98	176A9000	4	0,9	BCPR7ES	3330		BCPR7EIX
Punto 1 Sporting	176	1.6	65	07.95 - 05.97	176A9000	4	0,9	BCPR7ES	3330		BCPR7EIX
Punto 1 1.7 D	176	1.7	42	11.94 - 09.97	176B3000	4	█	Y-924J	7906	1	
Punto 1 1.7 TD	176	1.7	51	06.93 - 09.96	176A3000	4	█	Y-924J	7906	1	
Punto 1 1.7 TD	176	1.7	52	10.96 - 12.99	176A5000	4	█	Y-924J	7906	1	

**PUNTO 2 (188)**

Punto 2 1.2L 8V	188	1.2	44	09.00 - 10.04	188A4000	4	0,9	BKR5EZ	7642	36	LPG 1
Punto 2 1.2 Classic	188	1.2	44	10.04 -	188A4000	4	1,0	DCPR7E-N-10	4983		LPG 8
Punto 2 1.2 Natural Power	188	1.2	44	01.04 - 10.04	188A4000	4	0,9	BKR5EZ	7642	36	LPG 1
Punto 2 1.2 Natural Power Classic	188	1.2	44	02.05 -	188A4000	4	1,0	DCPR7E-N-10	4983		LPG 8
Punto 2 1.2 16V	188	1.2	59	09.00 - 11.02	188A5000	4	0,9	DCPR8E-N	5692		LPG 8
Punto 2 1.2 16V	188	1.2	59	12.02 - 02.05	188A5000	4	0,9	DCPR7E-N	4795		LPG 8
Punto 2 1.2 16V	188	1.2	59	02.05 -	188A5000	4	1,0	DCPR7E-N-10	4983		LPG 8
Punto 2 1.3 D Mjet	188	1.3	51	12.03 -	188A9000	4	█	Y8003J	97256	62	
Punto 2 1.4L 16V	188	1.4	70	06.03 -	843A1000	4	0,9	DCPR7E-N	4795		LPG 8
Punto 2 1,8 HGT	188	1.8	96	09.00 - 08.02	188A000	4		BKR6EKC	2848	26	LPG 1
Punto 2 1,8 HGT	188	1.8	96	09.02 -	188A000	4	0,9	BKR6EZ	4619	38	LPG 1
Punto 2 1.9 DS	188	1.9	44	09.99 - 03	188A3000	4	█	Y-939J	5059	43	
Punto 2 1.9 JTD	188	1.9	59	10.99 - 12.00	188A2000	4	█	Y-534J	3413	36	
Punto 2 1.9 JTD	188	1.9	63	01.01 - 06.03	188A7000	4	█	Y-534J	3413	36	
Punto 2 1.9 JTD	188	1.9	63	07.03 -	188A7000	4	█	Y1030J	90828	70	
Punto 2 1.9 D Mjet	188	1.9	74	07.03 - 06.05	188B2000	4	█	Y1030J	90828	70	

**PUNTO 3 (199)**

Punto 3 0.9	199	0.9	63	03.12 -	312A2000	2	0,8	ILKR9G8	97168		
Punto 3 0.9	199	0.9	77	07.13 -	199B6000	2	0,8	ILKR9G8	97168		
Punto 3 1.2	199	1.2	51	03.12 -	169A4000	4	1,0	ZKR7A-10	1691		LPG 8
Punto 3 1.3 D Mjet EURO IV	199	1.3	55	03.12 -	199A2000 / 199A9000	4	█	Y8003J	97256	62	
Punto 3 1.3 D Mjet EURO V	199	1.3	55	03.12 -	199A2000 / 199A9000	4	█	Y9001AS	97719	72	
Punto 3 1.3 D Mjet EURO IV	199	1.3	62	03.12 -	199B4000	4	█	Y8003J	97256	62	
Punto 3 1.3 D Mjet EURO V	199	1.3	62	03.12 -	199B4000	4	█	Y9001AS	97719	72	
Punto 3 1.3 D Mjet EURO IV	199	1.3	70	03.12 -	199B1000	4	█	Y8003J	97256	62	
Punto 3 1.3 D Mjet EURO V	199	1.3	70	03.12 -	199B1000	4	█	Y9001AS	97719	72	
Punto 3 1.4 Euro IV	199	1.4	55	03.12 -	199A7000	4	1,0	ZKR7A-10	1691		LPG 8
Punto 3 1.4 Euro V	199	1.4	55	03.12 -	199A7000	4	0,8	ZKR7AI-8	92402		
Punto 3 1.4 Euro IV	199	1.4	57	03.12 -	350A1000	4	1,0	ZKR7A-10	1691		LPG 8
Punto 3 1.4 Euro V	199	1.4	57	03.12 -	350A1000	4	0,8	ZKR7AI-8	92402		
Punto 3 1.4 Natural Power CNG	199	1.4	57	03.12 -	350A1000	4	1,0	ZKR7A-10	1691		LPG 8
Punto 3 1.4 MultiAir	199	1.4	77	03.12 -	955A6000	4	1,0	DCPR7E-N-10	4983		LPG 8
Punto 3 1.4 Turbo MultiAir	199	1.4	99	03.12 -	955A2000	4	0,8	IKR9J8	93311		

**PUNTO EVO**

Punto EVO 1.2	199	1.2	48	09.09 - 02.12	199A4000	4	1,0	ZKR7A-10	1691		LPG 8
Punto EVO 1.2	199	1.2	51	10.09 - 02.12	169A4000	4	1,0	ZKR7A-10	1691		LPG 8
Punto EVO 1.3 D Mjet	199	1.3	51	10.09 - 02.12	199B2000	4	█	Y9001AS	97719	72	
Punto EVO 1.3 D Mjet EURO IV	199	1.3	55	06.09 - 02.12	199A2000	4	█	Y8003J	97256	62	
Punto EVO 1.3 D Mjet EURO V	199	1.3	55	06.09 - 02.12	199A2000 / 199A9000	4	█	Y9001AS	97719	72	
Punto EVO 1.3 D Mjet	199	1.3	62	10.09 - 02.12	199B4000 / 223A9000	4	█	Y9001AS	97719	72	
Punto EVO 1.3 D Mjet	199	1.3	66	06.09 - 02.12	199A3000	4	█	Y8003J	97256	62	
Punto EVO 1.3 Mjet Stop&Start	199	1.3	70	06.09 - 02.12	199B1000	4	█	Y9001AS	97719	72	
Punto EVO 1.4	199	1.4	55	07.09 - 02.12	199A7000	4	1,0	ZKR7A-10	1691		LPG 8

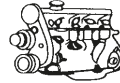
Code *l* kW

Cyl.

Stock-No.  
**VEFINE**  
E-FORWERS\*

LPG/CNG

**FIAT****PUNTO EVO**

Punto EVO 1.4	199	1.4	57	09.09 - 02.12	350A1000	4	1,0	ZKR7A-10	1691		LPG 8
Punto EVO 1.4 Natural Power CNG	199	1.4	57	09.09 - 02.12	350A1000	4	1,0	ZKR7A-10	1691		LPG 8
Punto EVO 1.4 Multiair	199	1.4	77	09.09 - 02.12	955A6000	4	1,0	DCPR7E-N-10	4983		LPG 8
Punto EVO 1.4 Turbo Multiair	199	1.4	99	09.09 - 02.12	955A2000	4	0,8	IKR9J8	93311		
Punto EVO 1.4 Abarth	199	1.4	120	10.09 - 02.12	955A8000	4	0,8	IKR9J8	93311		
Punto EVO 1.4 Abarth Esseesse	199	1.4	132	07.08 - 02.12	199A8000 / 955A8000	4	0,8	IKR9J8	93311		
Punto EVO 1.6 D Mjet	199	1.6	88	09.09 - 02.12	955A3000	4	█	Y9003AS	94251	78	

**QUBO**

Qubo 1.3 D Mjet EURO IV	225	1.3	55	09.08 -	199A2000	4	█	Y8003J	97256	62	
Qubo 1.3 D Mjet EURO V	225	1.3	55	09.08 -	199A2000	4	█	Y9001AS	97719	72	
Qubo 1.3 D Mjet	225	1.3	70	11.09 -	199B1000	4	█	Y9001AS	97719	72	
Qubo 1.4	225	1.4	54	09.08 -	KFT / KfV	4	0,9	BKR6EZ	4619	38	LPG 1
Qubo 1.4 Natural Power	225	1.4	57	10.09 -	350A1000	4	1,0	ZKR7A-10	1691		LPG 8

**SCUDO**

Scudo		1.6	58	02.96 -	220A2.000	4	0,8	BCPR7ES	3330		BCPR7EIX
Scudo D		1.9	51	03.96 -		4	█	Y-924J	7906	1	
Scudo TD		1.9	68	03.96 -		4	█	Y-924J	7906	1	
Scudo		1.9		09.98 -	DW8, DW8TD, WJZ	4	█	Y-503J	1009	10	
Scudo		1.9		09.98 -	XUD9TF	4	█	Y-924J	7906	1	
Scudo		2.0	100	11.06 -	RHR	4	█	Y1005J	7957	56	
Scudo		2.0	88	11.06 -	RHG	4	█	Y1005J	7957	56	
Scudo		2.0	88	11.06 -	RHK	4	█	Y1005J	7957	56	

**SEDICI**

Sedici 1.6 16V	189	1.6	79	09.05 -	M16A	4	1,1	IFR6J11	7658		
Sedici 1.6 16V	189	1.6	88	09.09 -	M16A	4	1,1	IFR6J11	7658		
Sedici 1.9D Mjet	189	1.9	88	01.06 -	D19AA	4	█	Y-534J	3413	36	
Sedici 2.0D Mjet	189	2.0	99	09.09 -	D20AA	4	█	Y9003AS	94251	78	

**SEICENTO**

Seicento 900 i.e. S; SX; Citymatic	187	0.9	29	05.98 - 12.00	1170A1.046	4	0,8	BPR6ES	7822	2	LPG 2
Seicento Sporting	187	1.1	40	03.98 - 09.00	176B2.000	4	0,8	BCPR6ES	2330	12	LPG 3
Seicento 1100	187	1.1	40	05.98 - 09.00	176B2.000	4	0,8	BCPR6ES	2330	12	LPG 3
Seicento 1100	187	1.1	40	10.00 - 10.04	187A1000	4	0,9	BKR5EZ	7642	36	LPG 1
Seicento 1.1	187	1.1	40	10.04 -	187A1.000	4	1,0	DCPR7E-N-10	4983		LPG 8

**STILO**

Stilo 1.2 16V	192	1.2	59	09.01 - 11.02	188.A5000	4	0,9	DCPR8E-N	5692		LPG 8
Stilo 1.2 16V	192	1.2	59	12.02 - 06.04	188.A5000	4	0,9	DCPR7E-N	4795		LPG 8
Stilo 1.4 16V / SW	192	1.4	70	01.04 - 02.05	843A1.000	4	0,9	DCPR7E-N	4795		LPG 8
Stilo 1.4 16 V /SW	192	1.4	70	02.05 -	843A1.000	4	1,0	DCPR7E-N-10	4983		LPG 8
Stilo 1.6	192	1.6	76	09.01 - 05.06	182.B6000	4	0,9	BKR5EZ	7642	36	LPG 1
Stilo 1.6 SW	192	1.6	76	09.02 -	182.B6000	4	0,9	BKR5EZ	7642	36	LPG 1
Stilo 1.8 16V	192	1.8	96	09.01 -	192.A4000	4	0,9	BKR6EZ	4619	38	LPG 1
Stilo 1.8 SW	192	1.8	98	09.02 -	192.A4000	4	0,9	BKR6EZ	4619	38	LPG 1
Stilo 1.9 JTD	192	1.9	59	09.01 - 08.04	192A3000	4	█	Y-534J	3413	36	
Stilo 1.9 JTD	192	1.9	66	09.04 - 12.10	192B5000	4	█	Y1030J	90828	70	
Stilo 1.9 JTD	192	1.9	74	09.04 - 07.05	192A9000	4	█	Y-534J	3413	36	
Stilo 1.9 JTD	192	1.9	85	10.01 - 12.07	192A1000	4	█	Y-534J	3413	36	
Stilo 1.9 JTD	192	1.9	85	07.05 - 12.07	937A7000	4	█	Y1030J	90828	70	
Stilo 1.9 D Mjet	192	1.9	88	09.05 -	192A8000	4	█	Y1030J	90828	70	
Stilo 1.9 D Mjet 16V	192	1.9	103	01.04 - 09.05	192A5000	4	█	YE07	6092		

Code *l* kW

Cyl.



Stock-No.



LPG/CNG

**FIAT  
STRADA**

Stilo 1.9 D Mjet 16V	192	1.9	110	09.05 - 10.07	937A5000	4		YE07	6092		
Stilo 2.4 20V	192	2.4	125	09.01 -	192A2000	5	0,9	BKR6EZ	4619	38	LPG 1
Strada		1.2	48	10.04 -	178B7.045	4	1,0	DCPR7E-N-10	4983		LPG 8
Strada 75		1.2	54	05.99 - 05	178B5.000	4	0,9	BKR5EZ	7642	36	LPG 1
Strada		1.2		01.99 - 10.05	188A4.000	4	0,9	BKR5EZ	7642	36	LPG 1
Strada 1.3 D Mjet		1.3	63	05.06 -	223A9000	4		Y8003J	97256	62	
Strada		1.6		10.99 - 10.04	178D2011	4	0,9	BKR5EZ	7642	36	LPG 1
Strada 1.7 D		1.7	51	06.99 -	176A3000	4		Y-924J	7906	1	
Strada 1.9 D		1.9	46	12.00 - 03.03	223A6000	4		Y-939J	5059	43	
Strada 1.9 JTD		1.9	59	04.03 - 06.05	188A2000	4		Y-534J	3413	36	

**TEMPRA**

Tempra 1.4- S.W- .S	159	1.4	51	10.94 - 10.96	836A4.000	4	0,8	BPR6ES	7822	2	LPG 2
Tempra / SX / Sta. Wagon	159	1.4	56	03.90 - 10.96	159A2.000	4	0,8	BPR6ES	7822	2	LPG 2
Tempra 1.6	159	1.6	55	02.90 - 12.94	159 A3.048	4	0,8	BPR7ES	2023	19	BPR8EIX
Tempra 1.6	159	1.6	55	09.94 - 10.96	835C1.000	4	0,9	BCPR7ES	3330		BCPR7EIX
Tempra 1.6 90CV-Liberty S.W.	159	1.6	66	03.95 -		4	0,9	BCPR7ES	3330		BCPR7EIX
Tempra ie SX, S.W.	159	1.8	74	05.95 -		4	0,8	BPR7ES	2023	19	BPR8EIX
Tempra 1800 i.e/a.Modelle	159	1.8	77	02.90 - 10.96	159A4.046	4	0,8	BPR7ES	2023	19	BPR8EIX
Tempra D - SW	159	1.9	48	02.90 - 06.96	160 A7.000	4		Y-924J	7906	1	
Tempra TD	159	1.9	59	07.90 -	160 B6.046	4		Y-924J	7906	1	
Tempra TD /SW	159	1.9	66	02.90 -	160 A6.000	4		Y-924J	7906	1	
Tempra TD	159	1.9	68	06.93 - 09.96	160 D1.000	4		Y-924J	7906	1	
Tempra 2.0L	159	2.0	83	02.90 - 10.96	159A6.046	4	0,8	BPR7ES	2023	19	BPR8EIX

**TIPO**

Tipo 1.1L	160	1.1	41	07.87 - 03.93	160A3.000	4	0,8	BCPR6ES	2330	12	LPG 3
Tipo Selecta	160	1.4	53	02.88 -	160A1.000	4	0,8	BPR6ES	7822	2	LPG 2
Tipo	160	1.4	57	01.90 - 05.95	159A2.000	4	0,8	BPR6ES	7822	2	LPG 2
Tipo 1.6L	160	1.6	55	03.93 - 10.94	835C1.000	4	0,9	BCPR7ES	3330		BCPR7EIX
Tipo i.e.	160	1.6	55	03.93 - 10.95	835C1.000	4	0,8	BPR7ES	2023	19	BPR8EIX
Tipo i.e.	160	1.6	55	03.94 -		4	0,9	BCPR7ES	3330		BCPR7EIX
Tipo Selecta	160	1.6	57	01.92 - 03.93	159A3.046	4	0,8	BPR7ES	2023	19	BPR8EIX
Tipo	160	1.6	63	04.90 - 12.92	159A3.000 DOHC	4	0,8	BPR7ES	2023	19	BPR8EIX
Tipo i.e.	160	1.6	66	03.93 - 10.95	159 A3.048	4	0,8	BPR7ES	2023	19	BPR8EIX
Tipo D	160	1.7	42	07.87 - 03.93	149 B 4.000	4		Y-924J	7906	1	
Tipo IE SX / GT / SLX	160	1.8	76	11.91 - 10.95	835C2.000	4	0,8	BPR7ES	2023	19	BPR8EIX
Tipo i.e. GT	160	1.8	80	03.92 - 03.93	139A4.000	4	0,8	BPR7ES	2023	19	BPR8EIX
Tipo D	160	1.9	48	07.89 - 03.93	149 A1.000	4		Y-924J	7906	1	
Tipo TD	160	1.9	66	07.87 -	160 D1.000	4		Y-924J	7906	1	
Tipo TD	160	1.9	68	07.87 - 03.93	149 A 1.000	4		Y-924J	7906	1	
Tipo TD	160	1.9	68	06.93 - 12.94		4		Y-924J	7906	1	
Tipo 2.0 L	160	2.0	83	03.90 - 03.92	159A6.046	4	0,8	BPR7ES	2023	19	BPR8EIX
Tipo 2.0 L- GT / SLX	160	2.0	83	11.91 - 10.95	159A6.046 Cat.	4	0,8	BPR7ES	2023	19	BPR8EIX
Tipo IE 16V	160	2.0	102	05.91 - 10.95	836A3.000 Cat.	4	0,8	BPR7ES	2023	19	BPR8EIX
Tipo i.e. 16V	160	2.0	109	05.91 - 10.95	160A8.046	4	0,8	BPR7ES	2023	19	BPR8EIX

**ULYSSE**

Ulysse TD		1.9	68	09.94 -	XUD 9 TU	4		Y-924J	7906	1	
Ulysse 2.0 JTD		2.0	80	09.02 - 05.03	RHW (DW10ATED4)	4		Y-504J	1441	24	
					fino a ric. n. —> 9666						



Code *l* kW

Cyl.

Stock-No.  
**V-TUNE**  
**16-POWER**

LPG/CNG

**FIAT****ULYSSE**

Ulysse JTD		2.0	80	09.02 -	DW10ATED4/RHT	4	█	Y-504J	1441	24	
Ulysse i.S		2.0	89	07.94 -	RFU	4		BKR5EK	7956	23	LPG 1
Ulysse 2.0		2.0	100	09.00 - 08.02	EW10J4 RFN	4	0,9	LFR5B	7113		LPG 7
Ulysse i.turbo		2.0	108	07.94 - 12.98	RGX	4		BKR6EK	2288	20	
Ulysse		2.0	100	05.06 -	RHR	4	█	Y1005J	7957	56	
Ulysse		2.0	80	06.03 -	RHM	4	█	Y1005J	7957	56	
Ulysse		2.0	81	06.02 - 07.06	RHW	4	█	Y1005J	7957	56	
Ulysse		2.0	88	05.06 -	RHK	4	█	Y1005J	7957	56	
Ulysse TD		2.1	80	07.96 -	XUD11ATE	4	█	Y-924J	7906	1	
Ulysse JTD		2.2	94	09.02 -	DW12ATED4/4HW	4	█	Y-504J	1441	24	
Ulysse 2.2 JTD		2.2	120	03.08 - 03.10	4HP / 4HR	4	█	YE08	4966		
Ulysse 2.2 D Mjet		2.2	125	02.08 - 03.10	4HT / DW12BTED4	4	█	YE08	4966		
Ulysse		2.2	96	06.02 - 07.07	4H01	4	█	Y1005J	7957	56	
Ulysse		2.2	96	06.02 - 07.07	4HW	4	█	Y1005J	7957	56	

**UNO**

Uno 45 ES/S/Sting/Trend		0.9	33	01.83 - 10.95	146A...	4	0,8	BPR6ES	7822	2	LPG 2
Uno 45		1.0	32	06.85 - 10.95	156A2...	4	0,8	BCPR6ES	2330	12	LPG 3
Uno 1.0L- Start		1.0	33	08.94 - 10.95	156A2.000-2.048	4	0,9	BPR5ES	7422	6	LPG 2
Uno 1.0 L		1.0	35	08.94 -		4	0,8	BPR6ES	7822	2	LPG 2
Uno 60 IE / S		1.1	37	07.91 - 10.95	156C.046 Cat.	4	0,8	BCPR6ES	2330	12	LPG 3
Uno 60 S / SX / Fire		1.1	41	05.85 - 10.95	146A6.000	4	0,8	BCPR6ES	2330	12	LPG 3
Uno 60 SL / Trend		1.1	41	09.89 - 09.92	146A6.000	4	0,8	BPR6ES	7822	2	LPG 2
Uno 70 all models		1.4	51	83 - 10.95	160A1.046	4	0,8	BPR6ES	7822	2	LPG 2
Uno 60 TD		1.4	51	03.86 - 09.92	146 B	4	█	Y-924J	7906	1	
Uno i.e.		1.4	51	08.94 -		4	0,8	BPR6ES	7822	2	LPG 2
Uno TD		1.4	52	09.89 - 12.95	146 B3.000	4	█	Y-924J	7906	1	
Uno Turbo IE/ Racing		1.4	82	09.89 - 12.93	146A8.046 Cat.	4		BCPR7ET	2164		BCPR7EIX
Uno 75 I.E. SPi		1.5	55	12.87 - 10.95	149C1.000	4	0,8	BPR6ES	7822	2	LPG 2
Uno 60 D		1.7	40	09.89 - 09.92	146 B2000	4	█	Y-924J	7906	1	
Uno D Van		1.7	42	09.89 - 03.96	146 B2000	4	█	Y-924J	7906	1	
Uno D		1.7		10.89 -		4	█	Y-924J	7906	1	
Uno D		1.7		01.91 -		4	█	Y-924J	7906	1	

**FORD****B-MAX**

B-Max 1.4	JK	1.4	66	10.12 -	SPJD	4	1,3	TR5B-13	4559		LPG 4
B-Max 1.5 TDCi	JK	1.5	55	10.12 -	UGJC	4	█	Y8001AS	8904	58	
B-Max 1.6 TDCi	JK	1.6	70	10.12 -	T3JB	4	█	Y8001AS	8904	58	
B-Max 1.6 Ti	JK	1.6	77	10.12 -	IQJA	4	1,3	TR5B-13	4559		LPG 4

**COUGAR**

Cougar 2.0		2.0	96	08.98 - 01.01	EDBA ZETEC-E SEFI	4	1,3	PTR5A-13	2467	25	LPG 4
Cougar 2.0		2.0	96	08.98 - 01.01	EDBB ZETEC-E SEFI	4	1,3	PTR5A-13	2467	25	LPG 4
Cougar 2.0		2.0	96	08.98 - 01.01	EDBC ZETEC-E SEFI	4	1,3	PTR5A-13	2467	25	LPG 4
Cougar 2.0		2.0	96	08.98 - 01.01	EDBD ZETEC-E SEFI	4	1,3	PTR5A-13	2467	25	LPG 4
Cougar 2.5 V6		2.5	125	08.98 - 01.01	LCBA Duratec VE SEFI	6	1,0	PTR5D-10	3784	31	LPG 5
Cougar 2.5 V6		2.5	125	08.98 - 01.01	LCBB Duratec-VE SEFI	6	1,0	PTR5D-10	3784	31	LPG 5
Cougar 2.5 V6		2.5	125	08.98 - 01.01	LCBC Duratec VE SEFI	6	1,0	PTR5D-10	3784	31	LPG 5
Cougar 2.5 V6		2.5	125	08.98 - 01.01	LCBE Duratec-VE SEFI	6	1,0	PTR5D-10	3784	31	LPG 5
Cougar 2.5 V6		2.5	151	08.98 - 01.01	MABB Duratec VE SEFI	6	1,0	PTR5D-10	3784	31	LPG 5

Code *l* kW

Cyl.



Stock-No.



LPG/CNG

**FORD  
COURIER**

Courier 1.8 D		1.8	66	03.93 -		4		Y-910R	4751	3	
---------------	--	-----	----	---------	--	---	--	--------	------	---	--

**ESCORT '91**

Escort '91 1.1		1.1	40	08.90 - 09.01	GUF HCS 2V	4	1,0	PTR5D-10	3784	31	LPG 5
Escort '91 1.3		1.3	44	08.90 - 09.01	J4B Endura-E SEFI	4	1,0	PTR5D-10	3784	31	LPG 5
Escort '91 1.3		1.3	44	08.90 - 09.01	J6A HCS CFI	4	1,0	PTR5D-10	3784	31	LPG 5
Escort '91 1.3		1.3	44	08.90 - 09.01	JBE HCS 2V	4	1,0	PTR5D-10	3784	31	LPG 5
Escort '91 1.3		1.3	46	08.90 - 09.01	JBD HCS 2V	4	1,0	PTR5D-10	3784	31	LPG 5
Escort '91 1.4		1.4	52	08.90 - 09.01	F6F CVH CFI	4	1,1	BCPR6ES-11	7121	11	LPG 3
Escort '91 1.4		1.4	52	08.90 - 09.01	F6G CVH CFI	4	1,1	BCPR6ES-11	7121	11	LPG 3
Escort '91 1.4		1.4	54	08.90 - 09.01	F4B PTE SEFI	4	1,1	BCPR6ES-11	7121	11	LPG 3
Escort '91 1.4		1.4	54	08.90 - 09.01	FUH CVH 2V	4	0,8	BCPR6ES	2330	12	LPG 3
Escort '91 1.6		1.6	65	08.90 - 09.01	L1H ZETEC-E SEFI	4	1,3	PTR5A-13	2467	25	LPG 4
Escort '91 1.6		1.6	66	08.90 - 09.01	L1E ZETEC-E SEFI	4	1,3	PTR5A-13	2467	25	LPG 4
Escort '91 1.6		1.6	66	08.90 - 09.01	L1K ZETEC-E SEFI	4	1,3	PTR5A-13	2467	25	LPG 4
Escort '91 1.6		1.6	66	08.90 - 09.01	LUJ CVH 2V	4	0,8	BCPR6ES	2330	12	LPG 3
Escort '91 1.6		1.6	66	08.90 - 09.01	LUK CVH 2V	4	0,8	BCPR6ES	2330	12	LPG 3
Escort '91 1.6		1.6	77	08.90 - 09.01	LJF CVH EFI	4	1,1	BCPR6ES-11	7121	11	LPG 3
Escort '91 1.6		1.6	79	08.90 - 09.01	LJE CVH EFI	4	1,1	BCPR6ES-11	7121	11	LPG 3
Escort '91 1.8 D		1.8	44	08.90 - 09.01	RTE	4		Y-910R	4751	3	
Escort '91 1.8 D		1.8	44	08.90 - 09.01	RTF	4		Y-910R	4751	3	
Escort '91 1.8 D		1.8	44	08.90 - 09.01	RTH	4		Y-910R	4751	3	
Escort '91 1.8 D		1.8	51	08.90 - 09.01	RVA Endura-DE (TC)	4		Y-937J	5148	5	
Escort '91 1.8 TD		1.8	66	08.90 - 09.01	RFD	4		Y-910R	4751	3	
Escort '91 1.8 TD		1.8	66	08.90 - 09.01	RFK	4		Y-910R	4751	3	
Escort '91 1.8 TD		1.8	66	08.90 - 09.01	RFS Endura-DE (TC)	4		Y-937J	5148	5	
Escort '91 1.8		1.8	77	08.90 - 09.01	RDA ZETEC SEFI	4	1,3	PTR5A-13	2467	25	LPG 4
Escort '91 1.8		1.8	85	08.90 - 09.01	RKC ZETEC-E SEFI	4	1,3	PTR5A-13	2467	25	LPG 4
Escort '91 1.8		1.8	96	08.90 - 09.01	RQB ZETEC SEFI	4	1,3	PTR5A-13	2467	25	LPG 4
Escort '91 2.0 RS 2000		2.0	110	08.90 - 09.01	N7A DOHC 16V EFI	4	1,1	BCPR6ES-11	7121	11	LPG 3
Escort '91 Cosworth		2.0	162	08.90 - 09.01	N5F DOHC COSWORTH	4	0,6	PFR7B	4853		PFR8B
Escort '91 Cosworth		2.0	162	08.90 - 09.01	N5E DOHC COSWORTH	4	1,1	PFR7B-11	5667		PFR8B
Escort '91 Cosworth		2.0	184	92 -	NC8 1711 COSWORTH 16V	4	0,8	R7234-10	5558		

**EXPLORER**

Explorer 4.0		4.0	115	01.93 - 03	V6 SEFI	6	1,5	TR55	3951		LPG 5
Explorer 4.0		4.0	121	01.93 - 03	V6 EFI	6	1,5	TR55	3951		LPG 5
Explorer 4.0		4.0	152	01.93 - 03	V6 SOHC SEFI	6	1,5	TR55	3951		LPG 5
Explorer 5.0		5.0		01.97 - 01	V8	8	1,5	TR55	3951		LPG 5

**FIESTA '89**

Fiesta '89 1.0	GFJ	1.0	33	03.89 - 06.96	TLB HCS 1V	4	1,0	BPR6EFS	3623	7	LPG 5
Fiesta '89 1.1	GFJ	1.1	37	03.89 - 06.96	G6A HCS CFI	4	1,0	BPR6EFS	3623	7	LPG 5
Fiesta '89 1.1	GFJ	1.1	40	03.89 - 06.96	GUD HCS 2V	4	1,0	BPR6EFS	3623	7	LPG 5
Fiesta '89 1.1	GFJ	1.1	40	03.89 - 06.96	GUE HCS 2V	4	1,0	BPR6EFS	3623	7	LPG 5
Fiesta '89 1.3	GFJ	1.3	44	03.89 - 06.96	J6B HCS CFI	4	1,0	BPR6EFS	3623	7	LPG 5
Fiesta '89 1.3	GFJ	1.3	44	03.89 - 06.96	JBC HCS 2V	4	1,0	BPR6EFS	3623	7	LPG 5
Fiesta '89 1.4	GFJ	1.4	52	03.89 - 06.96	F6E CVH CFI	4	1,1	BCPR6ES-11	7121	11	LPG 3
Fiesta '89 1.4	GFJ	1.4	54	03.89 - 06.96	F4A PTE SEFI	4	1,1	BCPR6ES-11	7121	11	LPG 3
Fiesta '89 1.4	GFJ	1.4	54	03.89 - 06.96	FUG CVH 2V	4	1,1	BCPR6ES-11	7121	11	LPG 3
Fiesta '89 1.4	GFJ	1.4	54	03.89 - 06.96	FUJ CVH 2V	4	0,8	BCPR6ES	2330	12	LPG 3
Fiesta '89 1.4	GFJ	1.4	55	03.89 - 06.96	FUF CVH 2V	4	0,8	BCPR6ES	2330	12	LPG 3

Code *l* kW

Cyl.



Stock-No.



LPG/CNG

**FORD****FIESTA '89**

Fiesta '89 1.6	GFJ	1.6	66	03.89 - 06.96	L1G ZETEC SEFI	4	1,3	PTR5A-13	2467	25	LPG 4
Fiesta '89 1.6	GFJ	1.6	66	03.89 - 06.96	LUH CVH 2V	4	0,8	BCPR6ES	2330	12	LPG 3
Fiesta '89 1.6 XR2i	GFJ	1.6	76	03.89 - 06.96	LJD CVH EFI	4	1,1	BCPR6ES-11	7121	11	LPG 3
Fiesta '89 1.6 XR2i	GFJ	1.6	81	03.89 - 06.96	LJC CVH EFI	4	1,1	BCPR6ES-11	7121	11	LPG 3
Fiesta '89 1.6 Turbo	GFJ	1.6	96	03.89 - 06.96	LHA CVH Turbo	4	0,8	BCR8ES	5430		
Fiesta '89 1.8 D	GFJ	1.8	44	03.89 - 06.96	RTC D	4	☑	Y-910R	4751	3	
Fiesta '89 1.8 D	GFJ	1.8	44	03.89 - 06.96	RTD D	4	☑	Y-910R	4751	3	
Fiesta '89 1.8 D	GFJ	1.8	44	03.89 - 06.96	RTG D	4	☑	Y-910R	4751	3	
Fiesta '89 1.8 16V	GFJ	1.8	77	03.89 - 06.96	RDB ZETEC SEFI	4	1,3	PTR5A-13	2467	25	LPG 4
Fiesta '89 1.8 XR2i	GFJ	1.8	96	03.89 - 06.96	RQC ZETEC SEFI	4	1,3	PTR5A-13	2467	25	LPG 4

**FIESTA '96**

Fiesta '96 1.25	JA / JB	1.25	55	11.95 - 02.02	DHA ZETEC-SE SEFI	4	1,3	PTR5A-13	2467	25	LPG 4
Fiesta '96 1.25	JA / JB	1.25	55	11.95 - 02.02	DHB ZETEC-SE SEFI	4	1,3	PTR5A-13	2467	25	LPG 4
Fiesta '96 1.25	JA / JB	1.25	55	11.95 - 02.02	DHC ZETEC-SE SEFI	4	1,3	PTR5A-13	2467	25	LPG 4
Fiesta '96 1.25	JA / JB	1.25	55	11.95 - 02.02	DHD ZETEC-SE SEFI	4	1,3	PTR5A-13	2467	25	LPG 4
Fiesta '96 1.25	JA / JB	1.25	55	11.95 - 02.02	DHE ZETEC-SE SEFI	4	1,3	PTR5A-13	2467	25	LPG 4
Fiesta '96 1.25	JA / JB	1.25	55	11.95 - 02.02	DHF ZETEC-SE SEFI	4	1,3	PTR5A-13	2467	25	LPG 4
Fiesta '96 1.25	JA / JB	1.25	55	11.95 - 02.02	DHG ZETEC-SE SEFI	4	1,3	PTR5A-13	2467	25	LPG 4
Fiesta '96 1.3	JA / JB	1.3	37	11.95 - 02.02	JJA Endura-E SEFI	4	1,0	PTR5D-10	3784	31	LPG 5
Fiesta '96 1.3	JA / JB	1.3	37	11.95 - 02.02	JJC Endura-E SEFI	4	1,0	PTR5D-10	3784	31	LPG 5
Fiesta '96 1.3	JA / JB	1.3	37	11.95 - 02.02	JJE Endura-E SEFI	4	1,0	PTR5D-10	3784	31	LPG 5
Fiesta '96 1.3	JA / JB	1.3	37	11.95 - 02.02	JJJ Endura-E SEFI	4	1,0	PTR5D-10	3784	31	LPG 5
Fiesta '96 1.3	JA / JB	1.3	37	11.95 - 02.02	JJK Endura-E SEFI	4	1,0	PTR5D-10	3784	31	LPG 5
Fiesta '96 1.3	JA / JB	1.3	37	11.95 - 02.02	JJM Endura-E SEFI	4	1,0	PTR5D-10	3784	31	LPG 5
Fiesta '96 1.3	JA / JB	1.3	44	11.95 - 02.02	J4C Endura-E SEFI	4	1,0	PTR5D-10	3784	31	LPG 5
Fiesta '96 1.3	JA / JB	1.3	44	11.95 - 02.02	J4J Endura-E SEFI	4	1,0	PTR5D-10	3784	31	LPG 5
Fiesta '96 1.3	JA / JB	1.3	44	11.95 - 02.02	J4L Endura-E SEFI	4	1,0	PTR5D-10	3784	31	LPG 5
Fiesta '96 1.3	JA / JB	1.3	44	11.95 - 02.02	J4Q Endura-E SEFI	4	1,0	PTR5D-10	3784	31	LPG 5
Fiesta '96 1.3	JA / JB	1.3	44	11.95 - 02.02	J4R Endura-E SEFI	4	1,0	PTR5D-10	3784	31	LPG 5
Fiesta '96 1.3	JA / JB	1.3	44	11.95 - 02.02	J4T Endura-E SEFI	4	1,0	PTR5D-10	3784	31	LPG 5
Fiesta '96 1.4 16V	JA / JB	1.4	66	11.95 - 02.02	FHA ZETEC-SE SEFI	4	1,3	PTR5A-13	2467	25	LPG 4
Fiesta '96 1.4 16V	JA / JB	1.4	66	11.95 - 02.02	FHE ZETEC-SE SEFI	4	1,3	PTR5A-13	2467	25	LPG 4
Fiesta '96 1.6 16V Sport	JA / JB	1.6	76	11.95 - 02.02	L1T ZETEC-SE SEFI	4	1,3	PTR5A-13	2467	25	LPG 4
Fiesta '96 1.6 16V Sport	JA / JB	1.6	76	11.95 - 02.02	L1V ZETEC-SE SEFI	4	1,3	PTR5A-13	2467	25	LPG 4
Fiesta '96 1.8 D	JA / JB	1.8	44	11.95 - 02.02	RTJ	4	☑	Y-937J	5148	5	
Fiesta '96 1.8 D	JA / JB	1.8	44	11.95 - 02.02	RTK	4	☑	Y-937J	5148	5	
Fiesta '96 1.8 DI	JA / JB	1.8	55	11.95 - 02.02	RTN	4	☑	Y-524J	4520	27	
Fiesta '96 1.8 DI	JA / JB	1.8	55	11.95 - 02.02	RTP	4	☑	Y-524J	4520	27	
Fiesta '96 1.8 DI	JA / JB	1.8	55	11.95 - 02.02	RTQ	4	☑	Y-524J	4520	27	

**FIESTA '01**

Fiesta '01 1.25	JH / JD	1.25	51	11.01 -	M7JA Duratec 16V SFI	4	1,3	PTR5A-13	2467	25	LPG 4
Fiesta '01 1.25	JH / JD	1.25	51	11.01 -	M7JB Duratec 16V SFI	4	1,3	PTR5A-13	2467	25	LPG 4
Fiesta '01 1.25	JH / JD	1.25	55	11.01 -	FUJA Duratec 16V SFI	4	1,3	PTR5A-13	2467	25	LPG 4
Fiesta '01 1.25	JH / JD	1.25	55	11.01 -	FUJB Duratec 16V SFI	4	1,3	PTR5A-13	2467	25	LPG 4
Fiesta '01 1.3	JH / JD	1.3	44	11.01 -	BAJA Duratec 8V SFI	4	1,3	TR5B-13	4559		LPG 4
Fiesta '01 1.3	JH / JD	1.3	51	11.01 -	A9JA Duratec 8V SFI	4	1,3	TR5B-13	4559		LPG 4
Fiesta '01 1.3	JH / JD	1.3	51	11.01 -	A9JB Duratec 8V SFI	4	1,3	TR5B-13	4559		LPG 4
Fiesta '01 1.4 TDCi	JH / JD	1.4	50	11.01 - 12.04	F6JA DuraTorq-TDCi	4	☑	YE04	1684	40	
Fiesta '01 1.4 TDCi	JH / JD	1.4	50	11.01 - 12.04	F6JB DuraTorq-TDCi	4	☑	YE04	1684	40	

Code *l* kW

Cyl.



Stock-No.



LPG/CNG

**FORD  
FIESTA '01**

Fiesta '01 1.4 TDCi	JH / JD	1.4	50	01.05 -	F6JA DuraTorq-TDCi	4		YE05	91322	73	
Fiesta '01 1.4 TDCi	JH / JD	1.4	50	01.05 -	F6JB DuraTorq-TDCi	4		YE05	91322	73	
Fiesta '01 1.4 16V	JH / JD	1.4	59	11.01 -	FXJA Duratec 16V SFI	4	1,3	PTR5A-13	2467	25	LPG 4
Fiesta '01 1.4 16V	JH / JD	1.4	59	11.01 -	FXJB Duratec 16V SFI	4	1,3	PTR5A-13	2467	25	LPG 4
Fiesta '01 1.6 TDCi	JH / JD	1.6	66	03.05 -	HHJA DuraTorq-TDCi	4		YE04	1684	40	
Fiesta '01 1.6 TDCi	JH / JD	1.6	66	03.05 -	HHJB DuraTorq-TDCi	4		YE04	1684	40	
Fiesta '01 1.6 16V	JH / JD	1.6	74	11.01 -	FYJB Duratec 16V SFI	4	1,3	PTR5A-13	2467	25	LPG 4
Fiesta '01 1.6 16V	JH / JD	1.6	74	11.01 -	FYJA Duratec 16V SFI	4	1,3	PTR5A-13	2467	25	LPG 4
Fiesta '01 2.0 ST 150	JH / JD	2.0	110	03.05 -	N4JB Duratec-ST (M14) SFI	4	1,3	ITR6F13	4477		LPG 5

**FIESTA '08**

Fiesta '08 1.25		1.25	44	08.08 -	STJA / STJB	4	1,3	TR5B-13	4559		LPG 4
Fiesta '08 1.25		1.25	60	08.08 -	SNJA / SNJB	4	1,3	TR5B-13	4559		LPG 4
Fiesta '08 1.4 TDCi		1.4	50	08.08 -	F6JB	4		YE05	91322	73	
Fiesta '08 1.4 TDCi		1.4	51	07.10 -	F6JD / KVJA	4		YE05	91322	73	
Fiesta '08 1.4 LPG		1.4	68	01.09 -	RTJA / RTJB	4	0,8	ILTR6H8G	96870		
Fiesta '08 1.4		1.4	71	10.08 -	SPJA / SPJC	4	1,3	TR5B-13	4559		LPG 4
Fiesta '08 1.6 TDCi		1.6	55	08.08 -	HHJF / UBJA	4		YE05	91322	73	
Fiesta '08 1.6 TDCi		1.6	66	08.08 -	HHJC / HHJD	4		YE05	91322	73	
Fiesta '08 1.6 TDCi Norm EU V		1.6	70	03.10 -	TZJA / TZJB	4		Y8001AS	8904	58	
Fiesta '08 1.6 Ti		1.6	88	10.08 -	HXJA / HXJB	4	1,3	TR5B-13	4559		LPG 4
Fiesta '08 1.6 Ti		1.6	99	12.10 -	U5JA	4	1,3	TR5B-13	4559		LPG 4

**FOCUS '98**

Focus '98 1.4 16V	DAW / DBW	1.4	55	08.98 - 12.04	FXDA ZETEC-SE SFI	4	1,3	PTR5A-13	2467	25	LPG 4
Focus '98 1.4 16V	DAW / DBW	1.4	55	08.98 - 12.04	FXDB ZETEC-SE SFI	4	1,3	PTR5A-13	2467	25	LPG 4
Focus '98 1.4 16V	DAW / DBW	1.4	55	08.98 - 12.04	FXDC ZETEC-SE SEFI	4	1,3	PTR5A-13	2467	25	LPG 4
Focus '98 1.4 16V	DAW / DBW	1.4	55	08.98 - 12.04	FXDD ZETEC-SE SFI	4	1,3	PTR5A-13	2467	25	LPG 4
Focus '98 1.6 16V	DAW / DBW	1.6	72	08.98 - 12.04	CDDA Duratec SFI	4	1,3	TR5B-13	4559		LPG 4
Focus '98 1.6 16V	DAW / DBW	1.6	74	08.98 - 12.04	FYDA ZETEC-SE SFI	4	1,3	PTR5A-13	2467	25	LPG 4
Focus '98 1.6 16V	DAW / DBW	1.6	74	08.98 - 12.04	FYDB ZETEC-SE SFI	4	1,3	PTR5A-13	2467	25	LPG 4
Focus '98 1.6 16V	DAW / DBW	1.6	74	08.98 - 12.04	FYDC ZETEC-SE SFI	4	1,3	PTR5A-13	2467	25	LPG 4
Focus '98 1.6 16V	DAW / DBW	1.6	74	08.98 - 12.04	FYDD ZETEC-SE SFI	4	1,3	PTR5A-13	2467	25	LPG 4
Focus '98 1.6 16V	DAW / DBW	1.6	74	08.98 - 12.04	FYDH ZETEC-SE SFI	4	1,3	PTR5A-13	2467	25	LPG 4
Focus '98 1.8 DI	DAW / DBW	1.8	55	08.98 - 12.04	BHDA Endura-DI	4		Y-524J	4520	27	
Focus '98 1.8 DI	DAW / DBW	1.8	55	08.98 - 12.04	BHDB Endura-DI	4		Y-524J	4520	27	
Focus '98 1.8 Turbo DI	DAW / DBW	1.8	66	08.98 - 12.04	C9DA Endura-DI	4		Y-524J	4520	27	
Focus '98 1.8 Turbo DI	DAW / DBW	1.8	66	08.98 - 12.04	C9DB Endura-DI	4		Y-524J	4520	27	
Focus '98 1.8 Turbo DI	DAW / DBW	1.8	66	08.98 - 12.04	C9DC Endura-DI	4		Y-524J	4520	27	
Focus '98 1.8 16V	DAW / DBW	1.8	74	08.98 - 12.04	FFDA DuraTorq-TDCi	4		Y-524J	4520	27	
Focus '98 1.8 16V	DAW / DBW	1.8	85	08.98 - 12.04	EYDB ZETEC-E SFI	4	1,3	PTR5A-13	2467	25	LPG 4
Focus '98 1.8 16V	DAW / DBW	1.8	85	08.98 - 12.04	EYDC ZETEC-E SFI	4	1,3	PTR5A-13	2467	25	LPG 4
Focus '98 1.8 16V	DAW / DBW	1.8	85	08.98 - 12.04	EYDD ZETEC-E SFI	4	1,3	PTR5A-13	2467	25	LPG 4
Focus '98 1.8 16V	DAW / DBW	1.8	85	08.98 - 12.04	EYDE ZETEC-E SFI	4	1,3	PTR5A-13	2467	25	LPG 4
Focus '98 1.8 16V	DAW / DBW	1.8	85	08.98 - 12.04	EYDF ZETEC-E SFI	4	1,3	PTR5A-13	2467	25	LPG 4
Focus '98 1.8 16V	DAW / DBW	1.8	85	08.98 - 12.04	EYDG ZETEC-E SFI	4	1,0	TR5A-10	0005		LPG 4
Focus '98 1.8 16V	DAW / DBW	1.8	85	08.98 - 12.04	EYDI ZETEC-E SFI	4	1,0	TR5A-10	0005		LPG 4
Focus '98 1.8 16V	DAW / DBW	1.8	85	08.98 - 12.04	EYDJ ZETEC-E SFI	4	1,0	TR5A-10	0005		LPG 4
Focus '98 1.8 16V	DAW / DBW	1.8	85	08.98 - 12.04	EYDL ZETEC-E SFI	4	1,0	TR5A-10	0005		LPG 4
Focus '98 1.8 TDCi	DAW / DBW	1.8	85	08.98 - 12.04	F9DB DuraTorq-TDCi	4		Y-524J	4520	27	
Focus '98 1.8 16V RUS	DAW / DBW	1.8	85	08.98 - 12.04	EYDK ZETEC-E SFI	4	1,3	PTR5A-13	2467	25	LPG 4
Focus '98 1.8 TDCi	DAW / DBW	1.8	85	08.98 - 12.04	F9DA DuraTorq-TDCi	4		Y-524J	4520	27	
Focus '98 2.0 16V	DAW / DBW	2.0	96	08.98 - 12.04	EDDB ZETEC-E SFI	4	1,3	PTR5A-13	2467	25	LPG 4



Code *l* kW

Cyl.

Stock-No.  
**VEFINE**  
E-FORWARD\*

LPG/CNG

**FORD****FOCUS '98**

Focus '98 2.0 16V	DAW / DBW	2.0	96	08.98 - 12.04	EDDC ZETEC-E SFI	4	1,3	PTR5A-13	2467	25	LPG 4
Focus '98 2.0 16V	DAW / DBW	2.0	96	08.98 - 12.04	EDDD ZETEC-E SFI	4	1,3	PTR5A-13	2467	25	LPG 4
Focus '98 2.0 16V	DAW / DBW	2.0	96	08.98 - 12.04	EDDF ZETEC-E SFI	4	1,3	PTR5A-13	2467	25	LPG 4
Focus '98 2.0 RS Turbo	DAW / DBW	2.0	158	10.02 - 12.04	HMDA Duratec RS SFI	4	1,0	PLTR6A-10G	3587		PLTR6A-10G

**FOCUS '02**

Focus / C-Max 1.6 TDCi	DAW / DBW	1.6	66	06.03 -	HHDA DuraTorq-TDCi	4	☑	YE04	1684	40	
Focus / C-Max 1.6 TDCi	DAW / DBW	1.6	66	06.03 -	HHDB DuraTorq-TDCi	4	☑	YE04	1684	40	
Focus / C-Max 1.6	DAW / DBW	1.6	74	06.03 -	HWDA Duratec-16V SFI	4	1,3	TR5B-13	4559		LPG 4
Focus / C-Max 1.6	DAW / DBW	1.6	74	06.03 -	HWDB Duratec-16V SFI	4	1,3	TR5B-13	4559		LPG 4
Focus / C-Max 1.6	DAW / DBW	1.6	74	06.03 -	SHDA Duratec-HE SFI	4	1,3	TR5B-13	4559		LPG 4
Focus / C-Max 1.6	DAW / DBW	1.6	74	06.03 -	SHDB Duratec-HE SFI	4	1,3	TR5B-13	4559		LPG 4
Focus / C-Max 1.6 TDCi	DAW / DBW	1.6	80	06.03 -	G8DA DuraTorq-TDCi	4	☑	YE04	1684	40	
Focus / C-Max 1.6 TDCi	DAW / DBW	1.6	80	06.03 -	G8DB DuraTorq-TDCi	4	☑	YE04	1684	40	
Focus / C-Max 1.6 Ti	DAW / DBW	1.6	85	06.03 -	HXDA Duratec- 16V Ti-VCT	4	1,3	TR5B-13	4559		LPG 4
Focus / C-Max 1.6 Ti	DAW / DBW	1.6	85	06.03 -	HXDB Duratec-HE SFI	4	1,3	TR5B-13	4559		LPG 4
Focus / C-Max 1.8	DAW / DBW	1.8	88	06.03 -	CSDA Duratec-HE SFI	4	1,3	ITR6F13	4477		LPG 5
Focus / C-Max 1.8	DAW / DBW	1.8	88	06.03 -	CSDB Duratec-HE SFI	4	1,3	ITR6F13	4477		LPG 5
Focus / C-Max 1.8	DAW / DBW	1.8	92	06.03 -	QQDA Duratec-HE SFI	4	1,3	TR6AP-13	5809		LPG 5
Focus / C-Max 1.8	DAW / DBW	1.8	92	06.03 -	QQDB Duratec-HE SFI	4	1,3	TR6AP-13	5809		LPG 5
Focus / C-Max 1.8	DAW / DBW	1.8	92	06.03 -	QQDC Duratec-HE SFI	4	1,3	TR6AP-13	5809		LPG 5
Focus / C-Max 1.8 Flexifuel	DAW / DBW	1.8	92	06.03 -	Q7DA Duratec-HE SFI	4	1,3	TR6AP-13	5809		LPG 5
Focus / C-Max 2.0 TDCi	DAW / DBW	2.0	98	06.03 -	G6DC DuraTorq-TDCi	4	☑	Y1005J	7957	56	
Focus / C-Max 2.0 TDCi	DAW / DBW	2.0	98	06.03 -	G6DE DuraTorq-TDCi	4	☑	Y1005J	7957	56	
Focus / C-Max 2.0 TDCi	DAW / DBW	2.0	98	06.03 -	G6DF DuraTorq-TDCi	4	☑	Y1005J	7957	56	
Focus / C-Max 2.0 TDCi	DAW / DBW	2.0	100	06.03 -	G6DA	4	☑	Y1005J	7957	56	
Focus / C-Max 2.0 TDCi	DAW / DBW	2.0	100	06.03 -	G6DB	4	☑	Y1005J	7957	56	
Focus / C-Max 2.0 TDCi	DAW / DBW	2.0	100	06.03 -	G6DD	4	☑	Y1005J	7957	56	
Focus / C-Max 2.0	DAW / DBW	2.0	107	04.04 - 03.07	AODA Duratec-HE SFI	4	1,3	TR6AP-13	5809		LPG 5
Focus / C-Max 2.0	DAW / DBW	2.0	107	04.04 - 03.07	AODB Duratec-HE SFI	4	1,3	TR6AP-13	5809		LPG 5
Focus / C-Max 2.0 LPG / CNG	DAW / DBW	2.0	107	04.04 - 03.07	SYDA Duratec-HE SFI	4	1,3	TR6AP-13	5809		LPG 5
Focus ST 170	DAW / DBW	2.0	127	03.02 - 11.04	ALDA Duratec-ST	4	1,0	PLTR6A-10G	3587		PLTR6A-10G

**FOCUS '04**

Focus '04 1.4	DA / DAW	1.4	59	07.04 -	ASDA Duratec-16V SFI	4	1,3	TR5B-13	4559		LPG 4
Focus '04 1.4	DA / DAW	1.4	59	07.04 -	ASDB Duratec-16V SFI	4	1,3	TR5B-13	4559		LPG 4
Focus '04 1.6 TDCi	DA / DAW	1.6	66	07.04 -	HHDA DuraTorq-TDCi	4	☑	YE04	1684	40	
Focus '04 1.6 TDCi	DA / DAW	1.6	66	07.04 -	HHDB DuraTorq-TDCi	4	☑	YE04	1684	40	
Focus '04 1.6	DA / DAW	1.6	74	07.04 -	HWDA Duratec-16V SFI	4	1,3	TR5B-13	4559		LPG 4
Focus '04 1.6	DA / DAW	1.6	74	07.04 -	HWDB Duratec-16V SFI	4	1,3	TR5B-13	4559		LPG 4
Focus '04 1.6	DA / DAW	1.6	74	07.04 -	SHDA Duratec-16V SFI	4	1,3	TR5B-13	4559		LPG 4
Focus '04 1.6	DA / DAW	1.6	74	07.04 -	SHDB Duratec-16V SFI	4	1,3	TR5B-13	4559		LPG 4
Focus '04 1.6 TDCi	DA / DAW	1.6	80	07.04 -	G8DA DuraTorq-TDCi	4	☑	YE04	1684	40	
Focus '04 1.6 TDCi	DA / DAW	1.6	80	07.04 -	G8DB DuraTorq-TDCi	4	☑	YE04	1684	40	
Focus '04 1.6 Ti	DA / DAW	1.6	85	07.04 -	HXDA Duratec-16V Ti-VCT	4	1,3	TR5B-13	4559		LPG 4
Focus '04 1.6 Ti	DA / DAW	1.6	85	07.04 -	HXDB Duratec-16V Ti-VCT	4	1,3	TR5B-13	4559		LPG 4
Focus '04 1.8 TDCi	DA / DAW	1.8	85	07.04 -	KKDA / KKDB	4	☑	Y-524J	4520	27	
Focus '04 1.8	DA / DAW	1.8	92	07.04 -	Q7DA Duratec-HE SFI	4	1,3	TR6AP-13	5809		LPG 5
Focus '04 1.8	DA / DAW	1.8	92	07.04 -	QQDB Duratec-HE SFI	4	1,3	TR6AP-13	5809		LPG 5
Focus '04 1.8	DA / DAW	1.8	92	06 -	QQDA Duratec-HE SFI	4	1,3	TR6AP-13	5809		LPG 5
Focus '04 1.8	DA / DAW	1.8	96	06 -	QQDD Duratec-HE SFI	4	1,3	TR6AP-13	5809		LPG 5

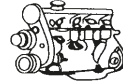
Code *l* kW

Cyl.

Stock-No.  
**VELINE**  
10-11-12-13-14-15-16-17-18-19-20-21-22-23-24-25-26-27-28-29-30-31-32-33-34-35-36-37-38-39-40-41-42-43-44-45-46-47-48-49-50-51-52-53-54-55-56-57-58-59-60-61-62-63-64-65-66-67-68-69-70-71-72-73-74-75-76-77-78-79-80-81-82-83-84-85-86-87-88-89-90-91-92-93-94-95-96-97-98-99-100

LPG/CNG

**FORD  
FOCUS '04**

Focus '04 2.0 TDCi	DA / DAW	2.0	81	02.08 -	IXDA	4	█	Y1005J	7957	56	
Focus '04 2.0 CNG	DA / DAW	2.0	93	03.09 -	Duratec-HE SFI	4	1,3	TR6AP-13	5809		LPG 5
Focus '04 2.0 TDCi	DA / DAW	2.0	98	07.04 -	G6DC DuraTorq-TDCi	4	█	Y1005J	7957	56	
Focus '04 2.0 TDCi	DA / DAW	2.0	98	07.04 -	G6DE DuraTorq-TDCi	4	█	Y1005J	7957	56	
Focus '04 2.0 TDCi	DA / DAW	2.0	98	07.04 -	G6DF DuraTorq-TDCi	4	█	Y1005J	7957	56	
Focus '04 2.0 TDCi	DA / DAW	2.0	100	07.04 -	G6DA	4	█	Y1005J	7957	56	
Focus '04 2.0 TDCi	DA / DAW	2.0	100	07.04 -	G6DB	4	█	Y1005J	7957	56	
Focus '04 2.0 TDCi	DA / DAW	2.0	100	07.04 -	G6DD	4	█	Y1005J	7957	56	
Focus '04 2.0 CNG	DA / DAW	2.0	107	03.09 -	Duratec-HE SFI	4	1,3	TR6AP-13	5809		LPG 5
Focus '04 2.0 LPG	DA / DAW	2.0	107	03.09 -	Duratec-HE SFI	4	1,3	TR6AP-13	5809		LPG 5
Focus '04 2.0	DA / DAW	2.0	107	07.04 -	AODA Duratec-HE SFI	4	1,3	TR6AP-13	5809		LPG 5
Focus '04 2.0	DA / DAW	2.0	107	07.04 -	AODB Duratec-HE SFI	4	1,3	TR6AP-13	5809		LPG 5
Focus '04 2.0	DA / DAW	2.0	107	06 -	SYDA Duratec-HE SFI	4	1,3	TR6AP-13	5809		LPG 5
Focus '04 2.5 ST	DA / DAW	2.5	166	12.05 -	HYDA	5	0,8	PLFR6A	5472		LPG 7

**FOCUS '11**

Focus '11 1.6 TI-VCT	DYM	1.6	63	08.11 -	XTDA	4	1,3	TR5B-13	4559		LPG 4
Focus '11 1.6 TDCi Norm EU V	DYM	1.6	70	04.11 -	T3DA / T3DB	4	█	Y8001AS	8904	58	
Focus '11 1.6 TI-VCT	DYM	1.6	77	04.11 -	IQDA / IQDB	4	1,3	TR5B-13	4559		LPG 4
Focus '11 1.6 TDCi Norm EU V	DYM	1.6	85	04.11 -	T1DA / T1DB	4	█	Y8001AS	8904	58	
Focus '11 1.6 Flexifuel	DYM	1.6	88	04.11 -	MUDA	4	1,3	TR5B-13	4559		LPG 4
Focus '11 1.6 TI-VCT	DYM	1.6	92	04.11 -	PNDA	4	1,3	TR5B-13	4559		LPG 4
Focus '11 1.6 EcoBoost	DYM	1.6	110	04.11 -	JQDA / JQDB	4	0,8	ILZTR6A8G	94769		
Focus '11 1.6 EcoBoost	DYM	1.6	134	04.11 -	JTDA / JTDB	4	0,8	ILZTR6A8G	94769		
Focus '11 2.0 TDCi Norm EU V	DYM	2.0	85	04.11 -	TYDA	4	█	Y8001AS	8904	58	
Focus '11 2.0 TDCi Norm EU V	DYM	2.0	100	04.11 -	UKDB	4	█	Y8001AS	8904	58	
Focus '11 2.0 TDCi Norm EU V	DYM	2.0	103	04.11 -	UFDB	4	█	Y8001AS	8904	58	
Focus '11 2.0 TDCi Norm EU V	DYM	2.0	120	04.11 -	TXDB	4	█	Y8001AS	8904	58	

**FOCUS C-MAX '11**

Focus C-Max '11 1.6 TI-VCT	BJ	1.6	63	09.11 -	XTDA	4	1,3	TR5B-13	4559		LPG 4
Focus C-Max '11 1.6 TDCi Norm EU V	BJ	1.6	70	12.10 -	T3DA / T3DB	4	█	Y8001AS	8904	58	
Focus C-Max '11 1.6	BJ	1.6	77	12.10 -	IQDA / IQDB	4	1,3	TR5B-13	4559		LPG 4
Focus C-Max '11 1.6 TDCi Norm EU V	BJ	1.6	85	12.10 -	T1DA / T1DB	4	█	Y8001AS	8904	58	
Focus C-Max '11 1.6	BJ	1.6	92	12.10 -	PNDA	4	1,3	TR5B-13	4559		LPG 4
Focus C-Max '11 1.6 EcoBoost	BJ	1.6	110	12.10 -	JQDA / JQDB	4	0,8	ILZTR6A8G	94769		
Focus C-Max '11 1.6 EcoBoost	BJ	1.6	134	12.10 -	JTDA / JTDB	4	0,8	ILZTR6A8G	94769		
Focus C-Max '11 2.0 TDCi Norm EU V	BJ	2.0	85	02.11 -	TYDA	4	█	Y8001AS	8904	58	
Focus C-Max '11 2.0 TDCi Norm EU V	BJ	2.0	100	02.11 -	UKDB	4	█	Y8001AS	8904	58	
Focus C-Max '11 2.0 TDCi Norm EU V	BJ	2.0	103	02.11 -	UFDA	4	█	Y8001AS	8904	58	
Focus C-Max '11 2.0 TDCi Norm EU V	BJ	2.0	120	12.10 -	TXDB	4	█	Y8001AS	8904	58	

**FUSION**

Fusion 1.25	JU	1.25	55	06.02 -	FUJA Duratec 16V SFI	4	1,3	PTR5A-13	2467	25	LPG 4
Fusion 1.25	JU	1.25	55	06.02 -	FUJB Duratec 16V SFI	4	1,3	PTR5A-13	2467	25	LPG 4
Fusion 1.4 TDCi	JU	1.4	50	06.02 - 12.04	F6JA DuraTorq-TDCi	4	█	YE04	1684	40	
Fusion 1.4 TDCi	JU	1.4	50	06.02 - 12.04	F6JB DuraTorq-TDCi	4	█	YE04	1684	40	
Fusion 1.4 TDCi	JU	1.4	50	01.05 -	F6JA DuraTorq-TDCi	4	█	YE05	91322	73	
Fusion 1.4 TDCi	JU	1.4	50	01.05 -	F6JB DuraTorq-TDCi	4	█	YE05	91322	73	
Fusion 1.4	JU	1.4	59	06.02 -	FXJA Duratec 16V SFI	4	1,3	PTR5A-13	2467	25	LPG 4
Fusion 1.4	JU	1.4	59	06.02 -	FXJB Duratec 16V SFI	4	1,3	PTR5A-13	2467	25	LPG 4
Fusion 1.6 TDCi	JU	1.6	66	06.02 -	HHJA DuraTorq-TDCi	4	█	YE04	1684	40	

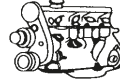
Code *l* kW

Cyl.

Stock-No.  
**VEINE**  
E-FORMER\*

LPG/CNG

**FORD****FUSION**

Fusion 1.6 TDCi	JU	1.6	66	06.02 -	HHJB DuraTorq-TDCi	4		YE04	1684	40	
Fusion 1.6	JU	1.6	74	06.02 -	FYJA Duratec 16V SFI	4	1,3	PTR5A-13	2467	25	LPG 4
Fusion 1.6	JU	1.6	74	06.02 -	FYJB Duratec 16V SFI	4	1,3	PTR5A-13	2467	25	LPG 4

**GALAXY '95**

Galaxy 1.9 TDI	WGR	1.9	66	02.95 - 02.96	1Z	4		Y-732J	5605	4	
Galaxy 1.9 TDI	WGR	1.9	66	02.95 - 03.00	ANU	4		Y-732J	5605	4	
Galaxy 1.9 TDI	WGR	1.9	66	03.96 - 03.00	1Z	4		Y-732J	5605	4	
Galaxy 1.9 TDI	WGR	1.9	66	09.96 - 03.00	AHU	4		Y-732J	5605	4	
Galaxy 1.9 TDI	WGR	1.9	81	02.95 - 08.99	AFN	4		Y-732J	5605	4	
Galaxy 1.9 TDI	WGR	1.9	81	09.99 - 03.00	AVG	4		Y-732J	5605	4	
Galaxy 1.9 TDI	WGR	1.9		06.95 -	AJM	4		Y-732J	5605	4	
Galaxy 2.0	WGR	2.0	85	02.95 - 03.00	NSE DOHC SEFI	4	1,1	BKR7EVX-11	4685		BKR8EIX
Galaxy 2.3 16V	WGR	2.3	107	02.95 - 03.00	Y5B DOHC 16V SEFI	4	1,1	BKR6EVX-11	3540		LPG 1
Galaxy 2.8 VR6 4x4	WGR	2.8	128	02.95 - 03.98	AAA CD V6 SEFI	6		BKR5EKUP	2890		
Galaxy 2.8 VR6 4x4	WGR	2.8	128	04.98 - 03.00	AMY CD V6 SEFI	6		BKR5EKUP	2890		

**GALAXY 2000**

Galaxy 1.9 TDI	WGR	1.9	66	04.00 - 02.06	ANU	4		Y-732J	5605	4	
Galaxy 1.9 TDI	WGR	1.9	85	04.00 - 02.06	AUY	4		Y-732J	5605	4	
Galaxy 1.9 TDI	WGR	1.9	96	04.00 - 02.06	ASZ	4		Y-732J	5605	4	
Galaxy 1.9 TDI	WGR	1.9	110	04.00 - 02.06	BTB	4		Y-732J	5605	4	
Galaxy 2.0	WGR	2.0	85	04.00 - 02.06	ZVSA DOHC SEFI	4	1,1	BKR7EVX-11	4685		BKR8EIX
Galaxy 2.3 16V	WGR	2.3	103	04.00 - 02.06	E5SB DOHC 16V SEFI	4	1,1	BKR6EVX-11	3540		LPG 1
Galaxy 2.3 16V	WGR	2.3	107	04.00 - 02.06	E5SA DOHC 16V SEFI	4	1,1	BKR6EVX-11	3540		LPG 1
Galaxy 2.8 24V	WGR	2.8	150	04.00 - 02.06	AYL CD V6 24V SEFI	6	1,1	PZFR5D-11	7968	34	LPG 6

**GALAXY '06**

Galaxy '06 1.6 TDCi Norm EU V	WM	1.6	85	02.11 -	T1WA / T1WB	4		Y8001AS	8904	58	
Galaxy '06 1.6 EcoBoost	WM	1.6	118	02.11 -	JTWA / JTWB	4	0,8	ILZTR6A8G	94769		
Galaxy '06 1.8 TDCi	WM	1.8	74	05.06 -	FFWA	4		Y-524J	4520	27	
Galaxy '06 2.0 TDCi	WM	2.0	85	11.07 -	KLWA	4		Y1005J	7957	56	
Galaxy '06 2.0 TDCi	WM	2.0	85	11.07 -	TYWA	4		Y8001AS	8904	58	
Galaxy '06 2.0 TDCi	WM	2.0	96	05.06 -	AZWA	4		Y1005J	7957	56	
Galaxy '06 2.0 TDCi	WM	2.0	100	04.06 -	AZWC / UKWA	4		Y8001AS	8904	58	
Galaxy '06 2.0 TDCi	WM	2.0	103	05.06 -	QXWA / QXWB / QXWC	4		Y1005J	7957	56	
Galaxy '06 2.0 TDCi	WM	2.0	103	05.06 -	UFWA	4		Y8001AS	8904	58	
Galaxy '06 2.0	WM	2.0	107	05.06 -	AOWA / AOWB	4	1,3	TR6AP-13	5809		LPG 5
Galaxy '06 2.0 Flexifuel	WM	2.0	107	05.06 -	TBWA / TBWB	4	1,3	TR6AP-13	5809		LPG 5
Galaxy '06 2.0 TDCi Norm EU V	WM	2.0	120	03.10 -	TXWA	4		Y8001AS	8904	58	
Galaxy '06 2.0 EcoBoost	WM	2.0	149	03.10 -	TNWA	4	0,8	ILTR6G8G	96621		
Galaxy '06 2.2 TDCi	WM	2.2	129	03.08 -	Q4BA / Q4WA	4		YE08	4966		
Galaxy '06 2.2 TDCi	WM	2.2	147	07.10 -		4		YE08	4966		
Galaxy '06 2.3	WM	2.3	118	07.07 -	SEWA	4	1,3	ILTR5A-13G	3811		ILTR6A-13G

**KA '96**

Ka '96 1.3	RB	1.3	36	09.96 -	JJD Endura-E SEFI	4	1,0	PTR5D-10	3784	31	LPG 5
Ka '96 1.3	RB	1.3	36	09.96 -	JJF Endura-E SEFI	4	1,0	PTR5D-10	3784	31	LPG 5
Ka '96 1.3	RB	1.3	36	09.96 -	JJG Endura-E SEFI	4	1,0	PTR5D-10	3784	31	LPG 5
Ka '96 1.3	RB	1.3	36	09.96 -	JJH Endura-E SEFI	4	1,0	PTR5D-10	3784	31	LPG 5
Ka '96 1.3	RB	1.3	36	09.96 -	JJL Endura-E SEFI	4	1,0	PTR5D-10	3784	31	LPG 5
Ka '96 1.3	RB	1.3	37	09.96 -	JJB Endura-E SEFI	4	1,0	PTR5D-10	3784	31	LPG 5
Ka '96 1.3	RB	1.3	44	09.96 -	BAA Duratec 8V SFI	4	1,3	TR5B-13	4559		LPG 4

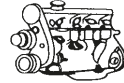
Code *l* kW

Cyl.



Stock-No.

VLINE  
E-M-PROW/ERK\*\*

LPG/CNG

**FORD  
KA '96**

Ka '96 1.3	RB	1.3	44	09.96 -	J4D Endura-E SEFI	4	1,0	PTR5D-10	3784	31	LPG 5
Ka '96 1.3	RB	1.3	44	09.96 -	J4K Endura-E SEFI	4	1,0	PTR5D-10	3784	31	LPG 5
Ka '96 1.3	RB	1.3	44	09.96 -	J4M Endura-E SEFI	4	1,0	PTR5D-10	3784	31	LPG 5
Ka '96 1.3	RB	1.3	44	09.96 -	J4N Endura-E SEFI	4	1,0	PTR5D-10	3784	31	LPG 5
Ka '96 1.3	RB	1.3	44	09.96 -	J4P Endura-E SEFI	4	1,0	PTR5D-10	3784	31	LPG 5
Ka '96 1.3	RB	1.3	44	09.96 -	J4S Endura-E SEFI	4	1,0	PTR5D-10	3784	31	LPG 5
Ka '96 1.3	RB	1.3	51	09.96 -	A9A Duratec 8V SFI	4	1,3	TR5B-13	4559		LPG 4
Ka '96 1.3	RB	1.3	51	09.96 -	A9B Duratec 8V SFI	4	1,3	TR5B-13	4559		LPG 4
Ka '96 1.6	RB	1.6	70	09.96 -	CDB Duratec 8V SFI	4	1,3	PTR5A-13	2467	25	LPG 4
Ka '96 1.6	RB	1.6	70	09.96 -	CDC Duratec 8V SFI	4	1,3	PTR5A-13	2467	25	LPG 4

**KA '08**

Ka '08 1.2	JDU	1.2	51	02.09 -	FP4	4	1,0	ZKR7A-10	1691		LPG 8
Ka '08 1.3 TDCi	JDU	1.3	55	02.09 - 10.10	FD4	4	<input checked="" type="checkbox"/>	Y8003J	97256	62	
Ka '08 1.3 TDCi	JDU	1.3	55	11.10 -	FD4	4	<input checked="" type="checkbox"/>	Y9001AS	97719	72	

**KUGA 1**

Kuga 1 2.0 TDCI	DR	2.0	100	03.08 -	G6DG / UKDA	4	<input checked="" type="checkbox"/>	Y1005J	7957	56	
Kuga 1 2.0 TDCI Norm EU V	DR	2.0	103	03.10 -	UFDA	4	<input checked="" type="checkbox"/>	Y8001AS	8904	58	
Kuga 1 2.0 TDCI	DR	2.0	120	03.10 -	DuraTorq-TDCi	4	<input checked="" type="checkbox"/>	Y1005J	7957	56	

**KUGA 2**

Kuga 2 1.6 EcoBoost	MA	1.6	110	11.12 -	JQMA / JQMB	4	0,8	ILZTR6A8G	94769		
Kuga 2 1.6 EcoBoost	MA	1.6	134	11.12 -	JTMA	4	0,8	ILZTR6A8G	94769		
Kuga 2 2.0 TDCI	MA	2.0	100	11.12 -	UKMA	4	<input checked="" type="checkbox"/>	Y8001AS	8904	58	
Kuga 2 2.0 TDCI	MA	2.0	103	11.12 -	UFMA	4	<input checked="" type="checkbox"/>	Y8001AS	8904	58	
Kuga 2 2.0 TDCI	MA	2.0	120	11.12 -	TXMA	4	<input checked="" type="checkbox"/>	Y8001AS	8904	58	

**MAVERICK '93**

Maverick '93 2.4	UDS / UNS	2.4	85	06.93 - 04.98	KA24 OHC 12V SEFI	4	1,1	ZFR5E-11	4435		
Maverick '93 2.4	UDS / UNS	2.4	87	06.93 - 04.98	KA24 OHC 12V SEFI	4	1,1	ZFR5E-11	4435		
Maverick '93 2.4	UDS / UNS	2.4	91	06.93 - 04.98	KA24 OHC 12V SEFI	4	1,1	ZFR5E-11	4435		
Maverick '93 2.7	UDS / UNS	2.7	74	04.93 - 04.98	TD27	4	<input checked="" type="checkbox"/>	Y-712RS	6140		
Maverick '93 2.7	UDS / UNS	2.7	92	05.96 - 04.98	TD27E	4	<input checked="" type="checkbox"/>	CY58	5486		

**MAVERICK '01**

Maverick '01 2.0 16V		2.0	91	12.00 - 11.03	YF ZETEC-E SFI	4	1,3	PTR5A-13	2467	25	LPG 4
Maverick '01 2.3 16V		2.3	110	12.03 -	GZ Duratec-HE SFI	4	1,3	ITR6F13	4477		LPG 5
Maverick '01 3.0		3.0	145	12.00 - 11.03	AJ Duratec-VE SFI	6	1,0	TR5IX	7397		LPG 5
Maverick '01 3.0		3.0	149	12.03 -	AJ Duratec-VE SFI	6	1,0	TR5IX	7397		LPG 5

**MONDEO '93**

Mondeo '93 1.6		1.6	65	01.93 - 07.96	L1J ZETEC-E SEFI	4	1,3	PTR5A-13	2467	25	LPG 4
Mondeo '93 1.6		1.6	66	01.93 - 07.96	L1F ZETEC SEFI	4	1,3	PTR5A-13	2467	25	LPG 4
Mondeo '93 1.8 TD		1.8	65	01.93 - 07.96	RFM D TCI	4	<input checked="" type="checkbox"/>	Y-910J	3617	3	
Mondeo '93 1.8 TD		1.8	65	01.93 - 07.96	RFN D TCI	4	<input checked="" type="checkbox"/>	Y-910J	3617	3	
Mondeo '93 1.8		1.8	82	01.93 - 07.96	RKB ZETEC-E SEFI	4	1,3	PTR5A-13	2467	25	LPG 4
Mondeo '93 1.8		1.8	85	01.93 - 07.96	RKA ZETEC SEFI	4	1,3	PTR5A-13	2467	25	LPG 4
Mondeo '93 2.0		2.0	100	01.93 - 07.96	NGA ZETEC SEFI	4	1,3	PTR5A-13	2467	25	LPG 4
Mondeo '93 2.5 i 24V		2.5	125	01.93 - 07.96	SEA Duratec-VE SEFI	6	1,0	PTR5D-10	3784	31	LPG 5

**MONDEO '97**

Mondeo '97 1.6		1.6	65	08.96 - 09.00	L1J ZETEC-E SEFI	4	1,3	PTR5A-13	2467	25	LPG 4
Mondeo '97 1.6 16V		1.6	70	08.96 - 09.00	L1L ZETEC-E SEFI	4	1,3	PTR5A-13	2467	25	LPG 4
Mondeo '97 1.6 16V		1.6	70	08.96 - 09.00	L1N ZETEC-E SEFI	4	1,3	PTR5A-13	2467	25	LPG 4

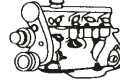

Code *l* kW

Cyl.



Stock-No.



LPG/CNG

**FORD****MONDEO '97**

Mondeo '97 1.6 16V		1.6	70	08.96 - 09.00	L1Q ZETEC-E SEFI	4	1,3	PTR5A-13	2467	25	LPG 4
Mondeo '97 1.8 TD		1.8	66	08.96 - 09.00	RFN Endura-De TCI	4	█	Y-937R	5148	5	
Mondeo '97 1.8		1.8	85	08.96 - 09.00	RKB ZETEC-E SEFI	4	1,3	PTR5A-13	2467	25	LPG 4
Mondeo '97 1.8		1.8	85	08.96 - 09.00	RKF ZETEC-E SEFI	4	1,3	PTR5A-13	2467	25	LPG 4
Mondeo '97 1.8		1.8	85	08.96 - 09.00	RKH ZETEC-E SEFI	4	1,3	PTR5A-13	2467	25	LPG 4
Mondeo '97 1.8		1.8	85	08.96 - 09.00	RKJ ZETEC-E SEFI	4	1,3	PTR5A-13	2467	25	LPG 4
Mondeo '97 1.8		1.8	85	08.96 - 09.00	RKK ZETEC-E SEFI	4	1,3	PTR5A-13	2467	25	LPG 4
Mondeo '97 2.0		2.0	96	08.96 - 09.00	NGA ZETEC-E SEFI	4	1,3	PTR5A-13	2467	25	LPG 4
Mondeo '97 2.0		2.0	96	08.96 - 09.00	NGB ZETEC-E SEFI	4	1,3	PTR5A-13	2467	25	LPG 4
Mondeo '97 2.0		2.0	96	08.96 - 09.00	NGC ZETEC-E SEFI	4	1,3	PTR5A-13	2467	25	LPG 4
Mondeo '97 2.0		2.0	96	08.96 - 09.00	NGD ZETEC-E SEFI	4	1,3	PTR5A-13	2467	25	LPG 4
Mondeo '97 2.5 24V		2.5	125	08.96 - 09.00	SEA Duratec-VE SEFI	6	1,0	PTR5D-10	3784	31	LPG 5
Mondeo '97 2.5 24V		2.5	125	08.96 - 09.00	SEB Duratec-VE SEFI	6	1,0	PTR5D-10	3784	31	LPG 5
Mondeo '97 2.5 24V		2.5	125	08.96 - 09.00	SEC Duratec-VE SEFI	6	1,0	PTR5D-10	3784	31	LPG 5
Mondeo '97 2.5 ST 200		2.5	151	08.96 - 09.00	SGA Duratec-VE SEFI	6	1,3	PTR6D-13G	6989		LPG 5

**MONDEO '01**

Mondeo '01 1.8 16V		1.8	81	10.00 - 8.07	CGBA Duratec-HE SFI	4	1,3	PTR6F-13	7569		LPG 5
Mondeo '01 1.8 16V		1.8	81	10.00 - 8.07	CGBB Duratec-HE SFI	4	1,3	PTR6F-13	7569		LPG 5
Mondeo '01 1.8 16V		1.8	92	10.00 - 8.07	CHBA Duratec-HE SFI	4	1,3	PTR6F-13	7569		LPG 5
Mondeo '01 1.8 16V		1.8	92	10.00 - 8.07	CHBB Duratec-HE SFI	4	1,3	PTR6F-13	7569		LPG 5
Mondeo '01 2.0 TDCi		2.0	66	10.00 - 8.07	D5BA DuraTorq-DI	4	█	Y-548J	94832	75	
Mondeo '01 2.0 TDCi		2.0	85	10.00 - 8.07	D6BA DuraTorq-DI	4	█	Y-548J	94832	75	
Mondeo '01 2.0 TDCi		2.0	85	10.00 - 8.07	HJBA DuraTorq-TDCi	4	█	Y-548J	94832	75	
Mondeo '01 2.0 TDCi		2.0	85	10.00 - 8.07	HJBB DuraTorq-TDCi	4	█	Y-548J	94832	75	
Mondeo '01 2.0 TDCi		2.0	85	10.00 - 8.07	HJBC DuraTorq-TDCi	4	█	Y-548J	94832	75	
Mondeo '01 2.0 TDCi		2.0	85	10.00 - 8.07	SDBA DuraTorq-TDCi	4	█	Y-548J	94832	75	
Mondeo '01 2.0 TDCi		2.0	96	10.00 - 8.07	FMBA DuraTorq-TDCi	4	█	Y-548J	94832	75	
Mondeo '01 2.0 TDCi		2.0	96	10.00 - 8.07	N7BA DuraTorq-TDCi	4	█	Y-548J	94832	75	
Mondeo '01 2.0 16V		2.0	107	10.00 - 8.07	CJBA Duratec-HE SFI	4	1,3	PTR6F-13	7569		LPG 5
Mondeo '01 2.0 16V		2.0	107	10.00 - 8.07	CJBB Duratec-HE SFI	4	1,3	PTR6F-13	7569		LPG 5
Mondeo '01 2.2 TDCi		2.2	110	09.04 - 8.07	QJBC DuraTorq-TDCi	4	█	Y-548J	94832	75	
Mondeo '01 2.2 TDCi		2.2	110	09.04 - 8.07	QJBD DuraTorq-TDCi	4	█	Y-548J	94832	75	
Mondeo '01 2.2 TDCi		2.2	114	09.04 - 8.07	QJBA DuraTorq-TDCi	4	█	Y-548J	94832	75	
Mondeo '01 2.2 TDCi		2.2	114	09.04 - 8.07	QJBB DuraTorq-TDCi	4	█	Y-548J	94832	75	
Mondeo '01 2.5 V6 24V		2.5	125	10.00 - 8.07	LCBD Duratec-VE SFI	6	1,3	PTR5D-13	6644		LPG 5
Mondeo '01 3.0 V6 24V		3.0	150	10.00 - 8.07	REBA Duratec-ST SFI	6	1,3	PTR6D-13G	6989		LPG 5
Mondeo '01 2.5 ST 220		3.0	166	10.00 - 8.07	MEBA Duratec-ST SFI	6	1,3	PTR6D-13G	6989		LPG 5

**MONDEO '07**

Mondeo '07 1.6 Ti		1.6	81	02.07 -	RHBA Duratec - 16V Ti-VCT	4	1,3	TR5B-13	4559		LPG 4
Mondeo '07 1.6 TDCi Norm EU V		1.6	85	11.10 -		4	█	Y8001AS	8904	58	
Mondeo '07 1.6 Ti		1.6	88	07.10 -		4	1,3	TR5B-13	4559		LPG 4
Mondeo '07 1.6 Ti		1.6	92	02.07 -	PNBA Duratec - 16V Ti-VCT	4	1,3	TR5B-13	4559		LPG 4
Mondeo '07 1.6 EcoBoost		1.6	118	02.11 -	JTBA / JTBB	4	0,8	ILZTR6A8G	94769		
Mondeo '07 1.8 TDCi		1.8	74	02.07 -	FFBA DuraTorq-TDCi	4	█	Y-524J	4520	27	
Mondeo '07 2.0 TDCi		2.0	85	02.07 -	KLBA / LPBA / TYBA	4	█	Y1005J	7957	56	
Mondeo '07 2.0 TDCi		2.0	96	02.07 -	AZBA	4	█	Y1005J	7957	56	
Mondeo '07 2.0 TDCi		2.0	100	03.07 -	AZBC	4	█	Y1005J	7957	56	
Mondeo '07 2.0 TDCi		2.0	103	02.07 -	QXBB / UFBA	4	█	Y1005J	7957	56	
Mondeo '07 2.0		2.0	107	02.07 -	AOBA / AOBC	4	1,3	TR6AP-13	5809		LPG 5

Code *l* kW

Cyl.



Stock-No.

VLINE

10-15-20-25-30-35-40-45-50-55-60-65-70-75-80-85-90-95-100-105-110-115-120-125-130-135-140-145-150-155-160-165-170-175-180-185-190-195-200-205-210-215-220-225-230-235-240-245-250-255-260-265-270-275-280-285-290-295-300-305-310-315-320-325-330-335-340-345-350-355-360-365-370-375-380-385-390-395-400-405-410-415-420-425-430-435-440-445-450-455-460-465-470-475-480-485-490-495-500-505-510-515-520-525-530-535-540-545-550-555-560-565-570-575-580-585-590-595-600-605-610-615-620-625-630-635-640-645-650-655-660-665-670-675-680-685-690-695-700-705-710-715-720-725-730-735-740-745-750-755-760-765-770-775-780-785-790-795-800-805-810-815-820-825-830-835-840-845-850-855-860-865-870-875-880-885-890-895-900-905-910-915-920-925-930-935-940-945-950-955-960-965-970-975-980-985-990-995-1000

LPG/CNG

**FORD  
MONDEO '07**

Mondeo '07 2.0 Flexifuel		2.0	107	03.07 -	TBBA / TBBA	4	1,3	TR6AP-13	5809		LPG 5
Mondeo '07 2.0 LPG		2.0	107	03.09 -	TBBA	4	1,3	TR6AP-13	5809		LPG 5
Mondeo '07 2.0 TDCi Norm EU V		2.0	120	03.10 -	TXBA	4	█	Y8001AS	8904	58	
Mondeo '07 2.0 EcoBoost		2.0	149	03.10 -	TNBA	4	0,8	ILTR6G8G	96621		
Mondeo '07 2.0 EcoBoost		2.0	176	07.10 -	TPBA	4	0,8	ILTR6G8G	96621		
Mondeo '07 2.2 TDCi		2.2	129	03.08 - 10.10	Q4BA	4	█	YE08	4966		
Mondeo '07 2.3		2.3	118	02.07 -	SEBA Duratec	4	1,3	ILTR5A-13G	3811		ILTR6A-13G
Mondeo '07 2.5		2.5	162	02.07 -	HUBA	5	0,8	PLFR6A	5472		LPG 7

**ORION '91**

Orion '91 1.3		1.3	44	08.90 - 07.93	J6A HCS CFI	4	1,0	PTR5D-10	3784	31	LPG 5
Orion '91 1.3		1.3	44	08.90 - 07.93	JBE HCS 2V	4	1,0	PTR5D-10	3784	31	LPG 5
Orion '91 1.3		1.3	46	08.90 - 07.93	JBD HCS 2V	4	1,0	PTR5D-10	3784	31	LPG 5
Orion '91 1.4		1.4	52	08.90 - 07.93	F6F CVH CFI	4	1,1	BCPR6ES-11	7121	11	LPG 3
Orion '91 1.4		1.4	52	08.90 - 07.93	F6G CVH CFI	4	1,1	BCPR6ES-11	7121	11	LPG 3
Orion '91 1.4		1.4	54	08.90 - 07.93	FUH CVH 2V	4	0,8	BCPR6ES	2330	12	LPG 3
Orion '91 1.6 16V		1.6	66	08.90 - 07.93	L1E ZETEC SEFI	4	1,3	PTR5A-13	2467	25	LPG 4
Orion '91 1.6 16V		1.6	66	08.90 - 07.93	LUJ CVH 2V	4	0,8	BCPR6ES	2330	12	LPG 3
Orion '91 1.6 16V		1.6	66	08.90 - 07.93	LUK CVH 2V	4	0,8	BCPR6ES	2330	12	LPG 3
Orion '91 1.6		1.6	77	08.90 - 07.93	LJF CVH EFI	4	1,1	BCPR6ES-11	7121	11	LPG 3
Orion '91 1.6		1.6	79	08.90 - 07.93	LJE CVH EFI	4	1,1	BCPR6ES-11	7121	11	LPG 3
Orion '91 1.8 D		1.8	44	08.90 - 07.93	RTE	4	█	Y-910R	4751	3	
Orion '91 1.8 D		1.8	44	08.90 - 07.93	RTF	4	█	Y-910R	4751	3	
Orion '91 1.8 D		1.8	44	08.90 - 07.93	RTH	4	█	Y-910R	4751	3	
Orion '91 1.8 TD		1.8	66	08.90 - 07.93	RFD	4	█	Y-910R	4751	3	
Orion '91 1.8 TD		1.8	66	08.90 - 07.93	RFK	4	█	Y-910R	4751	3	
Orion '91 1.8 16V		1.8	77	08.90 - 07.93	RDA ZETEC SEFI	4	1,3	PTR5A-13	2467	25	LPG 4
Orion '91 1.8 16V		1.8	96	08.90 - 07.93	RQB ZETEC SEFI	4	1,3	PTR5A-13	2467	25	LPG 4

**PROBE**

Probe 2.0		2.0	85	01.93 - 07.97	FS DOHC 16V SEFI	4	1,1	BCPR6ES-11	7121	11	LPG 3
Probe 2.2 GT		2.2	108	03.91 - 12.92	OHC EFI	4	1,1	ZFR6F-11	4291		LPG 6
Probe 2.5 V6 24V		2.5	120	01.93 - 07.97	KL V6 24V EFI	6	1,1	ZFR6F-11	4291		LPG 6

**PUMA '97**

Puma '97 1.4 16V	EC	1.4	66	06.97 - 12.01	FHD ZETEC-SE SEFI	4	1,3	PTR5A-13	2467	25	LPG 4
Puma '97 1.4 16V	EC	1.4	66	06.97 - 12.01	FHF ZETEC-SE SEFI	4	1,3	PTR5A-13	2467	25	LPG 4
Puma '97 1.6 16V	EC	1.6	76	06.97 - 12.01	L1W ZETEC-SE SFI	4	1,3	PTR5A-13	2467	25	LPG 4
Puma '97 1.7 16V	EC	1.7	92	06.97 - 12.01	MHA ZETEC-S VCT SFI	4	1,3	PTR5A-13	2467	25	LPG 4
Puma '97 1.7 16V	EC	1.7	92	06.97 - 12.01	MHB ZETEC-S VCT SFI	4	1,3	PTR5A-13	2467	25	LPG 4

**SCORPIO '85**

Scorpio '85 1.8		1.8	66	05.85 - 10.94	REC OHC 2V	4	0,8	APR6FS	2922		
Scorpio '85 2.0		2.0	74	05.85 - 10.94	NE4 OHC 2V	4	0,8	APR6FS	2922		
Scorpio '85 2.0		2.0	74	05.85 - 10.94	NER OHC 2V	4	0,8	APR6FS	2922		
Scorpio '85 2.0 i		2.0	74	05.85 - 10.94	NRC OHC EFI	4	0,8	APR6FS	2922		
Scorpio '85 2.0		2.0	77	05.85 - 10.94	N8D DOHC 2V	4	0,8	BCPR6ES	2330	12	LPG 3
Scorpio '85 2.0		2.0	77	05.85 - 10.94	NEL OHC 2V	4	0,8	APR6FS	2922		
Scorpio '85 2.0		2.0	77	05.85 - 10.94	NEL OHC 2V Cat.	4	0,8	APR6FS	2922		
Scorpio '85 2.0		2.0	80	05.85 - 10.94	N8B DOHC 2V	4	0,8	BCPR6ES	2330	12	LPG 3
Scorpio '85 2.0 i		2.0	85	05.85 - 10.94	N9F DOHC EFI	4	0,8	BCPR6ES	2330	12	LPG 3
Scorpio '85 2.0 i		2.0	85	05.85 - 10.94	NRA OHC EFI	4	0,8	APR6FS	2922		
Scorpio '85 2.0 i		2.0	85	05.85 - 10.94	NRA OHC EFI Cat.	4	0,8	APR6FS	2922		

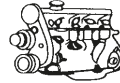
Code *l* kW

Cyl.

Stock-No.  
**V-TUNE**  
**EX-POWER**

LPG/CNG

**FORD****SCORPIO '85**

Scorpio '85 2.0 i		2.0	85	05.85 - 10.94	NRI OHC EFI	4	0,8	APR6FS	2922		
Scorpio '85 2.0 i		2.0	88	05.85 - 10.94	N9D DOHC EFI	4	0,8	BCPR6ES	2330	12	LPG 3
Scorpio '85 2.0 i		2.0	90	05.85 - 10.94	N9B DOHC EFI	4	0,8	BCPR6ES	2330	12	LPG 3
Scorpio '85 2.4 i V6		2.4	92	05.85 - 10.94	ARD V6 EFI	6	1,0	BPR6EFS	3623	7	LPG 5
Scorpio '85 2.4 i V6		2.4	96	05.85 - 10.94	ARC V6 EFI	6	0,8	BCPR6ES	2330	12	LPG 3
Scorpio '85 2.5 D		2.5	51	05.85 - 10.94	STR D	4	█	Y-924J	7906	1	
Scorpio '85 2.5 TD		2.5	68	05.85 - 10.94	SFA D TURBO	4	█	Y-924J	7906	1	
Scorpio '85 2.5 TD		2.5	68	05.85 - 10.94	SFB D TURBO	4	█	Y-924J	7906	1	
Scorpio '85 2.5 TD		2.5		11.94 - 07.98	SCB	4	█	Y-741U	6943	20	
Scorpio '85 2.8 i		2.8	105	05.85 - 10.94	PR4 V6 EFI	6	0,8	BPR6ES	7822	2	LPG 2
Scorpio '85 2.8 i		2.8	107	05.85 - 10.94	PR3 V6 EFI	6	0,8	BPR6ES	7822	2	LPG 2
Scorpio '85 2.8 i		2.8	110	05.85 - 10.94	PRE V6 EFI	6	0,8	BPR6ES	7822	2	LPG 2
Scorpio '85 2.9 i		2.9	107	05.85 - 10.94	BRD V6 EFI	6	1,0	BPR6EFS	3623	7	LPG 5
Scorpio '85 2.9 i		2.9	107	05.85 - 10.94	BRE V6 EFI	6	1,0	BPR6EFS	3623	7	LPG 5
Scorpio '85 2.9 i		2.9	107	05.85 - 10.94	BRF V6 EFI	6	1,0	BPR6EFS	3623	7	LPG 5
Scorpio '85 2.9 i		2.9	110	05.85 - 10.94	BRC V6 EFI	6	0,8	BCPR6ES	2330	12	LPG 3
Scorpio '85 2.9 i Cosworth		2.9	143	05.85 - 10.94	BOA V6 24V EFI	6	1,1	BKR6EIX-11	3764		LPG 1

**SCORPIO '95**

Scorpio '95 2.0 i		2.0	85	10.94 - 06.98	NSD DOHC 8V SEFI	4	1,1	PFR6B-11	4014		PFR7B
Scorpio '95 2.0 i		2.0	100	10.94 - 06.98	N3A DOHC 16V SEFI	4	1,1	PFR6B-11	4014		PFR7B
Scorpio '95 2.3		2.3	108	10.94 - 06.98	Y5A 16V SEFI	4	1,1	BKR6EIX-11	3764		LPG 1
Scorpio '95 2.5 TD		2.5	85	10.94 - 06.98	SCC TCI	4	█	Y-741U	6943	20	
Scorpio '95 2.5 TD		2.5	92	10.94 - 06.98	SCD TCI	4	█	Y-741U	6943	20	
Scorpio '95 2.9 i		2.9	110	10.94 - 06.98	BRG V6 12V SEFI	6	1,0	BPR6EFS	3623	7	LPG 5
Scorpio '95 2.9 i Cosworth		2.9	152	10.94 - 06.98	BOB V6 24V SEFI	6	1,1	PFR6B-11	4014		PFR7B

**SIERRA '87**

Sierra '87 1.6		1.6	53	01.87 - 12.92	LSF OHC 2V	4	0,8	APR6FS	2922		
Sierra '87 1.6		1.6	55	01.87 - 12.92	LSE OHC 2V	4	0,8	APR6FS	2922		
Sierra '87 1.6		1.6	55	01.87 - 12.92	LSE OHC 2V Cat.	4	0,8	APR6FS	2922		
Sierra '87 1.6i		1.6	59	01.87 - 12.92	L6B CVH CFI	4	1,1	BCPR6ES-11	7121	11	LPG 3
Sierra '87 1.8 TD		1.8	55	01.87 - 12.92	RFA	4	█	Y-910R	4751	3	
Sierra '87 1.8 TD		1.8	55	01.87 - 12.92	RFB	4	█	Y-910R	4751	3	
Sierra '87 1.8 TD		1.8	55	01.87 - 12.92	RFL	4	█	Y-910R	4751	3	
Sierra '87 1.8		1.8	59	01.87 - 12.92	RED OHC 2V Cat.	4	0,8	APR6FS	2922		
Sierra '87 1.8		1.8	59	01.87 - 12.92	REF OHC 2V	4	0,8	APR6FS	2922		
Sierra '87 1.8		1.8	63	01.87 - 12.92	R6A CVH CFI	4	1,1	BCPR6ES-11	7121	11	LPG 3
Sierra '87 1.8		1.8	64	01.87 - 12.92	R2C CVH 2V	4	1,1	BCPR6ES-11	7121	11	LPG 3
Sierra '87 1.8		1.8	66	01.87 - 12.92	R2A CVH 2V	4	1,1	BCPR6ES-11	7121	11	LPG 3
Sierra '87 1.8		1.8	66	01.87 - 12.92	RED OHC 2V	4	0,8	APR6FS	2922		
Sierra '87 2.0 i		2.0	74	01.87 - 12.92	N4B OHC EFI	4	0,8	APR6FS	2922		
Sierra '87 2.0 i		2.0	74	01.87 - 12.92	NE5 OHC 2V	4	0,8	APR6FS	2922		
Sierra '87 2.0 i		2.0	74	01.87 - 12.92	NEJ OHC 2V	4	0,8	APR6FS	2922		
Sierra '87 2.0		2.0	77	01.87 - 12.92	N8C DOHC 2V	4	0,8	BCPR6ES	2330	12	LPG 3
Sierra '87 2.0		2.0	77	01.87 - 12.92	NES OHC 2V	4	0,8	APR6FS	2922		
Sierra '87 2.0		2.0	77	01.87 - 12.92	NES OHC 2V Cat.	4	0,8	APR6FS	2922		
Sierra '87 2.0		2.0	80	01.87 - 12.92	N8A DOHC 2V	4	0,8	BCPR6ES	2330	12	LPG 3
Sierra '87 2.0 i		2.0	85	01.87 - 12.92	N4A OHC EFI	4	0,8	APR6FS	2922		
Sierra '87 2.0 i		2.0	85	01.87 - 12.92	N4A OHC EFI Cat.	4	0,8	APR6FS	2922		
Sierra '87 2.0 i		2.0	85	01.87 - 12.92	N4I OHC EFI	4	0,8	APR6FS	2922		
Sierra '87 2.0 i		2.0	85	01.87 - 12.92	N9E DOHC EFI	4	0,8	BCPR6ES	2330	12	LPG 3
Sierra '87 2.0 i		2.0	88	01.87 - 12.92	N9C DOHC EFI	4	0,8	BCPR6ES	2330	12	LPG 3

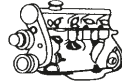
Code *l* kW

Cyl.



Stock-No.

VLINE  
E-PROXY/2018\*\*

LPG/CNG

**FORD  
SIERRA '87**

Sierra '87 2.0 i		2.0	90	01.87 - 12.92	N9A DOHC EFI	4	0,8	BCPR6ES	2330	12	LPG 3
Sierra '87 2.0 RS Cosworth		2.0	150	01.87 - 12.92	N5B DOHC COSWORTH	4	0,9	R7234-9	5487		
Sierra '87 2.0 16V Cosworth 4x4		2.0	162	01.87 - 12.92	N5C DOHC COSWORTH	4	1,1	PFR7B-11	5667		
Sierra '87 2.0 16V Cosworth 4x4		2.0	162	01.87 - 12.92	N5D DOHC COSWORTH	4	1,1	PFR7B-11	5667		
Sierra '87 2.3 D		2.3	49	01.87 - 12.92	YTR	4	█	Y-924J	7906	1	
Sierra '87 2.8 i		2.8	105	01.87 - 12.92	PR8 V6 EFI	6	0,8	BPR6ES	7822	2	LPG 2
Sierra '87 2.8 i		2.8	107	01.87 - 12.92	PR7 V6 EFI	6	0,8	BPR6ES	7822	2	LPG 2
Sierra '87 2.8 i		2.8	110	01.87 - 12.92	PRG V6 FI	6	0,8	BPR6ES	7822	2	LPG 2
Sierra '87 2.9 i		2.9	107	01.87 - 12.92	B4B V6 EFI	6	1,0	BPR6EFS	3623	7	LPG 5
Sierra '87 2.9 i		2.9	107	01.87 - 12.92	B4C V6 EFI	6	1,0	BPR6EFS	3623	7	LPG 5
Sierra '87 2.9 i		2.9	110	01.87 - 12.92	B4A V6 EFI	6	0,8	BCPR6ES	2330	12	LPG 3

**S-MAX**

S-MAX 1.6 TDCi Norm EU V	WS	1.6	85	02.11 -	T1WA	4	█	Y8001AS	8904	58	
S-MAX 1.6 EcoBoost	WS	1.6	118	02.11 -	JTWA	4	0,8	ILZTR6A8G	94769		
S-MAX 1.8 TDCi	WS	1.8	74	03.06 -	FFWA	4	█	Y-524J	4520	27	
S-MAX 1.8 TDCi	WS	1.8	92	03.06 -	QYWA	4	█	Y-524J	4520	27	
S-MAX 2.0 TDCi	WS	2.0	85	11.07 -	KLWA	4	█	Y1005J	7957	56	
S-MAX 2.0 TDCi	WS	2.0	85	11.07 -	TYWA	4	█	Y8001AS	8904	58	
S-MAX 2.0 TDCi	WS	2.0	96	03.06 -	AZWA	4	█	Y1005J	7957	56	
S-MAX 2.0 TDCi	WS	2.0	100	05.06 -	AZWC / UKWA	4	█	Y1005J	7957	56	
S-MAX 2.0 TDCi	WS	2.0	103	03.06 -	QXWA / QXWB / QXWC	4	█	Y1005J	7957	56	
S-MAX 2.0 TDCi	WS	2.0	103	03.06 -	UFWA	4	█	Y8001AS	8904	58	
S-MAX 2.0	WS	2.0	107	03.06 -	AOWA / AOWB	4	1,3	TR6AP-13	5809		LPG 5
S-MAX 2.0 Flexifuel	WS	2.0	107	05.06 -	TBWA / TBWB	4	1,3	TR6AP-13	5809		LPG 5
S-MAX 2.0 TDCi	WS	2.0	120	03.10 -	TXWA	4	█	Y1005J	7957	56	
S-MAX 2.0 EcoBoost	WS	2.0	149	03.10 -	TNWA	4	0,8	ILTR6G8G	96621		
S-MAX 2.0 EcoBoost	WS	2.0	176	07.10 -	TPWA	4	0,8	ILTR6G8G	96621		
S-MAX 2.2 TDCi	WS	2.2	129	03.08 -	Q4WA	4	█	YE08	4966		
S-MAX 2.2 TDCi	WS	2.2	147	07.10 -	KNWA	4	█	YE08	4966		
S-MAX 2.3	WS	2.3	118	08.07 -	SEWA Duratec-HE	4	1,3	ILTR5A-13G	3811		ILTR6A-13G
S-MAX 2.5 ST	WS	2.5	162	03.06 -	HUWA	5	0,8	PLFR6A	5472		LPG 7

**SPORTKA**

Sportka		1.6		05.03 -	Duratec Rocam	4	1,3	TR5B-13	4559		LPG 4
---------	--	-----	--	---------	---------------	---	-----	---------	------	--	-------

**STREETKA**

Streetka		1.6	70	01.03 - 07.05	CDRA Duratec 8V	4	1,3	TR5B-13	4559		LPG 4
Streetka		1.6	70	01.03 - 07.05	CDRB Duratec 8V	4	1,3	PTR5A-13	2467	25	LPG 4

**TOURNEO CONNECT**

Tourneo Connect		1.8	55	06.02 -	BHPA Endura-DI	4	█	Y-524J	4520	27	
Tourneo Connect		1.8	66	06.02 -	HCPA Duratorq-TDCi	4	█	Y-524J	4520	27	
Tourneo Connect		1.8	66	06.02 -	HCPB Duratorq-TDCi	4	█	Y-524J	4520	27	
Tourneo Connect		1.8	81	06.02 -	RWPA Duratorq-TDCi	4	█	Y-524J	4520	27	
Tourneo Connect		1.8	85	06.02 -	EYPA ZETEC-E SFI	4	1,3	PTR5A-13	2467	25	LPG 4
Tourneo Connect		1.8	85	06.02 -	EYPC ZETEC-E SFI	4	1,0	TR5A-10	0005		LPG 4

**TRANSIT CONNECT I**

Transit Connect I	P65/P70/P80	1.8	55	06.02 -	BHPA Endura-DI	4	█	Y-524J	4520	27	
Transit Connect I	P65/P70/P80	1.8	66	06.02 -	HCPA Duratorq-TDCi	4	█	Y-524J	4520	27	
Transit Connect I	P65/P70/P80	1.8	66	06.02 -	HCPB Duratorq-TDCi	4	█	Y-524J	4520	27	
Transit Connect I	P65/P70/P80	1.8	81	06.02 -	RWPA Duratorq-TDCi	4	█	Y-524J	4520	27	
Transit Connect I	P65/P70/P80	1.8	85	06.02 -	EYPA ZETEC-E SFI	4	1,3	PTR5A-13	2467	25	LPG 4



Code *l* kW

Cyl.

Stock-No.  
**VEFINE**  
E-FORWERS\*

LPG/CNG

**FORD****TRANSIT CONNECT I**

Transit Connect I	P65/P70/P80	1.8	85	06.02 -	EYPC ZETEC-E SFI	4	1,0	TR5A-10	0005		LPG 4
-------------------	-------------	-----	----	---------	------------------	---	-----	---------	------	--	-------

**TRANSIT**

Transit '92		2.0	66	08.91 - 07.94	NBA OHC 2V	4	0,8	APR6FS	2922		
Transit '92		2.0	72	08.91 - 07.94	NCA OHC EFI	4	0,8	APR6FS	2922		
Transit '92		2.9	107	08.91 - 07.94	BRT V6 EFI	6	1,1	BCPR6ES-11	7121	11	LPG 3
Transit '95		2.0	84	08.94 - 07.00	NSF DOHC 8V SEFI	4	1,1	BKR7EIX-11	6988		BKR8EIX
Transit '95		2.0	84	08.94 - 07.00	NSG DOHC 8V SEFI	4	1,1	BKR7EIX-11	6988		BKR8EIX
Transit '95		2.0	84	08.94 - 07.00	NSH DOHC-8V SEFI	4	1,1	BKR7EIX-11	6988		BKR8EIX
Transit 2000.5 (Vorderradantrieb)		2.0	55	08.00 - 05.06	D3FA	4	█	Y-548J	94832	75	
Transit 2000.5 (Vorderradantrieb)		2.0	63	08.00 - 05.06	F3FA	4	█	Y-548J	94832	75	
Transit 2000.5 (Vorderradantrieb)		2.0	74	08.00 - 05.06	ABFA	4	█	Y-548J	94832	75	
Transit 2000.5 (Vorderradantrieb)		2.0	92	08.00 - 05.06	FIFA	4	█	Y-548J	94832	75	
Transit 2000.5 (Hinterradantrieb)		2.3	107	01.00 - 05.06	E5FA	4	1,1	PFR6B-11	4014		PFR7B
Transit 2000.5 (Hinterradantrieb)		2.3	107	01.00 - 05.06	E5FC	4	1,1	PFR6B-11	4014		PFR7B
Transit 2000.5 (Hinterradantrieb)		2.4	55	01.00 - 05.06	F4FA	4	█	Y-548J	94832	75	
Transit 2000.5 (Hinterradantrieb)		2.4	66	01.00 - 05.06	D2FA	4	█	Y-548J	94832	75	
Transit 2000.5 (Hinterradantrieb)		2.4	66	01.00 - 05.06	D2FB	4	█	Y-548J	94832	75	
Transit 2000.5 (Hinterradantrieb)		2.4	85	01.00 - 05.06	FXFA	4	█	Y-548J	94832	75	
Transit 2000.5 (Hinterradantrieb)		2.4	88	01.00 - 05.06	D4FA	4	█	Y-548J	94832	75	
Transit 2000.5 (Hinterradantrieb)		2.4	92	01.00 - 05.06	DOFA	4	█	Y-548J	94832	75	
Transit 2000.5 (Hinterradantrieb)		2.4	101	01.00 - 05.06	H9FA	4	█	Y-548J	94832	75	
Transit 2006.5 (Vorderradantrieb)		2.2	63	04.06 -	P8FA	4	█	Y-548J	94832	75	
Transit 2006.5 (Vorderradantrieb)		2.2	81	04.06 -	QVFA	4	█	Y-548J	94832	75	
Transit 2006.5 (Vorderradantrieb)		2.2	96	04.06 -	QWFA	4	█	Y-548J	94832	75	
Transit 2006.5 (Hinterradantrieb)		2.4	74	04.06 -	PHFA	4	█	Y-548J	94832	75	
Transit 2006.5 (Hinterradantrieb)		2.4	85	04.06 -	JXFA	4	█	Y-548J	94832	75	
Transit 2006.5 (Hinterradantrieb)		2.4	103	04.06 -	H9FB	4	█	Y-548J	94832	75	

**WINDSTAR**

Windstar		3.0	109	10.94 -	V6 SEFI	6	1,0	TR5	2238		LPG 5
----------	--	-----	-----	---------	---------	---	-----	-----	------	--	-------

**FORD (USA)****BRONCO**

Bronco		4.9		87 - 95	Y EFI	6	1,1	WR4-1	4652		
Bronco		5.0		85 - 96	N EFI	8	1,1	UR4	6630		UR5IX
Bronco		5.8		88 - 95	H EFI	8	1,3	UR5	2771		UR6IX
Bronco II		4.0		90 -	X EFI	6	1,5	TR55	3951		LPG 5

**GT**

GT		5.4	368	09.06 -		8	1,0	TR6	4177		LPG 5
----	--	-----	-----	---------	--	---	-----	-----	------	--	-------

**MUSTANG**

Mustang (Mexico)		3.0		06 -	V6 24V DOHC	6	1,5	TR55	3951		LPG 5
Mustang		3.8		03 -	V6	6	1,5	TR55	3951		LPG 5
Mustang		4.0		05 -	V6	6	1,1	TR5-1	7060		

**TAURUS**

Taurus		3.0		89 - 95	Y DOHC V6 SFI	6	1,1	PFR5G-11	2647		
Taurus		3.0		92 - 99	U OHV V6 SFI	6	1,0	TR5	2238		LPG 5
Taurus		3.0		96 - 99	N SHO V8 SFI	8	1,0	TR5	2238		LPG 5
Taurus		3.0		96 - 99	S DOHC V6 SFI	6	1,5	TR55	3951		LPG 5
Taurus		3.2		93 - 95	P SHO V6 SFI	6	1,1	PFR5G-11	2647		

**THUNDERBIRD**

Thunderbird		3.8		88 - 97	4 EFI V6 EFI	6	1,5	TR55-1	2683		
-------------	--	-----	--	---------	--------------	---	-----	--------	------	--	--

Code *l* kW

Cyl.



Stock-No.



LPG/CNG

**FORD (USA)  
THUNDERBIRD**

Thunderbird		3.8		89 - 95	R EFI V6 EFISupercharged	6	1,5	TR55-1	2683		
Thunderbird		3.9		03 -	A EFI V8 DOHC	8	1,0	FR5AP-11	5463		
Thunderbird		4.6		94 - 97	W EFI V8 SOHC	8	1,5	TR55	3951		LPG 5
Thunderbird		5.0		91 - 93	T EFI V8 H O	8	1,5	UR45	6945		UR5IX

**FSO**

126 BIS		0.7	19	87 -		4	0,8	BPR6ES	7822	2	LPG 2
Polonez		1.4	75	09.93 -	16DOHC Rover	4	0,8	BKR6ES	3783	28	LPG 1
Polonez		1.5	60	07.95 -	Cat.	4		BP6ET	1263		LPG 2
Polonez		1.6	64	05.87 -		4	0,7	BP6ES	7811	4	LPG 2
Polonez 1600		1.6	64	87 -		4	0,8	BP7ES	2412		BPR8EIX
Polonez		1.6	64	07.95 -	Cat.	4		BP6ET	1263		LPG 2
Polonez Caro D		1.9	51	10.92 -	XUD Kat.	4	█	Y-924J	7906	1	

**GAZ (VOLGA)**

Gazel		2.5	119	07 -	3M3-4052	4	0,9	BPR5ES	7422	6	LPG 2
Gazel Euro3		2.5	119	07 -	3M3-405.24	4	0,8	BKR5ES	2460	35	LPG 1
Gazel		2.7	105	07 -	3M3-409	4	0,9	BPR5ES	7422	6	LPG 2
Gazel Euro3		2.7	105	07 -	3M3-409.10	4	0,8	BKR5ES	2460	35	LPG 1
Sobol		2.5	119	07 -	3M3-4052	4	0,9	BPR5ES	7422	6	LPG 2
Sobol Euro3		2.5	119	07 -	3M3-405.24	4	0,8	BKR5ES	2460	35	LPG 1
Sobol		2.7	105	07 -	3M3-409	4	0,9	BPR5ES	7422	6	LPG 2
Sobol Euro3		2.7	105	07 -	3M3-409.10	4	0,8	BKR5ES	2460	35	LPG 1
Volga		2.7	105	07 -	3M3-409	4	0,9	BPR5ES	7422	6	LPG 2
Volga Euro3		2.7	105	07 -	3M3-409.10	4	0,8	BKR5ES	2460	35	LPG 1
Volga 31105-501		2.4	110	06 -	DCC		1,1	LZTR4A-11	5444		
Volga 3111		2.3	107	00 -	3M3-4062.10	4	0,9	BPR5ES	7422	6	LPG 2
Volga 3111		2.5	112	00 -	3M3-4052.10	4	0,9	BPR5ES	7422	6	LPG 2

**HOMMEL**

Berlinette RS 16V		2.0	123	98 -	XU10.J4RS	4		BKR6EK	2288	20	LPG 1
-------------------	--	-----	-----	------	-----------	---	--	--------	------	----	-------

**HONDA****ACCORD**

Accord 1,8 i /iLS	CE7	1.8	85	96 - 10.98	F18A3	4	1,1	ZFR6F-11	4291		LPG 6
Accord 1,8 iS	CG8	1.8	100	99 - 02.03	F18B2	4	1,1	ZFR6F-11	4291		LPG 6
Accord 2,0	CB3	2.0	66	90 - 05.93	F20A2 Cat.	4	1,1	ZFR6F-11	4291		LPG 6
Accord 2,0	CB3	2.0	66	90 - 05.93	F20A6	4	1,1	ZFR6F-11	4291		LPG 6
Accord TDi		2.0	77	05.95 - 08.99	Rover (L-Serie)	4	█	Y-730U	6704	17	
Accord Tdi	CF1	2.0	77	09.99 -	20TN2	4	█	Y-730U	6704	17	
Accord 2,0i	CC7	2.0	85	93 -	F30Z2	4	1,1	ZFR6F-11	4291		LPG 6
Accord 2,0 S,LS,ES	CC7	2.0	96	93 -	F20Z1	4	1,1	ZFR6F-11	4291		LPG 6
Accord 2,0i LS	CE8	2.0	96	95 -		4	1,1	ZFR6F-11	4291		LPG 6
Accord 2,0i LS/ES	CE8	2.0	96	96 -	F20Z1	4	1,1	ZFR6F-11	4291		LPG 6
Accord 2,0i 16V	CA5	2.0	98	88 -	B20A8 Cat.	4	1,1	BCPR6E-11	3132	11	LPG 3
Accord 2,0i	CB3	2.0	98	01.90 - 10.98	F20A4	4	1,1	ZFR6F-11	4291		LPG 6
Accord 2,0i	CB3	2.0	98	90 -	F20A8	4	1,1	ZFR6F-11	4291		LPG 6

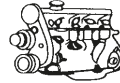
Code *l* kW

Cyl.



Stock-No.

VTEC  
E-POWER  
LPG/CNG**HONDA****ACCORD**

Accord 2,0i 16V EX	CA	2.0	101	87 -	B20A2	4	1,1	BCPR6EY-N-11	6262		LPG 3
Accord 2,0iLS / IES	CG9	2.0	108	99 - 02.03	F20B6	4	1,1	ZFR6F-11	4291		LPG 6
Accord 2,0i	CL7	2.0	114	10.02 -	K20A6	4	1,1	ZFR6K-11	6711		
Accord 2.0 Sport	CL7	2.0	114	10.02 -	K20A6	4	1,1	ZFR6K-11	6711		
Accord 2.0	CU1 / CW1	2.0	115	06.08 -	R20A3	4	1,1	IZFR6K11NS	9329		
Accord 2,2i (4WS)	CB7	2.2	110	90 - 05.03	F22A3	4	1,1	ZFR6F-11	4291		LPG 6
Accord 2,2i 16V	CE9	2.2	110	95 - 10.98		4	1,1	ZFR6F-11	4291		LPG 6
Accord 2,2i VTEC	CE9	2.2	110	95 - 10.98	F22Z2	4	1,1	ZFR6F-11	4291		LPG 6
Accord 2,2iR	CH1	2.2	156	99 - 02.03	H22A7	4	1,1	PZFR6F-11	3271		LPG 6
Accord 2,3 ES	CL3	2.3	113	01 - 05.03	F23Z5	4	1,1	ZFR6F-11	4291		LPG 6
Accord 2,3 SR	CC7	2.3	116	93 - 05.03	H23A3	4	1,1	ZFR6F-11	4291		LPG 6
Accord 2,4i	CL9	2.4	140	02.03 -	K24A3	4	1,1	IZFR6K11	6994		IZFR6K11
Accord 2.4 Sport	CL9	2.4	140	02.03 -	K24A3	4	1,1	IZFR6K11	6994		IZFR6K11
Accord 2.4	CU2	2.4	148	09 -	K24Z3	4	1,1	ILZKR7B11GS	7960		ILZKR7B11GS

**ACCORD AERO**

Accord Aero 2,0 EX	CA-53700C	2.0	75	87 -	A20A1 Cat. 5MT	4	1,1	BPR6EY-11	4228	10	LPG 2
Accord Aero 2,0 EX	CA-54700C	2.0	76	87 -	A20A1 Cat. 4AT	4	1,1	BPR6EY-11	4228	10	LPG 2
Accord Aero 2,0 EX	CA-53300C	2.0	78	86 -	A20A2	4	1,1	BPR6EY-11	4228	10	LPG 2
Accord Aero 2,0 EX	CA-54300C	2.0	78	86 -	A20A2	4	1,1	BPR6EY-11	4228	10	LPG 2
Accord Aero 2,0i EX	CA-53800C	2.0	85	87 -	A20A3 Cat.	4	1,1	BPR6EY-11	4228	10	LPG 2
Accord Aero 2,0i EX	CA-54800C	2.0	85	87 -	A20A3 Cat.	4	1,1	BPR6EY-11	4228	10	LPG 2
Accord Aero 2,0 Exi	CA-53400C	2.0	90	86 -	A20A4	4	1,1	BPR6EY-11	4228	10	LPG 2
Accord Aero 2,0 Exi	CA-54400C	2.0	90	86 -	A20A4	4	1,1	BPR6EY-11	4228	10	LPG 2
Accord Aero 2,0i	CC9	2.0	98	93 -	F20Z3	4	1,1	ZFR6F-11	4291		LPG 6
Accord Aero 2,0i LS,ES	CE2	2.0	100	94 -	F20B3	4	1,1	ZFR6F-11	4291		LPG 6
Accord Aero 2,2i	CB8	2.2	110	91 - 91	F22A7-F22A8	4	1,1	ZFR6F-11	4291		LPG 6
Accord Aero 2,2i LS,ES	CE1	2.2	110	94 - 10.98	F22B5	4	1,1	ZFR6F-11	4291		LPG 6

**ACCORD COUPE**

Accord Coupe 2,0	CC1	2.0	98	92 -	F20A7	4	1,1	ZFR6F-11	4291		LPG 6
Accord Coupe 2,0i ES / iLS	CG4	2.0	108	01.98 -	F20B5	4	1,1	ZFR6F-11	4291		LPG 6
Accord Coupe 2,2i	CD7	2.2	110	94 - 10.98	F22B5	4	1,1	ZFR6F-11	4291		LPG 6
Accord Coupe 3,0i V6	CG2	3.0	147	98 -	J30A1	6	1,1	ZFR5F-11	2262		LPG 6
Accord Tourer	CM1	2.0	114	04.03 -	K20A6	4	1,1	ZFR6K-11	6711		
Accord Tourer	CM2	2.4	140	04.03 -	K24A3	4	1,1	IZFR6K11	6994		IZFR6K11
Accord Tourer 2.4	CW2	2.4	148	09 -	K24Z3	4	1,1	ILZKR7B11GS	7960		ILZKR7B11GS

**CIVIC**

Civic 1.3	EC8	1.3	55	88 - 09.91	D13B1	4	1,1	BCPR6E-11	3132	11	LPG 3
Civic 1.3	EC8	1.3	55	90 - 95	D13B2 Cat.	4	1,1	BCPR6E-11	3132	11	LPG 3
Civic 1.3	EG3	1.3	55	92 - 95	D13B2	4	1,1	BKR6E-11	2756	14	LPG 1
Civic 1.3 IMA Hybrid	ES9	1.3	61	04 -	LDA1 Twinspark	4	1,1	IFR5G-11K	3107		IFR5G-11K
Civic 1.3i IMA Hybrid	ES9	1.3	66	03 -		4	1,1	IFR5G-11K	3107		IFR5G-11K
Civic 1.3 Hybrid	FD3	1.3	85	11.05 -	LDA	4	1,1	ILFR6J-11K	4458		ILFR6J-11K
Civic 1.4i	EJ9	1.4	55	96 - 02.01	D14A3	4	1,1	BKR6E-11	2756	14	LPG 1
Civic 1.4i	EJ9	1.4	55	99 - 02.01	D14Z1	4	1,1	ZFR5J-11	5584		LPG 6
Civic 1.4	FN / FK	1.4	61	06 -	L13A7 Twinspark	4	1,1	IFR6G-11K	1314		
Civic 1.4	EC9 / ED2	1.4	66	88 -	D14A1	4	1,1	BCPR6E-11	3132	11	LPG 3
Civic 1.4iS	EJ9	1.4	66	96 - 02.01	D14A4	4	1,1	BKR6E-11	2756	14	LPG 1
Civic 1.4iS	EJ9	1.4	66	99 - 12.05	D14Z2	4	1,1	ZFR5J-11	5584		LPG 6
Civic 1.4	EU7	1.4	66	03.01 - 09.05	D14Z6	4	1,1	ZFR5J-11	5584		LPG 6

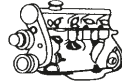
Code *l* kW

Cyl.



Stock-No.



LPG/CNG

**HONDA  
CIVIC**

Civic 1.4	FN4	1.4	74	09 -	L13Z1	4	1,3	IZFR6K13	6774		IZFR6K11
Civic 1.4		1.4		01.97 -	PIJ (SOHC)	4	1,1	ZFR5F-11	2262		LPG 6
Civic 1.4 i-VTEC	FB	1.4	73	02.12 -	L13Z4	4	1,3	IZFR6K13	6774		IZFR6K11
Civic 1.5i	ED6 / ED3	1.5	66	89 - 09.91	D15B2 Cat.	4	1,1	BCPR6E-11	3132	11	LPG 3
Civic 1.5 DXI/Lsi	EG4 / EG8	1.5	66	92 -	D15B2	4	1,1	BKR6E-11	2756	14	LPG 1
Civic 1.5 VEI	EG4	1.5	66	92 -	D15Z1	4	1,1	ZFR6F-11	4291		LPG 6
Civic 1.5i GT	AH-5330S	1.5	74	85 -	EW3	4	1,1	BPR6EY-11	4228	10	LPG 2
Civic 1.5i LS	EK3	1.5	84	96 -	D15Z6	4	1,1	ZFR6J-11	5585		LPG 6
Civic 1.5		1.5		97 -	VTi	4	1,1	BKR6EN-11	5724		
Civic 1.5 VTEC	P9L	1.5		01.97 - 02.01	D15Z8	4	1,1	ZFR5F-11	2262		LPG 6
Civic 1.6	ED4 / ED7	1.6	80	88 -	D16A6 Cat.	4	1,1	BCPR6E-11	3132	11	LPG 3
Civic 1.6	ED4 / ED7	1.6	81	90 - 01	D16Z2 Cat.	4	1,1	BCPR6E-11	3132	11	LPG 3
Civic 1.6	EU8	1.6	81	03.01 -	D16V1	4	1,1	ZFR6J-11	5585		LPG 6
Civic 1.6i ES	EK1	1.6	84	96 -	D16Y5	4	1,1	ZFR6J-11	5585		LPG 6
Civic 1.6 ESI	EG5 / EG9	1.6	92	92 -	D16Z6	4	1,1	BKR6E-11	2756	14	LPG 1
Civic 1.6 VTEC	EE9	1.6	110	90 -	B16A1	4	1,1	BKR6EN-11	5724		
Civic 1.6 VTI	EG6 / EG9	1.6	118	92 - 95	B16A2	4	1,1	BKR6E-11	2756	14	LPG 1
Civic 1.6 VTi	EK4	1.6	118	96 -	B16A2	4	1,1	BKR7EN-11	6256		
Civic Type R	EK9	1.6	148	- 12.01	B16B	4	1,1	PFR7G-11S	7772		
Civic 1.6		1.6		01.97 -	PIK(SOHC)	4	1,1	ZFR5F-11	2262		LPG 6
Civic 1.7 CTDi	EP4	1.7	74	02 -	4EE2	4		Y-541J	1983	42	
Civic 1.8 i-VTEC	FD1	1.8	103	09.05 -	R18A	4	1,1	IZFR6K-11S	5266		
Civic Type-R	EP3	2.0	147	08.01 - 06	K20A2	4	1,1	IFR7G-11KS	7746		IFR7G-11KS
Civic Type R	FN2	2.0	148	07 -	K20ZA	4	1,1	IFR7G-11KS	7746		IFR7G-11KS
Civic 1.4i 5Door	MA8	1.4	55	96 -	D14A5	4	1,1	BKR6E-11	2756	14	LPG 1
Civic 1.4i 5Door	MB2	1.4	55	97 -	D14A7	4	1,1	ZFR5F-11	2262		LPG 6
Civic 1.4i 5Door	MB2	1.4	55	99 -	D14Z3	4	1,1	ZFR5F-11	2262		LPG 6
Civic 1.4i 5Door	MA8	1.4	66	95 -	D14A2	4	1,1	BKR6E-11	2756	14	LPG 1
Civic 1.4 iS 5Door	MB2	1.4	66	97 -	D14A8	4	1,1	ZFR5F-11	2262		LPG 6
Civic 1.4iS 5Door	MB2	1.4	66	99 -	D14Z4	4	1,1	ZFR5F-11	2262		LPG 6
Civic 1.4 5Door	EU7	1.4	66	01 - 09.05	D14Z6 SOHC	4	1,1	ZFR5J-11	5584		LPG 6
Civic 1.4 5 Door		1.4			PIH	4	1,1	BKR6E-11	2756	14	LPG 1
Civic 1.5 VTEC-E 5Door	MA9	1.5	66	95 -	D15Z3	4	1,1	ZFR6F-11	4291		LPG 6
Civic 1.5 Vtec 5Door	MB3	1.5	85	97 -	D15Z8	4	1,1	ZFR5F-11	2262		LPG 6
Civic 1.6 Vtec 5Door	EU8	1.6	81	01 -	D16V1 SOHC	4	1,1	ZFR6J-11	5585		LPG 6
Civic 1.6LS 5Door	MB1	1.6	83	95 -	D16Y3	4	1,1	BKR6E-11	2756	14	LPG 1
Civic 1.6 LS 5Door	MB4	1.6	85	97 -	D16B2	4	1,1	ZFR5F-11	2262		LPG 6
Civic 1.6i/LS 5Door	MB4	1.6	85	99 -	D16W3	4	1,1	ZFR5F-11	2262		LPG 6
Civic 1.6SR VTEC 5Door	MB1	1.6	93	95 -	D16Y2	4	1,1	BKR6E-11	2756	14	LPG 1
Civic 1.6 5 Door		1.6			PIJ DOHC	4	1,1	BKR6E-11	2756	14	LPG 1
Civic 1.6 5 Door		1.6			PIK DOHC	4	1,1	BKR6E-11	2756	14	LPG 1
Civic 1.8 VTI 5Door	MB6	1.8	124	97 -	B18C4	4	1,1	BKR6EN-11	5724		
Civic 2.0i Sport	EV1	2.0	118	04 -	K20A3	4	1,1	ZFR6K-11	6711		
Civic 1.4i Aerodeck	MB8	1.4	55	98 -	D14A7	4	1,1	ZFR6F-11	4291		LPG 6
Civic 1.4iS Aerodeck	MB8	1.4	66	98 -	D14A8	4	1,1	ZFR6F-11	4291		LPG 6
Civic 1.5i VTEC Aerodeck	MB9	1.5	85	98 -	D15Z8	4	1,1	ZFR6F-11	4291		LPG 6
Civic 1.6i SR Aerodeck	MC1	1.6	85	98 -	D16B2	4	1,1	ZFR6F-11	4291		LPG 6
Civic 1.8i VTI Aerodeck	M18C4	1.8	124	98 -	B18C4	4	1,1	BKR7EN-11	6256		
<b>CIVIC VIII</b>											
Civic VIII 1.3 Hybrid	FD3	1.3	85	11.05 -	LDA	4	1,1	ILFR6J-11K	4458		



Code *l* kW

Cyl.



Stock-No.

VTEC  
i-POWER  
LPG/CNG**HONDA****CIVIC VIII**

Civic VIII 1.4	FN/FK	1.4	61	01.06 -	L13A7 Twinspark	4	1,1	IFR6G-11K	1314		
Civic VIII 1.4	FN4	1.4	73	10.08 -	L13Z1	4	1,3	IZFR6K13	6774		
Civic VIII 1.8	FK2	1.8	103	01.06 -	R18A2	4	1,1	IZFR6K-11S	5266		
Civic VIII 2.0 Type R	FN2	2.0	148	09.06 -	K20Z4	4	1,1	IFR7G-11KS	7746		

**CIVIC IX**

Civic IX 1.4 i-VTEC	FK	1.4	73	02.12 -	L13Z4	4	1,3	IZFR6K13	6774		
---------------------	----	-----	----	---------	-------	---	-----	----------	------	--	--

**CIVIC COUPÉ**

Civic Coupé 1,5i/Lsi	EJ2	1.5	74	94 -	D15B7	4	1,1	ZFR6F-11	4291		LPG 6
Civic Coupé 1,6 LS	EJ6	1.6	77	96 - 98	D16Y7	4	1,1	BKR6E-11	2756	14	LPG 1
Civic Coupé 1,6 LS	EJ6	1.6	77	96 - 98	D16Y7	4	1,1	BKR6E-11	2756	14	LPG 1
Civic Coupé 1,6iLS	EJ6	1.6	77	99 -	D16Y7	4	1,1	ZFR5F-11	2262		LPG 6
Civic Coupé 1,6 Esi	EJ1	1.6	92	94 -	D16Z9	4	1,1	BKR6E-11	2756	14	LPG 1
Civic Coupé 1,6i SR	EJ8	1.6	92	96 - 98	D16Y8	4	1,1	BKR6E-11	2756	14	LPG 1
Civic Coupé 1,6i SR	EJ8	1.6	92	96 -	D16Y8	4	1,1	BKR6E-11	2756	14	LPG 1
Civic Coupé 1,6 SR	EJ8	1.6	92	99 -	D16Y8	4	1,1	ZFR5F-11	2262		LPG 6
Civic Coupé 1,7 LS	EM2	1.7	88	01 -	D17A8	4	1,1	ZFR6J-11	5585		LPG 6
Civic Coupé 1,7 ES	EM2	1.7	92	01 -	D17A9	4	1,1	ZFR6J-11	5585		LPG 6

**CIVIC SHUTTLE**

Civic Shuttle 1,6i	EE	1.6	80	88 -	D16A6 Cat.	4	1,1	BCPR6E-11	3132	11	LPG 3
Civic Shuttle 1,6i	EE	1.6	81	88 -	D16Z2 Cat.	4	1,1	BCPR6E-11	3132	11	LPG 3

**CONCERTO**

Concerto 1,5i	HW	1.5	66	90 - 95	D15B2 Cat.	4	1,1	BCPR6E-11	3132	11	LPG 3
Concerto 1,6i	HW	1.6	82	90 - 95	D16Z2 SOHC Cat.	4	1,1	BCPR6E-11	3132	11	LPG 3
Concerto 1,6-16V	HW	1.6	90	90 - 95	D16A8 DOHC	4	1,1	BCPR6E-11	3132	11	LPG 3
Concerto TD	HW	1.8	64	10.94 - 12.95	XUD 7 TE	4		Y-924J	7906	1	

**CR-V**

CR-V 2.0	RD1	2.0	94	05.97 -	B20B3	4	1,1	ZFR5F-11	2262		LPG 6
CR-V 2.0	RD1	2.0	108	03.99 -	B20Z1	4	1,1	ZFR6F-11	4291		LPG 6
CR-V 2.0	RD8	2.0	110	02 -	K20A4	4	1,1	ZFR6K-11	6711		
CR-V 2.0	RE5	2.0	110	07 -	R20A2	4	1,1	IZFR6K-11S	5266		

**CRX**

CRX 1.6i-16	ED9	1.6	91	89 -	D16Z5 Cat.	4	1,1	BCPR6E-11	3132	11	LPG 3
CRX 1.6	EH6	1.6	92	92 -	D16Z6	4	1,1	BKR6E-11	2756	14	LPG 1
CRX 1.6i-16	ED9	1.6	96	88 -	D16A9	4	1,1	BCPR6E-11	3132	11	LPG 3
CRX 1.6 VTEC	EE8	1.6	110	90 -	B16A1	4	1,1	BKR6EN-11	5724		
CRX 1.6	EG2	1.6	118	92 -	B16A2	4	1,1	BKR6EN-11	5724		

**CR-Z**

CR-Z 1.5 Hybrid		1.5	84	02.10 -	LEA1	4	1,3	DIFR6D13	94167		
-----------------	--	-----	----	---------	------	---	-----	----------	-------	--	--

**FR-V**

FR-V 1.7	BE1	1.7	92	01.05 -	D17A2 SOHC VTEC	4	1,1	ZFR6J-11	5585		LPG 6
FR-V 1.8	BE1	1.8	103	01.07 -	R18A1	4	1,1	IZFR6K-11S	5266		
FR-V 2.0	BE3	2.0	110	01.05 -	K20A9 DOHC i-VTEC	4	1,1	ZFR6K-11	6711		

**HR-V**

HR-V 1.6	GH2	1.6	77	02.99 -	D16W1	4	1,1	ZFR5J-11	5584		LPG 6
HR-V 1.6 VTEC	GH2	1.6	91	10.99 -	VTEC	4	1,1	ZFR5J-11	5584		LPG 6

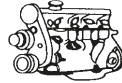
Code *l* kW

Cyl.



Stock-No.



LPG/CNG

**HONDA INSIGHT**

Insight	ZE2	1.3	65	04.09 -	LDA3 L4	4	1,1	DILFR6J11	92491		DILFR6J11
---------	-----	-----	----	---------	---------	---	-----	-----------	-------	--	-----------

**INTEGRA**

Integra Type-R 16V		2.0	162	02.02 -	K20A	4	1,1	IFR7G-11KS	7746		IFR7G-11KS
Integra R	DC2	1.8	140	10.97 - 99	B18C6	4	1,1	PFR7G-11	2380		PFR7G
Integra R	DC2	1.8	140	99 - 01	B18C6	4	1,1	PFR7G-11	2380		PFR7G

**JAZZ**

Jazz 1,2 i-DSI		1.2	57	02 -	TwinSpark	4	1,1	BKR6E-11	2756	14	LPG 1
Jazz 1,2	GD5	1.2	57	03 -	L12A1 TwinSpark	4	1,1	BKR6E-11	2756	14	LPG 1
Jazz 1,2 CHAC	GE2	1.2	57	06 -	L12A4	4	1,1	BKR6E-11	2756	14	LPG 1
Jazz 1,2	GG1	1.2	66	07.08 -	L12B1	4	1,3	DIFR6D13	94167		
Jazz 1,3 CHAC	GE3	1.3	61	06 -	L13A6	4	1,1	BKR6E-11	2756	14	LPG 1
Jazz 1,4	GD1	1.4	61	02 -	L13A1 TwinSpark	4	1,1	BKR6E-11	2756	14	LPG 1
Jazz 1,4 CHAC	GE3	1.4	61	06 -	L13A6	4	1,1	BKR6E-11	2756	14	LPG 1
Jazz 1,4 Hybrid	GP1	1.4	65	04.11 -	LDA3	4	1,1	DILFR6J11	92491		DILFR6J11
Jazz 1,4	GE6	1.4	74	09 -	L13Z1	4	1,3	IZFR6K13	6774		IZFR6K11

**LEGEND**

Legend V6 2,5i	HS..N	2.5	110	87 -	C25A1 Cat.	6	1,1	BCPR6E-11	3132	11	LPG 3
Legend V6 2,5i	HS..Y	2.5	110	87 -	C25A1 Cat.	6	1,1	BCPR6E-11	3132	11	LPG 3
Legend V6 2,5i	HS..N	2.5	127	87 -	C25A1	6	1,1	BCPR6E-11	3132	11	LPG 3
Legend V6 2,5i	HS..Y	2.5	127	87 -	C25A1	6	1,1	BCPR6E-11	3132	11	LPG 3
Legend 2,7i	HS / KA4	2.7	124	88 - 02.91	C27A1 Cat.	6	1,1	BCPR6E-11	3132	11	LPG 3
Legend 3,2	KA7 / KA8	3.2	151	91 - 96	C32A2	6	1,1	PFR6G-11	5555		PFR7G
Legend 3,2	KA7 / KA8	3.2	151	93 - 96	C32A2	6	1,1	PFR6G-11	5555		PFR7G
Legend 3,5 V6		3.5	151	95 - 04	C35A2	6	1,1	PFR6G-11	5555		PFR7G
Legend 3,5 V6	KA9	3.5	151	96 - 04	C35A5	6	1,1	PFR6G-11	5555		PFR7G
Legend 3,5 SH-AWD	KB1	3.5	217	06 -	J35A8	6	1,1	IZFR6K11	6994		IZFR6K11
Legend 3,5 V6	KB1	3.5	217	07 -	J35A8	6	1,1	IZFR6K11	6994		IZFR6K11
Legend Coupe 2,7i	KA3	2.7	124	88 -	C27A1 Cat.	6	1,1	BCPR6EY-N-11	6262		LPG 3

**LOGO**

Logo 1,3 i		1.3	48	99 - 01	D13B7	4	1,1	ZFR5J-11	5584		LPG 6
------------	--	-----	----	---------	-------	---	-----	----------	------	--	-------

**NSX**

NSX	NA1	3.0	188	91 - 01.05	C30A3/C30A4	6	1,1	PFR6G-11	5555		PFR7G
NSX	NA2	3.2	206	01.97 - 09.05	C32B2	6	1,1	PFR6G-11	5555		PFR7G

**PRELUDE**

Prelude 1,8	AB-7230C	1.8	74	83 - 92	ET	4	0,8	BPR6EY	6427		LPG 2
Prelude 1,8	AB-5240C	1.8	74	85 - 92	ET2	4	1,1	BPR6EY-11	4228	10	LPG 2
Prelude 1,8	AB-5220C	1.8	77	83 - 92	ET	4	0,8	BPR6EY	6427		LPG 2
Prelude 1,8	AB-5230C	1.8	77	83 - 92	ET	4	0,8	BPR6EY	6427		LPG 2
Prelude 2,0	BA4	2.0	80	88 - 01.92	B20A3 Cat.	4	1,1	BCPR6EY-N-11	6262		LPG 3
Prelude 2,0	BA4	2.0	80	90 - 01.92	B20A3 Cat.	4	1,1	BCPR6EY-N-11	6262		LPG 3
Prelude 2,0	BA4	2.0	84	88 - 01.92	B20A4	4	1,1	BCPR6EY-N-11	6262		LPG 3
Prelude 2,0	BB3	2.0	98	92 - 12.99	F20A4	4	1,1	ZFR6F-11	4291		LPG 6
Prelude 2,0		2.0	98	97 - 12.99		4	1,1	ZFR6F-11	4291		LPG 6
Prelude 2,0 i	BB9	2.0	98	99 - 12.99	F20A4	4	1,1	ZFR6F-11	4291		LPG 6
Prelude 2,0i 16V	BA2-1300C	2.0	101	86 - 92	BA20A1 DOHC	4	1,1	BCPR6E-11	3132	11	LPG 3
Prelude 2,0 16V 4WS	BA4	2.0	101	88 - 01.92	B20A5 Cat.	4	1,1	BCPR6EY-N-11	6262		LPG 3
Prelude 2,0 16V 4WS	BA4	2.0	103	90 - 01.92	B20A9 Cat.	4	1,1	BCPR6EY-N-11	6262		LPG 3
Prelude 2,2 VTEC	BB1	2.2	136	93 - 09.96	H22A2	4	1,1	PZFR6F-11	3271		LPG 6
Prelude 2,2i		2.2	136	97 - 12.01	H22A5	4	1,1	PZFR6F-11	3271		LPG 6

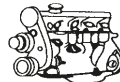
Code *l* kW

Cyl.



Stock-No.

V-TUNE

E-POWER

LPG/CNG

**HONDA****PRELUDE**

Prelude 2,2 Vti	BB6 / BB8	2.2	136	99 - 12.01	H22A5	4	1,1	PZFR6F-11	3271		LPG 6
Prelude 2,3	BB2	2.3	118	92 - 09.96	H23A2	4	1,1	ZFR6F-11	4291		LPG 6

**S 2000**

S 2000	AP1	2.0	177	06.00 -	F20C2	4	1,1	PFR7G-11S	7772		
--------	-----	-----	-----	---------	-------	---	-----	-----------	------	--	--

**SHUTTLE**

Shuttle 1.5	AN-3520S	1.5	63	84 -	EW2	4	1,1	BPR6EY-11	4228	10	LPG 2
Shuttle 1.5	AN-5520S	1.5	63	84 -	EW2	4	1,1	BPR6EY-11	4228	10	LPG 2
Shuttle 1.5 4WD	AR-6520C	1.5	63	85 -	EW2	4	1,1	BPR6EY-11	4228	10	LPG 2
Shuttle 2,2i ES		2.2	110	95 - 12.97	F22 RA1 (AT)	4	1,1	ZFR6F-11	4291		LPG 6
Shuttle 2,3	RA3	2.3	110	98 - 05.01	F23A7	4	1,1	ZFR6F-11	4291		LPG 6

**STREAM**

Stream 1.7	RN1	1.7	92	04.01 -	D17A2	4	1,1	ZFR6J-11	5585		LPG 6
Stream 2.0	RN3	2.0	115	04.01 -	K20A1	4	1,1	ZFR6K-11	6711		

**HUMMER-AM GENERAL**

Hummer H 3		3.4	162	05 -		5	1,3	PTR5A-13	2467	25	LPG 4
Hummer		5.7		94 - 96	D EFI V8	8	1,3	UR5	2771		UR6IX
Hummer H 2		6.0		03 - 06	N EFI V8	8	1,0	TR5	2238		
Hummer		8.1		03 -	G EFI V8	8	1,5	PZTR5A-15	7862		PZTR5A-15

**HYUNDAI****ACCENT**

Accent		1.3	44	10.94 - 99	G4EH	4	1,1	BKR5ES-11	2382	33	LPG 1
Accent		1.3	55	10.94 - 99	G4EH	4	1,1	BKR5ES-11	2382	33	LPG 1
Accent/LC		1.3	55	99 - 03.06	G4EA	4	1,1	BKR5ES-11	2382	33	LPG 1
Accent/LC		1.3	64	99 - 03.06	G4EA	4	1,1	BKR5ES-11	2382	33	LPG 1
Accent 1.4		1.4	71	06.06 -	G4EE	4	1,1	BKR5ES-11	2382	33	LPG 1
Accent TDI		1.5	55	04.02 -		3		Y-749J	5013		
Accent 12V CRDi		1.5	60	04.02 -	D3EA	3		Y-749J	5013		
Accent		1.5	65	10.94 - 07.99	G4EK	4	1,1	BKR5ES-11	2382	33	LPG 1
Accent/LC		1.5	66	01.00 - 06	G4EB	4	1,1	BKR5ES-11	2382	33	LPG 1
Accent/LC 16V		1.5	75	99 - 06	G4EA	4	1,1	BKR5ES-11	2382	33	LPG 1
Accent III 1.5 CRDi (MC)		1.5	81	11.05 -	D4FA	4		Y-527J	96187	67	
Accent GT 16V		1.5		95 - 07.99	G4EK	4	1,1	BKR5ES-11	2382	33	LPG 1
Accent 1.6 (MC)		1.6	82	06.06 -	G4ED	4	1,1	BKR5ES-11	2382	33	LPG 1
Amica		1.0		00 -		4	1,1	BKR5E-11	6953	33	LPG 1
Atos / MX		1.0	40	99 - 02	G4HC	4	1,1	BKR5ES-11	2382	33	LPG 1
Atos Prime		1.0	40	99 - 02	G4HC	4	1,1	BKR5ES-11	2382	33	LPG 1
Atos		1.1	46	03.04 -		4	1,1	BKR5ES-11	2382	33	LPG 1

**COUPE**

Coupe 1.6	RD	1.6	84	12.96 - 04.02	4G61	4	1,1	BKR5ES-11	2382	33	LPG 1
Coupe 2.0		2.0	99	01 -	G4GF-EG	4	1,1	BKR5ES-11	2382	33	LPG 1
Coupe 2.0		2.0	102	03.96 - 09.01	G4GF DOHC	4	1,1	BKR5ES-11	2382	33	LPG 1
Coupe 2.0		2.0	102	99 -	G4GC	4	1,1	BPR5ES-11	4424		LPG 2
Coupe 2.0	GK	2.0	105	03.02 -	G4GC-G	4	1,1	BKR5ES-11	2382	33	LPG 1
Coupe 2.7 V6	GK	2.7	121	03.02 -	G6BA-G V6	6	1,1	PFR5J-11	4642		

**ELANTRA**

Elantra 1.5	XD	1.5		- 02.95	DOHC	4	1,1	BPR6ES-11	4824	13	LPG 2
-------------	----	-----	--	---------	------	---	-----	-----------	------	----	-------

Code *l* kW

Cyl.



Stock-No.



100% POWER

LPG/CNG

**HYUNDAI ELANTRA**

Elantra 1.5	XD	1.5		03.95 - 06.05		4	1,1	BKR5E-11	6953	33	LPG 1
Elantra 1.6	XD	1.6	79	00 -	G4ED-G DOHC	4	1,1	BKR5ES-11	2382	33	LPG 1
Elantra 1.6 CRDi	XD	1.6	85	02.06 -	D4FB	4	█	Y-527J	96187	67	
Elantra 1.6	XD	1.6		- 99	DOHC	4	1,1	BPR6ES-11	4824	13	LPG 2
Elantra 1.8	XD	1.8			DOHC	4	1,1	BPR6ES-11	4824	13	LPG 2
Elantra 2.0 CRDi	XD	2.0	83	01 -	D4EA	4	█	Y-749J	5013		
Elantra 2.0	XD	2.0	102	00 -	G4GC-G DOHC	4	1,1	BKR5ES-11	2382	33	LPG 1
Elantra 2.0	XD	2.0	105	03 -		4	1,1	BKR5E-11	6953	33	LPG 1

**GALLOPER**

Galopper		2.5	57	- 01.94	4D55	4	█	Y-115T1	2189		
Galopper TC,TCI		2.5	65	11.95 -	4D56	4	█	CY57	4994	21	
Galopper TD 3/5p GLS, Inovation		2.5	74	01.99 -		4	█	CY57*	4994	21	
Galopper		3.0	104	08.98 - 08.01	G6AT Unleaded	6	1,1	BPR5ES-11	4424		LPG 2
Galopper		3.0	104	08.98 -	Leaded+LPG	6	0,9	BPR5ES	7422	6	LPG 2
Galopper		3.0		98 - 08.01	G6AT SOHC V6	6	1,1	BKR5ES-11	2382	33	LPG 1

**GETZ**

Getz 1.1	TB	1.1	46	09.02 - 08	G4HD	4	1,1	BKR5ES-11	2382	33	LPG 1
Getz 1.3	TB	1.3	60	09.02 - 08	G4EA	4	1,1	BKR5ES-11	2382	33	LPG 1
Getz 1.4	TB	1.4	71	05 - 08	G4EE	4	1,1	BKR5ES-11	2382	33	LPG 1
Getz 1.5 CRDi	TB	1.5	60	02.03 - 07.05	D3EA	3	█	Y-749J	5013		
Getz 1.5 CRDi	TB	1.5	60	08.05 - 10.06	D3EA	3	█	Y-527J	96187	67	
Getz 1.5 CRDi	TB	1.5	65	11.06 -	D4FA	4	█	Y-527J	96187	67	
Getz 1.5 CRDi	TB	1.5	81	11.06 -	D4FA	4	█	Y-527J	96187	67	
Getz 1.6	TB	1.6	78	09.02 -	G4ED	4	1,1	BKR5ES-11	2382	33	LPG 1

**GRANDEUR**

Grandeur 3.3 V6	TG	3.3	173	08.05 -	G6DB	6	1,1	IFR5G11	7854		
-----------------	----	-----	-----	---------	------	---	-----	---------	------	--	--

**H 1**

H 1		2.4	85	09.97 -	H100	4	1,1	BPR6ES-11	4824	13	LPG 2
H 1 Starex TD		2.5	59	10.97 -	D4BF	4	█	Y-722JS	9974		
H 1 TD		2.5	59	03.00 - 09.00	D4BF	4	█	Y-722JS	9974		
H 1 TD		2.5	73	03.00 -	D4BH	4	█	Y-722JS	9974		
H 1 Starex		2.4	82	98 -	G4CS	4	1,1	BPR6ES-11	4824	13	LPG 2

**H 100**

H 100 D intercooler		2.5	63	07.93 - 03.00	D4BF	4	█	Y-722JS	9974		
H 100 i		2.4	84	01.97 -		4	1,1	BP6EY-11	4128		LPG 2

**I10**

i10 1.1	PA	1.1	49	01.08 -	G4HG	4	1,1	BKR5ES-11	2382	33	LPG 1
i10 1.1	PA	1.1	51	04.11 -	G4HG	4	1,1	BKR5ES-11	2382	33	LPG 1
i10 1.1 CRDi	PA	1.1	55	03.08 -	D3FA	3	█	Y-527J	96187	67	
i10 1.2	PA	1.2	57	11.08 -	G4LA	4	0,8	PLKR7A	4288		
i10 1.2	PA	1.2	63	04.11 -	G4LA	4	0,8	PLKR7A	4288		

**I20**

i20 1.2	PB	1.2	57	09.08 -	G4LA	4	0,8	PLKR7A	4288		
i20 1.4 CRDi	PB	1.4	55	12.08 -	D4FC	4	█	Y-527J	96187	67	
i20 1.4 CRDi	PB	1.4	66	05.09 -	D4FC	4	█	Y-527J	96187	67	
i20 1.4	PB	1.4	74	09.08 - 01.09	G4FA	4	1,1	ZFR5F-11	2262		LPG 6
i20 1.4	PB	1.4	74	02.09 -	G4FA	4	1,0	LZKR6B-10E	1578		



Code *l* kW

Cyl.



Stock-No.

V-TUNE

E-Power

LPG/CNG

**HYUNDAI****I20**

i20 1.6 CRDi		1.6	85	12.08 -	D4FB	4	█	Y-527J	96187	67	
i20 1.6		1.6	93	09.08 -	G4FC	4	1,1	ZFR5F-11	2262		LPG 6

**I30 1**

i30 I 1.4	FD	1.4	77	10.07 - 01.09	G4FA	4	1,1	ZFR5F-11	2262		LPG 6
i30 I 1.4	FD	1.4	77	02.09 -	G4FA	4	1,0	LZKR6B-10E	1578		
i30 I 1.4	FD	1.4	80	06.07 - 01.09	G4FA	4	1,1	ZFR5F-11	2262		LPG 6
i30 I 1.4	FD	1.4	80	02.09 -	G4FA	4	1,0	LZKR6B-10E	1578		
i30 I 1.6 CRDi	FD	1.6	66	10.07 -	D4FB	4	█	Y-527J	96187	67	
i30 I 1.6	FD	1.6	85	10.07 - 01.09	G4FC	4	1,1	ZFR5F-11	2262		LPG 6
i30 I 1.6 CRDi	FD	1.6	85	10.07 -	D4FB	4	█	Y-527J	96187	67	
i30 I 1.6	FD	1.6	85	02.09 -	G4FC	4	1,0	LZKR6B-10E	1578		
i30 I 1.6	FD	1.6	90	06.07 - 01.09	G4FC	4	1,1	ZFR5F-11	2262		LPG 6
i30 I 1.6	FD	1.6	90	02.09 -	G4FC	4	1,0	LZKR6B-10E	1578		
i30 I 1.6	FD	1.6	93	02.08 - 01.09	G4FC	4	1,1	ZFR5F-11	2262		LPG 6
i30 I 1.6	FD	1.6	93	02.09 -	G4FC	4	1,0	LZKR6B-10E	1578		
i30 I 1.6 CRDi	FD	1.6	94	02.08 -	D4FB	4	█	Y-527J	96187	67	
i30 I 1.6 GDI	FD	1.6	99	11.11 -	G4FD	4	1,0	SILZKR6B10E	93815		
i30 I 2.0 CRDi	FD	2.0	103	07.07 -	D4EA	4	█	Y-749J	5013		
i30 I 2.0	FD	2.0	105	07.07 -	G4GC	4	1,1	BKR5ES-11	2382	33	LPG 1

**I30 2**

i30 II 1.4	GD	1.4	73	11.11 -	G4FA	4	1,0	LZKR6B-10E	1578		
i30 II 1.6	GD	1.6	88	01.12 -	G4FD	4	1,0	SILZKR6B10E	93815		
i30 II 1.6 GDI	GD	1.6	95	11.11 -	G4FD	4	1,0	SILZKR6B10E	93815		
i30 II 1.6 GDI	GD	1.6	99	11.11 -	G4FD	4	1,0	SILZKR6B10E	93815		
i30 II 1.4 CRDi	GD	1.4	66	11.11 -	D4FC	4	█	Y-527J	96187	67	
i30 II 1.6 CRDi	GD	1.6	81	11.11 -	D4FB	4	█	Y-527J	96187	67	
i30 II 1.6 CRDi	GD	1.6	94	11.11 -	D4FB	4	█	Y-527J	96187	67	

**I30 CW 1**

i30 CW I 1.4		1.4	80	06.09 -	G4FA	4	1,0	LZKR6B-10E	1578		
i30 CW I 1.6		1.6	85	02.08 - 01.09	G4FC	4	1,1	ZFR5F-11	2262		LPG 6
i30 CW I 1.6		1.6	85	02.09 -	G4FC	4	1,0	LZKR6B-10E	1578		
i30 CW I 1.6		1.6	90	02.08 - 01.09	G4FC	4	1,1	ZFR5F-11	2262		LPG 6
i30 CW I 1.6		1.6	90	02.09 -	G4FC	4	1,0	LZKR6B-10E	1578		
i30 CW I 1.6		1.6	93	02.08 - 01.09	G4FC	4	1,1	ZFR5F-11	2262		LPG 6
i30 CW I 1.6		1.6	93	02.09 -	G4FC	4	1,0	LZKR6B-10E	1578		
i30 CW I 1.6 CRDi		1.6	94	02.08 -	D4FB	4	█	Y-527J	96187	67	
i30 CW I 1.6 GDI		1.6	99	11.11 -	G4FD	4	1,0	SILZKR6B10E	93815		
i30 CW I 2.0		2.0	105	02.08 -	G4GC	4	1,1	BKR5ES-11	2382	33	LPG 1

**I40**

i40 1.6	VF	1.6	99	07.11 -	G4FD	4	1,0	SILZKR6B10E	93815		
i40 1.7 CRDi	VF	1.7	85	06.11 -	D4FD	4	█	CZ203	95232	68	
i40 1.7 CRDi	VF	1.7	100	06.11 -	D4FD	4	█	CZ203	95232	68	

**IX20**

ix20 1.4 CRDi	JC	1.4	57	11.10 -	D4FC	4	█	Y-527J	96187	67	
ix20 1.4	JC	1.4	66	11.10 -	G4FA	4	1,0	LZKR6B-10E	1578		
ix20 1.4 CRDi	JC	1.4	66	11.10 -	D4FC	4	█	Y-527J	96187	67	
ix20 1.6 CRDi	JC	1.6	85	11.10 -	D4FB	4	█	Y-527J	96187	67	
ix20 1.6	JC	1.6	92	11.10 -	G4FC	4	1,0	LZKR6B-10E	1578		

Code *l* kW

Cyl.



Stock-No.



LPG/CNG

**HYUNDAI****IX35**

ix35 1.6	LM	1.6	99	09.10 -	G4FD	4	1,0	SILZKR6B10E	93815		
ix35 1.7 CRDi	LM	1.7	85	09.10 -	D4FD	4	█	CZ203	95232	68	
ix35 2.0	LM	2.0	120	08.09 -	G4KD	4	1,1	LFR5A-11	6376		LPG 7
ix35 2.0 CRDi Euro III / Euro IV	LM	2.0	100	08.09 -	D4HA	4	█	Y1003AS	92283		
ix35 2.0 CRDi Euro V	LM	2.0	100	08.09 -	D4HA	4	█	CZ105	90007		
ix35 2.0 CRDi Euro III / Euro IV	LM	2.0	135	08.09 -	D4HA	4	█	Y1003AS	92283		
ix35 2.0 CRDi Euro V	LM	2.0	135	08.09 -	D4HA	4	█	CZ105	90007		

**LANTRA**

Lantra 1 1.5	J-1	1.5	63	92 - 04.95	G4DJ	4	1,1	BPR6ES-11	4824	13	LPG 2
Lantra 2 1.6	J-2	1.6	66	09.95 - 09.00	G4GR	4	1,1	BKR5ES-11	2382	33	LPG 1
Lantra 1 1.6	J-1	1.6	78	92 - 04.95	G4CR	4	1,1	BPR6ES-11	4824	13	LPG 2
Lantra 3 1.6		1.6	79	09.00 -	G4ED-G DOHC	4	1,1	BKR5ES-11	2382	33	LPG 1
Lantra 2 1.6	J-2	1.6	84	09.95 - 09.00	G4GR	4	1,1	BKR5ES-11	2382	33	LPG 1
Lantra 1 1.8	J-1	1.8	93	92 - 04.95	G4CN	4	1,1	BPR6ES-11	4824	13	LPG 2
Lantra 2 1.8	J-2	1.8	94	09.95 - 09.00	G4GM	4	1,1	BKR5ES-11	2382	33	LPG 1
Lantra 2 1.9 D		1.9	50	98 -	XUD9A	4	█	Y-924J	7906	1	
Lantra 3 2.0		2.0	101	09.00 -	G4GC-G DOHC	4	1,1	BKR5ES-11	2382	33	LPG 1
Lantra 2 2.0	J-2	2.0	102	02.97 - 00		4	1,1	BKR5ES-11	2382	33	LPG 1

**MATRIX**

Matrix 1.5 CRDi	FC	1.5	60	10.01 - 02.05	D3EA	3	█	Y-749J	5013		
Matrix 1.5 CRDi	FC	1.5	75	12.04 -	D4FA	4	█	Y-527J	96187	67	
Matrix 1.5 CRDi VGT	FC	1.5	81	08.05 -	D4FA	4	█	Y-527J	96187	67	
Matrix 1.6	FC	1.6	76	08.01 -	G4ED	4	1,1	BKR5ES-11	2382	33	LPG 1
Matrix 1.8	FC	1.8	90	08.01 -	G4GB	4	1,1	BKR5ES-11	2382	33	LPG 1
Matrix 1.8	FC	1.8	98	07.01 -	G4GB	4	1,1	BKR5ES-11	2382	33	LPG 1

**PONY/EXEL**

Pony/Exel		1.3		85 - 94	G13B/G4DG	4	1,1	BPR6ES-11	4824	13	LPG 2
Pony/Exel		1.5		85 - 94	G15B/G4DJ	4	1,1	BPR6ES-11	4824	13	LPG 2
Pony/Exel		1.5		85 - 94	G15B/G4DJ Cat.	4	1,1	BPR6ES-11	4824	13	LPG 2

**S COUPÉ**

S Coupe N/A	SLC	1.5	65	04.92 - 05.96	G4EK	4	1,1	BKR5ES-11	2382	33	LPG 1
S Coupe Turbo Charge	SLC	1.5	85	04.91 - 05.98	G4EK-TC	4	0,8	BKR6ES	3783	28	LPG 1
S Coupe	SLC	1.5		92 -	G15B	4	1,1	BKR5ES-11	2382	33	LPG 1
S Coupe Turbo	SLC	1.5		92 -		4	0,8	BKR6ES	3783	28	LPG 1

**SANTA FE 1**

Santa Fe I 2.0 CRDi	SM	2.0	83	04.01 - 05	D4EA	4	█	Y-749J	5013		
Santa Fe I 2.0 CRDi 4x4	SM	2.0	92	08.03 -	D4EA	4	█	Y-749J	5013		
Santa Fe I 2.0	SM	2.0	99	08.01 - 03.06	G4BP	4	1,1	BPR6ES-11	4824	13	LPG 2
Santa Fe I 2.2 CRDi	SM	2.2	102	03.06 -	D4EB	4	█	Y-749J	5013		
Santa Fe I 2.2 CRDi	SM	2.2	110	10.05 -	D4EB	4	█	Y-749J	5013		
Santa Fe I 2.2 CRDi	SM	2.2	114	03.06 -	D4EB	4	█	Y-749J	5013		
Santa Fe I 2.4	SM	2.4	107	02.01 - 05	G4JS-G	4	1,1	PGR5C-11	5760		
Santa Fe I 2.7	SM	2.7	127	08.00 - 12.05	G6BA-G	6	1,1	PFR5N-11	5838		

**SANTA FE 2**

Santa Fe II 2.0 CRDi Euro IV	CM	2.0	110	12.10 - 12.12	D4HA	4	█	Y1003AS	92283		
Santa Fe II 2.0 CRDi Euro V	CM	2.0	110	12.10 - 08.12	D4HA	4	█	CZ105	90007		
Santa Fe II 2.4	CM	2.4	128	11.10 - 05.13	G4KC / G4KE	4	1,1	LFR5A-11	6376		LPG 7

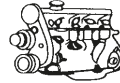
Code *l* kW

Cyl.

Stock-No.  
**VEFINE**LPG/CNG  
**BY-PROMEX****HYUNDAI****SANTA FE 2**

Santa Fe II 2.7	CM	2.7	125	03.06 - 09.09	G6BA / G6EA	6	1,1	ILFR5B11	1637		ILFR6B
Santa Fe II 2.7	CM	2.7	139	11.05 - 12.10	G6BA / G6EA	6	1,1	ILFR5B11	1637		ILFR6B

**SANTA FE 3**

Santa Fe III 2.2 CRDi EURO V mit Automatikgetriebe	DM	2.2	145	09.12 -	D4HB	4	<input checked="" type="checkbox"/>	Y1003AS	92283		
---	----	-----	-----	---------	------	---	-------------------------------------	---------	-------	--	--

**SANTAMO**

Santamo		2.0	101	99 - 12.02	G4CP DOHC / SOHC	4	1,1	BP6ES-11	1212		LPG 2
---------	--	-----	-----	------------	------------------	---	-----	----------	------	--	-------

**SONATA**

Sonata 1.8i		1.8	70	89 -	G62B	4	1,1	BPR6ES-11	4824	13	LPG 2
Sonata 2.0i		2.0	74	89 - 93	4G63 DOHC	4	1,1	BPR6ES-11	4824	13	LPG 2
Sonata 2.0i		2.0	77	06.94 - 96	G4CP-D SOHC	4	1,1	BUR6EA-11	5428		
Sonata 2.0	EF	2.0	100	09.98 - 01	G4JP-G DOHC	4	1,1	BPR6ES-11	4824	13	LPG 2
Sonata 2.0 CRDi		2.0	103	02.06 -	D4EA	4	<input checked="" type="checkbox"/>	Y-749J	5013		
Sonata 2.0i		2.0		93 - 98	G4CP-D DOHC	4	1,1	BPR6ES-11	4824	13	LPG 2
Sonata 2.4i	NF	2.4	118	89 - 01	G4KC	4	1,1	BKR5ES-11	2382	33	LPG 1
Sonata 2.4i		2.4	120	89 -	4G64	4	1,1	BPR6ES-11	4824	13	LPG 2
Sonata 2.4i		2.4	121	08 -		4	1,1	BKR5ES-11	2382	33	LPG 1
Sonata VI 2.4	YF	2.4	131	01.09 -	G4KC	4	1,1	LFR5A-11	6376		LPG 7
Sonata 2.5 V6		2.5	118	09.98 - 01	G6BV-EG DOHC	6	1,1	PFR5J-11	4642		
Sonata 2.7 V6		2.7	127	10.01 - 11.04	G6BA-G	6	1,1	PFR5B-11	2300		PFR6B
Sonata 3.0 V6		3.0		91 - 98	G6AT	6	1,1	PGR5A-11	3573		
Sonata 3.3 V6	NF	3.3	173	01.05 - 08	G6DB	6	1,1	IFR5G11	7854		

**STAREX**

Starex 2.4	H1	2.4	82	02.98 -	SOHC	4	1,1	BP6ES-11	1212		LPG 2
Starex 2.5TD	H1	2.5	59	06.97 -		4	<input checked="" type="checkbox"/>	Y-722JS	9974		

**TERRACAN**

Terracan 2.5 TD	HP	2.5	74	06.01 -	D4BH	4	<input checked="" type="checkbox"/>	CY57	4994	21	
Terracan 2.9 CRDi	HP	2.9	110	10.01 -		4	<input checked="" type="checkbox"/>	CY57	4994	21	
Terracan 2.9 CRDi	HP	2.9	120	11.03 -	J3	4	<input checked="" type="checkbox"/>	CY57	4994	21	

**TIBURON**

Tiburon 1.6		1.6		00 -	DOHC	4	1,1	BKR5ES-11	2382	33	LPG 1
Tiburon 1.8		1.8		00 -	DOHC	4	1,1	BKR5ES-11	2382	33	LPG 1
Tiburon 2.0		2.0		00 -	DOHC	4	1,1	BKR5ES-11	2382	33	LPG 1

**TRAJET**

Trajeto CRDi	FO	2.0	83	04.01 - 04	4DEA	4	<input checked="" type="checkbox"/>	Y-749J	5013		
Trajeto / FO	FO	2.0	100	05.00 -	G4JP-G DOHC	4	1,1	BPR6ES-11	4824	13	LPG 2
Trajeto / FO	FO	2.0	103	01.04 -		4	1,1	BKR5ES-11	2382	33	LPG 1
Trajeto / FO	FO	2.7	127	07.00 -	G6BA DOHC	6	1,1	PFR5N-11	5838		

**TUCSON**

Tucson 2.0 D	JM	2.0	83	09.04 -	D4EA	4	<input checked="" type="checkbox"/>	Y-749J	5013		
Tucson 2.0 D	JM	2.0	103	02.06 -	D4EA	4	<input checked="" type="checkbox"/>	Y-749J	5013		
Tucson 2.0	JM	2.0	104	09.04 -	G4GC	4	1,1	BKR5ES-11	2382	33	LPG 1
Tucson 2.7 V6	JM	2.7	129	09.04 -	G6BA	6	1,1	PFR5N-11	5838		

**VELOSTER**

Veloster 1.6 GDI	FS	1.6	103	03.11 -	G4FD	4	1,0	SILZKR6B10E	93815		
------------------	----	-----	-----	---------	------	---	-----	-------------	-------	--	--

Code *l* kW

Cyl.



Stock-No.



LPG/CNG

**HYUNDAI  
XG**

XG 250 V6	XG	2.5	120	06.99 - 09.03	G6AV	6	1,1	PFR5N-11	5838		
XG 300 V6	XG	3.0	138	12.98 -	G6CT	6	1,1	PFR5N-11	5838		
XG 350 V6	XG	3.5	145	10.02 - 09.05	G6CU	6	1,1	PFR5N-11	5838		

**INFINITI**

EX 35	J50	3.5	221	10.08 - 12.10	VQ35HR	6	1,1	DF7H-11B	1317		
EX 37	J50	3.7	235	09.10 -	VQ37VHR	6	1,1	DF8H-11B	1305		
FX 35	S50	3.5	206	05 -	VQ35DE V6	6	1,1	PLFR5A-11	6240		LPG 7
FX 37	S51	3.7	235	10.08 -	VQ37VHR	6	1,1	DF8H-11B	1305		
FX 45	S50	4.5	233	04 -	VK45DE V8	8	1,1	PLFR5A-11	6240		LPG 7
FX 50	S51	5.0	287	10.08 -	VK50VE	8	1,1	DF7H-11B	1317		
G 20		2.0		91 - 94	SR20DE	4	1,1	PFR5B-11	2300		PFR6B
G 20		2.0		95 - 96	SR20DE	4	1,1	PFR5B-11	2300		PFR6B
G 20		2.0		99 -	SR20DE	4	1,1	PFR5G-11	2647		
G 25	V36	2.5	163	01.11 -	VQ25HR	6	1,1	DF7H-11B	1317		
G 37	V36	3.7	235	10.08 -	VQ37VHR	6	1,1	DF8H-11B	1305		
G 37	V36	3.7	243	10.08 -	VQ37VHR	6	1,1	DF8H-11B	1305		
I 30		3.0		96 - 99	VQ30DE V6	6	1,1	PFR5G-11	2647		
J 30		3.0		93 - 97	VG30DE V6	6	1,1	PFR5G-11	2647		
M 30		3.0		90 - 92	VG30E	6	1,1	PFR6B-11	4014		PFR7B
M 35 Hybrid	Y51HV	3.5	225	04.11 -	VQ35HR	6	1,1	DF7H-11B	1317		
M 35 Hybrid	Y51HV	3.5	268	01.10 -	VQ35HR	6	1,1	DF7H-11B	1317		
M 37	Y51	3.7	235	03.10 -	VQ37VHR	6	1,1	DF8H-11B	1305		
Q 45		4.1		97 - 98	VH41DE	8	1,1	PFR5G-11	2647		
Q 45		4.5		90 - 93	VH45D	8	1,1	PFR5B-11	2300		PFR6B
Q 45		4.5		94 - 96	VH45DE	8	1,1	PFR5G-11	2647		
QX 56		5.6		08 -	VK56DE FI	8	1,1	LFR5A-11	6376		LPG 7
QX 4		3.3		97 - 98	VG33E	6	1,1	BKR5ES-11	2382	33	LPG 1
QX 4		3.3		99 -	VD33DE	6	1,0	FR5AP-10	5463		
QX 4		3.5		01 -	VQ35DE	6	1,1	PLFR5A-11	6240		LPG 7

**INNOCENTI**

Clip ie		1.0	35	09.95 - 06.97	146C7.000	4	0,9	BPR5ES	7422	6	LPG 2
Clip ie Super		1.4	51	09.95 - 06.97	160A1.046	4	0,8	BPR6ES	7822	2	LPG 2
Elba		1.3	49	07.91 - 08.93	146A5.000	4	0,8	BPR6ES	7822	2	LPG 2
Elba D		1.7	42	09.92 -	146 B 2.000	4		Y-924J	7906	1	
Elba ie		1.4	49	11.95 - 06.97	146C5.000	4	0,8	BPR6ES	7822	2	LPG 2
Elba ie		1.6	55	11.95 - 06.97	146C6.000	4	0,8	BPR6ES	7822	2	LPG 2
Elba ie Happy		1.6	55	06.95 - 06.96	146C6.000	4	0,8	BPR6ES	7822	2	LPG 2
Koral 45		0.9	33	10.90 - 06.97	100GL 064	4	0,8	BPR6ES	7822	2	LPG 2
Koral 55		1.1	41	10.90 - 06.97	128A 064	4	0,8	BPR6ES	7822	2	LPG 2
Mille		1.0	35	07.94 - 06.97	146C7.000	4	0,7	BP6ES	7811	4	LPG 2
Mille i.		1.0	35	07.94 - 06.97	146C7.000	4	0,9	BPR5ES	7422	6	LPG 2
Small 500 L / LS		0.6	23	01.91 - 06.97	Daihatsu E	3	0,9	BPR6EY	6427		LPG 2
Small 990 SE		1.0	38	01.91 - 06.97	Daihatsu CB	3	0,8	BPR5EY	2828	9	LPG 2

**ISUZU**

Gemini D		1.5	40	12.88 -	4EC1	4		Y-710J	7880		
Gemini		1.5	54	05.87 -	4XC1, 4XB1	4	0,8	BP5ES	6511	8	LPG 2



Code *l* kW

Cyl.



Stock-No.



LPG/CNG

**ISUZU**

Gemini 1.5 Turbo		1.5	88	02.88 -	4XC1UT	4	1,1	BPR6ES-11	4824	13	LPG 2
Gemini FF D		1.5		12.88 -	4EC1	4	█	Y-710J	7880		
Gemini FF Turbo		1.5		12.88 -	4EC1	4	█	Y-711J	4467	28	
Gemini TD		1.5		12.88 -	4EC1T	4	█	Y-711J	4467	28	
Gemini 16V		1.6	92	01.89 -	4XE1-V	4	1,1	BPR6ES-11	4824	13	LPG 2
Gemini 16V		1.6	92	01.89 -	4XE1-W	4	1,1	BKR6E-11	2756	14	LPG 1
Midi TD 11V		2.0	51	01.86 -		4	█	Y-711J	4467	28	
Midi TD 5V		2.0	51	01.86 -		4	█	Y-307R	5837		
Midi D 11V		2.2	45	01.86 -		4	█	Y-711J	4467	28	
Midi D 5V		2.2	45	01.86 -		4	█	Y-307R	5837		
Rodeo		3.2	151	98 -	V DOHC	6	1,1	PFR5G-11	2647		
Trooper		2.3	66	01.87 -	4ZD1 Cat.	4	1,1	BPR6ES-11	4824	13	LPG 2
Trooper		2.3		87 -		4	0,8	BPR6ES	7822	2	LPG 2
Trooper		2.3		88 -	4ZD1	4	0,8	BPR6ES	7822	2	LPG 2
Trooper		2.6	85	10.87 -	4ZE1 Cat.	4	1,1	BPR6ES-11	4824	13	LPG 2
Trooper 3.0 DTI		3.0	118	08.98 - 08.04	4JX1	4	█	Y1038J	94542		
Trooper TD		3.1	83	06.92 -	4JG2T	4	█	Y-711J	4467	28	
Trooper		3.5	158	04.00 -	6VE1 V6	6	1,1	PFR6B-11	4014		PFR7B
Vehiclecross 3.2 24V		3.2	158	03.97 -	6VDI	6	1,1	BKR6E-11	2756	14	LPG 1

**IVECO**

Daily TDi		2.8	90	09.97 -		6	█	Y-502R	3852		
-----------	--	-----	----	---------	--	---	---	--------	------	--	--

**JAGUAR**

Double Six		5.3		90 -	V 12 HE	12	0,6	BR7EF	3346		
Sovereign 3.2		3.2		07.90 - 07.97	AJ6	6	0,8	BCPR6ES	2330	12	LPG 3
Sovereign 4.0		4.0		09.89 - 09.97	AJ6	6	0,8	BCPR6ES	2330	12	LPG 3

**F-TYPE**

F-Type 5.0		5.0	364	10.12 -	AJ-V8	8	1,0	ILKAR7C10	94940		
------------	--	-----	-----	---------	-------	---	-----	-----------	-------	--	--

**S-TYPE**

S-Type 2.7 D		2.7	152	06.04 -		6	█	YE12	7794		
S-Type 4.2 V8		4.2		03.02 -	AJ-V8	8	1,0	IFR5N10	7866		
S-Type R		4.2		03.02 -	AJ28	8	1,0	IFR5N10	7866		
S-Type R		4.2		03.02 -	AJ-V8	8	1,0	IFR5N10	7866		
S-Type 2.5		2.5	143	02.01 -	AJV6	6	1,3	TR6AP-13E	4968		LPG 5
S-Type 3.0		3.0	175	10.98 -	FC AJ-V6	6	1,3	TR6AP-13E	4968		LPG 5
S-Type V8		4.0	203	10.98 - 03.00	GC AJ-V8	8	1,3	PFR5G-13E	2761		
S-Type V8		4.0	203	03.00 - 03.02	GC AJ-V8	8	1,1	PFR5G-11E	3000		

**XF**

XF 2.7 D	X250	2.7	152	03.08 -	AJD	6	█	YE12	7794		
XF 3.0	X250	3.0	175	03.08 -	AJV6	6	1,3	TR6AP-13E	4968		LPG 5
XF 4.2	X250	4.2	219	03.08 -	SV82G	8	1,0	IFR5N10	7866		
XF 4.2 Supercharged	X250	4.2	306	03.08 -	SV8TS	8	1,0	IFR5N10	7866		
XF 4.2 Supercharged	X250	4.2	313	07.09 -	SV8TS	8	1,0	IFR5N10	7866		
XF 5.0	X250	5.0	283	03.09 -	AJ133	8	1,0	ILKAR7C10	94940		
XFR 5.0 Supercharged	X250	5.0	346	01.09 -	AJ133	8	1,0	ILKAR7C10	94940		
XFR 5.0 Supercharged	X250	5.0	375	03.09 -	AJ133	8	1,0	ILKAR7C10	94940		
XFR-S 5.0 Supercharged	X250	5.0	405	10.12 -	AJ133	8	1,0	ILKAR7C10	94940		

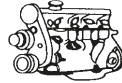
Code *l* kW

Cyl.

Stock-No.  
**VALVE**  
IN-PROGRESS

LPG/CNG

**JAGUAR****XJ**

XJ 5.0	X351	5.0	283	01.10 -	AJ133	8	1,0	ILKAR7C10	94940		
XJ 5.0 Supercharged	X351	5.0	346	01.10 -	AJ133	8	1,0	ILKAR7C10	94940		
XJ 5.0 Supercharged	X351	5.0	375	01.10 -	AJ133	8	1,0	ILKAR7C10	94940		

**XJ 12**

XJ12		5.3		91 - 93	HE(V12)	12	0,6	BR7EF	3346		
XJ12		6.0		92 - 11.94	V12	12	0,6	BR7EF	3346		
XJ12		6.0		93 - 11.94	HE(V12)	12	0,6	BR7EF	3346		
XJ12		6.0		11.94 - 09.96	HE(V12)	12	0,6	BR6EF	3177		
XJ12		6.0		11.94 - 09.96	V12	12	0,6	BR6EF	3177		

**XJ 6**

XJ6		3.2		07.90 - 07.97	AJ6 Cat./ 9BPMNA	6	0,8	BCPR6ES	2330	12	LPG 3
XJ6 V12		5.3		01.91 -	V12	12	0,6	BR7EFS	1094		
XJ6		3.6	136	08.86 - 05.92	AJ6 / 9DPANA	6	0,8	BCPR6ES	2330	12	LPG 3
XJ6 2.7 TDVi		2.7	152	10.05 -		6	<input checked="" type="checkbox"/>	YE12	7794		
XJ6 3.0		3.0		03.03 -	AJ-V6	6	1,3	TR6AP-13E	4968		LPG 5
XJ6		4.0		09.89 - 09.97	AJ6 Cat.	6	0,8	BCPR6ES	2330	12	LPG 3

**XJ 8**

XJ8		3.2	174	09.97 - 09.98	V8	8	1,3	BKR6EVXA-13	2563		
XJ8		3.2	176	09.97 -		8	1,3	BKR6EVXA-13	2563		
XJ8		3.2		09.97 - 09.98	AJ26	8	1,3	BKR5EVXA-13	1188		
XJ8		3.2		09.98 - 03.00	AJ26	8	1,3	PFR5G-13E	2761		
XJ8		3.2		03.00 - 03.02	AJ26	8	1,1	PFR5G-11E	3000		
XJ8		3.2		03.02 -	AJ26	8	1,0	IFR5N10	7866		
XJ8		4.2	219	03.03 - 06.06	AJ33	8	1,0	IFR5N10	7866		
XJ8 Supercharged		4.2	291	03.03 - 09.09	AJ33	8	1,0	IFR5N10	7866		
XJ8		4.2		03.02 -	AJ26	8	1,0	IFR5N10	7866		
XJ8		3.5	190	03.03 - 06.06	AJ33	8	1,0	IFR5N10	7866		
XJ8		3.5		03.02 -	AJ26	8	1,0	IFR5N10	7866		
XJ8		4.0	209	09.97 -	V8	8	1,3	BKR6EVXA-13	2563		
XJ8		4.0		09.97 - 09.98	AJ26	8	1,3	BKR5EVXA-13	1188		
XJ8		4.0		09.98 - 03.00	AJ26	8	1,3	PFR5G-13E	2761		
XJ8		4.0		03.00 - 03.02	AJ26	8	1,1	PFR5G-11E	3000		
XJ8		4.0		03.02 -	AJ26	8	1,0	IFR5N10	7866		

**XJ 8 R**

XJ8R 4.2		4.2		03.02 -		8	1,0	IFR5N10	7866		
XJ8R		4.0	272	09.97 - 03.00		8	1,3	PFR6G-13E	2341		
XJ8R Supercharged		4.0		09.97 - 02.00	AJ26	8	1,3	PFR6G-13E	2341		
XJ8R 4.0		4.0		03.00 - 03.02	AJ26	8	1,1	PFR5G-11E	3000		
XJ8R		4.0		03.02 -	AJ26	8	1,0	IFR5N10	7866		
XJR Supercharged X300		4.0	235	08.94 - 08.97	AJ16 Kompressor	6	0,9	BKR7E	6097		BKR8EIX
XJR 4.0		4.0		09.89 - 09.94	AJ6	6	0,8	BCPR6ES	2330	12	LPG 3
XJR V8 (X300)		4.0	267	09.97 - 02.00	AJ26	8	1,3	PFR6G-13E	2341		

**XJS**

XJS		5.3		91 - 93	V12 HE	12	0,6	BR7EF	3346		
XJS Coupe		4.0		04.91 - 09.96	AJ6	6	0,8	BCPR6ES	2330	12	LPG 3
XJS V12		6.0		05.93 - 11.94	V12	12	0,6	BR7EF	3346		
XJS V12		6.0		11.94 - 05.95	V12	12	0,6	BR6EF	3177		

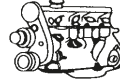
Code *l* kW

Cyl.



Stock-No.

V6/V8  
E-FORCE  
LPG/CNG**JAGUAR****XK 8**

XK8		4.2		09.02 -	AJ34	8	1,0	IFR5N10	7866		
XK8		4.0	213	10.96 - 09.97	AJ / V8	8	1,1	BKR6EIX-11	3764		LPG 1
XK8		4.0	213	09.97 - 09.98	AJ26	8	1,3	BKR5EVXA-13	1188		
XK8		4.0	389	10.96 - 09.97	AJ26	8	1,1	BKR6EIX-11	3764		LPG 1
XK8		4.0		09.97 - 09.98	AJ27	8	1,3	BKR5EVXA-13	1188		
XK8		4.0		09.98 - 03.00	AJ26	8	1,3	PFR5G-13E	2761		
XK8		4.0		09.98 - 03.00	AJ27	8	1,3	PFR5G-13E	2761		
XK8		4.0		03.00 -	AJ26	8	1,1	PFR5G-11E	3000		
XK8		4.0		03.00 - 02.02	AJ27	8	1,1	PFR5G-11E	3000		
XK8		4.0		03.02 -	AJ27	8	1,0	IFR5N10	7866		
XK8 5.0		5.0	283	01.09 -	AJ133	8	1,0	ILKAR7C10	94940		

**XKR**

XKR		4.2		09.02 -	AJ34	8	1,0	IFR5N10	7866		
XKR		4.0	267	05.98 - 03.00	AJ27	8	1,3	PFR6G-13E	2341		
XKR		4.0	267	03.00 - 02.02	AJ27	8	1,1	PFR5G-11E	3000		
XKR		4.0		03.02 -	AJ27	8	1,0	IFR5N10	7866		
XKR 5.0 Supercharged		5.0	375	01.09 -	AJ133	8	1,0	ILKAR7C10	94940		
XKR 5.0 Supercharged		5.0	390	09.10 -	AJ133	8	1,0	ILKAR7C10	94940		
XKR-S 5.0 Supercharged		5.0	405	01.11 -	AJ133	8	1,0	ILKAR7C10	94940		

**X-TYPE**

X-Type 2.0 D		2.0	96	07.03 - 10.05	R4-X404	4	█	Y-548J	94832	75	
X-Type 2.0		2.0	117	12.01 -	AJ-V6	6	1,3	TR6AP-13E	4968		LPG 5
X-Type 2.2 D		2.2	114	10.05 -	L J46G	4	█	YE08	4966		
X-Type 2.5		2.5	140	02.01 -	AJ-V6	6	1,3	TR6AP-13E	4968		LPG 5
X-Type 3.0		3.0	173	02.01 -	AJ-V6	6	1,3	TR6AP-13E	4968		LPG 5

**JEEP****CHEROKEE**

Cherokee		2.5		90 - 98	L4 MPI P	4	0,9	FR5-1	7252		
Cherokee 2.4	KJ	2.4	108	08.01 -	ED1	4	1,1	LZTR4A-11	5444		
Cherokee 2.5 CRD	KJ	2.5	105	09.01 - 10.02	ENJ	4	█	Y1031J	95970	71	
Cherokee 2.8 CRD (KJ)	KJ	2.8	110	09.02 - 01.08	ENR	4	█	Y1031J	95970	71	
Cherokee 2.8 CRD	KJ	2.8	120	11.04 - 12.04	ENR	4	█	Y1031J	95970	71	
Cherokee 3.7 V6	KJ	3.7	155	10.01 -	EKG	6	1,1	ZFR5F-11	2262		LPG 6
Cherokee TD		2.1	59	01.88 -		6	█	Y-924J	7906	1	
Cherokee TD		2.1	65	02.91 - 08.94	J8S 890	4	█	Y-913M	3965	15	
Cherokee TD		2.5	85	05.95 - 07.99	VM HR 425	4	█	Y-741U	6943	20	

**COMMANCHE**

Commanche		2.5		91 - 92	L4 MPI P	4	0,9	FR5-1	7252		
Commanche		4.0		91 - 92	L6 MPI S	6	0,9	FR5-1	7252		

**COMMANDER**

Commander 3.0 CRD		3.0	160	04.06 - 12.10	EXL	6	█	Y8002AS	6287	51	
-------------------	--	-----	-----	---------------	-----	---	---	---------	------	----	--

**COMPASS**

Compass 2.0		2.0	115	05.11 -	ECN	4	1,1	ZFR5F-11	2262		LPG 6
Compass 2.4		2.4	125	08.06 -	ED3 / EDG	4	1,1	ZFR5F-11	2262		LPG 6

**GRAND CHEROKEE**

Grand Cherokee TD		2.5	88	01.93 -	VM HR 425 CLIRE	4	█	Y-924J	7906	1	
Grand Cherokee TD		2.5	88	01.93 -	VM HR-492	4	█	Y-924J	7906	1	
Grand Cherokee TD		2.5	110	04.99 -	ENC	4	█	Y-741U	6943	20	

Code *l* kW

Cyl.



Stock-No.



LPG/CNG

## JEEP GRAND CHEROKEE

Grand Cherokee 3.0 CRD	WH	3.0	155	05.06 - 12.10	EXL	6	☑	Y8002AS	6287	51	
Grand Cherokee 3.0 CRD	WH	3.0	160	06.05 - 12.10	EXL	6	☑	Y8002AS	6287	51	
Grand Cherokee TD / Limited		3.1	103	04.98 -	EXA	5	☑	Y-741U	6943	20	
Grand Cherokee		3.7		05 -	V6 K FI	6	1,1	PZFR6F-11	3271		LPG 6
Grand Cherokee		4.0		91 - 98	L6 S MPI	6	0,9	FR5-1	7252		
Grand Cherokee		4.0		03 - 04	L6 S FI	6	0,8	ZFR5N	7917		
Grand Cherokee		4.7	173	02.99 - 99	V8 N MPI	8	1,1	PZFR6F-11	3271		LPG 6
Grand Cherokee		4.7		00 - 04	V8 N FI SOHC	8	1,1	PZFR6F-11	3271		LPG 6
Grand Cherokee		4.7		02 - 04	V8 J FI SOHC&H.O.	8	0,9	BKR7E	6097		BKR8EIX
Grand Cherokee		4.7		05 -	V8 N FI	8	1,1	PZFR6F-11	3271		LPG 6
Grand Wagoneer		5.2		93 - 93	V8 MPI Y	8	0,9	FR4	5188		
Grand Cherokee		5.2		93 - 96	V8 Y MPI	8	0,9	FR4	5188		
Grand Cherokee		5.2		97 - 98	V8 Y MPI	8	0,9	FR5-1	7252		
Grand Cherokee		5.7	240	05 -	V8 2 FI	8	1,1	LZTR4A-11	5444		
Grand Wagoneer		5.9		97 -	V8 MPI Z	8	0,9	FR4	5188		
Grand Cherokee		5.9		98 -	V8 MPI Z	8	1,0	FR5-1	7252		
Grand Cherokee SRT-8		6.1	313	08.06 -		8	1,3	PLZTR5A-13	4998		

## LIBERTY

Liberty		2.4		02 -	L4 1 FI	4	1,1	LZTR4A-11	5444		
Liberty		3.7		02 -	V6 K FI	6	1,1	PZFR6F-11	3271		LPG 6

## WAGONEER

Wagoneer		2.5		91 - 92	L4 MPI P	4	0,9	FR5-1	7252		
Wagoneer		4.0		91 - 92	L6 MPI S	6	0,9	FR5-1	7252		

## WRANGLER

Wrangler Laredo, Sahara, Texan TD		2.1	65	07.88 -		4	☑	Y-924J	7906	1	
Wrangler		2.5		07.88 -		6	☑	Y-924J	7906	1	
Wrangler, Laredo, Sahara		2.5		07.88 -		6	☑	Y-924J	7906	1	
Wrangler, Texan D		2.5		07.88 -		6	☑	Y-924J	7906	1	
Wrangler		2.5		91 - 01.01	L4 MPI P	4	0,9	FR5-1	7252		
Wrangler Rubicon 3.8		3.8	146	07 -	V6 FI	6	1,3	LZTR5A-13	4612		
Wrangler Unlimited		3.8	151	07 -		6	1,3	LZTR5A-13	4612		
Wrangler		4.0	135	91 -	L6 MPI	6	1,1	ZFR5A-11	5084		LPG 6
Wrangler		4.0		91 - 95	L6 MPI S	6	0,9	FR5-1	7252		
Wrangler		4.0		96 - 97	L6 MPI V	6	0,9	FR5-1	7252		
Wrangler		4.0		98 - 02	L6 MPI S	6	0,9	FR5-1	7252		

## KIA

### BESTA

Besta		2.2	48	02.96 -	R2	4	☑	Y-701J	1566	39	
Besta 2.2		2.2	52	03.90 - 07.99	HW	4	☑	Y-701J	1566	39	
Besta 2.7		2.7	60	03.90 - 07.99	VN	4	☑	Y-701J	1566	39	

### CARENS 1

Carens 1.6	FC	1.6	77	06.02 -	S6D	4	1,1	BKR6ES-11	5553	14	LPG 1
Carens 1.8	FC	1.8	81	01 -		4	0,9	BKR6E	6962	28	LPG 1
Carens 1.8	FC	1.8	93	06.02 -	TB	4	0,8	BKR6ES	3783	28	LPG 1
Carens 2.0 CRDI EX	FC	2.0	83	02 -	D4EA	4	☑	Y-749J	5013		

### CARENS 2

Carens II 2.0	FJ	2.0	102	08.04 -	G4GC	4	1,1	BKR5ES-11	2382	33	LPG 1
---------------	----	-----	-----	---------	------	---	-----	-----------	------	----	-------

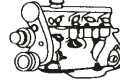

Code *l* kW

Cyl.

Stock-No.  
**V-TUNE**  
**B-Power**

LPG/CNG

**KIA****CARENS 3**

Carens III 1.6 CRDi	UN	1.6	85	06.10 -	D4FB	4	☑	Y-527J	96187	67	
Carens III 1.6 CVT	UN	1.6	93	06.09 -	G4FC	4	1,0	LZKR6B-10E	1578		
Carens III 1.6 CRDi	UN	1.6	94	07.10 -	D4FB	4	☑	Y-527J	96187	67	
Carens III 1.6 CVT	UN	1.6	97	08.09 -	G4FC	4	1,0	LZKR6B-10E	1578		
Carens III 2.0 CRDi	UN	2.0	85	05.06 -	D4EA	4	☑	Y-749J	5013		
Carens III 2.0 CRDi	UN	2.0	103	06 -	D4EA	4	☑	Y-749J	5013		
Carens III 2.0	UN	2.0	106	09.06 -	G4KA	4	1,1	BKR5ES-11	2382	33	LPG 1
Carens III 2.0 CRDi	UN	2.0	136	05.06 -	D4EA	4	☑	Y-749J	5013		

**CARENS 4**

Carens IV 1.6		1.6	99	03.13 -	G4FD	4	1,0	SILZKR6B10E	93815		
Carens IV 1.7 CRDi		1.7	85	03.13 -	D4FD	4	☑	CZ203	95232	68	
Carens IV 1.7 CRDi		1.7	100	03.13 -	D4FD	4	☑	CZ203	95232	68	

**CARNIVAL 1**

Carnival 2.5	UP	2.5	121	12.98 - 01	K5	6	1,1	PFR6N-11	3546		LPG 1
Carnival 2.5	UP	2.5	129	12.98 - 01	KV5 DOHC	6	1,1	PFR6N-11	3546		LPG 1

**CARNIVAL 2**

Carnival II 2.5	GQ	2.5	110	10.01 -		6	1,1	PFR6N-11	3546		LPG 1
Carnival II 2.7	GQ	2.7	139	06.06 -	G6EA V6	6	1,1	ILFR5B11	1637		ILFR6B

**CARNIVAL 3**

Carnival III 2.2 CRDi	VQ	2.2	110	01.10 -	D4HB	4	☑	CZ105	90007		
Carnival III 2.2 CRDi	VQ	2.2	143	01.10 -	D4HB	4	☑	CZ105	90007		
Carnival III 2.9 CRDi	VQ	2.9	136	06.06 -	J3	4	☑	Y-535J	91416		

**CEE'D (ED)**

Cee'd 1.4	ED	1.4	66	07.09 -	G4FA	4	1,0	LZKR6B-10E	1578		
Cee'd 1.4	ED	1.4	80	01.07 - 12.08	G4FA	4	1,1	ZFR5F-11	2262		LPG 6
Cee'd 1.4	ED	1.4	80	01.09 -	G4FA	4	1,0	LZKR6B-10E	1578		
Cee'd 1.6 CRDi	ED	1.6	66	12.06 - 10.10	D4FB-L	4	☑	CZ203	95232	68	
Cee'd 1.6 CRDi	ED	1.6	66	11.10 -	D4FB-L	4	☑	Y-527J	96187	67	
Cee'd 1.6 CRDi	ED	1.6	85	12.06 - 10.10	D4FB	4	☑	CZ203	95232	68	
Cee'd 1.6 CRDi	ED	1.6	85	11.10 -	D4FB	4	☑	Y-527J	96187	67	
Cee'd 1.6	ED	1.6	85	09.07 -	G4FC	4	1,0	LZKR6B-10E	1578		
Cee'd 1.6	ED	1.6	90	12.06 - 12.08	G4FC	4	1,1	ZFR5F-11	2262		LPG 6
Cee'd 1.6	ED	1.6	90	01.09 -	G4FC	4	1,0	LZKR6B-10E	1578		
Cee'd 1.6 CVT	ED	1.6	92	10.10 -	G4FC	4	1,0	LZKR6B-10E	1578		
Cee'd 1.6	ED	1.6	93	09.07 - 12.08	G4FC	4	1,1	ZFR5F-11	2262		LPG 6
Cee'd 1.6	ED	1.6	93	01.09 -	G4FC	4	1,0	LZKR6B-10E	1578		
Cee'd 1.6 CRDi	ED	1.6	94	06.10 - 10.10	D4FB	4	☑	CZ203	95232	68	
Cee'd 1.6 CRDi	ED	1.6	94	11.10 -	D4FB	4	☑	Y-527J	96187	67	
Cee'd 2.0 CRDi	ED	2.0	103	01.07 -	D4EA-F	4	☑	Y-749J	5013		
Cee'd 2.0	ED	2.0	105	01.07 -	G4GC	4	0,8	BKR5ES-11	2382	33	LPG 1

**CEE'D (JD)**

Cee'd 1.6 GDI	JD	1.6	99	05.12 -	G4FD	4	1,0	SILZKR6B10E	93815		
---------------	----	-----	----	---------	------	---	-----	-------------	-------	--	--

**CERATO**

Cerato 1.5 CRDi	LD	1.5	75	08.04 - 08.06	D4FA	4	☑	Y-527J	96187	67	
Cerato 1.6	LD	1.6	77	05.04 -	G4ED	4	1,1	BKR5ES-11	2382	33	LPG 1
Cerato 1.6 CRDi	LD	1.6	85	06.05 - 06.08	D4FB	4	☑	Y-527J	96187	67	
Cerato 1.6	LD	1.6	90	05.06 -	G4FC	4	1,1	ZFR5F-11	2262		LPG 6
Cerato 2.0 CRDi	LD	2.0	83	04.04 -	D4EA	4	☑	Y-749J	5013		

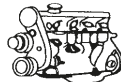
Code *l* kW

Cyl.



Stock-No.



LPG/CNG

**KIA  
CERATO**

Cerato 2.0	LD	2.0	106	05.04 -	G4GC	4	1,1	BKR5ES-11	2382	33	LPG 1
------------	----	-----	-----	---------	------	---	-----	-----------	------	----	-------

**CLARUS**

Clarus 1.8	K9A / GC	1.8	85	06.96 - 01	T8 DOHC	4	0,8	BKR5E	7938	35	LPG 1
Clarus 2.0	K9A / GC	2.0	98	09.96 - 01	FE DOHC	4	1,1	BK6E-11	7340		LPG 1

**JOICE**

Joice 2.0		2.0	103	09.01 - 03	G4CP	4	1,1	BPR6ES-11	4824	13	LPG 2
-----------	--	-----	-----	------------	------	---	-----	-----------	------	----	-------

**K 2500**

K 2500		2.5	69	05 -	D4BH	4		Y-722JS	9974		
--------	--	-----	----	------	------	---	--	---------	------	--	--

**K 2900**

K 2900 2.9 D		2.9	92	08.07 -	J3	4		Y-535J	91416		
--------------	--	-----	----	---------	----	---	--	--------	-------	--	--

**MAGENTIS**

Magentis 2.5 V6	GD	2.5	118	01 -	G6BV	6	0,8	BKR5ES	2460	35	LPG 1
Magentis 2.5 V6	GD	2.5	124	03 -	G6BV	6	0,8	BKR5ES	2460	35	LPG 1
Magentis 2.7 V6	MG	2.7	138	06 - 09	G6EA	6	1,1	ILFR5B11	1637		ILFR6B
Magentis 2.0	GD	2.0	100	01 - 05		4	0,8	BPR6ES	7822	2	LPG 2
Magentis 2.0 CRDi	MG	2.0	103	04.06 - 09	D4EA	4		Y-749J	5013		
Magentis 2.0	MG	2.0	106	06 - 09	G4KA	4	1,1	BKR5ES-11	2382	33	LPG 1
Magentis 2.0 (MG)	MG	2.0	121	07.09 -	G4KD	4	1,1	LFR5A-11	6376		LPG 7

**OPIRUS**

Opirus 3.5	GH	3.5	149	03 - 06		6	1,1	PFR5N-11	5838		
Opirus 3.8	GH	3.8		07 -	G6DA	6	1,1	IFR5G11	7854		

**OPTIMA**

Optima 1.7 CRDi	TF	1.7	100	03.12 -	D4FD	4		CZ203	95232	68	
-----------------	----	-----	-----	---------	------	---	--	-------	-------	----	--

**PICANTO (BA)**

Picanto 1.0	BA	1.0	45	05.04 -	G4HE	4	1,1	BKR5ES-11	2382	33	LPG 1
Picanto 1.0	BA	1.0	46	11.09 -	G4HE	4	1,1	BKR5ES-11	2382	33	LPG 1
Picanto 1.1	BA	1.1	48	10.03 -	G4HG	4	1,1	BKR5ES-11	2382	33	LPG 1
Picanto 1.1 CRDi	BA	1.1	55	11.05 -	D3FA	3		Y-527J	96187	67	

**PICANTO (TA)**

Picanto 1.0	TA	1.0	51	05.11 -	G3LA	3		LKR6D-10E	96569		
Picanto 1.2	TA	1.2	60	09.11 -	G4LA	4		LKR6D-10E	96569		

**PREGIO**

Pregio 2.7		2.7	60	06.96 -	J2	4		Y-701J	1566	39	
Pregio 3.0		3.0	66	06.97 -	W3 / NB9	4		Y-701J	1566	39	

**PRIDE**

Pride 1.3		1.3	44	05.95 - 01		4	1,1	BPR5ES-11	4424		LPG 2
Pride 1.3		1.3	53	05.95 - 01		4	1,1	BPR5ES-11	4424		LPG 2

**RETONA**

Retona 2.0		2.0	61	04.00 -		4		Y-721J	6919		
Retona 2.0 16V		2.0	94	00 -	FED	4	1,1	BKR6E-11	2756	14	LPG 1

**RIO 1**

Rio I 1.3	DC	1.3	55	09.00 - 02.05	B355	4	1,1	BPR5EY-11	3028		LPG 2
Rio I 1.3	DC	1.3	60	08.02 - 02.05	KZ301	4	1,1	BPR5ES-11	4424		LPG 2
Rio I 1.5	DC	1.5	71	09.02 - 02.05	B571	4	1,1	BKR6ES-11	5553	14	LPG 1

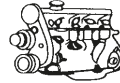
Code *l* kW

Cyl.

Stock-No.  
**V-TIME**  
B-PROMER

LPG/CNG

**KIA****RIO 1**

Rio I 1.5 16V	DC	1.5	72	09.00 - 02.05	B571	4	0,9	BKR6E	6962	28	LPG 1
---------------	----	-----	----	---------------	------	---	-----	-------	------	----	-------

**RIO 2**

Rio II 1.4 16V	JB	1.4	71	06.05 -	G4EE	4	1,1	BKR5ES-11	2382	33	LPG 1
Rio II 1.5 CRDi	JB	1.5	81	06.05 -	D4FA	4	█	Y-527J	96187	67	
Rio II 1.6 CVVT	JB	1.6	82	06.05 -	G4ED	4	1,1	BKR5ES-11	2382	33	LPG 1

**RIO 3**

Rio III 1.1 CRDi	UB	1.1	55	06.11 -	D3FA	3	█	Y-527J	96187	67	
Rio III 1.25 CVVT	UB	1.3	63	06.11 -	G4LA	4		LKR6D-10E	96569		
Rio III 1.4 CRDi	UB	1.4	66	06.11 -	D4FC	4	█	Y-527J	96187	67	
Rio III 1.4 CVVT	UB	1.4	79	09.11 -	G4FA	4	1,0	SILZKR6B10E	93815		
Rio III 1.4 CVVT	UB	1.4	80	06.11 -	G4FA	4		LZKR6B-10E	1578		

**SEDONA 1**

Sedona 2.5		2.5		09.99 -	KV6	6	1,1	PFR6N-11	3546		LPG 1
------------	--	-----	--	---------	-----	---	-----	----------	------	--	-------

**SEDONA 2**

Sedona MkII 2.2 CRDi (VQ)	VQ	2.2	143	01.10 -	D4HB	4	█	CZ105	90007		
---------------------------	----	-----	-----	---------	------	---	---	-------	-------	--	--

**SEPHIA**

Sephia 1.5	FA	1.5	59	96 -	B5E MMO	4	1,1	BPR5ES-11	4424		LPG 2
Sephia 1.8	FA	1.8		06.96 -		4	0,8	BKR5E	7938	35	LPG 1
Sephia 2 1.6 FB522	FB	1.6	75	04.01 -	OKAB5	4	0,9	BKR6E	6962	28	LPG 1
Sephia 1.6 GTX	FA	1.6	59	09.93 -	B6 SOHC	4	1,1	BPR6ES-11	4824	13	LPG 2

**SHUMA 1**

Shuma 1 1.5	FB	1.5	65	05.98 -	BFD	4	1,1	BKR6E-11	2756	14	LPG 1
Shuma 1 1.8	FB	1.8	82	05.98 -	TED	4	0,9	BKR6E	6962	28	LPG 1

**SHUMA 2**

Shuma 2 1.6 FB522,FB624	FB	1.6	75	04.01 -	OKAB5	4	0,9	BKR6E	6962	28	LPG 1
Shuma 2 1.8	FB	1.8	82	01 -	TED	4	0,9	BKR6E	6962	28	LPG 1

**SORENTO 1**

Sorento 2.4	JC	3.3	177	06 -	G6DB	6	1,1	IFR5G11	7854		
Sorento 2.5 CRDi	JC	2.4	102	08.02 - 08.06	G4JS	4	1,1	PGR5C-11	5760		
Sorento 3.3	JC	2.5	103	08.02 -		4	█	Y-508J	3709		
Sorento 3.5	JC	3.5	143	08.02 - 08.06	G6CU	6	1,1	PFR5N-11	5838		
Sorento 3.8	JC	3.8		06 -	G6DA	6	1,1	IFR5G11	7854		

**SORENTO 2**

Sorento 2.0 CRDi	XM	2.0	110	07.09 -	D4HA	4	█	Y1003AS	92283		
Sorento 2.2 CRDi Hot Climate Zone	XM	2.2	145	11.09 -	D4HB	4	█	Y1003AS	92283		
Sorento 2.2 CRDi Cold Climate Zone	XM	2.2	145	11.09 -	D4HB	4	█	CZ105	90007		
Sorento 2.4 CVVT	XM	2.4	128	11.09 -	G4KE	4	1,1	LFR5A-11	6376		LPG 7

**SOUL**

Soul 1.6 CVVT	AM	1.6	77	02.09 -	G4FC	4	1,0	LZKR6B-10E	1578		
Soul 1.6 CRDi	AM	1.6	85	02.09 -	D4FB	4	█	Y-527J	96187	67	
Soul 1.6	AM	1.6	93	02.09 -	G4FC	4	1,0	LZKR6B-10E	1578		
Soul 1.6 CRDi	AM	1.6	94	02.09 -	D4FB	4	█	Y-527J	96187	67	
Soul 1.6 GDI	AM	1.6	103	06.11 -	G4FD	4	1,0	SILZKR6B10E	93815		

**SPORTAGE 1**

Sportage 2.0 TD	K00	2.0	61	07.96 - 08.99	Mazda engine	4	█	Y-701J	1566	39	
Sportage 2.0	K00	2.0	70	94 - 12.02	SOHC	4	0,8	BKR5E	7938	35	LPG 1
Sportage 2.0 16V	K00	2.0	94	94 - 08.04	DOHC 16V	4	1,1	BKR6E-11	2756	14	LPG 1

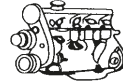
Code *l* kW

Cyl.



Stock-No.



LPG/CNG

## KIA SPORTAGE 2

Sportage 2.0	JE	2.0	83	11.04 -	D4EA	4		Y-749J	5013		
Sportage 2.0 CRDi	JE	2.0	103	06 -	D4EA	4		Y-749J	5013		
Sportage 2.0	JE	2.0	104	06 -	G4GC	4	1,1	BKR5ES-11	2382	33	LPG 1
Sportage 2.5	JE	2.5	129	09.04 -		6	1,1	BKR5ES-11	2382	33	LPG 1
Sportage 2.7	JE	2.7	129	06 -	G6BA V6	6	1,1	PFR5N-11	5838		PFR5N-11

## SPORTAGE 3

Sportage 1.6 GDI	SL	1.6	99	06.10 -	G4FD	4	1,0	SILZKR6B10E	93815		
Sportage 1.7 CRDi	SL	1.7	85	11.10 -	D4FD	4		CZ203	95232	68	
Sportage 2.0 CRDi 4x4 Automatik	SL	2.0	110	07.10 -	D4HA	4		Y1003AS	92283		
Sportage 2.0 CRDi	SL	2.0	110	07.10 -	D4HA	4		CZ105	90007		
Sportage 2.0 CVT	SL	2.0	120	07.10 -	G4KD	4	1,1	LF5A-11	6376		LPG 7

## VENGA

Venga 1.4 CRDi Euro III / Euro IV	YN	1.4	55	02.10 -	D4FC	4		Y-527J	96187	67	
Venga 1.4 CRDi Euro V	YN	1.4	55	02.10 -	D4FC	4		CZ203	95232	68	
Venga 1.4 CRDi Euro IV	YN	1.4	57	02.10 -	D4FC	4		Y-527J	96187	67	
Venga 1.4 CRDi Euro V	YN	1.4	57	02.10 -	D4FC	4		CZ203	95232	68	
Venga 1.4	YN	1.4	66	10.09 -	G4FA	4	1,0	LZKR6B-10E	1578		
Venga 1.4 CRDi Euro III / Euro IV	YN	1.4	66	02.10 -	D4FC	4		Y-527J	96187	67	
Venga 1.4 CRDi Euro V	YN	1.4	66	02.10 -	D4FC	4		CZ203	95232	68	
Venga 1.6 CRDi Euro IV	YN	1.6	85	02.10 -	D4FB	4		Y-527J	96187	67	
Venga 1.6 CRDi Euro V	YN	1.6	85	02.10 -	D4FB	4		CZ203	95232	68	
Venga 1.6	YN	1.6	92	10.09 -	G4FC	4	1,0	LZKR6B-10E	1578		
Venga 1.6 CRDi Euro IV	YN	1.6	94	02.10 -	D4FB	4		Y-527J	96187	67	
Venga 1.6 CRDi Euro V	YN	1.6	94	02.10 -	D4FB	4		CZ203	95232	68	

## LADA (AVTOVAZ)

112 2112 16V		1.5	54	01.96 -	VAZ-2111	4	0,8	BPR6ES	7822	2	LPG 2
112 Gli		1.5	67	03 -	16V	4	1,1	BCPR6ES-11	7121	11	LPG 3
21080 Samara 1.3		1.3	48	01.84 -		4	0,8	BPR6ES	7822	2	LPG 2
210993 Samara 1.5		1.5	53	01.90 -		4	0,8	BPR6ES	7822	2	LPG 2
2110 1,5		1.5	53	06.96 -		4	0,8	BPR6ES	7822	2	LPG 2
2110		1.5	56	96 -		4	0,8	BPR6ES	7822	2	LPG 2
2110		1.5	58	97 -		4	0,8	BPR6ES	7822	2	LPG 2
2111		1.5	58	97 -		4	0,8	BPR6ES	7822	2	LPG 2
2115 1,5		1.5	53	00.00 -		4	0,8	BPR6ES	7822	2	LPG 2
2115 1,5i		1.5	57	01.00 -	VAZ-2111	4	1,1	BPR6ES-11	4824	13	LPG 2
2120 Nadeschda 1,7i		1.7	60	01.98 -	BA3-21214	4	1,1	BPR6ES-11	4824	13	LPG 2
2120 Nadeschda 1,8		1.8	59	01.98 -	BA3-2130	4	0,8	BPR6ES	7822	2	LPG 2
Aleko D		1.8	44	01.87 -	Ford RTE, RTS	4		Y-910R	4751	3	
Forma		1.3		09.91 -		4	0,8	BPR6ES	7822	2	LPG 2
Forma		1.5	50	09.91 -		4	0,8	BPR6ES	7822	2	LPG 2
Lada 2101/ 21011/ 21012/ 21013/ 21014						4	0,7	BP6ES	7811	4	LPG 2
Lada 2102/ 21021/ 21022/ 21023/ 21024/ 21026						4	0,7	BP6ES	7811	4	LPG 2
Lada 2103/ 21033/ 21035						4	0,7	BP6ES	7811	4	LPG 2
Lada 2104/ 21043/ 21046/ 21047						4	0,7	BP6ES	7811	4	LPG 2
Lada 2105/ 21051/ 21053/ 21056/ 21057						4	0,7	BP6ES	7811	4	LPG 2

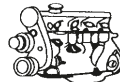
Code *l* kW

Cyl.



Stock-No.

VEFINE

B-PROMEX

LPG/CNG

**LADA (AVTOVAZ)**

Lada 2106/ 21061/ 21064/ 21065-01/ 21066						4	0,7	BP6ES	7811	4	LPG 2
Lada 2107/ 21072/ 21073/ 21074/ 21076/ 21077/ 21078/ 210736-40						4	0,7	BP6ES	7811	4	LPG 2
Lada 2108/ 21081/ 21083/ 21087/ 21088						4	0,8	BPR6ES	7822	2	LPG 2
Lada 21083i/ 21093i/ 21099i/ 21102/ 211026/ 21110/ 2131i						4	1,1	BPR6ES-11	4824	13	LPG 2
Lada 2109/ 21091/ 21093						4	0,8	BPR6ES	7822	2	LPG 2
Lada 21099						4	0,8	BPR6ES	7822	2	LPG 2
Lada 2110/ 2111						4	0,8	BPR6ES	7822	2	LPG 2
Lada 21103/ 211036/ 21113/ 21109/ 21108/ 21083-37/ 2112/ 2113/ 21103						4	1,1	BCPR6ES-11	7121	11	LPG 3
Lada 2115-01/ 2115-03/ 21153-01						4	0,8	BPR6ES	7822	2	LPG 2
Lada 2115-20/ 2115-21/ 2115-23/ 21153-21						4	1,1	BPR6ES-11	4824	13	LPG 2
Lada NIVA 4x4 2121						4	0,7	BP6ES	7811	4	LPG 2
Lada NIVA 4x4 21211/ 21212						4	0,8	BPR6ES	7822	2	LPG 2
Lada NIVA 4x4 2131/ 2130/ 2129/ 21217/ 21214/ 21213						4	0,8	BPR6ES	7822	2	LPG 2
Lada OKA 1111/ 1113						4	0,7	BCP6ES	4930	17	LPG 3
21102 i	1.5	57	01.96 -	BA3 2111		4	1,1	BPR6ES-11	4824	13	LPG 2
21103 16V	1.5	67	01.96 -	BA3 2112		4	1,1	BCPR6ES-11	7121	11	LPG 3
Lada 110 21101 8V	1.6	59	04 -	??? 21114		4	1,1	BPR6ES-11	4824	13	LPG 2
Lada 110 21104	1.6	66	04 -	??? 21124		4	1,1	BCPR6ES-11	7121	11	LPG 3
2110 GTi 16V	2.0	110	01.96 -	C20XE Opel		4	0,9	BKR6E	6962	28	LPG 1
110 2.0 GTI	2.0	110	01.00 -	C20XE		4		BKR6EK	2288	20	LPG 1
21111	1.5	53	01.98 -	BA3 2120		4	0,8	BPR6ES	7822	2	LPG 2
21110 i	1.5	57	01.98 -	BA3 2111		4	1,1	BPR6ES-11	4824	13	LPG 2
21113 16V	1.5	67	01.98 -	BA3 2112		4	1,1	BCPR6ES-11	7121	11	LPG 3
Lada 111 21112 8V	1.6	59	04 -	??? 21114		4	1,1	BPR6ES-11	4824	13	LPG 2
Lada 111 21114 16V	1.6	66	04 -	??? 21124		4	1,1	BCPR6ES-11	7121	11	LPG 3
21122 i	1.5	57	01.00 -	VAZ-2111		4	1,1	BPR6ES-11	4824	13	LPG 2
21120 16V	1.5	67	01.00 -	VAZ-2112		4	1,1	BCPR6ES-11	7121	11	LPG 3
Lada 112 21121 8V	1.6	59	04 -	??? 21114		4	1,1	BPR6ES-11	4824	13	LPG 2
Lada 112 21124 16V	1.6	66	04 -	??? 21124		4	1,1	BCPR6ES-11	7121	11	LPG 3
2102, 21021, 21022, 21023, 21024, 21026 Lada Kombi	1.2	43		BA3 2101		4	0,7	BP6ES	7811	4	LPG 2
2102, 21021, 21022, 21023, 21024, 21026 Lada Kombi	1.3	47		BA3 21011		4	0,7	BP6ES	7811	4	LPG 2
21043 / Nova Kombi	1.5	53	01.88 -	BA3-2103		4	0,7	BP6ES	7811	4	LPG 2
21050	1.5	53	01.88 -	BA3 21011		4	0,7	BP6ES	7811	4	LPG 2
21060	1.3	47		BA3 21011		4	0,7	BP6ES	7811	4	LPG 2
21063	1.5	52		BA3 2103		4	0,7	BP6ES	7811	4	LPG 2
21070	1.3	47	01.82 -	BA3 21011		4	0,7	BP6ES	7811	4	LPG 2
21073	1.5	53	01.88 -	BA3 2103		4	0,7	BP6ES	7811	4	LPG 2
Lada Kalina 1117	1.6	58	10.04 -	BA3 11183		4	1,1	BCPR6ES-11	7121	11	LPG 3
Lada Kalina 1118	1.6	58	10.04 -	BA3 11183		4	1,1	BCPR6ES-11	7121	11	LPG 3
Lada Kalina 1119	1.6	58	10.04 -	BA3 11183		4	1,1	BCPR6ES-11	7121	11	LPG 3
Lada Kalina 1117 8V	1.6	59	05 -	??? 21114		4	1,1	BPR6ES-11	4824	13	LPG 2
Lada Kalina 1118 8V	1.6	59	05 -	??? 21114		4	1,1	BPR6ES-11	4824	13	LPG 2
Lada Kalina 1119 8V	1.6	59	05 -	??? 21114		4	1,1	BPR6ES-11	4824	13	LPG 2

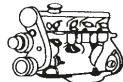

Code  $\ell$  kW

Cyl.



Stock-No.



LPG/CNG

**LADA (AVTOVAZ)**

Lada Kalina 1117 16V		1.6	65	10.04 -	BA3 21124	4	1,1	BCPR6ES-11	7121	11	LPG 3
Lada Kalina 1118 16V		1.6	65	10.04 -	BA3 21124	4	1,1	BCPR6ES-11	7121	11	LPG 3
Lada Kalina 1119 16V		1.6	65	10.04 -	BA3 21124	4	1,1	BCPR6ES-11	7121	11	LPG 3
Lada Niva 2129 1.7 Niva		1.7	59	93 -	??? 21213	4	0,8	BPR6ES	7822	2	LPG 2
2105 Nova Junior		1.2				4	0,7	BP6ES	7811	4	LPG 2
2105 Nova 1300		1.3				4	0,7	BP6ES	7811	4	LPG 2
2105 Nova Spezial		1.5				4	0,7	BP6ES	7811	4	LPG 2
21081 / Fun 1100		1.1	39	01.84 -		4	0,8	BPR6ES	7822	2	LPG 2
21091		1.1	39	01.87 -		4	0,8	BPR6ES	7822	2	LPG 2
21090		1.3	48	01.87 -	BA3 2108	4	0,8	BPR6ES	7822	2	LPG 2
21099		1.3	48	01.90 -	BA3 2108	4	0,8	BPR6ES	7822	2	LPG 2
21083 / Fun 1500		1.5	53	01.84 -	BA3 2103	4	0,8	BPR6ES	7822	2	LPG 2
21093		1.5	53	01.87 -	BA3 2103	4	0,8	BPR6ES	7822	2	LPG 2
Lada Samara 2113 8V		1.5	56	04 -	??? 2111	4	1,1	BPR6ES-11	4824	13	LPG 2
21083 i		1.5	57		BA3 2111	4	1,1	BPR6ES-11	4824	13	LPG 2
21093 i		1.5	57		BA3 2111	4	1,1	BPR6ES-11	4824	13	LPG 2
2114 i		1.5	57	01.01 -	BA3 2111	4	1,1	BPR6ES-11	4824	13	LPG 2
2107 Toscana		1.5	55	07.88 -		4	0,7	BP6ES	7811	4	LPG 2
21213 Niva 1.7		1.7	55	01.93 -		4	0,8	BPR6ES	7822	2	LPG 2
21214 Niva 1.7i		1.7	60	01.01 -	BA3-21214	4	1,1	BPR6ES-11	4824	13	LPG 2
Niva		1.7	59	95 -		4	0,8	BPR6ES	7822	2	LPG 2
21310 Niva 1.7i		1.7	60	01.95 -	BA3-21214	4	1,1	BPR6ES-11	4824	13	LPG 2
21312 Niva 1.8		1.8	59	01.95 -	BA3-2130	4	0,8	BPR6ES	7822	2	LPG 2
Niva D		1.9	47	10.93 -	Peugeot XUD 9L	4		Y-924J	7906	1	
Nova / Vaz 2104, 2105			55	07.88 -		4	0,8	BPR6ES	7822	2	LPG 2
Nova / Vaz 2107			57	07.88 -		4	0,8	BPR6ES	7822	2	LPG 2
Nova / Vaz 21051		1.2	44	07.88 -		4	0,8	BPR6ES	7822	2	LPG 2
Nova / Vaz 2102, 2105		1.3	48	07.88 -		4	0,8	BPR6ES	7822	2	LPG 2
Nova / Vaz 21043		1.5	55	07.88 -		4	0,8	BPR6ES	7822	2	LPG 2
Nova i		1.7	59	11.94 -		4	0,8	BPR6ES	7822	2	LPG 2
Nova i		1.7	62	11.94 -		4	0,8	BPR6ES	7822	2	LPG 2
1111 Oka / 640		0.65	22	09.89 -	BA3 1111	2	0,7	BCP6ES	4930	17	LPG 3
Oka /640		0.65	22	09.89 -	Vaz 1111	2	0,7	BCP6ES	4930	17	LPG 3
1111 Oka 1.3		1.3	46	01.98 -	A-Plus ROV	4	0,8	BPR6ES	7822	2	LPG 2
Oka 1.3 VAZ-1111		1.3	46	01.98 -	A-Plus ROV	4	0,8	BPR6ES	7822	2	LPG 2
Riva 1200		1.2	47	11.85 -	OHC 21012	4	0,7	BP6ES	7811	4	LPG 2
Riva 1300		1.3	49	11.85 -	OHC 21056	4	0,7	BP6ES	7811	4	LPG 2
Riva 1500		1.5	55	11.85 -	OHC 21026	4	0,7	BP6ES	7811	4	LPG 2
Riva 1600		1.6	63	01.86 -	OHC 21062	4	0,7	BP6ES	7811	4	LPG 2
Sagona D		1.5	40	01.95 -	TUD5	4		Y-503J	1009	10	
Sagona i		1.5		07.94 -		4	0,9	BPR5ES	7422	6	LPG 2
Sagona GLX		1.5		07.95 -		4	0,8	BPR6ES	7822	2	LPG 2
Samara Fun		1.1	39	09.91 -		4	0,8	BPR6ES	7822	2	LPG 2
Samara / Vaz 2108		1.1	41	07.88 -		4	0,8	BPR6ES	7822	2	LPG 2
Samara / Vaz 2108		1.3	46	07.88 -		4	0,8	BPR6ES	7822	2	LPG 2
Samara D		1.5	40	01.95 -	TUD 5	4		Y-503J	1009	10	
Samara 21093		1.5	56			4	0,8	BPR6ES	7822	2	LPG 2
Samara Sport		1.5	65	96 -		4	0,8	BPR6ES	7822	2	LPG 2
Toscana		1.5	55	01.86 -		4	0,7	BP6ES	7811	4	LPG 2

Code *l* kW

Cyl.



Stock-No.

V-TUNE

E-FORWARD

LPG/CNG

**LAMBORGHINI**

Gallardo Coupé		5.0	382	05.05 -	L140	10	0,8	PFR7G	4364		
Gallardo Spider		5.0	382	05.05 -	L140	10	0,8	PFR7G	4364		
Gallardo Coupé Superleggera		5.0	390	06.07 -	L140	10	0,8	PFR7G	4364		
Murciélago Coupé		6.5	471	04.06 -	L537	12		KR8BI	4347		
Murciélago LP640 Coupe / Roadster		6.5	471	07 -	L537	12		KR8BI	4347		

**LANCIA****DEDRA**

Dedra 1.6L i.e.		1.6	57	08.89 - 09.94	835A1.046 Cat.	4	0,8	BPR6ES	7822	2	LPG 2
Dedra 1.6L - LE/S.W. LE		1.6	66	10.94 - 02.98	159B9.000	4	0,9	BCPR7ES	3330		BCPR7EIX
Dedra 1.6		1.6	66	03.97 - 02.98	159B9.000	4	0,9	BCPR7ES	3330		BCPR7EIX
Dedra 1.6i.e. S.W. 16V		1.6	76	03.98 - 01.00	182A4.000	4	0,9	BKR5EZ	7642	36	LPG 1
Dedra 1.6i.e. 16V		1.6	76	03.98 - 01.00	182A4.000	4	0,9	BKR5EZ	7642	36	LPG 1
Dedra 1.8L - LE-LS-SW		1.8	74	10.94 - 02.98	835A2.046	4	0,9	BCPR7ES	3330		BCPR7EIX
Dedra 1.8 i.e./ LE		1.8	77	01.89 - 09.94	835A2.046 Cat.	4	0,8	BPR7ES	2023	19	BPR8EIX
Dedra 1.8 16V		1.8	83	07.97 - 01.00	182A2.000	4		BKR6EKC	2848	26	LPG 1
Dedra 1.9 TD		1.9	66	03.89 - 09.94	835 A 4.000	4	■	Y-924J	7906	1	
Dedra 1.9 TD ds		1.9	66	10.94 -	160 D 1.000	4	■	Y-924J	7906	1	
Dedra 1.9 Eco LE TD		1.9	68	06.93 -	160 D 1.000	4	■	Y-924J	7906	1	
Dedra 2.0 i.e. / LS		2.0	83	01.89 - 09.94	835A5.046 Cat.	4	0,8	BPR7ES	2023	19	BPR8EIX
Dedra 2.0 i.e. automatica LS		2.0	83	10.94 - 04.97	835A5.046	4	0,8	BPR7ES	2023	19	BPR8EIX
Dedra 2.0 16V S.W.LX / integrale		2.0	102	10.94 - 02.98	836A3.000	4	0,8	BPR7ES	2023	19	BPR8EIX
Dedra 2000 Turbo		2.0	119	08.91 - 02.98	835A8.046	4		BP6ET	1263		LPG 2
Dedra 2.0 i.e. Turbo/Integr.		2.0	124	01.91 - 09.94	835A7.046 Cat.	4		BP6ET	1263		LPG 2

**DELTA**

Delta 1.6		1.6	55	09.93 - 11.97	851C1.000	4	0,9	BCPR7ES	3330		BCPR7EIX
Delta 1.6 (836)		1.6	66	03.96 - 02.98	182A6.000	4	0,9	BCPR7ES	3330		BCPR7EIX
Delta 1.6 16V - HPE		1.6	76	06.96 - 11.97	182A4.000	4		BKR6EKC	2848	26	LPG 1
Delta 1.6i.e. 16V HPE; LS		1.6	76	12.97 - 02.98	182A4.000	4		BKR6EKC	2848	26	LPG 1
Delta 1.6		1.6	76	03.98 - 01.00	182A4.000	4	0,9	BKR5EZ	7642	36	LPG 1
Delta 1.8 i.e. / LE		1.8	66	09.93 - 11.97	835C4.000	4	0,8	BPR7ES	2023	19	BPR8EIX
Delta 1.8 16V/ HPE		1.8	96	06.96 - 11.97	183A1.000	4		BKR6EKC	2848	26	LPG 1
Delta 1.8 16V- HPE/LS		1.8	96	12.97 - 01.00	183A1.000	4		BKR6EKC	2848	26	LPG 1
Delta 1.9 TD		1.9	66	10.94 -	160 D 1.000	4	■	Y-924J	7906	1	
Delta 1.9 Td		1.9	66	10.96 -		4	■	Y-928U	4389	29	
Delta 2.0 i.e. 16V / LS		2.0	102	09.93 - 11.97	836A3.000	4	0,8	BPR7ES	2023	19	BPR8EIX
Delta 2.0 i.e. 16V GT		2.0	102	10.94 - 11.97	836A3.000	4	0,8	BPR7ES	2023	19	BPR8EIX
Delta 2.0 HPE ie		2.0	102	06.95 -		4	0,8	BPR7ES	2023	19	BPR8EIX
Delta 2.0 i.e. HPE Turbo 16V		2.0	137	01.93 - 09.96	836 A2.000	4	0,8	BPR7ES	2023	19	BPR8EIX
Delta 2.0 Turbo		2.0	137	09.93 - 11.97	836 A2.000	4		BP6ET	1263		LPG 2
Delta 2.0 HPE Turbo 16V HF		2.0	137	06.95 -		4		BUR6ET	3172	1	LPG 2
Delta 2.0 i.e. HPE Turbo 16V HF		2.0	142	12.97 - 01.00	175A4.000	4		BCPR6ET	2197		LPG 3
Delta 2.0 i.e. Turbo HF 16V Inte		2.0	144	10.87 - 11.97	831 C5.000	4	0,8	BPR7ES	2023	19	BPR8EIX
Delta 2.0 HF Integrale Evo 3		2.0	144	07.92 - 11.97	831C5.046	4		BP6ET	1263		LPG 2
Delta 2.0 i.e. Turbo HF Integr.		2.0	144	07.92 - 11.97	831C5.046	4	0,8	BPR7ES	2023	19	BPR8EIX
Delta 2.0 HF integrale Spec.ed.		2.0	155	02.94 - 11.97	831E5.046	4		BUR6ET	3172	1	LPG 2

**DELTA III**

Delta 3 1.4 T-Jet	844	1.4	88	09.08 -	198A4000	4	0,8	IKR9J8	93311		
Delta 3 1.4 T-Jet LPG	844	1.4	88	10.09 -	198A4000	4	0,8	IKR9J8	93311		
Delta 3 1.4 T-Jet	844	1.4	103	07.10 -	198A7000	4	0,8	IKR9J8	93311		

Code *l* kW

Cyl.



Stock-No.



LPG/CNG

**LANCIA  
DELTA III**

Delta 3 1.4 T-Jet	844	1.4	110	09.08 -	198A1000	4	0,8	IKR9J8	93311		
Delta 3 1.6 D Mjet	844	1.6	77	04.11 -	844A3000	4	█	Y9003AS	94251	78	
Delta 3 1.6 D Mjet	844	1.6	85	09.08 -	955A4000	4	█	Y9003AS	94251	78	
Delta 3 1.6 D Mjet	844	1.6	88	07.08 -	198A2000	4	█	Y9003AS	94251	78	
Delta 3 1.8 Di TURBO-JET	844	1.8	147	05.09 -	939B1000	4	0,6	ILKAR7D6G	93607		
Delta 3 1.9 D MJet	844	1.9	140	09.08 -	844A1000	4	█	Y9003AS	94251	78	
Delta 3 2.0 D MJet	844	2.0	120	09.08 -	844A2000	4	█	Y9003AS	94251	78	
Delta 3 2.0 D Mjet	844	2.0	121	07.08 -	198A5000	4	█	Y9003AS	94251	78	

**KAPPA (K)**

K		2.0	114	11.94 - 02.01	838 A6.000	4		BKR6EKC	2848	26	LPG 1
K		2.0	114	07.98 - 02.01	838A6.000	4		BCPR6ET	2197		LPG 3
K 20V LS; S.W.		2.0	114	07.98 - 02.01	838 A6.000	5		BKR6EKC	2848	26	LPG 1
K turbo		2.0	151	02.95 - 06.98	838A4.000	4		BP6ET	1263		LPG 2
K Turbo 16V Coupé		2.0	151	07.97 - 06.98	838A4.000	4		BP6ET	1263		LPG 2
K i. 20V LS/LE/LX/SW		2.4	129	01.95 - 02.01	838A2.000	5		BKR6EKC	2848	26	LPG 1
K i 20V Coupé		2.5	129	07.97 - 02.01	838A2.000	5		BKR6EKC	2848	26	LPG 1
K V6 - 24V-LX/LS/SW/coupè		3.0	150	01.95 - 02.01	838B.000	6	0,9	PFR6B	3500		PFR7B
K i V6 24V aut. Coupé		3.0	150	07.97 - 02.01	838B.000	6	0,9	PFR6B	3500		PFR7B
KAPPA 2000 20V 150CV		2.0	110	01.95 -	838A1.000	5		BKR6EKC	2848	26	LPG 1
KAPPA 2000 16V TURBO		2.0	151	02.95 - 02.01	838A4.000	4		BP6ET	1263		LPG 2
KAPPA 2000 TURBO 20V		2.0	162	07.98 - 02.01	175 A3.000	5		BKUR6ET	6437	27	LPG 1
KAPPA / SW / Coupé 2,4 JTD		2.4	100	06.98 - 10.99	838A8000 fino a n. motore —> 1713818	5	█	Y-747U	4694	26	
KAPPA / SW / Coupé 2,4 JTD		2.4	100	11.99 - 04	838A8000 dal n. motore 1713819 —>	5	█	Y-534J	3413	36	
KAPPA 2400 20V 175CV		2.4	129	01.95 - 02.01	838A2.000	5		BKR6EKC	2848	26	LPG 1
KAPPA TD		2.4		10.94 - 12.98	838 A3.000	5	█	Y-910J	3617	3	
KAPPA 3000 V6 24V		3.0	150	01.95 - 02.01	838B.000	6	0,9	PFR6B	3500		PFR7B

**LYBRA**

Lybra 1.6 16V		1.6	76	09.99 -	182 A4.000	4	0,9	BKR5EZ	7642	36	LPG 1
Lybra 1.8 16V		1.8	96	09.99 - 08.02	839 A4.000	4		BKR6EKC	2848	26	LPG 1
Lybra 1.8 16V		1.8	96	09.02 -	839 A4.000	4	0,9	BKR6EZ	4619	38	LPG 1
Lybra 1.9 JTD		1.9	77	09.98 - 11.99	AR32302 fino a n. motore —> 1713818	4	█	Y-747U	4694	26	
Lybra 1.9 JTD		1.9	77	12.99 - 09.00	AR32302 dal n. motore 1713819 —>	4	█	Y-534J	3413	36	
Lybra 1.9 JTD		1.9	81	09.00 - 05.01	AR 37101	4	█	Y-534J	3413	36	
Lybra 1.9 JTD		1.9	85	06.01 - 04	937A2000	4	█	Y-534J	3413	36	
Lybra 2.0 20V		2.0	110	09.99 - 08.02	182 B7.000	5		BKR6EKC	2848	26	LPG 1
Lybra 2.0 20V		2.0	110	09.02 -	182 B7.000	5	0,9	BKR6EZ	4619	38	LPG 1
Lybra 2.4 JTD		2.4	100	11.99 - 12.00	AR 32501 dal n. motore 1713819 —>	5	█	Y-534J	3413	36	
Lybra 2.4 JTD		2.4	100	09.99 - 11.99	AR 32501 fino a n. motore —> 1713818	5	█	Y-747U	4694	26	
Lybra 2.4 JTD		2.4	103	09.00 - 05.02	839 A6.000	5	█	Y-534J	3413	36	
Lybra 2.4 JTD		2.4	110	05.02 - 04	841C000	5	█	Y-534J	3413	36	

**MUSA**

Musa 1.3 D Mjet EURO IV		1.3	51	09.04 - 12.12	188A9000	4	█	Y8003J	97256	62	
Musa 1.3 D Mjet EURO V		1.3	51	11 - 12.12	188A9000	4	█	Y9001AS	97719	72	
Musa 1.3 D Mjet		1.3	66	02.05 -	199A3000	4	█	Y8003J	97256	62	

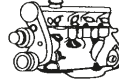
Code *l* kW

Cyl.



Stock-No.

LPG/CNG

**LANCIA****MUSA**

Musa 1.3 D Mjet EURO V		1.3	66	11 -	199A3000	4	☑	Y9001AS	97719	72	
Musa 1.3 D Mjet EURO V		1.3	70	03.09 -	199B1000	4	☑	Y9001AS	97719	72	
Musa 1.4		1.4	57	09.05 -	350A1000	4	1,0	ZKR7A-10	1691		LPG 8
Musa 1.4 LPG EURO IV		1.4	57	04.09 -	350A1000	4	1,0	ZKR7A-10	1691		LPG 8
Musa 1.4 LPG EURO V		1.4	57	11.10 -	350A1000	4	0,8	ZKR7AI-8	92402		
Musa 1.4 16V		1.4	66	10.04 - 12.12	192B2.000	4	1,0	DCPR7E-N-10	4983		LPG 8
Musa 1.4 16V		1.4	70	09.04 - 02.05	843A1.000	4	0,9	DCPR7E-N	4795		LPG 8
Musa 1.4 16V		1.4	70	03.05 -	843A1.000	4	1,0	DCPR7E-N-10	4983		LPG 8
Musa 1.6 D Mjet		1.6	85	07.08 - 12.12	350A3000	4	☑	Y9003AS	94251	78	
Musa 1.6 D Mjet		1.6	88	06.08 -	350A2000	4	☑	Y9003AS	94251	78	
Musa 1.9 D Mjet		1.9	74	10.04 - 12.12	188B2000	4	☑	Y-534J	3413	36	

**PHEDRA**

Phedra 2.0 JTD		2.0	79	09.02 - 05.03	RHM (DW10ATED4) fino a n. ric. —> 9666	4	☑	Y-504J	1441	24	
Phedra 2.0 JTD		2.0	80	09.02 -	DW10ATED4/RHT, RHW	4	☑	Y-504J	1441	24	
Phedra 2.0 JTD		2.0	80	09.02 - 05.03	RHW (DW10ATED4) fino a n. ric. —> 9666	4	☑	Y-504J	1441	24	
Phedra 2.0		2.0	100	10.02 - 11.10	EW10J4 RFN	4	0,9	LFR5B	7113		LPG 7
Phedra 2.2 JTD		2.2	94	09.02 - 05.03	4HW (DW12ATED4) fino a n. ric. —> 9666	4	☑	Y-504J	1441	24	
Phedra 2.2 JTD		2.2	94	06.03 -	DW12ATED4/4HW	4	☑	Y-504J	1441	24	
Phedra 2.2 JTD		2.2	120	04.06 - 11.10	4HP / 4HR	4	☑	YE08	4966		
Phedra 2.2 D Mjet		2.2	125	02.08 - 11.10	4HT / 4HS	4	☑	YE08	4966		
Phedra 3,0 V6		3.0	150	10.02 -	XFW	6	1,1	PLFR5A-11	6240		LPG 7

**THEMA**

Thema 2.0 i.e.16V		2.0	112	04.94 - 01.95	834F1.000	4	0,8	BPR7ES	2023	19	BPR8EIX
Thema 2.0 i.e. Turbo 16V		2.0	148	10.91 - 01.95	834F2.000 Cat.	4		BP6ET	1263		LPG 2
Thema i.e. Turbo 16V S.W.Fairway		2.0	148	04.94 - 01.95	834C1.246	4		BUR6ET	3172	1	LPG 2
Thema 2.4 TD		2.4	74	01.93 -		4	☑	Y-924J	7906	1	
Thema 2.5 TD		2.5	85	01.94 - 12.94		4	☑	Y-926U	7119		
Thema 3.0 i.e. V6		3.0	126	92 - 01.95	834F.000	6	0,8	BPR7ES	2023	19	BPR8EIX
Thema 3.0 8.32		3.0	150	90 - 92	F105L Cat.	8	0,7	DCPR9E	2641		

**THESIS**

Thesis 2.0 20 V TB		2.0	136	11.02 -	841E.000	5		BKUR6ETB	6992		
Thesis 2.0 TB cambio 6 marce		2.0	136	11.02 -	841E.000	5		BKUR6ETB	6992		
Thesis 2.4 JTD		2.4	110	07.02 - 04.03	841C000	5	☑	Y-534J	3413	36	
Thesis 2.4 JTD 20V		2.4	120	05.03 - 10.03	841M000 / 841N000	5	☑	YE07	6092		
Thesis 2.4 20V		2.4	125	11.02 -	841D.000	5	0,9	BKR6EZ	4619	38	LPG 1
Thesis 2.4 JTD 20V		2.4	129	05.03 - 06.09	841G000 / 841H000	5	☑	YE07	6092		
Thesis 2.4 D Mjet 20V		2.4	136	09.05 - 06.09	841P000	5	☑	YE07	6092		
Thesis 3.0 24V V6		3.0	158	11.02 -	841A.000	6	0,9	PFR6B	3500		PFR7B
Thesis 3.2 24V V6		3.2	169	11.03 -	841A.000	6	0,9	PFR6B	3500		PFR7B

**YPSILON (Y)**

Y 1.2 8V		1.2	44	10.00 - 12.03	188A4.000	4	0,9	BKR5EZ	7642	36	LPG 1
Y 1.2 16V		1.2	59	10.00 - 11.02	188A5.000	4	0,9	DCPR8E-N	5692		LPG 8
Y 1.2 16V		1.2	59	12.02 - 12.03	188A5.000	4	0,9	DCPR7E-N	4795		LPG 8
Y 10 1.0 4WD		1.0	33	85 - 10.96	156A2.246	4	0,8	BCPR6ES	2330	12	LPG 3
Y 10 1.0 Fire		1.0	33	85 - 10.96	156A2.000	4	0,8	BCPR6ES	2330	12	LPG 3
Y 10 1.1 4x4		1.1	37	09.86 - 10.96	156C.046	4	0,6	BCPR7ES	3330		BCPR7EIX
Y 1.1 Elefantino Blu		1.1	40	05.97 - 04.00	176B2.000	4	0,9	BKR6E	6962	28	LPG 1

Code *l* kW

Cyl.



Stock-No.



LPG/CNG

**LANCIA  
YPSILON (Y)**

Y 1.1 Elefantino Blu		1.1	40	05.97 - 09.00	176B2.000	4	0,8	BCPR6ES	2330	12	LPG 3
Y 1.2 8 V		1.2	44	01.96 - 03.97	840.A3.000	4	0,8	BCPR6ES	2330	12	LPG 3
Y 1.2 8 V CVT		1.2	44	01.96 - 10.99	840 A3.000	4	0,8	BCPR6ES	2330	12	LPG 3
Y 1.2 8 V Elefantino Blu		1.2	44	10.99 - 09.03	188A4.000	4	0,9	BKR5EZ	7642	36	LPG 1
Y 1.2 16V Elefantino Blu /Rosso		1.2	59	10.00 - 11.02	188A5.000	4	0,9	DCPR8E-N	5692		LPG 8
Y 1.2 16V		1.2	63	04.97 - 03.00	176B9.000	4	0,9	DCPR8E	4339		LPG 8
Y 1.2 16V,LE,LS,LX, Elefantino Rosso		1.2	63	04.97 - 04.00	176B9.000	4	0,9	DCPR8E	4339		LPG 8
Y 1.2 16V LE		1.2	63	02.98 - 09.00	176B9.000	4	0,9	DCPR8E	4339		LPG 8
Y 10 1.3 G.T.		1.3	53	11.87 - 10.96	146A5.046	4	0,8	BPR6ES	7822	2	LPG 2
Y 1.4		1.4	55	01.96 - 12.97		4		BCPR6ET	2197		LPG 3
Y 1.4 12V		1.4	55	01.96 - 01.98	840 A2.000 - 4.000	4		BKR6EKC	2848	26	LPG 1
Y 1.4 i.e. 12V		1.4	59	01.96 - 01.98	840A4.000	4		BKR6EKC	2848	26	LPG 1

**YPSILON (843)**

Ypsilon 1.2 8V	843	1.2	44	09.03 - 10.04	188A4.000	4	0,9	BKR5EZ	7642	36	LPG 1
Ypsilon 1.2	843	1.2	44	10.04 -	188A4.000	4	1,0	DCPR7E-N-10	4983		LPG 8
Ypsilon 1.2	843	1.2	51	09.10 -	169A5000	4	1,0	ZKR7A-10	1691		LPG 8
Ypsilon 1.2 16V	843	1.2	57	09.03 - 02.05	188A5.000	4	0,9	DCPR7E-N	4795		LPG 8
Ypsilon 1.2 16V	843	1.2	57	02.05 -	188A5.000	4	1,0	DCPR7E-N-10	4983		LPG 8
Ypsilon 1.3 MJT	843	1.3	51	10.03 - 06	188A4000	4		Y8003J	97256	62	
Ypsilon 1.3 D Mjet EURO IV	843	1.3	55	09.06 -	199A2000	4		Y8003J	97256	62	
Ypsilon 1.3 D Mjet EURO V	843	1.3	55	11 -	199A2000	4		Y9001AS	97719	72	
Ypsilon 1.3 D Mjet	843	1.3	66	09.06 -	199A3000	4		Y8003J	97256	62	
Ypsilon 1.3 D Mjet	843	1.3	77	09.07 -	199A3000	4		Y8003J	97256	62	
Ypsilon 1,4	843	1.4	57	09.06 -	350A1000	4	1,0	ZKR7A-10	1691		LPG 8
Ypsilon 1.4 LPG	843	1.4	57	04.09 -	350A1000	4	1,0	ZKR7A-10	1691		LPG 8
Ypsilon 1.4 16V	843	1.4	70	09.03 - 02.05	843A1.000	4	0,9	DCPR7E-N	4795		LPG 8
Ypsilon 1.4 16V	843	1.4	70	02.05 -	843A1.000	4	1,0	DCPR7E-N-10	4983		LPG 8

**YPSILON (846)**

Ypsilon 0.9 Twinair	846	0.9	63	05.11 -	312A2000	2	0,8	ILKR9G8	97168		
Ypsilon 1.2 LPG	846	1.2	49	05.11 -	169A4000	4	0,8	ZKR7AI-8	92402		
Ypsilon 1.2	846	1.2	51	05.11 -	169A4000	4	1,0	ZKR7A-10	1691		LPG 8
Ypsilon 1.3 D Multijet	846	1.3	70	05.11 -	199B1000	4		Y9001AS	97719	72	

**ZETA**

Zeta 1.9 TD		1.9	68	04.95 -	XUD 9TE	4		Y-924J	7906	1	
Zeta 2.0 i.e.		2.0	89	04.99 - 12.01	RFV	4		BKR5EK	7956	23	LPG 1
Zeta 2.0 16V		2.0	100	07.00 - 09.02	RFN	4	0,9	LF5B	7113		LPG 7
Zeta 2.0 i.e. Turbo		2.0	108	10.94 - 03.99	RGX	4		BKR6EK	2288	20	
Zeta 2.1 TD		2.1	80	07.96 -	XUD11ATE	4		Y-924J	7906	1	

**LAND ROVER  
COUNTRY**

Country TD		2.5	83	01.89 -		4		Y-909R	4602		
------------	--	-----	----	---------	--	---	--	--------	------	--	--

**DEFENDER**

Defender TDI		2.5	83	11.89 - 10.98	200/300 Gemini 1	4		Y-729U	4119	34	
Defender 2.5 Td5		2.5	90	11.98 - 09.07	Td5	4		Y-605J	4309		
Defender TDI 90 & 110		2.5	102	01.99 -		4		Y-924J	7906	1	
Defender 2.5		2.5		90 -		6	0,8	BP6ES	7811	4	LPG 2
Defender 3.5 V8		3.5		90 -		8	0,9	BPR5ES	7422	6	LPG 2



Code *l* kW

Cyl.

Stock-No.  
**VEFINE****LPG/CNG****LAND ROVER****DISCOVERY**

Discovery TDi ES		2.5	83	09.89 -		4	☑	Y-729U	4119	34	
Discovery TDI		2.5	83	09.89 - 01.99	200/300 Gemini 1	4	☑	Y-729U	4119	34	
Discovery TDi Vogue ES		2.5	90	10.93 - 08.98		4	☑	Y-729U	4119	34	
Discovery 2.5 Td5		2.5	102	09.98 - 08.04	Td5	4	☑	Y-605J	4309		
Discovery V8		3.5	107	09.89 - 01.99	V8 3.5	8	0,8	BPR6ES	7822	2	LPG 2
Discovery V8		3.9	136	02.99 -	V8	8	0,8	BPR6ES	7822	2	LPG 2
Discovery 2.0		2.0	99	06.93 - 01.99	Mpi	4	0,9	BKR6E	6962	28	LPG 1
Discovery		4.0		94 - 99		8	0,8	BPR6ES	7822	2	LPG 2
Discovery		4.0		10.98 -		8	1,1	PFR6N-11	3546		LPG 1
Discovery 3 4.4		4.4	220	07.04 - 10.08		8	1,0	IFR5N10	7866		

**FREELANDER 1**

Freelander 1.8		1.8	87	97 -	K SERIES	4	1,1	PFR6N-11	3546		LPG 1
Freelander 2.0 TD		2.0	71	10.97 - 08.98	20 T2R	4	☑	Y-730U	6704	17	
Freelander 2.0 TD4		2.0	80	08.98 -	M47D20 (BMW)	4	☑	Y-507J	2691	32	
Freelander 2.0		2.0		01 -	KV6	6	1,1	PFR6N-11	3546		LPG 1
Freelander 2.5 Tdi		2.5	102	05.98 -		5	☑	Y-924J	7906	1	
Freelander 2.5 V6		2.5	130	09.00 -	KV6	6	1,1	PFR6N-11	3546		LPG 1

**FREELANDER 2**

Freelander 2 2.2 TD4 to chassis no. AH999999		2.2	110	08.10 -	DW12BTED4	4	☑	YE08	4966		
Freelander 2 2.2 TD4 to chassis no. AH999999		2.2	112	01.07 -	224DT	4	☑	YE08	4966		
Freelander 2 2.2 TD4 to chassis no. AH999999		2.2	118	10.06 -	224DT	4	☑	YE08	4966		
Freelander 2 2.2 SD4 to chassis no. AH999999		2.2	140	08.10 -		4	☑	YE08	4966		

**RANGE ROVER**

Range Rover		4.2		10.92 - 12.94	V8	8	0,8	BPR6ES	7822	2	LPG 2
Range Rover		4.4	210	09.99 -	BMW M62 B44	8		BKR6EQU	3199	30	LPG 1
Range Rover		2.5	66	04.86 - 10.92	VM UNIT (NOT GEMINI ENG.)	4	☑	Y-909R	4602		
Range Rover TDI		2.5	83	01.86 - 12.94	ETC 9091 N	4	☑	Y-729U	4119	34	
Range Rover Vogue TD		2.5	87	01.90 - 09.94	VM 425 SLIRR	4	☑	Y-924J	7906	1	
Range Rover Vogue TD		2.5	87	01.90 - 09.94	VM HR-492	4	☑	Y-924J	7906	1	
Range Rover		2.5	100	09.94 -	M51 D25 (BMW)	6	☑	Y-924J	7906	1	
Range Rover		2.5		09.89 -	200/300 Gemini 1	4	☑	Y-729U	4119	34	
Range Rover		4.6	160	01.99 -		8	1,1	PFR6N-11	3546		LPG 1
Range Rover		4.6	165	09.94 - 10.98	V8	8	0,8	BPR6ES	7822	2	LPG 2
Range Rover		3.9	127	11.88 - 10.95	V8	8	0,8	BPR6ES	7822	2	LPG 2
Range Rover 3		3.0	130	03.02 -	M57 D30 BMW	6	☑	Y-507J	2691	32	
Range Rover		4.0	131	01.99 - 02		8	1,1	PFR6N-11	3546		LPG 1
Range Rover		4.0		09.94 - 12.98		8	0,8	BPR6ES	7822	2	LPG 2

**RANGE ROVER 4**

Range Rover 4 4.2 Supercharged		4.2	291	05.05 -	AJ41	8	1,0	IFR5N10	7866		
Range Rover 4 4.4		4.4	225	05.05 -	AJ41	8	1,0	IFR5N10	7866		
Range Rover 4 5.0		5.0	276	09.09 -	AJ133	8	1,0	ILKAR7C10	94940		
Range Rover 4 5.0 Supercharged		5.0	375	09.09 -	AJ133	8	1,0	ILKAR7C10	94940		

Code *l* kW

Cyl.



Stock-No.



LPG/CNG

**LAND ROVER  
RANGE ROVER EVOQUE**

Range Rover Evoque 2.0	L538	2.0	177	06.11 -	204PT	4	0,8	ILTR6G8G	96621		
------------------------	------	-----	-----	---------	-------	---	-----	----------	-------	--	--

**RANGE ROVER SPORT**

Range Rover Sport 4.2 Supercharged		4.2	287	02.05 -	AJ41	8	1,0	IFR5N10	7866		
Range Rover Sport 4.4		4.4	220	02.05 -	AJ41	8	1,0	IFR5N10	7866		
Range Rover Sport 5.0		5.0	276	07.09 -	AJ133	8	1,0	ILKAR7C10	94940		
Range Rover Sport 5.0 Supercharged		5.0	372	01.10 -	AJ133	8	1,0	ILKAR7C10	94940		
Range Rover Sport 5.0 Supercharged		5.0	375	09.09 -	AJ133	8	1,0	ILKAR7C10	94940		

**LEXUS  
CT**

CT 200h Hybrid	ZWA10	1.8	73	12.10 -	2ZR-FXE	4	1,1	ILKAR7B11	4912		
----------------	-------	-----	----	---------	---------	---	-----	-----------	------	--	--

**ES**

ES 300	MCV20	3.0		01.00 - 03	2JZ-GE	6		BKR6EKP-11	3452		
ES 300	MCV30	3.0		01.04 -	1MZ-FE	6	1,1	IFR6T11	4589		

**GS**

GS 250	GRL11	2.5	154	03.12 -	4GR-FSE	6	1,1	DFH6B-11A	1501		
GS 300	JZS147	3.0	156	93 - 99	2JZ-GE	6	1,1	BKR5EP-11	3440		LPG 1
GS 300	JZS160 / UZS161	3.0	161	01.02 -	2JZ-GE	6	1,1	BKR6EP-11	2978		LPG 1
GS 300		3.0	163	97 -	2TZ-GE	6		BKR6EKP-11	3452		
GS 300	UZS190 / GRS190	3.0	170	04.05 -	3GR-FE	6	1,1	DFH6B-11A	1501		
GS 300	UZS190 / GRS190	3.0	183	04.05 - 08.07	3GR-FSE	6	1,1	DFH6B-11A	1501		
GS 300	UZS190 / GRS190	3.0	183	09.07 -	3GR-FSE	6	1,1	ILFR6T11	4904		
GS 300	JZS160	3.0		01.00 -	1MZ-FE	6		BKR6EKP-11	3452		
GS 300	UZS190 / GRS190	3.0		05.05 -	3GR-FSE	6	1,1	IFR6T11	4589		
GS 430	JZS160 / UZS161	4.3	208	01.02 -	3UZ-FE	6	1,1	IFR6T11	4589		
GS 430	GRS190	4.3	208	08.05 -	3UZ-FE	8	1,1	IFR6T11	4589		
GS 430	UZS190	4.3	208	08.05 -	3UZ-FE	8	1,1	IFR6T11	4589		
GS 450h Hybrid	GWS191	3.5	218	02.06 - 11.11	2GR-FSE	6	1,1	DFH6B-11A	1501		
GS 450h Hybrid	GWS191	3.5	254	02.06 - 11.11	2GR-FSE	6	1,1	DFH6B-11A	1501		
GS 460	URS190	4.6	255	09.07 -	1UR-FSE	8	1,1	DFH6B-11A	1501		

**IS**

IS 200	GXE10	2.0	114	01.00 -	1G-FE	6	1,1	IFR6T11	4589		
IS 250	GSE20	2.5	153	08.05 -	4GR-FSE	6	1,1	DFH6B-11A	1501		
IS 300	GXE10/ JCE10/15	2.0	114	09.01 -	1G-FE	6	1,1	IFR6T11	4589		
IS 300	GXE10/ JCE10/15	3.0		01.02 -	2JZ-GE	6	1,1	BKR6EP-11	2978		LPG 1

**IS C**

IS C	GSE20	2.5	153	04.09 -	4GR-FSE	6	1,1	DFH6B-11A	1501		
------	-------	-----	-----	---------	---------	---	-----	-----------	------	--	--

**ISF**

IS-F	USE20	5.0	311	11.07 -	2UR-GSE	8	1,1	DFH6B-11A	1501		
------	-------	-----	-----	---------	---------	---	-----	-----------	------	--	--

**LS**

LS 400		4.0	180	90 - 94	1UZ-FE Cat.	8	1,1	BKR6EP-11	2978		LPG 1
--------	--	-----	-----	---------	-------------	---	-----	-----------	------	--	-------

Code *l* kW

Cyl.



Stock-No.



LPG/CNG

**LEXUS****LS**

LS 400		4.0	194	10.94 - 12.99	1UZ-FE	8	0,8	BKR6EP-8	2215		LPG 1
LS 400		4.0		06.90 - 06.97	1UAZ-FE	8	1,1	BKR5EP-11	3440		LPG 1
LS 400	UCF20	4.0		01.00 -	1UZ-FE	8	1,1	IFR6T11	4589		
LS 430	UCF30	4.3	207	08.00 -	3UZ-FE with TWC	8	1,1	IFR6T11	4589		
LS 430	UCF30	4.3		08.00 -	3UZ-FE without TWC	8	0,8	BKR6EYA	2249		LPG 1
LS 460	USF40/41	4.6	255	09.06 -	1UR-FE	8	1,1	ILFR6T11	4904		
LS 460 AWD	USF45/46	4.6	270	12.08 -	1UR-FSE	8	1,1	DFH6B-11A	1501		
LS 460	USF40/41	4.6	280	04.06 -	1UR-FSE	8	1,1	DFH6B-11A	1501		
LS 460	USF46	4.6	280	12.08 -	1UR-FSE	8	1,1	DFH6B-11A	1501		
LS 600h Hybrid	UVF45/46	5.0	290	04.07 -	2UR-FSE	8	1,1	DFH6B-11A	1501		

**LX**

LX 470 (UZJ100)		4.7		01.00 -	2UZ-FE with TWC	8	1,1	IFR6T11	4589		
LX 470 (UZJ100)		4.7		01.00 -	2UZ-FE without TWC	8	0,8	BKR6EYA	2249		LPG 1

**RX**

RX 300	MCU10	3.0	148	01.98 - 02.03	1MZ-FE	6	1,1	IFR6T11	4589		
RX 300	MCU15	3.0	150	07.00 - 06	1MZ-FE	6	1,1	IFR6T11	4589		
RX 300	MCU35 / 38	3.0		01.04 - 06	1MZ-FE	6	1,1	IFR6T11	4589		
RX 300	MCU35 / 38	3.3		01.04 - 06	3MZ-FE	6	1,1	IFR6T11	4589		
RX 330	MCU35 / 38	3.0		01.04 -	1MZ-FE	6	1,1	IFR6T11	4589		
RX 330	MCU35 / 38	3.3	171	04.03 - 01.06	3MZ-FE	6	1,1	IFR6T11	4589		
RX 400 h	MHU38	3.3	155	03.05 -	3MZ-FE	6	1,1	IFR6T11	4589		

**SC 430**

SC 430	UZZ40	4.3	210	05.01 -	3UZ-FE	8	1,1	IFR6T11	4589		
--------	-------	-----	-----	---------	--------	---	-----	---------	------	--	--

**LOTUS**

Elan SE 16V Turbo		1.6		10.89 -		4	0,8	BKR6E	6962	28	LPG 1
Elan 1.6 16V		1.6		10.89 -		4	1,1	BKR6E-11	2756	14	LPG 1
Elise		1.8	88	96 -	K- SERIES (Including) VVC	4	1,1	PFR6N-11	3546		LPG 1
Elise 111S		1.8	107	99 -		4	1,1	PFR6N-11	3546		LPG 1
Esprit 2.0 Turbo 16V GT3		2.0		10.96 -		4	0,8	BPR6EKN	1128		
Esprit Turbo SE		2.2	197	89 -	910S	4	0,6	BPR6EKN	1128		
Esprit HC		2.2		85 -	DOHC	4	0,8	BPR7ES	2023	19	BPR8EIX
Esprit Turbo		2.2		87 -		4	0,8	BPR6ES	7822	2	LPG 2
Esprit S4		2.2		93 - 07.96		4	0,6	BPR6EKN	1128		
Esprit Sport 300		2.2		93 -		4	0,6	BPR6EKN	1128		
Esprit SE 2.2		2.2		11.94 - 07.96	Cat.	4	0,8	BPR6EKN	1128		
Esprit		3.5	260	96 -	918	8		BKR6EKC	2848	26	LPG 1
Europa Special, Twin-Cam, S2, S1				85 -		4	0,8	BP7ES	2412		BPR8EIX
Exige 1.8 16V		1.8	132	07.00 -		4	0,8	BKR7E	6097		BKR8EIX

**MAHINDRA**

CJ 340 Classic D		2.1	48	93 -	XD 4.90	4	█	Y-208T	1250		
CJ 540 D		2.1	48	93 -	XD 4.90	4	█	Y-208T	1250		
CJ3				04.86 -	Peugeot	4	█	Y-924J	7906	1	
CJ5				04.86 -	Peugeot	4	█	Y-924J	7906	1	

Code *l* kW

Cyl.



Stock-No.



B-PRO/VER\*\*

LPG/CNG

**MASERATI**

2.24 V		2.0	180	88 -	AM 475	4	0,9	DCPR8E	4339		LPG 8
228 I		2.8	184	12.87 -	Bi Turbo Cat.	6	0,8	BP8ES	2912		BPR9EIX
3200 GT		3.2	271	12.98 - 09.01	585	8	0,7	PMR8A	5851		
4.18 V		2.0		02.91 -		6	0,8	BP8ES	2912		BPR9EIX
4.24 V / Spider 24V		2.0	180	90 -	475	6	0,9	DCPR8E	4339		LPG 8
420 / I / S / SI /		2.0	138	01.87 -	470	6	0,8	BP8ES	2912		BPR9EIX
422		2.0	164	88 -	AM 471	6	0,8	BP8ES	2912		BPR9EIX
430		2.8	182	02.88 -	473 Cat.	6	0,8	BP8ES	2912		BPR9EIX
Biturbo		2.5		85 -		6	0,7	BP8ES	2912		BPR9EIX
Biturbo		2.8		85 -		6	0,7	BP8ES	2912		BPR9EIX
Coupè GT / Cambiocorsa		4.2	287	06.02 - 11.03	F136R	8	0,7	PMR8A	5851		
Coupè GT / Cambiocorsa		4.2	287	12.03 -	F136R	8		PMR8B	6378		
Ghibli		2.0	209	09.96 -	496	6	0,7	DCPR9E	2641		
Ghibli V6		2.8	209	11.95 -		6	0,8	DCPR9E	2641		
GranSport		4.2	294	09.04 -	F136S	8		PMR8B	6378		
Karif		2.8	165	04.88 -	437 Cat.	6	0,8	BP8ES	2912		BPR9EIX
Quattroporte i. V6 24V		2.0	211	11.94 - 99	475	6	0,6	DCPR9E	2641		
Quattroporte i. V6 24V		2.8	209	11.95 - 01.99		6	0,8	DCPR9E	2641		
Quattroporte V6 Evoluzione		2.8	260	02.99 - 12.01	588	6	0,9	DCPR8E	4339		LPG 8
Quattroporte V8 Evoluzione		3.2	270	02.99 - 02	578	8	0,7	PMR8A	5851		
Quattroporte 4,2		4.2	294	11.02 - 11.03		8	0,7	PMR8A	5851		
Quattroporte 4,2		4.2	294	12.03 -	F136S	8		PMR8B	6378		
Racing		2.0	194	02.91 -	475	6	0,7	DCPR9E	2641		
Shamal I Turbo 32V		3.2	240	02.91 - 02.96	AM 479 Cat.	8	0,9	DCPR8E	4339		LPG 8
Spyder		2.8	165	01.90 -	473 Cat.	6	0,8	BP8ES	2912		BPR9EIX
Spyder GT/Cambiocorsa		4.2	287	10.01 - 11.03	F136R	8	0,7	PMR8A	5851		
Spyder GT/Cambiocorsa		4.2	287	12.03 -	F136R	8		PMR8B	6378		

**MAYBACH**

Maybach 57/ 62 (240)		5.5	404	09.02 -	M 285.950	12	0,8	IFR6Q-G	5648		
Maybach 62S (240)		6.0	450	09.05 -	M 285.980	12	0,8	IFR6Q-G	5648		

**MAZDA****121**

121 16V		1.25	55	00 - 02	DHB / DHC / DHD / DHF	4	1,3	PTR5A-13	2467	25	LPG 4
121 ZQ		1.3	37	03.96 -	JJA / JJC / JJE / J4C	4	1,0	PTR5D-10	3784	31	LPG 5
121 DA Fgst—> 200000		1.3	44	03.96 -	B3	4	0,9	BPR5ES	7422	6	LPG 2
121 ZQ		1.3	55	03.96 -	DHA Zetec (FORD)	4	1,3	PTR5A-13	2467	25	LPG 4
121		1.8	44	03.96 -	RTJ / RTK	4	█	Y-910R	4751	3	

**2**

2 1.25 DY Fgst 3*00001—>		1.25	55	03 - 07	MZI FUJA / F8JB	4	1,3	PTR5A-13	2467	25	LPG 4
2 1.25 DY Fgst 3*00001—>		1.25	55	03 - 07	MZI FUJB / F8JA	4	1,3	PTR5A-13	2467	25	LPG 4
2 1.3 (DE)		1.3	55	10.07 -	ZJ-VE / FUJA	4	1,3	IFR5E13	6903		IFR6E11
2 1.3 DY Fgst 3*00001—>		1.3	59	03 - 07	MZI DOHC FXJA / FXJB	4	1,3	PTR5A-13	2467	25	LPG 4
2 1.3 (DE)		1.3	63	10.07 -	ZJ-VEM / FXJA	4	1,3	IFR5E13	6903		IFR6E11
2 1.4 Di Turbo DY Fgst 3*00001—>		1.4	50	04.03 - 07	MZ-CD-SOHC F6JA	4	█	YE04	1684	40	
2 1.4 MZ-CD		1.4	50	07 -	F6JA	4	█	YE04	1684	40	
2 1.5 (DE)		1.5	76	10.07 -	ZY-VE / FYJA	4	1,3	IFR5E13	6903		IFR6E11
2 1.6 DY Fgst 3*00001—>		1.6	74	03 - 07	MZI DOHC FYJA	4	1,3	PTR5A-13	2467	25	LPG 4

**3**

3 1.4	BK	1.4	59	04 - 09	ZJ	4	1,1	BKR5E-11	6953	33	LPG 1
-------	----	-----	----	---------	----	---	-----	----------	------	----	-------

Fgst = Chassis No.

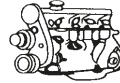
Code *l* kW

Cyl.



Stock-No.

**MAZDA****3**

3 1.4	BK	1.4	62	10.03 - 03.06	ZJ07	4	1,1	BKR5E-11	6953	33	LPG 1
3 1.6	BK	1.6	77	10.03 -	CE	4	1,1	BKR5E-11	6953	33	LPG 1
3 1.6	BK	1.6	77	10.03 - 09	Z601 / Z627	4	1,1	BKR5E-11	6953	33	LPG 1
3 1.6 MZR	BL	1.6	77	06.09 -	Z668	4	1,3	IFR5E13	6903		IFR6E11
3 2.0 MZR-CD	BK	2.0	105	09.07 - 01.09	RF7J	4	■	Y-529J	4664		
3 2.0 Zündkerze am Fzg. ermitteln !	BK	2.0	110	10.03 - 01.04	LF17 / 50 / 72 / LFN7 / LFN8	4	1,3	ILTR5A-13G	3811		ILTR6A-13G
3 2.0 Zündkerze am Fzg. ermitteln !	BK	2.0	110	02.04 - 12.09	LF17 / 50 / 72 / LFN7 / LFN8	4	1,3	TR5AI-13	90813		LPG 5
3 2.0 MZR	BL	2.0	110	02.09 -	LF5H / LF5W / LFZ2	4	1,3	ILTR5A-13G	3811		ILTR6A-13G
3 2.0 MZR DISI	BL	2.0	111	02.09 -	LF5H / LF5W / LFZ2	4	1,3	ILTR5A-13G	3811		ILTR6A-13G
3 2.3 MPS Turbo	BL	2.3	191	05.09 -	L3Y7	4	0,7	SILTR6A7G	95369		
3 2.3 MPS	BK	2.3	191	06.06 - 01.09	L3M6	4	0,8	ILTR6A-8G	3787		
3 2.2 D Skyactiv-D 150	BM	2.2	110	07.13 -	SHY1	4	■	CZ163	92703		

**323**

323 (BJ) Fgst 400001—>		1.4	53	02 -	B3 SOHC	4	1,1	BKR5E-11	6953	33	LPG 1
323 (BA) Fgst 300001 —>		1.4	54	09.94 -	B3	4	1,1	BKR6E-11	2756	14	LPG 1
323 (BJ) Fgst 100001—>		1.4	54	09.98 -	B3	4	1,1	BKR5E-11	6953	33	LPG 1
323 (BA) Fgst 100001—>		1.5	65	09.94 -	Z5 Cat.	4	1,1	BKR5E-11	6953	33	LPG 1
323 (BJ) Fgst 100001 —>		1.5	65	09.98 -	ZL	4	1,1	BKR5E-11	6953	33	LPG 1
323 TD BF—>Fgst 300001		1.7	60	99 -	4EE1-T	4	■	Y-603J	8838	60	
323		1.8	84	02.97 -	B6D	4	1,1	BKR5E-11	6953	33	LPG 1
323 GTR Turbo		1.8	136	95 -		4	1,1	BKR6EIX-11	3764		LPG 1
323		1.8		89 -	BP DOHC Cat.	4	1,1	BKR6E-11	2756	14	LPG 1
323		1.8		89 -	BP EGI Cat.	4	0,8	BKR5E	7938	35	LPG 1
323 Turbo		1.8		89 -	BP	4	1,1	BKR6E-11	2756	14	LPG 1
323 (BA) Fgst 300001 —>		1.9	84	09.94 -	BP 16V Cat.	4	1,1	BKR5E-11	6953	33	LPG 1
323 (BJ) Fgst 100001 —>		1.9	84	09.98 -	FP	4	1,1	BKR5E-11	6953	33	LPG 1
323 (BJ) Fgst 400001—>		2.0	96	02 - 04	FS7G / FS7E DOHC (High Power)	4	1,1	ZFR5F-11	2262		LPG 6
323 F (BJ)		2.0	100	10.00 - 10.03	RF4F	4	■	Y-529J	4664		
323 (BA) Fgst 100001 —>		2.0	106	09.94 - 10.98	KF DOHC V6	6	1,1	BKR6E-11	2756	14	LPG 1
323 (BA) Fgst 500001 —>		2.0	106	08.94 - 10.98	KF DOHC V6	6	1,1	BKR6E-11	2756	14	LPG 1

**5**

5 1.8	CR19	1.8	85	06.05 -	L8	4	1,3	TR5AI-13	90813		LPG 5
5 2.0 CD	CR19	2.0	81	02.05 - 05.10	RF7J	4	■	Y-529J	4664		
5 2.0 CD	CR19	2.0	105	02.05 - 05.10	RF7J	4	■	Y-529J	4664		
5 2.0	CR19	2.0	107	03.05 - 05.10	LFF7	4	1,3	TR5AI-13	90813		LPG 5
5 2.3	CR19	2.3		05 -	L3-VE	4	1,3	TR5AI-13	90813		LPG 5
5 1.8 Zündkerze am Fzg. ermitteln !	CW19	1.8	85	06.10 -	L850	4	1,3	TR5AI-13	90813		LPG 5
5 1.8 Zündkerze am Fzg. ermitteln !	CW19	1.8	85	06.10 -	L850	4	1,3	ILTR6A-13G	3789		
5 2.0 Zündkerze am Fzg. ermitteln !	CW19	2.0	106	06.10 -	LFZB	4	1,3	TR5AI-13	90813		LPG 5
5 2.0 Zündkerze am Fzg. ermitteln !	CW19	2.0	106	06.10 -	LFZB	4	1,3	ILTR6A-13G	3789		
5 2.0 Zündkerze am Fzg. ermitteln !	CW19	2.0	110	06.10 -	LF5H	4	1,3	TR5AI-13	90813		LPG 5
5 2.0 Zündkerze am Fzg. ermitteln !	CW19	2.0	110	06.10 -	LF5H	4	1,3	ILTR6A-13G	3789		

**6**

6 Fgst 100001—>	GG	1.8	88	06.02 - 07	MZR-L8 DOHC	4	1,3	ITR6F13	4477		LPG 5
6 Sport-Kombi Fgst 100001—>	GY	1.8	88	06.02 - 07	MZR-L8 DOHC	4	1,3	ITR6F13	4477		LPG 5
6		1.8	88	09.07 -	L823	4	1,3	TR5AI-13	90813		LPG 5

Fgst = Chassis No.

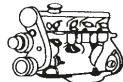

Code *l* kW

Cyl.



Stock-No.

V-**LINE**

10-15-20-25-30-35-40-45-50-55-60-65-70-75-80-85-90-95-100-105-110-115-120-125-130-135-140-145-150-155-160-165-170-175-180-185-190-195-200-205-210-215-220-225-230-235-240-245-250-255-260-265-270-275-280-285-290-295-300-305-310-315-320-325-330-335-340-345-350-355-360-365-370-375-380-385-390-395-400-405-410-415-420-425-430-435-440-445-450-455-460-465-470-475-480-485-490-495-500-505-510-515-520-525-530-535-540-545-550-555-560-565-570-575-580-585-590-595-600-605-610-615-620-625-630-635-640-645-650-655-660-665-670-675-680-685-690-695-700-705-710-715-720-725-730-735-740-745-750-755-760-765-770-775-780-785-790-795-800-805-810-815-820-825-830-835-840-845-850-855-860-865-870-875-880-885-890-895-900-905-910-915-920-925-930-935-940-945-950-955-960-965-970-975-980-985-990-995-1000

LPG/CNG

**MAZDA****6**

6 2.0 DI	GG	2.0	89	10.02 - 09.07	RF5C	4	▣	Y-529J	4664		
6 2.0 DI	GG	2.0	100	10.02 - 09.07	RF5C	4	▣	Y-529J	4664		
6 2.0 Zündkerze am Fzg. ermitteln !	GG	2.0	104	06.02 - 09.07	LF17 / LF18	4	1,3	ITR6F13	4477		LPG 5
6 2.0 Zündkerze am Fzg. ermitteln !	GG	2.0	104	06.02 - 09.07	LF17 / LF18	4	1,3	ILTR5A-13G	3811		ILTR6A-13G
6 2.0 Sport-Kombi Fgst 100001—>	GY	2.0	104	06.02 - 02.05	LF17 / LF18	4	1,3	ILTR5A-13G	3811		ILTR6A-13G
6 2.0 DI	GG	2.0	105	03.05 - 09.05	RF7J	4	▣	Y-529J	4664		
6 2.0 Zündkerze am Fzg. ermitteln !	GG	2.0	108	03.05 - 09.07	LFH1 / LFF7	4	1,3	ITR6F13	4477		LPG 5
6 2.0 Zündkerze am Fzg. ermitteln !	GG	2.0	108	03.05 - 09.07	LFH1 / LFF7	4	1,3	ILTR5A-13G	3811		ILTR6A-13G
6 2.0 Sport-Kombi	GY	2.0	108	03.05 - 01.08	LFH1 / LFF7		1,3	ILTR5A-13G	3811		ILTR6A-13G
6 2.0	GH	2.0	108	08.07 -	L17 / LF95	4	1,3	ILTR5A-13G	3811		ILTR6A-13G
6		2.0		06.05 -	LF-VE	4	1,3	ILTR5A-13G	3811		ILTR6A-13G
6 Sport-Kombi 4WD Fgst 100001—>	GY	2.3	119	06.02 - 07	MZR-L3 DOHC	4	1,3	ITR6F13	4477		LPG 5
6 Fgst 100001—>	GG	2.3	122	06.02 - 07	MZR-L3 DOHC	4	1,3	ITR6F13	4477		LPG 5
6 Sport-Kombi Fgst 100001—>	GY	2.3	122	06.02 - 07	MZR-L3 DOHC	4	1,3	ITR6F13	4477		LPG 5
6		2.3	122	06.05 -	L3C1	4	1,3	ILTR5A-13G	3811		ILTR6A-13G
6 2.3 MPS Turbo		2.3	191	03.05 - 02.08	L3KG	4	1,3	ILTR5A-13G	3811		ILTR6A-13G
6 2.2 D Skyactiv-D 150 i-ELOOP	GJ2/GJ9	2.2	110	10.12 -	SHY1	4	▣	CZ163	92703		
6 2.2 D Skyactiv-D 175 i-ELOOP	GJ2/GJ9	2.2	129	10.12 -	SHY1	4	▣	CZ163	92703		

**626**

626		1.8	66	90 -	F8	4	1,1	BKR6E-11	2756	14	LPG 1
626		1.8	66	90 -	F8 Cat.	4	1,1	BKR6E-11	2756	14	LPG 1
626 (GF) Fgst 100001—>		1.8	66	07.97 -	FP DOHC	4	0,8	PZFR6F	7550		LPG 6
626 (GE) Fgst 434202 —>		1.9	66	09.94 -	FP DOHC	4	1,1	BKR6E-11	2756	14	LPG 1
626 (GF)		1.9	66	07.97 -	FP	4	0,8	PZFR6F	7550		LPG 6
626 (GF) Fgst 400001—>		1.9	74	00 -	FP DOHC	4	0,8	PZFR6F	7550		LPG 6
626 (GW) Fgst 208843—>		1.9	74	00 -	FP DOHC	4	0,8	PZFR6F	7550		LPG 6
626 (GE) Fgst 100001 —>		1.9	77	92 -	FP DOHC Cat.	4	1,1	BKR6E-11	2756	14	LPG 1
626 (GF) 2.0 DITD		2.0	66	04.98 - 10.02	RF3F	4	▣	Y-529J	4664		
626 (GF) 2.0 Turbo DI		2.0	74	04.98 - 10.02	RF2A	4	▣	Y-529J	4664		
626 DIDT GF Fgst 186527—>		2.0	74	09.98 -	RF	4	▣	Y-529J	4664		
626 DIDT Kombi GF Fgst 116329—>		2.0	74	09.98 -	RF	4	▣	Y-529J	4664		
626 (GF) 2.0 TD		2.0	81	10.00 - 10.02	RF4F	4	▣	Y-529J	4664		
626(USA)GE Fgst 802219—>		2.0	85	92 - 98	FS DOHC	4	1,1	BKR5E-11	6953	33	LPG 1
626 (GE) Fgst 4343202—>		2.0	85	94 -	FS DOHC Cat.	4	1,1	BKR6E-11	2756	14	LPG 1
626 (GF) Fgst 400001—>		2.0	85	00 -	FS DOHC	4	0,8	PZFR6F	7550		LPG 6
626 (GW) Fgst 200001—>		2.0	85	00 -	FS DOHC	4	0,8	PZFR6F	7550		LPG 6
626 (GF)		2.0	100	07.97 -	FS	4	0,8	PZFR6F	7550		LPG 6
626 (GF) Fgst 400001—>		2.0	100	00 -	FS DOHC High Power	4	0,8	PZFR6F	7550		LPG 6
626 (GW) Fgst 208843—>		2.0	100	00 -	FS DOHC High Power	4	0,8	PZFR6F	7550		LPG 6
626 (GE) Fgst 434202 —>		2.5	120	09.94 -	KL DOHC V6	6	1,1	ZFR5F-11	2262		LPG 6
626 (GE) Fgst 100001—>		2.5	121	92 - 94	KL DOHC V6 Cat.	6	1,1	ZFR6F-11	4291		LPG 6

**B SERIE**

B 2200		2.0		08.84 -	F 2	4	▣	Y-107R	1229		
B 2200		2.2		01.85 - 10.96	R 2	4	▣	Y-107R	1229		
B 2200		2.2		90 -	F2	4	0,9	BPR5ES	7422	6	LPG 2
B 2200		2.2		90 -	F2 EGI	4	1,1	BPR5ES-11	4424		LPG 2
B 2500 UF Fgst 702487—>		2.5	57	99 -	WL	4	▣	Y-701J	1566	39	
B 2600		2.6		90 -	G6	6	1,1	ZFR5F-11	2262		LPG 6
B Serie				97 - 11.02	WLT		▣	Y-701J	1566	39	

Fgst = Chassis No.

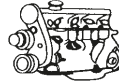
Code *l* kW

Cyl.

Stock-No.  
**VEFINE**  
E-FORWARD\*

LPG/CNG

**MAZDA****BT-50**

BT-50 2.5 MRZ-CD (CD)		2.5	105	08.06 -	WLAA	4	▣	Y-526J1	93283	69	
BT-50 3.0 CDVi (CD)		3.0	115	10.06 -	WEAT	4	▣	Y-526J1	93283	69	

**CX-5**

CX-5 2.2 D Skyactiv-D 150	KE	2.2	110	02.12 -	SHY1	4	▣	CZ163	92703		
CX-5 2.2 D Skyactiv-D 175	KE	2.2	129	04.12 -	SHY1	4	▣	CZ163	92703		

**CX-7**

CX-7 2.3 MZR DISI Turbo (ER8)	ER	2.3	190	10.07 - 05.09	L3K4 / L3-VDT	4	0,8	ILTR6A-8G	3787		
CX-7 2.3 MZR DISI Turbo (ER8)	ER	2.3	190	06.09 - 08.09	L3K4 / L3-VDT	4	0,7	SILTR6A7G	95369		
CX-7 2.3 MZR DISI Turbo (ER9)	ER	2.3	191	09.09 - 03.13	L3ZA	4	0,7	SILTR6A7G	95369		

**DEMIO**

Demio DW Fgst 100.001 →		1.4	46	98 - 03	B3 SOHC	4	1,1	BKR6E-11	2756	14	LPG 1
Demio DW Fgst 300001 →		1.4	46	00 - 03	B3 SOHC	4	1,1	BKR5E-11	6953	33	LPG 1
Demio DW Fgst 100.001 →		1.4	53	98 - 03	B3 (High Power)	4	1,1	BKR6E-11	2756	14	LPG 1
Demio DW Fgst 300001 →		1.5	55	05.00 - 03	B5 SOHC	4	1,1	BKR6E-11	2756	14	LPG 1

**E SERIE**

E 2000 SR Fgst → 600000		2.0	63	84 - 95	FE	4	0,8	BPR6ES	7822	2	LPG 2
E 2000 SR Fgst 700001 →		2.0	70	95 -	FE	4	1,1	BKR6E-11	2756	14	LPG 1
E 2000 SR Fgst X100001 →		2.0	70	99 -	FE	4	1,1	BKR5E-11	6953	33	LPG 1
E 2000		2.0		93 -	RF	4	▣	Y-107R	1229		
E 2200		2.2		02.83 - 92	F2	4	▣	Y-107R	1229		
E 2200		2.2		93 - 96	R2	4	▣	Y-107R	1229		
E 3000		3.0		93 -	L4DE		▣	Y-721RS	3687		
E 3000		3.0		93 -	VS		▣	Y-721RS	3687		
E Serie				97 -	R2		▣	Y-721RS	3687		

**MPV**

MPV LW Fgst Y100001 →		2.0	90	06.99 - 04.02	FS DOHC	4	1,1	ZFR5F-11	2262		LPG 6
MPV		2.0	100	97 - 06.02	WLT	4	▣	Y-701J	1566	39	
MPV LW Fgst 200001 →		2.3	104	05.02 -	MZR-L3 DOHC	4	1,3	ITR6F13	4477		LPG 5
MPV		2.5		02 -	AJ	6	1,0	TR5IX	7397		LPG 5
MPV		2.5		06 -	L3-VDT	6	0,8	ILTR6A-8G	3787		
MPV LV Fgst 100001 →		3.0	109	05.96 -	JE 12V	6	1,1	BKR6E-11	2756	14	LPG 1
MPV LV 52 Fgst 631983 →		3.0	113	09.94 -	JEE	6	1,1	ZFR6F-11	4291		LPG 6

**MX-3**

MX-3 EC		1.6	65	08.91 -	B6 SOHC Cat.	4	1,1	BKR5E-11	6953	33	LPG 1
MX-3 EC Fgst 208015 →		1.6	79	94 -	B6 DOHC	4	1,1	BKR6E-11	2756	14	LPG 1
MX-3 EC Fgst 208015 →		1.8	95	95 -	K8 DOHC	6	1,1	BKR5E-11	6953	33	LPG 1
MX-3 EC		1.8	98	08.91 -	K8 DOHC Cat.	6	1,1	BKR5E-11	6953	33	LPG 1

**MX-5**

MX-5 NA Fgst 308212 →		1.6	66		B6 DOHC	4	1,1	BKR6E-11	2756	14	LPG 1
MX-5 NA Fgst 200001 →		1.6	66	95 -	B6 DOHC	4	1,1	BKR6E-11	2756	14	LPG 1
MX-5 NB Fgst 100001 →		1.6	81	98 -	B6 DOHC	4	1,1	BKR5E-11	6953	33	LPG 1
MX-5 NA Fgst 100001 →		1.6	85	90 -	B6 DOHC Cat.	4	1,1	BKR6E-11	2756	14	LPG 1
MX-5		1.8	93	06 -		4	1,3	TR5AI-13	90813		LPG 5
MX-5 NA Fgst 308212 →		1.9	96		BP DOHC	4	1,1	BKR6E-11	2756	14	LPG 1
MX-5 NA Fgst 100000 →		1.9	96	94 -	BP DOHC Cat.	4	1,1	BKR6E-11	2756	14	LPG 1
MX-5 NB Fgst 300001 → Automatic		1.9	102	01 -	BP DOHC	4	1,1	BKR5E-11	6953	33	LPG 1
MX-5 NB Fgst 100001 →		1.9	103	98 -	BP DOHC	4	1,1	BKR5E-11	6953	33	LPG 1

Fgst = Chassis No.

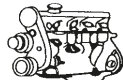
Code *l* kW

Cyl.

Stock-No.  
**VLINE**  
BY FORD/MAZDA

LPG/CNG

**MAZDA****MX-5**

MX-5 NB Fgst 121912—> (Anniversary)		1.9	103	00 -	BP DOHC	4	1,1	BKR5E-11	6953	33	LPG 1
MX-5 NB Fgst 200001—>		1.9	107	01 -	BP DOHC	4	1,1	BKR5E-11	6953	33	LPG 1
MX-5		2.0	118	01.06 -	LF-VE	4	1,3	ILTR6A-13G	3789		

**MX-6**

MX-6 GE Fgst 100001—>		2.0	85	92 -	FS DOHC Cat.	4	1,1	BKR6E-11	2756	14	LPG 1
MX-6 GE Fgst 400001—>		2.0	85	09.94 -	FS DOHC	4	1,1	BKR5E-11	6953	33	LPG 1
MX-6		2.2		92 -	F2	4	1,1	ZFR6F-11	4291		LPG 6
MX-6 GE Fgst 400001—>		2.5	120	09.94 -	KL DOHC V6	6	1,1	ZFR5F-11	2262		LPG 6
MX-6 GE Fgst 100001—>		2.5	121	92 -	KL DOHC V6 Cat.	6	1,1	ZFR5F-11	2262		LPG 6

**PREMACY**

Premacy 1.9 Fgst 100001—>151176	CP	1.9	74		FP DOHC	4	1,1	BKR5E-11	6953	33	LPG 1
Premacy 1.9 Fgst 151177—>	CP	1.9	74	06.99 -	FP DOHC	4	1,1	ZFR5F-11	2262		LPG 6
Premacy 1.9 Fgst 151177—>	CP	1.9	85	06.99 -	FP DOHC with VICS	4	1,1	ZFR5F-11	2262		LPG 6
Premacy 2.0 TD	CP	2.0	66	03.99 - 03.00	RF3F	4		Y-529J	4664		
Premacy 2.0 TD	CP	2.0	74	07.00 - 06.05	RF4F	4		Y-529J	4664		
Premacy 2.0 Fgst 300001—>	CP	2.0	96		FS DOHC	4	1,1	BKR5E-11	6953	33	LPG 1

**RANGER**

Ranger					S 2			Y-107T	1253		
--------	--	--	--	--	-----	--	--	--------	------	--	--

**RX-7**

RX-7 FB Fgst 700001—>			83		12 A			BR8ET	4221		BR9EIX
RX-7 FC Fgst—> 200000			110		13 B			BR10ET	7480		BR10EIX
RX-7 Turbo FC Fgst—>200000			133		RE 13 B		1,0	SD11A	1199		
RX-7 Turbo FC Fgst 200001—>			147	90 -	RE 13 B			BUR9EQ	5483		
RX-7 Turbo FD Fgst—>100000			176		13B-REV			BUR9EQP	5255		

**RX-8**

RX-8		2.6	141	09.03 - 12.10	13B-MSP			RE8C-L	5745		
					2+2sparkplug			+ RE9B-T	+2809		
RX-8 Sport		2.6	170	09.03 - 12.10	13B-MSP(high power)			RE8C-L	5745		
					2+2sparkplug			+ RE9B-T	+2809		

**T SERIE**

T 3000		3.0		93 -	HA			Y-771R	4262		
T 3000		3.0		93 -	L4DE			Y-771R	4262		
T Serie				97 -	VS			Y-771R	4262		

**TRIBUTE**

Tribute 2.0 EP Fgst M00001—>		2.0	91	04.00 -	Zetec 16V	4	1,3	PTR5A-13	2467	25	LPG 4
Tribute 2.0 EP2 Fgst M00001—>		2.0	91	04.00 -	Zetec 16V	4	1,3	PTR5A-13	2467	25	LPG 4
Tribute 2.0		2.0		03 -	Ford	4	1,3	PTR5A-13	2467	25	LPG 4
Tribute 2.3		2.3	110	03 -	MZR-L3 DOHC	4	1,3	ITR6F13	4477		LPG 5
Tribute 3.0 V6 EP Fgst M00001—>		3.0	145	04.00 -	Duratec 24V	6	1,0	TR5IX	7397		LPG 5
Tribute 3.0 V6 EP2 Fgst M00001—>		3.0	145	04.00 -	Duratec 24V	6	1,0	TR5IX	7397		LPG 5

**XEDOS 6**

Xedos 6 1.6 Fgst 210758—>	CA	1.6	79	09.94 -	B6 DOHC	4	1,1	BKR5E-11	6953	33	LPG 1
Xedos 6 2.0 Fgst 210758—>	CA	2.0	103	09.94 -	KF DOHC V6	6	1,1	BKR6E-11	2756	14	LPG 1
Xedos 6 2.0 Fgst 100001—>	CA	2.0	106	06.92 -		4	1,1	BKR6E-11	2756	14	LPG 1

**XEDOS 9**

Xedos 9 2.0 Fgst 200001—>	TA	2.0	105	10.93 -	KF V6 DOHC	6	1,1	BKR6E-11	2756	14	LPG 1
Xedos 9 2.3 Fgst 200001—>	TA	2.3	155	02.95 -	KJ V6 DOHC Miller Mot	6	0,8	PZFR5F	3741		LPG 6
Xedos 9 2.5 Fgst 400001—>	TA	2.5	120		KL-V6 DOHC	6	1,1	ZFR5F-11	2262		LPG 6

Fgst = Chassis No.

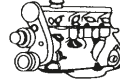
Code *l* kW

Cyl.



Stock-No.

LPG/CNG

**MAZDA****XEDOS 9**

Xedos 9 2.5 V6	TA	2.5	120	01 -	KJD	6	1,1	BKR5E-11	6953	33	LPG 1
Xedos 9 2.5 Fgst 200001—>	TA	2.5	128	10.93 -	KL-ZE V6	6	1,1	ZFR5F-11	2262		LPG 6

**MERCEDES****190 W201**

190 E 1.8	201	1.8	80	05.90 - 05.93	M 102.910	4	0,8	BP6EFS	3812	5	LPG 5
190 D	201	2.0	53	02.89 - 05.93	OM 601.911	4	█	Y-916J	5906	6	
190 E	201	2.0	87	09.85 - 08.93	M 102.962	4	0,8	BP6EFS	3812	5	LPG 5
190 E 2.3	201	2.3	97	09.86 - 05.93	M 102.985	4	0,8	BP6EFS	3812	5	LPG 5
190 D	201	2.5	66	02.89 - 05.93	OM 602.911	5	█	Y-916J	5906	6	
190 Turbo-D 2.5	201	2.5	90	02.89 - 05.93	OM 602.961	5	█	Y-916J	5906	6	
190 Turbo-D 2.5	201	2.5	90	02.89 - 05.93	OM 602.961	5	█	Y-918J	6285	2	
190 E 2.5 16V	201	2.5	143	09.88 - 05.93	M 102.990	4	0,8	BP6EFS	3812	5	LPG 5
190 E Evolution II 2.5 16V	201	2.5	173	05.90 - 05.93	M 102.992	4	0,8	BP6EFS	3812	5	LPG 5
190 E 2.6	201	2.6	118	09.86 - 05.93	M 103.942	6	0,8	BP6EFS	3812	5	LPG 5

**A W168**

A 140	168	1.4	60	10.97 - 08.04	M 166.940	4		BKUR5ET	2789	29	LPG 1
A 140	168	1.6	60	01.01 - 08.04	M 166.960	4		BKUR5ET	2789	29	LPG 1
A 160	168	1.6	75	10.97 - 08.04	M 166.960	4		BKUR5ET	2789	29	LPG 1
A 160 CDI	168	1.7	44	10.97 - 02.01	OM 668.941	4	█	Y-746R	4842	38	
A 160 CDI	168	1.7	55	02.01 - 08.04	OM 668.940	4	█	Y-746R	4842	38	
A 170 CDI	168	1.7	66	08.98 - 02.01	OM 668.940	4	█	Y-746R	4842	38	
A 170 CDI	168	1.7	70	02.01 - 08.04	OM 668.942	4	█	Y-746R	4842	38	
A 190	168	1.9	92	03.99 - 08.04	M 166.990	4		BKUR5ET	2789	29	LPG 1
A 210 Evolution	168	2.0	103	03.02 - 08.04	M 166.995	4		BKUR5ET	2789	29	LPG 1

**A W169**

A 150	169	1.5	70	09.04 -	M 266.920	4	0,9	BKR6EZB	4293		
A 170	169	1.7	85	09.04 -	M 266.940	4	0,9	BKR6EZB	4293		
A 160 CDI	169	2.0	60	09.04 -	OM 640.942	4	█	Y8002AS	6287	51	
A 180 CDI	169	2.0	80	09.04 -	OM 640.940	4	█	Y8002AS	6287	51	
A 200	169	2.0	100	09.04 -	M 266.960	4	0,9	BKR6EZB	4293		
A 200 Turbo	169	2.0	142	09.05 -	M 266.980	4	1,0	IFR6D10	5344		LPG 1
A 200 CDI	169	2.0	103	09.04 -	OM 640.941	4	█	Y8002AS	6287	51	

**A W176**

A 180 CDi	176	1.8	80	06.12 -	OM 651.901	4	█	CZ303	7865	54	
A 200 CDi	176	1.8	100	06.12 -	OM 651.901	4	█	CZ303	7865	54	
A 220 CDi	176	2.2	125	06.12 -	OM 651.930	4	█	CZ303	7865	54	

**B W245**

B 150	245	1.5	70	04.05 - 11	M 266.920	4	0,9	BKR6EZB	4293		
B 170	245	1.7	85	04.05 - 11	M 266.940	4	0,9	BKR6EZB	4293		
B 180 Cdi	245	2.0	80	04.05 - 10.07	OM 640.940	4	█	Y8002AS	6287	51	
B 180 Cdi	245	2.0	80	11.07 - 11	OM 640.940	4	█	CZ303	7865	54	
B 180 NGT	245	2.0	85	04.08 -	M 266.960	4	0,9	BKR6EZB	4293		
B 200	245	2.0	100	04.05 - 11	M 266.960	4	0,9	BKR6EZB	4293		
B 200 Cdi	245	2.0	100	04.05 - 11.07	OM 640.941	4	█	Y8002AS	6287	51	
B 200 Cdi	245	2.0	100	12.07 - 11	OM 640.941	4	█	CZ303	7865	54	
B 200 Cdi	245	2.0	103	04.05 - 11.07	OM 640.941	4	█	Y8002AS	6287	51	
B 200 Cdi	245	2.0	103	12.07 - 11	OM 640.941	4	█	CZ303	7865	54	
B 200 Turbo	245	2.0	142	04.05 - 11	M 266.980	4	1,0	IFR6D10	5344		LPG 1

Fgst = Chassis No.

Code *l* kW

Cyl.

Stock-No.  
**VLIVE**  
10-15-10-15-10-15-10-15

LPG/CNG

**MERCEDES****B W246**

B 180 CDI	246	1.8	80	11.11 -	OM 651.901	4		CZ303	7865	54	
B 200 CDI	246	1.8	100	11.11 -	OM 651.901	4		CZ303	7865	54	
B 220 CDi	246	2.2	125	11.11 -	OM 651.930	4		CZ303	7865	54	

**C W/S 202**

C 180	202	1.8	90	06.93 - 06.97	M 111.920	4	0,7	BCP6ES	4930	17	LPG 3
C 180	202	1.8	90	07.97 - 05.00	M 111.921	4		BKUR5ET	2789	29	LPG 1
C 180	202	1.8	95	09.00 - 03.01	M 111.952	4	1,0	IFR6D10	5344		LPG 1
C 200 D	202	2.0	55	07.93 - 05.00	OM 601.913	4		Y-916J	5906	6	
C 200 D	202	2.0	65	10.96 - 05.00	OM 604.915	4		Y-925J	6848	16	
C 200	202	2.0	100	03.94 - 06.97	M 111.941	4	0,7	BCP6ES	4930	17	LPG 3
C 200	202	2.0	100	07.97 - 05.00	M 111.945	4		BKUR5ET	2789	29	LPG 1
C 200	202	2.0	120	09.00 - 03.01	M 111.956	4	1,0	IFR6D10	5344		LPG 1
C 200 Kompressor	202	2.0	132	09.95 - 10.96	M 111.944	4		BKUR6ET-10	2397	24	LPG 1
C 200 Kompressor	202	2.0	141	11.96 - 05.00	M 111.944	4		BKUR6ET-10	2397	24	LPG 1
C 220 D	202	2.2	70	07.93 - 05.95	OM 604.910	4		Y-930U	4275	30	
C 220 D	202	2.2	70	06.95 - 05.00	OM 604.910	4		Y-925J	6848	16	
C 200 CDI	202	2.2	75	03.98 - 05.00	OM 611.960	4		Y-745U	6346	11	
C 220 CDI	202	2.2	75	06.98 - 05.00	OM 611.961	4		Y-745U	6346	11	
C 220 CDI	202	2.2	92	09.97 - 03.01	OM 611.960	4		Y-745U	6346	11	
C 220	202	2.2	110	06.93 - 09.96	M 111.961	4	0,7	BCP6ES	4930	17	LPG 3
C 230	202	2.3	110	09.96 - 05.97	M 111.974	4	0,7	BCP6ES	4930	17	LPG 3
C 230 Kompressor	202	2.3	142	10.95 - 05.00	M 111.975	4		BKUR6ET-10	2397	24	LPG 1
C 240 V6	202	2.4	125	04.97 - 05.00	M 112.910 Twin Spark	6	1,1	PFR5R-11	4292		LPG 1
C 240 V6	202	2.6	125	09.00 - 03.01	M 112.915 Twin Spark	6	1,1	PFR5R-11	4292		LPG 1
C 250 D	202	2.5	83	07.93 - 01.95	OM 605.910	5		Y-930U	4275	30	
C 250 D	202	2.5	83	02.95 - 08.95	OM 605.910	5		Y-925J	6848	16	
C 250 Turbo-D	202	2.5	110	05.96 - 05.00	OM 605.960	5		Y-925J	6848	16	
C 280	202	2.8	141	06.93 - 05.97	M 104.941	6	0,7	BCP6ES	4930	17	LPG 3
C 280 V6	202	2.8	145	06.97 - 05.00	M 112.920 Twin Spark	6	1,1	PFR5R-11	4292		LPG 1
C 36 AMG	202	3.6	206	01.94 - 05.97	M 104.941	6		BKR5EKU	3964		
C 43 AMG	202	4.3	225	09.97 - 05.00	M 113.944 Twin Spark	8	1,1	PFR5R-11	4292		LPG 1

**C W/S 203**

C 180	203	2.0	95	05.00 - 05.02	M 111.951	4	1,0	IFR6D10	5344		LPG 1
C 180 Kompressor	203	1.8	105	05.02 - 11.06	M 271.940	4	0,8	ILFR6A	3588		ILFR6A
C 180 Kompressor	203	1.8	105	12.06 -	M 271.940 -> 30853899	4	0,8	PLKR7B8E	94716		PLKR7B8E
C 180 Kompressor	203	1.8	105	05.02 - 11.06	M 271.946 30853900 ->	4	0,8	ILFR6A	3588		ILFR6A
C 180 Kompressor	203	1.8	105	12.06 -	M 271.946 30853900 ->	4	0,8	PLKR7B8E	94716		PLKR7B8E
C 200 CDI	203	2.2	75	03.01 - 03.03	OM 646.962	4		Y-745U	6346	11	
C 200 CDI	203	2.2	85	05.00 - 03.04	OM 611.962	4		Y-745U	6346	11	
C 200 CDI	203	2.2	90	04.03 - 03.07	OM 646.962	4		Y-745U	6346	11	
C 200 CGI Kompressor	203	1.8	125	02.03 - 11.06	M 271.942 -> 30853899	4	0,8	ILFR6A	3588		ILFR6A
C 200 CGI Kompressor	203	1.8	125	12.06 -	M 271.942 30853900 ->	4	0,8	PLKR7B8E	94716		PLKR7B8E
C 200 Kompressor	203	1.8	105	02.03 - 11.06	M 271.942 -> 30853899	4	0,8	ILFR6A	3588		ILFR6A

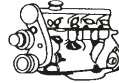

Code *l* kW

Cyl.

Stock-No.  
**VEINE**LPG/CNG  
**BY-PASS****MERCEDES****C W/S 203**

C 200 Kompressor	203	1.8	105	12.06 -	M 271.942 30853900 ->	4	0,8	PLKR7B8E	94716		PLKR7B8E
C 200 Kompressor	203	1.8	120	02.03 - 11.06	M 271.940 -> 30853899	4	0,8	ILFR6A	3588		ILFR6A
C 200 Kompressor	203	1.8	120	12.06 -	M 271.940 30853900 ->	4	0,8	PLKR7B8E	94716		PLKR7B8E
C 200 Kompressor	203	1.8	135	12.06 -	M 271.957 30853900 ->	4	0,8	PLKR7B8E	94716		PLKR7B8E
C 200 Kompressor	203	2.0	120	05.00 -	M 111.955	4	1,0	IFR6D10	5344		LPG 1
C 220 CDI	203	2.2	105	05.00 - 12.04	OM 611.962	4	█	Y-745U	6346	11	
C 220 CDI	203	2.2	110	04.03 - 10.07	OM 646.963	4	█	Y-745U	6346	11	
C 230	203	2.5	150	12.04 -	M 272.920	6	0,8	PLKR7A	4288		PLKR7A
C 230 Kompressor	203	2.3	145	03.01 - 05.02	M 111.981	4	1,0	IFR6D10	5344		LPG 1
C 230 Kompressor	203	1.8	141	02.04 - 11.06	M 271.948 -> 30853899	4	0,8	ILFR6A	3588		ILFR6A
C 230 Kompressor	203	1.8	141	12.06 -	M 271.948 30853900 ->	4	0,8	PLKR7B8E	94716		PLKR7B8E
C 240	203	2.6	125	05.00 -	M 112.912 Twin Spark	6	1,1	PFR5R-11	4292		LPG 1
C 240 4-Matic	203	2.6	125	07.02 -	M 112.916 Twin Spark	6	1,1	PFR5R-11	4292		LPG 1
C 270 CDI	203	2.7	125	12.00 - 12.04	OM 612.962	5	█	Y-745U	6346	11	
C 280	203	3.0	170	11.04 -	M 272.940	6	0,8	PLKR7A	4288		PLKR7A
C 280 4-Matic	203	3.0	170	02.05 -	M 272.941	6	0,8	PLKR7A	4288		PLKR7A
C 32 AMG Kompressor	203	3.2	260	00 -	M 112.961 Twin Spark	6	1,0	IFR6D10	5344		LPG 1
C 320	203	3.2	160	05.00 -	M 112.946 Twin Spark	6	1,1	PFR5R-11	4292		LPG 1
C 320 4-Matic	203	3.2	160	07.02 -	M 112.953 Twin Spark	6	1,1	PFR5R-11	4292		LPG 1
C 320 CDI	203	3.0	165	12.04 - 11.07	OM 642.910	6	█	Y8002AS	6287	51	
C 350	203	3.5	200	12.04 -	M 272.960	6	0,8	PLKR7A	4288		PLKR7A
C 350 4-Matic	203	3.5	200	12.04 -	M 272.970	6	0,8	PLKR7A	4288		PLKR7A
C 55 AMG	203	5.4	270	02.04 -	M 113.988 Twin Spark	8	1,0	IFR6D10	5344		LPG 1

**C COUPÉ C203**

CLC 160	203	1.6	95	02.09 -	M 271.911	4	0,8	PLKR7B8E	94716		PLKR7B8E
CLC 180 Kompressor	203	1.8	105	05.08 -	M 271.940 -> 30853899	4	0,8	ILFR6A	3588		ILFR6A
CLC 180 Kompressor	203	1.8	105	05.08 -	M 271.940 30853900 ->	4	0,8	PLKR7B8E	94716		PLKR7B8E
CLC 180 Kompressor	203	1.8	105	05.08 -	M 271.946 -> 30853899	4	0,8	ILFR6A	3588		ILFR6A
CLC 180 Kompressor	203	1.8	105	05.08 -	M 271.946 30853900 ->	4	0,8	PLKR7B8E	94716		PLKR7B8E
CLC 200 CDI	203	2.2	90	05.08 -	OM 646.962	4	█	Y-745U	6346	11	
CLC 200 Kompressor	203	1.8	135	05.08 -	M 271.957 30853900 ->	4	0,8	PLKR7B8E	94716		PLKR7B8E
CLC 220 CDI	203	2.2	110	05.08 -	OM 646.963	4	█	Y-745U	6346	11	
CLC 230	203	2.5	150	05.08 -	M 272.920	6	0,8	PLKR7A	4288		PLKR7A
CLC 350	203	3.5	200	05.08 -	M 272.960	6	0,8	PLKR7A	4288		PLKR7A

**C W/S 204**

C 180 CDI	204	2.2	88	01.10 -	OM 651.913	4	█	CZ303	7865	54	
C 180 Kompressor	204	1.8	115	01.07 -	M 271.952 30853900 ->	4	0,8	PLKR7B8E	94716		PLKR7B8E
C 180 Kompressor	204	1.6	115	01.08 -	M 271.910	4	0,8	PLKR7A	4288		PLKR7A
C 180 CGI	204	1.8	115	01.07 -	M 271.820	4	0,8	PLKR7B8E	94716		PLKR7B8E

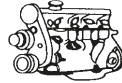
Code *l* kW

Cyl.



Stock-No.



LPG/CNG

**MERCEDES  
C W/S 204**

C 200 CDI	204	2.2	100	08.07 - 12.09	OM 646.811	4	☑	CZ106	9957	53	
C 200 CDI	204	2.2	100	01.10 -	OM 651.913	4	☑	CZ303	7865	54	
C 200 CDI	204	2.2		10.07 - 12.09	OM 646.812	4	☑	CZ106	9957	53	
C 200 CGI Kompressor	204	1.8	135	05.07 -	M 271.950 30853900 ->	4	0,8	PLKR7B8E	94716		PLKR7B8E
C 200 CGI	204	1.8	135	01.07 -	M 271.820	4	0,8	PLKR7B8E	94716		PLKR7B8E
C 220 CDI	204	2.2	125	05.07 - 11.08	OM 646.811	4	☑	CZ106	9957	53	
C 220 CDI	204	2.2	125	12.08 -	OM 651.911	4	☑	CZ303	7865	54	
C 220 CDI	204	2.2	150	12.08 -	OM 651.911	4	☑	CZ303	7865	54	
C 230	204	2.5	150	08.07 -	M 272.921	6	0,8	PLKR7A	4288		PLKR7A
C 230 4-matic	204	2.5	150	01.07 -	M 272.911	6	0,8	PLKR7A	4288		PLKR7A
C 250 CDI	204	2.2	150	01.08 -	OM 651.911	4	☑	CZ303	7865	54	
C 250 CDI 4-matic	204	2.2	150	01.11 -	OM 651.912	4	☑	CZ303	7865	54	
C 250 CGI	204	1.8	150	07.09 -	M 271.860	4	0,8	PLKR7B8E	94716		PLKR7B8E
C 280	204	3.0	170	05.07 -	M 272.947	6	0,8	PLKR7A	4288		PLKR7A
C 280 4-Matic	204	3.0	170	05.07 -	M 272.948	6	0,8	PLKR7A	4288		PLKR7A
C 300	204	3.0	170	07.09 -	M 272.947	6	0,8	PLKR7A	4288		PLKR7A
C 300 4-Matic	204	3.0	170	07.07 -	M 272.948	6	0,8	PLKR7A	4288		PLKR7A
C 300 CDI 4-Matic	204	3.0	170	01.11 -	OM 642.832	6	☑	CZ303	7865	54	
C 320 CDI	204	3.0	165	07.07 -	OM 642.960 / 961	6	☑	Y8002AS	6287	51	
C 350	204	3.5	200	05.07 -	M 272.961	6	0,8	PLKR7A	4288		PLKR7A
C 350 4-Matic	204	3.5	200	05.07 -	M 272.971	6	0,8	PLKR7A	4288		PLKR7A
C 350 CGI	204	3.5		08 -	M 272.982	6	0,7	SILZKR7A-S	7718		SILZKR7A-S
C 350 CDI	204	3.0	165	07.09 -	OM 642.960 / 961	6	☑	Y8002AS	6287	51	
C 350 CDI	204	3.0	170	09.09 -	OM 642.830	6	☑	CZ303	7865	54	
C 350 CDI 4-Matic	204	3.0	170	04.09 -	OM 642.832	6	☑	CZ303	7865	54	
C 63 AMG	204	6.3	336	08.07 -	M 156.985	8	1,0	ILZKAR7A10	6043		ILZKAR7A10
C 63 AMG	204	6.3	358	01.11 -	M 156.985	8	1,0	ILZKAR7A10	6043		ILZKAR7A10
C 63 AMG Coupé Black Series	204	6.3	380	01.12 -	M 156.985	8	1,0	ILZKAR7A10	6043		ILZKAR7A10

**CLA 117**

CLA 220 CDI	117	2.2	125	01.13 -	OM 651.930	4	☑	CZ303	7865	54	
-------------	-----	-----	-----	---------	------------	---	---	-------	------	----	--

**CLK C208**

CLK 200	208	2.0	100	06.97 - 02	M 111.945	4		BKUR5ET	2789	29	LPG 1
CLK 200 Kompressor	208	2.0	120	06.00 - 06.02	M 111.956	4	1,0	IFR6D10	5344		LPG 1
CLK 200 Kompressor	208	2.0	135	07.97 - 02	M 111.944	4		BKUR6ET-10	2397	24	LPG 1
CLK 230 Kompressor	208	2.3	142	06.97 - 02.00	M 111.975	4		BKUR6ET-10	2397	24	LPG 1
CLK 230 Kompressor	208	2.3	145	03.00 - 06.02	M 111.982	4	1,0	IFR6D10	5344		LPG 1
CLK 320 V6	208	3.2	160	06.97 - 02	M 112.940 Twin Spark	6	1,1	PFR5R-11	4292		LPG 1
CLK 430	208	4.3	205	06.98 - 02	M 113.943 Twin Spark	8	1,1	PFR5R-11	4292		LPG 1
CLK 55	208	5.5	255	08.99 - 03	M 113.984 Twin Spark	8	1,1	PFR5R-11	4292		LPG 1

**CLK C209**

CLK 200 CGI	209	1.8	125	02.03 - 11.06	M 271.942 -> 30853899	4	0,8	ILFR6A	3588		ILFR6A
CLK 200 CGI	209	1.8	125	12.06 -	M 271.942 30853900 ->	4	0,8	PLKR7B8E	94716		PLKR7B8E
CLK 200 Kompressor	209	1.8	120	09.02 - 11.06	M 271.940 -> 30853899	4	0,8	ILFR6A	3588		ILFR6A
CLK 200 Kompressor	209	1.8	120	12.06 -	M 271.940 30853900 ->	4	0,8	PLKR7B8E	94716		PLKR7B8E

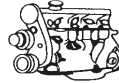
Code *l* kW

Cyl.



Stock-No.



E-POWER

LPG/CNG

**MERCEDES****CLK C209**

CLK 200 Kompressor	209	1.8	120	10.06 -	M 271.955 30853900 ->	4	0,8	PLKR7B8E	94716		PLKR7B8E
CLK 220 CDI	209	2.2	110	01.05 -	OM 646.963	4		Y-745U	6346	11	
CLK 220 CDI	209	2.2	110	01.05 -	OM 646.966	4		Y-745U	6346	11	
CLK 240	209	2.6	125	02.03 -	M 112.912 Twin Spark	6	1,1	PFR5R-11	4292		LPG 1
CLK 270 CDI	209	2.7	125	10.02 - 07.05	OM 612.962	5		Y-745U	6346	11	
CLK 270 CDI	209	2.7	125	10.02 - 07.05	OM 612.967	5		Y-745U	6346	11	
CLK 280	209	3.0	170	01.05 -	M 272.940	6	0,8	PLKR7A	4288		PLKR7A
CLK 320	209	3.2	160	03.03 -	M 112.955 Twin Spark	6	1,1	PFR5R-11	4292		LPG 1
CLK 320 CDI	209	3.0	165	01.05 -	OM 642.910	6		Y8002AS	6287	51	
CLK 350	209	3.5	200	01.05 -	M 272.960	6	0,8	PLKR7A	4288		PLKR7A
CLK 500	209	5.5	286	06 -	M 273.967	8	0,8	PLKR7A	4288		PLKR7A
CLK 500	209	5.0	225	06.02 -	M 113.968 Twin Spark	8	1,1	PFR5R-11	4292		LPG 1
CLK 55 AMG	209	5.4	270	09.02 -	M 113.987 Twin Spark	8	1,0	IFR6D10	5344		LPG 1
CLK 63 AMG	209	6.3	354	04.06 -	M 156.982	8	1,0	ILZKAR7A10	6043		ILZKAR7A10
CLK 63 AMG	209	6.3	373	05.07 -	M 156.982	8	1,0	ILZKAR7A10	6043		ILZKAR7A10

**CLS C218**

CLS 250 CDI	218	2.2	150	10.10 -	OM 651.924	4		CZ303	7865	54	
-------------	-----	-----	-----	---------	------------	---	--	-------	------	----	--

**CLS C219**

CLS 280	219	3.0	170	07 -	M 272.943	6	0,8	PLKR7A	4288		PLKR7A
CLS 300	219	3.0	170	04.09 -	M 272.943	6	0,8	PLKR7A	4288		PLKR7A
CLS 320 CDI nicht für USA	219	3.0	165	01.05 -	OM 642.920	6		Y8002AS	6287	51	
CLS 320 CDI nur für USA	219	3.0	165	01.05 -	OM 642.920	6		CZ303	7865	54	
CLS 350	219	3.5	200	10.04 -	M 272.964	6	0,8	PLKR7A	4288		PLKR7A
CLS 350 CDI nicht für USA	219	3.0	165	04.09 -	OM 642.920	6		Y8002AS	6287	51	
CLS 350 CDI nur für USA	219	3.0	165	04.09 -	OM 642.920	6		CZ303	7865	54	
CLS 350 CGI	219	3.5	215	04.06 -	M 272.985	6	0,7	SILZKR7A-S	7718		SILZKR7A-S
CLS 500	219	5.5	286	04.06 -	M 273.960	8	0,8	PLKR7A	4288		PLKR7A
CLS 500	219	5.0	225	10.04 -	M 113.967 Twin Spark	8	1,1	PFR5R-11	4292		LPG 1
CLS 55 AMG	219	5.5	350	01.05 -	M 113.990 Twin Spark	8	0,8	ILFR6A	3588		ILFR6A
CLS 63 AMG	219	6.3	378	05.06 -	M 156.983	8	1,0	ILZKAR7A10	6043		ILZKAR7A10

**E W/S 124**

200 D	124	2.0	53	02.89 - 06.93	OM 601.912	4		Y-916J	5906	6	
200 E	124	2.0	87	12.88 - 09.92	M 102.963	4	0,8	BP6EFS	3812	5	LPG 5
200 E	124	2.0	100	10.92 - 06.93	M 111.940	4	0,7	BCP6ES	4930	17	LPG 3
220 E	124	2.2	110	10.92 - 06.93	M 111.960	4	0,7	BCP6ES	4930	17	LPG 3
230 E	124	2.3	90	12.84 - 09.92	M 102.982	4	0,8	BP6EFS	3812	5	LPG 5
250 D	124	2.5	66	02.89 - 06.93	OM 602.912	5		Y-916J	5906	6	
250 D Turbo	124	2.5	93	02.89 - 06.93	OM 602.962	5		Y-916J	5906	6	
260 E	124	2.6	118	09.85 - 09.92	M 103.940/943	6	0,8	BP6EFS	3812	5	LPG 5
280 E	124	2.8	142	- 06.95	M 104.942	6	0,7	BCP6ES	4930	17	LPG 3
300 D	124	3.0	80	02.89 - 06.93	OM 603.912	6		Y-916J	5906	6	
300 D 4-Matic	124	3.0	80	02.89 - 06.93	OM 603.913	6		Y-916J	5906	6	
300 E	124	3.0	132	09.85 - 09.92	M 103.983	6	0,8	BP6EFS	3812	5	LPG 5
300 E 4-Matic	124	3.0	132	09.86 - 06.93	M 103.985	6	0,8	BP6EFS	3812	5	LPG 5
300 E-24V	124	3.0	162	09.89 - 06.93	M 104.980	6	0,7	BCP6ES	4930	17	LPG 3
300 TD	124	3.0	92	02.89 - 06.93	OM 603.960	6		Y-916J	5906	6	
300 TD	124	3.0	108	02.89 - 06.93	OM 603.960	6		Y-916J	5906	6	
300 TD 4Matic	124	3.0	105	02.89 - 06.93	OM 603.963	6		Y-916J	5906	6	

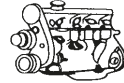
Code *l* kW

Cyl.



Stock-No.



LPG/CNG

**MERCEDES  
E W/S 124**

E 320 E	124	3.2	162	10.92 - 06.93	M 104.992	6	0,7	BCP6ES	4930	17	LPG 3
E 400 E	124	4.2	205	10.92 - 06.93	M 119.975	8	0,7	BCP6ES	4930	17	LPG 3
E 500 E	124	5.0	235	06.91 - 06.93	M 119.974	8	0,7	BCP6ES	4930	17	LPG 3
E 200	124	2.0	100	06.93 - 06.97	M 111.942	4	0,7	BCP6ES	4930	17	LPG 3
E 200 D	124	2.0	53	07.93 - 05.95	OM 601.912	4	█	Y-916J	5906	6	
E 220	124	2.2	110	06.93 - 06.95	M 111.960	4	0,7	BCP6ES	4930	17	LPG 3
E 250 D	124	2.5	66	07.93 -	OM 602.912/962	5	█	Y-916J	5906	6	
E 250 D	124	2.5	83	07.93 - 05.95	OM 605.911	5	█	Y-930U	4275	30	
E 250 D	124	2.5	83	07.93 - 04.96	OM 605.911/912	5	█	Y-925J	6848	16	
E 250 Turbo-D	124	2.5	93	07.93 - 05.95	OM 602.962	5	█	Y-916J	5906	6	
E 280	124	2.8	142	07.93 - 02.97	M 104.942	6	0,7	BCP6ES	4930	17	LPG 3
E 280	124	2.8	142	06.93 - 06.95	M 104.945	6	0,7	BCP6ES	4930	17	LPG 3
E 300 24V	124	3.0	162	06.93 - 06.97	M 104.980	6	0,7	BCP6ES	4930	17	LPG 3
E 300 4-Matic	124	3.0	132	09.86 - 06.93	M 103.985	6	0,8	BP6EFS	3812	5	LPG 5
E 300 D	124	3.0	100	07.93 - 05.95	OM 606.910	6	█	Y-930U	4275	30	
E 300 D	124	3.0	100	06.95 - 06.96	OM 606.910	6	█	Y-925J	6848	16	
E 300 Turbo-D	124	3.0	108	07.93 -	OM 603.960	6	█	Y-916J	5906	6	
E 320	124	3.2	162	06.93 - 06.95	M 104.992	6	0,7	BCP6ES	4930	17	LPG 3
E 420	124	4.2	205	06.93 - 06.95	M 119.975	8	0,7	BCP6ES	4930	17	LPG 3
E 500	124	5.0	235	06.93 - 06.95	M 119.974	8	0,7	BCP6ES	4930	17	LPG 3

**E W/S 210**

E 200 D	210	2.0	65	01.96 - 03.02	OM 604.917	4	█	Y-925J	6848	16	
E 200 CDI	210	2.2	75	06.98 - 06.99	OM 611.961	4	█	Y-745U	6346	11	
E 200 CDI	210	2.2	85	07.99 - 03.03	OM 611.961	4	█	Y-745U	6346	11	
E 200	210	2.0	100	06.95 - 06.97	M 111.942	4	0,8	BCP5ES	7496	16	LPG 3
E 200	210	2.0	100	07.97 - 08.00	M 111.942	4		BKUR5ET	2789	29	LPG 1
E 200 Kompressor	210	2.0	120	06.00 - 03.03	M 111.957	4	1,0	IFR6D10	5344		LPG 1
E 200 Kompressor	210	2.0	137	09.96 - 03.03	M 111.947	4		BKUR6ET-10	2397	24	LPG 1
E 220 D	210	2.2	55	05.96 - 03.02	OM 611.913	4	█	Y-925J	6848	16	
E 220 D	210	2.2	70	03.95 - 03.02	OM 604.912	4	█	Y-925J	6848	16	
E 220 CDI	210	2.2	92	06.98 - 06.99	OM 611.961	4	█	Y-745U	6346	11	
E 220 CDI	210	2.2	105	07.99 - 03.03	OM 611.961	4	█	Y-745U	6346	11	
E 230	210	2.3	110	06.95 - 06.97	M 111.970	4	0,8	BCP5ES	7496	16	LPG 3
E 240	210	2.6	125	06.00 - 03.03	M 112.914 Twin Spark	6	1,1	PFR5R-11	4292		LPG 1
E 240 V6	210	2.4	125	04.97 - 06.99	M 112.911 Twin Spark	6	1,1	PFR5R-11	4292		LPG 1
E 250 D	210	2.5	83	03.95 - 07.99	OM 605.912	5	█	Y-925J	6848	16	
E 250 Turbo-D	210	2.5	110	06.97 - 07.99	OM 605.962	5	█	Y-925J	6848	16	
E 270 CDI	210	2.7	105	07.99 - 03.03	OM 612.961	5	█	Y-745U	6346	11	
E 280	210	2.8	142	01.96 - 06.99	M 104.945	6	0,8	BCP5ES	7496	16	LPG 3
E 280 V6	210	2.8	150	03.97 - 03.03	M 112.921 Twin Spark	6	1,1	PFR5R-11	4292		LPG 1
E 290 Turbo-D	210	2.9	95	06.95 - 07.99	OM 602.982	5	█	Y-929U	1749	41	
E 300 D	210	3.0	100	03.95 - 06.97	OM 606.912	6	█	Y-925J	6848	16	
E 300 Turbo-D	210	3.0	130	03.97 - 07.99	OM 606.962	6	█	Y-930U	4275	30	
E 300 Turbo-D	210	3.0	130	03.97 - 07.99	OM 606.962	6	█	Y-925J	6848	16	
E 320	210	3.2	170	06.95 - 05.99	M 104.995	6	0,8	BCP5ES	7496	16	LPG 3
E 320 V6	210	3.2	165	06.99 - 03.03	M 112.941 Twin Spark	6	1,1	PFR5R-11	4292		LPG 1
E 320 CDI	210	3.2	145	07.99 - 03.03	OM 613.961	6	█	Y-745U	6346	11	
E 420 V8	210	4.2	205	07.97 - 05.98	M 119.985	8		BKUR5ET	2789	29	LPG 1
E 430 V8	210	4.3	205	04.97 - 03.03	M 113.940 Twin Spark	8	1,1	PFR5R-11	4292		LPG 1
E 50 AMG	210	5.0	255	02.96 - 08.97	M 119.985	8		BKR5EKU	3964		

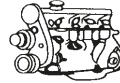
Code *l* kW

Cyl.

Stock-No.  
**V-TUNE**  
E-POWER\*

LPG/CNG

**MERCEDES****E W/S 210**

E 50 AMG USA	210	5.0	235	02.96 - 05.99	M 119.980	8	0,7	BCP6ES	4930	17	LPG 3
E 55 AMG	210	5.5	260	09.97 - 03.03	M 113.980 Twin Spark	8	1,1	PFR5R-11	4292		LPG 1

**E W/S 211**

E 200 CDI	211	2.2	90	07.02 - 07.09	OM 646.951	4	█	Y-745U	6346	11	
E 200 CDI	211	2.2	100	04.06 - 07.09	OM 646.820 / 821	4	█	CZ106	9957	53	
E 200 Kompressor	211	1.8	120	11.02 - 11.06	M 271.941 -> 30853899	4	0,8	ILFR6A	3588		ILFR6A
E 200 Kompressor	211	1.8	120	12.06 - 07.09	M 271.941 30853900 ->	4	0,8	PLKR7B8E	94716		PLKR7B8E
E 200 Kompressor	211	1.8	135	04.06 - 11.06	M 271.956 -> 30853899	4	0,8	ILFR6A	3588		ILFR6A
E 200 Kompressor	211	1.8	135	12.06 - 07.09	M 271.956 30853900 ->	4	0,8	PLKR7B8E	94716		PLKR7B8E
E 200 NGT	211	1.8	120	03.04 - 11.06	M 271.941 -> 30853899	4	0,8	ILFR6A	3588		ILFR6A
E 200 NGT	211	1.8	120	12.06 - 07.09	M 271.941 30853900 ->	4	0,8	PLKR7B8E	94716		PLKR7B8E
E 220 CDI	211	2.2	110	03.03 - 07.09	OM 646.961	4	█	Y-745U	6346	11	
E 220 CDI	211	2.2	125	04.06 - 07.09	OM 646.821	4	█	CZ106	9957	53	
E 230	211	2.5	150	09.07 - 07.09	M 272.922	6	0,8	PLKR7A	4288		PLKR7A
E 240	211	2.6	130	03.02 - 07.09	M 112.913 Twin Spark	6	1,1	PFR5R-11	4292		LPG 1
E 240 4-matic	211	2.6	130	03.03 - 07.09	M 112.917 Twin Spark	6	1,1	PFR5R-11	4292		LPG 1
E 270 CDI	211	2.7	130	03.03 - 07.09	OM 647.961	5	█	Y-745U	6346	11	
E 280	211	3.0	170	01.06 - 07.09	M 272.943	6	0,8	PLKR7A	4288		PLKR7A
E 280 4-matic	211	3.0	140	03.05 - 07.09	OM 642.921	6	█	CZ303	7865	54	
E 280 4-Matic	211	3.0	170	01.06 - 07.09	M 272.944	6	0,8	PLKR7A	4288		PLKR7A
E 280 CDI	211	3.2	130	05.04 - 07.09	OM 648.961	6	█	Y-745U	6346	11	
E 280 CDI nicht für USA	211	3.0	140	03.05 - 07.09	OM 642.920 / 921	6	█	Y8002AS	6287	51	
E 280 CDI nur für USA	211	3.0	140	03.05 - 07.09	OM 642.920 / 921	6	█	CZ303	7865	54	
E 300 CDI Bluetec	211	3.0	165	08 - 07.09	OM 642.920	6	█	CZ303	7865	54	
E 320	211	3.2	165	03.02 - 07.09	M 112.949 Twin Spark	6	1,1	PFR5R-11	4292		LPG 1
E 320 4-matic	211	3.2	165	03.03 - 07.09	M 112.954 Twin Spark	6	1,1	PFR5R-11	4292		LPG 1
E 320 CDI	211	3.2	150	03.03 - 07.09	OM 648.961	6	█	Y-745U	6346	11	
E 320 CDI nicht für USA	211	3.0	165	03.05 - 07.09	OM 642.920	6	█	Y8002AS	6287	51	
E 320 CDI nur für USA	211	3.0	165	03.05 - 07.09	OM 642.920	6	█	CZ303	7865	54	
E 320 CDI 4-matic nicht für USA	211	3.0	165	03.05 - 07.09	OM 642.921	6	█	Y8002AS	6287	51	
E 320 CDI 4-matic nur für USA	211	3.0	165	03.05 - 07.09	OM 642.921	6	█	CZ303	7865	54	
E 350	211	3.5	200	10.04 - 07.09	M 272.964	6	0,8	PLKR7A	4288		PLKR7A
E 350 4-matic	211	3.5	200	11.04 - 07.09	M 272.972	6	0,8	PLKR7A	4288		PLKR7A
E 350 CGI	211	3.5	215	08 - 07.09	M 272.985	6	0,7	SILZKR7A-S	7718		SILZKR7A-S
E 400 CDI	211	4.0	191	02.03 - 07.09	OM 628.961	8	█	Y-745U	6346	11	
E 420 CDI	211	4.0	231	09.05 - 07.09	OM 629.910	8	█	Y8002AS	6287	51	
E 420 CDI	211	4.0	231	01.06 - 07.09	OM 629.910	8	█	Y8002AS	6287	51	
E 500	211	5.5	285	04.06 - 07.09	M 273.960	8	0,8	PLKR7A	4288		PLKR7A
E 500	211	5.5	300	04.06 - 07.09	M 273.962	8	0,8	PLKR7A	4288		PLKR7A
E 500	211	5.0	225	03.02 - 07.09	M 113.967 Twin Spark	8	1,1	PFR5R-11	4292		LPG 1
E 500 4-matic	211	5.0	225	03.03 - 07.09	M 113.969 Twin Spark	8	1,1	PFR5R-11	4292		LPG 1
E 55 AMG	211	5.5	350	10.02 - 07.09	M 113.990 Twin Spark	8	0,8	ILFR6A	3588		ILFR6A
E 63 AMG	211	6.3	378	05.06 - 07.09	M 156.983	8	1,0	ILZKAR7A10	6043		ILZKAR7A10

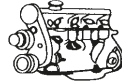

Code *l* kW

Cyl.



Stock-No.



LPG/CNG

**MERCEDES  
E W/S 212**

E 200 CDI	212	2.2	100	05.09 -	OM 651.925	4	█	CZ303	7865	54	
E 200 CGI	212	1.8	135	08.09 -	M 271.820	4	0,8	PLKR7B8E	94716		PLKR7B8E
E 200 CGI	212	1.8	135	08.09 -	M 271.860	4	0,8	PLKR7B8E	94716		PLKR7B8E
E 220 CDI	212	2.2	125	03.09 -	OM 651.924	4	█	CZ303	7865	54	
E 250 CDI	212	2.2	150	03.09 -	OM 651.924	4	█	CZ303	7865	54	
E 250 CGI	212	1.8	150	01.09 -	M 271.860	4	0,8	PLKR7B8E	94716		PLKR7B8E
E 300 CDI	212	3.0	170	03.10 -	OM 642.850	6	█	CZ303	7865	54	
E 350 4-matic	212	3.5	200	01.09 -	M 272.977	6	0,8	PLKR7A	4288		PLKR7A
E 350 CDI BlueEfficiency	212	3.0	170	03.09 -	OM 642.850	6	█	CZ303	7865	54	
E 350 CDI BlueTec	212	3.0	155	03.09 -	OM 642.850	6	█	CZ303	7865	54	
E 350 CGI BlueEfficiency	212	3.5	215	03.09 -	M 272.983	6	0,7	SILZKR7A-S	7718		SILZKR7A-S
E 500	212	5.0	286	03.09 -	M 273.971	8	0,8	PLKR7A	4288		PLKR7A
E 63 AMG	212	6.3	386	12.09 -	M 156.985	8	1,0	ILZKAR7A10	6043		ILZKAR7A10

**E COUPÉ/CABRIOLET C/A 207**

E 220 CDI Coupé / Cabriolet	207	2.2	125	01.10 -	OM 651.911	4	█	CZ303	7865	54	
E 250 CDI Coupé / Cabriolet	207	2.2	150	01.10 -	OM 651.911	4	█	CZ303	7865	54	
E 350 CDI Coupé / Cabriolet	207	3.0	170	01.10 -	OM 642.836	4	█	CZ303	7865	54	
E 200 CGI Coupé / Cabriolet	207	1.8	135	01.10 -	M 271.860	4	0,8	PLKR7B8E	94716		PLKR7B8E
E 250 CGI Coupé / Cabriolet	207	1.8	150	01.09 -	M 271.860	4	0,8	PLKR7B8E	94716		PLKR7B8E
E 350 CDI Coupé / Cabriolet	207	3.0	170	01.09 -	OM 642.836	6	█	CZ303	7865	54	
E 350 CGI Coupé / Cabriolet	207	3.5	215	01.09 -	M 272.982	6	0,7	SILZKR7A-S	7718		SILZKR7A-S
E 500 Coupé / Cabriolet	207	5.5	286	01.09 -	M 273.966	8	0,8	PLKR7A	4288		PLKR7A

**G W461**

230 GE	461	2.3	90	02.93 - 09.95	M 102.979	4	0,8	BP6EFS	3812	5	LPG 5
230 GE	461	2.3	92	04.92 - 09.95	M 102.981	4	0,8	BP6EFS	3812	5	LPG 5
230 GE	461	2.3	92	06.93 - 09.95	M 102.996	4	0,8	BP6EFS	3812	5	LPG 5
230 GE	461	2.3	92	04.92 - 09.95	M 102.998	4	0,8	BP6EFS	3812	5	LPG 5
250 GD	461	2.5	69	04.92 -	OM 602.939	5	█	Y-916J	5906	6	
280 GE	461	2.8	110	04.92 - 07.97	M 110.994	6	0,7	BP6ES	7811	4	LPG 2
290 GD	461	2.9	70	04.92 -	OM 602.942	5	█	Y-916J	5906	6	
290 GD Turbo	461	2.9	72	08.93 - 00.94	OM 602.942/947	6	█	Y-916J	5906	6	
290 GD Turbo	461	2.9	90	07.97 -	OM 602.983	5	█	Y-929U	1749	41	

**G W463**

200 GE	463	2.0	79	06.92 - 06.95	M 102.965	4	0,8	BP6EFS	3812	5	LPG 5
230 GE	463	2.3	93	09.89 - 07.93	M 102.989	4	0,8	BP6EFS	3812	5	LPG 5
250 GD	463	2.5	62	06.90 -	OM 602.931	5	█	Y-916J	5906	6	
300 GD	463	3.0	83	02.89 - 06.93	OM 603.931	6	█	Y-916J	5906	6	
300 GE	463	3.0	128	09.89 - 07.93	M 103.987	6	0,8	BP6EFS	3812	5	LPG 5
350 GD	463	3.5	100	09.91 - 06.93	OM 603.972	6	█	Y-916J	5906	6	
G 200	463	2.0	80	09.93 -	M 102.965	4	0,8	BP6EFS	3812	5	LPG 5
G 230	463	2.3	93	08.93 - 10.94	M 102.989	4	0,8	BP6EFS	3812	5	LPG 5
G 270 CDI	463	2.7	115	10.01 -	OM 612.965	5	█	Y-745U	6346	11	
G 300	463	3.0	126	08.93 - 10.94	M 103.987	6	0,8	BP6EFS	3812	5	LPG 5
G 300 D	463	3.0	83	08.93 -	OM 603.931	6	█	Y-916J	5906	6	
G 300 Turbo-D	463	3.0	130	08.96 -	OM 606.964	6	█	Y-925J	6848	16	
G 320	463	3.2	155	09.93 - 12.97	M 104.996	6	0,8	BCP5ES	7496	16	LPG 3
G 320	463	3.2	158	07.97 -	M 112.945 Twin Spark	6	1,1	PFR5R-11	4292		LPG 1
G 320 CDI	463	3.0	165	09.06 -	OM 642.970	6	█	CZ303	7865	54	
G 36 AMG	463	3.2	155	01.95 -	M 104.996	6	0,8	BCP5ES	7496	16	LPG 3
G 400 CDI	463	4.0	184	12.00 -	OM 628.962	8	█	Y-745U	6346	11	

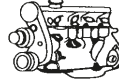
Code *l* kW

Cyl.



Stock-No.

V6  
B-POWER  
LPG/CNG**MERCEDES****G W463**

G 500	463	5.0	195	08.93 - 10.94	M 117.965	8	0,7	BP6ES	7811	4	LPG 2
G 500	463	5.0	218	00 -	M 113.962 Twin Spark	8	1,1	PFR5R-11	4292		LPG 1
G 55 AMG	463	5.5	260	04.99 -	M 113.982 Twin Spark	8	1,1	PFR5R-11	4292		LPG 1
G 55 AMG	463	5.5	350	06.04 -	M 113.993 Twin Spark	8	0,8	ILFR6A	3588		ILFR6A
G 55 AMG	463	5.0	218	04.99 -	M 113.962 Twin Spark	8	1,1	PFR5R-11	4292		LPG 1

**GL X164**

GL 320 CDI nicht für USA	X164	3.0	165	01.06 -	OM 642.940	6	█	Y8002AS	6287	51	
GL 320 CDI nur für USA	X164	3.0	165	01.06 -	OM 642.940	6	█	CZ303	7865	54	
GL 350 CDI Bluetec	X164	3.0	155	06.09 -	OM 642.820	6	█	CZ303	7865	54	
GL 350 CDI nicht für USA	X164	3.0	165	05.09 -	OM 642.940	6	█	Y8002AS	6287	51	
GL 350 CDI nur für USA	X164	3.0	165	05.09 -	OM 642.940	6	█	CZ303	7865	54	
GL 420 CDI	X164	4.0	225	01.06 -	OM 629.912	8	█	Y8002AS	6287	51	
GL 450 CDI	X164	4.0	225	05.09 -	OM 629.912	8	█	Y8002AS	6287	51	
GL 450	X164	4.6	250	01.06 -	M 273.923	8	0,8	PLKR7A	4288		PLKR7A
GL 500	X164	5.5	286	01.06 -	M 273.963	8	0,8	PLKR7A	4288		PLKR7A

**GLK X204**

GLK 200 CDI	X204	2.2	105	07.10 -	OM 651.913	4	█	CZ303	7865	54	
GLK 220 CDI	X204	2.2	120	06.08 -	OM 651.912	4	█	CZ303	7865	54	
GLK 220 CDI	X204	2.2	120	06.08 -	OM 651.916	4	█	CZ303	7865	54	
GLK 220 CDI	X204	2.2	125	08.08 -	OM 651.916	4	█	CZ303	7865	54	
GLK 220 CDI	X204	2.2	125	06.08 -	OM 651.912	4	█	CZ303	7865	54	
GLK 250 CDI	X204	2.2	150	10.08 -	OM 651.912	4	█	CZ303	7865	54	
GLK 280	X204	3.0	170	06.08 - 06.09	M 272.948	6	0,8	PLKR7A	4288		PLKR7A
GLK 300	X204	3.0	170	07.09 -	M 272.948	6	0,8	PLKR7A	4288		PLKR7A
GLK 320 CDI	X204	3.0	165	08.08 -	OM 642.961	6	█	Y8002AS	6287	51	
GLK 350 CDI	X204	3.0	165	06.09 -	OM 642.832	6	█	CZ303	7865	54	
GLK 350	X204	3.5	200	06.08 -	M 272.961	6	0,8	PLKR7A	4288		PLKR7A
GLK 350	X204	3.5	200	08 -	M 272.971	6	0,8	PLKR7A	4288		PLKR7A

**MB 100**

MB 100		2.4	43	02.89 -	OM 615.970	4	█	Y-924J	7906	1	
MB 100 D		2.4	56	02.89 -	OM 616.963	4	█	Y-916J	5906	6	

**M W163**

ML 230	163	2.3	110	02.98 - 06.05	M 111.977	4		BKUR5ET	2789	29	LPG 1
ML 270 CDI	163	2.7	120	12.99 - 06.05	OM 612.963	5	█	Y-745U	6346	11	
ML 320	163	3.2	160	02.98 - 08.02	M 112.942 Twin Spark	6	1,1	PFR5R-11	4292		LPG 1
ML 350	163	3.7	173	08.00 - 06.05	M 112.970 Twin Spark	6	1,1	PFR5R-11	4292		LPG 1
ML 400 CDI	163	4.0	184	09.00 - 06.05	OM 628.963	8	█	Y-745U	6346	11	
ML 430	163	4.3	200	11.98 - 06.05	M 113.942 Twin Spark	8	1,1	PFR5R-11	4292		LPG 1
ML 500	163	5.0	215	09.00 - 06.04	M 113.965 Twin Spark	8	1,1	PFR5R-11	4292		LPG 1
ML 55 AMG	163	5.5	255	11.99 - 06.05	M 113.981 Twin Spark	8	1,1	PFR5R-11	4292		LPG 1

**M W164**

ML 280 CDI nicht für USA	164	3.0	140	10.05 -	OM 642.940	6	█	Y8002AS	6287	51	
ML 280 CDI nur für USA	164	3.0	140	10.05 -	OM 642.940	6	█	CZ303	7865	54	
ML 300 CDI nicht für USA	164	3.0	140	06.09 -	OM 642.940	6	█	Y8002AS	6287	51	
ML 300 CDI nur für USA	164	3.0	140	06.09 -	OM 642.940	6	█	CZ303	7865	54	
ML 300 CDI	164	3.0	150	06.09 -	OM 642.820	6	█	CZ303	7865	54	
ML 320 CDI nicht für USA	164	3.0	165	07.05 -	OM 642.940	6	█	Y8002AS	6287	51	
ML 320 CDI nur für USA	164	3.0	165	07.05 -	OM 642.940	6	█	CZ303	7865	54	

Code *l* kW

Cyl.



Stock-No.



LPG/CNG

LPG/CNG

**MERCEDES****M W164**

ML 350 CDI	164	3.0	155	09.09 -	OM 642.820	6		CZ303	7865	54	
ML 350 CDI nicht für USA	164	3.0	165	06.09 -	OM 642.940	6		Y8002AS	6287	51	
ML 350 CDI nicht für USA	164	3.0	170	02.10 -	OM 642.940	6		Y8002AS	6287	51	
ML 350 CDI nur für USA	164	3.0	165	06.09 -	OM 642.940	6		CZ303	7865	54	
ML 350 CDI nur für USA	164	3.0	170	02.10 -	OM 642.940	6		CZ303	7865	54	
ML 350	164	3.5	200	07.05 -	M 272.967	6	0,8	PLKR7A	4288		PLKR7A
ML 420 CDI	164	4.0	225	02.06 -	OM 629.912	8		Y8002AS	6287	51	
ML 450 CDI	164	4.0	225	06.09 -	OM 629.912	8		Y8002AS	6287	51	
ML 500	164	5.0	225	12.04 -	M 113.964 Twin Spark	8	1,1	PFR5R-11	4292		LPG 1
ML 500	164	5.5	286	12.07 -	M 273.963	8	0,8	PLKR7A	4288		PLKR7A
ML 63 AMG	164	6.3	375	01.06 -	M 156.980	8	1,0	ILZKAR7A10	6043		ILZKAR7A10

**M W166**

ML 250 CDI	166	2.2	150	06.11 -	OM 651.960	4		CZ303	7865	54	
------------	-----	-----	-----	---------	------------	---	--	-------	------	----	--

**R W251**

R 280 CDI nicht für USA	251	3.0	140	05.06 -	OM 642.950	6		Y8002AS	6287	51	
R 280 CDI nur für USA	251	3.0	140	05.06 -	OM 642.950	6		CZ303	7865	54	
R 280	251	3.0	170	02.06 -	M 272.945	6	0,8	PLKR7A	4288		PLKR7A
R 300	251	3.0	170	07.09 -	M 272.945	6	0,8	PLKR7A	4288		PLKR7A
R 300 CDI nicht für USA	251	3.0	140	07.09 -	OM 642.950	6		Y8002AS	6287	51	
R 300 CDI nur für USA	251	3.0	140	07.09 -	OM 642.950	6		CZ303	7865	54	
R 320 CDI nicht für USA	251	3.0	165	02.06 -	OM 642.950	6		Y8002AS	6287	51	
R 320 CDI nur für USA	251	3.0	165	02.06 -	OM 642.950	6		CZ303	7865	54	
R 350 CDI Bluetec	251	3.0	155	07.09 -	OM 642.950	6		CZ303	7865	54	
R 350 CDI	251	3.0	165	07.09 -	OM 642.950	6		CZ303	7865	54	
R 350	251	3.5	200	02.06 -	M 272.967	6	0,8	PLKR7A	4288		PLKR7A
R 500	251	5.0	225	02.06 -	M 113.971 Twin Spark	8	1,1	PFR5R-11	4292		LPG 1
R 500	251	5.5	286	01.07 -	M 273.963	8	0,8	PLKR7A	4288		PLKR7A
R 63 AMG	251	6.3	375	11.05 -	M 156.980	8	1,0	ILZKAR7A10	6043		ILZKAR7A10

**S W140**

300 SE 2.8	140	2.8	142	02.93 - 10.98	M 104.944	6	0,7	BCP6ES	4930	17	LPG 3
300 SE/SEL 3,2	140	3.2	170	03.91 - 06.93	M 104.990	6	0,7	BCP6ES	4930	17	LPG 3
S 300 Turbo-D	140	3.0	130	05.96 - 10.98	OM 606.961	6		Y-916J	5906	6	
400 SE/SEL	140	4.2	210	02.91 - 06.93	M 119.971	8	0,7	BCP6ES	4930	17	LPG 3
500 SE/SEL	140	5.0	240	02.91 - 06.93	M 119.970	8	0,7	BCP6ES	4930	17	LPG 3
500 SEC	140	5.0	240	10.92 - 06.93	M 119.970	8	0,7	BCP6ES	4930	17	LPG 3
600 SE/SEL	140	6.0	290	04.91 - 06.93	M 120.980	12	0,7	BCP6ES	4930	17	LPG 3
600 SEC	140	6.0	290	10.92 - 06.93	M 120.980	12	0,7	BCP6ES	4930	17	LPG 3
S 280	140	2.8	142	07.93 - 06.97	M 104.944	6	0,7	BCP6ES	4930	17	LPG 3
S 300	140	3.0	130	05.96 - 10.98	OM 606.961	6		Y-930U	4275	30	
S 300	140	3.0	130	05.96 - 10.98	OM 606.961	6		Y-925J	6848	16	
S 320	140	3.2	170	07.93 - 06.97	M 104.994	6	0,7	BCP6ES	4930	17	LPG 3
S 350 Turbo-D	140	3.5	110	01.93 - 10.98	OM 603.971	6		Y-916J	5906	6	
S 420	140	4.2	205	07.93 - 06.97	M 119.971	8	0,7	BCP6ES	4930	17	LPG 3
S 420	140	4.2	205	06.93 - 06.97	M 119.981	8	0,7	BCP6ES	4930	17	LPG 3
S 500	140	5.0	235	07.93 - 06.97	M 119.970	8	0,7	BCP6ES	4930	17	LPG 3
S 600	140	6.0	290	07.93 - 06.97	M 120.980	12	0,7	BCP6ES	4930	17	LPG 3
S 600	140	6.0	290	06.93 - 06.97	M 120.982	12	0,7	BCP6ES	4930	17	LPG 3

**S W220**

S 280	220	2.8	142	10.99 - 08.05	M 112.922 Twin Spark	6	1,1	PFR5R-11	4292		LPG 1
-------	-----	-----	-----	---------------	----------------------	---	-----	----------	------	--	-------

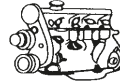
Code *l* kW

Cyl.



Stock-No.

V6

E-POWER

LPG/CNG

**MERCEDES****S W220**

S 320	220	3.2	165	10.98 - 08.05	M 112.944 Twin Spark	6	1,1	PFR5R-11	4292		LPG 1
S 320 CDI	220	3.2	145	08.99 - 09.02	OM 613.960	6	█	Y-745U	6346	11	
S 320 CDI	220	3.2	150	09.02 - 08.05	OM 648.960	6	█	Y-745U	6346	11	
S 350	220	3.7	180	09.02 - 08.05	M 112.972 Twin Spark	6	1,1	PFR5R-11	4292		LPG 1
S 350 4-matic	220	3.7	180	06.03 - 08.05	M 112.975 Twin Spark	6	1,1	PFR5R-11	4292		LPG 1
S 400 CDI	220	4.0	184	06.00 - 08.05	OM 628.960	8	█	Y-745U	6346	11	
S 400 CDI	220	4.0	191	06.03 - 08.05	OM 628.960	8	█	Y-745U	6346	11	
S 430	220	4.3	205	10.98 - 08.05	M 113.941 Twin Spark	8	1,1	PFR5R-11	4292		LPG 1
S 430 4-matic	220	4.3	205	09.02 - 08.05	M 113.948 Twin Spark	8	1,1	PFR5R-11	4292		LPG 1
S 500	220	5.0	225	10.98 - 08.05	M 113.960 Twin Spark	8	1,1	PFR5R-11	4292		LPG 1
S 500 4-matic	220	5.0	225	09.02 - 08.05	M 113.966 Twin Spark	8	1,1	PFR5R-11	4292		LPG 1
S 55 AMG	220	5.5	265	99 - 08.05	M 113.980 Twin Spark	8	1,1	PFR5R-11	4292		LPG 1
S 55 AMG	220	5.5	265	04.99 - 08.05	M 113.986 Twin Spark	8	1,1	PFR5R-11	4292		LPG 1
S 55 AMG Kompressor	220	5.5	368	02 - 08.05	M 113.991 Twin Spark	8	0,8	ILFR6A	3588		ILFR6A
S 600	220	6.0	270	01.00 - 08.05	M 137.970 Twin Spark	12	0,8	IFR6Q-G	5648		IFR6Q-G
S 600	220	6.0	368	01 - 08.05	M 275.950 Twin Spark	12	0,8	IFR6Q-G	5648		IFR6Q-G
S 65 AMG	220	6.0	450	03 - 08.05	M 275.980 Twin Spark	12	0,8	IFR6Q-G	5648		IFR6Q-G

**S W221**

S 250 CDI	221	2.2	150	01.11 -	OM 651.961	4	█	CZ303	7865	54	
S 280	221	3.0	170	05 -	M 272.946	6	0,8	PLKR7A	4288		PLKR7A
S 320 CDI	221	3.0	173	03.06 -	OM 642.930	6	█	Y8002AS	6287	51	
S 320 CDI 4-Matic	221	3.0	173	10.06 -	OM 642.932	6	█	Y8002AS	6287	51	
S 350	221	3.5	200	10.05 -	M 272.965	6	0,8	PLKR7A	4288		PLKR7A
S 350 4Matic	221	3.5	200	06.07 -	M 272.965	6	0,8	PLKR7A	4288		PLKR7A
S 400 BlueHybrid	221	3.5	205	01.09 -	M 272.974	6	0,8	PLKR7A	4288		PLKR7A
S 420 CDI	221	4.0	235	10.06 -	OM 629.911	8	█	Y8002AS	6287	51	
S 450	221	4.6	250	07.05 -	M 273.922	8	0,8	PLKR7A	4288		PLKR7A
S 450 4-Matic	221	4.6	250	12.05 -	M 273.924	8	0,8	PLKR7A	4288		PLKR7A
S 500	221	5.5	285	07.05 -	M 273.961	8	0,8	PLKR7A	4288		PLKR7A
S 500 4-Matic	221	5.5	285	10.05 -	M 273.968	8	0,8	PLKR7A	4288		PLKR7A
S 600	221	6.0	380	03.06 -	M 275.953 Twin Spark	12	0,8	IFR6Q-G	5648		IFR6Q-G
S 63 AMG	221	6.3	386	10.06 -	M 156.984	8	1,0	ILZKAR7A10	6043		ILZKAR7A10
S 65 AMG	221	6.0	450	12.05 -	M 275.982 Twin Spark	12	0,8	IFR6Q-G	5648		IFR6Q-G

**S COUPÉ C140**

CL 420	140	4.2	205	06.96 - 06.97	M 119.981	8	0,7	BCP6ES	4930	17	LPG 3
CL 420	140	4.2	205	07.97 - 10.98	M 119.981	8	1,1	PFR5R-11	4292		LPG 1
CL 500	140	5.0	235	09.96 - 06.97	M 119.980	8	1,1	PFR5R-11	4292		LPG 1
CL 500	140	5.0	235	07.97 - 10.98	M 119.980	8	1,1	PFR5R-11	4292		LPG 1
CL 600	140	6.0	290	06.96 - 05.97	M 120.982	12	0,7	BCP6ES	4930	17	LPG 3
CL 600	140	6.0	290	06.97 - 10.98	M 120.982	12	1,1	PFR5R-11	4292		LPG 1

**S COUPÉ C215**

CL 500	215	5.0	225	09.00 - 03.06	M 113.960 Twin Spark	8	1,1	PFR5R-11	4292		LPG 1
CL 55 AMG	215	5.5	265	10.99 - 03.06	M 113.986 Twin Spark	8	1,1	PFR5R-11	4292		LPG 1
CL 55 AMG Kompressor	215	5.5	386	00 - 03.06	M 113.991 Twin Spark	8	0,8	ILFR6A	3588		ILFR6A
CL 600	215	6.0	270	03.99 - 03.06	M 137.970 Twin Spark	12	0,8	IFR6Q-G	5648		IFR6Q-G
CL 65 AMG	215	6.0	450	09.03 - 03.06	M 275.980 Twin Spark	12	0,8	IFR6Q-G	5648		IFR6Q-G

**S COUPÉ C216**

CL 500	216	5.5	286	10.06 -	M 273.961	8	0,8	PLKR7A	4288		PLKR7A
CL 500 4matic	216	5.5	286	02.08 -	M 273.968	8	0,8	PLKR7A	4288		PLKR7A
CL 600	216	6.0	368	02 - 03.06	M 275.950 Twin Spark	12	0,8	IFR6Q-G	5648		IFR6Q-G

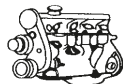

Code *l* kW

Cyl.



Stock-No.

VLINE  
10-15-20-25-30-35-40-45-50-55-60-65-70-75-80-85-90-95-100-105-110-115-120-125-130-135-140-145-150-155-160-165-170-175-180-185-190-195-200-205-210-215-220-225-230-235-240-245-250-255-260-265-270-275-280-285-290-295-300-305-310-315-320-325-330-335-340-345-350-355-360-365-370-375-380-385-390-395-400-405-410-415-420-425-430-435-440-445-450-455-460-465-470-475-480-485-490-495-500-505-510-515-520-525-530-535-540-545-550-555-560-565-570-575-580-585-590-595-600-605-610-615-620-625-630-635-640-645-650-655-660-665-670-675-680-685-690-695-700-705-710-715-720-725-730-735-740-745-750-755-760-765-770-775-780-785-790-795-800-805-810-815-820-825-830-835-840-845-850-855-860-865-870-875-880-885-890-895-900-905-910-915-920-925-930-935-940-945-950-955-960-965-970-975-980-985-990-995-1000

LPG/CNG

**MERCEDES  
S COUPÉ C216**

CL 600	216	6.0	381	09.06 -	M 275.953 Twin Spark	12	0,8	IFR6Q-G	5648		IFR6Q-G
CL 63 AMG	216	6.3	386	09.06 -	M 156.984	8	1,0	ILZKAR7A10	6043		ILZKAR7A10
CL 65 AMG	216	6.0	450	10.06 -	M 275.982 Twin Spark	12	0,8	IFR6Q-G	5648		IFR6Q-G

**SL R129**

300 SL	129	3.0	140	03.89 - 06.93	M 103.984	6	0,8	BP6EFS	3812	5	LPG 5
300 SL-24V	129	3.0	170	07.89 - 06.93	M 104.981	6	0,7	BCP6ES	4930	17	LPG 3
500 SL	129	5.0	235	09.92 - 06.93	M 119.972	8	0,7	BCP6ES	4930	17	LPG 3
500 SL	129	5.0	240	03.89 - 06.93	M 119.960	8	0,7	BCP6ES	4930	17	LPG 3
600 SL	129	6.0	290	07.92 - 06.93	M 120.981	12	0,7	BCP6ES	4930	17	LPG 3
SL 280	129	2.8	141	07.93 - 06.97	M 104.943	6	0,7	BCP6ES	4930	17	LPG 3
SL 280	129	2.8	142	07.97 - 05.98	M 104.943	6		BKUR5ET	2789	29	LPG 1
SL 280	129	2.8	150	06.98 -	M 112.923 Twin Spark	6	1,1	PFR5R-11	4292		LPG 1
SL 320	129	3.2	165	06.98 -	M 112.943 Twin Spark	6	1,1	PFR5R-11	4292		LPG 1
SL 320	129	3.2	170	07.93 - 06.97	M 104.991	6	0,7	BCP6ES	4930	17	LPG 3
SL 320	129	3.2	170	07.97 - 05.98	M 104.991	6		BKUR5ET	2789	29	LPG 1
SL 500	129	5.0	225	98 -	M 113.961 Twin Spark	8	1,1	PFR5R-11	4292		LPG 1
SL 500	129	5.0	235	07.93 - 06.97	M 119.972	8	0,7	BCP6ES	4930	17	LPG 3
SL 500	129	5.0	235	07.93 - 06.97	M 119.982	8	0,7	BCP6ES	4930	17	LPG 3
SL 60	129	6.0	280	95 -	M 119.E60	12		BKR5EKU	3964		
SL 60 AMG	129	6.0	280	95 -	M 119.E60	12		BKR5EKU	3964		
SL 600	129	6.0	290	07.93 - 06.97	M 120.981	12	0,7	BCP6ES	4930	17	LPG 3
SL 600	129	6.0	290	07.93 - 06.97	M 120.983	12	0,8	BCP5ES	7496	16	LPG 3
SL 600	129	6.0	290	98 -	M 120.983	12	1,1	PFR5R-11	4292		LPG 1
SL 73 AMG	129	7.3	386	99 -	M 120.E73	12	1,1	PFR5R-11	4292		LPG 1

**SL R230**

SL 280	230	3.0	170	03.08 -	M 272.949	6	0,8	PLKR7A	4288		PLKR7A
SL 300	230	3.0	170	04.09 -	M 272.949	6	0,8	PLKR7A	4288		PLKR7A
SL 350	230	3.5	200	05.05 -	M 272.966	6	0,8	PLKR7A	4288		PLKR7A
SL 350	230	3.5	233	04.08 -	M 272.968	6	0,8	PLKR7A	4288		PLKR7A
SL 350	230	3.7	180	03.03 -	M 112.973 Twin Spark	6	1,1	PFR5R-11	4292		LPG 1
SL 500	230	5.5	286	03.06 -	M 273.965	8	0,8	PLKR7A	4288		PLKR7A
SL 500	230	5.0	225	10.01 -	M 113.963 Twin Spark	8	1,1	PFR5R-11	4292		LPG 1
SL 55 AMG	230	5.5	350	10.01 - 06.02	M 113.992 Twin Spark	8	0,8	ILFR6A	3588		ILFR6A
SL 55 AMG	230	5.5	368	06.02 -	M 113.992 Twin Spark	8	0,8	ILFR6A	3588		ILFR6A
SL 55 AMG	230	5.5	380	03.06 -	M 113.995 Twin Spark	8	0,8	ILFR6A	3588		ILFR6A
SL 600	230	5.5	368	04.03 -	M 275.951 Twin Spark	12	0,8	IFR6Q-G	5648		IFR6Q-G
SL 600	230	5.5	381	03.06 -	M 275.954 Twin Spark	12	0,8	IFR6Q-G	5648		IFR6Q-G
SL 63 AMG	230	6.3	386	03.08 -	M 156.981	8	1,0	ILZKAR7A10	6043		ILZKAR7A10
SL 65 AMG	230	6.0	450	03.04 -	M 275.981 Twin Spark	12	0,8	IFR6Q-G	5648		IFR6Q-G

**SLK R170**

SLK 200	170	2.0	100	09.96 -	M 111.946	4		BKUR5ET	2789	29	LPG 1
SLK 200 Kompressor	170	2.0	120	03.00 -	M 111.958	4	1,0	IFR6D10	5344		LPG 1
SLK 200 Kompressor	170	2.0	141	09.96 - 02.00	M 111.943	4		BKUR6ET-10	2397	24	LPG 1
SLK 230 Kompressor	170	2.3	142	09.96 - 02.00	M 111.973	4		BKUR6ET-10	2397	24	LPG 1
SLK 230 Kompressor	170	2.3	145	03.00 -	M 111.983	4	1,0	IFR6D10	5344		LPG 1
SLK 32 AMG	170	3.2	260	01 -	M 112.960 Twin Spark	6	1,0	IFR6D10	5344		LPG 1
SLK 32 AMG Kompressor	170	3.2	260	11.00 -	M 112.960 Twin Spark	6	1,0	IFR6D10	5344		LPG 1
SLK 320	170	3.2	160	03.00 -	M 112.947 Twin Spark	6	1,1	PFR5R-11	4292		LPG 1



Code *l* kW

Cyl.

Stock-No.  
**VEINE****B-Power**  
LPG/CNG**MERCEDES****SLK R171**

SLK 200 Kompressor	171	1.8	120	04.04 - 11.06	M 271.944 -> 30853899	4	0,8	ILFR6A	3588		ILFR6A
SLK 200 Kompressor	171	1.8	120	12.06 - 12.10	M 271.944 30853900 ->	4	0,8	PLKR7B8E	94716		PLKR7B8E
SLK 200 Kompressor	171	1.8	135	01.08 - 12.10	M 271.954 30853900 ->	4	0,8	PLKR7B8E	94716		PLKR7B8E
SLK 250	171	1.8	150	02.11 -	M 271.861	4	0,8	PLKR7B8E	94716		PLKR7B8E
SLK 280	171	3.0	170	01.05 -	M 272.942	6	0,8	PLKR7A	4288		PLKR7A
SLK 300	171	3.0	170	04.09 -	M 272.942	6	0,8	PLKR7A	4288		PLKR7A
SLK 350	171	3.5	200	06.04 -	M 272.963	6	0,8	PLKR7A	4288		PLKR7A
SLK 350	171	3.5	224	01.08 -	M 272.969	6	0,8	PLKR7A	4288		PLKR7A
SLK 55 AMG	171	5.5	265	04.04 -	M 113.989 Twin Spark	8	1,0	IFR6D10	5344		LPG 1

**SLK R172**

SLK 200	172	1.8	135	02.11 -	M 271.861	4	0,8	PLKR7B8E	94716		PLKR7B8E
SLK 250	172	1.8	150	02.11 -	M 271.861	4	0,8	PLKR7B8E	94716		PLKR7B8E
SLK 250 Cdi	172	2.2	150	01.12 -	OM 651.980	4		CZ303	7865	54	

**SLR**

SLR Mc Laren	199	5.4	460	04.04 - 01.10	M 155.980 Twin Spark	8	0,8	ILFR6A	3588		ILFR6A
--------------	-----	-----	-----	---------------	----------------------	---	-----	--------	------	--	--------

**SPRINTER 901 / 902**

Sprinter 208 CDI	901/902	2.2	60	04.00 -				Y-745U	6346	11	
Sprinter 208 D	901/902	2.3	58	04.95 -	OM 601....	4		Y-916J	5906	6	
Sprinter 211 CDI	901/902	2.2	80	04.00 -				Y-745U	6346	11	
Sprinter 212 D	901/902	2.9	90	04.95 -	OM 602.980.10 DELA ->9849	5		Y-923U	3380	1	
Sprinter 212 D	901/902	2.9	90	04.95 -	OM 602.980.10 DELA 9850->	5		Y-929U	1749	41	
Sprinter 212 D	901/902	2.9	90	04.95 -	OM 602.980.12 DELA ->136	5		Y-923U	3380	1	
Sprinter 212 D	901/902	2.9	90	04.95 -	OM 602.980.12 DELA 137 ->	5		Y-929U	1749	41	
Sprinter 213 CDI	901/902	2.1	95	04.00 -				Y-745U	6346	11	
Sprinter 214	901/902	2.3	105	04.95 -	M 111.979	4		BKUR5ET	2789	29	LPG 1
Sprinter 216 CDI	901/902	2.7	115	04.00 -				Y-745U	6346	11	

**SPRINTER 903**

Sprinter 308 CDI	903	2.2	60	04.00 -				Y-745U	6346	11	
Sprinter 308 D	903	2.3	58	04.95 - 00	OM 601.....	4		Y-916J	5906	6	
Sprinter 311 CDI	903	2.1	80	04.00 -	OM 611.981	4		Y-745U	6346	11	
Sprinter 312 D	903	2.9	90	04.95 - 04.00	OM 602.980.10 DELA ->9849	5		Y-923U	3380	1	
Sprinter 312 D	903	2.9	90	04.95 - 04.00	OM 602.980.10 DELA9850->	5		Y-929U	1749	41	
Sprinter 312 D	903	2.9	90	04.95 - 04.00	OM 602.980.12 DELA ->136	5		Y-923U	3380	1	
Sprinter 312 D	903	2.9	90	04.95 - 04.00	OM 602.980.12 DELA 137 ->	5		Y-929U	1749	41	
Sprinter 313 CDI	903	2.1	95	04.00 -				Y-745U	6346	11	
Sprinter 314	903	2.3	105	04.95 -	M 111.979	4		BKUR5ET	2789	29	LPG 1
Sprinter 316 CDI	903	2.7	115	04.00 -				Y-745U	6346	11	

Code *l* kW

Cyl.



Stock-No.

V-LINE  
10-15-20-25-30-35-40-45-50-55-60-65-70-75-80-85-90-95-100-105-110-115-120-125-130-135-140-145-150-155-160-165-170-175-180-185-190-195-200-205-210-215-220-225-230-235-240-245-250-255-260-265-270-275-280-285-290-295-300-305-310-315-320-325-330-335-340-345-350-355-360-365-370-375-380-385-390-395-400-405-410-415-420-425-430-435-440-445-450-455-460-465-470-475-480-485-490-495-500-505-510-515-520-525-530-535-540-545-550-555-560-565-570-575-580-585-590-595-600-605-610-615-620-625-630-635-640-645-650-655-660-665-670-675-680-685-690-695-700-705-710-715-720-725-730-735-740-745-750-755-760-765-770-775-780-785-790-795-800-805-810-815-820-825-830-835-840-845-850-855-860-865-870-875-880-885-890-895-900-905-910-915-920-925-930-935-940-945-950-955-960-965-970-975-980-985-990-995-1000

LPG/CNG

**MERCEDES  
SPRINTER 904**

Sprinter 412 D	904	2.9	90	04.95 -	OM 602.980.10 DELA ->9849	5		Y-923U	3380	1
Sprinter 412 D	904	2.9	90	04.95 -	OM 602.980.10 DELA 9850 ->	5		Y-929U	1749	41
Sprinter 412 D	904	2.9	90	04.95 -	OM 602.980.12 DELA ->136	5		Y-923U	3380	1
Sprinter 412 D	904	2.9	90	04.95 -	OM 602.980.12 DELA 137 ->	5		Y-929U	1749	41

**SPRINTER 906**

Sprinter 209 CDI	906	2.2	65	06.06 -	OM 646.984	4		Y-745U	6346	11
Sprinter 209 CDI	906	2.2	80	06.06 -	OM 646.985	4		Y-745U	6346	11
Sprinter 209 CDI	906	3.0	135	06.06 -	OM 642.992	4		CZ303	7865	54
Sprinter 209 CDI	906	3.0		06.06 -	OM 642.896	4		CZ303	7865	54
Sprinter 210 CDI	906	2.2	70	03.09 -	OM 651.955	4		CZ303	7865	54
Sprinter 213 CDI	906	2.2	95	03.09 -	OM 651.956	4		CZ303	7865	54
Sprinter 216	906	1.8	115	09.08 -	M 271.951	4	0,8	PLKR7B8E	94716	
Sprinter 216 CDI	906	2.2	120	03.09 -	OM 651.957	4		CZ303	7865	54
Sprinter 218 CDI	906	3.0	135	06.06 -	OM 642.992	6		Y8002AS	6287	51
Sprinter 219 CDI	906	3.0	140	03.09 -	OM 642.992	6		CZ303	7865	54
Sprinter 224	906	3.5	190	06.06 -	M 272.979	6	0,8	PLKR7A	4288	
Sprinter 310 CDI	906	2.2	70	03.09 -	OM 651.955	4		CZ303	7865	54
Sprinter 313 CDI	906	2.2	95	06.06 -	OM 651.956	4		CZ303	7865	54
Sprinter 313 CDI	906	2.2	95	08.11 -	OM 651.955	4		CZ303	7865	54
Sprinter 316	906	1.8	115	09.08 -	M 271.951	4	0,8	PLKR7B8E	94716	
Sprinter 316 NGT	906	1.8	115	09.08 -	M 271.951	4	0,8	PLKR7B8E	94716	
Sprinter 316 CDI	906	2.2	120	03.09 -	OM 651.957	4		CZ303	7865	54
Sprinter 318 CDI	906	3.0	135	06.06 -	OM 642.992	6		Y8002AS	6287	51
Sprinter 319 CDI	906	3.0	140	03.09 -	OM 642.992	6		Y8002AS	6287	51
Sprinter 324	906	3.5	190	06.06 -	M 272.979	6	0,8	PLKR7A	4288	
Sprinter 413 CDI	906	2.2	95	06.06 -	OM 651.956	4		Y8002AS	6287	51
Sprinter 416 CDI	906	2.2	120	03.09 -	OM 651.957	4		CZ303	7865	54
Sprinter 419 CDI	906	3.0	140	03.09 -	OM 642.992	6		Y8002AS	6287	51
Sprinter 424	906	3.5	190	06.06 -	M 272.979	6	0,8	PLKR7A	4288	
Sprinter 510 CDI	906	2.2	70	03.09 -	OM 651.955	4		CZ303	7865	54
Sprinter 513 CDI	906	2.2	95	03.09 -	OM 651.956	4		CZ303	7865	54
Sprinter 516	906	1.8	115	09.08 -	M 271.951	4	0,8	PLKR7B8E	94716	
Sprinter 516 NGT	906	1.8	115	09.08 -	M 271.951	4	0,8	PLKR7B8E	94716	
Sprinter 516 CDI	906	2.2	120	03.09 -	OM 651.957	4		CZ303	7865	54
Sprinter 518 CDI	906	3.0	135	06.06 -	OM 642.992	6		Y8002AS	6287	51
Sprinter 519 CDI	906	3.0	140	03.09 -	OM 642.992	6		Y8002AS	6287	51
Sprinter 524	906	3.5	190	06.06 -	M 272.979	6	0,8	PLKR7A	4288	

**UNIMOG**

Unimog 100 L		2.9	71	11.92 -	OM 602.948	5		Y-916J	5906	6
Unimog 600/650		2.4	38	01.88 -	OM 616.	4		Y-924J	7906	1
Unimog U 90		3.0	65	11.92 -	OM 602.941	5		Y-916J	5906	6

**VANEO 414**

Vaneo	414	1.6	60	01.02 -	M 166.961	4		BKUR5ET	2789	29	LPG 1
Vaneo	414	1.6	75	01.02 -	M 166.961	4		BKUR5ET	2789	29	LPG 1
Vaneo CDI	414	1.7	55	01.02 -	OM 668.914	4		Y-746R	4842	38	

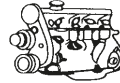
Code *l* kW

Cyl.



Stock-No.

V-TUNE  
E-POWER  
LPG/CNG**MERCEDES****VANEO 414**

Vaneo CDI	414	1.7	67	01.02 -	OM 668.914	4	☑	Y-746R	4842	38	
Vaneo	414	1.9	92	01.02 -	M 166.991	4		BKUR5ET	2789	29	LPG 1

**VIANO 639**

Viano 2.0I CDI	639	2.2	80	07.03 -	OM 646.982	4	☑	Y-745U	6346	11	
Viano 2.2I CDI	639	2.2	100	07.10 -	OM 651.940	4	☑	CZ303	7865	54	
Viano 2.2I CDI	639	2.2	110	09.03 -	OM 646.983	4	☑	Y-745U	6346	11	
Viano 2.2I CDI	639	2.2	120	07.10 -	OM 651.940	4	☑	CZ303	7865	54	
Viano 3.0I	639	3.2	140	09.03 -	M 112.951 Twin Spark	6	1,1	PFR5R-11	4292		LPG 1
Viano 3.0I CDI	639	3.0	150	08.05 -	OM 642.990	6	☑	Y8002AS	6287	51	
Viano 3.0I CDI	639	3.0	165	07.10 -	OM 642.990	6	☑	Y8002AS	6287	51	
Viano 3.2I	639	3.2	190	09.05 -	M 272.978	6	0,8	PLKR7A	4288		PLKR7A
Viano 3.5I	639	3.5	190	09.07 -	M 272.979	6	0,8	PLKR7A	4288		PLKR7A
Viano 3.5I	639	3.7	170	01.05 -	M 112.976 Twin Spark	6	1,1	PFR5R-11	4292		LPG 1

**VITO 638**

Vito 113	638	2.0	95	03.96 -	M 111.948/950	4		BKUR5ET-10	7553		LPG 1
Vito 108 D	638	2.3	60	02.96 -	OM 601.942	4	☑	Y-916J	5906	6	
Vito 110 D	638	2.3	72	02.96 -	OM 601.970	4	☑	Y-916J	5906	6	
Vito 114	638	2.3	105	03.96 - 07.03	M 111.978	4		BKUR5ET-10	7553		LPG 1

**VITO 639**

Vito 110 CDI	639	2.2	70	09.10 -	OM 651.940	4	☑	CZ303	7865	54	
Vito 113 CDI	639	2.2	100	07.10 -	OM 651.940	4	☑	CZ303	7865	54	
Vito 116 CDI	639	2.2	120	09.10 -	OM 651.940	4	☑	CZ303	7865	54	
Vito 120 CDI	639	3.0	150	03.06 -	OM 642.990	6	☑	Y8002AS	6287	51	
Vito 122 CDI	639	3.0	165	09.10 -	OM 642.990	6	☑	Y8002AS	6287	51	
Vito 3.5I	639	3.5	190	09.07 -	M 272.978	6	0,8	PLKR7A	4288		PLKR7A

**V 638**

V 200 CDI	638	2.2	75	03.99 - 07.03	OM 611.980	4	☑	Y-745U	6346	11	
V 220 CDI	638	2.2	90	03.99 - 07.03	OM 611.980	4	☑	Y-745U	6346	11	
V 230	638	2.3	105	09.96 -	M 111.978	4		BKR6EK	2288	20	LPG 1
V 230 TD	638	2.3	72	09.96 -	OM 601.970	4	☑	Y-916J	5906	6	
V 280 VR6	638	2.8	125	98 -	M 104.900(AFS)	6		BKR5EKUP	2890		

**MG**

Express 1.4		1.4		02.03 -	K Series	4	1,1	PFR6N-11	3546		LPG 1
Express 1.8		1.8		02.03 -	K Series	4	1,1	PFR6N-11	3546		LPG 1
Express 2.0		2.0		02.03 -	K Series	4	☑	Y-730U	6704	17	
MGF 1.6		1.6	81	02.00 -	K Series	4	1,1	PFR6N-11	3546		LPG 1
MGF Roadster		1.8	88	11.95 -	NPI	4	1,1	PFR6N-11	3546		LPG 1
MGF Roadster		1.8	106	11.95 -	VV10	4	1,1	PFR6N-11	3546		LPG 1
MGF Trophy 160 SE		1.8	116	02.95 -	K Series VVC	4	1,0	PFR6N-11	3546		LPG 1
MGTF 1.6		1.6	85	03.02 -	K Series	4	1,0	PFR6N-11	3546		LPG 1
MGTF 1.8		1.8	88	03.02 -	K Series	4	1,0	PRF6N-11	3546		
MGTF 1.8		1.8	99	03.02 -	K Series	4	1,0	PFR6N-11	3546		LPG 1
MGTF 1.8		1.8	118	03.02 -	K Series	4	1,0	PFR6N-11	3546		LPG 1
RV 8		3.9	140	10.92 - 10.95	Rover V8 Efi	8	0,8	BPR6ES	7822	2	LPG 2
ZR 105		1.4	74	06.01 -	K	4	1,1	PFR6N-11	3546		LPG 1
ZR 105		1.4	74	06.01 -	K	4	1,1	PFR6N-11	3546		LPG 1

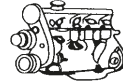
Code *l* kW

Cyl.

Stock-No.  
**VALUE**  
BY-PARTS

LPG/CNG

**MG**

ZR 120		1.8	85	06.01 -	K	4	1,1	PFR6N-11	3546		LPG 1
ZR 120		1.8	85	06.01 -	K	4	1,1	PFR6N-11	3546		LPG 1
ZR 160		1.8	116	06.01 -	K VVC	4	1,1	PFR6N-11	3546		LPG 1
ZR TD		2.0		06.01 -		4		Y-730U	6704	17	
ZR TD		2.0		12.02 -		4		Y-730U	6704	17	
ZS 110		1.6		07.03 -	K Series	4	1,1	PFR6N-11	3546		LPG 1
ZS 120		1.8	85	06.01 -	K	4	1,1	PFR6N-11	3546		LPG 1
ZS 120		1.8	88	06.01 -	K	4	1,1	PFR6N-11	3546		LPG 1
ZS TD		2.0		08.02 -		4		Y-730U	6704	17	
ZS TD		2.0		12.02 -		4		Y-730U	6704	17	
ZS 180		2.5	132	06.01 -	KV6	6	1,1	PFR6N-11	3546		LPG 1
ZT 160 Turbo		1.8		10.02 -	K Series	4	1,1	PFR6N-11	3546		LPG 1
ZT-T 160 Turbo		1.8		10.02 -	K series	4	1,1	PFR6N-11	3546		LPG 1
ZT 120		1.8		07.03 -	K Series	4	1,1	PFR6N-11	3546		LPG 1
ZT CDTi		2.0		07.02 -	M47R (BMW)	4		Y-507J	2691	32	
ZT CDTi		2.0		10.02 -	M47R (BMW)	4		Y-507J	2691	32	
ZT-T CDTi		2.0		07.02 -	M47R (BMW)	4		Y-507J	2691	32	
ZT-T CDTi		2.0		10.02 -	M47R (BMW)	4		Y-507J	2691	32	
ZT 160		2.5	116	06.01 -	KV6	6	1,1	PFR6N-11	3546		LPG 1
ZT 160		2.5	116	06.01 -	KV6	6	1,1	PFR6N-11	3546		LPG 1
ZT-T 160		2.5	116	06.01 -	KV6	6	1,1	PFR6N-11	3546		LPG 1
ZT-T 160		2.5	116	06.01 -	KV6	6	1,1	PFR6N-11	3546		LPG 1
ZT 190		2.5	138	06.01 -	KV6	6	1,1	PFR6N-11	3546		LPG 1
ZT 190		2.5	138	06.01 -	KV6	6	1,1	PFR6N-11	3546		LPG 1
ZT-T 190		2.5	138	06.01 -	KV6	6	1,1	PFR6N-11	3546		LPG 1

**MINI**

Mini One	R50	1.4	55	09.02 - 12.04	W10 B14	4		BKR6EQU	3199	30	LPG 1
Mini D	R50	1.4	55	03.03 -	W17 D14	4		Y-542J	5513	45	
Mini D	R50	1.4	65	03.03 -	W17 D14	4		Y-542J	5513	45	
Mini One	R50	1.6	66	04.01 -	W10 B16	4		BKR6EQU	3199	30	LPG 1
Mini Cooper	R50	1.6	85	04.01 -	W10 B16	4		BKR6EQU	3199	30	LPG 1
Mini Cooper S 16V	R53	1.6	125	12.01 -	W11 B16	4		BKR6EQU	3199	30	LPG 1
Mini Cooper S 16V JCW	R53	1.6	147	01.03 -	W11 B16	4		BKR7EQU	4285		
Mini Clubman One	R55	1.4	70	03.09 - 02.10	N12 B14A	4	0,8	PLZKBR7A-G	5843		
Mini Clubman One	R55	1.4	72	03.10 -	N12 B14A	4	0,8	PLZKBR7A-G	5843		
Mini Clubman One D	R55	1.6	66	03.10 -	N47 C16A	4		Y1039AS	91648	80	
Mini Clubman One	R55	1.6	72	03.10 -	N16 B16A	4	0,8	PLZKBR7A-G	5843		
Mini Clubman Cooper D	R55	1.6	80	10.07 -	9HZ (DV6TED4)	4		YE05	91322	73	
Mini Clubman Cooper D	R55	1.6	82	03.10 -	N47 C16A	4		Y1039AS	91648	80	
Mini Clubman Cooper	R55	1.6	85	03.10 -	N16 B16A	4	0,8	PLZKBR7A-G	5843		
Mini Clubman Cooper	R55	1.6	88	09.07 -	N12 B16A	4	0,8	PLZKBR7A-G	5843		
Mini Clubman Cooper	R55	1.6	90	03.10 -	N16 B16A	4	0,8	PLZKBR7A-G	5843		
Mini Clubman Cooper S	R55	1.6	120	10.07 - 02.10	N14 B16A	4	0,8	PLZKBR7A-G	5843		
Mini Clubman Cooper S	R55	1.6	128	10.07 -	N14 B16A	4	0,8	PLZKBR7A-G	5843		
Mini Clubman John Cooper Works	R55	1.6	155	03.08 -	N14 B16C	4	0,8	ILZKBR7A-8G	5992		
Mini Clubman Cooper D	R55	2.0	82	02.11 -	N47 C20A	4		Y1039AS	91648	80	
Mini Clubman Cooper SD	R55	2.0	100	02.11 -	N47 C20A	4		Y1039AS	91648	80	
Mini Clubman Cooper SD	R55	2.0	105	02.11 -	N47 C20A	4		Y1039AS	91648	80	
Mini One	R56	1.4	55	03.09 - 03.10	N12 B14A	4	0,8	PLZKBR7A-G	5843		
Mini One	R56	1.4	70	11.06 - 03.10	N12 B14A	4	0,8	PLZKBR7A-G	5843		

Code *l* kW

Cyl.



Stock-No.

VEINE

E-POWER

LPG/CNG

**MINI**

Mini One	R56	1.6	55	03.10 -	N16 B16A	4	0,8	PLZKBR7A-G	5843		
Mini One D	R56	1.6	66	06.09 - 07.10	9HZ (DV6TED4)	4	█	YE05	91322	73	
Mini One D	R56	1.6	66	07.10 -	N47 D16 / N47 C16A	4	█	Y1039AS	91648	80	
Mini One	R56	1.6	72	03.10 -	N16 B16	4	0,8	PLZKBR7A-G	5843		
Mini Cooper D	R56	1.6	80	03.07 - 09.10	W16 D16	4	█	YE05	91322	73	
Mini Cooper D	R56	1.6	82	06.10 -	N47 D16 / N47 C16A	4	█	Y1039AS	91648	80	
Mini Cooper	R56	1.6	88	09.06 -	N12 B16	4	0,8	PLZKBR7A-G	5843		
Mini Cooper	R56	1.6	90	03.10 -	N16 B16A	4	0,8	PLZKBR7A-G	5843		
Mini Cooper S	R56	1.6	128	09.06 -	N14 B16A	4	0,8	PLZKBR7A-G	5843		
Mini John Cooper Works	R56	1.6	155	05.08 -	N14 B16	4	0,8	ILZKBR7A-8G	5992		
Mini John Cooper Works	R56	1.6	160	07.07 -	N14 B16	4	0,8	ILZKBR7A-8G	5992		
Mini Cooper D	R56	2.0	82	02.11 -	N47 C20A	4	█	Y1039AS	91648	80	
Mini Cooper SD	R56	2.0	100	02.11 -	N47 C20A	4	█	Y1039AS	91648	80	
Mini Cooper SD	R56	2.0	105	02.11 -	N47 C20A	4	█	Y1039AS	91648	80	
Mini Countryman One D	R60	1.6	66	06.10 -	N47 C16A	4	█	Y1039AS	91648	80	
Mini Countryman One	R60	1.6	72	06.10 -	N16 B16A	4	0,8	PLZKBR7A-G	5843		
Mini Countryman Cooper D	R60	1.6	82	06.10 -	N47 C16A	4	█	Y1039AS	91648	80	
Mini Countryman Cooper	R60	1.6	85	06.10 -	N16 B16A	4	0,8	PLZKBR7A-G	5843		
Mini Countryman Cooper	R60	1.6	90	06.10 -	N16 B16A	4	0,8	PLZKBR7A-G	5843		
Mini Countryman Cooper D	R60	2.0	82	02.11 -	N47 C20A	4	█	Y1039AS	91648	80	
Mini Countryman Cooper SD ALL4	R60	2.0	100	02.11 -	N47 C20A	4	█	Y1039AS	91648	80	
Mini Countryman Cooper SD	R60	2.0	105	02.11 -	N47 C20A	4	█	Y1039AS	91648	80	
Mini Coupe Cooper	R58	1.6	85	09.11 -	N16 B16A	4	0,8	PLZKBR7A-G	5843		
Mini Coupe Cooper	R58	1.6	90	09.11 -	N16 B16A	4	0,8	PLZKBR7A-G	5843		
Mini Coupe John Cooper Works	R58	1.6	155	09.11 -	N14 B16C	4	0,8	ILZKBR7A-8G	5992		
Mini Coupe Cooper SD	R58	2.0	100	09.11 -	N47 C20A	4	█	Y1039AS	91648	80	
Mini Coupe Cooper SD	R58	2.0	105	09.11 -	N47 C20A	4	█	Y1039AS	91648	80	
Mini Paceman Cooper D	R61	1.6	82	09.12 -	N47 C16A	4	█	Y1039AS	91648	80	
Mini Paceman Cooper	R61	1.6	90	04.12 -	N16 B16A	4	0,8	PLZKBR7A-G	5843		
Mini Paceman Cooper SD	R61	2.0	105	10.12 -	N47 C20A	4	█	Y1039AS	91648	80	
Mini Roadster Cooper	R59	1.6	85	02.12 -	N16 B16A	4	0,8	PLZKBR7A-G	5843		
Mini Roadster Cooper	R59	1.6	90	02.12 -	N16 B16A	4	0,8	PLZKBR7A-G	5843		
Mini Roadster John Cooper Works	R59	1.6	155	02.12 -	N14 B16C	4	0,8	ILZKBR7A-8G	5992		
Mini Roadster Cooper SD	R59	2.0	100	02.12 -	N47 C20A	4	█	Y1039AS	91648	80	
Mini Roadster Cooper SD	R59	2.0	105	02.12 -	N47 C20A	4	█	Y1039AS	91648	80	

**MITSUBISHI**

2000 GTX		2.0		94 -	4G63	4	1,1	BKR5E-11	6953	33	LPG 1
3000 GT		3.0	210	09.92 - 00	6G72/T DOHC	6	1,1	PFR6J-11	2743		
3000 GT		3.0		95 - 00	6G72 MPI TC	6	1,1	PFR6J-11	2743		
3000 GT		3.0		97 -	6G7	6	1,1	PFR6J-11	2743		

**AIRTREK**

Airtrek		2.0	93	02 -	4G63 MPI	4	1,1	BKR6E-11	2756	14	LPG 1
Airtrek		2.0		06.02 -	4G63	4	0,7	PGR6A	4984		
Airtrek		2.4		01.03 -	4G64	4	1,1	BKR5E-11	6953	33	LPG 1

**ASX**

ASX 1.6	GA1W	1.6	86	06.10 -	4A92	4	1,1	DILFR5A11	93759		
ASX 1.8	GA3W	1.8	102	02.10 -	4B10	4	0,8	FR6EI	2687		
ASX 2.0	GA2W	2.0	110	06.10 -	4B11	4	0,8	FR6EI	2687		

**CANTER**

Canter (N-FE301, 311, 321, 331)				10.85 - 10.03	4D30	4	█	Y-971M	5035		
---------------------------------	--	--	--	---------------	------	---	---	--------	------	--	--

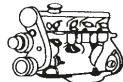

Code *l* kW

Cyl.



Stock-No.



LPG/CNG

## MITSUBISHI CANTER

Canter (N-FE401)				10.85 - 10.03	4D30	4	<input checked="" type="checkbox"/>	Y-971M	5035		
Canter		3.0	92	09.01 - 02.05	4M42-OAT		<input checked="" type="checkbox"/>	Y1007J	3040	59	
Canter		3.0	92	09.01 - 02.05	4M42-OAT		<input checked="" type="checkbox"/>	Y1007J	3040	59	

## CARISMA

Carisma 1.3		1.3	55	09.00 - 10.04	4G13	4	1,1	BKR6E-11	2756	14	LPG 1
Carisma 1600 DAO		1.6	66	07.95 - 99	4G92	4	1,1	BKR6E-11	2756	14	LPG 1
Carisma		1.6		97 - 99	4G92 SOHC	4	1,1	BKR6E-11	2756	14	LPG 1
Carisma 1800 DAO		1.8	85	09.95 -	4G93	4	1,1	BKR6E-11	2756	14	LPG 1
Carisma GDI		1.8	92	09.97 -	4G93 GDI	4	0,6	IZFR6B	3116		
Carisma Elegance GDI		1.8	92	99 -	4G93 GDI	4	0,6	IZFR6B	3116		
Carisma 1800 DAO		1.8	103	09.95 -	4G93	4	1,1	BKR6E-11	2756	14	LPG 1
Carisma		1.8		97 - 00	4G93 SOHC	4	1,1	BKR6E-11	2756	14	LPG 1
Carisma TD		1.9	66	10.96 -	F8Q	4	<input checked="" type="checkbox"/>	Y-933J	7947	25	
Carisma 1.9 DI-D(DA..)		1.9	75	09.00 -		4	<input checked="" type="checkbox"/>	Y-732J	5605	4	
Carisma 1.9 DI-D(DA..)		1.9	85	09.00 -		4	<input checked="" type="checkbox"/>	Y-732J	5605	4	

## COLT

Colt 1300 (3)		1.3		89 - 92	4G13	4	1,1	BPR6ES-11	4824	13	LPG 2
Colt 1500 (3)		1.5		- 12.93	4G15	4	0,8	BPR6ES	7822	2	LPG 2
Colt 1500 (3)		1.5		91 -	4G15 Cat.	4	1,1	BPR6ES-11	4824	13	LPG 2
Colt 1800 (3)		1.8			4G67 Cat.	4	0,8	BPR7ES	2023	19	BPR8EIX
Colt 1300 (4)		1.3	55	93 - 94	4G13 / MPI Cat.	4	1,1	BPR6ES-11	4824	13	LPG 2
Colt 1300 (4)		1.3		92 -	4G13 / MPI	4	1,1	BPR5ES-11	4424		LPG 2
Colt 1300 (4)		1.3		95 -	4G13	4	1,1	BPR5ES-11	4424		LPG 2
Colt 1500 (4)		1.5	69	94 -	4G15	4	0,8	BP5ES	6511	8	LPG 2
Colt 1600 16V (4)		1.6	83	12.91 -	4G92	4	0,8	BPR6ES	7822	2	LPG 2
Colt 1600 (4)		1.6	83	94 - 95	4G92 MPI	4	1,1	BKR6E-11	2756	14	LPG 1
Colt 1600 (4)		1.6		92 - 93	4G92	4	1,1	BKR6E-11	2756	14	LPG 1
Colt 1600 (4)		1.6		95 - 96	4G92 MPI MVV	4	1,1	BKR6E-11	2756	14	LPG 1
Colt 1800 GTI 16V (4)		1.8	103	94 -	4G93 MPI	4	1,1	BKR6E-11	2756	14	LPG 1
Colt 1300 (5)		1.3	55	03.96 -	4G13	4	1,1	BPR5ES-11	4424		LPG 2
Colt 1300 (5)		1.3	60	09.00 -		4	1,1	BKR6E-11	2756	14	LPG 1
Colt 1300 (5)		1.3		97 -	4G13	4	1,1	BPR5ES-11	4424		LPG 2
Colt (5)		1.6	66	03.96 - 03	4G92	4	1,1	BKR6E-11	2756	14	LPG 1
Colt 1600 (5)		1.6	66	03.96 -	4G92	4	1,1	BKR6E-11	2756	14	LPG 1
Colt 1600 (5)		1.6		97 -	4G9 MVV	4	1,1	BKR6E-11	2756	14	LPG 1
Colt 1600 (5)		1.6		97 -	4G9 (not MVV Magermix)	4	1,1	BKR6E-11	2756	14	LPG 1
Colt (6) Z31A / Z32A		1.1	55	10.04 - 06.10	3A91	3	1,1	LFR6C-11	5788		
Colt (6) Z31A / Z32A		1.1	55	07.10 -	3A91	3	1,1	LZFR5BI-11	93298		
Colt (6) Z33A / Z34A		1.3	70	04.05 - 06.10	4A90 16V	4	1,1	LFR6C-11	5788		
Colt DID (6) Z38A		1.5	50	04.05 - 09.08	639 938	3	<input checked="" type="checkbox"/>	YE13	8643		
Colt DID (6) Z39A		1.5	70	04.05 - 09.08	639 939	3	<input checked="" type="checkbox"/>	YE13	8643		
Colt (6) Z36A		1.5	80	04.05 -	4A91 16V	4	0,8	ILZFR6C-K	6645		
Colt CZC (6) Z36A		1.5	80	04.05 - 07.08	4A91 16V	4	0,8	ILZFR6C-K	6645		
Colt CZC (6) Z37A		1.5	110	03.05 - 07.08	4G15T DOHC	4	0,8	ILZFR6C-K	6645		
Colt CZT (6) Z37A		1.5	110	03.05 -	4G15T DOHC	4	0,8	ILZFR6C-K	6645		

## DIAMANTE

Diamante (F31A, F41A) 2500 GDI		2.5		09.99 - 09.01	6G73		0,8	IZFR5C	7748		
Diamante 3000		3.0		94 -	6G72 MPI DOHC	6	0,8	BK6E	3536		LPG 1
Diamante 3000		3.0		94 -	6G72 MPI SOHC	6	1,1	BPR6ES-11	4824	13	LPG 2
Diamante (F36A, F46A) 3000 GDI		3.0		09.99 - 09.01	6G72	6	0,8	IZFR5C	7748		

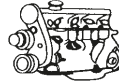
Code *l* kW

Cyl.



Stock-No.

V6/V8

B-Power

LPG/CNG

**MITSUBISHI****ECLIPSE**

Eclipse 2000 D30		2.0	107	11.95 - 04.99	4G63	4	1,1	BPR6ES-11	4824	13	LPG 2
Eclipse 2000		2.0	110	91 - 10.95	4G63 MPI DOHC	4	0,8	BPR7ES	2023	19	BPR8EIX
Eclipse		2.0		97 -	4G6	4	1,1	BPR6ES-11	4824	13	LPG 2
Eclipse 2400		2.4	105	09.98 - 04.99	4G64	4	1,1	BKR5E-11	6953	33	LPG 1
Eclipse V6 24V		3.0	147	07.03 -	4G72 SOHC MPI	6	0,8	FR6EI	2687		

**ETERNA**

Eterna 2000 (E74A,E84A)		2.0		05.92 - 10.94	6A12	4	0,8	PFR6J	2645		
Eterna 2500 (EC5A)		2.5		08.96 -	6A13	4	0,8	PFR6J	2645		

**EVOLUTION**

Evolution-V (CP9A)		2.0	206		4G63 Turbo	4	0,8	PGR7A	3200		
Evolution-VI (CP9A)		2.0	206	02.98 - 05.99	4G63 Turbo	4	0,8	PGR7A	3200		
Evolution-VI Tommi Makinen Edit. (CP9A)		2.0	250	01.99 -	4G63 Turbo	4	0,8	IGR7A	6687		
Evolution-VII (CT9A)		2.0	206	01 -	4G63 Turbo	4	0,8	IGR7A-G	3106		
Evolution-VIII (CT9A)		2.0	195	04 -	4G63 Turbo	4	0,8	IGR7A-G	3106		
Evolution-IX (CT9A)		2.0	195	03.05 -	4G63 Turbo	4	0,6	ILFR7H	5245		
					D4(VT)DOHC						
Evolution-X		2.0	217	04.08 - 09.10	4B11 FQ30	4	0,6	ILKR8E6	1422		
Evolution-X		2.0	217	10.10 -	4B11 FQ30	4	0,6	DILKR8B6	91448		

**GALANT**

Galant 1800		1.8	85	93 - 94	4G93 MPI	4	1,1	BKR6E-11	2756	14	LPG 1
Galant 1800		1.8		92 - 96	4G37 Cat.	4	1,1	BPR7ES-11	7226		BPR8EIX
Galant 1800		1.8		94 - 96	4G93	4	0,8	BK6E	3536		LPG 1
Galant TD (E5..8)		2.0	66	11.92 - 10.96	4D68 SOHC	4	█	CY57	4994	21	
Galant TD (EA)		2.0	66	10.96 - 02.00	4D68	4	█	CY57	4994	21	
Galant 2000		2.0	100	96 - 03	4G63	4	1,1	BKR6E-11	2756	14	LPG 1
Galant 2000		2.0	101	94 - 03	4G63 MPI	4	1,1	BKR6E-11	2756	14	LPG 1
Galant 2000 V6 (E74A,E84A)		2.0	110	05.92 - 10.94	6A12 MPI 24V	6	1,1	PFR6J-11	2743		
Galant		2.0		88 - 93	4G63 GTi16	4	0,8	BPR7ES	2023	19	BPR8EIX
Galant 2000		2.0		92 -	Cat.	4	1,1	BPR7ES-11	7226		BPR8EIX
Galant 2000		2.0		92 - 92	4G63	4	1,1	BPR7ES-11	7226		BPR8EIX
Galant 2000		2.0		92 - 92	4G63D	4	0,8	BPR6ES	7822	2	LPG 2
Galant 2000		2.0		93 - 96	4G63	4	0,8	BK6E	3536		LPG 1
Galant		2.0		97 - 03	4G63	4	1,1	BKR6E-11	2756	14	LPG 1
Galant GDI		2.4	110	10.98 -	4G64 GDI	6	0,6	IZFR5B	4080		
Galant 2400		2.4		94 -	4G64 MPI DOHC	6	1,1	BPR6ES-11	4824	13	LPG 2
Galant 2400		2.4		94 -	4G64 MPI SOHC	6	1,1	BKR6E-11	2756	14	LPG 1
Galant 2500 V6		2.5	125	93 - 03.97	6G12 24V	6	1,1	PFR6J-11	2743		
Galant V6 24V		2.5		95 - 00	6G73 MPI	6	1,1	PFR6J-11	2743		
Galant 2500 (EC5A)		2.5		08.96 - 03	6A13	4	0,8	PFR6J	2645		
Galant V6		2.5		03.97 - 03	6A13	6	1,1	PFR6G-11	5555		PFR7G
Galant Station Wagon QGS Typ				83 -	4D55	4	█	Y-115R1	2161		
Galant Wagon TD (EA)		2.0	66	10.96 - 02.00	4D68	4	█	CY57	4994	21	

**GALLOPER**

Galloper Td		2.5	65	02.99 - 01	D4BH	4	█	CY57	4994	21	
Galloper Td		2.5	73	02.99 - 01	D4BH	4	█	CY57	4994	21	
Galloper		3.0	104	98 - 12.01	G6AT	6	1,1	BPR5ES-11	4424		LPG 2

**GRANDIS**

Grandis 2.0 DI-D ohne Partikelfilter		2.0	100	09.05 - 03.10	BSY (VW engine)	4	█	YE14	7768	48	
Grandis 2.0 DI-D mit Partikelfilter		2.0	100	06.07 - 03.10	BSY (VW engine)	4	█	CZ304	9864	55	
Grandis 2.0 DI-D ohne Partikelfilter		2.0	103	02.07 - 03.10	BWC	4	█	YE14	7768	48	

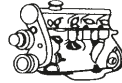
Code *l* kW

Cyl.



Stock-No.



LPG/CNG

**MITSUBISHI  
GRANDIS**

Grandis 2.0 DI-D mit Partikelfilter		2.0	103	06.07 - 03.10	BWC	4		CZ304	9864	55	
Grandis		2.4	121	04.04 -	4G69	4		LZFR6AI	3656		

<b>I</b>											
i 0.7	HA1W	0.66	38	02.07 -	3B20	3	0,8	ILKR7B8	1989		

**L200**

L200		1.6		92 -	4G32	4	0,9	BPR5ES	7422	6	LPG 2
L200		2.0		92 -	4G63	4	0,8	BPR6ES	7822	2	LPG 2
L200		2.4	82	94 -	4G64 MPI	4	1,1	BCPR6ES-11	7121	11	LPG 3
L200		2.4	97	99 -		4	1,1	BPR6ES-11	4824	13	LPG 2
L200 (KOT-K3T) ohne Schnellstartanlage		2.5	51	11.93 - 05.94	4D56 without QGS	4		Y-733J	6592	13	
L200 (KOT-K3T)		2.5	51	06.94 - 08.96	4D56 SOHC	4		CY57	4994	21	
L200 2.5 TD		2.5	73	06.96 - 12.07	4D56	4		Y-733J	6592	13	
L200 2.5 TD		2.5	85	09.01 - 12.07	4D56TD	4		Y-733J	6592	13	
L200 2.5 TD		2.5	98	08.01 - 12.07	4D56T	4		Y-733J	6592	13	
L200		2.6	76	93 -	4G54/B	4	1,1	BPR6ES-11	4824	13	LPG 2
L200		2.6		95 -	G54B	4	1,1	BUR6EA-11	5428		
L200 2.5 DI-D	KB4T	2.5	94	04.10 -	4D56HP	4		CZ251	91238	76	
L200 2.5 DI-D	KB4T	2.5	100	11.05 -	4D56HP	4		CZ251	91238	76	
L200 2.5 DI-D Euro III + IV	KB4T	2.5	123	08.07 -	4D56HP	4		CZ251	91238	76	
L200 2.5 DI-D	KB4T	2.5	131	06.09 -	4D56HP	4		CZ251	91238	76	

**L300**

L300		1.4		94 -	4G33	4	0,7	BP6ES	7811	4	LPG 2
L300		2.0	66	92 -	4G63 Cat.	4	0,8	BPR6ES	7822	2	LPG 2
L300		2.0	85	07.94 -	4G63	4	0,9	BPR5ES	7422	6	LPG 2
L300		2.0		10.94 -	4G63 MPI	4	1,1	BKR5E-11	6953	33	LPG 1
L300		2.0		95 -	4G63 FBC	4	1,1	BKR5E-11	6953	33	LPG 1
L300		2.4	82	92 -	4G64 Cat.	4	1,1	PGR6A-11	3738		
L300 TD (P)		2.5	64	06.93 - 96	4D56 SOHC	4		CY57	4994	21	
L300		2.5		97 -	4D56	4		Y-733J	6592	13	
L300 / 4WD		2.3		04.83 -	4D55	4		Y-115T1	2189		

**L400**

L400				95 - 97	4D56	4		CY57	4994	21	
L400		2.0		95 -	4G63 MPI	4	1,1	BKR5E-11	6953	33	LPG 1
L400		2.4		95 -	4G64 MPI	4	1,1	BKR5E-11	6953	33	LPG 1
L400 TD		2.5	73	12.94 -	4D56	4		CY57	4994	21	
L400		2.5		98 -	4D56	4		Y-733J	6592	13	

**LANCER**

Lancer 1300		1.3	55	11.95 - 05.01	4G13M MPI	4	1,1	BPR5ES-11	4424		LPG 2
Lancer		1.3	55	03.96 - 01	4G13	4	1,1	BUR6EA-11	5428		
Lancer 1.3	CS1A	1.3	60	09.03 - 06.06	4G13S	4	1,1	BKR6E-11	2756	14	LPG 1
Lancer 1.3	CS1A	1.3	60	07.06 -	4G13S	4	0,8	IFR6S	99404		
Lancer 1300		1.3		89 - 92	4G13	4	0,8	BPR6ES	7822	2	LPG 2
Lancer 1300		1.3		10.92 - 01	4G13	4	0,8	BP5ES	6511	8	LPG 2
Lancer 1300		1.3		97 -	4G1	4	1,1	BPR5ES-11	4424		LPG 2
Lancer 1500		1.5	69	93 - 00	4G15	4	0,8	BP5ES	6511	8	LPG 2
Lancer Sportback 1.5 (CX2A)		1.5	80	06.08 -	4A91 MIVEC	4	1,1	ILZFR6C-11K	4673		
Lancer Stufenheck 1.5 (CY2A)		1.5	80	06.08 -	4A91 MIVEC	4	1,1	ILZFR6C-11K	4673		
Lancer 1500		1.5		08.84 - 92	4G15	4	0,8	BPR6ES	7822	2	LPG 2
Lancer 1500		1.5		86 - 92	4G15 Cat.	4	1,1	BPR6ES-11	4824	13	LPG 2
Lancer 1500		1.5		94 - 96	4G91 MPI	4	1,1	BK6E-11	7340		LPG 1

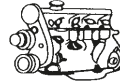
Code *l* kW

Cyl.



Stock-No.

V-TIME

E-POWER

LPG/CNG

**MITSUBISHI****LANCER**

Lancer 1.6	CS3A/CS3W	1.6	72	09.03 - 06.06	4G18	4	1,1	BKR6E-11	2756	14	LPG 1
Lancer 1.6	CS3A/CS3W	1.6	72	07.06 -	4G18	4	0,8	IFR6S	99404		
Lancer 1600		1.6	83	10.92 - 00	4G92 MPI	4	1,1	BKR6E-11	2756	14	LPG 1
Lancer 1.6 (CY1A / CX1A)		1.6	86	05.10 -	4A92	4	1,1	DILFR5A11	93759		
Lancer 1600		1.6		90 - 09.92	4G61 DOHC	4	0,8	BPR6ES	7822	2	LPG 2
Lancer 1600		1.6		94 - 12.96	4G92 MVV	4	1,1	BKR5E-11	6953	33	LPG 1
Lancer 1600		1.6		97 -	4G9 MVV	4	1,1	BKR5E-11	6953	33	LPG 1
Lancer 1600		1.6		97 - 00	4G9	4	1,1	BKR6E-11	2756	14	LPG 1
					(not MVV Magermix)						
Lancer Sportback 1.8 (CX3A)		1.8	105	06.08 -	4B10 MIVEC	4	0,8	FR6EI	2687		
Lancer Stufenheck 1.8 (CY3A)		1.8	105	02.08 - 03.09	4B10 MIVEC	4	0,8	FR6EI	2687		
Lancer Stufenheck 1.8 (CY3A)		1.8	105	04.09 -	4B10 MIVEC	4	1,1	DIFR5C11	1311		
Lancer 1800		1.8		86 - 92	4G37 Cat.	4	1,1	BPR6ES-11	4824	13	LPG 2
Lancer 1800		1.8		86 - 92	4G67	4	0,8	BPR7ES	2023	19	BPR8EIX
Lancer		1.8		90 - 92	4G37 GLXi	4	1,1	BPR6ES-11	4824	13	LPG 2
Lancer		1.8		90 - 92	4G37 GTi16	4	0,8	BPR6ES	7822	2	LPG 2
Lancer		1.8		93 -	4G93 GTi16	4	1,1	BKR6E-11	2756	14	LPG 1
Lancer 1800 16V		1.8		93 -	4G93 MPI	4	0,8	BK6E	3536		LPG 1
Lancer (CB/CD)		2.0	50	12.93 - 06.96	4D68	4	☑	CY57	4994	21	
Lancer		2.0	99	09.03 -	4G63	4	1,1	IGR6A11	5743		
Lancer 2000		2.0		01.05 -	4G94	4	1,1	BKR5E-11	6953	33	LPG 1

**MIRAGE**

Mirage		1.5		94 -	4G15 MPI	4	1,1	BPR5ES-11	4424		LPG 2
Mirage		1.6		96 -	4G92	4	1,1	BKR6E-11	2756	14	LPG 1
Mirage		1.8		94 -	4G93 MPI	4	1,1	BKR5E-11	6953	33	LPG 1

**MONTERO**

Montero				92 - 93	4D56	4	☑	Y-115T1	2189		
Montero				94 - 95	4D56	4	☑	CY57	4994	21	
Montero				96 -	4D56	4	☑	Y-733J	6592	13	
Montero Sport				97 -		4	☑	Y-733J	6592	13	
Montero V6 3000		3.0		91 -	6G72	6	1,1	BPR5ES-11	4424		LPG 2

**OUTLANDER I**

Outlander I 2.0	CU2W	2.0	93	05.03 - 10.06	4G63	4	1,1	IGR6A11	5743		
Outlander I 2.0	CU2W	2.0	100	05.03 - 10.06	4G63	4	1,1	IGR6A11	5743		
Outlander I 2.0 Turbo	CU2W	2.0	148	04.04 - 06.04	4G63 Turbo	4	1,1	IGR6A11	5743		
Outlander I 2.0 Turbo	CU2W	2.0	177	05.03 - 10.06		4	1,1	IGR6A11	5743		
Outlander I 2.4	CU5W	2.4	102	05.03 - 10.06		4		LZFR6AI	3656		
Outlander I 2.4	CU5W	2.4	118	05.03 - 10.06	4G69	4		LZFR6AI	3656		

**OUTLANDER II**

Outlander II 2.0 DI-D	CW8W	2.0	103	11.06 - 06.10	BSY	4	☑	YE14	7768	48	
Outlander II 2.0	CW4W	2.0	108	11.06 - 08.13	4B11	4	1,1	DIFR6C11	1312		
Outlander II 2.2 DI-D	CW7W	2.2	115	08.07 - 12.12	4HK / 4HN	4	☑	YE08	4966		
Outlander II 2.4	CW5W	2.4	125	06.07 - 08.13	4B12	4	0,8	FR5EI	1313		FR6EI
Outlander II 2.4 Flex Fuel	CW5W	2.4	125	09.07 - 06.10	4B12	4	0,8	FR5EI	1313		FR6EI
Outlander II 3.0	CW6W	3.0	162	11.06 - 08.13	6B31	6	0,8	ILKR7B8	1989		

**OUTLANDER III**

Outlander III 2.0 Hybrid	GG2W	2.0	89	12.12 -	4B11	4	0,8	FR6EI	2687		
--------------------------	------	-----	----	---------	------	---	-----	-------	------	--	--

**PAJERO**

Pajero				92 - 93	4D56	4	☑	Y-115T1	2189		
--------	--	--	--	---------	------	---	---	---------	------	--	--

Code *l* kW

Cyl.



Stock-No.



LPG/CNG

**MITSUBISHI  
PAJERO**

Pajero 2400		2.4		03.91 -	4G64	4	1,1	BPR6ES-11	4824	13	LPG 2
Pajero		2.4		97 -	4G64	4	1,1	BPR6ES-11	4824	13	LPG 2
Pajero TD Intercooler (IV)		2.5	62	08.93 - 05.99	4D56 T	4	█	Y-733J	6592	13	
Pajero TD Intercooler (V)		2.5	73	11.93 - 01.98	4D56 T	4	█	CY57	4994	21	
Pajero 2600		2.6		92 -		4	1,1	BP6ES-11	1212		LPG 2
Pajero (V4..)		2.8	92	06.94 - 04.00	4M40	4	█	CZ256	90066		
Pajero		3.0	130	97 -	6G72 24Ventiler	6	1,1	PFR6J-11	2743		
Pajero 3000 V6		3.0		89 -	6G72	6	1,1	BPR5ES-11	4424		LPG 2
Pajero		3.0		97 -	6G72 12Ventiler	6	1,1	BPR5ES-11	4424		LPG 2
Pajero Sport		3.0		99 -	6G72 24Ventiler	6	1,1	PFR6J-11	2743		
Pajero 3.2 DI-D		3.2	118	04.00 -		4	█	Y-532J	7782		
Pajero		3.5	143	97 -	6G74	6	1,1	PFR5J-11	4642		
Pajero GDI V60		3.5	149	04.00 -	V6	6	0,6	IZFR5B	4080		
Pajero 3500 V6		3.5	153	04.94 - 97	6G74 DOHC	6	1,1	PFR6J-11	2743		
Pajero 3.2 DI-D	V88W/V98W	3.2	118	02.07 -	4M41	4	█	CZ251	91238	76	
Pajero 3.2 DI-D	V88W/V98W	3.2	125	02.07 -	4M41	4	█	CZ251	91238	76	
Pajero 3.2 DI-D	V88W/V98W	3.2	147	01.09 -	4M41	4	█	CZ251	91238	76	
Pajero 3.8 V6 GDI	V87W/V97W	3.8	182	02.10 -	6G75	6		IFR6B-K	4867		
Pajero 3.8 V6 GDI	V87W/V97W	3.8	184	11.06 -	6G75	6		IFR6B-K	4867		
Pajero Classic		3.2	118	05.05 -	4M41		█	Y1007J	3040	59	
Pajero III		3.2	118	10.01 -	4M41		█	Y1007J	3040	59	
Pajero III		3.2	121	04.00 - 10.01	4M41		█	Y1007J	3040	59	

**PAJERO PININ**

Pajero Pinin (H66W,H67W)		1.8	88	00 -	4G93 GDI	4	0,6	IZFR6B	3116		
Pajero Pinin (H76W,H77W)		2.0	95	09.00 -	4G94 GDI	4	0,6	IZFR5B	4080		

**SANTAMO**

Santamo		2.0	102	99 -	DOHC / SOHC	4	1,1	BP6ES-11	1212		LPG 2
---------	--	-----	-----	------	-------------	---	-----	----------	------	--	-------

**SHOGUN**

Shogun		2.5		94 - 95	4D56	4	█	CY57*	4994	21	
Shogun		2.5		01.96 - 03.00	4D56	4	█	Y-733J	6592	13	
Shogun		3.0		91 - 94	6G72	6	1,1	BPR5ES-11	4424		LPG 2
Shogun		3.0		91 - 94	6G72	6	1,1	BPR5ES-11	4424		LPG 2
Shogun		3.0		94 -	6G72	6	1,1	PFR6J-11	2743		
Shogun		3.5		91 -	6G74	6	1,1	PFR5J-11	4642		
Shogun		3.5		00 -		6	0,8	IZFR5B	4080		
Shogun PININ		1.8		00 -	4G93 GDI	4	0,8	IZFR6B	3116		
Shogun PININ		2.0		00 -	4G94 GDI	4	0,8	IZFR5B	4080		

**SIGMA**

Sigma V6		3.0		91 - 93	6G72 DOHC 24V	6	1,1	PFR6J-11	2743		
Sigma V6		3.0		91 - 93	6G72 SOHC	6	1,1	BPR6ES-11	4824	13	LPG 2
Sigma 3000		3.0		93 - 96	6G72 MPI V6	6	1,1	BPR6ES-11	4824	13	LPG 2
Sigma 3000		3.0		94 - 96	6G72 MPI V6-24V	6	1,1	PFR6J-11	2743		

**SPACE GEAR**

Space Gear 2.0		2.0	83	04.95 - 01	4G63 MPI	4	1,1	BKR5E-11	6953	33	LPG 1
Space Gear 2.0		2.0		97 - 01	4G69	4	1,1	BKR5E-11	6953	33	LPG 1
Space Gear 2.4		2.4	97	04.95 - 01	4G64 MPI	4	1,1	BKR5E-11	6953	33	LPG 1
Space Gear 2.5 Turbo D		2.5	73	12.94 -	4D56	4	█	CY57	4994	21	
Space Gear 2.5 Turbo D		2.5	73	06.94 - 05.95	4D56 Turbo	4	█	Y-733J	6592	13	

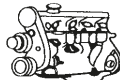

Code *l* kW

Cyl.



Stock-No.

V-TIME

E-POWER

LPG/CNG

**MITSUBISHI****SPACE GEAR**

Space Gear 2.5 Turbo D		2.5		98 -	4D56 Turbo	4		Y-733J	6592	13	
------------------------	--	-----	--	------	------------	---	--	--------	------	----	--

**SPACE RUNNER**

Space Runner 1800		1.8	90	09.91 - 92	4G93	4	1,1	BKR6E-11	2756	14	LPG 1
Space Runner 1800		1.8	90	91 - 99	4G93 MPI	4	1,1	BKR6E-11	2756	14	LPG 1
Space Runner 1800		1.8		94 - 99	4G93	4	0,8	BK6E	3536		LPG 1
Space Runner		1.8		97 - 99	4G93	4	1,1	BKR6E-11	2756	14	LPG 1
Space Runner		2.0	60	06.93 -	4D68	4		CY57	4994	21	
Space Runner		2.0	100	99 - 08.02	4G63 MPI	4	1,1	BKR6E-11	2756	14	LPG 1
Space Runner GDI		2.4	110	99 -	4G64 GDI	4	0,6	IZFR5B	4080		

**SPACE STAR**

Space Star 1.3		1.3	63	12.98 - 05.00	4G13	4	1,1	BKR5E-11	6953	33	LPG 1
Space Star 1.3		1.3	63	06.00 - 12.04	4G13	4	1,1	BKR6E-11	2756	14	LPG 1
Space Star 1.6		1.6	72	04.01 - 12.04	4G18	4	1,1	BKR6E-11	2756	14	LPG 1
Space Star 1.8 MPI		1.8	82	08.02 - 12.04	4G93	4	0,6	IZFR6B	3116		
Space Star 1.8 GDI		1.8	87	06.98 - 12.04	4G93 GDI	4	0,6	IZFR6B	3116		
Space Star 1.8 GDI		1.8	90	06.98 - 12.04	4G93 GDI	4	0,6	IZFR6B	3116		
Space Star 1.9 DI-D		1.9	75	08.00 - 12.04	F9Q1	4		Y-732J	5605	4	
Space Star 1.9 DI-D		1.9	85	08.02 - 12.04	F9Q2	4		Y-732J	5605	4	

**SPACE WAGON**

Space Wagon 1800		1.8		09.91 - 93	4G93	4	1,1	BKR6E-11	2756	14	LPG 1
Space Wagon 1800		1.8		94 -	4G93	4	0,8	BK6E	3536		LPG 1
Space Wagon 1800		1.8		94 -	4G93 MPI	4	1,1	BKR6E-11	2756	14	LPG 1
Space Wagon (N)		2.0	60	06.93 - 11.00	4D68	4		CY57	4994	21	
Space Wagon 2000		2.0	98	92 - 00	4G63 MPI Cat.	4	1,1	BKR6E-11	2756	14	LPG 1
Space Wagon Gdi (N5.)		2.0	98	02.02 -	4G94	4	1,1	HB6BIX-11P	5705		
Space Wagon 2000 4WD		2.0		89 -		4	0,8	BPR7ES	2023	19	BPR8EIX
Space Wagon		2.0		97 -	4G63	4	1,1	BKR5E-11	6953	33	LPG 1
Space Wagon GDI (N84W,N94W)		2.4	110	10.98 - 01.04	4G64 GDI	4	0,6	IZFR5B	4080		
Space Wagon 2400		2.4		93 - 95	4G64 Cat.	4	1,1	BKR6E-11	2756	14	LPG 1

**STARION**

Starion 2600 Turbo		2.6		89 -	4G54 Cat.		1,1	BPR6ES-11	4824	13	LPG 2
--------------------	--	-----	--	------	-----------	--	-----	-----------	------	----	-------

**MORGAN**

4/4		1.6	71	01.82 - 93	CVH Ford	4	0,8	BCPR6ES	2330	12	LPG 3
4/4		1.6	72	01.82 -	132D.000	4	0,7	BP6ES	7811	4	LPG 2
4/4		1.8	89	02.93 -	Zetec 16V	4	1,3	PTR5A-13	2467	25	LPG 4
4/4		1.8		94 - 98	FORD ZETEC	4	1,0	PTR5A-10	5055		
Aero 8		4.4	210	00 -	BMW M62B44	8		BKR6EQU	3199	30	LPG 1
Plus 4		2.0	98	09.87 - 92	M16i	4	0,8	BCPR6ES	2330	12	LPG 3
Plus 4		2.0	99	09.92 - 96	T16	4	0,8	BCPR6ES	2330	12	LPG 3
Plus 8		3.5	136	01.90 - 01	V8 Rover Cat.	8	0,7	BP6ES	7811	4	LPG 2
Plus 8		3.5	142	01.90 - 01	V8 Rover	8	0,7	BP6ES	7811	4	LPG 2
Plus 8		3.9	140	01.90 - 09.03	V8 Kat Rover	8	0,8	BPR6ES	7822	2	LPG 2
Plus 8		4.0		01 -	ROVER V8	8	1,1	PFR6N-11	3546		LPG 1
Plus 8		4.6		97 - 99	ROVER V8	8	1,1	PFR6N-11	3546		LPG 1

**NISSAN****100 NX**

100 NX	B13	1.6	66	10.90 - 95	GA16DE Cat.	4	0,9	BKR6E	6962	28	LPG 1
--------	-----	-----	----	------------	-------------	---	-----	-------	------	----	-------

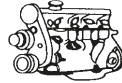
Code *l* kW

Cyl.



Stock-No.



LPG/CNG

**NISSAN  
100 NX**

100 NX	B13	1.6	66	10.90 - 93	GA16DS	Cat.	4	0,9	BKR6E	6962	28	LPG 1
100 NX	B13	1.6	75	09.93 - 94	GA16DE		4	0,8	BKR5E	7938	35	LPG 1
100 NX	B13	2.0	105	10.90 - 95	SR20DE	Cat.	4	0,9	BKR6EY	3696		LPG 1

**200 SX**

200 SX Turbo	S13	1.8	124	89 - 93	CA18DET		4	1,1	PFR6A-11	4045		PFR6A-11
200 SX Turbo	S13	1.8	124	09.88 - 93	CA18DET	Cat.	4	1,1	PFR6A-11	4045		PFR6A-11
200 SX Turbo	S13	1.8	129	09.88 - 93	CA18DET		4	1,1	BCPR6ES-11	7121	11	LPG 3
200 SX Turbo	S14	2.0	147	08.94 - 12.99	SR20DET		4	0,9	PFR6B-9	3100		PFR7B

**300 ZX**

300 ZX	Z32	3.0		90 - 96	VG30DE		6	1,1	PFR6B-11	4014		PFR7B
300 ZXTT Biturbo	Z32	3.0	197	90 - 95	VG30DETT		6	1,1	PFR6B-11C	2684		
300 ZX Biturbo	Z32	3.0	206	01.90 - 95	VG30DETT	Cat.	6	1,1	PFR6B-11C	2684		

**350 Z**

350 Z	Z33	3.5	206	10.03 - 06.06	VQ35DE		6	1,1	PLFR5A-11	6240		LPG 7
350 Z	Z33	3.5	221	04.06 - 01.07	VQ35DE		6	1,1	PLFR5A-11	6240		LPG 7
350 Z	Z33	3.5	230	09.05 -	VQ35HR		6	1,1	DF7H-11B	1317		

**370 Z**

370 Z	Z34	3.7	241	06.09 -	VQ37VHR		6	1,1	DF8H-11B	1305		
370 Z	Z34	3.7	243	06.09 -	VQ37VHR		6	1,1	DF8H-11B	1305		

**ALMERA 1**

Almera 1.4	N15	1.4	55	09.95 - 04.00	GA14DE		4	0,8	BKR5E	7938	35	LPG 1
Almera 1.6	N15	1.6	66	09.95 -	GA16DE		4	0,8	BKR5E	7938	35	LPG 1
Almera 1.6	N15	1.6	66	95 - 00	QG15DE		4	1,1	BKR5E-11	6953	33	LPG 1
Almera 2.0 D	N15	2.0	55	07.95 - 00	CD20E		4	☑	CY52	3017		
Almera 2.0 Gti	N15	2.0	105	95 - 04.00	SR20DE		4	1,1	BKR5EY-11	2355		LPG 1

**ALMERA 2**

Almera 1.5 dCi	N16	1.5	60	01.03 -	K9K		4	☑	Y-732J	5605	4	
Almera 1.5	N16	1.5	66	02.00 - 09.02	QG15DE		4	1,1	BKR5E-11	6953	33	LPG 1
Almera 1.5	N16	1.5	72	10.02 -	QG15DE		4	1,1	LFR5A-11	6376		LPG 7
Almera 1.8	N16	1.8	84	02.00 - 09.02	QG18DE		4	1,1	BKR5E-11	6953	33	LPG 1
Almera 1.8	N16	1.8	85	10.02 -	QG18DE		4	1,1	LFR5A-11	6376		LPG 7
Almera 2.2 dCi	N16	2.2	82	09.03 -	YD22DDTi		4	☑	Y-519J	93293	61	
Almera 2.2 dCi	N16	2.2	100	09.03 -	YD22DDTi		4	☑	Y-519J	93293	61	

**ALMERA TINO**

Almera Tino 1.8	V10	1.8	84	00 - 02	QG18DE		4	1,1	BKR5E-11	6953	33	LPG 1
Almera Tino 1.8	V10	1.8	85	03 -	QG18DE		4	1,1	LFR5A-11	6376		LPG 7
Almera Tino 2.0	V10	2.0	100	00 - 02	SR20DE		4	1,1	PFR6G-11	5555		PFR7G
Almera Tino 2.2 dCi	V10	2.2	82	09.03 -	YD22DDTi		4	☑	Y-519J	93293	61	
Almera Tino 2.2 dCi	V10	2.2	100	09.03 -	YD22DDTi		4	☑	Y-519J	93293	61	

**BLUEBIRD**

Bluebird 1.8		1.8		90 -	CA18NS		4	0,8	BCP5ES	7496	16	LPG 3
Bluebird 1.8		1.8		90 -	CA18S		4	0,8	BCP5ES	7496	16	LPG 3
Bluebird 1.6	U13	1.6		94 -	CA16NS		4	0,8	BCP5ES	7496	16	LPG 3
Bluebird 2.0	U13	2.0		93 -	CA20E		4	1,1	BCPR6ES-11	7121	11	LPG 3
Bluebird 2.0	U13	2.0		93 -	CA20S		4	0,7	BCP6ES	4930	17	LPG 3

**CABSTER**

Cabster 1.6	F23 / H41	1.6		93 -	Z16		4	0,8	BP5ES	6511	8	LPG 2
Cabster 2.0	F23 / H41	2.0		93 -	Z20		4	0,8	BP5ES	6511	8	LPG 2
Cabster 2.4	F23 / H41	2.4		93 -	Z24		6	0,7	BP6ES	7811	4	LPG 2

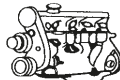
Code *l* kW

Cyl.



Stock-No.

**NISSAN****CARAVAN**

Caravan 2.0		2.0	120	01.01 -	KA20DE (DOHC)	4	1,1	BKR5E-11	6953	33	LPG 1
Caravan 2.4		2.4		01.01 -	KA24DE (DOHC)	4	1,1	BKR5E-11	6953	33	LPG 1

**CUBE**

Cube 1.5 dCi	Z12	1.5	78	03.10 -	K9K	4		Y1035AS	94103	77	
Cube 1.5 dCi	Z12	1.5	81	03.10 -	K9K	4		Y1035AS	94103	77	
Cube 1.6 16V	Z12	1.6	81	03.10 -	HR16DE	4	1,1	LZKAR6AP-11	6643		LZKAR6AP-11

**D 21**

D21		2.5		93 -	TD25			Y-707RS	4937		
D21		2.7		93 -	TD27			Y-707RS	4937		
D21		2.7		93 -	TD27T			Y-712RS	6140		

**EVALIA**

Evalia 1.5 dCi	M20M	1.5	66	04.11 -	K9K	4		Y1035AS	94103	77	
Evalia 1.5 dCi	M20M	1.5	81	04.11 -	K9K	4		Y1035AS	94103	77	
Evalia 1.6 16V	M20M	1.6	81	07.10 -	HR16DE	4	1,1	PLZKAR6A-11	5118		PLZKAR6A-11

**GLORIA**

Gloria	MY34	2.5		06.99 - 06.00	VQ25DD Ne-Di	4	1,1	PFR5P-11	4341		PFR5P-11
Gloria		2.5		06.00 -	VQ25DD	4	1,1	FR5BP-11	6247		

**INTERSTAR**

Interstar dCi 80	X70	1.9	60	07.02 -	F9Q772	4		Y-732J	5605	4	
Interstar dCi 90	X70	2.2	66	07.02 -	G9T722	4		Y-517J	3319	66	
Interstar dCi 100	X70	2.5	74	04.06 -	G9U754	4		Y-517J	3319	66	
Interstar dCi 115	X70	2.5	84	04.02 -	G9U720	4		Y-517J	3319	66	
Interstar dCi 120	X70	2.5	88	09.06 -	G9U650	4		Y-517J	3319	66	
Interstar dCi 150	X70	2.5	107	09.06 -	G9U632	4		Y-517J	3319	66	

**JUKE**

Juke 1.5 dCi	F15E	1.5	81	06.10 -	K9K	4		Y1035AS	94103	77	
Juke 1.6	F15E	1.6	86	06.10 -	HR16DE	4	1,1	DILZKAR6A11	91691		
Juke 1.6	F15E	1.6	140	06.10 -	MR16DDT	4	0,9	DILKAR7C9H	91215		
Juke 1.6 4x4	F15E	1.6	140	06.10 -	MR16DDT	4	0,9	DILKAR7C9H	91215		
Juke 1.6 DIG-T	F15E	1.6	147	11.12 -	MR16DDT	4	0,9	DILKAR7C9H	91215		

**KUBISTAR**

Kubistar 1.2	X76	1.1	43	03 -	D7F	4		BKR5EK	7956	23	LPG 1
Kubistar 1.2 16V	X76	1.2	55	04.06 -	D4F-712	4	0,8	LZKAR7A	6799		LZKAR7A
Kubistar Cdi	X76	1.5	48	08.03 -	K9K	4		Y-732J	5605	4	
Kubistar Cdi	X76	1.5	60	08.03 -	K9K	4		Y-732J	5605	4	
Kubistar 1.6 16V	X76	1.6	70	09.03 -	K4M-720 / 744 / 745 / 748	4	0,9	BKR6E	6962	28	LPG 1

**MAXIMA**

Maxima	J30	3.0	125	10.88 - 95	VG30E	6	1,1	BKR6ES-11	5553	14	LPG 1
Maxima	J30	3.0			VG30DE	6	1,1	PFR5C-11	2271		PFR5C-11

**MAXIMA QX**

Maxima QX	A32	2.0	103	95 - 00	VQ20DE	6	1,1	PFR6G-11	5555		PFR7G
Maxima QX	A32	3.0	141	95 - 00	VQ30DE	6	1,1	PFR6G-11	5555		PFR7G
Maxima QX	A33	2.0	103	00 -	VQ20DE	6	1,1	PFR6G-11	5555		PFR7G
Maxima QX	A33	3.0	147	00 -	VQ30DE	6	1,1	PFR6G-11	5555		PFR7G

Code *l* kW

Cyl.



Stock-No.



LPG/CNG

**NISSAN  
MICRA 1**

Micra 1.0	K10	1.0	37	12.82 - 92	MA10S	4	0,9	BPR5ES	7422	6	LPG 2
Micra 1.0	K10	1.0	40	93 -	MA10	4	0,9	BPR5ES	7422	6	LPG 2
Micra 1.2	K10	1.2	40	01.86 - 93	MA12	4	1,1	BPR5ES-11	4424		LPG 2
Micra 1.3 Super S	K10	1.3	55	93 -	CG13DE	4	1,1	BKR5E-11	6953	33	LPG 1

**MICRA 2**

Micra 1.0 16V	K11	1.0	40	93 - 00	CG10DE Cat.	4	1,1	BKR5E-11	6953	33	LPG 1
Micra 1.0	K11	1.0	44	00 - 02	CG10DE	4	1,1	BKR5E-11	6953	33	LPG 1
Micra 1.3 16V	K11	1.3	55	93 - 00	CG13DE Cat.	4	1,1	BKR5E-11	6953	33	LPG 1
Micra 1.3 16 V Sport	K11	1.3	60	00 - 02	CGA3DE	4	1,1	BKR5E-11	6953	33	LPG 1
Micra 1.5 dCi	K11	1.5	42	98 - 00	VJX	4	<input checked="" type="checkbox"/>	Y-503J	1009	10	
Micra 1.5 dCi	K11	1.5	42	98 - 00	VJZ	4	<input checked="" type="checkbox"/>	Y-503J	1009	10	

**MICRA 3**

Micra 1.0	K12	1.0	48	01.03 - 05.05	CG10DE	4	1,1	LFR5E-11	1669		LPG 7
Micra 1.2	K12	1.2	48	02.03 -	CR12DE	4	1,1	LFR5E-11	1669		LPG 7
Micra 1.2	K12	1.2	59	02.03 -	CR12DE	4	1,1	LFR5E-11	1669		LPG 7
Micra 1.4	K12	1.4	65	02.03 -	CR14DE	4	1,1	LFR5E-11	1669		LPG 7
Micra dCi	K12	1.5	48	04.03 -	K9K	4	<input checked="" type="checkbox"/>	Y-732J	5605	4	
Micra dCi	K12	1.5	60	09.03 -	K9K	4	<input checked="" type="checkbox"/>	Y-732J	5605	4	
Micra 1.6	K12	1.6	81	07.05 -	HR16DE	4	1,1	PLZKAR6A-11	5118		PLZKAR6A-11
Micra C+C	K12	1.6	81	06 -	HR16DE	4	1,1	PLZKAR6A-11	5118		PLZKAR6A-11
Micra SR160	K12	1.6	85	07 -	HR16DE	4	1,1	PLZKAR6A-11	5118		PLZKAR6A-11

**MICRA 4**

Micra 1.2	K13	1.2	59	05.10 -	HR12DE	3	1,1	LZKAR6AP-11	6643		LZKAR6AP-11
Micra 1.2 DIG	K13	1.2	72	04.11 -	HR12DDR	3	1,1	LZKAR6AP-11	6643		LZKAR6AP-11

**MURANO 1**

Murano 2.5	Z50	2.5		09.04 -	QR25DE	4	1,1	LFR5A-11	6376		LPG 7
Murano 3.5	Z50	3.5	172	12.02 -	VQ35DE	6	1,1	PLFR5A-11	6240		LPG 7

**MURANO 2**

Murano II 3.5	Z51	3.5	188	10.08 -	VQ35DE	6	1,1	DF7H-11B	1317		
Murano II 3.5	Z51	3.5	191	01.10 -	VQ35DE	6	1,1	DF7H-11B	1317		
Murano II 3.5	Z51	3.5	195	11.07 -	VQ35DE	6	1,1	DF7H-11B	1317		

**NAVARA**

Navara 2.5 dCi d22		2.5	128	05 -	YD25DDTI	4	<input checked="" type="checkbox"/>	Y-519J	93293	61	
--------------------	--	-----	-----	------	----------	---	-------------------------------------	--------	-------	----	--

**NOMAD**

Nomad		2.0			LD20		<input checked="" type="checkbox"/>	CY51	2696		
-------	--	-----	--	--	------	--	-------------------------------------	------	------	--	--

**NOTE**

Note 1.4	E11	1.4	65	03.06 -	CR14DE	4	1,1	LFR5E-11	1669		LPG 7
Note 1.5 dCi	E11	1.5	50	03.06 -	K9K 700	4	<input checked="" type="checkbox"/>	Y-732J	5605	4	
Note 1.5 dCi	E11	1.5	63	03.06 -	K9K	4	<input checked="" type="checkbox"/>	Y-732J	5605	4	
Note 1.5 dCi	E11	1.5	66	09.10 -	K9K 276	4	<input checked="" type="checkbox"/>	Y1035AS	94103	77	
Note 1.6	E11	1.6	81	03.06 -		4	1,1	PLZKAR6A-11	5118		PLZKAR6A-11
Note 1.6	E11	1.6	85	03.06 -	HR16DE	4	1,1	PLZKAR6A-11	5118		PLZKAR6A-11

**NV 200**

NV200 1.5 dCi	M20M	1.5	66	04.11 -	K9K	4	<input checked="" type="checkbox"/>	Y1035AS	94103	77	
NV200 1.5 dCi	M20M	1.6	81	04.11 -	K9K	4	<input checked="" type="checkbox"/>	Y1035AS	94103	77	
NV200 1.6 16V	M20M	1.6	81	02.10 -	HR16DE	4	1,1	PLZKAR6A-11	5118		PLZKAR6A-11

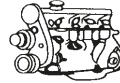
Code *l* kW

Cyl.



Stock-No.

V-TIME  
E-POWER  
LPG/CNG**NISSAN****PATHFINDER**

Pathfinder 2.5 dCi		2.5	128	04.05 -	YD25DDTI	4	█	Y-519J	93293	61	
Pathfinder	D21	2.0			Z20S	4	0,8	BPR6ES	7822	2	LPG 2
Pathfinder	D21	2.4			KA24	6	1,1	ZFR5E-11	4435		
Pathfinder	D21	2.4			Z24i	6	0,9	BPR5ES	7422	6	LPG 2
Pathfinder	D21	2.4			Z24S	6	0,8	BPR6ES	7822	2	LPG 2
Pathfinder	D21	2.5		93 -	TD25	4	█	Y-707RS	4937		
Pathfinder	D21	2.7		93 -	TD27	4	█	Y-707RS	4937		
Pathfinder	D21	2.7		93 -	TD27T	4	█	Y-712RS	6140		
Pathfinder	D21	3.0			VG30i	6	1,1	BCPR5ES-11	3524		LPG 3
Pathfinder	D21	3.0		92 -	VG30E	6	0,9	BKR6EY	3696		LPG 1
Pathfinder	R50	3.3	110	92 - 12.00	VG33E V6	6	1,1	BKR5E-11	6953	33	LPG 1
Pathfinder	R50	3.3	110	97 - 00	VG33E V6	6	1,1	BKR5ES-11	2382	33	LPG 1
Pathfinder	R50	3.5	162	01.00 -	VQ35E V6	6	1,1	PLFR5A-11	6240		LPG 7
Pathfinder	R51M	4.0	198	09.05 -	VQ40DE	6	1,1	LFR5AIX-11	4469		LPG 7

**PATROL**

Patrol	Y60 / 260	2.0		04.89 -	RB30S	4	0,9	BKR6E	6962	28	LPG 1
Patrol		2.7		02.93 -	TD27	6	█	Y-707RS	4937		
Patrol (4,5,6 Cyl CX51.)(1,2,3 Cyl.CZ51)	Y61	2.8	95	04.98 -	RD28	6	█	CX51	2896		
					only if NGK is OE		█	+ CZ51	+3209		
Patrol (4,5,6 Cyl CX51.)(1,2,3 Cyl.CZ51)	Y60 / 160	2.8			RD28T	6	█	CX51	2896		
							█	+ CZ51	+3209		
Patrol 3.0 Di	Y61	3.0	116	05.00 - 06	ZD30DDTi	4	█	CZ71	6836		
					only if NGK is OE						
Patrol 3.0 Di	Y61	3.0	116	06 - 09	ZD30DDTi	4	█	Y-522J	5939		
					only if NGK is OE						
Patrol		3.3		11.84 -	SD33 12V	6	█	Y-705RS	1249		
Patrol		3.3		11.84 -	SD33 24V	6	█	Y-755RS	7771		
Patrol		3.3		11.84 -	SD33T 12V	6	█	Y-705RS	1249		
Patrol		3.3		11.84 -	SD33T 24V	6	█	Y-755RS	7771		
Patrol		4.2		- 92	TB42S	6	0,8	BP5ES	6511	8	LPG 2
Patrol		4.2			TD42 12V	6	█	Y-707RS	4937		
Patrol		4.2			TD42 24V	6	█	Y-757RS	4018		
Patrol	160	4.2		- 12.98	TD42 12V	6	█	Y-707RS	4937		
Patrol	160	4.2		- 12.98	TD42 24V	6	█	Y-757RS	4018		
Patrol	Y60	4.2		88 - 12.95	TB42S	6	0,7	BP6ES	7811	4	LPG 2
Patrol	Y60	4.2		93 - 94	RB42S	6	0,9	BPR5E	7281	6	LPG 2
Patrol	Y60	4.2		93 -	TB42E	6	0,9	BPR5E	7281	6	LPG 2
Patrol		4.5		98 -	TB45E	6	1,1	BPR5E-11	5638		LPG 2

**PICK UP**

Pick-Up	B120	1.2		93 -	A12	4	0,8	BP5ES	6511	8	LPG 2
Pick-Up	D21	1.6		09.85 -	Z16	4	0,8	BPR6ES	7822	2	LPG 2
Pick-Up	D21	2.0		09.85 - 04.92	Z20	4	0,8	BPR6ES	7822	2	LPG 2
Pick-Up	D21	2.0		04.92 -	Z20S	4	0,8	BPR6ES	7822	2	LPG 2
Pick-Up	720	2.2	71	03.86 - 04.93	Z22	4	0,7	BP6ES	7811	4	LPG 2
Pick-Up	720	2.3		87 -	SD23	4	█	Y-705RS	1249		
Pick-Up	D21	2.4	74	09.85 - 04.92	Z24	4	0,8	BPR6ES	7822	2	LPG 2
Pick-Up	D21	2.4	76	10.88 - 04.92	Z24i	4	0,8	BPR6ES	7822	2	LPG 2
Pick-Up	D21	2.4	88	98 - 01	KA24E	4	1,1	ZFR5E-11	4435		
Pick-Up	MD21	2.4	93	94 - 98	KA24E	4	1,1	ZFR5E-11	4435		
Pick-Up	D22	2.4	98	02 -	KA24E	4	1,1	BKR6E-11	2756	14	LPG 1

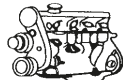

Code *l* kW

Cyl.



Stock-No.



LPG/CNG

**NISSAN  
PICK UP**

Pick Up		2.5	98	12.01 -	YD25DDTi	4		Y-519J	93293	61	
Pick-Up	720	2.5		87 -	SD25	4		Y-705RS	1249		
Pick Up		3.0		90 -	VG30I	6	1,1	BCPR5ES-11	3524		LPG 3
Pick Up		3.0		93 -	VG30E	6	0,9	BKR6EY	3696		LPG 1

**PIXO**

Pixo	UA0	1.0	50	06.09 -	K10B	3	1,1	IKR6G11	7980		IKR6G11
------	-----	-----	----	---------	------	---	-----	---------	------	--	---------

**PRAIRIE**

Prairie	M11	2.0	98	93 - 95	CA20S	4	0,7	BCP6ES	4930	17	LPG 3
Prairie	M11	2.0		90 - 92	CA20S	4	0,8	BCPR6ES	2330	12	LPG 3
Prairie	M11	2.4	98	94 - 95	KA24E		1,1	ZFR5E-11	4435		
Prairie	M11	3.0	98	92 - 95	KA24E	4	1,1	ZFR5E-11	4435		
Prairie 4 x EX + 4 x IN	M11	2.0	72	10.88 - 92	CA20E Twin Spark Cat.	4	1,1	BCPR5ES-11 + BCPR6ES-11	3524 + 7121		LPG 3 * 8 pcs
Prairie 4 x EX + 4 x IN	M11	2.0	73	10.88 - 92	CA20E Twin Spark	4	1,1	BCPR5ES-11 + BCPR6ES-11	3524 + 7121		LPG 3 * 8 pcs
Prairie 4 x EX + 4 x IN	M11	2.0	98	93 - 95	CA20E Twin Spark	4	1,1	BCPR5ES-11 + BCPR6ES-11	3524 + 7121		LPG 3 * 8 pcs

**PRIMASTAR**

Primastar dCi 80	X83	1.9	60	03.01 -		4		Y-732J	5605	4	
Primastar dCi 100	X83	1.9	74	03.01 -		4		Y-732J	5605	4	
Primastar J4	X83	2.0	88	03 -	F4R	4	0,9	BKR6EZ	4619	38	LPG 1
Primastar dCi 140	X83	2.5	99	09.03 -	G9U730	4		Y-517J	3319	66	
Primastar dCi 150	X83	2.5	107	09.06 -	G9U632	4		Y-517J	3319	66	

**PRIMERA 1**

Primera 1.6	P10	1.6	66	07.90 - 93	GA16DS Cat.	4	0,9	BKR6E	6962	28	LPG 1
Primera 1.6	P10	1.6	66	93 - 97	GA16DE	4	0,9	BKR5EY	7390		LPG 1
Primera 1.6	P10	1.6	66	93 -	GA16DS	4	0,9	BKR6E	6962	28	LPG 1
Primera 1.6	P10	1.6	66	93 - 96	GA16DE	4	0,8	BKR5E	7938	35	LPG 1
Primera 1.6	P10	1.6	66	93 -	GA16DS	4	0,9	BKR6EY	3696		LPG 1
Primera 1.6	P10E	1.6	66	06.90 - 93	GA16DS Cat.	4	0,9	BKR6E	6962	28	LPG 1
Primera 1.6	P10	1.6	70	07.90 - 93	GA16DS	4	0,9	BKR6E	6962	28	LPG 1
Primera 1.6	P10E	1.6	70	06.90 - 92	GA16DS	4	0,9	BKR6E	6962	28	LPG 1
Primera 2.0	P10	2.0	55	07.90 - 04.96	CD20	4		CY52	3017		
Primera 2.0	P10	2.0	55	01.91 - 06.96	CD20	4		CY52	3017		
Primera 2.0	P10	2.0	85	07.90 - 96	SR20Di	4	0,9	BKR5EY	7390		LPG 1
Primera 2.0	P10	2.0	85	93 - 96	SR20DE	4	0,9	BKR5EY	7390		LPG 1
Primera 2.0	P10E	2.0	85	06.90 - 96	SR20Di	4	0,9	BKR5EY	7390		LPG 1
Primera 2.0	P10	2.0	89	07.90 - 96	SR20Di SPI	4	0,9	BKR5EY	7390		LPG 1
Primera 2.0	P10E	2.0	89	06.90 - 96	SR20Di SPI	4	0,9	BKR5EY	7390		LPG 1
Primera 2.0	P10E	2.0	110	06.90 - 96	SR20DE EGI Cat.	4	0,9	BKR6EY	3696		LPG 1

**PRIMERA 2**

Primera 1.6	P11	1.6	66	96 -	GA16DE	4	0,9	BKR6E	6962	28	LPG 1
Primera 1.6 16V	P11	1.6	74	09.96 - 00	GA16DE	4	0,8	BKR5E	7938	35	LPG 1
Primera 1.6	P11	1.6	78	02.00 - 07.02	QG16DE	4	1,1	BKR5E-11	6953	33	LPG 1
Primera 1.8	P11	1.8	83	02.00 - 02	QG18DE	4	1,1	BKR5E-11	6953	33	LPG 1
Primera 2.0 16V	P11	2.0	85	09.96 - 99	SR20DE	4	1,1	BKR5EY-11	2355		LPG 1
Primera 2.0	P11	2.0	91	96 - 99	SR20DE	4	0,9	BKR5EY	7390		LPG 1
Primera 2.0 16V	P11	2.0	96	09.96 - 99	SR20DE	4	1,1	BKR5EY-11	2355		LPG 1

Code *l* kW

Cyl.



Stock-No.

**NISSAN****PRIMERA 2**

Primera 2.0	P11	2.0	103	00 - 02	SR20DE	4	1,1	PFR6G-11	5555		PFR7G
Primera 2.0	P11	2.0	109	96 - 99	SR20DE	4	0,9	BKR5EY	7390		LPG 1
Primera 2.0	P11	2.0	110	06.97 - 99	SR20DE	4	0,9	BKR6EY	3696		LPG 1
Primera 2.0 GT UK	P11	2.0	110	04.97 -	SR20DE	4	1,1	BKR5EY-11	2355		LPG 1

**PRIMERA 3**

Primera 1.6	P12	1.6	78	01.02 -	QG16DE	4	1,1	LFR5A-11	6376		LPG 7
Primera 1.8	P12	1.8	85	03.02 -	QG18DE	4	1,1	LFR5A-11	6376		LPG 7
Primera 1.8 Traveller	P12	1.8	85	03.02 -	QG18DE	4	1,1	LFR5A-11	6376		LPG 7
Primera 1.9 dCi	P12	1.9	88	09.03 -	F9Q...	4	█	Y-732J	5605	4	
Primera 2.0	P12	2.0	103	03.02 -	QR20DE	4	1,1	LFR5A-11	6376		LPG 7
Primera 2.0	P12	2.0		08.01 - 06.03	SR20VE	4	0,9	PLFR6A-9	4342		LPG 7
Primera 2.0 Wagon	P12	2.0		08.01 - 06.03	SR20VE	4	0,9	PLFR6A-9	4342		LPG 7
Primera 2.2 Di	P12	2.2	93	03.02 -	YD22ET	4	█	Y-519J	93293	61	
Primera 2.2 dCi	P12	2.2	102	04.03 -	YD22DDT	4	█	Y-519J	93293	61	

**QASHQAI 1**

Qashqai I 1.5 dCi	J10	1.5	76	07.08 - 06.10	K9K	4	█	Y-732J	5605	4	
Qashqai I 1.5 dCi	J10	1.5	78	02.07 - 06.10	K9K	4	█	Y-732J	5605	4	
Qashqai I 1.6	J10	1.6	84	02.07 -	HR16DE	4	1,1	PLZKAR6A-11	5118		PLZKAR6A-11
Qashqai I 2.0	J10	2.0	104	02.07 -	MR20DE	4	1,1	PLZKAR6A-11	5118		PLZKAR6A-11

**SERENA**

Serena 1.6	C23M	1.6	71	07.93 -	GA16DE Cat.	4	0,8	BKR5E	7938	35	LPG 1
Serena 2.0 D	C23M	2.0	49	07.92 - 01.96	LD20	4	█	CY51	2696		
Serena 2.0	C23M	2.0	93	01.92 -	SR20DE Cat.	4	0,9	BKR5EY	7390		LPG 1
Serena 2.3 D	C23M	2.3	55	01.95 - 02.98	LD23	4	█	Y-712RS	6140		
Serena 2.3 D	C23M	2.3	55	03.98 -	LD23	4	█	Y-530J	6586		
Serena 2.0	C25	2.0		05.05 -	MR20DE	4	1,1	LZKAR6AP-11	6643		LZKAR6AP-11

**SILVIA**

Silvia RS12 4x EX + 4 x IN		1.8	90	89 - 95	CA18E	4	1,1	BCPR5ES-11 + BCPR6ES-11	3524 + 7121		LPG 3 * 8 pcs
Silvia Turbo 4x EX + 4 x IN S12(CH)		1.8	90	10.83 - 95	CA18ET Cat.	4	1,1	BCPR5ES-11 + BCPR6ES-11	3524 + 7121		LPG 3 * 8 pcs

**SKYLINE**

Skyline V6 24V	V35	2.5	158	02 -	VQ25DD	6	1,1	LFR5AIX-11	4469		LPG 7
Skyline	V35	2.6		98 -	RB26DETT	6	1,1	PFR7A-11	4579		PFR7A-11
Skyline V6 24V	V35	3.0	191	02 -	VQ30DD	6	1,1	LFR5AIX-11	4469		LPG 7
Skyline V6 24V	V35	3.5	200	02 -	VQ35DE	6	1,1	LFR5AIX-11	4469		LPG 7

**SUNNY**

Sunny 1.0	B13	1.0		93 - 95	E10S Cat.	4	0,8	BP5ES	6511	8	LPG 2
Sunny 1.3	B13	1.3		93 - 95	GA13DS	4	0,9	BKR6E	6962	28	LPG 1
Sunny 1.4	B13	1.4	55	93 - 95	GA14DS	4	0,9	BKR6E	6962	28	LPG 1
Sunny 1.6	B13	1.6		- 96	GA16DE	4	0,9	BKR6E	6962	28	LPG 1
Sunny 1.6	B13	1.6		- 95	GA16DS	4	0,9	BKR6E	6962	28	LPG 1
Sunny 1.7 D	B13	1.7	40	93 - 96	CD17	4	█	CY51	2696		
Sunny 2.0	B13	2.0		91 - 96	SR20DE	4	0,9	BKR6EY	3696		LPG 1
Sunny 1.3	B14	1.3		95 -	GA13DE	4	1,1	BKR6E-11	2756	14	LPG 1
Sunny 1.3	B14	1.3		95 -	GA13DS	4	0,9	BKR6E	6962	28	LPG 1

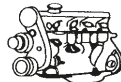
Code *l* kW

Cyl.



Stock-No.



LPG/CNG

**NISSAN  
SUNNY**

Sunny 1.4	B14	1.4		95 -	GA14DE	4	0,9	BKR6E	6962	28	LPG 1
Sunny 1.6	B14	1.6		95 -	GA16DE	4	1,1	BKR6E-11	2756	14	LPG 1
Sunny 1.8	B14	1.8		95 -	GA18DE(A)	4	1,1	BKR6E-11	2756	14	LPG 1
Sunny 1.8	B14	1.8		95 -	GA18DE(B)	4	0,9	BKR6E	6962	28	LPG 1
Sunny 2.0 D	B14	2.0	55	10.90 -	CD20	4		CY52	3017		
Sunny 2.0 D	B14	2.0			CD20	4		CY51	2696		
Sunny 2.0	B14	2.0		95 -	SR20DE	4	0,9	BKR6EY	3696		LPG 1
Sunny 1.4	N14	1.4	55	10.90 - 93	GA14DS	4	0,8	BKR5E	7938	35	LPG 1
Sunny 1.4	N14	1.4	55	10.92 - 95	GA14DE	4	0,8	BKR5E	7938	35	LPG 1
Sunny 1.6	N14	1.6	66	10.90 - 93	GA16DS	4	0,9	BKR6E	6962	28	LPG 1
Sunny 1.6	N14	1.6	66	10.92 - 95	GA16DE	4	0,8	BKR5E	7938	35	LPG 1
Sunny 1.6	N14	1.6	75	10.92 - 95	GA16DE	4	0,8	BKR5E	7938	35	LPG 1
Sunny 1.7 D	N14	1.7		91 - 91	CD17	4		CY52	3017		
Sunny 2.0 D	N14	2.0	55	10.90 - 95	CD20	4		CY52	3017		
Sunny 2.0	N14	2.0		95 -	SR20DET	4	0,6	PFR7B	4853		PFR8B
Sunny 2.0 D	N15	2.0	55	10.90 - 95	CD20	4		CY52	3017		
Sunny 1.6	Y10	1.6	66	94 - 00	GA16DS	4	0,9	BKR6E	6962	28	LPG 1
Sunny 1.6	Y10	1.6	67	94 - 00	SR16DE	4	0,8	BKR5E	7938	35	LPG 1
Sunny 1.7 D	Y10	1.7	40	93 - 96	CD17	4		CY51	2696		
Sunny 2.0 D	Y10	2.0	55	10.90 - 00	CD20	4		CY52	3017		
Sunny 2.0	Y10	2.0	105	93 - 00	GA20DE	4	0,9	BKR6EY	3696		LPG 1
Sunny 1.6	Y10L	1.6	66	10.90 - 93	GA16DS	4	0,9	BKR6E	6962	28	LPG 1
Sunny 1.6	Y10L	1.6	66	10.92 - 00	GA16DE	4	0,8	BKR5E	7938	35	LPG 1
Sunny 1.7 D	Y11	1.7	40	05.92 - 04.98	CD17	4		CY51	2696		
Sunny GTI	N14	2.0	105	10.90 - 05.95	SR20DE Cat.	4	0,9	BKR6EY	3696		LPG 1
Sunny GTI-R	N14	2.0	162	10.93 - 95	SR20DET Cat.	4	0,9	PFR7B-9	4180		PFR8B

**TEANA**

Teana 3.5	J32	3.5	185	07.08 -	VQ35DE	6	1,1	DF7H-11B	1317		
-----------	-----	-----	-----	---------	--------	---	-----	----------	------	--	--

**TERRANO 1**

Terrano 1	WD21	2.0			Z20S	4	0,8	BPR6ES	7822	2	LPG 2
Terrano 1 4 x EX + 4 x IN	WD21	2.4	76	08.86 - 92	Z24i Twin Spark	4	0,9	BPR5ES	7422	6	LPG 2 * 8 pcs
Terrano 1	WD21	2.4	76	08.87 - 07.92	Z24i Cat.	6	0,9	BPR5ES	7422	6	LPG 2
Terrano 1	WD21	2.5		- 95	TD25	4		Y-707RS	4937		
Terrano 1	WD21	2.7		- 95	TD27	4		Y-707RS	4937		
Terrano 1	WD21	3.0	109	01.90 - 07.96	VG30E Cat.	6	0,9	BKR6EY	3696		LPG 1

**TERRANO 2**

Terrano 2	R20	2.4	86	05.96 - 01	KA24E	6	1,1	ZFR5E-11	4435		
Terrano 2	R20	2.4	87	05.96 - 01	KA24E	6	1,1	ZFR5E-11	4435		
Terrano 2	R20	2.4	91	07.93 - 96	KA24E	6	1,1	ZFR5E-11	4435		
Terrano 2 Tdi only Europa	R20	2.7	92	05.96 - 02	TD27T For EU	4		CY58	5486		
Terrano 2 not Europe	R20	2.7		07.93 - 02	TD27T	4		Y-712RS	6140		
Terrano 2	R20	3.0	113	05.02 -	ZD30DDTI	4		CZ71	6836		
					only if NGK is OE						

**TIIDA**

Tiida 1.6	C11X	1.6	81	01.08 -	HR16DE	4	1,1	PLZKAR6A-11	5118		PLZKAR6A-11
Tiida 1.8	C11X	1.8	93	01.08 -	MR18DE	4	1,1	PLZKAR6A-11	5118		PLZKAR6A-11

**TINO**

Tino 1.8 16V V10		1.8	88	99 -	NEOQG18DE	4	1,1	BKR5E-11	6953	33	LPG 1
------------------	--	-----	----	------	-----------	---	-----	----------	------	----	-------

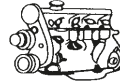
Code *l* kW

Cyl.



Stock-No.

V-TUNE  
E-POWER  
LPG/CNG**NISSAN****TINO**

Tino 2.0 16V V10		2.0	99	99 -	SR20DE	4	1,1	PFR6G-11	5555		PFR7G
Tino 2.0 16V V10		2.2	84	07.00 -	YD22DT	4	█	Y-519J	93293	61	

**URVAN**

Urvan	E23 / E24	2.0	64	11.86 - 97	Z20 OHC	4	0,9	BPR5ES	7422	6	LPG 2
Urvan	E23 / E24	2.0		95 - 97	NA20S	4	1,1	BPR6ES-11	4824	13	LPG 2
Urvan	E23 / E24	2.4	74	02.87 - 97	Z24S OHC	6	0,9	BPR5ES	7422	6	LPG 2
Urvan	E23 / E24	2.4	74	05.89 - 96	Z24i	6	0,9	BPR5ES	7422	6	LPG 2
Urvan	E23 / E24	2.4		95 - 97	Z24	6	0,7	BP6ES	7811	4	LPG 2
Urvan	E23 / E24	2.5		93 - 97	TD25	4	█	Y-707RS	4937		
Urvan QGS Type 2	E23 / E24	2.0		05.82 - 98	LD20T	4	█	Y-204SS	7629		
Urvan QGS Type 2	E23 / E24	2.3		05.82 -	SD23	4	█	Y-112M1	2531		
Urvan	E23 / E24	2.3		- 97	TD23	4	█	Y-707RS	4937		
Urvan	E23 / E24	2.3		05.82 - 97	SD23	4	█	Y-162R1	2431		
Urvan	E23 / E24	2.7		87 - 97	TD27	4	█	Y-707RS	4937		
Urvan QGS Type 1	E23 / E24	2.0		05.82 - 97	LD20T	4	█	Y-204RS	4573		
Urvan QGS Type 1	E23 / E24	2.3		05.82 - 97	SD23	4	█	Y-112R1	1032		

**VANETTE**

Vanette	M20	1.6		09 -	HR16DE	4	1,1	LZKAR6AP-11	6643		LZKAR6AP-11
Vanette		2.0			CD20	4	█	CY52	3017		
Vanette		2.0		93 -	SR20E	4	0,9	BKR5EY	7390		LPG 1
Vanette		2.3	55	05.98 -	LD23	4	█	Y-530J	6586		
Vanette	C22	2.4	74	09.86 - 93	Z24i	4	0,9	BPR5ES	7422	6	LPG 2
Vanette	C22	1.5	51	09.86 - 95	A15S	4	0,9	BPR5ES	7422	6	LPG 2
Vanette	C22	2.0	64	09.86 - 95	Z20S	4	0,8	BPR6ES	7822	2	LPG 2
Vanette	C22	2.0	44	04.87 - 11.94	LD20 II OHV	4	█	CY51	2696		
Vanette	C22	2.0	47	01.91 - 11.94	LD20 IIL	4	█	CY51	2696		
Vanette	C22	2.0	47	09.86 - 03.93	LD20 OHV	4	█	CY51	2696		
Vanette Cargo		2.0	49	07.92 - 09.94	LD20 OHV	4	█	CY51	2696		
Vanette Cargo (NL)		1.6	71	03.95 -		4	0,8	BKR5E	7938	35	LPG 1
Vanette E (NL)		1.6	71	03.95 -		4	0,8	BKR5E	7938	35	LPG 1

**X-TRAIL**

X-Trail 2.0	T30	2.0	103	06.01 -	QR20DE	4	1,1	LFR5A-11	6376		LPG 7
X-Trail 2.0	T30	2.0		02.01 -	SR20VET	4	0,9	PLFR6A-9	4342		LPG 7
X-Trail 2.2 dCi	T30	2.2	84	09.01 - 10.03	YD22DDTi	4	█	Y-519J	93293	61	
X-Trail 2.2 dCi	T30	2.2	100	11.03 -	YD22DDTi	4	█	Y-519J	93293	61	
X-Trail 2.5	T30	2.5	121	09.01 - 02.07	QR25DE	4	1,1	LFR5A-11	6376		LPG 7
X-Trail 2.5	T30	2.5	132	11.02 - 02.07	QR25DE	4	1,1	LFR5A-11	6376		LPG 7
X-Trail 2.0	T31	2.0	104	06.07 -	MR20DE	4	1,1	PLZKAR6A-11	5118		PLZKAR6A-11
X-Trail 2.5	T31	2.5	124	06.07 -	QR25DE	4	1,1	DILKAR6A11	9029		DILKAR6A11

**OPEL****ADAM**

Adam 1.2	M13	1.2	51	10.12 -	A12XEL	4	0,9	ZFR6V-G	8894		
Adam 1.4	M13	1.4	64	10.12 -	A14XEL	4	0,9	ZFR6V-G	8894		
Adam 1.4	M13	1.4	74	10.12 -	A14XER	4	0,9	ZFR6V-G	8894		

**AGILA H00**

Agila 12V	H00	1.0	43	07.00 -	Z10XE	3		BKR5EK	7956	23	LPG 1
Agila 12V	H00	1.0	44	04 -	Z10XEP	3	1,1	ZFR5F-11	2262		LPG 6
Agila 16V	H00	1.2	55	07.00 -	Z12XE	4		BKR5EK	7956	23	LPG 1

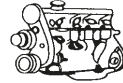
Code *l* kW

Cyl.

Stock-No.  
**VELINE**  
10-15-10-15-10-15

LPG/CNG

**OPEL  
AGILA H00**

Agila 16V	H00	1.2	59	07.04 -	Z12XEP	4	1,1	ZFR5F-11	2262		LPG 6
Agila 1.3 CDTI	H00	1.3	51	08.03 -	Z13DT	4	█	Y8003J	97256	62	

**AGILA H08 / F68**

Agila 1.0	H08 / F68	1.0	48	05.08 -	K10B	3	1,1	IKR6G11	7980		IKR6G11
Agila 1.0 LPG	H08 / F68	1.0	48	01.10 -	K10B	3	1,1	IKR6G11	7980		IKR6G11
Agila 1.2	H08 / F68	1.2	63	05.08 -	K12B	4	1,1	IKR6G11	7980		IKR6G11
Agila 1.2	H08 / F68	1.2	69	06.10 -	K12B	4	1,1	IKR6G11	7980		IKR6G11
Agila 1.2 LPG	H08 / F68	1.2	63	01.10 -	K12B	4	1,1	IKR6G11	7980		IKR6G11

**ANTARA**

Antara 2.0 CDTI		2.0	93	09.08 -	Z20DM	4	█	Y8009AS	96478		
Antara 2.0 CDTI		2.0	93	03.07 -	Z20S	4	█	Y8009AS	96478		
Antara 2.0 CDTI		2.0	110	05.06 -	Z20DMH	4	█	Y8009AS	96478		
Antara 2.4		2.4	103	09.06 -	Z24XED	4		BKR5EK	7956	23	LPG 1
Antara 3.2		3.2	167	09.06 -	Z32SE	6	1,3	PTR5A-13	2467	25	LPG 4

**ARENA**

Arena 1.9D		1.9	44	01.98 -	F8Q M6	4	█	Y-506R	4409	7	
Arena 2.5D		2.5	55	07.98 - 02.01	S8U V7	4	█	Y-908R	4585	1	

**ASTRA F**

Astra F 1.4		1.4	44	09.91 - 07.95	C14NZ OHC	4	0,9	BPR5ES	7422	6	LPG 2
Astra F 1.4		1.4	44	08.95 - 02.98	C14NZ OHC	4		BKR5EK	7956	23	LPG 1
Astra F 1.4		1.4	44	08.96 - 02.98	X14NZ OHC I	4		BKR5EK	7956	23	LPG 1
Astra F 1.4		1.4	55	09.91 - 03.93	14NV OHC I	4		BKR5EK	7956	23	LPG 1
Astra F 1.4 Si		1.4	60	09.91 - 07.95	C14SE OHC	4	0,9	BPR5ES	7422	6	LPG 2
Astra F 1.4 Si		1.4	60	03.93 - 07.95	14SE OHC	4	0,9	BPR5ES	7422	6	LPG 2
Astra F 1.4 Si		1.4	60	08.95 - 02.98	14SE OHC	4		BKR5EK	7956	23	LPG 1
Astra F 1.4 Si		1.4	60	08.95 - 02.98	C14SE OHC	4		BKR5EK	7956	23	LPG 1
Astra F 1.4 16V		1.4	66	02.96 - 02.98	X14XE DOHC	4		BKR5EK	7956	23	LPG 1
Astra F 1.6		1.6	52	03.93 - 03.94	X16SZ OHC	4	0,9	BPR5ES	7422	6	LPG 2
Astra F 1.6		1.6	52	04.94 - 12.94	X16SZ OHC	4	0,9	BPR5ES	7422	6	LPG 2
Astra F 1.6		1.6	52	01.95 - 02.96	X16SZ OHC	4		BKR5EK	7956	23	LPG 1
Astra F 1.6		1.6	55	09.91 - 07.95	C16NZ OHC	4	0,9	BPR5ES	7422	6	LPG 2
Astra F 1.6		1.6	55	08.94 - 02.98	16LZ2 OHC	4		BKR5EK	7956	23	LPG 1
Astra F 1.6		1.6	55	08.95 - 02.96	C16NZ OHC	4		BKR5EK	7956	23	LPG 1
Astra F 1.6		1.6	55	02.96 - 08.00	X16SZR OHC	4		BKR5EK	7956	23	LPG 1
Astra F 1.6		1.6	55	09.97 -	16NZR OHC	4		BKR5EK	7956	23	LPG 1
Astra F 1.6 Si		1.6	74	02.92 - 07.95	C16SE OHC I	4	0,9	BPR5ES	7422	6	LPG 2
Astra F 1.6 16V		1.6	74	08.94 - 02.98	X16XEL DOHC	4		BKR5EK	7956	23	LPG 1
Astra F 1.6 16V		1.6	74	08.95 - 02.98	C16SE OHC I	4		BKR5EK	7956	23	LPG 1
Astra F 1.7 D		1.7	42	09.91 - 09.92	17 D OHC II	4	█	Y-924U	4950	1	
Astra F 1.7 D		1.7	44	09.92 - 08.94	17 DR	4	█	Y-924U	4950	1	
Astra F 1.7 TD Eco		1.7	50	08.94 - 02.98	X17 DTL	4	█	Y-924U	4950	1	
Astra F 1.7 TD		1.7	60	12.91 - 02.98	17DT TC4 EE1 OHC	4	█	Y-603J	8838	60	
Astra F 1.7 TD		1.7	60	04.96 - 02.98	Isuzu Mot.956633—> X17DT TC4 EE1 OHC	4	█	Y-603J	8838	60	
Astra F 1.8		1.8	66	09.91 - 07.95	C18NZ OHC II	4	0,9	BPR5ES	7422	6	LPG 2
Astra F 1.8		1.8	66	08.95 - 02.98	C18NZ OHC II	4		BKR5EK	7956	23	LPG 1
Astra F 1.8 16V		1.8	85	02.94 - 03.96	C18XEL DOHC	4		BKR5EK	7956	23	LPG 1
Astra F 1.8 16V		1.8	85	02.96 - 02.98	X18XE DOHC	4		BKR5EK	7956	23	LPG 1

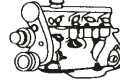

Code *l* kW

Cyl.



Stock-No.



LPG/CNG

**OPEL****ASTRA F**

Astra F 1.8 16V		1.8	92	05.93 - 04.94	C18XE DOHC II	4		BKR5EK	7956	23	LPG 1
Astra F 2.0		2.0	85	09.91 - 07.95	C20NE OHC II	4	0,9	BPR5ES	7422	6	LPG 2
Astra F 2.0		2.0	85	08.95 - 02.98	C20NE OHC II	4		BKR5EK	7956	23	LPG 1
Astra F 2.0 16V		2.0	100	02.95 - 02.98	X20XE DOHC	4		BKR5EK	7956	23	LPG 1
Astra F 2.0 GSI 16V		2.0	110	09.91 - 08.92	C20XE DOHC	4		BKR6EK	2288	20	LPG 1
Astra F 2.0 GSI 16V		2.0	110	09.91 - 08.92	C20XE-LN DOHC I	4		BKR6EK	2288	20	LPG 1
Astra F 2.0 GSI 16V		2.0	110	09.92 - 02.98	C20XE DOHC	4		BKR5EK	7956	23	LPG 1
Astra F 2.0 GSI 16V		2.0	110	09.92 - 02.98	C20XE-LN DOHC I	4		BKR5EK	7956	23	LPG 1

**ASTRA G**

Astra G 1.2 16V		1.2	48	03.98 - 00	X12XE DOHC	4		BKR5EK	7956	23	LPG 1
Astra G 1.2 16V		1.2	55	08.00 -	Z12XE	4		BKR5EK	7956	23	LPG 1
Astra G 1.4		1.4	66	08.00 -	Z14XE DOHC	4		BKR5EK	7956	23	LPG 1
Astra G 1.4 16V		1.4	66	03.98 -	X14XE DOHC	4		BKR5EK	7956	23	LPG 1
Astra G 1.6		1.6	55	03.98 - 08.00	X16SZR	4		BKR5EK	7956	23	LPG 1
Astra G 1.6		1.6	62	08.00 -	Z16SE	4		BKR5EK	7956	23	LPG 1
Astra G 1.6 CNG		1.6	71	09.02 - 06.04	Z16YNG	4		LPG 1	1496		LPG 1
Astra G 1.6 16V		1.6	74	03.98 -	X16XEL	4		BKR5EK	7956	23	LPG 1
Astra G 1.6 16V		1.6	74	03.03 -	Z16XEP	4	1,1	ZFR5F-11	2262		LPG 6
Astra G 1.6 16V		1.6	74	08.00 -	Z16XE	4		BKR5EK	7956	23	LPG 1
Astra G 1.7 TD		1.7	50	02.98 -	X17DTL	4	☑	Y-924U	4950	1	
Astra G 1.7 DTI 16V		1.7	55	02.00 - 01.05	Y17DT	4	☑	Y-541J	1983	42	
Astra G 1.7 CDTI		1.7	59	04.03 - 01.05	Z17DTL	4	☑	Y-541J	1983	42	
Astra G 1.8 16V		1.8	85	03.98 -	X18XE1	4		BKR5EK	7956	23	LPG 1
Astra G 1.8 16V		1.8	85	08.00 -	Z18XEL	4		BKR5EQUA	3566		
Astra G 1.8 16V		1.8	92	08.00 -	Z18XE	4		BKR5EK	7956	23	LPG 1
Astra G 2.0 DI		2.0	60	02.98 -	X20DTL SOHC	4	☑	Y-748U	6649	14	
Astra G 2.0 DI		2.0	60	08.00 -	Y20DTL	4	☑	Y-748U	6649	14	
Astra G 2.0 DTI II 16V to chassis no. 2H999999		2.0	74	08.00 -	Y20DTH	4	☑	Y-748U	6649	14	
Astra G 2.0 DTI II 16V from chassis no. 3H000001		2.0	74	08.00 -	Y20DTH	4	☑	Y-523J	6298	37	
Astra G 2.0 16V		2.0	100	03.98 -	X20XE	4		BKR5EK	7956	23	LPG 1
Astra G 2.0 16V		2.0	118	10.99 - 09.02	X20XER DOHC	4		BKR5EK	7956	23	LPG 1
Astra G 2.0 OPC Turbo		2.0	140	09.00 -	Z20LET	4		BKR5EK	7956	23	LPG 1
Astra G 2.0 OPC Turbo		2.0	147	11.02 - 05.05	Z20LER	4	0,7	ZFR5F	5165		LPG 6
Astra G 2.2 DTI		2.2	92	03 -	Y22DTR	4	☑	Y-523J	6298	37	
Astra G 2.2 16V		2.2	108	09.00 - 06	Z22SE	4		LTR6B-10T	5948		LTR6B-10T
Astra G 2.2 16V		2.2	108	01.99 -	X22XE DOHC	4		BKR5EK	7956	23	LPG 1

**ASTRA H**

Astra H 1.3 CDTI		1.3	66	06.04 -	Z13DTH	4	☑	Y8003J	97256	62	
Astra H 1.4		1.4	55	03.04 -	Z14XEL	4	1,1	ZFR5F-11	2262		LPG 6
Astra H 1.4		1.4	66	03.04 -	Z14XEP	4	1,1	ZFR5F-11	2262		LPG 6
Astra H 1.6		1.6	71	08.06 -	Z16YNG	4		LPG 1	1496		LPG 1
Astra H 1.6		1.6	74	03.04 -	Z16XEP	4	1,1	ZFR5F-11	2262		LPG 6
Astra H 1.6		1.6	85	01.07 -	Z16XER	4	1,1	ZFR5F-11	2262		LPG 6
Astra H 1.6 Turbo		1.6	132	10.06 -	Z16LET	4	0,9	ZFR6BP-G	1748		ZFR6BP-G
Astra H 1.7 CDTI		1.7	59	03.04 -	Z17DTL	4	☑	Y-541J	1983	42	
Astra H 1.7 CDTI		1.7	74	03.04 -	Z17DTH	4	☑	Y-541J	1983	42	
Astra H 1.7 CDTI		1.7	92	02.07 -	A17DTR	4	☑	Y-541J	1983	42	
Astra H 1.7 CDTI		1.7	92	03.07 -	Z17DTR	4	☑	Y-541J	1983	42	

Fgst = Chassis No.

Code *l* kW

Cyl.



Stock-No.



LPG/CNG

**OPEL  
ASTRA H**

Astra H 1.8		1.8	92	03.04 -	Z18XE	4	1,1	ZFR5F-11	2262		LPG 6
Astra H 1.8		1.8	103	05.06 -	Z18XER	4	1,1	ZFR5F-11	2262		LPG 6
Astra H 1.9 CDTI bis Fgst.-Nr. 72045139		1.9	74	09.05 -	Z19DTL	4	█	Y-534J	3413	36	
Astra H 1.9 CDTI ab Fgst.-Nr. 72045140		1.9	74	09.05 -	Z19DTL	4	█	Y1030J	90828	70	
Astra H 1.9 CDTI bis Fgst.-Nr. 72045139		1.9	88	04.04 -	Z19DT	4	█	Y-534J	3413	36	
Astra H 1.9 CDTI ab Fgst.-Nr. 72045140		1.9	88	04.04 -	Z19DT	4	█	Y1030J	90828	70	
Astra H 1.9 CDTI		1.9	88	04.05 -	Z19DTJ	4	█	YE07	6092		
Astra H 1.9 CDTI 16V		1.9	110	09.04 -	Z19DTH	4	█	YE07	6092		
Astra H 2.0 Turbo		2.0	125	03.04 -	Z20LEL	4	0,7	ZFR5F	5165		LPG 6
Astra H 2.0 Turbo		2.0	147	03.05 -	Z20LER	4	0,7	ZFR5F	5165		LPG 6
Astra H 2.0 Turbo OPC		2.0	177	09.05 -	Z20LEH	4		PFR6T-G	6314		PFR6T-G

**ASTRA J**

Astra J 1.4		1.4	64	10.09 -	A14XEL	4	0,9	ZFR6V-G	8894		ZFR6V-G
Astra J 1.4		1.4	74	10.09 -	A14XER	4	0,9	ZFR6V-G	8894		ZFR6V-G
Astra J 1.4 Turbo		1.4	88	07.10 -	A14NEL	4	0,7	IFR7X7G	91039		IFR7X7G
Astra J 1.4 Turbo		1.4	103	10.09 -	A14NET	4	0,7	IFR7X7G	91039		IFR7X7G
Astra J 1.4 LPG		1.4	103	10.09 -	A14NET	4	0,7	IFR7X7G	91039		IFR7X7G
Astra J 1.6		1.6	85	10.09 -	A16XER	4	0,9	ZFR6V-G	8894		ZFR6V-G
Astra J 1.6 Turbo		1.6	132	10.09 -	A16LET	4	0,9	ZFR6BP-G	1748		ZFR6BP-G
Astra J 1.8 GTC		1.8	103	10.11 -	A18XER	4	0,9	ZFR6V-G	8894		ZFR6V-G

**CALIBRA**

Calibra 2.0		2.0	85	06.90 - 07.95	C20NE OHC II	4	0,9	BPR5ES	7422	6	LPG 2
Calibra 2.0		2.0	85	08.95 - 08.97	C20NE OHC II	4		BKR5EK	7956	23	LPG 1
Calibra 2.0 16V		2.0	100	11.93 - 08.97	X20XEV DOHC	4		BKR5EK	7956	23	LPG 1
Calibra 2.0 16V		2.0	110	02.90 - 08.92	C20XE	4		BKR6EK	2288	20	LPG 1
Calibra 2.0 16V		2.0	110	06.90 - 04.97	C20XE-LN DOHC	4		BKR6EK	2288	20	LPG 1
Calibra 2.0 16V		2.0	110	09.92 - 02.94	C20XE	4		BKR5EK	7956	23	LPG 1
Calibra 2.0 Turbo		2.0	150	03.92 - 08.97	C20LET DOHC	4	1,1	ZFR6F-11	4291		LPG 6
Calibra 2.5 V6		2.5	125	09.93 - 08.97	C25XE DOHC	6		BKR5EK	7956	23	LPG 1
Calibra 2.5 V6		2.5	125	09.93 - 08.97	X25XE DOHC	6		BKR5EK	7956	23	LPG 1

**CAMPO**

Campo 2.3		2.3	72	08.94 - 08.95	4ZD1	4	0,8	BPR6ES	7822	2	LPG 2
Campo 2.5 TD		2.5	56	07.94 -	4JA1T (25 DT)	4	█	Y-904M1	7995		
Campo 3.1 TD		3.1	80	09.92 -	4JG2T (31 TD/TDS)	4	█	Y-719RS1	6900		

**CASCADA**

Cascada 1.4		1.4	88	03.13 -	A14NEL	4	0,7	IFR7X7G	91039		
Cascada 1.4 Turbo		1.4	103	03.13 -	A14NET	4	0,7	IFR7X7G	91039		

**COMBO**

Combo 1.3 CDTI		1.3	51	10.04 -	Y13DT	4	█	Y8003J	97256	62	
Combo 1.3 CDTI		1.3	55	10.05 -	Y13DTJ	4	█	Y8003J	97256	62	
Combo 1.4		1.4	44	03.93 - 10.01	C14NZ OHC	4		BKR5EK	7956	23	LPG 1
Combo 1.4		1.4	44	02.96 - 10.01	X14SZ OHC	4		BKR5EK	7956	23	LPG 1
Combo 1.4		1.4	60	03.93 - 10.01	C14SE OHC	4		BKR5EK	7956	23	LPG 1
Combo 1.4		1.4	66	10.04 -	Z14XEP	4	0,7	ZFR5F	5165		LPG 6
Combo 1.6		1.6	64	10.01 -	Z16SE	4		BKR5EK	7956	23	LPG 1
Combo 1.6 CNG		1.6	69	05 -	Y16YNG	4		LPG 1	1496		LPG 1
Combo 1.6 CNG		1.6	71	08.05 -	Z16YNG	4		LPG 1	1496		LPG 1
Combo 1.7 D		1.7	44	07.94 - 10.01	17D 4EE1 OHC	4	█	Y-603J	8838	60	
Combo 1.7 D		1.7	44	04.96 - 10.01	X17D (4EE1)/OHC	4	█	Y-603J	8838	60	

Fgst = Chassis No.

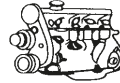
Code *l* kW

Cyl.

Stock-No.  
**VEFINE****LPG/CNG****OPEL****COMBO**

Combo 1.7 DI 16V		1.7	48	10.01 -	Y17DTL	4	▣	Y-541J	1983	42	
Combo 1.7 DTI 16V		1.7	55	10.01 -	Y17DT	4	▣	Y-541J	1983	42	
Combo 1.7 CDTI 16V		1.7	74	12.04 -	Z17DTH	4	▣	Y-541J	1983	42	

**CORSA A**

Corsa A 1.0		1.0	33	09.82 - 09.92	10S OHV	4	0,7	BPR6HS	7022	3	BPR7HIX
Corsa A 1.2		1.2	33	02.90 - 03.93	12NV OHC I	4	0,8	BPR6ES	7822	2	LPG 2
Corsa A 1.2		1.2	33	09.90 - 03.93	C12NZ OHC I	4	0,9	BPR5ES	7422	6	LPG 2
Corsa A 1.2		1.2	37	09.82 - 03.93	12S OHC	4	0,8	BPR6ES	7822	2	LPG 2
Corsa A 1.2		1.2	37	09.86 - 03.93	A12ST OHC	4	0,8	BPR6ES	7822	2	LPG 2
Corsa A 1.2		1.2	40	09.84 - 03.93	S12ST OHC	4	0,8	BPR6ES	7822	2	LPG 2
Corsa A 1.3		1.3	51	09.82 - 03.93	13S OHC	4	0,8	BPR6ES	7822	2	LPG 2
Corsa A 1.3 Sprint		1.3	61	04.85 - 03.93	13E irmscher	4	0,8	BPR6ES	7822	2	LPG 2
Corsa A 1.4		1.4	44	10.89 - 03.93	C14NZ OHC	4	0,9	BPR5ES	7422	6	LPG 2
Corsa A 1.4		1.4	53	10.89 - 09.92	14NV OHC I	4	0,8	BPR6ES	7822	2	LPG 2
Corsa A 1.4		1.4	60	09.91 - 03.93	C14SE OHC	4	0,9	BPR5ES	7422	6	LPG 2
Corsa A 1.5 D (Isuzu-Motor)		1.5	37	09.87 - 03.93	15 D/4 EC1 AAD —> Motor 804 794	4	▣	Y-306R	6244		
Corsa A 1.5 D (Isuzu-Motor)		1.5	37	09.87 - 03.93	15 D/4 EC1 AAD Motor 804795 —>	4	▣	Y-710J	7880		
Corsa A 1.5 TD (Isuzu-Motor)		1.5	49	02.88 - 03.93	15DT/T4 EC1-AADT OHC 804795—>	4	▣	Y-711J	4467	28	
Corsa A 1.6		1.6	55	03.88 - 09.91	C16NZ	4	0,9	BPR5ES	7422	6	LPG 2
Corsa A 1.6		1.6	74	03.88 - 03.92	E16SE OHC I	4	0,8	BPR6ES	7822	2	LPG 2
Corsa A 1.6		1.6	74	02.92 - 03.93	C16SE DOHC	4	0,9	BPR5ES	7422	6	LPG 2
Corsa A 1.6 Irmscher		1.6	72	06.90 - 03.92	C16SEI irmscher	4	0,8	BPR6ES	7822	2	LPG 2

**CORSA B**

Corsa B 1.0 12V		1.0	40	03.97 - 08.00	X10XE DOHC	3		BKR5EK	7956	23	LPG 1
Corsa B 1.2		1.2	33	03.93 - 07.95	12NZ	4	0,9	BPR5ES	7422	6	LPG 2
Corsa B 1.2		1.2	33	03.93 - 07.95	C12NZ OHC I	4	0,9	BPR5ES	7422	6	LPG 2
Corsa B 1.2		1.2	33	03.93 - 07.95	X12SZ OHC	4	0,9	BPR5ES	7422	6	LPG 2
Corsa B 1.2		1.2	33	08.95 - 12.97	12NZ	4		BKR5EK	7956	23	LPG 1
Corsa B 1.2		1.2	33	08.95 - 09.00	C12NZ OHC I	4		BKR5EK	7956	23	LPG 1
Corsa B 1.2		1.2	33	08.95 - 09.00	X12SZ OHC	4		BKR5EK	7956	23	LPG 1
Corsa B 1.2 16V		1.2	48	09.97 - 08.01	X12XE	4		BKR5EK	7956	23	LPG 1
Corsa B 1.4		1.4	44	03.93 - 07.95	C14NZ OHC	4	0,9	BPR5ES	7422	6	LPG 2
Corsa B 1.4		1.4	44	08.95 - 08.98	C14NZ OHC	4		BKR5EK	7956	23	LPG 1
Corsa B 1.4		1.4	44	03.96 - 07.00	X14SZ	4		BKR5EK	7956	23	LPG 1
Corsa B 1.4		1.4	60	03.93 - 07.95	C14SE OHC	4	0,9	BPR5ES	7422	6	LPG 2
Corsa B 1.4		1.4	60	08.95 - 07.97	C14SE OHC	4		BKR5EK	7956	23	LPG 1
Corsa B 1.4		1.4	63	06.98 - 10.00	C14SEL OHC	4		BKR5EK	7956	23	LPG 1
Corsa B 1.4 16V		1.4	66	11.94 - 08.00	X14XE DOHC	4		BKR5EK	7956	23	LPG 1
Corsa B 1.4 16V		1.6	78	08.94 - 08.01	X16XE DOHC	4		BKR5EK	7956	23	LPG 1
Corsa B 1.5 D		1.5	37	03.93 - 08.00	15D (4EC1) OHC Isuzu	4	▣	Y-603J	8838	60	
Corsa B 1.5 D		1.5	49	04.96 - 08.01	X15DT 4EE1 OHC	4	▣	Y-603J	8838	60	
Corsa B 1.5 TD		1.5	49	03.93 - 08.00	X/15DT (T4EC1) OHC Isuzu	4	▣	Y-603J	8838	60	
Corsa B 1.6		1.6	74	06.98 - 10.00	C16SEL DOHC	4		BKR5EK	7956	23	LPG 1
Corsa B 1.6		1.6	80	03.93 - 08.94	C16XE DOHC I	4		BKR5EK	7956	23	LPG 1
Corsa B 1.7 D		1.7	44	04.96 - 08.01	X17D (4EE1)/OHC	4	▣	Y-603J	8838	60	
Corsa B 1.7 TD		1.7	44	03.93 - 08.00	17D (4EE1)/OHC	4	▣	Y-603J	8838	60	

Code *l* kW

Cyl.



Stock-No.

VLINE

10-15-20-25-30-35-40-45-50-55-60-65-70-75-80-85-90-95-100-105-110-115-120-125-130-135-140-145-150-155-160-165-170-175-180-185-190-195-200-205-210-215-220-225-230-235-240-245-250-255-260-265-270-275-280-285-290-295-300-305-310-315-320-325-330-335-340-345-350-355-360-365-370-375-380-385-390-395-400-405-410-415-420-425-430-435-440-445-450-455-460-465-470-475-480-485-490-495-500-505-510-515-520-525-530-535-540-545-550-555-560-565-570-575-580-585-590-595-600-605-610-615-620-625-630-635-640-645-650-655-660-665-670-675-680-685-690-695-700-705-710-715-720-725-730-735-740-745-750-755-760-765-770-775-780-785-790-795-800-805-810-815-820-825-830-835-840-845-850-855-860-865-870-875-880-885-890-895-900-905-910-915-920-925-930-935-940-945-950-955-960-965-970-975-980-985-990-995-1000

LPG/CNG

**OPEL  
CORSA C**

Corso C 1.0 12V		1.0	43	08.00 -	Z10XE	3		BKR5EK	7956	23	LPG 1
Corso C 1.0 12V		1.0	44	06.03 -	Z10XEP	3	1,1	ZFR5F-11	2262		LPG 6
Corso C 1.2		1.2	55	08.00 -	Z12XE	4		BKR5EK	7956	23	LPG 1
Corso C 1.2		1.2	59	07.04 -	Z12XEP	4	1,1	ZFR5F-11	2262		LPG 6
Corso C 1.3 CDTI		1.3	51	06.03 -	Z13DT	4	☑	Y8003J	97256	62	
Corso C 1.4		1.4	66	08.00 -	Z14XE	4		BKR5EK	7956	23	LPG 1
Corso C 1.4		1.4	66	06.03 -	Z14XEP	4	1,1	ZFR5F-11	2262		LPG 6
Corso C 1.6		1.6	62	08.00 -	Z16SE	4		BKR5EK	7956	23	LPG 1
Corso C 1.6 CNG		1.6	71	04 -	Y16YNG	4		LPG 1	1496		LPG 1
Corso C 1.7 CDTI		1.7	74	06.03 -	Z17DTH	4	☑	Y-541J	1983	42	
Corso C 1.7 DI 16V		1.7	48	08.00 -	Y17DTL	4	☑	Y-541J	1983	42	
Corso C 1.7 DTI 16V		1.7	55	08.00 -	Y17DT	4	☑	Y-541J	1983	42	
Corso C 1.8		1.8	92	08.00 -	Z18XE	4		BKR5EK	7956	23	LPG 1

**CORSA D**

Corso D 1.0		1.0	48	01.10 -	A10XEP	3	0,9	ZFR6V-G	8894		ZFR6V-G
Corso D 1.012V		1.0	44	07.06 -	Z10XEP	3	1,1	ZFR5F-11	2262		LPG 6
Corso D 1.2		1.2	59	07.06 -	Z12XEP	4	1,1	ZFR5F-11	2262		LPG 6
Corso D 1.2		1.3	51	06.10 -	A12XEL	4	0,9	ZFR6V-G	8894		ZFR6V-G
Corso D 1.2		1.3	63	06.10 -	A12XER	4	0,9	ZFR6V-G	8894		ZFR6V-G
Corso D 1.3 CDTI		1.3	66	07.05 -	Z13XDTH	4	☑	Y8003J	97256	62	
Corso D 1.3 DTI 16V		1.3	55	07.06 -	Z13DTJ	4	☑	Y8003J	97256	62	
Corso D 1.4		1.4	64	01.10 -	A14XEL	4	0,9	ZFR6V-G	8894		ZFR6V-G
Corso D 1.4		1.4	66	07.06 -	Z14XEP	4	1,1	ZFR5F-11	2262		LPG 6
Corso D 1.4		1.4	74	01.10 -	A14XER	4	0,9	ZFR6V-G	8894		ZFR6V-G
Corso D 1.6 GSI		1.6	110	05.07 -	Z16LEL	4	0,9	ZFR6BP-G	1748		ZFR6BP-G
Corso D 1.6 Turbo		1.6	110	02.07 -	Z16LEL	4	0,9	ZFR6BP-G	1748		ZFR6BP-G
Corso D 1.6 Turbo		1.6	141	11.06 -	A16LER	4	0,9	ZFR6BP-G	1748		ZFR6BP-G
Corso D 1.6 Turbo		1.6	141	11.06 -	Z16LER	4	0,9	ZFR6BP-G	1748		ZFR6BP-G
Corso D 1.6 Turbo		1.6	155	06.11 -	A16LES	4	0,9	ZFR6BP-G	1748		ZFR6BP-G
Corso D 1.7 CDTI		1.7	92	07.06 -	Z17DTR	4	☑	Y-541J	1983	42	

**FRONTERA A**

Frontera A 2.0		2.0	85	09.91 - 08.95	C20NE OHC II	4		BKR5EK	7956	23	LPG 1
Frontera A 2.0		2.0	85	02.95 - 06.98	X20SE OHC II	4		BKR5EK	7956	23	LPG 1
Frontera A 2.0		2.0	85	02.95 -	X20XE OHC	4		BKR5EK	7956	23	LPG 1
Frontera A 2.2 16V		2.2	100	02.95 - 06.98	X22XE DOHC	4		BKR5EK	7956	23	LPG 1
Frontera A 2,3 TD Intercooler		2.3	74	09.91 - 02.95	Z3 DTR OHC	4	☑	Y-924U	4950	1	
Frontera A 2,3 TD Intercooler		2.3	74	03.92 - 09.95	DTR OHC	4	☑	Y-924U	4950	1	
Frontera A 2.4		2.4	92	09.91 - 02.95	C24NE CIH	4	0,7	BPR6HS	7022	3	BPR7HIX
Frontera A 2.5 TDS		2.5	85	06.96 - 08.98	25TD VM41B (25TDS)	4	☑	Y-741U	6943	20	
Frontera A 2.5 TDS		2.5	85	09.96 - 10.98	25TD/TDS/OHC	4	☑	Y-741U	6943	20	
Frontera A 2.8 TD		2.8	83	02.95 - 11.98	28TD 4JB1T (28TDI)	4	☑	Y-904M1	7995		
					Isuzu						

**FRONTERA B**

Frontera B 2.2 16V		2.2	100	10.98 - 12.00	X22SE	4		BKR5EK	7956	23	LPG 1
Frontera B 2.2 16V		2.2	100	10.98 -	X22XE DOHC	4		BKR5EK	7956	23	LPG 1
Frontera B 2.2 DTI 16V		2.2	85	10.98 - 09.02	X22DTH	4	☑	Y-748U	6649	14	
Frontera B 2.2 DTI 16V		2.2	85	10.98 - 09.02	Y22DTH	4	☑	Y-523J	6298	37	
Frontera B 3.2 V6		3.2	151	08.98 -	Y32NE 6VD1	6	1,1	PFR5G-11	2647		PFR6G-11

**GT**

GT Turbo		2.0	194	11.07 - 01.10	Z20LNF / Z20NHH	4	0,9	ILTR5D	5476		ILTR5D
----------	--	-----	-----	---------------	-----------------	---	-----	--------	------	--	--------

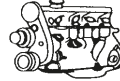
Code *l* kW

Cyl.



Stock-No.

V-TIME  
E-FORWARD  
LPG/CNG**OPEL****INSIGNIA**

Insignia 1.4 Turbo		1.4	103	08.11 -	A14NET	4	0,7	IFR7X7G	91039		IFR7X7G
Insignia 1.6		1.6	85	07.08 -	A16XER	4	1,1	ZFR5F-11	2262		LPG 6
Insignia 1.6 Turbo		1.6	132	07.08 -	A16LET	4	0,9	ZFR6BP-G	1748		ZFR6BP-G
Insignia 1.8		1.8	103	07.08 -	A18XER	4	1,1	ZFR5F-11	2262		LPG 6
Insignia 2.0 Turbo		2.0	162	07.08 -	A20NHT	4	0,9	ILTR5D	5476		
Insignia 2.0 Turbo E85		2.0	162	09.10 -	A20NHT	4	0,9	ILTR5D	5476		
Insignia 2.0 Turbo 4x4		2.0	184	07.11 -	A20NFT	4	0,9	ILTR5D	5476		
Insignia 2.8 V6 Turbo 4x4		2.8	191	07.08 -	A28NET	6	1,0	DILFR7B10G	97218		DILFR7B10G
Insignia 2.8 V6 Turbo 4x4 OPC		2.8	239	07.09 -	A28NER	6	1,0	DILFR7B10G	97218		DILFR7B10G

**MERIVA A**

Meriva A 1.3 CDTI		1.3	55	09.03 -	Z13DTJ	4	█	Y8003J	97256	62	
Meriva A 1.4		1.4	66	06.05 -	Z14XEP	4	1,1	ZFR5F-11	2262		LPG 6
Meriva A 1.6		1.6	64	05.03 -	Z16SE	4		BKR5EK	7956	23	LPG 1
Meriva A 1.6		1.6	74	05.03 -	Z16XE	4		BKR5EK	7956	23	LPG 1
Meriva A 1.6		1.6	77	01.06 -	Z16XEP	4	1,1	ZFR5F-11	2262		LPG 6
Meriva A 1.6 Turbo OPC		1.6	132	08.05 -	Z16LET	4	0,9	ZFR6BP-G	1748		ZFR6BP-G
Meriva A 1.7 CDTI		1.7	74	09.03 -	Z17DTH	4	█	Y-541J	1983	42	
Meriva A 1.7 CDTI		1.7	92	09.06 -	Z17DTR	4	█	Y-541J	1983	42	
Meriva A 1.7 CDTI		1.7	92	01.08 -	A17DTR	4	█	Y-541J	1983	42	
Meriva A 1.7 DTI		1.7	55	09.03 -	Y17DT	4	█	Y-541J	1983	42	
Meriva A 1.8		1.8	92	05.03 -	Z18XE	4		BKR5EK	7956	23	LPG 1

**MERIVA B**

Meriva B 1.3 CDTI nur für Zylinder ohne Drucksensor		1.3	55	06.10 -	A13DTC	4	█	Y9004AS	90860		
Meriva B 1.3 CDTI nur für Zylinder ohne Drucksensor		1.3	70	03.10 -	A13DTE	4	█	Y9004AS	90860		
Meriva B 1.4		1.4	74	03.10 -	A14XER	4	0,9	ZFR6V-G	8894		
Meriva B 1.4		1.4	88	03.10 -	A14NEL	4	0,7	IFR7X7G	91039		
Meriva B 1.4 LPG		1.4	88	06.11 -	A14NEL	4	0,7	IFR7X7G	91039		
Meriva B 1.4		1.4	103	03.10 -	A14NET	4	0,7	IFR7X7G	91039		
Meriva B 1.7 CDTI		1.7	74	03.10 -	A17DT	4	█	Y-541J	1983	42	

**MOKKA**

Mokka 1.4		1.4	103	06.12 -	A14NET	4	0,7	IFR7X7G	91039		
Mokka 1.6		1.6	85	06.12 -	A16XER	4	0,9	ZFR6V-G	8894		
Mokka 1.8		1.8	103	01.13 -	A18XER	4	0,9	ZFR6V-G	8894		

**MONTEREY A**

Monterey A 3.1 TD		3.1	84	11.91 - 02.98	4JG2-TC (3.1 D)	4	█	Y-719RS1	6900		
Monterey A 3.2 V6 24V		3.2	130	04.92 - 12.98	6VDI SOHC	6	0,9	BKR6E	6962	28	LPG 1

**MONTEREY B**

Monterey B 3.0 DTI		3.0	117	02.98 - 10.99	4JX1 (3.0 DTI)	4	█	Y1038J	94542		
Monterey B 3.5 V6 24V		3.5	158	02.98 - 07.99	6VE1	6	1,1	BKR5EIX-11	5464		LPG 1

**MOVANO**

Movano 1.9 DTI		1.9	59	09.00 -	F9Q M7	4	█	Y-732J	5605	4	
Movano 2.2 DTI		2.2	66	09.00 -	G9T C7	4	█	Y-517J	3319	66	
Movano 2.5 CDTi		2.5	74	08.06 -	G9U 650	4	█	Y-517J	3319	66	
Movano 2.5 CDTi		2.5	88	08.06 -	G9U 650	4	█	Y-517J	3319	66	
Movano 2.5 CDTi		2.5	107	08.06 -	G9U 650	4	█	Y-517J	3319	66	
Movano 2.5 D		2.5	59	10.98 - 10.00	S8U W7	4	█	Y-910J	3617	3	
Movano 2.5 DTi		2.5	73	10.03 -	G9U 754	4	█	Y-517J	3319	66	

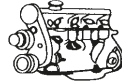

Code *l* kW

Cyl.



Stock-No.



LPG/CNG

**OPEL  
MOVANO**

Movano 2.5 DTi		2.5	84	10.01 -	G9U 720 / 724	4		Y-517J	3319	66	
----------------	--	-----	----	---------	---------------	---	--	--------	------	----	--

**OMEGA A**

Omega A 1.8 N		1.8	60	09.86 - 03.94	18NV OHC II	4	0,8	BPR6ES	7822	2	LPG 2
Omega A 1.8 N		1.8	62	09.86 - 03.94	S18NV OHC II	4	0,8	BPR6ES	7822	2	LPG 2
Omega A 1.8		1.8	85	09.86 - 09.92	18SEH OHC II	4	0,8	BPR6ES	7822	2	LPG 2
Omega A 2.0		2.0	74	09.86 - 03.94	20NE	4	0,9	BPR5ES	7422	6	LPG 2
Omega A 2.0		2.0	74	09.86 - 03.94	20NEJ	4		BKR6EK	2288	20	LPG 1
Omega A 2.0		2.0	74	04.90 - 02.92	C20NEJ OHC	4		BKR6EK	2288	20	LPG 1
Omega A 2.0 i		2.0	85	09.86 - 03.94	C20NE OHC	4	0,9	BPR5ES	7422	6	LPG 2
Omega A 2.0		2.0	90	09.89 - 03.94	20SE OHC II	4		BKR6EK	2288	20	LPG 1
Omega A 2.3 D		2.3	54	09.86 - 02.94	23 YD OHC	4		Y-924U	4950	1	
Omega A 2.3 TD		2.3	74	09.88 - 02.94	23 DTR OHC	4		Y-924U	4950	1	
Omega A 2.4 i		2.4	92	09.88 - 03.94	C24NE CIH	6	0,7	BPR6HS	7022	3	BPR7HIX
Omega A 2.6 i		2.6	110	09.90 - 03.94	C26NE CIH	6	0,7	BPR6HS	7022	3	BPR7HIX
Omega A 3.0 3000		3.0	115	03.87 - 03.94	C30NE CIH	6	0,7	BPR6HS	7022	3	BPR7HIX
Omega A 3.0 3000		3.0	130	03.87 - 03.94	C30NE CIH	6	0,7	BPR6HS	7022	3	BPR7HIX
Omega A 3.0 24V 3000		3.0	147	09.89 - 03.94	C30SE	6		BKR6EK	2288	20	LPG 1
Omega A 3.0 24V 3000		3.0	147	09.90 - 03.94	C30SEJ DOHC	6		BKR6EK	2288	20	LPG 1
Omega A 3.0 24V Evo 500		3.0	170	03.91 - 09.92	C30XEI DOHC	6		BKR6EK	2288	20	LPG 1

**OMEGA B**

Omega B 2.0 DTI 16V		2.0	74	09.99 -	Y20DTH	4		Y-523J	6298	37	
Omega B 2.0 DTI 16V		2.0	74	10.98 - 09.00	X20DTH OHC	4		Y-748U	6649	14	
Omega B 2.0 DTI 16V		2.0	74	09.97 -	X20DILC	4		Y-748U	6649	14	
Omega B 2.0		2.0	85	01.94 - 09.99	20SE OHC	4		BKR5EK	7956	23	LPG 1
Omega B 2.0		2.0	85	01.94 - 09.00	X20SE OHC	4		BKR5EK	7956	23	LPG 1
Omega B 2.0 16V		2.0	100	01.94 - 09.00	X20XEV DOHC	4		BKR5EK	7956	23	LPG 1
Omega B 2.2 DTI 16V		2.2	88	08.01 -	Y22DTH	4		Y-523J	6298	37	
Omega B 2.2 DTI 16V		2.2	88	05.01 -	Y22DTR	4		Y-523J	6298	37	
Omega B 2.2 16V		2.2	106	09.99 - 09.00	Y22XE	4		BKR5EK	7956	23	LPG 1
Omega B 2.2 16V		2.2	108	08.00 -	Z22XE	4		BKR5EK	7956	23	LPG 1
Omega B 2.5 TD		2.5	96	02.94 - 02.96	U25TD (Mot. BMW)	6		Y-924J	7906	1	
Omega B 2.5 TD		2.5	96	08.96 - 10.01	X25DT OHC	6		Y-924J	7906	1	
Omega B 2.5 V6		2.5	125	01.94 - 09.00	X25XE DOHC	6		BKR5EK	7956	23	LPG 1
Omega B 2.6 V6		2.6	132	08.00 - 07.03	Y26SE	6		BKR5EQUA	3566		
Omega B 3.0 V6 24V		3.0	155	09.94 - 10.01	X30XE DOHC	6		BKR5EK	7956	23	LPG 1
Omega B 3.2 V6		3.2	160	05.01 - 07.03	Y32SE	6		BKR5EQUA	3566		

**SENATOR B**

Senator B 2.6 i		2.6	110	09.90 - 09.93	C26NE CIH	6	0,7	BPR6HS	7022	3	BPR7HIX
Senator B 3.0		3.0	150	09.89 - 06.93	C30SE DOHC	6		BKR6EK	2288	20	LPG 1
Senator B 3.6		3.6	145	08.89 - 09.93	C3,6NE irmscher	6	0,7	BPR6HS	7022	3	BPR7HIX
Senator B 3.6		3.6	145	08.89 - 09.93	C3,6NEI irmscher	6	0,7	BPR6HS	7022	3	BPR7HIX
Senator B 4.0 Irmischer		4.0	200	01.91 - 09.93	C40SE irmscher	6	0,7	BPR6HS	7022	3	BPR7HIX

**SIGNUM**

Signum 1.6		1.6	74	03 -	Z16XE DOHC	4		BKR5EQUA	3566		
Signum 1.8		1.8	85	05.03 -	Z18XEL	4		BKR5EQUA	3566		
Signum 1.8		1.8	103	09.05 - 03.07	Z18XER	4	1,1	ZFR5F-11	2262		LPG 6
Signum 1.8		1.8	90	05.03 - 07.05	Z18XE	4		BKR5EQUA	3566		
Signum 1.9 CDTI bis Fgst.-Nr. 71021891		1.9	74	08.05 - 02.08	Z19DTL	4		Y-534J	3413	36	
Signum 1.9 CDTI ab Fgst.-Nr. 71021892		1.9	74	08.05 - 02.08	Z19DTL	4		Y1030J	90828	70	
Signum 1.9 CDTI bis Fgst.-Nr. 71021891		1.9	88	04.04 - 10.08	Z19DT	4		Y-534J	3413	36	

Fgst = Chassis No.

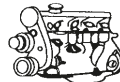
Code *l* kW

Cyl.



Stock-No.

V-TUNE

E-FORWARD

LPG/CNG

**OPEL****SIGNUM**

Signum 1.9 CDTI ab Fgst.-Nr. 71021892	1.9	88	04.04 - 10.08	Z19DT	4	☑	Y1030J	90828	70	
Signum 1.9 CDTI 16V	1.9	110	04.04 - 02.08	Z19DTH	4	☑	YE07	6092		
Signum 2.0 DTI 16V	2.0	74	05.03 - 04.04	Y20DTH	4	☑	Y-523J	6298	37	
Signum 2.0 Turbo	2.0	129	05.03 - 12.08	Z20NET	4		PFR6T-10G	5542		PFR6T-10G
Signum 2.2 DTI 16V	2.2	92	05.03 - 04.04	Y22DTR	4	☑	Y-523J	6298	37	
Signum 2.2	2.2	108	05.03 -	Z22SE	4		LTR6B-10T	5948		LTR6B-10T
Signum 2.2 direct	2.2	114	05.03 - 09.08	Z22YH	4		BKR5EQUA	3566		
Signum 2.8 V6 Turbo	2.8	169	09.05 - 12.08	Z28NEL	6	1,0	PLFR6C-10G	1959		PLFR6C-10G
Signum 2.8 V6 Turbo	2.8	184	01.06 - 12.08	Z28NET	6	1,0	DILFR7B10G	97218		DILFR7B10G
Signum 3.2 V6	3.2	155	05.03 - 07.05	Z32SE	6		BKR5EQUA	3566		

**SINTRA**

Sintra 2.2 16V	2.2	104	09.96 - 09.99	X22XE DOHC	4		BKR5EK	7956	23	LPG 1
Sintra 3.0 V6 24V	3.0	155	09.96 - 09.99	X30XE DOHC	6		BKR5EK	7956	23	LPG 1
Sintra 2.2 DTI	2.2	85	01.98 -	X22DTH	4	☑	Y-748U	6649	14	

**SPEEDSTER**

Speedster	2.2	108	04.00 - 06	Z22SE	4		LTR6B-10T	5948		LTR6B-10T
Speedster Turbo	2.0	147	03 -	Z20LET	4		BKR5EK	7956	23	LPG 1

**TIGRA A**

Tigra A 1.4 16V	1.4	63	08.97 - 12.00	C14SEL OHC	4		BKR5EK	7956	23	LPG 1
Tigra A 1.4 16V	1.4	66	08.94 - 12.00	X14XE DOHC	4		BKR5EK	7956	23	LPG 1
Tigra A 1.6 16V	1.6	74	06.97 - 08.98	C16SEL DOHC	4		BKR5EK	7956	23	LPG 1
Tigra A 1.6 16V	1.6	78	08.94 - 08.98	X16XE DOHC	4		BKR5EK	7956	23	LPG 1

**TIGRA B**

Tigra B 1.3 CDTI	1.3	52	06.04 -	Z13DT	4	☑	Y8003J	97256	62	
Tigra B 1.4	1.4	66	06.04 -	Z14XEP	4	1,1	ZFR5F-11	2262		LPG 6
Tigra B 1.8	1.8	92	06.04 -	Z18XE	4	1,1	ZFR5F-11	2262		LPG 6

**VECTRA A**

Vectra A 1.4	1.4	55	09.88 - 09.92	14NV OHC I	4	0,8	BPR6ES	7822	2	LPG 2
Vectra A 1.6	1.6	52	09.93 - 08.95	X16SZ OHC	4		BKR5EK	7956	23	LPG 1
Vectra A 1.6	1.6	55	09.88 - 08.94	C16NZ	4	0,9	BPR5ES	7422	6	LPG 2
Vectra A 1.6	1.6	60	09.88 - 09.92	16SV OHC I	4	0,8	BPR6ES	7822	2	LPG 2
Vectra A 1.7 D	1.7	42	02.88 - 09.92	17D OHC II	4	☑	Y-924U	4950	1	
Vectra A 1.7 TD	1.7	60	03.90 -	Isuzu TC4EC1	4	☑	Y-743U	5642		
				817253→						
Vectra A 1.7 TD	1.7	60	10.92 - 08.95	17DT Isuzu TC4EE1	4	☑	Y-603J	8838	60	
Vectra A 1.7 TD	1.7	60	10.92 - 08.95	X17DT Isuzu TC4EE1	4	☑	Y-603J	8838	60	
Vectra A 1.8 S	1.8	65	09.88 - 08.95	E18NVR OHC II	4	0,8	BPR6ES	7822	2	LPG 2
Vectra A 1.8 S 4x4	1.8	65	01.89 - 08.95	E18NVR OHC II	4	0,8	BPR6ES	7822	2	LPG 2
Vectra A 1.8 i	1.8	66	09.89 - 08.95	18SV	4	0,8	BPR6ES	7822	2	LPG 2
Vectra A 1.8 i	1.8	66	09.89 - 08.95	C18SV OHC	4	0,8	BPR6ES	7822	2	LPG 2
Vectra A 1.8 i	1.8	66	03.90 - 08.95	C18NZ OHC II	4		BKR5EK	7956	23	LPG 1
Vectra A 1.8 i 4x4	1.8	66	09.89 - 08.95	18SV	4	0,8	BPR6ES	7822	2	LPG 2
Vectra A 1.8 i 4x4	1.8	66	09.89 - 08.95	C18SV OHC	4	0,8	BPR6ES	7822	2	LPG 2
Vectra A 2.0 i	2.0	85	09.89 - 08.95	20NE	4		BKR5EK	7956	23	LPG 1
Vectra A 2.0 i	2.0	85	09.89 - 08.95	C20NE OHC	4		BKR5EK	7956	23	LPG 1
Vectra A 2.0 i 4x4	2.0	85	01.89 - 08.95	20NE	4		BKR5EK	7956	23	LPG 1
Vectra A 2.0 i 4x4	2.0	85	01.89 - 08.95	C20NE OHC	4		BKR5EK	7956	23	LPG 1
Vectra A 2.0 i	2.0	95	09.88 - 09.92	20SEH OHC II	4	0,8	BPR6ES	7822	2	LPG 2

Fgst = Chassis No.

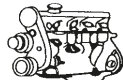
Code *l* kW

Cyl.



Stock-No.



LPG/CNG

**OPEL  
VECTRA A**

Vectra A 2.0 i 4x4		2.0	95	01.89 - 09.92	20SEH OHC II	4	0,8	BPR6ES	7822	2	LPG 2
Vectra A 2.0 i 16V		2.0	100	08.92 - 08.95	20XE	4		BKR5EK	7956	23	LPG 1
Vectra A 2.0 i 16V		2.0	100	08.92 - 08.95	C20XE	4		BKR5EK	7956	23	LPG 1
Vectra A 2.0 i 16V		2.0	100	08.92 - 08.95	C20XE-LN	4		BKR5EK	7956	23	LPG 1
Vectra A 2.0 i 16V		2.0	100	12.94 - 08.95	X20XEV DOHC	4		BKR5EK	7956	23	LPG 1
Vectra A 2.0 2000 16V		2.0	110	09.89 - 08.92	20XE	4		BKR6EK	2288	20	LPG 1
Vectra A 2.0 2000 16V		2.0	110	09.89 - 08.92	C20XE DOHC	4		BKR6EK	2288	20	LPG 1
Vectra A 2.0 2000 16V 4x4		2.0	110	09.89 - 08.92	20XE	4		BKR6EK	2288	20	LPG 1
Vectra A 2.0 2000 16V 4x4		2.0	110	09.89 - 08.92	C20XE DOHC	4		BKR6EK	2288	20	LPG 1
Vectra A 2.0 i Turbo 4x4		2.0	150	09.92 - 08.95	C20LET DOHC	4	1,1	ZFR6F-11	4291		LPG 6
Vectra A 2.5 V6		2.5	125	02.93 - 08.95	25XE	6		BKR5EK	7956	23	LPG 1
Vectra A 2.5 V6		2.5	125	03.93 - 08.95	C25XE DOHC	6		BKR5EK	7956	23	LPG 1

**VECTRA B**

Vectra B 1.6 i		1.6	55	08.95 -	16LZ2 OHC	4		BKR5EK	7956	23	LPG 1
Vectra B 1.6 i		1.6	55	08.95 - 09.00	X16SZR OHC	4		BKR5EK	7956	23	LPG 1
Vectra B 1.6 i 16V		1.6	74	08.95 - 09.00	X16XEL DOHC	4		BKR5EK	7956	23	LPG 1
Vectra B 1.6 i 16V		1.6	74	08.00 - 04.02	Z16XE DOHC	4		BKR5EK	7956	23	LPG 1
Vectra B 1.7 TD		1.7	60	08.95 - 12.98	X17TD / TC4 EE1 Isuzu	4	☑	Y-603J	8838	60	
Vectra B 1.8 i 16V		1.8	85	08.95 - 09.00	X18XE	4		BKR5EK	7956	23	LPG 1
Vectra B 1.8 i 16V		1.8	85	03.99 - 09.00	X18XE1	4		BKR5EK	7956	23	LPG 1
Vectra B 1.8 i 16V		1.8	85	08.00 - 04.02	Z18XEL	4		BKR5EK	7956	23	LPG 1
Vectra B 1.8 i 16V		1.8	92	08.00 - 04.02	Z18XE	4		BKR5EK	7956	23	LPG 1
Vectra B 2.0 Di		2.0	60	08.96 - 07.99	X20DTL SOHC	4	☑	Y-604J	6157		
Vectra B 2.0 Di		2.0	60	08.99 - 04.02	X20DTL SOHC	4	☑	Y-748U	6649	14	
Vectra B 2.0 DTI 16V		2.0	74	08.97 - 04.02	X20DTH OHC	4	☑	Y-748U	6649	14	
Vectra B 2.0 DTI 16V		2.0	74	09.97 - 07.99	X20DILC	4	☑	Y-748U	6649	14	
Vectra B 2.0 DTI 16V		2.0	74	08.00 - 04.02	Y20DTH	4	☑	Y-523J	6298	37	
Vectra B 2.0		2.0	80	08.95 -	Z0NEJ OHC	4		BKR5EK	7956	23	LPG 1
Vectra B 2.0 i 16V		2.0	100	08.95 - 09.00	X20XEV	4		BKR5EK	7956	23	LPG 1
Vectra B 2.0 i 16V		2.0	100	02.97 -	C20SEL DOHC	4		BKR5EK	7956	23	LPG 1
Vectra B 2.2 DTI 16V		2.2	92	08.00 - 04.02	Y22DTR	4	☑	Y-523J	6298	37	
Vectra B 2.2 i 16V		2.2	106	10.99 -	C22SEL DOHC	4		BKR5EK	7956	23	LPG 1
Vectra B 2.2 i 16V		2.2	108	08.00 - 04.02	Z22SE	4		LTR6B-10T	5948		LTR6B-10T
Vectra B 2.5 i V6		2.5	125	08.95 - 09.00	X25XE DOHC	6		BKR5EK	7956	23	LPG 1
Vectra B 2.5 i V6		2.6	125	08.00 - 07.03	Y26SE	6		BKR5EQUPA	3566		
Vectra B i500		2.5	143	01.98 - 09.00	X25XE DOHC	6		BKR5EK	7956	23	LPG 1

**VECTRA C**

Vectra C 1.6		1.6	74	06.04 - 08.08	Z16XE DOHC	4		BKR5EQUPA	3566		
Vectra C 1.6		1.6	77	01.06 - 08.08	Z16XEP	4	1,1	ZFR5F-11	2262		LPG 6
Vectra C 1.8		1.8	81	04.02 - 07.03	Z18XEL	4		BKR5EQUPA	3566		
Vectra C 1.8		1.8	103	01.06 - 08.08	Z18XER	4	1,1	ZFR5F-11	2262		LPG 6
Vectra C 1.8		1.8	92	08.02 - 09.05	Z18XE	4		BKR5EQUPA	3566		
Vectra C 1.9 CDTI		1.9	74	06.05 - 08.08	Z19DTL	4	☑	Y-534J	3413	36	
bis Fgst.-Nr. 71021891											
Vectra C 1.9 CDTI		1.9	74	06.05 - 08.08	Z19DTL	4	☑	Y1030J	90828	70	
ab Fgst.-Nr. 71021892											
Vectra C 1.9 CDTI		1.9	88	04.04 - 08.08	Z19DT	4	☑	Y-534J	3413	36	
bis Fgst.-Nr. 71021891											
Vectra C 1.9 CDTI		1.9	88	04.04 - 08.08	Z19DT	4	☑	Y1030J	90828	70	
ab Fgst.-Nr. 71021892											

Fgst = Chassis No.

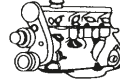
Code *l* kW

Cyl.



Stock-No.



LPG/CNG

**OPEL****VECTRA C**

Vectra C 1.9 CDTI 16V		1.9	110	04.04 - 08.08	Z19DTH	4	☑	YE07	6092		
Vectra C 2.0 DTI 16V		2.0	74	04.02 - 08.05	Y20DTH	4	☑	Y-523J	6298	37	
Vectra C 2.0 16V Turbo		2.0	129	03.03 - 08.08	Z20NET	4		PFR6T-10G	5542		PFR6T-10G
Vectra C 2.2 DTI 16V		2.2	92	04.02 - 07.04	Y22DTR	4	☑	Y-523J	6298	37	
Vectra C 2.2 16V		2.2	108	08.02 - 04.04	Z22SE	4		LTR6B-10T	5948		LTR6B-10T
Vectra C 2.2 direct		2.2	114	10.03 - 08.08	Z22YH	4		BKR5EQUA	3566		
Vectra C 2.8 V6 Turbo		2.8	169	09.05 - 08.08	Z28NEL	6	1,0	PLFR6C-10G	1959		PLFR6C-10G
Vectra C 2.8 V6 Turbo		2.8	184	08.06 - 08.08	Z28NET	6	1,0	PLFR6C-10G	1959		PLFR6C-10G
Vectra C 2.8 V6 Turbo		2.8	188	08.05 - 08.06	Z28NET	6	1,0	PLFR6C-10G	1959		PLFR6C-10G
Vectra C 3.2 V6		3.2	155	08.02 - 07.05	Z32SE	6		BKR5EQUA	3566		

**VIVARO**

Vivaro 2.0		2.0	86	08.01 -	F4R 820	4	0,9	PFR6G-9	4377		PFR7G
Vivaro 12.0 6V		2.0	88	09.01 -	F4R 720	4	0,9	PFR6G-9	4377		PFR7G
Vivaro 2.5 CDTI		2.5	84	08.06 -	G9U 720 / 730	4	☑	Y-517J	3319	66	
Vivaro 2.5 CDTI		2.5	107	08.06 -	G9U 630	4	☑	Y-517J	3319	66	
Vivaro 1.9 DI		1.9	60	09.01 -		4	☑	Y-732J	5605	4	
Vivaro 1.9 DTI		1.9	74	09.01 -	F9Q 760	4	☑	Y-732J	5605	4	
Vivaro 2.5 DTI		2.5	98	05.03 -	G9U 730	4	☑	Y-517J	3319	66	

**ZAFIRA A**

Zafira A 1.6 16V		1.6	74	03.99 -	X16XE DOHC	4		BKR5EK	7956	23	LPG 1
Zafira A 1.6 16V		1.6	74	08.00 -	Z16XE	4		BKR5EK	7956	23	LPG 1
Zafira A 1.6 CNG		1.6	71	09.01 -	Z16YNG	4		LPG 1	1496		LPG 1
Zafira A 1.8 16V		1.8	85	03.99 - 09.00	X18XE DOHC	4		BKR5EK	7956	23	LPG 1
Zafira A 1.8 16V		1.8	85	04.99 - 09.00	X18XE1	4		BKR5EK	7956	23	LPG 1
Zafira A 1.8 16V		1.8	92	09.00 -	Z18XE	4		BKR5EK	7956	23	LPG 1
Zafira A 2.0 DI		2.0	60	09.99 - 11.00	X20DTL	4	☑	Y-748U	6649	14	
Zafira A 2.0 DTI		2.0	74	04.99 -	X20DILC	4	☑	Y-748U	6649	14	
Zafira A 2.0 DTI		2.0	74	08.99 -	Y20DTL	4	☑	Y-748U	6649	14	
Zafira A 2.0 DTI		2.0	74	08.00 -	Y20DTH	4	☑	Y-523J	6298	37	
Zafira A 2.0 Turbo OPC		2.0	141	01 -	Z20LET	4		BKR5EK	7956	23	LPG 1
Zafira A 2.2		2.2	108	08.00 - 06	Z22SE	4		LTR6B-10T	5948		LTR6B-10T
Zafira A 2.2 DTI		2.2	92	01.02 - 06.05	Y22DTR	4	☑	Y-523J	6298	37	

**ZAFIRA B**

Zafira B 1.6 CNG		1.6	69	05 -	Y16YNG	4		LPG 1	1496		LPG 1
Zafira B 1.6 16V		1.6	77	07.05 -	Z16XEP	4	1,1	ZFR5F-11	2262		LPG 6
Zafira B 1.6 16V		1.6	85	01.08 -	Z16XER	4	1,1	ZFR5F-11	2262		LPG 6
Zafira B 1.6 16V		1.6	85	01.08 -	A16XER	4	0,9	ZFR6V-G	8894		ZFR6V-G
Zafira B 1.7 CDTI		1.7	81	01.08 -	A17DTJ	4	☑	Y-541J	1983	42	
Zafira B 1.7 CDTI		1.7	92	01.08 -	A17DTR	4	☑	Y-541J	1983	42	
Zafira B 1.8 16V		1.8	103	07.05 -	Z18XER	4	1,1	ZFR5F-11	2262		LPG 6
Zafira B 1.9 CDTI		1.9	74	07.05 -	Z19DTL	4	☑	Y-534J	3413	36	
bis Fgst.-Nr. 62999999											
Zafira B 1.9 CDTI		1.9	74	07.05 -	Z19DTL	4	☑	Y1030J	90828	70	
ab Fgst.-Nr. 72000001											
Zafira B 1.9 CDTI		1.9	88	07.05 -	Z19DT	4	☑	Y-534J	3413	36	
bis Fgst.-Nr. 62999999											
Zafira B 1.9 CDTI		1.9	88	07.05 -	Z19DT	4	☑	Y1030J	90828	70	
ab Fgst.-Nr. 72000001											
Zafira B 1.9 CDTI		1.9	110	07.05 -	Z19DTH	4	☑	YE07	6092		
Zafira B 2.0 Turbo		2.0	147	07.05 -	Z20LER	4	0,7	ZFR5F	5165		LPG 6

Fgst = Chassis No.

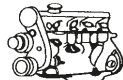
Code *l* kW

Cyl.



Stock-No.



LPG/CNG

**OPEL  
ZAFIRA B**

Zafira B 2.0 Turbo OPC		2.0	177	09.05 -	Z20LEH	4		PFR6T-G	6314		PFR6T-G
Zafira B 2.2 DI		2.2	110	07.05 -	Z22YH	4		BKR5EQUA	3566		

**ZAFIRA TOURER**

Zafira Tourer 1.4		1.4	88	10.11 -	A14NEL	4	0,7	IFR7X7G	91039		IFR7X7G
Zafira Tourer 1.4		1.4	103	10.11 -	A14NET	4	0,7	IFR7X7G	91039		IFR7X7G
Zafira Tourer 1.8		1.8	103	12.11 -	A18XER	4	0,9	ZFR6V-G	8894		ZFR6V-G

**PEUGEOT  
106 1.VERSION**

106 XN		0.9	37	08.91 - 12.92	TU9-C1A	4	0,8	BCP5ES	7496	16	LPG 3
106i XN, XA, Kid		0.9	37	07.92 - 06.95	TU9M-CDZ	4	0,8	BCPR5ES	6130	32	LPG 3
106i XN, XA, Kid		0.9	37	07.95 - 03.96	TU9M-CDZ	4		BKR5EK	7956	23	LPG 1
106 XN, XR		1.1	38	08.91 - 12.92	TU1-H1A	4	0,8	BCP5ES	7496	16	LPG 3
106i XN, XR, XT, Green		1.1	44	07.92 - 06.95	TU1M-HDZ	4	0,8	BCPR5ES	6130	32	LPG 3
106i XN, XR, XT, Green		1.1	44	07.95 - 03.96	TU1M-HDZ	4		BKR6EK	2288	20	LPG 1
106 Rallye		1.3	74	11.93 - 03.96	TU2J2-MFZ	4		BKR6EK	2288	20	LPG 1
106 D		1.4	37	08.91 - 06.94	TUD3/L	4		<input checked="" type="checkbox"/> Y-910J	3617	3	
106 XR, XT		1.4	51	08.91 - 12.92	TU3.2-K2D	4	0,7	BCP6ES	4930	17	LPG 3
106 Xsi		1.4	55	08.91 - 12.92	TU3JP~KFX	4		BKR6EK	2288	20	LPG 1
106 Xsi		1.4	55	07.92 - 03.96	TU3JP cat.~KFX	4		BKR6EK	2288	20	LPG 1
106i XR, XS, XT		1.4	55	07.92 - 06.95	TU3MC~KDX	4	0,8	BCPR5ES	6130	32	LPG 3
106i XR, XS, XT		1.4	55	07.95 - 03.96	TU3MC~KDX	4		BKR6EK	2288	20	LPG 1
106 D		1.5	42	07.94 - 03.96	TUD5	4		<input checked="" type="checkbox"/> Y-503J	1009	10	
106 D		1.5	42	04.96 - 10.03	TUD5	4		<input checked="" type="checkbox"/> Y-503J	1009	10	
106i XS, XT, Griffes		1.6	66	07.94 - 03.96	TU5JP~NFZ	4		BKR6EK	2288	20	LPG 1
106 Xsi		1.6	74	12.93 - 06.95	TU5J2~NFW	4	0,8	BKR6ES	3783	28	LPG 1
106 Xsi		1.6	74	07.95 - 05.96	TU5J2~NFW	4		BKR6EK	2288	20	LPG 1

**106 2.VERSION**

106i		1.0	37	04.96 -	TU9M~CDZ /Y	4		BKR5EK	7956	23	LPG 1
106i		1.1	44	04.96 -	TU1M+ ~HDZ	4		BKR6EK	2288	20	LPG 1
106		1.1	44	05.00 -	TU1JP	4	0,9	BKR6EZ	4619	38	LPG 1
106i		1.4	55	04.96 - 12.99	TU3JP~KFX	4		BKR6EK	2288	20	LPG 1
106i		1.4	55	01.00 -	TU3JP~KFX	4	0,9	BKR6EZ	4619	38	LPG 1
106i		1.6	66	04.96 - 12.99	TU5JP~NFZ	4		BKR6EK	2288	20	LPG 1
106i		1.6	66	01.00 -	TU5JP~NFZ	4	0,9	BKR6EZ	4619	38	LPG 1
106 Rallye		1.6	74	06.96 -	TU5J2~NFW	4		BKR6EK	2288	20	LPG 1
106 S16, Gti		1.6	88	06.96 - 12.99	TU5J4~NFX	4		BKR6EK	2288	20	LPG 1
106 S16, Gti		1.6	88	01.00 -	TU5J4~NFX	4	0,9	BKR6EZ	4619	38	LPG 1

**107**

107 12V		1.0	50	06.05 -		3	1,1	LFR6C-11	5788		
107 Hdi		1.4	51	01.05 -	DV4	4		<input checked="" type="checkbox"/> YE05	91322	73	
107 Hdi		1.4	51	01.05 -	DV4TD	4		<input checked="" type="checkbox"/> YE04	1684	40	

**205**

205 XE, GL, Junior		0.9	33	07.87 - 12.92	TU9	4	0,8	BCP5ES	7496	16	LPG 3
205 XE, GL, Junior		0.9	33	07.92 -	TU9M Cat.	4	0,8	BCPR5ES	6130	32	LPG 3
205 XR, XL, GL, GR		1.1	34	07.87 - 12.92	TU1	4	0,8	BCP5ES	7496	16	LPG 3
205		1.1	44	- 06.92		4	0,8	BCPR6ES	2330	12	LPG 3
205 GR, Color Line		1.1	44	07.92 - 06.95	TU1M Cat.	4	0,8	BCPR5ES	6130	32	LPG 3



Code *l* kW

Cyl.

Stock-No.  
**VEFINE**  
E-FORMER\*

LPG/CNG

**PEUGEOT****205**

205 GR,Color,Sacre Num		1.1	44	03.95 -	TU1.M Cat.	4		BKR6EK	2288	20	LPG 1
205 Rallye		1.3	75	03.88 - 06.92	TU2.4	4		BKUR7ET	7873		PFR7Q
205 XR,GR,SR,CJ		1.4	43	07.87 - 12.92	TU3 , TU3A	4	0,8	BCP5ES	7496	16	LPG 3
205 XR,GR,SR,CJ		1.4	55	07.92 -	TU3FM Cat.	4	0,8	BCPR5ES	6130	32	LPG 3
205 XR,XS		1.4	55	07.92 - 06.95	TU3MC Cat.	4	0,8	BCPR6ES	2330	12	LPG 3
205 XR,GR,SR,SJ,Sacre N°		1.4	55	07.95 -	TU3.MC Cat.	4		BKR6EK	2288	20	LPG 1
205 XT,XS,GT,CT		1.4	62	07.87 - 12.92	TU3S	4	0,7	BCP6ES	4930	17	LPG 3
205 Rallye		1.4		03.88 - 06.92	TU2.4	4		BKUR7ET	7873		PFR7Q
205 XS,GT,Auto		1.6	65	07.92 -	XU5.M Cat.	4	0,8	BCPR5ES	6130	32	LPG 3
205 GTi / CTi		1.6	83	07.87 - 06.92	XU5JA	4	0,7	BCP6ES	4930	17	LPG 3
205 GR,XS,XT,Auto		1.6		07.90 - 12.92	XU5.1C	4	0,7	BCP6ES	4930	17	LPG 3
205 D		1.8	44	10.83 - 08.98	XUD7	4		Y-924J	7906	1	
205 D		1.8	44	09.98 - 12.99	XUD7	4		Y-938R	5267	1	
205 TD		1.8	58	07.85 - 08.98	XUD7T	4		Y-924J	7906	1	
205		1.8	58	09.98 - 12.99	XUD7T	4		Y-938R	5267	1	
205 D		1.9	47	10.87 - 08.98	XUD9	4		Y-924J	7906	1	
205		1.9	51	09.98 - 12.99	XUD9A	4		Y-938R	5267	1	
205 Gentry		1.9	75	07.92 -	XU9.J1 Cat.	4	0,8	BCPR5ES	6130	32	LPG 3
205 GTi		1.9	88	07.92 -	XU9.JA Cat.	4	0,8	BCPR5ES	6130	32	LPG 3
205 GTi / Gentry		1.9	94	- 12.92	XU9.JA	4	0,7	BCP6ES	4930	17	LPG 3

**206**

206		1.1	44	09.98 - 12.99	TU1JP-HFZ,HFY	4		BKR6EK	2288	20	LPG 1
206		1.1	44	01.00 -	TU1JP-HFZ,HFY	4	0,9	BKR6EZ	4619	38	LPG 1
206 & SW		1.4	51	12.04 -	DV4TD	4		YE05	91322	73	
206		1.4	55	09.98 - 12.99	TU3JP-KFX	4		BKR6EK	2288	20	LPG 1
206		1.4	55	01.00 -	TU3JP-KFX	4	0,9	BKR6EZ	4619	38	LPG 1
206		1.6	66	09.98 - 08.00	TU5JP-NFZ	4		BKR6EK	2288	20	LPG 1
206		1.6	66	01.00 -	TU5JP-NFZ	4	0,9	BKR6EZ	4619	38	LPG 1
206 16V CC		1.6	81	03.01 -	TU5JP4-NFU	4	0,9	LFR6B	6677		LPG 7
206 Coupé 16V XS, XT		1.6	81	03.01 -	TU5JP4	4	0,9	LFR6B	6677		LPG 7
206 D		1.9	51	09.98 -	DW8/ DW8B	4		Y-503R	4279	10	
206 & SW Hdi		2.0	66	10.99 -	DW10TD	4		Y-504J	1441	24	
206 S16,GT,CC		2.0	101	04.99 -	EW10J4	4	0,9	LFR5B	7113		LPG 7
206 Coupé 16V		2.0	102	04.99 -	EW10J4	4	0,9	LFR5B	7113		LPG 7
206 2.0 S16 RC		2.0	132	10.02 -	EW10J4S- RFK	4	0,9	LFR6B	6677		LPG 7
206 S16		2.0	132	10.02 -	EW10J4S~RFK	4	0,9	LFR6B	6677		LPG 7

**206 SW**

206 SW		1.1	44	09.98 - 12.99	TU1JP~HFZ, HFY	4		BKR6EK	2288	20	LPG 1
206 SW		1.1	44	01.00 -	TU1JP~HFZ, HFY	4	0,9	BKR6EZ	4619	38	LPG 1
206 SW Hdi		1.4	51	09.01 - 12.04	DV4TD	4		YE04	1684	40	
206 SW		1.4	55	09.98 - 12.99	TU3JP~KFX	4		BKR6EK	2288	20	LPG 1
206 SW		1.4	55	01.00 -	TU3JP~KFX	4	0,9	BKR6EZ	4619	38	LPG 1
206 SW		1.4	66	04 -	ET3J4~KFU	4	0,8	LZKAR7A	6799		
206 SW		1.6	66	09.98 - 12.99	TU5JP~NFZ	4		BKR6EK	2288	20	LPG 1
206 SW		1.6	66	01.00 -	TU5JP~NFZ	4	0,9	BKR6EZ	4619	38	LPG 1
206 SW 16V		1.6	81	03.01 -	TU5JP4~NFU	4	0,9	LFR6B	6677		LPG 7
206 SW Hdi		1.6	81	04 - 06.06	DV6TED4	4		YE04	1684	40	
206 SW S16		2.0	101	04.99 -	EW10J4-RFR, RFN	4	0,9	LFR5B	7113		LPG 7

**206 PLUS**

206 Plus 1.1		1.1	44	03.09 -	TU1A	4	0,9	BKR6EZ	4619	38	
--------------	--	-----	----	---------	------	---	-----	--------	------	----	--

Code *l* kW

Cyl.



Stock-No.



LPG/CNG

**PEUGEOT  
206 PLUS**

206 Plus 1.4 HdI		1.4	51	03.09 -	DV4TD	4		YE05	91322	73	
206 Plus 1.4		1.4	55	03.09 -	TU3A~KfV	4	0,9	BKR6EZ	4619	38	

**207**

207 HdI		1.4	51	07.06 -	DV4TD	4		YE04	1684	40	
207		1.4	55	05.06 -	TU3A-KfV	4	0,9	BKR6EZ	4619	38	LPG 1
207 16V		1.4	55	07 -	EP3	4	0,8	PLZKBR7A-G	5843		PLZKBR7A-G
207 16V		1.4	66	04.06 -	ET3J4-KFU	4	0,8	LZKAR7A	6799		
207 1.4 Vti 95		1.4	70	10.07 -	EP3 / EP3C	4	0,8	PLZKBR7A-G	5843		PLZKBR7A-G
207 HdI		1.6	66	07.06 -	DV6TD	4		YE04	1684	40	
207 1.6 HdI 90		1.6	66	06.07 -	DV6ATED4	4		YE05	91322	73	
207 16V		1.6	75	04.06 -	EP6	4	0,8	PLZKBR7A-G	5843		PLZKBR7A-G
207 & SW		1.6	80	06.07 -	DV6TED4	4		YE05	91322	73	
207 HdI		1.6	81	07.06 -	DV6	4		YE05	91322	73	
207 HdI 16V		1.6	81	07.06 -	DV6TED4	4		YE04	1684	40	
207 1.6 HdI 110		1.6	82	08.09 -	DV6C	4		Y8001AS	8904	58	
207 1.6 Vti 120		1.6	88	02.07 -	EP6 / EP6C	4	0,8	PLZKBR7A-G	5843		PLZKBR7A-G
207 1.6 16V		1.6	110	06.06 -	EP6DT	4	0,8	PLZKBR7A-G	5843		PLZKBR7A-G
207		1.6	110	07 -	EP6DT	4	0,8	PLZKBR7A-G	5843		PLZKBR7A-G
207 1.6 THP 155		1.6	115	10.09 -	EP6DT / EP6CDT	4	0,8	PLZKBR7A-G	5843		PLZKBR7A-G
207		1.6	129	11.06 -	EP6DTS	4	0,8	PLZKBR7A-G	5843		PLZKBR7A-G
207 RC		1.6	129	04.07 -	EP6DTS	4	0,8	PLZKBR7A-G	5843		PLZKBR7A-G

**208**

208 1.0 68 VTi		1.0	50	03.12 -	EB0	3	1,0	LZKR6AI-10G	97999		
208 1.2 82 VTi		1.2	60	03.12 -	EB2	3	1,0	LZKR6AI-10G	97999		
208 1.4 95 VTi		1.4	70	03.12 -	EP3C	4	0,8	PLZKBR7A-G	5843		
208 1.6 HDi 92		1.6	68	03.12 -	DV6DTEd	4		Y8001AS	8904	58	
208 1.6 HDi 115		1.6	84	03.12 -	DV6C	4		Y8001AS	8904	58	
208 1.6 120 VTi		1.6	88	03.12 -	EP6C	4	0,8	PLZKBR7A-G	5843		
208 1.6 155 THP		1.6	115	03.12 -	EP6CDT	4	0,8	PLZKBR7A-G	5843		
208 1.6 Gti		1.6	147	08.12 -	EP6CDTXM	4	0,8	ILZKBR7A-8G	5992		

**301**

301 1.2 72 VTi		1.2	52	12 -	EB2M	3	1,0	LZKR6AI-10G	97999		
----------------	--	-----	----	------	------	---	-----	-------------	-------	--	--

**306**

306		1.1	44	02.93 - 06.95	TU1M-HDZ	4	0,8	BCPR5ES	6130	32	LPG 3
306		1.1	44	07.95 - 04.97	TU1M-HDZ	4		BKR5EK	7956	23	LPG 1
306		1.1		96 -	TU1.M+	4		BKR6EK	2288	20	LPG 1
306		1.4	55	02.93 - 06.95	TU3.MC-KDX	4	0,8	BCPR5ES	6130	32	LPG 3
306		1.4	55	07.95 - 12.03	TU3JP-KFX	4		BKR6EK	2288	20	LPG 1
306		1.4	55	01.00 - 10.03	TU3JP-KFX	4	0,9	BKR6EZ	4619	38	LPG 1
306		1.6	66	02.93 - 12.99	TU5JP-NFZ	4		BKR6EK	2288	20	LPG 1
306		1.6	66	01.00 - 10.03	TU5JP-NFZ	4	0,9	BKR6EZ	4619	38	LPG 1
306		1.8	43	10.93 - 08.98	XUD7	4		Y-924J	7906	1	
306		1.8	44	09.98 -	XUD7	4		Y-938R	5267	1	
306 D		1.8	44	09.98 - 07.02	DW8	4		Y-503R	4279	10	
306 TD		1.8	59	09.98 - 07.02	DW8TD	4		Y-503R	4279	10	
306		1.8	74	02.93 - 03.95	XU7JP-LFZ	4	0,8	BCPR5ES	6130	32	LPG 3
306		1.8	74	04.95 - 10.03	XU7JP-LFZ	4		BKR5EK	7956	23	LPG 1
306 16V		1.8	81	04.97 - 10.03	XU7JP4-LFY	4		BKR5EK	7956	23	LPG 1

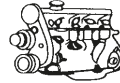
Code *l* kW

Cyl.



Stock-No.

LPG/CNG

**PEUGEOT****306**

306 D		1.9	51	02.93 - 08.98	XUD9A	4	☑	Y-924J	7906	1	
306		1.9	51	09.98 - 07.02	DW8	4	☑	Y-503R	4279	10	
306		1.9	51	09.98 - 12.99	XUD9A/XUD9BSD	4	☑	Y-938R	5267	1	
306 D		1.9	68	03.93 - 08.98	XUD9TE	4	☑	Y-923U	3380	1	
306 D		1.9	68	09.98 - 12.99	XUD9TE	4	☑	Y-938R	5267	1	
306 Hdi		2.0	66	04.99 - 07.02	DW10TD	4	☑	Y-504J	1441	24	
306 D		2.0	80	09.98 -	DW10TD	4	☑	Y-504J	1441	24	
306		2.0	89	- 03.97	XU10.J4-RFY	4	0,8	BKR6ES	3783	28	LPG 1
306		2.0	89	02.93 - 03.95	XU10.J2-RFX	4	0,8	BCPR5ES	6130	32	LPG 3
306		2.0	89	04.95 - 04.97	XU10.J2-RFX	4		BKR5EK	7956	23	LPG 1
306		2.0	98	04.97 -	XU10J4R-RFV	4		BKR5EK	7956	23	LPG 1
306 Le Mans		2.0	110	11.93 - 96	XU10J4	4	0,8	BKR6ES	3783	28	LPG 1
306		2.0	120	07.96 - 10.03	XU10J4RS-RFS	4	0,9	BKR5EZ	7642	36	LPG 1
306 2.0 16V		2.0		11.93 - 96	XU10J4	4	0,8	BKR6ES	3783	28	LPG 1
306		2.0	120	07.96 - 10.03	XU10J4RS-RFS	4	0,9	BKR5EZ	7642	36	LPG 1
306 2.0 16V Le Mans		2.0		11.93 - 96	XU10J4	4	0,8	BKR6ES	3783	28	LPG 1

**307**

307 Hdi		1.4	51	01.02 - 12.04	DV4TD	4	☑	YE04	1684	40	
307 Hdi		1.4	51	01.02 - 12.04	DV4TD	4	☑	YE04	1684	40	
307		1.4	51	12.04 - 05.05	DV4TD	4	☑	YE05	91322	73	
307		1.4	55	04.01 - 05.05	TU3JP-KFX	4	0,9	BKR6EZ	4619	38	LPG 1
307 XR		1.4	55	04.01 - 99	TU3JP~KFX	4	0,9	BKR6EZ	4619	38	LPG 1
307 16V		1.4	66	03.04 -	ET3J4 KFU	4	0,8	LZKAR7A	6799		
307 1.6 Hdi		1.6	66	04.05 -	DV6ATED4	4	☑	YE05	91322	73	
307 Hdi		1.6	68	07.06 -	DV6TD	4	☑	YE04	1684	40	
307		1.6	81	04.01 -	TU5JP4-NFU	4	0,9	LFR6B	6677		LPG 7
307 16V		1.6	81	04.01 -	TU5JP4~NFU	4	0,9	LFR6B	6677		LPG 7
307 Hdi		1.6	81	03.04 - 06.06	DV6TED4	4	☑	YE04	1684	40	
307 Hdi		1.6	81	07.06 -		4	☑	YE05	91322	73	
307 Hdi		1.6	81	07.06 -	DV6	4	☑	YE05	91322	73	
307 Hdi		2.0	66	04.01 -	DW10TD	4	☑	Y-504J	1441	24	
307 Hdi		2.0	81	09.01 -	DW10ATED	4	☑	Y-504J	1441	24	
307 Hdi		2.0	100	03.04 -	DW10TED	4	☑	Y-504J	1441	24	
307 2.0 Hdi		2.0	100	11.03 - 11.07	DW10BTED4	4	☑	Y1005J	7957	56	
307 CC 2.0 Hdi		2.0	100	11.03 - 04.09	DW10BTED4	4	☑	Y1005J	7957	56	
307 SW 2.0 Hdi		2.0	100	11.03 - 04.08	DW10BTED4	4	☑	Y1005J	7957	56	
307		2.0	101	04.01 -	EW10J4-RFN	4	0,9	LFR5B	7113		LPG 7
307 16V		2.0	101	04.01 -	EW10J4-RFN	4	0,9	LFR5B	7113		LPG 7
307 16V		2.0	102	03 -	EW10J4	4	0,9	LFR5B	7113		LPG 7
307		2.0	104	09.06 -	EW10A	4	0,9	LFR5B	7113		LPG 7
307 2.0 16V		2.0	104	09.06 -	EW10A	4	0,9	LFR5B	7113		LPG 7

**308 I**

308 I 1.4 16V		1.4	55	09.07 -	EP3	4	0,8	PLZKBR7A-G	5843		
308 I 1.4 Vti 95		1.4	70	09.07 -	EP3 / EP3C	4	0,8	PLZKBR7A-G	5843		
308 I 1.4 Vti 95		1.4	72	12.09 -	EP3C	4	0,8	PLZKBR7A-G	5843		
308 I 1.6 Hdi		1.6	66	09.07 -	DV6TD	4	☑	YE05	91322	73	
308 I 1.6 Hdi		1.6	68	11.09 -	DV6DTED	4	☑	Y8001AS	8904	58	
308 I 1.6 16V		1.6	80	09.07 -	EP6	4	0,8	PLZKBR7A-G	5843		
308 I 1.6 Hdi		1.6	80	09.07 -	DV6TED4	4	☑	YE05	91322	73	

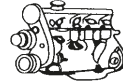
Code *l* kW

Cyl.



Stock-No.



LPG/CNG

**PEUGEOT****308 I**

308 I 1.6 HdI 110		1.6	82	12.09 -	DV6CTED4	4		Y8001AS	8904	58	
308 I 1.6 16V		1.6	88	09.07 -	EP6 / EP6C	4	0,8	PLZKBR7A-G	5843		
308 I 1.6 16V		1.6	103	09.07 -	EP6DT	4	0,8	PLZKBR7A-G	5843		
308 I 1.6 THP 150		1.6	110	09.07 -	EP6DT	4	0,8	PLZKBR7A-G	5843		
308 I 1.6 THP 155		1.6	115	07.09 -	EP6CDT	4	0,8	PLZKBR7A-G	5843		
308 I 1.6 THP 175		1.6	130	09.07 -	EP6DTS	4	0,8	PLZKBR7A-G	5843		
308 I 1.6 GTi		1.6	147	07.10 -	EP6CDTX	4	0,8	ILZKBR7A-8G	5992		
308 I 2.0 HdI		2.0	100	09.07 -	DW10BTED	4		Y1005J	7957	56	
308 I 2.0 HdI		2.0	100	09.07 -	DW10BTED4	4		Y1005J	7957	56	
308 I 2.0 HdI 140		2.0	103	07.10 -	DW10BTED	4		Y1005J	7957	56	
308 I 2.0 HdI 165		2.0	120	07.09 -	DW10CTED4	4		Y8001AS	8904	58	

**308CC I**

308 CC I 1.6 THP 16V		1.6	105	03.09 -	EP6DT	4	0,8	PLZKBR7A-G	5843		
308 CC I 1.6 THP 16V		1.6	110	03.09 -	EP6DT	4	0,8	PLZKBR7A-G	5843		
308 CC I 1.6 THP 200		1.6	147	10.10 -	EP6CDTX	4	0,8	ILZKBR7A-8G	5992		
308 CC I 2.0 HdI 165		2.0	120	06.09 -	DW10CTED4	4		Y8001AS	8904	58	

**308 II**

308 II 1.2 82 Vti		1.2	60	09.13 -	EB2	3	1,0	LZKR6AI-10G	97999		
308 II 1.6 HDi 92		1.6	68	09.13 -	DV6DTE	4		Y8001AS	8904	58	
308 II 1.6 e-HDi 115		1.6	85	09.13 -	DV6C	4		Y8001AS	8904	58	
308 II 1.6 125 THP		1.6	92	09.13 -	EP6CDT	4	0,8	PLZKBR7A-G	5843		
308 II 1.6 155 THP		1.6	115	09.13 -	EP6CDT	4	0,8	PLZKBR7A-G	5843		

**309**

309 GE, GL, GR		1.1	40	- 12.92	E1A	4	0,8	BCP5ES	7496	16	LPG 3
309 XA, XR, XL		1.1	40	- 12.92	E1A	4	0,8	BCP5ES	7496	16	LPG 3
309 XE, GE		1.1	40	- 12.92	TU1	4	0,8	BCP5ES	7496	16	LPG 3
309 Vital		1.1	40	07.92 -	TU1M Cat.	4	0,8	BCPR5ES	6130	32	LPG 3
309 GE, GL, GR, XE, XL, XR, XA		1.3	47	10.86 - 12.93	G1A	4	0,8	BCP5ES	7496	16	LPG 3
309 XL, GL		1.4	44	10.86 - 12.93	TU3	4	0,8	BCP5ES	7496	16	LPG 3
309 GRX		1.4	55	10.86 - 12.93	TU3M Cat.	4	0,8	BCPR5ES	6130	32	LPG 3
309		1.5	42	03.94 - 12.95	TUD5	4		Y-503J	1009	10	
309 SR, GRX		1.6	65	07.92 -	XU5M Cat.	4	0,8	BCPR5ES	6130	32	LPG 3
309 GR, GRX, SR, SX, XS, XR		1.6	68	07.89 - 12.92	XU5.2C	4	0,7	BCP6ES	4930	17	LPG 3
309 D		1.8	44	06.86 - 12.93	XUD7	4		Y-924J	7906	1	
309 TD		1.8	58	11.89 - 12.93	XUD7T	4		Y-924J	7906	1	
309 D		1.9	47	06.86 - 12.93	XUD9 / XUD9Y	4		Y-924J	7906	1	
309 XS, SX		1.9	80	07.89 - 06.92	XU9.2C	4	0,7	BCP6ES	4930	17	LPG 3
309 XS, SX		1.9	80	07.92 -	XU9M Cat.	4	0,8	BCPR5ES	6130	32	LPG 3
309 GTi		1.9	88	07.92 -	XU9.JA Cat.	4	0,8	BCPR5ES	6130	32	LPG 3
309 GTi		1.9	94	- 12.92	XU9.JA	4	0,7	BCP6ES	4930	17	LPG 3
309 GTi 16V		1.9	110	07.92 -	XU9.J4 Cat.	4		BCPR6ET	2197		LPG 3
309 GTi 16V		1.9	118	- 06.92	XU9.J4	4		BCP6ET	4563		LPG 3

**405**

405 GL		1.4	47	07.87 - 06.92	TU3	4	0,8	BCP5ES	7496	16	LPG 3
405 GL		1.4	55	07.92 - 06.95	TU3M-KDX Cat.	4	0,8	BCPR5ES	6130	32	LPG 3
405		1.4	55	07.95 - 04.97	TU3M-KDX Cat.	4		BKR6EK	2288	20	LPG 1
405 GL, GR, SR		1.6	55	07.87 - 06.92	XU51C	4	0,8	BCP5ES	7496	16	LPG 3
405 GL, GR, SR		1.6	65	07.92 - 06.94	XU5M-BDY Cat.	4	0,8	BCPR5ES	6130	32	LPG 3
405		1.6	66	04.95 -	XU5JP-BFZ	4		BKR5EK	7956	23	LPG 1
405 Sillage, Style		1.6		07.94 - 03.95	XU5JP-BFZ Cat.	4	0,8	BCPR5ES	6130	32	LPG 3

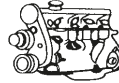
Code *l* kW

Cyl.

Stock-No.  
**VEFINE****LPG/CNG****PEUGEOT****405**

405 TD		1.8	68	03.88 - 12.92	XUD7TE	4	☑	Y-924J	7906	1	
405 Signa, Style		1.8	74	07.92 - 03.95	XU7JP-LFZ Cat.	4	0,8	BCPR5ES	6130	32	LPG 3
405		1.8		04.95 -	XU7JP-LFZ	4		BKR5EK	7956	23	LPG 1
405 GLD		1.9	47	07.88 - 12.92	XUD9Y	4	☑	Y-924J	7906	1	
405 D		1.9	51	03.88 -	XUD9A	4	☑	Y-924J	7906	1	
405		1.9	51	09.98 - 12.99	XUD9A	4	☑	Y-938R	5267	1	
405		1.9	55	10.95 -	XUD9SD	4	☑	Y-923U	3380	1	
405 TD		1.9	68	09.92 - 12.97	XUD9TE / XUD9TF	4	☑	Y-923U	3380	1	
405 GR,SR		1.9		07.87 - 06.92	XU92C	4	0,7	BCP6ES	4930	17	LPG 3
405 GRi, SRi, Si, X4		1.9		07.87 - 06.92	XU9J2-D6A	4	0,7	BCP6ES	4930	17	LPG 3
405 MI16,X4		1.9		07.90 - 06.92	XU9J4-D6C	4		BCPR6ET	2197		LPG 3
405 Signature, STI		2.0	90	07.92 - 03.95	XU10J2-RFX Cat.	4		BKR5EK	7956	23	LPG 1
405 Mi16		2.0	110	07.92 -	XU10J4-RFY Cat.	4	0,8	BKR6ES	3783	28	LPG 1
405 T16		2.0	147	09.92 - 04.97	XU10J4TE-RGZ Cat.	4		BKR6EK	2288	20	LPG 1
405 Signature,STI		2.0		07.92 - 03.95	XU10J2-RFX Cat.	4	0,8	BCPR5ES	6130	32	LPG 3

**406**

406		1.6	66	10.95 - 06.04	XU5JP-BFZ	4		BKR5EK	7956	23	LPG 1
406		1.8	66	10.95 - 06.04	XU7JP-L6A	4		BKR5EK	7956	23	LPG 1
406		1.8	81	10.95 - 06.04	XU7JP4-LFY	4		BKR5EK	7956	23	LPG 1
406 TD		1.9	68	10.95 - 08.98	XUD9TE/TF/BTF	4	☑	Y-923U	3380	1	
406		1.9	68	09.98 - 12.99	XUD9TE /TF/BTF	4	☑	Y-938R	5267	1	
406 Hdi		2.0	81	12.98 - 04.04	DW10ATED	4	☑	Y-504J	1441	24	
406		2.0	97	10.95 - 06.04	XU10J4R-RFV	4		BKR5EK	7956	23	LPG 1
406 Coupé 16V		2.0	97	06.97 - 03.99	XU10J4R-RFV	4		BKR5EK	7956	23	LPG 1
406 Coupé 16V		2.0	101	04.99 - 02.05	EW10J4-RFR	4	0,9	LFR5B	7113		LPG 7
406		2.0	107	07.96 - 03.99	XU10J2TE-RGX	4		BKR6EK	2288	20	LPG 1
406 TD		2.1	80	10.95 - 08.98	XUD11BTE	4	☑	Y-923U	3380	1	
406		2.1	80	09.98 - 12.99	XUD11BTE	4	☑	Y-938R	5267	1	
406 Coupé Hdi		2.2	100	03.01 -	DW12TED4	4	☑	Y-504J	1441	24	
406 Coupé 16V		2.2	118	05.00 - 02.05	EW12J4-3FZ	4	0,9	LFR5B	7113		LPG 7
406 24V V6		3.0	140	10.96 - 02.05	ES9J4-XFZ	6		BKR6EK	2288	20	LPG 1
406 Coupé V6		3.0	143	06.97 - 02.05	ES9J4-XFZ	6		BKR6EK	2288	20	LPG 1
406 Coupé V6		3.0	154	06.00 - 11.04	ES9J4S-XFX	6	1,1	PLFR5A-11	6240		LPG 7

**406 PHASE 2**

406 Phase 2		1.8	66	04.99 - 02.05	XU7JB-LFX	4		BKR6EK	2288	20	LPG 1
406 Phase 2		1.8	81	04.99 - 06.04	XU7JP4-LFY	4		BKR5EK	7956	23	LPG 1
406 Phase 2		1.8	86	09.00 - 06.04	EW7J4-6FZ	4	0,9	LFR5B	7113		LPG 7
406 TD Phase 2		2.0	66	04.99 - 04.04	DW10TD	4	☑	Y-504J	1441	24	
406 TD Phase 2		2.0	81	04.99 - 04.04	DW10ATED	4	☑	Y-504J	1441	24	
406 2.2 Hdi		2.2	98	03.00 - 10.04	DW12TED4	4	☑	Y1005J	7957	56	
406 Coupe 2.2 Hdi		2.2	98	09.00 - 12.04	DW12TED4	4	☑	Y1005J	7957	56	
406 Phase 2		2.0	101	04.99 - 02.05	EW10J4-RFR, RFN	4	0,9	LFR5B	7113		LPG 7
406 Hdi Phase 2		2.2	100	09.00 - 05.03	DW12TED4	4	☑	Y-504J	1441	24	
406 Phase 2		2.2	117	04.99 - 02.05	EW12J4-3FZ	4	0,9	LFR5B	7113		LPG 7
406 Phase 2		3.0	140	04.99 - 02.05	ES9J4-XFZ	6		BKR6EK	2288	20	LPG 1
406 Phase 2		3.0	154	10.00 - 02.05	ES9J4S-XFX	6	1,1	PLFR5A-11	6240		LPG 7

**407**

407 1.6 Hdi		1.6	81	04.04 - 06.06	DV6TED	4	☑	YE04	1684	40	
407 1.6 Hdi		1.6	81	03.06 - 12.10	DV6TED4	4	☑	YE05	91322	73	
407 1.8		1.8	85	04.04 - 07.05	EW7J4-6FZ	4	0,9	LFR5B	7113		LPG 7

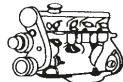

Code *l* kW

Cyl.



Stock-No.



LPG/CNG

**PEUGEOT****407**

407 2.0 Hdi		2.0	93	04.04 - 12.10	DW10TED	4	█	Y-504J	1441	24	
407 2.0 Hdi		2.0	100	08.05 - 05.09	DW10BTED4	4	█	Y1005J	7957	56	
407 2.0		2.0	100	05.04 - 07.05	EW10J4 RFN	4	0,9	LFR5B	7113		LPG 7
407 16V		2.0	104	09.06 - 12.10	EW10A	4	0,9	LFR5B	7113		LPG 7
407 2.0 16V		2.0		09.06 - 12.10	EW10A	4	0,9	LFR5B	7113		LPG 7
407 2.0 HDi		2.0	120	06.09 - 12.10	DW10CTED4	4	█	Y8001AS	8904	58	
407 2.2		2.2	116	04.04 - 07.05	EW12J4-3FZ	4	0,9	LFR5B	7113		LPG 7
407 2.2 16V		2.2	120	08.05 - 12.10	EW12J4-3FZ	4	0,9	LFR5B	7113		LPG 7
407 2.2 Hdi		2.2	125	05.06 - 12.10	DW12BTED4	4	█	YE08	4966		
407 2.7 V6 Hdi		2.7	150	10.05 - 12.10	DT17TED4	6	█	YE12	7794		
407 3.0 V6 24V		3.0	155	04.04 - 12.10	ES9A~XFV	6	1,1	PLFR5A-11	6240		LPG 7

**408**

408 2.0 Hdi		2.0	110	10 -	DW10CTED4	4	█	Y8001AS	8904	58	
-------------	--	-----	-----	------	-----------	---	---	---------	------	----	--

**508**

508 1.6 Hdi 110		1.6	82	11.10 -	DV6C	4	█	Y8001AS	8904	58	
508 1.6 Hdi 110		1.6	84	02.12 -	DV6C	4	█	Y8001AS	8904	58	
508 1.6 e-Hdi 115		1.6	84	03.13 -	DV6C	4	█	Y8001AS	8904	58	
508 1.6 Vti 120		1.6	88	11.10 -	EP6C	4	0,8	PLZKBR7A-G	5843		
508 1.6 THP 155		1.6	115	11.10 -	EP6CDT	4	0,8	PLZKBR7A-G	5843		
508 2.0 Hdi 140		2.0	103	11.10 -	DW10BTED4	4	█	Y1005J	7957	56	
508 2.0 Hdi 165		2.0	120	11.10 -	DW10CTED4	4	█	Y8001AS	8904	58	
508 2.0 Hdi RXH HYbrid4		2.0	120	12.11 -	DW10CTED4	4	█	Y8001AS	8904	58	

**605**

605 SL		2.0	79	07.89 - 06.92	XU102C-R2A	4	0,7	BCP6ES	4930	17	LPG 3
605 SRi		2.0	89	09.89 - 12.92	XU10J2-R6A	4	0,8	BCPR6ES	2330	12	LPG 3
605 SLI		2.0	89	07.92 - 07.94	XU10J2-RFZ Cat.	4	0,8	BCPR5ES	6130	32	LPG 3
605		2.0	99	08.94 - 05.99	XU10J4R-RFV	4		BKR5EK	7956	23	LPG 1
605 SRTi Turbo		2.0	104	12.92 - 05.99	XU10J2TE-RGX	4		BKR6EK	2288	20	LPG 1
605 D		2.1	60	09.89 - 06.94	XUD11A/L	4	█	Y-924J	7906	1	
605 TD		2.1	80	09.89 - 06.94	XUD11ATE/L, BTE	4	█	Y-923U	3380	1	
605 TD		2.1	80	09.98 - 07.00	XUD11ATE/BTE	4	█	Y-938R	5267	1	
605 TD		2.5	96	07.94 - 05.99	DK5ATE	4	█	Y-923U	3380	1	
605 SR, SV		3.0	125	07.89 - 06.97	ZPJ-SFZ Cat.	6		BCPR6ET	2197		LPG 3
605 3.0		3.0	140	07.97 - 05.99	ES9J4-XFZ	6		BKR6EK	2288	20	LPG 1
605 SV 24V		3.0	147	07.89 - 06.97	ZPJ4-SKZ Cat.	6		BCPR6ET	2197		LPG 3

**607**

607 Hdi		2.0	81		DW10TED	4	█	Y-504J	1441	24	
607 2.0 Hdi		2.0	100	09.05 -	DW10BTED4	4	█	Y1005J	7957	56	
607		2.0	101	05.00 - 11.04	EW10J4-RFN	4	0,9	LFR5B	7113		LPG 7
607 2.2 Hdi		2.2	98	12.99 - 02.06	DW12TED4	4	█	Y1005J	7957	56	
607 Hdi 16V		2.2	100	05.00 -	DW12TED4	4	█	Y-504J	1441	24	
607		2.2	118	05.00 -	EW12J4-3FZ	4	0,9	LFR5B	7113		LPG 7
607 Hdi		2.2	125	06.06 -	DW12BTED4	4	█	YE08	4966		
607 2.7 V6 Hdi		2.7	150	12.04 -	DT17	6	█	YE12	7794		
607 3.0 V6		3.0	152	05.00 -	ES9J4S-XFX	6	1,1	PLFR5A-11	6240		LPG 7

**806**

806		1.8	74	10.96 - 06.00	XU7JP-LFW	4		BKR5EK	7956	23	LPG 1
806 TD		1.9	68	06.94 - 08.98	XUD9TF	4	█	Y-923U	3380	1	
806 D		1.9	68	09.98 -	XUD9BTF	4	█	Y-938R	5267	1	

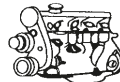
Code *l* kW

Cyl.



Stock-No.



LPG/CNG

**PEUGEOT****806**

806 D		1.9	68	09.98 - 01.01	XUD9TF	4	☑	Y-938R	5267	1	
806 D		2.0	80	09.98 -	DW10TED	4	☑	Y-504J	1441	24	
806 D Hdi		2.0	81	09.99 -	DW10ATED	4	☑	Y-504J	1441	24	
806 16V		2.0	89	06.94 - 03.95	XU10J2-RFU	4	0,8	BCPR5ES	6130	32	LPG 3
806		2.0	90	04.95 - 05.00	XU10J2-RFU	4		BKR5EK	7956	23	LPG 1
806		2.0	101	06.00 -	EW10J4-RFR	4	0,9	LFR5B	7113		LPG 7
806 Turbo		2.0	110	06.94 - 05.00	XU10J2TE-RGX	4		BKR6EK	2288	20	LPG 1
806 D		2.1	80	06.96 - 08.98	XUD11BTE	4	☑	Y-923U	3380	1	
806 TD		2.1	80	07.96 -	XUD11ATE	4	☑	Y-923U	3380	1	
806 D		2.1	80	09.98 - 01.01	XUD11BTE	4	☑	Y-938R	5267	1	

**807**

807 2.0 Hdi		2.0	79	08.02 - 05.06	DW10ATED4	4	☑	Y1005J	7957	56	
807 2.0 Hdi		2.0	80	06.02 -	DW10ATED4/RHT	4	☑	Y-504J	1441	24	
807 2.0 Hdi		2.0	80	04.04 - 05.06	DW10ATED4	4	☑	Y1005J	7957	56	
807 2.0 Hdi		2.0	88	11.06 -	DW10UTED4	4	☑	Y1005J	7957	56	
807 2.0 Hdi		2.0	100	06.06 -	DW10BTED4	4	☑	Y1005J	7957	56	
807 2.0		2.0	102	06.02 - 09.05	EW10J4-RFR	4	0,9	LFR5B	7113		LPG 7
807 2.0 16V		2.0	104	10.05 -	EW10A	4	0,9	LFR5B	7113		LPG 7
807 2.0 Hdi		2.0	120	06.09 -	DW10CTED4	4	☑	Y8001AS	8904	58	
807 2.2 Hdi		2.2	94	06.02 -	DW12TED4/4HW	4	☑	Y-504J	1441	24	
807 2.2 Hdi		2.2	94	08.02 - 05.06	DW12TED4	4	☑	Y1005J	7957	56	
807 2.2 16V		2.2	118	06.02 -	EW12J4-3FZ	4	0,9	LFR5B	7113		LPG 7
807 2.2 Hdi		2.2	125	06.06 -	DW12BTED4	4	☑	YE08	4966		
807 3.0 V6		3.0	154	06.02 -	ES9J4S-XFX	6	1,1	PLFR5A-11	6240		LPG 7

**1007**

1007 1.4 Hdi		1.4	51	01.05 -	DV4TD	4	☑	YE05	91322	73	
1007 1.4		1.4	55	04.05 -		4	1,1	BKR6E-11	2756	14	LPG 1
1007 1.4 16V		1.4	65	10.05 -	ET3J4	4	0,8	LZKAR7A	6799		
1007 1.4 Hdi		1.4	68		DV6TD	4	☑	YE05	91322	73	
1007 1.6 Hdi		1.6	80	06.07 -	DV6TED4	4	☑	YE05	91322	73	
1007 1.6		1.6	81	04.05 -		4	0,9	LFR6B	6677		LPG 7

**2008**

2008 1.2 82 Vti		1.2	60	03.13 -	EB2	3	1,0	LZKR6AI-10G	97999		
2008 1.6 e-HDi 92		1.6	68	03.13 -	DV6TED4	4	☑	Y8001AS	8904	58	
2008 1.6 e-HDi 115		1.6	84	03.13 -	DV6C	4	☑	Y8001AS	8904	58	
2008 1.6 120 Vti		1.6	88	03.13 -	EP6C	4	0,8	PLZKBR7A-G	5843		

**3008**

3008 1.6 HDI		1.6	80	05.09 -	DV6TED4	4	☑	YE05	91322	73	
3008 1.6 Hdi 110		1.6	82	08.10 -	DV6CTED4~9HZ	4	☑	Y8001AS	8904	58	
3008 1.6 HDi 115		1.6	84	03.13 -	DV6C	4	☑	Y8001AS	8904	58	
3008 1.6 Vti 120		1.6	88	05.09 -	EP6	4	0,8	PLZKBR7A-G	5843		
3008 THP		1.6	110	05.09 -	EP6DT	4	0,8	PLZKBR7A-G	5843		
3008 1.6 THP 155		1.6	115	05.09 -	EP6CDT	4	0,8	PLZKBR7A-G	5843		
3008 Hdi		2.0	80	06.09 -	DW10CTED4	4	☑	Y8001AS	8904	58	
3008 2.0 Hdi 150		2.0	110	04.09 -	DW10CTED4~RHE, RHH	4	☑	Y8001AS	8904	58	
3008 2.0 HDi 165		2.0	120	06.09 -	DW10CTED4	4	☑	Y8001AS	8904	58	
3008 2.0 HDi Hybrid4		2.0	120	09.11 -	DW10CTED4	4	☑	Y8001AS	8904	58	

Code *l* kW

Cyl.



Stock-No.



LPG/CNG

**PEUGEOT****4007**

4007 2.2 Hdi		2.2	115	07.07 -	DW12MTED4	4		YE08	4966		
4007 2.4		2.4	125	02.07 -	VUSFZC/VUSFZF/ VVSFZC/VVSFZF	4	0,8	FR5EI	1313		FR6EI

**4008**

4008 1.6 Hdi 115		1.6	84	04.12 -	DV6	4		Y8001AS	8904	58	
4008 2.0		2.0	110	04.12 -	4B11	4	0,8	FR6EI	2687		FR6EI

**5008**

5008 1.6 Hdi 110		1.6	80	09.09 -	DV6CTED4	4		Y8001AS	8904	58	
5008 1.6 HDi 110		1.6	82	08.10 -	DV6C	4		Y8001AS	8904	58	
5008 1.6 HDi 115		1.6	84	03.13 -	DV6C	4		Y8001AS	8904	58	
5008 1.6 Vti 120		1.6	88	09.09 -	EP6	4	0,8	PLZKBR7A-G	5843		
5008 1.6 THP 155		1.6	115	09.09 -	EP6CDT	4	0,8	PLZKBR7A-G	5843		
5008 2.0 HDi 140		2.0	100	02.12 -	DW10CTED4	4		Y8001AS	8904	58	
5008 2.0 Hdi 150		2.0	110	09.09 -	DW10CTED4	4		Y8001AS	8904	58	
5008 2.0 Hdi 165		2.0	121	09.09 -	DW10CTED4	4		Y8001AS	8904	58	

**BIPPER**

Bipper 1.3 HDi 75		1.3	55	10.10 -	F13DTE5	4		Y9001AS	97719	72	
Bipper Tepee 1.3 HDi 75		1.3	55	10.10 -	F13DTE5	4		Y9001AS	97719	72	
Bipper 1.4 Hdi		1.4	50	02.08 -	DV4TD	4		YE05	91322	73	
Bipper 1.4		1.4	54	02.08 -	KFV (TU3A)	4	0,9	BKR6EZ	4619	38	LPG 1
Bipper Tepee 1.4		1.4	54	05.08 -	KFV (TU3A)	4	0,9	BKR6EZ	4619	38	LPG 1

**BOXER**

Boxer D		1.8	44	09.98 -	XUD7	4		Y-924J	7906	1	
Boxer D		1.9	51	03.94 - 08.98	XUD9A	4		Y-924J	7906	1	
Boxer D		1.9	51	09.98 -	XUD9AU	4		Y-924J	7906	1	
Boxer TD		1.9	68	03.94 - 08.98	XUD9TF	4		Y-924J	7906	1	
Boxer		1.9	68	09.98 -	XUD9TF	4		Y-924J	7906	1	
Boxer		2.0	81	04.95 -	XU10J2U-RFW	4		BKR6EK	2288	20	LPG 1
Boxer 2.2 Hdi		2.2	74	12.01 - 06.06	DW12UTED	4		Y1005J	7957	56	
Boxer 2.2 Hdi 100		2.2	74	04.06 -	4HV	4		Y-548J	94832	75	
Boxer 2.2 Hdi 120		2.2	88	04.06 -	4HU	4		Y-548J	94832	75	
Boxer		2.5	63	03.94 - 08.98	DJ5	4		Y-924J	7906	1	
Boxer TD		2.5	76	03.94 - 08.96	DJ5T	4		Y-924J	7906	1	
Boxer Tdi		2.5	76	09.96 -	DJ5TED	4		Y-738U	5390		
Boxer Hdi		2.8	93	10.97 -	Sofim	4		Y-924U	4950	1	
Boxer 3.0 Hdi		3.0	107	04.10 -	F30DT	4		Y8005J	96853	64	
Boxer 3.0 Hdi 160		3.0	116	04.06 -	F30DT	4		Y8005J	96853	64	
Boxer 2 Hdi		2.0	66	09.98 -	DW10TD	4		Y-504J	1441	24	
Boxer 2 Hdi		2.2	100	03.01 -	DW10TED4	4		Y-504J	1441	24	

**EXPERT**

Expert		1.6	59	95 -	1580 SPI 222A2.000	4	0,8	BCPR7ES	3330		BCPR7EIX
Expert 1.6 Hdi		1.6	66	01.07 -	DV6UTED4	4		YE05	91322	73	
Expert		1.8	44	09.98 -	DW8	4		Y-503J	1009	10	
Expert TD		1.8	59	09.98 -	DW8TD	4		Y-503J	1009	10	
Expert		1.8	74	96 -	XU7JP	4		BKR5EK	7956	23	LPG 1
Expert		1.9	51	01.96 - 08.98	XUD9A	4		Y-924J	7906	1	
Expert		1.9	51	09.98 -	XUD9A	4		Y-924J	7906	1	
Expert TD		1.9	66	09.95 - 08.98	XUD 9TE	4		Y-924J	7906	1	
Expert		1.9	68	01.96 - 08.98	XUD9BTF	4		Y-924J	7906	1	

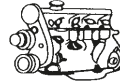
Code *l* kW

Cyl.

Stock-No.  
**VEFINE**  
E-FORWARD\*

LPG/CNG

**PEUGEOT****EXPERT**

Expert		1.9	68	01.96 - 08.98	XUD9TF	4	☑	Y-924J	7906	1	
Expert TD		1.9	68	09.98 -	XUD9BTF	4	☑	Y-924J	7906	1	
Expert TD		1.9	68	09.98 -	XUD9TF	4	☑	Y-924J	7906	1	
Expert Hdi		2.0	70	02.00 -	DW10TED	4	☑	Y-504J	1441	24	
Expert 2.0 Hdi 100		2.0	72	03.11 -	DW10CE	4	☑	Y8001AS	8904	58	
Expert Hdi		2.0	81	02.00 -	DW10ATED	4	☑	Y-504J	1441	24	
Expert Hdi		2.0	88	11.06 -	DW10UTED4	4	☑	Y1005J	7957	56	
Expert 2.0 Hdi 130		2.0	94	03.11 -	DW10CD	4	☑	Y8001AS	8904	58	
Expert Hdi		2.0	100	11.06 -	DW10BTED4	4	☑	Y1005J	7957	56	
Expert		2.0	100	06.00 -	EW10J4 RFN	4	0,9	LFR5B	7113		LPG 7
Expert		2.0	104	01.07 -	EW10A	4	0,9	LFR5B	7113		LPG 7
Expert 2.0 16V		2.0	105	01.07 -	EW10A	4	0,9	LFR5B	7113		LPG 7
Expert 2.0 Hdi 165		2.0	120	09.09 -	DW10CTED4	4	☑	Y8001AS	8904	58	
Expert		2.1	80	07.96 -	XUD11ATE	4	☑	Y-924J	7906	1	

**J5**

J5		1.9	51	11.87 - 01.94	XUD9A	4	☑	Y-924J	7906	1	
J5 D		1.9	51	11.87 -	XUD9A	4	☑	Y-924J	7906	1	
J5		2.5	54	07.91 - 03.94	CRD93	4	☑	Y-924J	7906	1	
J5		2.5	70	07.91 - 03.94	CRD93LS	4	☑	Y-924J	7906	1	

**PARTNER**

Partner		1.1	44	07.96 -	TU1M+HDZ	4		BKR6EK	2288	20	LPG 1
Partner		1.4	55	07.96 -	TU3JP-KFX/KFW	4		BKR6EK	2288	20	LPG 1
Partner 1.4 Hdi		1.4	55	03.06 -	DV6	4	☑	YE05	91322	73	
Partner 1.6 Hdi		1.6	55	04.08 -	DV6BTED4	4	☑	YE05	91322	73	
Partner 1.6 Hdi		1.6	66	03.06 -	DV6	4	☑	YE05	91322	73	
Partner		1.8	66	07.97 -	XU7JB-LFX	4		BKR6EK	2288	20	LPG 1
Partner Combi		1.8	43	07.96 - 08.98	XUD7	4	☑	Y-924J	7906	1	
Partner Combi		1.8	44	09.98 - 03.02	XUD7	4	☑	Y-924J	7906	1	
Partner Combi		1.8	44	09.98 - 03.02	DW8	4	☑	Y-503J	1009	10	
Partner Combi		1.8	59	09.98 - 03.02	DW8TD	4	☑	Y-503J	1009	10	
Partner Combi		1.9	51	07.96 - 08.98	XUD9A	4	☑	Y-924J	7906	1	
Partner Combi		1.9	51	09.98 - 03.02	XUD9A	4	☑	Y-924J	7906	1	
Partner Combi		1.9	51	09.98 - 03.02	DW8 / DW8B	4	☑	Y-503J	1009	10	
Partner Combi Hdi		2.0	66	10.99 - 03.02	DW10TD	4	☑	Y-504J	1441	24	
Partner Multispace		1.4	55	01.97 - 12.99	TU3JP-KFX/KFW	4		BKR6EK	2288	20	LPG 1
Partner Multispace		1.4	55	01.00 -	TU3JP-KFX/KFW	4	0,9	BKR6EZ	4619	38	LPG 1
Partner Multispace		1.6	81	02.01 -	TU5JP4-NFU	4	0,9	LFR6B	6677		LPG 7
Partner Multispace		1.8	66	07.97 -	XU7JB-LFX	4		BKR6EK	2288	20	LPG 1
Partner Multispace		1.9	51	01.97 - 09.98	XUD9A	4	☑	Y-924J	7906	1	
Partner Multispace		1.9	51	09.98 -	DW8 / DW8B	4	☑	Y-503J	1009	10	
Partner Multispace Hdi		2.0	66	10.99 -	DW10TD	4	☑	Y-504J	1441	24	

**RCZ**

RCZ 1.6 155 THP		1.6	115	03.10 -	EP6CDT	4	0,8	PLZKBR7A-G	5843		
RCZ 1.6 200 THP		1.6	147	06.10 -	EP6CDTX	4	0,8	ILZKBR7A-8G	5992		
RCZ 2.0 Hdi 165		2.0	120	03.10 -	DW10CTED4	4	☑	Y8001AS	8904	58	

**PIAGGIO**

Porter 1.3i 16V		1.3	48	05.98 -	HC-ES	4		BKUR6EK	2213		
-----------------	--	-----	----	---------	-------	---	--	---------	------	--	--

Code *l* kW

Cyl.



Stock-No.



LPG/CNG

**PORSCHE  
911 SERIE 964**

911 Turbo	964	3.3	236	91 - 92	M30.69	6	0,8	BPR8EIX	6684		BPR9EIX
911 Turbo S	964	3.3	280	92 - 92	M30.69SL	6	0,8	BPR8EIX	6684		BPR9EIX
911 Carrera 2	964	3.6	184	90 - 93	M64.01	6		BCPR7ET	2164		BCPR7EIX
911 Carrera 2	964	3.6	184	90 - 93	M64.02	6		BCPR7ET	2164		BCPR7EIX
911 Carrera 4	964	3.6	184	90 - 93	M64.01	6		BCPR7ET	2164		BCPR7EIX
911 Carrera RS America	964	3.6	184	92 - 92	M64.01	6		BCPR7ET	2164		BCPR7EIX
911 Turbo Look	964	3.6	184	92 - 92	M64.01	6		BCPR7ET	2164		BCPR7EIX
911 Turbo Look	964	3.6	184	92 - 92	M64.02	6		BCPR7ET	2164		BCPR7EIX
911 Carrera RS	964	3.6	191	92 - 92	M64.03	6		BCPR7ET	2164		BCPR7EIX
911 Turbo 3,6	964	3.6	265	93 - 93	M64.50	6		BKR6EK	2288	20	LPG 1

**911 SERIE 993**

911 Carrera 2	993	3.6	184	94 - 95	M64.01	6		BCPR7ET	2164		BCPR7EIX
911 Carrera 2	993	3.6	184	94 - 95	M64.02	6		BCPR7ET	2164		BCPR7EIX
911 Carrera 2 Speedster	993	3.6	184	94 - 94	M64.01	6		BCPR7ET	2164		BCPR7EIX
911 Carrera 2 Speedster	993	3.6	184	94 - 94	M64.02	6		BCPR7ET	2164		BCPR7EIX
911 Carrera 4 Turbo Look	993	3.6	184	94 - 94	M64.01	6		BCPR7ET	2164		BCPR7EIX
911 Carrera	993	3.6	200	93 - 97	M64.07	6		BCPR7ET	2164		BCPR7EIX
911 Carrera	993	3.6	200	93 - 97	M64.08	6		BCPR7ET	2164		BCPR7EIX
911 Carrera	993	3.6	200	93 - 97	M64.23	6		BCPR7ET	2164		BCPR7EIX
911 Carrera	993	3.6	200	93 - 97	M64.24	6		BCPR7ET	2164		BCPR7EIX
911 Carrera	993	3.6	200	94 - 95	M64.05	6		BCPR7ET	2164		BCPR7EIX
911 Carrera	993	3.6	200	94 - 95	M64.06	6		BCPR7ET	2164		BCPR7EIX
911 Carrera 4	993	3.6	200	95 - 95	M64.05	6		BCPR7ET	2164		BCPR7EIX
911 Carrera	993	3.6	210	97 - 97	M64.21	6		BCPR7ET	2164		BCPR7EIX
911 Carrera	993	3.6	210	97 - 97	M64.22	6		BCPR7ET	2164		BCPR7EIX
911 Carrera 4	993	3.6	210	97 - 98	M64.21	6		BCPR7ET	2164		BCPR7EIX
911 Carrera 4 S	993	3.6	210	97 - 98	M64.21	6		BCPR7ET	2164		BCPR7EIX
911 Carrera S	993	3.6	210	97 - 98	M64.21	6		BCPR7ET	2164		BCPR7EIX
911 Carrera S	993	3.6	210	97 - 98	M64.22	6		BCPR7ET	2164		BCPR7EIX
911 Carrera 4s	993	3.6	221	96 - 96	M64.21	6		BCPR7ET	2164		BCPR7EIX
911 Turbo 3.6	993	3.6	265	94 - 94	M64.50	6		BKR6EK	2288	20	LPG 1
911 Turbo Biturbo	993	3.6	300	95 - 97	M64.60	6		BKR6EK	2288	20	LPG 1
911 Turbo 3.6 Biturbo	993	3.6	300	98 - 98	M64.60	6		BKR6EK	2288	20	LPG 1
911 GT2	993	3.6	316	96 - 98	M64.60R	6		BKR6EK	2288	20	LPG 1
911 Carrera	993	3.8	210	96 - 96	M64.05	6		BCPR7ET	2164		BCPR7EIX
911 Carrera	993	3.8	210	96 - 96	M64.06	6		BCPR7ET	2164		BCPR7EIX
911 Carrera 4	993	3.8	210	96 - 96	M64.05	6		BCPR7ET	2164		BCPR7EIX
911 Carrera RS America	993	3.8	221	95 - 96	M64.20	6		BCPR7ET	2164		BCPR7EIX

**911 SERIE 996**

911 Carrera	996	3.4	221	98 - 98	M96.01	6		BKR6EQUIP	3199	30	LPG 1
911 Carrera 2	996	3.4	221	99 - 00	M96.01	6		BKR6EQUIP	3199	30	LPG 1
911 Carrera 4	996	3.4	221	99 - 00	M96.02	6		BKR6EQUIP	3199	30	LPG 1
911 Carrera 2	996	3.4	221	01 - 04	M96.04	6		BKR6EQUIP	3199	30	LPG 1
911 Carrera 4	996	3.4	221	01 - 00	M96.04	6		BKR6EQUIP	3199	30	LPG 1
911 Carrera	996	3.6	235	01 - 03	M96.03	6		BKR7EQUIP	4285		
911 GT3	996	3.6	265	00 - 00	M96.76	6		BKR6EK	2288	20	
911 GT3	996	3.6	280	01 - 04	M96.76/ M 96.79	6	0,7	BKR7EIX	2667		BKR8EIX
911 Turbo	996	3.6	309	01 - 06	M96.70	6		BCPR7ET	2164		BCPR7EIX
911 GT2	996	3.6	340	01 - 04	M96.70S	6		BKR7EKC	7354		



Code *l* kW

Cyl.



Stock-No.

VEMTE

LPG/CNG

**PORSCHE****911 SERIE 997**

911 Carrera	997	3.6	239	04 -	M96.05	6		BKR7EQUIP	4285		
911 Carrera S (997)	997	3.8	261	04 -	M97.01	6		BKR7EQUIP	4285		

**968**

968		3.0	176	08.91 - 11.95	M 44.43/44	4	0,8	BPR6ES	7822	2	LPG 2
968 Turbo S		3.0	224	01.93 - 11.95		4	0,8	BKR6ES	3783	28	LPG 1

**BOXSTER SERIE 986**

Boxster 2.5	986	2.5	150	09.96 - 08.99	M 96.20	6		BKR6EK	2288	20	LPG 1
Boxster 2.7	986	2.7	162	09.99 - 07.02	M 96.22	6		BKR6EQUIP	3199	30	LPG 1
Boxster 2.7	986	2.7	168	07.02 -	M 96.23	6		BKR6EQUIP	3199	30	LPG 1
Boxster S 3.2	986	3.2	185	09.99 - 07.02	M 96.21	6		BKR6EQUIP	3199	30	LPG 1
Boxster S 3.2	986	3.2	191	07.02 -	M 96.24	6		BKR6EQUIP	3199	30	LPG 1

**BOXSTER SERIE 987**

Boxster 2.7	987	2.7	176	12.04 -	M 96.25	6		BKR7EQUIP	4285		
Boxster 2.7	987	2.7	180	07.06 -	M 97.20	6		BKR7EQUIP	4285		
Boxster 2.9	987	2.9	188	08 -	M 96.25 / 20	6		BKR7EQUIP	4285		
Boxster S 3.2	987	3.2	206	09.04 - 08.06	M 96.26	6		BKR7EQUIP	4285		
Boxster S 3.4	987	3.4	217	09.06 -	M 97.21	6		BKR7EQUIP	4285		
Boxster S 3.4	987	3.4	228	08 -	M 97.26 / 21	6		BKR7EQUIP	4285		
Boxster Spyder 3.4	987	3.4	236	08 -	M 97.21	6		BKR7EQUIP	4285		

**CAYENNE SERIE 955**

Cayenne	955	2.5	128	04 -	BAC	5	<input checked="" type="checkbox"/>	Y-741U	6943	20	
Cayenne 3.2	955	3.2	184	10.03 -	M 02.2Y BFD	6	0,9	IZKR7B	7563		IZKR7B
Cayenne S 4.5	955	4.5	250	10.02 -	M 48.00	8		BKR6EQUIP	3199	30	LPG 1
Cayenne Turbo 4.5	955	4.5	331	10.02 -	M 48.50	8		PFR7Q	7963		PFR7Q

**CAYENNE**

Cayenne 3.6		3.6	220	06.10 -	M55.02	6	0,8	ILZKR8A	94290		ILZKR8A
-------------	--	-----	-----	---------	--------	---	-----	---------	-------	--	---------

**CAYMAN SERIE 987**

Cayman 2.7	987 Cayman	2.7	180	09.06 -	M 97.20	6		BKR7EQUIP	4285		
Cayman 2.9	987 Cayman	2.9	195	08 -	M 97.20	6		BKR7EQUIP	4285		
Cayman S 3.4	987 Cayman	3.4	217	11.05 -	M 97.21	6		BKR7EQUIP	4285		
Cayman S 3.4	987 Cayman	3.4	236	08 -	M 97.21	6		BKR7EQUIP	4285		

**PROTON**

1300		1.3		10.92 -	Multipoint	4	0,9	BPR5ES	7422	6	LPG 2
1500		1.5		10.92 -	Multipoint	4	0,9	BPR5ES	7422	6	LPG 2
313		1.3	55	96 -	(Mitsubishi)	4	1,1	BPR5ES-11	4424		LPG 2
315		1.5	64	96 -	(Mitsubishi)	4	1,1	BKR6E-11	2756	14	LPG 1
318 GTI		1.9	100	09.99 -		4	1,1	BKR6E-11	2756	14	LPG 1
413		1.3	55	05.96 -	C96	4	1,1	BPR5ES-11	4424		LPG 2
415		1.5	66	03.95 -	C97	4	1,1	BPR5ES-11	4424		LPG 2
416		1.6	85	03.95 -	C98	4	1,1	BKR6E-11	2756	14	LPG 1
418		1.8	85	05.96 -	C99	4	1,1	BKR6E-11	2756	14	LPG 1
418 LRS		1.8	99	98 -		4	1,1	BKR6E-11	2756	14	LPG 1
Persona		1.5		11.93 -	4G15	4	0,9	BPR5ES	7422	6	LPG 2
Persona		1.6		11.93 -	4G92	4	1,1	BKR6E-11	2756	14	LPG 1
Persona		1.8		09.96 -	4G92	4	1,1	BKR6E-11	2756	14	LPG 1
Satria		1.3		03.00 -		4	0,9	BPR5ES	7422	6	LPG 2

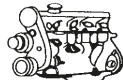
Code *l* kW

Cyl.

Stock-No.  
**V-FLINE**  
10-15-10-15-10-15-10-15

LPG/CNG

**PROTON**

Wira		1.5		03.00 -	4G15	4	1,1	BPR5ES-11	4424		LPG 2
Wira		1.6		05.00 -	4G92	4	1,1	BKR6E-11	2756	14	LPG 1
Wira		1.8		05.00 -		4	1,1	BKR6E-11	2756	14	LPG 1

**RELIANT**

Robin				09.96 -		4	0,8	BCPR5ES	6130	32	LPG 3
-------	--	--	--	---------	--	---	-----	---------	------	----	-------

**RENAULT  
AVANTIME**

Avantime 2.0i 16V Turbo		2.0	121	04.02 - 05.03	F4RT 760/762	4	0,9	PFR6G-9	4377		PFR7G
Avantime 16V Turbo		2.0	121	04.02 - 05.03	F4R 760/761	4	0,8	BKR6EIX	6418		LPG 1
Avantime 2.2 dCi		2.2	110	06.02 - 05.03	G9T 712	4		Y-517J	3319	66	
Avantime 3.0 V6		3.0	154	02.02 - 05.03	L7X 720/721	6	1,1	PLFR5A-11	6240		LPG 7

**CAPTUR**

Captur 1.2 TCe 120		1.2	88	06.13 -	H5F 403	4	0,7	ILKAR7F7G	90061		
Captur 1.5 dCi 90		1.5	66	06.13 -	K9K 830 / 838	4		Y1035AS	94103	77	

**CLIO 1**

Clio		1.1	35	06.90 - 03.96	C1E 700	4	0,8	BP5ES	6511	8	LPG 2
Clio		1.2	40	06.90 - 02.98	E5F 710/716	4	0,8	BCP5ES	7496	16	LPG 3
Clio		1.2	40	06.90 - 02.98	E5F 710/716	4	0,8	BCP5ES	7496	16	LPG 3
Clio		1.2	40	06.90 - 02.98	E7F 706/700	4	0,8	BCP5ES	7496	16	LPG 3
Clio		1.2	40	11.94 - 03.96	C3G 720	4	0,8	BP5ESZ	4691		LPG 2
Clio		1.2	44	01.96 - 06.97	D7F 730	4	0,9	BK5ESZ	5675		
Clio		1.2	44	07.97 - 02.98	D7F 730	4		BKR5EK	7956	23	LPG 1
Clio		1.4	55	06.90 - 02.98	E6J 712 / 713	4	0,8	BCP5ES	7496	16	LPG 3
Clio		1.4	55	06.90 -	E7J 718 / 719	4	0,8	BCP5ES	7496	16	LPG 3
Clio		1.4	55	04.96 -	E7J 754	4	0,8	BCP5ES	7496	16	LPG 3
Clio		1.4	58	06.90 - 02.98	E7J 710 / 711	4	0,8	BCP5ES	7496	16	LPG 3
Clio		1.7	66	06.90 - 03.96	F2N 770	4	0,8	BP7ES	2412		BPR8EIX
Clio		1.8	65	06.90 - 04.96	F3P 710/714	4	0,9	BP6ESZ	7639		LPG 2
Clio		1.8	65	06.96 - 02.98	F3P 755	4	0,9	BP6ESZ	7639		LPG 2
Clio		1.8	66	06.90 - 02.98	F3P	4	0,7	BP6ESZ	7639		LPG 2
Clio RSi		1.8	79	08.94 -	F3P 758 Cat.	4	0,8	BP7ES	2412		BPR8EIX
Clio		1.8	79	08.95 -	F3P R758	4	0,7	BP6ES	7811	4	LPG 2
Clio		1.8	81	02.91 - 04.96	F3P 712	4	0,7	BP6ESZ	7639		LPG 2
Clio 1.8 16V		1.8	100	03.91 - 03.96	F7P 720/722	4		BKR6EKUB	3584		LPG 1
Clio		1.9	48	05.90 - 09.98	F8Q 714/730/732	4		Y-913M	3965	15	
Clio		1.9	48	03.91 - 08.98	F8Q 672/676/ 678/692/696	4		Y-927R	5171	19	
Clio Williams 2.0 16S		2.0	110	12.93 - 01.96	F7R 700	4		BKR6EKUB	3584		LPG 1

**CLIO 2**

Clio 2		1.2	44	03.98 -	D7F 720/722	4		BKR5EK	7956	23	LPG 1
Clio 2		1.2	44	10.99 -	D7F 726	4	0,9	BKR6EZ	4619	38	LPG 1
Clio 2 16V		1.2	55	03.00 -	D4F 712 / 714	4	0,8	LZKAR7A	6799		
Clio 2		1.4	55	03.98 - 03.01	E7J 780	4	0,9	BKR5EZ	7642	36	LPG 1
Clio 2		1.4	55	07.00 - 03	K7J 700/701	4	0,9	BKR5EZ	7642	36	LPG 1
Clio 2		1.4	55	07.00 - 03	K7J 710	4	0,9	BKR5EZ	7642	36	LPG 1
Clio 2 16V		1.4	73	03.98 - 06.00	K4J 712/713	4	0,9	BKR6EZ	4619	38	LPG 1

Code *l* kW

Cyl.



Stock-No.

V6/INE

E-FORWARD\*

LPG/CNG

**RENAULT****CLIO 2**

Clio 2		1.6	66	03.98 - 09.99	K7M 745	4		BKR5EK	7956	23	LPG 1
Clio 2 16V		1.6	66	03.98 - 09.99	K7M 744	4		BKR5EK	7956	23	LPG 1
Clio 2		1.6	81	02.99 -	K4M 748	4	0,9	BKR6EZ	4619	38	LPG 1
Clio 2		1.9	48	03.98 - 12.03	F8Q 630/ 662 BBOEOF	4	█	Y-506J	2419	7	
Clio 2		1.9	48	03.99 - 12.03	F8Q 632	4	█	Y-516J	6416	12	
Clio 2 Dti		1.9	59	01.99 - 12.03	F9Q 716	4	█	Y-740U	4818	22	
Clio 2 Dti		1.9	59	03.99 - 12.03	F9Q 780	4	█	Y-732J	5605	4	
Clio 2 Dti		1.9	59	01.99 - 06.01	F9Q 782	4	█	Y-740U	4818	22	
Clio 2 16V RS		2.0	126	01.00 -	F4R 730	4	1,0	PFR6E-10	3688		

**CLIO 2 PHASE 2**

Clio 2 Phase 2		1.2	44	06.01 -	D7FGPL	4		BKR5EIX	6341		LPG 1
Clio 2 Phase 2 8S		1.2	44	06.01 -	D7F 726	4	0,9	BKR6EZ	4619	38	LPG 1
Clio 2 Phase 2 16S		1.2	55	01.02 -	D4F-712	4	0,8	LZKAR7A	6799		
Clio 2 Phase 2 16S		1.4	72	06.01 -	K4J 710/711	4	0,9	BKR6EZ	4619	38	LPG 1
Clio 2 Phase 2 1.5 Dci		1.5	48	06.01 -	K9K 700/704/710	4	█	Y-732J	5605	4	
Clio 2 Phase 2 1.5 Dci		1.5	50	08.04 -	K9K 714	4	█	Y-732J	5605	4	
Clio 2 Phase 2 1.5 Dci		1.5	59	11.01 -	K9K 702	4	█	Y-732J	5605	4	
Clio 2 Phase 2 1.5 Dci		1.5	60	11.03 - 04.05	K9K 702/710/716	4	█	Y-732J	5605	4	
Clio 2 Phase 2 1.5 Dci		1.5	62	02.07 - 06.09	K9K 718	4	█	Y-732J	5605	4	
Clio 2 Phase 2 1.5 Dci		1.5	74	04 -	K9K 712	4	█	Y-732J	5605	4	
Clio 2 Phase 2 16S		1.6	81	06.01 -	K4M 744/745	4	0,9	BKR6EZ	4619	38	LPG 1
Clio 2 Phase 2 16V RS		2.0	126	06.01 -	F4R 730	4	1,0	PFR6E-10	3688		

**CLIO 3**

Clio 3 1.2 16V		1.2	55	06.05 - 05.07	D4F 740/764	4	0,8	LZKAR7A	6799		
Clio 3 1.2 16V		1.2	55	05.07 -	D4F 722/740/772	4	0,9	LZKAR7B	5942		
Clio 3 1.2 16V Hi-Flex		1.2	55	07.08 -	D4F 740/742	4	0,9	LZKAR7B	5942		
Clio 3 1.2 TCe 100		1.2	74	05.07 -	D4F 780 / 784	4	0,7	ILKAR7A7	91432		
Clio 3 1.4 16V		1.4	70	06.05 -	K4J 780	4	0,9	BKR6EZ	4619	38	LPG 1
Clio 3 1.5 Dci		1.5	47	06.05 -	K9K 752	4	█	Y-732J	5605	4	
Clio 3 1.5 Dci		1.5	48	05.05 - 10.06	K9K 752	4	█	Y-732J	5605	4	
Clio 3 1.5 Dci		1.5	50	06.05 -	K9K 768	4	█	Y-732J	5605	4	
Clio 3 1.5 Dci		1.5	55	08.10 -	K9K 770	4	█	Y1035AS	94103	77	
Clio 3 1.5 Dci		1.5	60	11.07 -	K9K 750	4	█	Y-732J	5605	4	
Clio 3 1.5 Dci		1.5	63	06.05 -	K9K 766	4	█	Y-732J	5605	4	
Clio 3 1.5 Dci		1.5	65	08.10 -	K9K 770	4	█	Y1035AS	94103	77	
Clio 3 1.5 Dci		1.5	76	06.05 -	K9K 772	4	█	Y-732J	5605	4	
Clio 3 1.5 Dci		1.5	78	06.05 -	K9K 764	4	█	Y-732J	5605	4	
Clio 3 1.6 16V		1.6	81	06.05 -	K4M 800/801/804	4	0,9	BKR6EZ	4619	38	LPG 1
Clio 3 1.6 16V		1.6	94	11.07 -	K4M 862	4	0,9	PFR7Z-TG	5768		
Clio 3 2.0 16V		2.0	103	04.06 -	M4R Nissan	4	1,1	PLZKAR6A-11	5118		
Clio 3 2.0 16V RS		2.0	145	02.06 -	F4R 830 / 832	4	0,9	PFR7Z-TG	5768		
Clio 3 2.0 16V RS		2.0	148	09.08 -	F4R 830	4	0,9	PFR7Z-TG	5768		

**CLIO 4**

Clio 4 1.2		1.2	54	10.12 -	D4F 740	4	0,7	ILKAR7A7	91432		
Clio 4 1.2 TCE 120		1.2	88	03.13 -	H5F 403	4	0,7	ILKAR7F7G	90061		
Clio 4 1.5 dCi 75		1.5	55	10.12 -	K9K 612	4	█	Y1035AS	94103	77	
Clio 4 1.5 dCi 90		1.5	66	10.12 -	K9K 608	4	█	Y1035AS	94103	77	
Clio 4 1.6 RS		1.6	147	03.13 -	M5M 400	4	0,9	DILKAR7C9H	91215		

**ESPACE 2**

Espace 2		2.0		04.91 - 10.96	J7R 768 Cat	4	0,8	BP6EFS	3812	5	LPG 5
----------	--	-----	--	---------------	-------------	---	-----	--------	------	---	-------

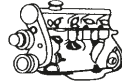
Code *l* kW

Cyl.

Stock-No.  
**VLIVE**  
10-15-10-15-10-15

LPG/CNG

**RENAULT  
ESPACE 2**

Espace 2		2.2	81	04.91 - 10.96	J7T 772 CAT	4	0,7	BP7EFS	3526		
Espace 2		2.2	85	91 - 10.96	G8T 714/716/760	4	█	Y-740U	4818	22	
Espace 2		2.8	113	04.91 - 10.96	Z7W 712/ 717 Cat	6	0,7	BP7EFS	3526		

**ESPACE 3**

Espace 3		2.0	103	09.00 -	F5R	4	1,1	LFR4AP-11	5613		
Espace 3 Dci		1.9	74	02.99 - 12.02	F9Q 722	4	█	Y-732J	5605	4	
Espace 3 Dti		1.9	74	02.99 - 12.02	F9Q 716/730/734	4	█	Y-740U	4818	22	
Grand Espace Dti		1.9	74	01.00 -	F9Q 730/734	4	█	Y-740U	4818	22	
Espace 3		2.0	85	11.96 - 09.00	F3R 728 /729 / 768 /769	4	0,9	BPR5ES	7422	6	LPG 2
Espace 3		2.0	103	10.98 - 10.02	F4R 700 /701	4	0,9	BKR6EZ	4619	38	LPG 1
Espace 3 DT		2.2	81	10.96 - 08.00	G8T 714/716	4	█	Y-730U	6704	17	
Grand Espace DT		2.2	81	01.98 - 08.00	G8T 714/716	4	█	Y-730U	6704	17	
Espace 3 Dci		2.2	85	06.00 - 12.02	G9T 710	4	█	Y-517J	3319	66	
Grand Espace Dci 16S		2.2	85	06.00 - 09.02	G9T 710	4	█	Y-517J	3319	66	
Grand Espace 3 Dci 16S		2.2	95	06.00 - 09.02	G9T 710	4	█	Y-517J	3319	66	
Espace 3 Dci		2.2	96	06.00 - 12.02		4	█	Y-517J	3319	66	
Grand Espace Dci 16S		2.2	96	06.00 - 09.02		4	█	Y-517J	3319	66	
Espace 3 V6		3.0	121	11.96 - 09.98	Z7X 775	6		BKR6EKUB	3584		LPG 1
Espace 3 V6 24 V		3.0	140	10.98 -	L7X 727	6	1,0	PFR6E-10	3688		

**ESPACE 4**

Espace 4 Dci		1.9	86	10.02 -	F9Q	4	█	Y-732J	5605	4	
Grand Espace 4 Dci		1.9	86	10.02 -	F9Q	4	█	Y-732J	5605	4	
Espace 4		2.0	103	10.02 -	F4Rt	4		BKR6EK	2288	20	LPG 1
Espace 4 Turbo		2.0	121	10.02 -	F4R 760	4	0,9	PFR6G-9	4377		PFR7G
Grand Espace 4		2.0	121	03 -	F4R	4	0,9	PFR6G-9	4377		PFR7G
Grand Espace Turbo		2.0	121	03 -	F4R 760/762	4	0,9	PFR6G-9	4377		PFR7G
Espace 4 Turbo		2.0	125	03.05 -	F4R 794/795/ 796/797/896/897	4	0,9	PFR6G-9	4377		PFR7G
Grand Espace 4 Dci		2.2	110	10.02 -		4	█	Y-517J	3319	66	
Espace 4 Dci		2.2	110	03 -	G9T	4	█	Y-517J	3319	66	
Grand Espace Dci		2.2	110	03 -	G9T	4	█	Y-517J	3319	66	
Espace 4		3.5	180	10.02 -	V4Y 711	6	1,1	PLFR5A-11	6240		LPG 7
Grand Espace 4		3.5	180	10.02 -	V4Y 711	6	1,1	PLFR5A-11	6240		LPG 7

**EXPRESS 1**

Express		1.6	40	07.86 - 03.98	F8M 720/730/736/760	4	█	Y-913M	3965	15	
Express		1.9	48	09.91 - 03.98	F8Q 684/722/ 724/774/776	4	█	Y-913M	3965	15	
Express		1.9	48	09.94 - 12.95	F8Q 640/644/646/648	4	█	Y-927R	5171	19	
Express		1.9	48	01.96 - 03.98	F8Q 640/680/682	4	█	Y-927R	5171	19	
Express		1.0		03.86 - 08.91	C1C 706/700	4	0,8	BP5ES	6511	8	LPG 2
Express		1.1	35	06.87 - 10.97	C1E	4	0,8	BP5ES	6511	8	LPG 2
Express		1.4	44	03.86 - 09.91	C1J / C2J	4	0,8	BP5ES	6511	8	LPG 2

**EXPRESS 2**

Express		1.0		10.91 -	C1C	4	0,8	BP5ES	6511	8	LPG 2
Express		1.2	40	10.91 -	C3G 710 Cat.	4	0,9	BP5ESZ	4691		LPG 2
Express		1.2		10.91 - 10.97	C1G	4	0,8	BP5ES	6511	8	LPG 2
Express		1.4	59	10.91 -	E7J Cat.	4	0,8	BCP5ES	7496	16	LPG 3
Express		1.4		10.91 -	E6J	4	0,8	BCP5ES	7496	16	LPG 3

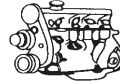
Code *l* kW

Cyl.



Stock-No.

V6/V8

E-POWER

LPG/CNG

**RENAULT****EXPRESS 2**

Express		1.4		08.92 -	C3J 760 Cat.	4	0,9	BPR5ES	7422	6	LPG 2
---------	--	-----	--	---------	--------------	---	-----	--------	------	---	-------

**FLUENCE**

Fluence 1.5 dCi		1.5	63	02.10 -	K9K 830	4	█	Y1035AS	94103	77	
Fluence 1.5 dCi		1.5	66	02.10 -	K9K 834	4	█	Y1035AS	94103	77	
Fluence 1.5 dCi		1.5	78	02.10 -	K9K 832	4	█	Y1035AS	94103	77	
Fluence 1.5 dCi		1.5	81	02.10 -	K9K 836	4	█	Y1035AS	94103	77	
Fluence 1.6 16V		1.6	81	02.10 -	K4M 838/839	4	0,9	BKR6EZ	4619	38	LPG 1
Fluence 2.0 16V		2.0	103	02.10 -	M4R 714/751	4	1,1	PLZKAR6A-11	5118		

**KANGOO**

Kangoo (XCOA)		1.2	44	08.97 - 05.00	D7F 710/720/722/ 726/744/746	4		BKR5EK	7956	23	LPG 1
Kangoo		1.2	44	05.00 -	D7F 710/720/722/ 726 / 744 Euro2000	4	0,9	BKR6EZ	4619	38	LPG 1
Kangoo		1.2	44	05.00 -	D7F 726	4	0,9	BKR6EZ	4619	38	LPG 1
Kangoo		1.2	44	05.00 -	D7FGPL	4		BKR5EIX	6341		LPG 1
Kangoo 16V		1.2	55	07.00 -	D4F 712/714	4	0,8	LZKAR7A	6799		
Kangoo 16V		1.2	55	07 -	D4F 722/740/772	4	0,9	LZKAR7B	5942		
Kangoo (XCOC)		1.4	55	10.97 - 03.99	E7J 634/635/780	4	0,9	BKR6EZ	4619	38	LPG 1
Kangoo		1.4	55	07.00 -	K7J 700/701	4	0,9	BKR5EZ	7642	36	LPG 1
Kangoo 1.5 Dci		1.5	42	12.02 -	K9K 704	4	█	Y-732J	5605	4	
Kangoo 1.5 Dci		1.5	48	06.01 -	K9K 700/704	4	█	Y-732J	5605	4	
Kangoo 1.5 Dci		1.5	50	06.05 -	K9K 714	4	█	Y-732J	5605	4	
Kangoo 1.5 Dci		1.5	50	02.08 -	K9K 840	4	█	Y-732J	5605	4	
Kangoo 1.5 Dci		1.5	60	07.02 -	K9K 702/710	4	█	Y-732J	5605	4	
Kangoo 1.5 Dci		1.5	62	06.05 -	K9K 718	4	█	Y-732J	5605	4	
Kangoo 1.5 Dci		1.5	63	02.08 -	K9K 800/802	4	█	Y-732J	5605	4	
Kangoo		1.6	70	07.01 -	K7M 746	4		BKR5EK	7956	23	LPG 1
Kangoo 16V		1.6	70	07.01 -	K4M 708/750/752	4	0,9	BKR6EZ	4619	38	LPG 1
Kangoo 2 4X4		1.6	70	03 -	K4M	4	0,9	BKR6EZ	4619	38	LPG 1
Kangoo Express D		1.9	40	03.98 -	F8Q 662	4	█	Y-506J	2419	7	
Kangoo Express D		1.9	48	03.98 -	F8Q 630	4	█	Y-506J	2419	7	
Kangoo Express D		1.9	48	03.99 -	F8Q 632	4	█	Y-516J	6416	12	
Kangoo Dti		1.9	59	03.98 -	F9Q 780	4	█	Y-732J	5605	4	
Kangoo Dci 4X4		1.9	59	11.01 -		4	█	Y-732J	5605	4	
Kangoo Express Dci		1.5	48	07.03 -	K9K	4	█	Y-732J	5605	4	
Kangoo Express Dci		1.5	59	04 -	K9K	4	█	Y-732J	5605	4	
Kangoo Express Dci		1.9	62	04 -	F9Q	4	█	Y-732J	5605	4	

**KOLEOS**

Koleos 2.5		2.5	125	06.08 -	2TR700/702/703	4	1,1	DILKAR6A11	9029		
------------	--	-----	-----	---------	----------------	---	-----	------------	------	--	--

**LAGUNA 1**

Laguna / Nevada		1.8	66	01.94 - 12.00	F3P 670/674/676/678	4	0,9	BP6ESZ	7639		LPG 2
Laguna / Nevada		1.8	70	01.94 - 12.00	F3P 720/724	4	0,9	BP6ESZ	7639		LPG 2
Laguna / Nevada		1.9	103	03.94 - 12.00	N7Q 700	4		BKR5EK	7956	23	LPG 1
Laguna / Nevada		2.0	83	01.94 - 03.01	F3R 722/723	4	0,9	BP6ESZ	7639		LPG 2
Laguna / Nevada D		2.2	62	09.94 -	G8T	4	█	Y-730U	6704	17	
Laguna / Nevada DT		2.2	85	03.96 -	G8T Turbo	4	█	Y-730U	6704	17	
Laguna 2		2.2	110	01.02 -	G9T 702	4	█	Y-517J	3319	66	
Laguna / Nevada		3.0	123	04.94 - 05.96	Z7X 760/765/767	6		BKR6EKUB	3584		LPG 1

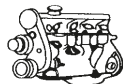

Code  $\ell$  kW

Cyl.



Stock-No.

VLINE

RE-POWER

LPG/CNG

**RENAULT  
LAGUNA 1**

Laguna / Nevada		3.0	143	06.96 - 04.98	L7X 700/701 (980511→)	6	1,0	PFR6E-10	3688		
Laguna / Nevada		3.0		09.96 - 04.98	L7X 700/701 (→980511)	6		BKR6EKC	2848	26	LPG 1

**LAGUNA 1 PHASE 2**

Laguna / Nevada Phase 2		1.6	81	04.98 - 12.00	K4M 720/724	4		BKR5EK	7956	23	LPG 1
Laguna / Nevada Phase 2		1.8	88	09.98 - 12.00	F4P 760	4	0,8	BKR6ES	3783	28	LPG 1
Laguna / Nevada Phase2 Dti		1.9	74	10.97 -	F9Q 716/730/734	4	☑	Y-740U	4818	22	
Laguna / Nevada Phase 2		1.9	75	10.97 - 02.01	F9Q 716	4	☑	Y-740U	4818	22	
Laguna / Nevada Phase 2		1.9	75	02.99 - 02.01	F9Q 710	4	☑	Y-732J	5605	4	
Laguna / Nevada Phase 2		2.0	85	04.98 - 08.98	F3R	4	0,8	BPR6ES	7822	2	LPG 2
Laguna / Nevada Phase 2		2.0	103	02.99 - 12.00	F4R 780	4	0,8	BKR6ES	3783	28	LPG 1
Laguna / Nevada Phase2 DT		2.2	80	04.98 -	G8T Turbo	4	☑	Y-730U	6704	17	
Laguna / Nevada Phase 2		3.0	143	05.98 - 12.00	L7X 700/701	6	1,0	PFR6E-10	3688		

**LAGUNA 2**

Laguna 2 1.6 16V		1.6	81	01.01 -	K4M 720	4	0,9	BKR6EZ	4619	38	LPG 1
Laguna 2 1.8 16V		1.8	87	01.01 -	K4M 720	4	0,8	BKR6ES	3783	28	LPG 1
Laguna 2 1.8 16V		1.8	87	01.01 -	F4P 760	4	0,8	BKR6ES	3783	28	LPG 1
Laguna 2 1.9 Dci		1.9	68	10.03 - 05.05	F9Q 664	4	☑	Y-732J	5605	4	
Laguna 2 1.9 Dci		1.9	74	03.99 -	F9Q 710/717/718	4	☑	Y-732J	5605	4	
Laguna 2 1.9 Dci		1.9	77	06.01 - 05.05	F9Q 752	4	☑	Y-732J	5605	4	
Laguna 2 1.9 Dci		1.9	81	03.01 -		4	☑	Y-732J	5605	4	
Laguna 2 1.9 Dci		1.9	81	01.05 - 08.07	F9Q 758/674	4	☑	Y-732J	5605	4	
Laguna 2 1.9 Dci		1.9	88	01.01 -	F9QC 750	4	☑	Y-732J	5605	4	
Laguna 2 1.9 Dci		1.9	96	03.05 - 12.07	F9Q 758/759	4	☑	Y-732J	5605	4	
Laguna 2 2.0 16 V		2.0	100	04 -	F4R atmo	4	0,9	BKR6EZ	4619	38	LPG 1
Laguna 2 2.0 16V IDE		2.0	103	09.01 -	F5R 700	4	1,1	LFR4AP-11	5613		
Laguna 2 2.0 Turbo		2.0	120	01.03 - 03.05	F4R 764 / 765	4	0,9	PFR6G-9	4377		PFR7G
Laguna 2 2.0 Turbo		2.0	121	03 -	F4RT 762	4	0,9	PFR6G-9	4377		PFR7G
Laguna 2 2.0 Turbo		2.0	125	03.05 - 12.07	F4R 784	4	0,9	PFR7Z-TG	5768		
Laguna 2 2.0 Turbo		2.0	125	03.05 - 12.07	F4R 786 / 787	4	0,9	PFR6G-9	4377		PFR7G
Laguna 2 2.0 Turbo		2.0	150	03.05 - 08.07	F4R 886	4	0,9	PFR6G-9	4377		PFR7G
Laguna 2 2.0 Turbo		2.0	150	03.05 - 08.07	F4R 887	4	0,9	PFR7Z-TG	5768		
Laguna 2 2.2 dCi 115		2.2	85	04.04 - 10.05	G9T 600	4	☑	Y-517J	3319	66	
Laguna 2 2.2 dCi 140		2.2	102	04.04 -	G9T 706 / 707	4	☑	Y-517J	3319	66	
Laguna 2 2.2 dCi 150		2.2	110	01.02 -	G9T 710	4	☑	Y-517J	3319	66	
Laguna 2 3.0 V6 24V		3.0	152	01.01 - 12.07	L7X 731	6	1,1	PLFR5A-11	6240		LPG 7
Laguna 2 3.0 V6 24V		3.0	155	01.01 - 12.07	L7X	6	1,1	PLFR5A-11	6240		LPG 7

**LAGUNA 3**

Laguna 3 1.5 Dci		1.5	80	10.07 -	K9K 780	4	☑	Y-732J	5605	4	
Laguna 3 1.6 16V		1.6	85	02.07 -	K4M	4	0,9	BKR6EZ	4619	38	LPG 1
Laguna 3 2.0 16V		2.0	100	02.07 -	F4R	4	0,9	BKR6EZ	4619	38	LPG 1
Laguna 3 2.0 16V		2.0	103	02.07 -	M4R 704 / 726	4	1,1	PLZKAR6A-11	5118		PLZKAR6A-11
Laguna 3 2.0 Turbo		2.0	121	02.07 -	F4R 762	4	0,9	PFR6G-9	4377		PFR7G
Laguna 3 2.0 Turbo		2.0	125	09.07 -	F4R 811 / 813	4	0,9	PFR6G-9	4377		PFR7G
Laguna 3 2.0 GT Turbo		2.0	150	03.08 -	F4R 800	4	0,9	PFR7Z-TG	5768		

**LOGAN**

Logan (X90)		1.4	55	05 -	K7J	4	0,9	BKR6E	6962	28	LPG 1
Logan (X90)		1.6	66	05 -	K7M	4	0,9	BKR6E	6962	28	LPG 1

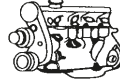
Code *l* kW

Cyl.



Stock-No.

VEFINE

E-POWER

LPG/CNG

**RENAULT****MASTER**

Master T28 , T33 , T35				07.98 -		4	Y-502R	3852		
Master Dci		1.9	59	06.00 -	F9Q 770	4	Y-732J	5605	4	
Master D T30		2.1	45	11.81 - 96	852	4	Y-924J	7906	1	
Master Dci 16S		2.2	66	05.01 -	G9T 720 / 722 / 750	4	Y-517J	3319	66	
Master Dci		2.2	85	00 -	G9T 710	4	Y-517J	3319	66	
Master D T 30		2.4	52	06.82 - 96	8140 / S8U	4	Y-924J	7906	1	
Master Turbo D T35		2.5	55	06.82 - 96	S9U	4	Y-924J	7906	1	
Master D		2.5	59	07.98 -	S8U 770/772	4	Y-910J	3617	3	
Master D		2.5	69	09.97 -	S8V 748	4	Y-910J	3617	3	
Master 2.5 dCi 100 T28, T33, T35		2.5	73	10.03 -	G9U 754	4	Y-517J	3319	66	
Master 2.5 dCi 100 T28, T33, T35		2.5	74	08.06 -	G9U 754	4	Y-517J	3319	66	
Master 2.5 Dci 115 T28, T35, T39		2.5	84	10.01 -	G9U 720 / 750	4	Y-517J	3319	66	
Master 2.5 Dci 120 T28, T35, T39		2.5	88	08.06 -	G9U 650	4	Y-517J	3319	66	
Master 2.5 Dci 150 T28, T35, T39		2.5	107	08.06 -	G9U 632	4	Y-517J	3319	66	
Master Dti		2.8	85	09.97 -	S9W 700/702	4	Y-502R	3852		
Master Dci		3.0	96	01.07 -	ZD30CDTi	4	Y-522J	5939		

**MEGANE 1**

Mégane		1.8	88	10.00 - 09.03	F4P-720 / 722	4	1,1	BKR6E-11	2756	14	LPG 1
Mégane / Classic		1.4	51	10.95 - 03.99	E7J 624	4	0,8	BCP5ES	7496	16	LPG 3
Mégane / Classic		1.4	55	10.95 - 03.99	E7J 764	4	0,8	BCP5ES	7496	16	LPG 3
Mégane / Classic		1.6	66	10.95 - 10.98	K7M 702/703/720	4	0,8	BCPR5ES	6130	32	LPG 3
Mégane Coupé / cabrio		1.6	66	10.95 - 10.98	K7M 702/703	4	0,8	BCPR5ES	6130	32	LPG 3
Mégane / Classic GPL		1.6	66	07.97 - 04.99	K7M 702	4	0,6	BKR5EIX	6341		LPG 1
Mégane / Classic		1.6	66	10.98 - 04.99	K7M 702/703/720	4	0,9	BKR5EZ	7642	36	LPG 1
Mégane Coupé / cabrio		1.6	66	10.98 - 03.99	K7M 702/703	4	0,9	BKR5EZ	7642	36	LPG 1
Mégane / Classic D		1.9	48	01.96 -	F8Q 620/624	4		Y-927R	5171	19	
Mégane / Classic D		1.9	48	03.98 -	F8Q 788	4		Y-506R	4409	7	
Mégane / Classic D		1.9	48	03.99 - 02.01	F8Q 622	4		Y-516J	6416	12	
Mégane 1.9 Dti		1.9	59	02.01 -	F9Q 744	4		Y-732J	5605	4	
Mégane / Classic Di		1.9	66	01.96 - 08.99	F9Q 730/734	4		Y-740U	4818	22	
Mégane / Classic DT		1.9	66	01.96 -	F8Q 784/786	4		Y-933J	7947	25	
Mégane / Classic Dti		1.9	74	01.96 -	F9Q 716/730/734	4		Y-740U	4818	22	
Mégane / Classic Dci		1.9	77	03.99 -	F9Q 731/732/736/740	4		Y-732J	5605	4	
Mégane / Classic		2.0	85	10.95 - 03.99	F3R 750/751/791, 796, 797, 798	4	0,9	BPR5ES	7422	6	LPG 2
Mégane Coupé / cabrio		2.0	85	10.95 - 03.99	F3R 750/751/791, 796, 797, 798	4	0,9	BPR5ES	7422	6	LPG 2
Mégane / Classic		2.0	110	10.95 - 03.99	F7R 710/714	4		BKR6EKUB	3584		LPG 1
Mégane Coupé / cabrio		2.0	110	10.95 - 03.99	F7R 710/714	4		BKR6EKUB	3584		LPG 1

**MEGANE 1 PHASE 2**

Mégane / Classic Phase 2		1.4	55	04.99 -	E7J 626	4	0,8	BKR6ES	3783	28	LPG 1
Mégane / Classic Phase 2		1.4	70	09.99 -	K4J 750	4	0,9	BKR6EZ	4619	38	LPG 1
Mégane Coupé / cab. phase 2		1.4	70	09.99 -	K4J 750	4	0,9	BKR6EZ	4619	38	LPG 1
Mégane / Classic Phase 2		1.6	66	04.99 -	K7M 704	4		BKR5EK	7956	23	LPG 1
Mégane / Classic Phase 2		1.6	81	04.99 -	K4M 700/701/704, 706	4	0,9	BKR6EZ	4619	38	LPG 1
Mégane Coupé / cab. phase 2		1.6	81	04.99 -	K4M 700/701	4	0,9	BKR6EZ	4619	38	LPG 1
Mégane Coupé / cab. phase 2		1.8	87	05.01 -	F4P 760	4	0,8	BKR6ES	3783	28	LPG 1
Mégane Phase 2 D		1.9	48	09.99 -	F8Q 620/624	4		Y-927R	5171	19	
Mégane Phase 2 D		1.9	48	03.99 -	F8Q 622/790	4		Y-516J	6416	12	

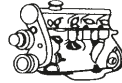
Code *l* kW

Cyl.

Stock-No.  
**VELINE**  
10-17-19-20-21-22-23-24-25-26-27-28-29-30-31-32-33-34-35-36-37-38-39-40-41-42-43-44-45-46-47-48-49-50-51-52-53-54-55-56-57-58-59-60-61-62-63-64-65-66-67-68-69-70-71-72-73-74-75-76-77-78-79-80-81-82-83-84-85-86-87-88-89-90-91-92-93-94-95-96-97-98-99-100-101-102-103-104-105-106-107-108-109-110-111-112-113-114-115-116-117-118-119-120-121-122-123-124-125-126-127-128-129-130-131-132-133-134-135-136-137-138-139-140-141-142-143-144-145-146-147-148-149-150-151-152-153-154-155-156-157-158-159-160-161-162-163-164-165-166-167-168-169-170-171-172-173-174-175-176-177-178-179-180-181-182-183-184-185-186-187-188-189-190-191-192-193-194-195-196-197-198-199-200

LPG/CNG

**RENAULT  
MEGANE 1 PHASE 2**

Mégane Phase 2 Dti		1.9	59	04.01 -	F9QT 770	4		Y-732J	5605	4	
Mégane Phase 2 Dti		1.9	74	01.96 -	F9Q 716/730/734	4		Y-740U	4818	22	
Mégane Phase 2 Dci		1.9	77	03.99 -	F9Q 718/722/731/ 736/780	4		Y-732J	5605	4	
Mégane IDE Coupé Cab. Phase 2 2.0 16V Ide		2.0	103	11.99 -	F5R 740	4	1,1	LFR4AP-11	5412		

**MEGANE 2**

Mégane 2		1.4	70	03 -	K4J 730	4	0,9	BKR6EZ	4619	38	LPG 1
Mégane 2 Coupé / cab 16 V		1.4	72	03 -	K4J	4	0,9	BKR6EZ	4619	38	LPG 1
Mégane 2 1.5 Dci		1.5	59	09.02 -	K9K 722	4		Y-732J	5605	4	
Mégane 2 1.5 Dci Berline		1.5	59	09.03 -	K9K 722	4		Y-732J	5605	4	
Mégane 2 1.5 Dci Break		1.5	59	09.03 -	K9K 722	4		Y-732J	5605	4	
Mégane 2 1.5 Dci		1.5	63	05.05 - 02.08	K9K 724	4		Y-732J	5605	4	
Mégane 2 Coupé		1.5	74	04 -	K9K	4		Y-732J	5605	4	
Mégane 2 1.5 Dci		1.5	76	05.05 - 07.09	K9K 728	4		Y-732J	5605	4	
Mégane 2 1.5 Dci		1.5	78	05.05 - 07.09	K9K 732/734	4		Y-732J	5605	4	
Mégane 2 1.6 Flex Fuel		1.6	77	02.08 - 07.09	K4M	4	1,0	BKR6EZ	4619	38	LPG 1
Mégane 2		1.6	85	03 -	K4M 760	4	0,9	BKR6EZ	4619	38	LPG 1
Mégane 2 Coupé / cab 16V		1.6	85	03 -	K4M	4	0,9	BKR6EZ	4619	38	LPG 1
Mégane 2 1.9 Dci		1.9	81	05.05 -	F9Q 803/804/818	4		Y-732J	5605	4	
Mégane 2 1.9 Dci		1.9	85	11.02 - 03.09	F9Q 804/816/818	4		Y-732J	5605	4	
Mégane 2 Coupe Dci		1.9	88	09.02 -	F9Q 800	4		Y-732J	5605	4	
Mégane 2 1.9 Dci		1.9	96	05.05 -	F9Q 803/816	4		Y-732J	5605	4	
Mégane 2		2.0	100	03 -	F4R	4	0,9	BKR6EZ	4619	38	LPG 1
Mégane 2 Coupé / cab		2.0	100	03 -	F4R	4	0,9	BKR6EZ	4619	38	LPG 1
Mégane 2		2.0	121	05 -	F4R 762/776	4	0,9	PFR6G-9	4377		PFR7G
Mégane 2 2.0 Renault Sport		2.0	165	05.04 - 10.09	F4R 774	4	0,9	PFR7Z-TG	5768		
Mégane 2 2.0 Renault Sport		2.0	169	08.06 - 02.08	F4R 774	4	0,9	PFR7Z-TG	5768		
Mégane 2 RS		2.0	147	06 -	F4R 830	4		PFR7Z-TG	5768		
Mégane 2 RS		2.0	165	03.04 - 07	F4RT 774	4	0,9	PFR7G-9	4371		
Mégane 2 RS		2.0	169	07 -	F4RT 774	4		PFR7Z-TG	5768		

**MEGANE 3**

Mégane 3 1.2 TCe 115		1.2	85	03.12 -	H5F 400	4	0,7	ILKAR7F7G	90061		
Mégane 3 1.4 TCe 130		1.4	96	06.09 -	H4J 700	4	0,7	ILKAR7A7	91432		
Mégane 3 1.5 dCi		1.5	63	12.09 -	K9K 830	4		Y1035AS	94103	77	
Mégane 3 1.5 dCi		1.5	66	11.08 -	K9K 834	4		Y1035AS	94103	77	
Mégane 3 1.5 dCi		1.5	78	02.09 -	K9K 832	4		Y1035AS	94103	77	
Mégane 3 1.5 dCi		1.5	81	02.09 -	K9K 836	4		Y1035AS	94103	77	
Mégane 3 1.6 16V		1.6	74	11.08 -	K4M 812 / 848	4	0,9	BKR6EZ	4619	38	LPG 1
Mégane 3 1.6 16V		1.6	81	11.08 -	K4M 858	4	0,9	BKR6EZ	4619	38	LPG 1
Mégane 3 1.9 dCi		1.9	96	06.08 -	F9Q 870 / 872	4		Y1036AS	96062		
Mégane 3 2.0 CVT		2.0	103	02.09 -	M4R 711 / 713	4	1,1	PLZKAR6A-11	5118		
Mégane 3 2.0 Tce 180		2.0	132	11.08 -	F4R 870 / 872	4	0,9	PFR6G-9	4377		PFR7G
Mégane 3 RS		2.0	184	11.09 -	F4R 874	4	0,8	IFR7X8G	95820		
Mégane RS		2.0	169	07 -	F4RT 774	4		PFR7Z-TG	5768		

**MEGANE SCENIC**

Mégane Scenic		1.9	48	10.96 - 08.99	F8Q 620/624	4		Y-927R	5171	19	
Mégane Scenic		1.9	48	03.98 -	F8Q 788	4		Y-506J	2419	7	
Mégane Scenic		1.9	48	03.99 -	F8Q 622/790	4		Y-516J	6416	12	

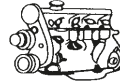
Code *l* kW

Cyl.

Stock-No.  
**VEFINE****B-FORMER**  
LPG/CNG**RENAULT****MEGANE SCENIC**

Mégane Scenic		1.9	66	01.96 -	F8Q 784/786	4	☑	Y-933J	7947	25	
Mégane Scenic Di		1.9	66	10.96 - 08.99	F9Q 716/730/734	4	☑	Y-740U	4818	22	
Mégane Scenic Dti		1.9	74	01.96 -	F9Q 716/730/734	4	☑	Y-740U	4818	22	

**MODUS**

Modus 16 V		1.2	55	09.04 - 05.07	D4F	4	0,8	LZKAR7A	6799		
Modus		1.2	55	06.07 -	D4F 722/740/772	4	0,9	LZKAR7B	5942		
Modus TCe 100		1.2	74	05.07 -	D4F 780/784	4	0,7	ILKAR7A7	91432		
Modus 16 V		1.4	72	09.04 -	K4M	4	0,9	BKR6EZ	4619	38	LPG 1
Modus 1.5 Dci		1.5	48	09.04 -	K9K 752	4	☑	Y-732J	5605	4	
Modus 1.5 Dci		1.5	50	12.04 -	K9K 768	4	☑	Y-732J	5605	4	
Modus 1.5 Dci 75		1.5	55	10.10 -	K9K 770	4	☑	Y1035AS	94103	77	
Modus 1.5 Dci		1.5	60	09.04 -	K9K 750	4	☑	Y-732J	5605	4	
Modus 1.5 Dci		1.5	63	12.04 -	K9K 766	4	☑	Y-732J	5605	4	
Modus 1.5 Dci 90		1.5	65	10.10 -	K9K 770	4	☑	Y1035AS	94103	77	
Modus 1.5 Dci		1.5	76	05.07 -	K9K 772	4	☑	Y-732J	5605	4	
Modus 1.5 Dci		1.5	78	05.05 -	K9K 764	4	☑	Y-732J	5605	4	
Modus 1.6		1.6	65	12.04 -	K4M 792/794	4	0,9	BKR6EZ	4619	38	LPG 1
Modus 1.6		1.6	82	09.04 -	K4J	4	0,9	BKR6EZ	4619	38	LPG 1

**R 5**

R 5		1.0	30	10.84 - 12.96	C1C-700	4	0,7	BP6ES	7811	4	LPG 2
R 5		1.2	40	10.86 - 12.96	C1G 720/722	4	0,7	BP6ES	7811	4	LPG 2
R 5		1.4	43	10.84 - 12.96	C1J 768	4	0,7	BP6ES	7811	4	LPG 2
R 5		1.4	44	10.84 - 12.96	C3J 700/702/760	4	0,9	BPR5ES	7422	6	LPG 2
R 5		1.4	44	06.87 - 12.96	C2J 784	4	0,7	BP6ES	7811	4	LPG 2
R 5		1.4	49	10.84 - 12.96	C2J 780/781/782	4	0,7	BP6ES	7811	4	LPG 2
R 5		1.4	49	10.84 - 12.96	C2J 788/789/798	4	0,7	BP6ES	7811	4	LPG 2
R 5		1.4	50	06.87 - 12.96	C2J 700	4	0,7	BP6ES	7811	4	LPG 2
R 5 Turbo		1.4	77	10.84 - 12.96	C1J 782/784	4	0,7	BR8EIX	5044		BR9EIX
R 5		1.7	55	10.86 - 12.96	F3N 716/717	4	0,8	BPR6ES	7822	2	LPG 2
R 5		1.7	66	06.87 - 12.96	F2N 740/742	4	0,7	BP6ES	7811	4	LPG 2
R 5		1.7	69	10.86 - 12.96	F3N 702	4	0,8	BP7ES	2412		BPR8EIX

**R 19**

R 19		1.2	40	09.88 - 30.92	C1G 730	4	0,9	BP5ESZ	4691		LPG 2
R 19		1.4	43	09.88 - 03.92	C1J 742, C2J 772	4	0,9	BP5ESZ	4691		LPG 2
R 19		1.4	50	09.88 - 03.92	C2J 776	4	0,8	BP5ES	6511	8	LPG 2
R 19		1.4	59	09.88 - 03.92	E6J...,E7J.... Cat.	4	0,8	BCP5ES	7496	16	LPG 3
R 19		1.7	54	03.86 -	F3N-740/741	4	0,8	BPR6ES	7822	2	LPG 2
R 19		1.7	55	09.88 - 03.92	F2N-724	4	0,8	BP7ES	2412		BPR8EIX
R 19		1.7	66	09.88 - 03.92	F3N 746	4	0,8	BPR6ES	7822	2	LPG 2
R 19		1.7	66	09.88 - 03.92	F3N-742/743 Cat	4	0,8	BP7ES	2412		BPR8EIX
R 19		1.7	68	09.88 - 03.92	F2N 720/721	4	0,8	BP7ES	2412		BPR8EIX
R 19		1.8	54	94 -	F3N 740 / 741	4	0,8	BPR6ES	7822	2	LPG 2
R 19		1.8	81	06.89 - 03.92	F7P 700 Cat.	4		BKR6EKUB	3584		LPG 1
R 19 16V		1.8		06.89 - 03.92	F7P 704 Cat.	4	0,7	BCP6ES	4930	17	LPG 3
R 19 D		1.9	48	03.91 - 12.95	F8Q 706/742/764	4	☑	Y-913M	3965	15	
R 19 TD		1.9	66	09.90 - 06.96	F8Q 610/740/744/768	4	☑	Y-933J	7947	25	

**R 19 PHASE 2**

R 19 Phase 2		1.2	40	04.92 - 12.95	C1G 730	4	0,8	BP5ESZ	4691		LPG 2
--------------	--	-----	----	---------------	---------	---	-----	--------	------	--	-------

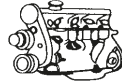
Code *l* kW

Cyl.



Stock-No.



LPG/CNG

**RENAULT  
R 19 PHASE 2**

R 19 Phase 2		1.2	45	04.92 - 12.95	E7F 730 Cat	4	0,8	BCP5ES	7496	16	LPG 3
R 19 Phase 2		1.4	44	04.92 - 12.95	C3J 710 Cat.	4	0,9	BPR5ES	7422	6	LPG 2
R 19 Phase 2		1.4	55	04.92 - 12.95	E7J 706	4	0,8	BCP5ES	7496	16	LPG 3
R 19 Phase 2		1.4	55	04.92 - 12.95	E7J 745	4	0,8	BCP5ES	7496	16	LPG 3
R 19 Phase 2		1.4		04.92 - 12.95	C1J	4	0,8	BP5ESZ	4691		LPG 2
R 19 Phase 2		1.4		04.92 - 12.95	E6J...,E7J.... Cat.	4	0,8	BCP5ES	7496	16	LPG 3
R 19 Phase 2		1.8	70	04.92 - 12.95	F3P 704/706 Cat.	4	0,7	BP6ES	7811	4	LPG 2
R 19 Phase 2		1.8	99	04.92 - 12.95	F7P 704 Cat.	4		BKR6EKUB	3584		LPG 1
R 19 Phase 2		1.8		04.92 - 12.95	F3P 705	4	0,7	BP6ES	7811	4	LPG 2
R 19 Phase 2		1.8		04.92 - 12.95	F3P 707	4	0,7	BP6ES	7811	4	LPG 2
R 19 Phase 2		1.8		04.92 - 12.95	F7P 700 Cat.	4	0,9	BP6ESZ	7639		LPG 2

**R 21**

R 21		1.4	51	09.89 - 10.93	C2J	4	0,7	BP6ES	7811	4	LPG 2
R 21 Nevada		1.7	65	03.86 - 12.95	F2N 711	4	0,8	BP7ES	2412		BPR8EIX
R 21 Nevada		1.7	65	02.88 - 12.95	F2N 754	4	0,8	BP7ES	2412		BPR8EIX
R 21		1.7		09.89 - 12.95	F3N 726	4	0,8	BPR6ES	7822	2	LPG 2
R 21 Nevada		1.7		09.89 - 12.95	F3N 722/723	4	0,8	BP7ES	2412		BPR8EIX
R 21 D / Nevada		1.9	48	03.91 - 95	F8Q 710	4	█	Y-924J	7906	1	
R 21		2.0	66	08.86 - 12.95	F2R 702	4	0,8	BP7ES	2412		BPR8EIX
R 21		2.0	76	03.86 - 12.95	J6R	4	0,8	BP6EFS	3812	5	LPG 5
R 21 Nevada		2.0	98	05.89 - 12.95	J7R 754	4		BCP6ET	4563		LPG 3
R 21		2.0	99	06.90 - 12.93	J7R 746/747	4	0,8	BP6EFS	3812	5	LPG 5
R 21 Nevada		2.0	110	09.89 - 12.95	J7R 740	4		BCP6ET	4563		LPG 3
R 21 D / Nevada		2.1	53	09.89 - 12.93	J8S	4	█	Y-924J	7906	1	
R 21 TD / Nevada		2.1	65	03.86 - 12.93	J8S	4	█	Y-924J	7906	1	
R 21 Nevada		2.2	79	01.93 -	J7T 754/755	4	0,9	BP7EFS	3526		

**R 25**

R 25		2.0	74	01.84 - 12.92	J6R 706/707	4	0,8	BP6EFS	3812	5	LPG 5
R 25		2.0	74	01.84 - 12.92	J6R 762/763	4	0,8	BP6EFS	3812	5	LPG 5
R 25		2.0	88	06.87 - 12.92	J7R 722/723	4	0,9	BP7EFS	3526		
R 25		2.0	103	10.88 - 12.92	J7R 720/721/726	4		BCP6ET	4563		LPG 3
R 25 D		2.1	47	01.84 - 12.92	J8S 736	4	█	Y-924J	7906	1	
R 25 TD		2.1	63	01.84 - 12.92	J8S 708/738	4	█	Y-924J	7906	1	
R 25		2.2	79	10.86 - 12.92	J7T706/707/730/ 731/732/733	4	0,9	BP7EFS	3526		
R 25 V6		2.8	110	06.87 - 12.92	Z7W 700/701	6	0,9	BP7EFS	3526		
R 25 V6		2.8	110	06.87 - 12.92	Z7W 706/707 Cat.	6	0,9	BP7EFS	3526		

**RAPID**

Rapid 1,4		1.4		91 -		4	0,8	BCP5ES	7496	16	LPG 3
Rapid Express		1.9	34	09.94 -	F8Q 640	4	█	Y-927R	5171	19	
Rapid		1.9		03.86 -		4	█	Y-913M	3965	15	

**SAFRANE**

Safrane		1.9			N7Q 716	4		BKR6EKUB	3584		LPG 1
Safrane		1.9		06.92 - 09.96	N7Q 710/ 711	4		BKR6EKUB	3584		LPG 1
Safrane		2.0	77	06.92 - 09.96	J7R 723/733	4	0,8	BP6EFS	3812	5	LPG 5
Safrane		2.0	97	04.92 - 09.96	J7R 734/735/738/739	4		BCP6ET	4563		LPG 3
Safrane DT		2.1	65	06.92 - 09.96	J8S 760	4	█	Y-924J	7906	1	
Safrane		2.2	103	06.92 - 09.96	J7T 760/761	4		BCP6ET	4563		LPG 3
Safrane		2.2		06.92 - 09.96	J7T 762	4	0,8	BP6EFS	3812	5	LPG 5



Code *l* kW

Cyl.



Stock-No.

V6

E-POWER

LPG/CNG

**RENAULT****SAFRANE**

Safrane DT		2.5	83	03.93 - 09.96	S8U 762/763	4	☑	Y-924J	7906	1	
Safrane V6		3.0	123	10.96 -	Z7X W755	6		BKR6EK	2288	20	LPG 1
Safrane V6		3.0	125	06.92 - 09.96	Z7X 721/722/723/ 753/755	6		BKR6EKUB	3584		LPG 1
Safrane Biturbo		3.0	194	94 - 09.96	Z7X 726	6		BKUR7ET	7873		

**SAFRANE PHASE 2**

Safrane Phase 2		1.9	100	10.96 - 12.00	N7Q 710/711	4		BKR5EK	7956	23	LPG 1
Safrane Phase 2 DT		2.2	85	10.96 - 11.00	G8T 740	4	☑	Y-730U	6704	17	
Safrane Phase 2		2.5	121	10.96 - 12.00	N7U 700/701	6	0,8	BCPR6ES	2330	12	LPG 3
Safrane Phase 2 V6		3.0	125	10.96 - 03.99	Z7X 721/722/723/ 753/755	6		BKR6EKUB	3584		LPG 1
Safrane Phase 2 V6		3.0	143	04.99 - 12.00	L7X 713	6	1,0	PFR6E-10	3688		

**SCENIC 1**

Scenic		1.4	55	10.95 - 03.99	E7J 764	4	0,8	BCP5ES	7496	16	LPG 3
Scenic		1.6	66	10.95 - 09.98	K7M 702,703,720	4	0,8	BCPR5ES	6130	32	LPG 3
Scenic GPL		1.6	66	07.97 - 03.99	K7M 702	4		BKR5EK	7956	23	LPG 1
Scenic		1.6	66	10.98 - 03.99	K7M 702,703,720	4	0,9	BKR5EZ	7642	36	LPG 1
Scenic D		1.9	48	10.96 - 08.99	F8Q 620/624	4	☑	Y-927R	5171	19	
Scenic D		1.9	48	03.98 -	F8Q 788	4	☑	Y-506R	4409	7	
Scenic D		1.9	48	03.99 -	F8Q 622/790	4	☑	Y-516J	6416	12	
Scenic Di		1.9	66	10.96 - 08.99	F9Q 716730/734	4	☑	Y-740U	4818	22	
Scenic Dti		1.9	74	01.96 -	F9Q 716/730/734	4	☑	Y-740U	4818	22	
Scenic		2.0	85	10.95 - 03.99	F3R 750/751/79, 796,797,798	4	0,9	BPR5ES	7422	6	LPG 2
Scenic DT		1.9	66	01.96 -	F8Q 784/786	4	☑	Y-933J	7947	25	
Scenic dci RX4		1.9	75	99 -		4	☑	Y-732J	5605	4	

**SCENIC 1 PHASE 2**

Scenic Phase 2		1.4	70	09.99 -	K4J 750	4	0,9	BKR6EZ	4619	38	LPG 1
Scenic Phase 2		1.6	81	09.99 -	K4M 708/709	4	0,9	BKR6EZ	4619	38	LPG 1
Scenic Phase 2		1.8	87	07.00 -	F4P 760	4	0,8	BKR6ES	3783	28	LPG 1
Scenic Phase 2 D		1.9	48	09.99 -		4	☑	Y-927R	5171	19	
Scenic Phase 2 Dti		1.9	59	06.01 -	F9Q T770	4	☑	Y-732J	5605	4	
Scenic Phase 2 Dti		1.9	74	09.99 -	F9Q 730/734/744	4	☑	Y-740U	4818	22	
Scenic Phase 2 Dci		1.9	77	03.99 -	F9Q 718/731/736/740	4	☑	Y-732J	5605	4	
Scenic Phase 2 Dci RX4		1.9	77	09.00 -	F9Q 740	4	☑	Y-732J	5605	4	
Scenic Phase 2		2.0	103	08.99 -	F4R 740/741	4	0,8	BKR6ES	3783	28	LPG 1
Scenic Phase 2		2.0	103	03.00 -	F4R 744	4	0,8	BKR6ES	3783	28	LPG 1
Scenic Phase 2		2.0	120	03.04 - 11.08	F4R 776	4	0,9	PFR6G-9	4377		PFR7G

**SCENIC 2**

Scenic 2 1.4		1.4	72	03 -	K4J	4	0,9	BKR6EZ	4619	38	LPG 1
Scénic 2 1.5 Dci		1.5	59	03 -	K9K	4	☑	Y-732J	5605	4	
Scénic 2 1.5 Dci		1.5	63	05.05 - 11.08	K9K 722/724	4	☑	Y-732J	5605	4	
Scénic 2 1.5 Dci		1.5	74	04.04 -	K9K 728/729	4	☑	Y-732J	5605	4	
Scenic 2 1.6		1.6	85	03 -	K4M	4	0,9	BKR6EZ	4619	38	LPG 1
Scénic 2 1.9 Dci		1.9	81	05.05 -	F9Q 803/812	4	☑	Y-732J	5605	4	
Scénic 2 1.9 Dci		1.9	88	04.04 -	F9Q 812	4	☑	Y-732J	5605	4	
Scénic 2 1.9 Dci		1.9	96	05.05 - 02.08	F9Q 803/804/816/818	4	☑	Y-732J	5605	4	
Scenic 2 2.0		2.0	100	03 -	F4R	4	0,9	BKR6EZ	4619	38	LPG 1

**SCENIC 3**

Scenic 3 1.2 TCe 115		1.2	85	04.12 -	H5F 400	4	0,7	ILKAR7F7G	90061		
----------------------	--	-----	----	---------	---------	---	-----	-----------	-------	--	--

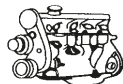
Code *l* kW

Cyl.

Stock-No.  
**VELINE**  
10-11-12-13-14-15-16-17-18-19-20-21-22-23-24-25-26-27-28-29-30-31-32-33-34-35-36-37-38-39-40-41-42-43-44-45-46-47-48-49-50-51-52-53-54-55-56-57-58-59-60-61-62-63-64-65-66-67-68-69-70-71-72-73-74-75-76-77-78-79-80-81-82-83-84-85-86-87-88-89-90-91-92-93-94-95-96-97-98-99-100

LPG/CNG

**RENAULT  
SCENIC 3**

Scenic 3 1.2 TCe 130		1.2	97	06.13 -	H5F 404	4	0,7	ILKAR7F7G	90061		
Scenic 3 1.4 TCe 130		1.4	96	02.09 -	H4J 700	4	0,7	ILKAR7A7	91432		
Scenic 3 1.5 dCi		1.5	63	04.09 -	K9K 830	4	█	Y1035AS	94103	77	
Scenic 3 1.5 dCi		1.5	70	11.10 -	K9K 846	4	█	Y1035AS	94103	77	
Scenic 3 1.5 dCi		1.5	78	02.09 -	K9K 832	4	█	Y1035AS	94103	77	
Scenic 3 1.5 dCi		1.5	81	04.09 -	K9K 836	4	█	Y1035AS	94103	77	
Scenic 3 1.9 dCi		1.9	96	12.08 -	F9Q 870	4	█	Y1036AS	96062		
Scenic 3 2.0 16V		2.0	103	02.09 -	M4R 710 / 711	4	1,1	PLZKAR6A-11	5118		

**SPORT SPIDER**

Sport Spider		2.0	110	03.95 -	F7R 710/712/720	4		BKR6EKUB	3584		LPG 1
--------------	--	-----	-----	---------	-----------------	---	--	----------	------	--	-------

**THALIA / SYMBOL**

Thalia / Symbol 1.2 16V	LB0/1/2	1.2	55	04.02 -	D4F 712	4	0,8	LZKAR7A	6799		
Thalia / Symbol 1.4	LB0/1/2	1.4	55	08.00 - 10.05	K7J 700	4	0,9	BKR5EZ	7642	36	LPG 1
Thalia / Symbol 1.4 16V	LB0/1/2	1.4	72	08.00 -	K4J 712	4	0,9	BKR6EZ	4619	38	LPG 1
Thalia / Symbol 1.5 dCi	LB0/1/2	1.5	47	06.05 -	K9K 740	4	█	Y-732J	5605	4	
Thalia / Symbol 1.5 dCi	LB0/1/2	1.5	48	04.02 - 10.05	K9K 700	4	█	Y-732J	5605	4	
Thalia / Symbol 1.5 dCi	LB0/1/2	1.5	50	02.03 -	K9K 700/714	4	█	Y-732J	5605	4	
Thalia / Symbol 1.5 dCi	LB0/1/2	1.5	60	06.01 -	K9K 702	4	█	Y-732J	5605	4	
Thalia / Symbol 1.6 16V	LB0/1/2	1.6	79	04.02 - 10.05	K4M 734/740/745	4	0,9	BKR6EZ	4619	38	LPG 1
Thalia / Symbol 1.9 D	LB0/1/2	1.9	48	02.98 - 05.01	F8Q 630	4	█	Y-506J	2419	7	
Thalia / Symbol II 1.2 16V	LU1/2	1.2	55	09.08 -	D4F 712	4	0,8	LZKAR7A	6799		
Thalia / Symbol II 1.5 dCi	LU1/2	1.5	47	09.08 -	K9K 740	4	█	Y-732J	5605	4	
Thalia / Symbol II 1.5 dCi	LU1/2	1.5	62	09.08 -	K9K 718	4	█	Y-732J	5605	4	
Thalia / Symbol II 1.6 16V	LU1/2	1.6	77	09.08 -	K4M 745	4		BKR6EZ	4619	38	LPG 1

**TRAFIC**

Trafic D T 1000		1.9	45	11.97 -	F8Q 600/606	4	█	Y-506J	2419	7	
Trafic Dci		1.9	60	05.01 -	F9Q 762	4	█	Y-732J	5605	4	
Trafic 1.9 Dci		1.9	74	05.01 -	F9Q 760	4	█	Y-732J	5605	4	
Trafic T1100 / P1400 / T1400 / V1000		2.0	59	09.89 - 12.97	J5R- 829	4	0,7	BP6ES	7811	4	LPG 2
Trafic 2.0 16V		2.0	86	08.06 -	F4R 820	4	0,9	PFR6G-9	4377		PFR7G
Trafic 2.0		2.0	88	03.01 -	F4R 720 / 722	4	0,9	PFR6G-9	4377		PFR7G
Trafic D P1000, P1200, 4x4		2.1	43	11.81 - 10.97	852/720/750	4	█	Y-924J	7906	1	
Trafic D T 1000		2.1	56	11.97 -	S8U 758/780/782	4	█	Y-910J	3617	3	
Trafic D		2.5	52	10.82 - 10.97	S8U	4	█	Y-208T	1250		
Trafic D		2.5	55	03.90 - 10.97	Sofim 8140	4	█	Y-924J	7906	1	
Trafic 2.5 dCi 115		2.5	84	08.07 -	G9U 630	4	█	Y-517J	3319	66	
Trafic 2.5 dCi 135		2.5	99	03.03 -	G9U 730	4	█	Y-517J	3319	66	
Trafic 2.5 dCi 150		2.5	107	08.06 -	G9U 630	4	█	Y-517J	3319	66	

**TWINGO 1**

Twingo	C06	1.2	40	03.93 - 06.97	C3G 700	4	0,9	BP5ESZ	4691		LPG 2
Twingo easy	C06	1.2	40	09.94 - 96	C3G 702	4	0,9	BP5ESZ	4691		LPG 2
Twingo	C06	1.2	44	04.94 - 06.97	D7F 730	4	0,8	BK5ESZ	5675		
Twingo	C06	1.2	44	07.97 - 07.98	D7F 700/701/702 / 703 / 704 / 706	4		BKR5EK	7956	23	LPG 1
Twingo	C06	1.2	44	04.00 -	D7F GPL	4		BKR5EIX	6341		LPG 1

**TWINGO 2**

Twingo 2	CNO	1.2	44	08.98 -	D7F 702/703	4		BKR5EK	7956	23	LPG 1
Twingo 2 Euro2000	CNO	1.2	44	04.00 -	D7F 726	4	0,9	BKR6EZ	4619	38	LPG 1
Twingo 2	CNO	1.2	44	06.07 -	D4F 764	4	0,9	LZKAR7B	5942		

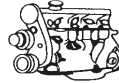
Code *l* kW

Cyl.



Stock-No.

V6/V8

LPG/CNG

**RENAULT****TWINGO 2**

Twingo 2	CNO	1.2	44	08 -	D7F 800	4	0,9	BKR6EZ	4619	38	LPG 1
Twingo 2 16V	CNO	1.2	55	11.00 -	D4F 702/703/704/740	4	0,8	LZKAR7A	6799		
Twingo 2	CNO	1.2	55	06.07 -	D4F 722/740/772	4	0,9	LZKAR7B	5942		
Twingo 2 Tce 100	CNO	1.2	74	06.07 -	D4F 780 / 782	4	0,7	ILKAR7A7	91432		
Twingo 2 1.5 DCI	CNO	1.5	47	06.07 -	K9K 740	4	█	Y-732J	5605	4	
Twingo 2 1.5 DCI 75	CNO	1.5	55	10.10 -	K9K 820	4	█	Y1035AS	94103	77	
Twingo 2 1.5 DCI	CNO	1.5	62	04.08 -	K9K 718	4	█	Y-732J	5605	4	
Twingo 2 1.5 DCI 90	CNO	1.5	63	10.10 -	K9K 820	4	█	Y1035AS	94103	77	
Twingo 2 1.6 RS	CNO	1.6	98	05.08 -	K4M 854/862	4	0,9	PFR7Z-TG	5768		

**VEL SATIS**

Vel Satis 2.0 16V Turbo	BJO	2.0	108	04.05 - 08.09	F4R 867	4	0,9	PFR6G-9	4377		PFR7G
Vel Satis 2.0 16V Turbo	BJO	2.0	120	03.02 - 08.09	F4R 760/762/763	4	0,9	PFR6G-9	4377		PFR7G
Vel Satis 2.0 16V Turbo	BJO	2.0	125	04.04 - 08.09	F4R 766 / 767	4	0,9	PFR6G-9	4377		PFR7G
Vel Satis 2.2 Dci	BJO	2.2	85	03.02 -		4	█	Y-517J	3319	66	
Vel Satis 2.2 Dci	BJO	2.2	85	03.02 - 12.03	G9T	4	█	Y-517J	3319	66	
Vel Satis 2.2 Dci	BJO	2.2	110	03.02 - 12.03	G9T 702	4	█	Y-517J	3319	66	
Vel Satis 3.5 V6 24V	BJO	3.5	180	02.02 -	V4Y 701	6	1,1	PLFR5A-11	6240		LPG 7

**WIND**

Wind TCe 100	E4M	1.2	74	07.10 -	D4F 782	4	0,7	ILKAR7A7	91432		
Wind TCe 100	E4M	1.2	75	02.11 -	D4F 780	4	0,7	ILKAR7A7	91432		
Wind 1.6 16V 130	E4M	1.6	98	07.10 -	K4M 854	4	0,9	PFR7Z-TG	5768		

**ROLLS ROYCE**

Corniche 71—>02		6.75		07.93 - 08.95		8	0,9	BKR4EVX	4870		
Corniche 71—>02		6.75		09.95 -		8		BKR5EIX	6341		LPG 1
Flying Spur		6.75		08.94 - 07.95		8		BKR5EIX	6341		LPG 1
Park Ward		5.4		10.00 -	V12 BMW	12		BKR6EQUP	3199	30	LPG 1
Park Ward		6.8		02.97 - 09.00		8	0,9	BKR4EVX	4870		
Silver Dawn		6.75		94 - 98		8		BKR5EIX	6341		LPG 1
Silver Seraph		5.4	240	98 - 07.99	BMW M73B54	12		BKR6EK	2288	20	LPG 1
Silver Seraph		5.4	240	08.99 -	BMW M73B54	12		BKR6EQUP	3199	30	LPG 1
Silver Spirit/ Spur		6.75		07.93 -		8	0,9	BKR4EVX	4870		

**ROVER****25**

25 1.1		1.1	44	11.99 -	K Series	4	1,1	PFR6N-11	3546		LPG 1
25 1.1 16V		1.1	55	01.04 -	K Series	4	1,1	PFR6N-11	3546		LPG 1
25 1.4 16V		1.4	62	11.99 -	K Series	4	1,1	PFR6N-11	3546		LPG 1
25 1.6 16V		1.6	80	11.99 -	K Series	4	1,1	PFR6N-11	3546		LPG 1
25 1.8 16V		1.8	85	99 -	K Series with VVC	4	1,1	PFR6N-11	3546		LPG 1
25 Steptronic		1.8	86	05.01 -		4	1,1	PFR6N-11	3546		LPG 1
25 1.8 16V		1.8	107	02.00 -	K Series	4	1,1	PFR6N-11	3546		LPG 1
25 2.0 iDT		2.0	74	11.99 -		4	█	Y-730U	6704	17	

**45**

45 1.4		1.4	76	11.99 -	K Series	4	1,1	PFR6N-11	3546		LPG 1
45 1.6		1.6	80	11.99 -	K Series	4	1,1	PFR6N-11	3546		LPG 1
45 1.8		1.8	86	99 -	K Series	4	1,1	PFR6N-11	3546		LPG 1
45 2.0 TD		2.0	73	11.99 -		4	█	Y-730U	6704	17	
45 2.0 V6		2.0	110	99 -	KV6	6	1,1	PFR6N-11	3546		LPG 1

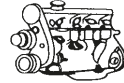
Code *l* kW

Cyl.



Stock-No.



LPG/CNG

**ROVER****75**

75 1.8		1.8	87	02.99 -	K Series	4	1,1	PFR6N-11	3546		LPG 1
75 1.8 Turbo		1.8		07.02 -	K Series	4	1,1	PFR6N-11	3546		LPG 1
75 2.0 CDT		2.0	85	99 -	M47R (BMW)	4	█	Y-507J	2691	32	
75 2.0 V6		2.0	109	02.99 -	K V6	6	1,1	PFR6N-11	3546		LPG 1
75 2.5 V6		2.5	128	02.99 -	K V6	6	1,1	PFR6N-11	3546		LPG 1

**SERIE 100**

111		1.1	44	91 -	K8 8 VALVE	4	0,9	BKR6E	6962	28	LPG 1
114		1.4	55	91 -	K8	4	0,9	BKR6E	6962	28	LPG 1
114		1.4		91 -	K16	4	0,9	BKR6E	6962	28	LPG 1
115 SD/CSD		1.5	57	01.95 - 98	TUD 5	4	█	Y-503J	1009	10	

**SERIE 200**

211		1.1	43	01.98 - 04.99	K Series 8 V	4	0,8	BKR6ES	3783	28	LPG 1
214 Mk.2		1.4		10.89 -	K Series	4	0,9	BKR6E	6962	28	LPG 1
214 Mk.3		1.4		11.95 -		4	0,9	BKR6E	6962	28	LPG 1
216 Mk.2		1.6		10.89 -	SOHC	4	1,1	BCPR6E-11	3132	11	LPG 3
216 Mk.2		1.6		09.90 -	DOHC	4	1,1	BCPR6E-11	3132	11	LPG 3
216 Mk.3		1.6		11.95 -		4	0,9	BKR6E	6962	28	LPG 1
217 SD, 218 SD/SLD		1.9	49	09.91 -	XUD 9	4	█	Y-924J	7906	1	
218 TD		1.8	65	09.91 -	XUD 7 TE	4	█	Y-924J	7906	1	
218 Mk.3		1.8	107	01.96 -	K Series with VVC	4	1,1	PFR6N-11	3546		LPG 1
218 D		1.9	49	09.91 -	XUD 9	4	█	Y-924J	7906	1	
220 SDi		2.0	63	10.95 -	20 T2R	4	█	Y-730U	6704	17	
220 SDi		2.0	77	10.95 -	20T2N (Intercooled)	4	█	Y-730U	6704	17	
220 Mk.2		2.0		06.91 -	T16 TURBO	4	0,9	BKR6E	6962	28	LPG 1

**SERIE 400**

400 D				01.87 -			█	Y-924J	7906	1	
414 Mk.1		1.4		03.90 - 07.95		4	0,9	BKR6E	6962	28	LPG 1
414 Mk.2		1.4		05.95 -		4	0,9	BKR6E	6962	28	LPG 1
Tourer 1.6		1.6	80	03.96 - 04.99	K Series	4	0,8	BKR6ES	3783	28	LPG 1
416 Mk.1		1.6		03.90 - 12.91	DOHC	4	1,1	BCPR6E-11	3132	11	LPG 3
416 Mk.1		1.6		03.90 -	SOHC	4	1,1	BCPR6E-11	3132	11	LPG 3
416 Mk.2		1.6		05.95 -	Automatik	4	1,1	BKR6E-11	2756	14	LPG 1
416 Mk.2		1.6		05.95 -	Schaltgetriebe	4	0,9	BKR6E	6962	28	LPG 1
418 SLD/GSD TD		1.8	65	09.91 - 03.96	XUD 7 T	4	█	Y-924J	7906	1	
418		1.8	105	03.96 - 10.97	K Series	4	1,1	PFR6N-11	3546		LPG 1
420 Mk.1		2.0		10.91 - 11.94		4	0,9	BKR6E	6962	28	LPG 1
420 Turbo		2.0		92 -	T16 TURBO	4	0,9	BKR6E	6962	28	LPG 1
420 Mk.2		2.0		12.95 -		4	0,7	BCP6ES	4930	17	LPG 3
420 SDi, SLDi TD		2.0		10.95 - 99	20 T2R, 20T2N (Intercooled)	4	█	Y-730U	6704	17	
420 D / SD		2.0	63	07.95 -		4	█	Y-730U	6704	17	
420 Di / Sdi		2.0	77	07.95 -		4	█	Y-730U	6704	17	

**SERIE 600**

618		1.8		02.96 -	Honda	4	1,1	ZFR6F-11	4291		LPG 6
620		2.0	85	04.93 -	HONDA	4	1,1	ZFR6F-11	4291		LPG 6
620 Turbo		2.0		94 -	T Series	4	0,9	BKR6E	6962	28	LPG 1
620 SDi, SLDi TD		2.0		10.95 - 99	20 T2R, 20T2N (Intercooled)	4	█	Y-730U	6704	17	
623		2.3	116	04.94 -	HONDA	4	1,1	ZFR6F-11	4291		LPG 6

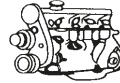
Code *l* kW

Cyl.



Stock-No.



LPG/CNG

**ROVER****SERIE 800**

820 Turbo		2.0	132	10.92 -	20T4 TURBO MPI	4	0,9	BKR6E	6962	28	LPG 1
820		2.0		07.86 - 10.91	M16 Inj.	4	0,9	BKR6E	6962	28	LPG 1
820		2.0		03.91 - 10.91	M16 Turbo Inj.	4	0,9	BKR6E	6962	28	LPG 1
820		2.0		11.91 -	T16 / Turbo/ Inj.	4	0,9	BKR6E	6962	28	LPG 1
820 i		2.0		91 -	20T4 MPI	4	0,9	BKR6E	6962	28	LPG 1
825 SD TD		2.5	87	01.93 -	VM HR-492/VM 425 SLIRR	4	█	Y-923U	3380	1	
825 D/SD/SLD		2.5		90 - 03.96	VM	4	█	Y-924J	7906	1	
825		2.5		03.96 - 10.99	VM	4	█	Y-741U	6943	20	
825 i		2.5		01.96 -	KV6	6	0,9	BKR6E	6962	28	LPG 1
827		2.7		02.88 - 01.96	C27A V6	6	1,1	BCPR6E-11	3132	11	LPG 3

**CITY ROVER**

City Rover 1.4		1.4		10.03 -	K Series	4	0,8	BK6E	3536		LPG 1
----------------	--	-----	--	---------	----------	---	-----	------	------	--	-------

**MAESTRO**

Maestro		1.3	51	03.89 - 12.94		4	0,8	BPR6ES	7822	2	LPG 2
Maestro		1.6	63	07.89 - 04.92	S Series	4	0,8	BCPR6ES	2330	12	LPG 3
Maestro Van TD		2.0	60	01.86 -		4	█	Y-924J	7906	1	
Maestro TD		2.0	60	07.89 -	Perkins-Prima 80 T	4	█	Y-924J	7906	1	

**METRO**

Metro		1.1		05.90 - 12.94	K8	4	0,9	BKR6E	6962	28	LPG 1
Metro D		1.4	39	01.92 - 01.95	Peugeot TUD 3	4	█	Y-910J	3617	3	
Metro /16V/16V GTI		1.4		05.90 - 01.95	K8/K16/K16	4	0,9	BKR6E	6962	28	LPG 1

**RV 8**

MG RV8		3.9	140	94 -	V8i	8	0,8	BPR6ES	7822	2	LPG 2
--------	--	-----	-----	------	-----	---	-----	--------	------	---	-------

**MINI**

Mini		1.0		10.89 - 04.92		4	0,8	BPR6ES	7822	2	LPG 2
Mini Cooper i		1.3	46	91 -	12A2EF77/SPI	4	0,8	BPR6ES	7822	2	LPG 2
Mini		1.3		10.89 -	not Turbo	4	0,8	BPR6ES	7822	2	LPG 2

**MONTEGO**

Montego 1.4		1.4		12.94 -		4	0,7	BCP6ES	4930	17	LPG 3
Montego 1.6		1.6		04.89 - 01.93		4	0,8	BCPR6ES	2330	12	LPG 3
Montego 2.0 TD		2.0	60	09.88 -	Perkins-Prima 80 T	4	█	Y-924J	7906	1	
Montego 2.0		2.0		04.89 - 12.94		4	0,8	BPR6ES	7822	2	LPG 2

**STREETWISE**

Streetwise 1.4		1.4		07.03 -	K Series	4	1,1	PFR6N-11	3546		LPG 1
Streetwise 1.4		1.4		07.03 -	K Series	4	1,1	PFR6N-11	3546		LPG 1
Streetwise 1.6		1.6		07.03 -	K Series	4	1,1	PFR6N-11	3546		LPG 1
Streetwise 1.8		1.8		07.03 -	K Series	4	1,1	PFR6N-11	3546		LPG 1
Streetwise 2.0 TD		2.0		07.03 -		4	█	Y-730U	6704	17	

**SAAB****900**

900		2.0	136	10.93 -	B204L	4	1,1	BCPR7ES-11	1095		BCPR7EIX
900 Turbo		2.0		83 - 93	B201 mit / with APC	4	0,8	BPR7EIX	4055		BPR8EIX
900		2.3	110	10.93 -	B234I	4	0,7	BCP6EVX	6323		LPG 3
900		2.5	125	94 -	B258 Motronic	6		BKR5EK	7956	23	LPG 1
900		2.5		10.93 -	B258i, B308i	6		BKR6EK	2288	20	LPG 1

**9000**

9000		2.0	87	09.84 - 12.98	B202L	4	1,1	BCPR7ES-11	1095		BCPR7EIX
------	--	-----	----	---------------	-------	---	-----	------------	------	--	----------



Code *l* kW

Cyl.



Stock-No.



BIOPOWER

LPG/CNG

**SAAB  
9000**

9000		2.0	96	94 - 98	B204i	4	1,1	BCPR6ES-11	7121	11	LPG 3
9000		2.0	110	94 - 98	B204 E	4	1,1	BCPR7ES-11	1095		BCPR7EIX
9000		2.0		94 - 96	B202 mit Di	4	0,8	BCPR7ES	3330		BCPR7EIX
9000		2.0		94 - 96	B202S mit Di	4	0,8	BCPR7ES	3330		BCPR7EIX
9000		2.3	96	94 - 96	B234I	4	0,7	BCP6EVX	6323		LPG 3
9000 CS 2.3-16		2.3	107	09.91 - 12.98	B234I Cat.	4	1,1	BCPR6ES-11	7121	11	LPG 3
9000		2.3	125	94 - 98	B234 E	4	1,1	BCPR7ES-11	1095		BCPR7EIX
9000		2.3	147	92 - 98	B234L	4	1,1	BCPR7ES-11	1095		BCPR7EIX
9000 Aero		2.3	165	93 - 98	B234R	4	1,1	BCPR7ES-11	1095		
9000 V6		3.0	155	11.94 - 12.98	B308 V6	6		BKR5EK	7956	23	LPG 1

**9-3 1**

9-3 2.0i	YS3D	2.0	96	02.98 - 08.03	B204i	4	0,7	BCP5EVX	5664		LPG 3
9-3 2.0 Turbo	YS3D	2.0	110	03.99 - 08.03	B205E	4	0,7	BCP5EVX	5664		LPG 3
9-3 2.0 Turbo	YS3D	2.0	113	10.98 - 08.03	B204E	4	1,1	BCPR7ES-11	1095		BCPR7EIX
9-3 2.0 Turbo	YS3D	2.0	136	02.98 - 07.03	B204L	4	1,1	BCPR7ES-11	1095		BCPR7EIX
9-3 2.0 Turbo	YS3D	2.0	136	02.98 - 07.03	B205L	4	1,0	PFR6H-10	6290		PFR7H-10
9-3 2.0 SE Turbo	YS3D	2.0	147	02.98 - 08.03	B204R	4	1,1	BCPR7ES-11	1095		BCPR7EIX
9-3 2.0 Turbo	YS3D	2.0	151	09.99 - 08.03	B205R	4	1,0	PFR6H-10	6290		PFR7H-10
9-3 2.2 TiD	YS3D	2.2	85	02.98 - 11.00	D223L / X22DTH Opel	4	█	Y-748U	6649	14	
9-3 2.2 TiD	YS3D	2.2	92	11.00 - 09.02	D223L	4	█	Y-523J	6298	37	
9-3 2.3i	YS3D	2.3	110	02.98 - 08.03	B234I	4	1,0	PFR6H-10	6290		PFR7H-10
9-3 2.3 Turbo	YS3D	2.3	165	10.98 - 03.03	B235R	4	1,0	PFR6H-10	6290		PFR7H-10
9-3 2.3	YS3D	2.3	169	09.99 - 12.02	B235R	4	1,0	PFR6H-10	6290		PFR7H-10

**9-3 2**

9-3 1.8i	YS3F	1.8	90	11.03 - 03.09	Z18XE	4		BKR5EQUA	3566		
9-3 1.8t	YS3F	2.0	110	09.02 - 12.07	B207E	4	1,0	PFR6T-10G	5542		PFR6T-10G
9-3 1.8t	YS3F	2.0	110	01.08 - 07.12	B207E	4	1,0	PFR6D10G	1632		PFR6D10G
9-3 1.8t BioPower	YS3F	2.0	110	01.07 - 12.07	B207E	4	1,1	BKR7ESC-11	6313		
9-3 1.8t BioPower	YS3F	2.0	110	01.08 - 07.12	B207E	4	1,0	PFR6D10G	1632		PFR6D10G
9-3 1.8t BioPower	YS3F	2.0	129	01.10 - 07.12	B207L	4	1,0	PFR6D10G	1632		PFR6D10G
from engine-no. 11765306											
9-3 1.8t BioPower	YS3F	2.0	129	01.07 - 12.09	B207L	4	1,1	BKR7ESC-11	6313		
to engine-no. 11765305											
9-3 1.9 TiD	YS3F	1.9	88	03.05 - 07.12	Z19DT Fiat	4	█	Y-534J	3413	36	
9-3 1.9 TTiD	YS3F	1.9	96	12.07 - 07.12	A19DTR	4	█	Y9003AS	94251	78	
9-3 1.9 TiD	YS3F	1.9	110	03.05 - 07.12	Z19DTH	4	█	YE07	6092		
9-3 1.9 TTiD	YS3F	1.9	118	12.07 - 07.12	A19DTR	4	█	Y9003AS	94251	78	
9-3 2.0t	YS3F	2.0	110	03.05 - 12.07	B207E	4	1,0	PFR6T-10G	5542		PFR6T-10G
9-3 2.0t	YS3F	2.0	110	01.08 - 07.12	B207E	4	1,0	PFR6D10G	1632		PFR6D10G
9-3 2.0t	YS3F	2.0	120	01.07 - 12.07	B207R	4	1,0	PFR6T-10G	5542		PFR6T-10G
9-3 2.0t	YS3F	2.0	120	01.08 - 07.12	B207R	4	1,0	PFR6D10G	1632		PFR6D10G
9-3 2.0t BioPower	YS3F	2.0	120	01.07 - 12.07	B207R	4	1,1	BKR7ESC-11	6313		
9-3 2.0t BioPower	YS3F	2.0	120	01.08 - 07.12	B207R	4	1,0	PFR6D10G	1632		
9-3 2.0t	YS3F	2.0	129	09.02 - 12.07	B207L	4	1,0	PFR6T-10G	5542		PFR6T-10G
9-3 2.0t	YS3F	2.0	129	01.08 - 07.12	B207L	4	1,0	PFR6D10G	1632		PFR6D10G
9-3 2.0t BioPower	YS3F	2.0	129	01.07 - 12.07	B207L	4	1,1	BKR7ESC-11	6313		
9-3 2.0t BioPower	YS3F	2.0	129	01.08 - 07.12	B207L	4	1,0	PFR6D10G	1632		
9-3 2.0t BioPower	YS3F	2.0	145	06.07 - 12.07	B207R	4	1,1	BKR7ESC-11	6313		
to engine-no. 11765305											

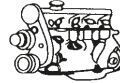
Code *l* kW

Cyl.



Stock-No.



LPG/CNG

**SAAB****9-3 2**

9-3 2.0t BioPower from engine-no. 11765306	YS3F	2.0	145	01.08 - 07.12	B207R	4	1,0	PFR6D10G	1632		
9-3 2.0t	YS3F	2.0	147	06.07 - 12.07	B207R	4	1,0	PFR6T-10G	5542		PFR6T-10G
9-3 2.0t	YS3F	2.0	147	01.08 - 07.12	B207R	4	1,0	PFR6D10G	1632		PFR6D10G
9-3 2.0t BioPower to engine-no. 11765305	YS3F	2.0	147	06.07 - 12.07	B207R	4	1,1	BKR7ESC-11	6313		
9-3 2.0t BioPower from engine-no. 11765306	YS3F	2.0	147	01.08 - 07.12	B207R	4	1,0	PFR6D10G	1632		
9-3 2.0 T	YS3F	2.0	154	09.02 - 12.07	B207R	4	1,0	PFR6T-10G	5542		PFR6T-10G
9-3 2.0 T	YS3F	2.0	154	01.08 - 07.12	B207R	4	1,0	PFR6D10G	1632		PFR6D10G
9-3 2.0 T BioPower	YS3F	2.0	154	09.02 - 12.07	B207R	4	1,1	BKR7ESC-11	6313		
9-3 2.0 T BioPower	YS3F	2.0	154	01.08 - 07.12	B207R	4	1,0	PFR6D10G	1632		
9-3 2.0 T	YS3F	2.0	162	01.11 - 07.12	B207R / A20NFT	4	1,0	PFR6D10G	1632		PFR6D10G
9-3 2.0 T BioPower	YS3F	2.0	162	01.11 - 07.12	B207R / A20NFT	4	1,0	PFR6D10G	1632		
9-3 2.0 T Aero	YS3F	2.0	177	05.09 - 07.12	B207R	4	1,0	PFR6D10G	1632		PFR6D10G
9-3 2.2 TiD	YS3F	2.2	92	09.02 - 07.12	D223L	4		Y-523J	6298	37	
9-3 2.8 Turbo Aero	YS3F	2.8	169	04.05 - 07.12	B284E HFV6	6	1,0	PLFR6C-10G	1959		PLFR6C-10G
9-3 2.8 Turbo V6	YS3F	2.8	184	03.05 - 12.07	B284E / B284L	6	1,0	PLFR6C-10G	1959		PLFR6C-10G
9-3 2.8 Turbo V6	YS3F	2.8	184	01.08 - 07.12	B284E / B284L	6	1,0	DILFR7B10G	97218		DILFR7B10G
9-3 2.8 Turbo V6	YS3F	2.8	188	09.07 - 12.07	B284L	6	1,0	PLFR6C-10G	1959		PLFR6C-10G
9-3 2.8 Turbo V6	YS3F	2.8	188	01.08 - 07.12	B284L	6	1,0	DILFR7B10G	97218		DILFR7B10G
9-3 2.8 Turbo V6	YS3F	2.8	203	02.09 - 07.12	B284R	6	1,0	DILFR7B10G	97218		DILFR7B10G
9-3 2.8 Turbo V6	YS3F	2.8	206	09.07 - 12.07	B284R	6	1,0	PLFR6C-10G	1959		PLFR6C-10G
9-3 2.8 Turbo V6	YS3F	2.8	206	01.08 - 07.12	B284R	6	1,0	DILFR7B10G	97218		DILFR7B10G

**9-3 X**

9-3X 1.9 TtID	YS3F	1.9	132	02.09 - 07.12	Z19DTR	4		Y9003AS	94251	78	
9-3X 2.0 T XWD	YS3F	2.0	154	02.09 - 07.12	B207R	4	1,0	PFR6T-10G	5542		
9-3X 2.0 T BioPower XWD	YS3F	2.0	154	02.09 - 07.12	B207R	4	1,1	BKR7ESC-11	6313		
9-3X 2.0 T BioPower XWD	YS3F	2.0	162	01.11 - 07.12	B207R	4	1,0	PFR6D10G	1632		

**9-5 1**

9-5 1.9 TiD	YS3E	1.9	110	01.06 - 05.10	Z19DTH	4		YE07	6092		
9-5 2.0t	YS3E	2.0	110	09.97 - 05.10	B205E	4	1,1	BCPR7ES-11	1095		BCPR7EIX
9-5 2.0t Bio Power	YS3E	2.0	132	07.07 - 05.10	A20NHL	4	1,1	BKR7ESC-11	6313		
9-5 2.0t SE	YS3E	2.0	136	07.00 - 07.01	B205L	4	1,0	PFR6H-10	6290		PFR7H-10
9-5 2.0t	YS3E	2.0	140	09.97 - 07.00	B205E Trim Kit	4	1,0	PFR6H-10	6290		PFR7H-10
9-5 2.2 TiD	YS3E	2.2	88	01.02 - 08.05	D223L	4		Y-748U	6649	14	
9-5 2.3t	YS3E	2.3	125	09.97 - 07.01	B235E	4	1,1	BCPR6ES-11	7121	11	LPG 3
9-5 2.3t	YS3E	2.3	136	09.99 - 05.10	B235E	4	1,1	BCPR6ES-11	7121	11	LPG 3
9-5 2.3t Bio Power	YS3E	2.3	155	09.06 - 05.10		4	1,1	BCPR7ES-11	1095		BCPR7EIX
9-5 2.3 Turbo	YS3E	2.3	162	07.03 - 05.10	B235L	4	1,0	PFR6H-10	6290		PFR7H-10
9-5 2.3 Turbo	YS3E	2.3	165	07.98 - 05.10	B235R	4	1,0	PFR6H-10	6290		PFR7H-10
9-5 2.3 Turbo	YS3E	2.3	169	10.99 - 09.01	B235R	4	1,0	PFR6H-10	6290		PFR7H-10
9-5 2.3 Turbo	YS3E	2.3	184	10.99 - 05.10	B235R	4	1,0	PFR6H-10	6290		PFR7H-10
9-5 2.3 Turbo	YS3E	2.3	191	11.05 - 05.10	B235R	4	1,0	PFR6H-10	6290		PFR7H-10
9-5 3.0 V6	YS3E	3.0	147	09.97 - 08.05	B308E	6	1,1	BKR7ES-11	2387		BKR8EIX

**9-5 2**

9-5 1.6T	YS3G	1.6	132	05.10 - 07.12	A16LET	4	0,9	ZFR6BP-G	1748		ZFR6BP-G
9-5 2.0T Bio Power	YS3G	2.0	162	05.10 - 07.12	A20NFT	4	0,9	ILTR5D	5476		
9-5 2.0T	YS3G	2.0	162	05.10 - 07.12	A20NHT	4	0,9	ILTR5D	5476		

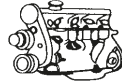
Code *l* kW

Cyl.



Stock-No.



LPG/CNG

**SAAB****9-5 2**

9-5 2.8 T V6 XWD	YS3G	2.8	221	05.10 - 07.12	A28NER	6	1,0	DILFR7B10G	97218		DILFR7B10G
------------------	------	-----	-----	---------------	--------	---	-----	------------	-------	--	------------

**SEAT****ALHAMBRA 1995**

Alhambra 1.8 T	7V8/7V9	1.8	110	05.98 - 02.00	AJH	4		BKR6ETA-10	7998		
Alhambra 1.9 TDI	7V8/7V9	1.9	66	04.95 - 07.96	1Z	4	☑	Y-732J	5605	4	
Alhambra 1.9 TDI	7V8/7V9	1.9	66	07.96 - 02.00	AHU	4	☑	Y-732J	5605	4	
Alhambra 1.9 TDI	7V8/7V9	1.9	81	09.97 - 02.00	AFN	4	☑	Y-732J	5605	4	
Alhambra 2.0	7V8/7V9	2.0	85	03.96 - 02.00	ADY	4		BKUR6ET	6437	27	LPG 1

**ALHAMBRA 2000**

Alhambra 1.8 T	7V8/7V9	1.8	110	06.00 - 03.10	AWC	4	0,8	PFR6Q	6458	37	LPG 1
Alhambra 1.9 TDI	7V8/7V9	1.9	66	06.00 - 03.10	ANU	4	☑	Y-732J	5605	4	
Alhambra 1.9 TDI	7V8/7V9	1.9	85	06.00 - 03.10	AUY	4	☑	Y-732J	5605	4	
Alhambra 1.9 TDI	7V8/7V9	1.9	96	06.05 - 05.06	ASZ	4	☑	Y-741U	6943	20	
Alhambra 1.9 TDI	7V8/7V9	1.9	110	05.05 - 05.07	BTB	4	☑	Y-741U	6943	20	
Alhambra 2.0	7V8/7V9	2.0	85	06.00 - 03.10	ATM	4		BKUR6ET-10	2397	24	LPG 1
Alhambra 2.0 TDI	7V8/7V9	2.0	103	11.05 - 03.10	BRT	4	☑	CZ104	9826	52	
Alhambra 2.8 V6	7V8/7V9	2.8	150	06.00 - 04.02	AUE	6	1,1	PZFR5D-11	7968	34	LPG 6
Alhambra 2.8 V6	7V8/7V9	2.8	150	06.00 - 03.10	AYL	6	1,1	PZFR5D-11	7968	34	LPG 6

**ALHAMBRA 2**

Alhambra 2 1.4 TSI	710	1.4	110	06.10 -	CAVA	4	0,8	SIZFR6B8EG	96209		
Alhambra 2 1.4 TSI	710	1.4	110	06.10 -	CNWB	4	0,8	SIZFR6B8EG	96209		
Alhambra 2 1.4 TSI	710	1.4	110	06.10 -	CTHA	4	0,8	SIZFR6B8EG	96209		
Alhambra 2 2.0 TDI	710	2.0	85	06.11 -	CFFE	4	☑	Y1002AS	8888	57	
Alhambra 2 2.0 TDI	710	2.0	100	06.10 -	CFFA	4	☑	Y1002AS	8888	57	
Alhambra 2 2.0 TDI	710	2.0	103	06.10 -	CFFB	4	☑	Y1002AS	8888	57	
Alhambra 2 2.0 TDI	710	2.0	125	06.10 -	CFGB	4	☑	Y1002AS	8888	57	
Alhambra 2 2.0 TDI	710	2.0	130	11.12 -	CFGC	4	☑	Y1002AS	8888	57	
Alhambra 2 2.0 TSI	710	2.0	147	11.10 -	CCZA	4	0,8	PFR7S8EG	1675		PFR8S8EG

**ALTEA**

Altea 1.2 TSI	5P1	1.2	77	04.10 -	CBZB	4	0,7	IZFR6P7	97153		
Altea 1.4	5P1	1.4	63	05.06 -	BXW	4	1,1	ZFR6T-11G	5960		
Altea 1.4	5P1	1.4	63	05.10 -	CGGB	4	1,1	ZFR6T-11G	5960		
Altea 1.4 TSI	5P1	1.4	92	11.07 -	CAXC	4	0,9	PZFR6R	5758		
Altea 1.6	5P1	1.6	75	03.04 - 05.05	BGU	4		BKUR6ET-10	2397	24	LPG 1
Altea 1.6	5P1	1.6	75	05.05 -	BSE	4		BKUR6ET-10	2397	24	LPG 1
Altea 1.6	5P1	1.6	75	05.05 - 09	BSF	4		BKUR6ET-10	2397	24	LPG 1
Altea 1.6	5P1	1.6	75	12.07 -	CCSA	4		BKUR6ET-10	2397	24	LPG 1
Altea 1.6 LPG	5P1	1.6	75	09.09 -	CHGA	4		BKUR6ET-10	2397	24	LPG 1
Altea 1.6 TDI	5P1	1.6	77	10.09 -	CAYC	4	☑	Y1002AS	8888	57	
Altea 1.8 TFSI	5P1	1.8	118	01.07 - 06.07	BYT	4	0,8	PFR7S8EG	1675		PFR8S8EG
Altea 1.8 TFSI	5P1	1.8	118	06.07 - 03.09	BZB	4	0,8	PFR7S8EG	1675		PFR8S8EG
Altea 1.8 TFSI	5P1	1.8	118	03.09 -	CDA	4	0,8	PFR7S8EG	1675		PFR8S8EG
Altea 1.9 TDI	5P1	1.9	66	08.09 -	BXF	4	☑	Y-607AS	7560	50	
Altea 1.9 TDI	5P1	1.9	77	04.04 - 09.05	BJB	4	☑	Y-607AS	7560	50	
Altea 1.9 TDI	5P1	1.9	77	04.04 - 05.06	BKC	4	☑	Y-607AS	7560	50	
Altea 1.9 TDI	5P1	1.9	77	10.05 -	BLS	4	☑	CZ104	9826	52	
Altea 1.9 TDI	5P1	1.9	77	02.06 -	BXE	4	☑	Y-607AS	7560	50	
Altea 2.0 TDI 16V	5P1	2.0	100	04.04 - 05.09	AZV	4	☑	YE14	7768	48	
Altea 2.0 TDI 16V	5P1	2.0	103	03.04 -	BKD	4	☑	YE14	7768	48	
Altea 2.0 TDI	5P1	2.0	103	11.05 -	BMM	4	☑	Y-607AS	7560	50	

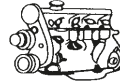
Code *l* kW

Cyl.

Stock-No.  
**VEFINE****B-FORMER**  
LPG/CNG**SEAT****ALTEA**

Altea 2.0 FSI	5P1	2.0	110	05.04 - 11.05	BLR	4		PZFR5N-11T	7742		
Altea 2.0 FSI	5P1	2.0	110	11.04 - 11.05	BLY	4	0,9	BKR6E	6962	28	LPG 1
Altea 2.0 FSI	5P1	2.0	110	11.05 -	BVY	4		PZFR5N-11T	7742		
Altea 2.0 FSI	5P1	2.0	110	11.05 -	BVZ	4	0,9	BKR6E	6962	28	LPG 1
Altea 2.0 TDI	5P1	2.0	125	02.06 -	BMN	4	█	CZ304	9864	55	
Altea 2.0 TDI	5P1	2.0	125	03.09 - 09.10	CEGA	4	█	Y-609AS	5849	49	
Altea 2.0 TFSI	5P1	2.0	147	02.06 - 05.09	BWA	4	0,8	PFR7S8EG	1675		PFR8S8EG

**ALTEA XL**

Altea XL 1.6 LPG	5P5	1.6	75	09.09 -	CHGA	4		BKUR6ET-10	2397	24	LPG 1
Altea XL 1.6 TDI	5P5	1.6	77	10.09 -	CAYC	4	█	Y1002AS	8888	57	
Altea XL 2.0 TFSI 4x4	5P5	2.0	155	05.09 -	CCZB	4	0,8	PFR7S8EG	1675		PFR8S8EG

**AROSA**

Arosa 1.0	6H	1.0	37	02.97 - 09.99	AER	4		BUR6ET	3172	1	LPG 2
Arosa 1.0	6H	1.0	37	08.97 - 06.99	ALL	4		BUR6ET	3172	1	LPG 2
Arosa 1.0	6H	1.0	37	11.98 - 02.00	AHT	4		BKR6ETA-10	7998		
Arosa 1.0	6H	1.0	37	07.99 - 07.00	ALD	4	1,1	PZFR5D-11	7968	34	LPG 6
Arosa 1.0	6H	1.0	37	07.99 - 07.00	ANV	4	1,1	PZFR5D-11	7968	34	LPG 6
Arosa 1.0	6H	1.0	37	07.00 - 06.04	AUC	4	1,1	PZFR5D-11	7968	34	LPG 6
Arosa 1.4	6H	1.4	44	02.97 - 11.97	AEX	4		BUR6ET	3172	1	LPG 2
Arosa 1.4	6H	1.4	44	05.97 - 09.99	AKV	4		BUR6ET	3172	1	LPG 2
Arosa 1.4	6H	1.4	44	12.97 - 08.99	APQ	4		BUR6ET	3172	1	LPG 2
Arosa 1.4	6H	1.4	44	07.99 - 10.00	AKK	4	1,1	PZFR5D-11	7968	34	LPG 6
Arosa 1.4	6H	1.4	44	07.99 - 10.00	ANW	4	1,1	PZFR5D-11	7968	34	LPG 6
Arosa 1.4	6H	1.4	44	09.00 - 06.04	AUD	4	1,1	PZFR5D-11	7968	34	LPG 6
Arosa 16V	6H	1.4	55	01.98 -	AHW	4		BKUR6ET-10	2397	24	LPG 1
Arosa 1.4 TDI Fgst >6H-2-009 700	6H	1.4	55	09.99 - 06.04	AMF	3	█	Y-732J	5605	4	
Arosa 1.4 TDI Fgst 6H-2-009 701>	6H	1.4	55	09.99 - 06.04	AMF	3	█	Y-741U	6943	20	
Arosa 1.4 16V	6H	1.4	74	01.99 - 09.00	AFK	4		BKUR6ET-10	2397	24	LPG 1
Arosa 1.4 16V	6H	1.4	74	01.99 -	ANM	4		BKUR6ET-10	2397	24	LPG 1
Arosa 1.4 16V	6H	1.4	74	10.99 - 09.00	AQQ	4		BKUR6ET-10	2397	24	LPG 1
Arosa 1.4 16V	6H	1.4	74	09.00 - 06.04	AUB	4		BKUR6ET-10	2397	24	LPG 1
Arosa 1.7 SDI	6H	1.7	44	08.97 - 10.03	AKU	4	█	Y-732J	5605	4	

**CORDOBA**

Cordoba / Vario		1.0	37	09.96 -	AER	4		BUR6ET	3172	1	LPG 2
Cordoba / Vario		1.0	37	08.99 - 08.02	ALD	4	1,1	PZFR5D-11	7968	34	LPG 6
Cordoba / Vario		1.0	37	08.99 - 07.00	ANV	4	1,1	PZFR5D-11	7968	34	LPG 6
Cordoba		1.0	37	07.00 -	AUC	4	1,1	PZFR5D-11	7968	34	LPG 6
Cordoba		1.0	51	05.00 -	AVZ	4		BKUR6ETB-10	5742		
Cordoba 12V		1.2	47	05.05 - 06.06	BME	3	0,9	ZFR5P-G	6893		LPG 6
Cordoba		1.3	40	02.93 - 08.94	2G	4		BUR6ET	3172	1	LPG 2
Cordoba		1.3	40	02.93 - 08.94	AAV	4		BP5ET	2287		LPG 2
Cordoba		1.4	40	01.98 -	ANX	4		BUR6ET	3172	1	LPG 2
Cordoba		1.4	44	09.93 - 12.95	ABD	4		BP5ET	2287		LPG 2
Cordoba / Vario		1.4	44	09.95 - 12.97	AEX	4		BUR6ET	3172	1	LPG 2
Cordoba / Vario		1.4	44	09.97 -	AKV	4		BUR6ET	3172	1	LPG 2
Cordoba / Vario		1.4	44	12.97 - 05.98	APQ	4		BUR6ET	3172	1	LPG 2
Cordoba / Vario		1.4	44	08.99 - 08.02	AKK	4	1,1	PZFR5D-11	7968	34	LPG 6
Cordoba / Vario		1.4	44	05.99 - 08.00	ANW	4	1,1	PZFR5D-11	7968	34	LPG 6
Cordoba / Vario		1.4	44	06.00 -	AUD	4	1,1	PZFR5D-11	7968	34	LPG 6
Cordoba TDI		1.4	51	05.05 -	BNM	3	█	Y-741U	6943	20	

Fgst = Chassis No.

Code *l* kW

Cyl.



Stock-No.



LPG/CNG

**SEAT  
CORDOBA**

Cordoba 16V		1.4	55	05.99 - 06.00	APE	4		BKUR6ET-10	2397	24	LPG 1
Cordoba 16V		1.4	55	06.00 -	AUA	4		BKUR6ET-10	2397	24	LPG 1
Cordoba 16V Automatic		1.4	55	09.02 - 04.04	BBY	4	1,1	PZFR5D-11	7968	34	LPG 6
Cordoba TDI		1.4	55	10.02 - 04.04	AMF	3	■	Y-741U	6943	20	
Cordoba 16V		1.4	55	05.04 -	BKY	4		BKUR6ET-10	2397	24	LPG 1
Cordoba 16V Automatic		1.4	55	05.04 -	BKY	4	1,1	PZFR5D-11	7968	34	LPG 6
Cordoba TDI		1.4	58	05.05 -	BNV	3	■	Y-741U	6943	20	
Cordoba TDI PD		1.4	59	06.06 - 12.06	BMS	3	■	CZ104	9826	52	
Cordoba		1.4	63	05.06 -	BXW	4	1,1	ZFR6T-11G	5960		
Cordoba / Vario 16V		1.4	74	06.97 -	AFH	4		BKUR6ET	6437	27	LPG 1
Cordoba / Vario 16V		1.4	74	09.99 - 07.00	AQQ	4		BKUR6ET-10	2397	24	LPG 1
Cordoba / Vario 16V		1.4	74	07.00 -	AUB	4		BKUR6ET-10	2397	24	LPG 1
Cordoba 16V		1.4	74	05.05 -	BBZ	4		BKUR6ET-10	2397	24	LPG 1
Cordoba		1.6	52	11.93 -	ABM	4		BUR5ET	3377	22	LPG 2
Cordoba		1.6	55	02.93 - 07.94	ABU	4		BUR6ET	3172	1	LPG 2
Cordoba / Vario		1.6	55	09.94 - 09.97	1F	4		BUR5ET	3377	22	LPG 2
Cordoba / Vario		1.6	55	05.97 - 12.98	AEE	4		BUR6ET	3172	1	LPG 2
Cordoba / Vario		1.6	55	09.97 - 08.02	ALM	4		BUR6ET	3172	1	LPG 2
Cordoba		1.6	74			4		BUR5ET	3377	22	LPG 2
Cordoba / Vario		1.6	74	09.95 - 05.98	AFT	4		BKUR6ET-10	2397	24	LPG 1
Cordoba		1.6	74	01.96 -	AEK	4		BKUR5ET	2789	29	LPG 1
Cordoba		1.6	74	05.99 - 08.02	AKL	4		BKUR6ET-10	2397	24	LPG 1
Cordoba / Vario		1.6	74	05.99 - 08.02	AEH	4		BKUR6ET-10	2397	24	LPG 1
Cordoba / Vario		1.6	74	03.00 - 10.00	APF	4		BKUR6ET-10	2397	24	LPG 1
Cordoba / Vario		1.6	74	05.00 -	AUR	4		BKUR6ET-10	2397	24	LPG 1
Cordoba		1.6	77	11.06 -	BTS	4	1,1	ZFR6T-11G	5960		
Cordoba		1.8	55	08.91 -	AAM	4		BUR5ET	3377	22	LPG 2
Cordoba		1.8	66	02.93 - 08.94	ABS	4		BUR6ET	3172	1	LPG 2
Cordoba / Vario		1.8	66	07.94 -	ADZ	4		BUR6ET	3172	1	LPG 2
Cordoba		1.8	66	07.96 -	ACC	4		BUR6ET	3172	1	LPG 2
Cordoba		1.8	95	02.94 - 06.96	ADL	4		BKUR7ET	7873		
Cordoba 16V		1.8	100			4		BUR6ET	3172	1	LPG 2
Cordoba 20V		1.8	115	12.99 -	AQX	4		BKUR6ET-10	2397	24	LPG 1
Cordoba		1.8	115	09.00 -	AYP	4		BKUR6ET-10	2397	24	LPG 1
Cordoba / Vario D		1.9	47	02.93 -	1Y	4	■	Y-918J	6285	2	
Cordoba / Vario SDI		1.9	47	07.96 -	AEY	4	■	Y-732J	5605	4	
Cordoba SDI		1.9	47	09.02 - 04.04	ASY	4	■	Y-732J	5605	4	
Cordoba SDI		1.9	50	04.99 - 08.02	AGP	4	■	Y-732J	5605	4	
Cordoba SDI		1.9	50	06.99 - 08.02	AQM	4	■	Y-732J	5605	4	
Cordoba / Vario TD		1.9	55	02.93 - 08.97	AAZ	4	■	Y-918J	6285	2	
Cordoba / Vario TDI		1.9	66	07.95 - 12.96	1Z	4	■	Y-732J	5605	4	
Cordoba / Vario TDI		1.9	66	12.96 -	AHU	4	■	Y-732J	5605	4	
Cordoba TDI		1.9	66	04.99 - 08.02	AGR	4	■	Y-732J	5605	4	
Cordoba TDI		1.9	66	10.99 - 05.01	ALH	4	■	Y-732J	5605	4	
Cordoba TDI		1.9	74	09.02 - 04.04	ATD	4	■	Y-741U	6943	20	
Cordoba TDI		1.9	74	05.05 -	AXR	4	■	Y-741U	6943	20	
Cordoba TDI		1.9	74	09.06 - 12.06	BMT	4	■	CZ104	9826	52	
Cordoba / Vario TDI		1.9	81	03.97 -	AFN	4	■	Y-732J	5605	4	
Cordoba TDI		1.9	81	03.99 - 08.02	ASV	4	■	Y-732J	5605	4	
Cordoba TDI		1.9	96	10.02 - 04.04	ASZ	4	■	Y-741U	6943	20	
Cordoba TDI		1.9	96	05.05 -	BLT	4	■	Y-741U	6943	20	

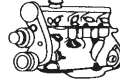

Code *l* kW

Cyl.



Stock-No.



LPG/CNG

**SEAT****CORDOBA**

Cordoba		2.0	85	02.93 - 06.96	2E	4		BUR6ET	3172	1	LPG 2
Cordoba / Vario		2.0	85	04.96 -	AGG	4		BUR6ET	3172	1	LPG 2
Cordoba		2.0	85	09.02 -	AZL	4		BKUR6ET-10	2397	24	LPG 1
Cordoba		2.0	85	04.03 -	BBX	4		BKUR6ET-10	2397	24	LPG 1
Cordoba 16V		2.0	110	07.96 -	ABF	4		BKUR6ET-10	2397	24	LPG 1

**EXEO**

Exeo 1.6	3R2/3R5	1.6	75	03.09 - 09.10	ALZ	4		BKUR6ET-10	2397	24	LPG 1
Exeo 1.8 TSI	3R2/3R5	1.8	88	09.10 - 05.13	CDHA	4	0,8	PFR7S8EG	1675		PFR8S8EG
Exeo 1.8 T	3R2/3R5	1.8	110	12.08 - 05.10	CFMA	4		BKUR6ET-10	2397	24	LPG 1
Exeo 1.8 TSI	3R2/3R5	1.8	118	05.10 - 05.13	CDHB	4	0,8	PFR7S8EG	1675		PFR8S8EG
Exeo 2.0 TDI	3R2/3R5	2.0	88	12.08 - 05.13	CAGC	4	█	Y1002AS	8888	57	
Exeo 2.0 TDI	3R2/3R5	2.0	88	12.08 - 05.13	CJCC	4	█	Y1002AS	8888	57	
Exeo 2.0 TDI	3R2/3R5	2.0	105	12.08 - 05.13	CAGA	4	█	Y1002AS	8888	57	
Exeo 2.0 TDI	3R2/3R5	2.0	105	12.08 - 05.13	CJCA	4	█	Y1002AS	8888	57	
Exeo 2.0 TDI	3R2/3R5	2.0	125	02.09 - 05.13	CAHA	4	█	Y1002AS	8888	57	
Exeo 2.0 TDI	3R2/3R5	2.0	125	02.09 - 05.13	CGLB	4	█	Y1002AS	8888	57	
Exeo 2.0 TFSI	3R2/3R5	2.0	147	03.09 - 05.13	BWE	4	0,8	PFR7S8EG	1675		PFR8S8EG
Exeo 2.0 TFSI	3R2/3R5	2.0	155	05.10 - 05.13	CDND	4	0,8	PFR7S8EG	1675		PFR8S8EG

**IBIZA 1**

Ibiza 1 0.9	021A	0.9	29	06.84 - 09.93	NCA	4	0,8	BPR6ES	7822	2	LPG 2
Ibiza 1 1,2i	021A	1.2	52	08.89 - 03.93	021-C-1000	4	0,9	BCP7ES	5030		BCPR7EIX
Ibiza 1 1,5i	021A	1.5	66	09.87 - 09.93	021-C-2000	4	0,9	BCP7ES	5030		BCPR7EIX
Ibiza 1 1.7 D	021A	1.7	42	09.87 - 05.93	022A5000	4	█	Y-924J	7906	1	
Ibiza 1 1,7	021A	1.7	72	01.91 - 05.93	021A3000	4	0,9	BCP7ES	5030		BCPR7EIX

**IBIZA 2**

Ibiza 2 1.0	6K1	1.0	33	03.93 - 09.96	AAU	4		BP5ET	2287		LPG 2
Ibiza 2 1.0	6K1	1.0	37	09.96 - 08.99	AER	4		BUR6ET	3172	1	LPG 2
Ibiza 2 1.3	6K1	1.3	40	02.93 - 08.94	2G	4		BP6ET	1263		LPG 2
Ibiza 2 1.3	6K1	1.3	40	02.93 - 08.94	AAV	4		BP5ET	2287		LPG 2
Ibiza 2 1.4	6K1	1.4	44	09.93 - 12.95	ABD	4		BP5ET	2287		LPG 2
Ibiza 2 1.4	6K1	1.4	44	09.95 - 12.97	AEX	4		BUR6ET	3172	1	LPG 2
Ibiza 2 1.4	6K1	1.4	44	09.97 - 08.99	AKV	4		BUR6ET	3172	1	LPG 2
Ibiza 2 1.4	6K1	1.4	44	12.97 - 05.98	APQ	4		BUR6ET	3172	1	LPG 2
Ibiza 2 1.4 16V	6K1	1.4	74	06.97 - 08.99	AFH	4		BKUR6ET	6437	27	LPG 1
Ibiza 2 1.6	6K1	1.6	55	02.93 - 07.94	ABU	4		BUR6ET	3172	1	LPG 2
Ibiza 2 1.6	6K1	1.6	55	09.94 - 09.97	1F	4		BUR5ET	3377	22	LPG 2
Ibiza 2 1.6	6K1	1.6	55	05.97 - 12.98	AEE	4		BUR6ET	3172	1	LPG 2
Ibiza 2 1.6	6K1	1.6	55	09.97 - 05.02	ALM	4		BUR6ET	3172	1	LPG 2
Ibiza 2 1.6	6K1	1.6	74	09.95 - 05.98	AFT	4		BKUR6ET-10	2397	24	LPG 1
Ibiza 2 1.8	6K1	1.8	66	02.93 - 08.94	ABS	4		BUR6ET	3172	1	LPG 2
Ibiza 2 1.8	6K1	1.8	66	07.94 - 08.99	ADZ	4		BUR6ET	3172	1	LPG 2
Ibiza 2 1.8 16V	6K1	1.8	95	02.94 - 06.96	ADL	4		BKUR7ET	7873		
Ibiza 2 1.9 D	6K1	1.9	47	02.93 - 08.96	1Y	4	█	Y-918J	6285	2	
Ibiza 2 1.9 SDI	6K1	1.9	47	07.96 - 08.99	AEY	4	█	Y-732J	5605	4	
Ibiza 2 1.9 TD	6K1	1.9	55	02.93 - 08.96	AAZ	4	█	Y-918J	6285	2	
Ibiza 2 1.9 TDI	6K1	1.9	66	07.96 - 12.96	1Z	4	█	Y-732J	5605	4	
Ibiza 2 1.9 TDI	6K1	1.9	66	12.96 - 08.99	AHU	4	█	Y-732J	5605	4	
Ibiza 2 1.9 TDI	6K1	1.9	81	03.97 - 08.99	AFN	4	█	Y-732J	5605	4	
Ibiza 2 2.0	6K1	2.0	85	02.93 - 06.96	2E	4		BUR6ET	3172	1	LPG 2
Ibiza 2 2.0	6K1	2.0	85	04.96 - 08.99	AGG	4		BUR6ET	3172	1	LPG 2

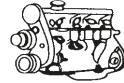
Code *l* kW

Cyl.



Stock-No.



LPG/CNG

**SEAT  
IBIZA 2**

Ibiza 2 2.0 16V	6K1	2.0	110	07.96 - 08.99	ABF	4		BKUR6ET-10	2397	24	LPG 1
-----------------	-----	-----	-----	---------------	-----	---	--	------------	------	----	-------

**IBIZA 3**

Ibiza 3 1.0	6K1	1.0	37	08.99 - 05.02	ALD	4	1,1	PZFR5D-11	7968	34	LPG 6
Ibiza 3 1.0	6K1	1.0	37	08.99 - 07.00	ANV	4	1,1	PZFR5D-11	7968	34	LPG 6
Ibiza 3 1.0	6K1	1.0	37	07.00 - 05.02	AUC	4	1,1	PZFR5D-11	7968	34	LPG 6
Ibiza 3 1.4	6K1	1.4	44	08.99 - 05.02	AKK	4	1,1	PZFR5D-11	7968	34	LPG 6
Ibiza 3 1.4	6K1	1.4	44	05.99 - 08.00	ANW	4	1,1	PZFR5D-11	7968	34	LPG 6
Ibiza 3 1.4	6K1	1.4	44	06.00 - 05.02	AUD	4	1,1	PZFR5D-11	7968	34	LPG 6
Ibiza 3 1.4 16V	6K1	1.4	55	09.99 - 06.00	APE	4		BKUR6ET-10	2397	24	LPG 1
Ibiza 3 1.4 16V	6K1	1.4	55	06.00 - 05.02	AUA	4		BKUR6ET-10	2397	24	LPG 1
Ibiza 3 1.4 16V	6K1	1.4	74	09.99 - 07.00	AQQ	4		BKUR6ET-10	2397	24	LPG 1
Ibiza 3 1.4 16V	6K1	1.4	74	07.00 - 05.02	AUB	4		BKUR6ET-10	2397	24	LPG 1
Ibiza 3 1.6	6K1	1.6	74	05.99 - 05.02	AEH	4		BKUR6ET-10	2397	24	LPG 1
Ibiza 3 1.6	6K1	1.6	74	06.99 - 05.02	AKL	4		BKUR6ET-10	2397	24	LPG 1
Ibiza 3 1.6	6K1	1.6	74	03.00 - 02.02	APF	4		BKUR6ET-10	2397	24	LPG 1
Ibiza 3 1.6	6K1	1.6	74	05.00 - 05.02	AUR	4		BKUR6ET-10	2397	24	LPG 1
Ibiza 3 1.8T 20V Cupra	6K1	1.8	115	12.99 - 02.02	AQX	5		BKUR6ET-10	2397	24	LPG 1
Ibiza 3 1.8T 20V Cupra	6K1	1.8	115	05.00 - 05.02	AYP	5		BKUR6ET-10	2397	24	LPG 1
Ibiza 3 1.9 SDI	6K1	1.9	50	04.99 - 05.02	AGP	4	☑	Y-732J	5605	4	
Ibiza 3 1.9 SDI	6K1	1.9	50	05.99 - 05.02	AQM	4	☑	Y-732J	5605	4	
Ibiza 3 1.9 TDI	6K1	1.9	66	04.99 - 05.02	AGR	4	☑	Y-732J	5605	4	
Ibiza 3 1.9 TDI	6K1	1.9	66	05.99 - 05.02	ALH	4	☑	Y-732J	5605	4	
Ibiza 3 1.9 TDI	6K1	1.9	81	03.99 - 05.02	ASV	4	☑	Y-732J	5605	4	

**IBIZA 4**

Ibiza 4 1.2	6L1	1.2	44	06.07 - 05.08	BBM	3	0,9	ZFR5P-G	6893		LPG 6
Ibiza 4 1.2	6L1	1.2	47	01.02 - 06.06	AZQ	3	0,9	ZFR5P-G	6893		LPG 6
Ibiza 4 1.2	6L1	1.2	47	05.05 - 06.06	BME	3	0,9	ZFR5P-G	6893		LPG 6
Ibiza 4 1.2 12V	6L1	1.2	51	05.06 - 11.09	BXV	3	0,9	ZFR5P-G	6893		LPG 6
Ibiza 4 1.4 TDI	6L1	1.4	51	05.05 - 11.09	BNM	3	☑	Y-741U	6943	20	
Ibiza 4 1.4	6L1	1.4	55	01.02 - 04.04	BBY	4		BKUR6ET-10	2397	24	LPG 1
Ibiza 4 1.4 Automatic	6L1	1.4	55	01.02 - 04.04	BBY	4	1,1	PZFR5D-11	7968	34	LPG 6
Ibiza 4 1.4	6L1	1.4	55	05.04 - 06.06	BKY	4		BKUR6ET-10	2397	24	LPG 1
Ibiza 4 1.4 Automatic	6L1	1.4	55	05.04 - 06.06	BKY	4	1,1	PZFR5D-11	7968	34	LPG 6
Ibiza 4 1.4 TDI Fgst 6L-2-001 501>	6L1	1.4	55	05.05 - 12.05	AMF	3	☑	Y-741U	6943	20	
Ibiza 4 1.4 TDI	6L1	1.4	59	05.05 - 11.09	BNV	3	☑	Y-741U	6943	20	
Ibiza 4 1.4 16V	6L1	1.4	74	04.02 - 11.09	BBZ	4		BKUR6ET-10	2397	24	LPG 1
Ibiza 4 1.6	6L1	1.6	74	01.07 - 11.09	BAH	4	1,1	PZFR5D-11	7968	34	LPG 6
Ibiza 4 1.8T FR	6L1	1.8	110	12.03 - 05.08	BJX	4	0,8	PFR6Q	6458	37	LPG 1
Ibiza 4 1.8T FR	6L1	1.8	110	12.03 - 05.08	BKV	4	0,8	PFR6Q	6458	37	LPG 1
Ibiza 4 1.8T Cupra R	6L1	1.8	132	05.04 - 02.08	BBU	4	0,8	PFR6Q	6458	37	LPG 1
Ibiza 4 1.9 SDI	6L1	1.9	47	05.05 - 12.05	ASY	4	☑	Y-732J	5605	4	
Ibiza 4 1.9 TDI Fgst 6L-2-001 501>	6L1	1.9	74	05.05 - 05.05	ATD	4	☑	Y-741U	6943	20	
Ibiza 4 1.9 TDI	6L1	1.9	74	09.06 - 11.09	BMT	4	☑	CZ104	9826	52	
Ibiza 4 1.9 TDI	6L1	1.9	74	05.05 - 11.09	AXR	4	☑	Y-741U	6943	20	
Ibiza 4 1.9 TDI	6L1	1.9	96	05.05 - 11.09	BLT	4	☑	Y-741U	6943	20	
Ibiza 4 1.9 TDI Fgst 6L-2-001 501>	6L1	1.9	96	05.05 - 09.05	ASZ	4	☑	Y-741U	6943	20	
Ibiza 4 1.9 TDI Cupra R	6L1	1.9	118	03.04 - 02.08	BPX	4	☑	Y-741U	6943	20	
Ibiza 4 1.9 TDI Cupra R	6L1	1.9	118	11.05 - 02.08	BUK	4	☑	Y-741U	6943	20	
Ibiza 4 2.0	6L1	2.0	85	07.02 - 04.04	AZL	4		BKUR6ET-10	2397	24	LPG 1
Ibiza 4 2.0	6L1	2.0	85	04.03 - 11.09	BBX	4		BKUR6ET-10	2397	24	LPG 1

Fgst = Chassis No.

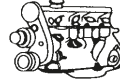
Code *l* kW

Cyl.

Stock-No.  
**VEFINE**  
BY-PROMOTER

LPG/CNG

**SEAT****IBIZA 5**

Ibiza 5 1.2	6J5	1.2	44	07.09 -	CGPB	3	1,1	ZFR6T-11G	5960		
Ibiza 5 1.2	6J5	1.2	51	03.08 -	BZG	3	0,9	ZFR5P-G	6893		LPG 6
Ibiza 5 1.2	6J5	1.2	51	05.09 -	CGPA	3	0,9	ZFR6T-11G	5960		
Ibiza 5 1.2 TDI	6J5	1.2	55	05.10 -	CFWA	3	█	Y1002AS	8888	57	
Ibiza 5 1.2 TSI	6J5	1.2	77	09.10 -	CBZB	4	0,7	IZFR6P7	97153		
Ibiza 5 1.4 TDI	6J5	1.4	59	07.08 - 06.10	BMS	3	█	CZ104	9826	52	
Ibiza 5 1.4	6J5	1.4	63	03.08 -	BXW	4	1,1	ZFR6T-11G	5960		
Ibiza 5 1.4	6J5	1.4	63	07.08 -	CGGB	4	1,1	ZFR6T-11G	5960		
Ibiza 5 1.4 TSI	6J5	1.4	110	06.09 -	CAVF	4	0,8	SIZFR6B8EG	96209		
Ibiza 5 1.4 TSI Cupra	6J5	1.4	132	05.09 -	CAVE	4	0,8	SIZFR6B8EG	96209		
Ibiza 5 1.6 TDI	6J5	1.6	66	05.09 -	CAYB	4	█	Y1002AS	8888	57	
Ibiza 5 1.6	6J5	1.6	77	11.06 -	BTS	4	1,1	ZFR6T-11G	5960		
Ibiza 5 1.6 TDI	6J5	1.6	77	05.09 -	CAYC / CLNA	4	█	Y1002AS	8888	57	
Ibiza 5 1.9 TDI	6J5	1.9	66	06.08 - 06.10	BXJ	4	█	Y-607AS	7560	50	
Ibiza 5 1.9 TDI	6J5	1.9	77	02.08 - 06.10	BLS	4	█	Y-607AS	7560	50	
Ibiza 5 2.0 TDI	6J5	2.0	105	01.10 -	CFHD	4	█	Y1002AS	8888	57	

**INCA**

Inca	6K9	1.4	44	11.95 - 12.97	AEX	4		BUR6ET	3172	1	LPG 2
Inca	6K9	1.4	44	12.97 - 09.00	AKV	4		BUR6ET	3172	1	LPG 2
Inca	6K9	1.4	44	12.97 - 06.03	APQ	4		BUR6ET	3172	1	LPG 2
Inca	6K9	1.4	44	09.00 - 06.03	AUD	4	1,1	PZFR5D-11	7968	34	LPG 6
Inca 16V	6K9	1.4	55	09.00 - 06.03	AUA	4		BKUR6ET-10	2397	24	LPG 1
Inca	6K9	1.6	55	11.95 - 05.97	1F	4		BUR5ET	3377	22	LPG 2
Inca	6K9	1.6	55	06.97 - 09.00	AEE	4		BUR6ET	3172	1	LPG 2
Inca D	6K9	1.7	42	07.96 - 09.00	AHB	4	█	Y-918J	6285	2	
Inca D	6K9	1.9	47	11.95 - 06.03	1Y	4	█	Y-918J	6285	2	
Inca SDI	6K9	1.9	47	11.95 - 09.00	AEY	4	█	Y-732J	5605	4	
Inca SDI	6K9	1.9	47	09.00 - 06.03	AYQ	4	█	Y-732J	5605	4	

**LEÓN 1**

León 1 1.4 16V	1M1	1.4	55	11.99 - 05.00	APE	4		BKUR6ET-10	2397	24	LPG 1
León 1 1.4 16V	1M1	1.4	55	01.00 - 05.02	AHW	4		BKUR6ET-10	2397	24	LPG 1
León 1 1.4 16V	1M1	1.4	55	00 -	AKQ	4		BKUR6ET-10	2397	24	LPG 1
León 1 1.4 16V	1M1	1.4	55	06.00 - 02.02	AXP	4		BKUR6ET-10	2397	24	LPG 1
León 1 1.4 16V	1M1	1.4	55	02.02 - 10.05	BCA	4		BKUR6ET-10	2397	24	LPG 1
León 1 1.6	1M1	1.6	74	11.98 - 10.05	AEH	4		BKUR6ET-10	2397	24	LPG 1
León 1 1.6	1M1	1.6	74	10.98 - 10.05	AKL	4		BKUR6ET-10	2397	24	LPG 1
León 1 1.6	1M1	1.6	75	10.05 -	BFQ	4		BKUR6ET-10	2397	24	LPG 1
León 1 1.6 16V	1M1	1.6	77	11.99 -	ATN	4		BKUR6ET-10	2397	24	LPG 1
León 1 1.6 16V	1M1	1.6	77	06.00 - 04.01	AUS	4		BKUR6ET-10	2397	24	LPG 1
León 1 1.6 16V	1M1	1.6	77	05.01 - 04.02	AZD	4	1,1	PZFR6J-11	3586		LPG 6
León 1 1.6 16V	1M1	1.6	77	04.02 - 06.06	BCB	4	1,1	PZFR6J-11	3586		LPG 6
León 1 1.8 20V	1M1	1.8	92	10.98 - 12.03	AGN	4		BKUR6ET-10	2397	24	LPG 1
León 1 1.8 20V T	1M1	1.8	132	11.99 -	APP	4	0,8	PFR6Q	6458	37	LPG 1
León 1 1.8 20V T4	1M1	1.8	132	04.00 -	AJQ	4	0,8	PFR6Q	6458	37	LPG 1
León 1 1.8 20V	1M1	1.8	132	06.00 - 10.05	APG	4		BKUR6ET-10	2397	24	LPG 1
León 1 1.8 20V T4	1M1	1.8	132	09.00 - 04.04	ARY	4	0,8	PFR6Q	6458	37	LPG 1
León 1 1.8 20V T	1M1	1.8	132	09.00 - 10.05	AUQ	4	0,8	PFR6Q	6458	37	LPG 1
León 1 1.8 20V T	1M1	1.8	132	05.01 - 10.05	AUQ	4	0,8	PFR6Q	6458	37	LPG 1
León 1 1.8T Cupra R	1M1	1.8	154	05.02 - 05.03	AMK	4	0,8	PFR6Q	6458	37	LPG 1
León 1 1.8T Cupra R	1M1	1.8	165	05.03 -	BAM	4	0,8	PFR6Q	6458	37	LPG 1

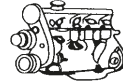
Code *l* kW

Cyl.

Stock-No.  
**VLINE**  
BY-PRO-WERK

LPG/CNG

**SEAT  
LEÓN 1**

León 1 1.9 SDI	1M1	1.9	50	03.00 - 10.03	AQM	4	<input checked="" type="checkbox"/>	Y-732J	5605	4	
León 1 1.9 TDI	1M1	1.9	66	04.99 - 09.02	AGR	4	<input checked="" type="checkbox"/>	Y-732J	5605	4	
León 1 1.9 TDI	1M1	1.9	66	03.99 - 10.05	ALH	4	<input checked="" type="checkbox"/>	Y-732J	5605	4	
León 1 1.9 TDI	1M1	1.9	81	10.98 - 09.02	AHF	4	<input checked="" type="checkbox"/>	Y-732J	5605	4	
León 1 1.9 TDI	1M1	1.9	81	11.99 - 10.05	ASV	4	<input checked="" type="checkbox"/>	Y-732J	5605	4	
León 1 1.9 TDI	1M1	1.9	96	05.03 - 06.06	ASZ	4	<input checked="" type="checkbox"/>	Y-741U	6943	20	
León 1 1.9 TDI Fgst >1M-2-062000	1M1	1.9	110	09.00 -	ARL	4	<input checked="" type="checkbox"/>	Y-732J	5605	4	
León 1 1.9 TDI Fgst 1M-2-062001 >	1M1	1.9	110	09.00 - 12.05	ARL	4	<input checked="" type="checkbox"/>	Y-741U	6943	20	
León 1 2.8 Cupra 4	1M1	2.8	150	05.01 - 07.01	AUE	6	1,1	PZFR5D-11	7968	34	LPG 6
León 1 2.8 Cupra 4	1M1	2.8	150	06.01 - 04.04	BDE	6	1,1	PZFR5D-11	7968	34	LPG 6

**LEÓN 2**

León 2 1.2 TSI	1P1	1.2	77	02.10 -	CBZB	4	0,7	IZFR6P7	97153		
León 2 1.4 16V	1P1	1.4	63	06.06 -	BXW	4	1,1	ZFR6T-11G	5960		
León 2 1.4 16V	1P1	1.4	63	05.10 -	CGGB	4	0,8	PZFR6R8EG	96498		
León 2 1.4 TFSI	1P1	1.4	92	11.07 -	CAXC	4	0,9	PZFR6R	5758		
León 2 1.6	1P1	1.6	75	07.05 -	BSE	4		BKUR6ET-10	2397	24	LPG 1
León 2 1.6	1P1	1.6	75	07.05 -	BSF	4		BKUR6ET-10	2397	24	LPG 1
León 2 1.6	1P1	1.6	75	10.09 -	CCSA	4		BKUR6ET-10	2397	24	LPG 1
León 2 1.6 LPG	1P1	1.6	75	12.09 -	CHGA	4		BKUR6ET-10	2397	24	LPG 1
León 2 1.6 TDI	1P1	1.6	77	02.10 -	CAYC	4	<input checked="" type="checkbox"/>	Y1002AS	8888	57	
León 2 1.8 TFSI	1P1	1.8	118	05.07 - 03.09	BZB	4	0,8	PFR7S8EG	1675		PFR8S8EG
León 2 1.8 TFSI	1P1	1.8	118	03.09 -	CDA A	4	0,8	PFR7S8EG	1675		PFR8S8EG
León 2 1.9 TDI	1P1	1.9	66	06.07 -	BXF	4	<input checked="" type="checkbox"/>	Y-607AS	7560	50	
León 2 1.9 TDI	1P1	1.9	77	07.05 - 02.06	BKC	4	<input checked="" type="checkbox"/>	Y-607AS	7560	50	
León 2 1.9 TDI	1P1	1.9	77	11.05 -	BLS	4	<input checked="" type="checkbox"/>	CZ104	9826	52	
León 2 1.9 TDI	1P1	1.9	77	02.06 -	BXE	4	<input checked="" type="checkbox"/>	Y-607AS	7560	50	
León 2 2.0 TDI	1P1	2.0	100	07.05 - 03.09	AZV	4	<input checked="" type="checkbox"/>	YE14	7768	48	
León 2 2.0 TDI 16V	1P1	2.0	103	07.05 -	BKD	4	<input checked="" type="checkbox"/>	YE14	7768	48	
León 2 2.0 TDI	1P1	2.0	103	10.05 -	BMM	4	<input checked="" type="checkbox"/>	Y-607AS	7560	50	
León 2 2.0 FSI	1P1	2.0	110	07.05 - 11.05	BLR	4		PZFR5N-11T	7742		
León 2 2.0 FSI	1P1	2.0	110	07.05 - 11.05	BLY	4		PZFR5N-11T	7742		
León 2 2.0 FSI	1P1	2.0	110	11.05 - 03.09	BVY	4		PZFR5N-11T	7742		
León 2 2.0 FSI	1P1	2.0	110	11.05 -	BVZ	4		PZFR5N-11T	7742		
León 2 2.0 TDI	1P1	2.0	125	05.06 - 03.09	BMN	4	<input checked="" type="checkbox"/>	CZ304	9864	55	
León 2 2.0 TDI	1P1	2.0	125	03.09 - 09.10	CEGA	4	<input checked="" type="checkbox"/>	Y-609AS	5849	49	
León 2 2.0 TFSI	1P1	2.0	136	10.05 - 05.06	BWA1	4	0,8	PFR7S8EG	1675		PFR8S8EG
León 2 2.0 TFSI	1P1	2.0	147	05.05 - 03.09	BWA	4	0,8	PFR7S8EG	1675		PFR8S8EG
León 2 2.0 TFSI	1P1	2.0	155	06.09 -	CCZB	4	0,8	PFR7S8EG	1675		PFR8S8EG
León 2 2.0 TFSI	1P1	2.0	177	11.06 - 05.09	BWJ	4	0,8	PFR7S8EG	1675		PFR8S8EG
León 2 2.0 TFSI	1P1	2.0	177	06.09 -	CDLD	4	0,8	PFR7S8EG	1675		PFR8S8EG
León 2 2.0 TSI Cupra R	1P1	2.0	195	09.09 -	CDLA	4	0,8	PFR7S8EG	1675		PFR8S8EG

**LEÓN 3**

León 3 1.2 TSI	5F1/5F5	1.2	63	01.13 -	CJZB	4	0,8	PZKER7A8EGS	94968		
León 3 1.2 TSI	5F1/5F5	1.2	77	01.13 -	CJZA	4	0,8	PZKER7A8EGS	94968		
León 3 1.4 TSI	5F1/5F5	1.4	90	10.12 -	CMBA	4	0,8	PZKER7A8EGS	94968		
León 3 1.4 TSI	5F1/5F5	1.4	103	09.12 -	CHPA	4	0,8	PZKER7A8EGS	94968		
León 3 1.4 TSI	5F1/5F5	1.4	103	09.12 -	CPTA	4	0,8	PZKER7A8EGS	94968		
León 3 1.6 TDI	5F1/5F5	1.6	66	11.12 -	CLHB	4	<input checked="" type="checkbox"/>	Y1002AS	8888	57	
nur für Zyl. ohne Drucksensor											

Fgst = Chassis No.

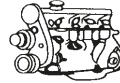
Code *l* kW

Cyl.

Stock-No.  
**V-TIME****B-FORMER**  
LPG/CNG**SEAT****LEÓN 3**

León 3 1.6 TDI nur für Zyl. ohne Drucksensor	5F1/5F5	1.6	77	09.12 -	CLHA	4		Y1002AS	8888	57	
León 3 1.6 TDI nur für Zyl. ohne Drucksensor	5F1/5F5	1.6	81	09.13 -	CRKB	4		Y1002AS	8888	57	
León 3 2.0 TDI nur für Zyl. ohne Drucksensor	5F1/5F5	2.0	110	10.12 -	CKFC	4		Y1002AS	8888	57	
León 3 2.0 TDI nur für Zyl. ohne Drucksensor	5F1/5F5	2.0	110	10.12 -	CRMB	4		Y1002AS	8888	57	
León 3 2.0 TDI nur für Zyl. ohne Drucksensor	5F1/5F5	2.0	135	09.12 -	CUPA	4		Y1002AS	8888	57	

**MARBELLA**

Marbella 0,9		0,9	29	86 - 12.92	09NCA Verg.	4	0,8	BPR6ES	7822	2	LPG 2
Marbella 0,9		0,9	30	92 - 05.98	09NCB Cat.	4	0,9	BPR5ES	7422	6	LPG 2

**MII**

Mii 1.0	KF1	1.0	44	10.11 -	CHYA	3	1,0	ZKER6A-10EG	96596		
Mii 1.0	KF1	1.0	55	10.11 -	CHYB	3	1,0	ZKER6A-10EG	96596		

**TERRA**

Terra 0,9		0,9	29	08.91 - 05.98	09NCB Cat.	4	0,9	BPR5ES	7422	6	LPG 2
Terra D		1.4	35	01.90 -		4		Y-918J	6285	2	
Terra D		1.4	35	10.90 -		4		Y-918J	6285	2	
Terra Kombi D		1.4		10.91 -	1W	4		Y-918J	6285	2	

**TOLEDO 1**

Toledo 1 1.6	1L	1.6	52	11.93 - 10.99	ABN	4		BUR5ET	3377	22	LPG 2
Toledo 1 1.6	1L	1.6	54	08.91 - 10.99	EZ	4		BUR5ET-10	7264	21	LPG 2
Toledo 1 1.6	1L	1.6	55	11.93 - 03.99	1F	4		BUR5ET	3377	22	LPG 2
Toledo 1 1.6	1L	1.6	55	03.93 -	ABU	4		BUR6ET	3172	1	LPG 2
Toledo 1 1.6	1L	1.6	74	04.96 - 03.99	AFT	4		BKUR6ET-10	2397	24	LPG 1
Toledo 1 1.8	1L	1.8	66	05.91 - 07.94	ABS	4		BUR6ET	3172	1	LPG 2
Toledo 1 1.8	1L	1.8	66	08.91 - 12.92	RP	4		BUR6ET	3172	1	LPG 2
Toledo 1 1.8	1L	1.8	66	11.94 - 05.99	ADZ	4		BUR6ET	3172	1	LPG 2
Toledo 1 1.8	1L	1.8	66	01.95 -	ACC	4		BUR6ET	3172	1	LPG 2
Toledo 1 1.8 16V	1L	1.8	92	08.91 - 05.94	PL	4		BKUR7ET	7873		
Toledo 1 1.8 16V	1L	1.8	98	08.91 -	KR	4		BCPR7ET	2164		BCPR7EIX
Toledo 1 1.9 D	1L	1.9	47	03.91 - 03.99	1Y	4		Y-918J	6285	2	
Toledo 1 1.9 TD	1L	1.9	55	03.91 - 04.97	AAZ	4		Y-918J	6285	2	
Toledo 1 1.9 TDI	1L	1.9	66	08.93 - 12.96	1Z	4		Y-732J	5605	4	
Toledo 1 1.9 TDI	1L	1.9	81	12.96 - 03.99	AFN	4		Y-732J	5605	4	
Toledo 1 2.0	1L	2.0	85	05.91 -	2E	4		BUR6ET	3172	1	LPG 2
Toledo 1 2.0	1L	2.0	85	07.95 - 03.99	AGG	4		BUR6ET	3172	1	LPG 2
Toledo 1 2.0 16V	1L	2.0	110	05.94 - 03.99	ABF	4		BKUR6ET-10	2397	24	LPG 1

**TOLEDO 2**

Toledo 2 1.4 16V	1M2	1.4	55	11.99 -	APE	4		BKUR6ET-10	2397	24	LPG 1
Toledo 2 1.4 16V	1M2	1.4	55	01.00 - 05.02	AHW	4		BKUR6ET-10	2397	24	LPG 1
Toledo 2 1.4 16V	1M2	1.4	55	06.00 -	AXP	4		BKUR6ET-10	2397	24	LPG 1
Toledo 2 1.4 16V	1M2	1.4	55	02.02 - 10.05	BCA	4		BKUR6ET-10	2397	24	LPG 1
Toledo 2 1.6	1M2	1.6	74	01.96 - 03	AEK	4		BKUR5ET	2789	29	LPG 1

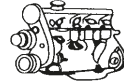

Code *l* kW

Cyl.

Stock-No.  
**VLINE**  
BY-PROFIT/VER

LPG/CNG

**SEAT  
TOLEDO 2**

Toledo 2 1.6	1M2	1.6	74	11.98 - 10.05	AEH	4		BKUR6ET-10	2397	24	LPG 1
Toledo 2 1.6	1M2	1.6	74	02.99 - 10.05	AKL	4		BKUR6ET-10	2397	24	LPG 1
Toledo 2 1.6	1M2	1.6	74	09.99 -	APF	4		BKUR6ET-10	2397	24	LPG 1
Toledo 2 1.6	1M2	1.6	75	10.05 -	BFQ	4		BKUR6ET-10	2397	24	LPG 1
Toledo 2 1.6	1M2	1.6	77	11.99 -	ATN	4		BKUR6ET-10	2397	24	LPG 1
Toledo 2 1.6 16V	1M2	1.6	77	06.00 -	AUS	4		BKUR6ET-10	2397	24	LPG 1
Toledo 2 1.6 16V	1M2	1.6	77	09.00 - 04.02	AZD	4		BKUR6ET-10	2397	24	LPG 1
Toledo 2 1.6 16V	1M2	1.6	77	04.02 - 05.06	BCB	4	1,1	PZFR6J-11	3586		LPG 6
Toledo 2 1.8 20V	1M2	1.8	92	10.98 - 12.03	AGN	4		BKUR6ET-10	2397	24	LPG 1
Toledo 2 1.8 20V	1M2	1.8	92	09.00 - 10.05	APG	4		BKUR6ET-10	2397	24	LPG 1
Toledo 2 1.8 20V T	1M2	1.8	132	11.99 -	APP	4	0,8	PFR6Q	6458	37	LPG 1
Toledo 2 1.8 20V T	1M2	1.8	132	03.00 - 01.01	AJQ	4	0,8	PFR6Q	6458	37	LPG 1
Toledo 2 1.8 20V T	1M2	1.8	132	05.01 - 04.04	ARY	4	0,8	PFR6Q	6458	37	LPG 1
Toledo 2 1.8 20V T	1M2	1.8	132	05.01 - 10.05	AUQ	4	0,8	PFR6Q	6458	37	LPG 1
Toledo 2 1.8 20V Cupra R	1M2	1.8	154	05.02 - 05.03	AMK	4	0,8	PFR6Q	6458	37	LPG 1
Toledo 2 1.8 20V Cupra R	1M2	1.8	165	05.03 -	BAM	4	0,8	PFR6Q	6458	37	LPG 1
Toledo 2 1.9 SDI	1M2	1.9	50	05.01 - 10.03	AQM	4	☑	Y-732J	5605	4	
Toledo 2 1.9 TDI	1M2	1.9	66	05.99 - 09.02	AGR	4	☑	Y-732J	5605	4	
Toledo 2 1.9 TDI	1M2	1.9	66	03.99 - 10.05	ALH	4	☑	Y-732J	5605	4	
Toledo 2 1.9 TDI	1M2	1.9	81	05.99 - 09.02	AHF	4	☑	Y-732J	5605	4	
Toledo 2 1.9 TDI	1M2	1.9	81	10.99 - 10.05	ASV	4	☑	Y-732J	5605	4	
Toledo 2 1.9 TDI	1M2	1.9	110	10.00 - 12.05	ARL	4	☑	Y-732J	5605	4	
Toledo 2 2.0	1M2	2.0	85	06.99 -	AQY	4		BKUR6ET-10	2397	24	LPG 1
Toledo 2 2.3 V5	1M2	2.3	110	10.98 - 11.00	AGZ	5		BKR5EKUP	2890		
Toledo 2 2.3 V5 20V	1M2	2.3	125	09.00 - 11.03	AQN	5	1,1	PZFR5D-11	7968	34	LPG 6
Toledo 2 2.8 V6	1M2	2.8	150	05.01 -	AUE	6	1,1	PZFR5D-11	7968	34	LPG 6
Toledo 2 2.8 V6	1M2	2.8	150	05.02 - 04.04	BDE	6	1,1	PZFR5D-11	7968	34	LPG 6

**TOLEDO 3**

Toledo 3 1.6	5P2	1.6	75	09.04 - 05.05	BGU	4		BKUR6ET-10	2397	24	LPG 1
Toledo 3 1.6	5P2	1.6	75	05.05 -	BSE	4		BKUR6ET-10	2397	24	LPG 1
Toledo 3 1.6	5P2	1.6	75	05.05 - 05.07	BSF	4		BKUR6ET-10	2397	24	LPG 1
Toledo 3 1.6	5P2	1.6	75	12.07 -	CCSA	4		BKUR6ET-10	2397	24	LPG 1
Toledo 3 1.8 TFSI	5P2	1.8	118	01.07 - 06.07	BYT	4	0,8	PFR7S8EG	1675		PFR8S8EG
Toledo 3 1.8 TFSI	5P2	1.8	118	06.07 - 03.09	BZB	4	0,8	PFR7S8EG	1675		PFR8S8EG
Toledo 3 1.8 TFSI	5P2	1.8	118	03.09 - 05.09	CDA	4	0,8	PFR7S8EG	1675		PFR8S8EG
Toledo 3 1.9 TDI	5P2	1.9	77	09.04 - 09.05	BJB	4	☑	Y-607AS	7560	50	
Toledo 3 1.9 TDI	5P2	1.9	77	09.04 - 02.06	BKC	4	☑	Y-607AS	7560	50	
Toledo 3 1.9 TDI	5P2	1.9	77	10.05 - 05.09	BLS	4	☑	CZ104	9826	52	
Toledo 3 1.9 TDI	5P2	1.9	77	02.06 - 05.09	BXE	4	☑	Y-607AS	7560	50	
Toledo 3 2.0 TDI	5P2	2.0	100	09.04 - 05.09	AZV	4	☑	YE14	7768	48	
Toledo 3 2.0 TDI 16V	5P2	2.0	103	04.04 - 05.09	BKD	4	☑	YE14	7768	48	
Toledo 3 2.0 TDI	5P2	2.0	103	11.05 - 05.09	BMM	4	☑	Y-607AS	7560	50	
Toledo 3 2.0 FSI	5P2	2.0	110	09.04 - 11.05	BLR	4		PZFR5N-11T	7742		
Toledo 3 2.0 FSI	5P2	2.0	110	11.04 - 11.05	BLY	4	0,9	BKR6E	6962	28	LPG 1
Toledo 3 2.0 FSI	5P2	2.0	110	11.05 - 03.09	BVY	4		PZFR5N-11T	7742		
Toledo 3 2.0 FSI	5P2	2.0	110	11.05 - 03.09	BVZ	4	0,9	BKR6E	6962	28	LPG 1
Toledo 3 2.0 TDI	5P2	2.0	125	01.06 - 05.09	BMN	4	☑	CZ304	9864	55	
Toledo 3 2.0 TDI	5P2	2.0	125	03.09 - 05.09	CEGA	4	☑	Y-609AS	5849	49	
Toledo 3 2.0 TFSI	5P2	2.0	147	11.05 - 05.09	BWA	4	0,8	PFR7S8EG	1675		PFR8S8EG

**TOLEDO 4**

Toledo 4 1.2	KG3	1.2	55	10.12 -	CGPC	3	0,9	ZFR6T-11G	5960		
--------------	-----	-----	----	---------	------	---	-----	-----------	------	--	--

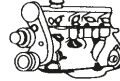
Code *l* kW

Cyl.



Stock-No.



LPG/CNG

**SEAT****TOLEDO 4**

Toledo 4 1.2 TSI	KG3	1.2	63	10.12 -	CBZA	4	0,7	IZFR6P7	97153		
Toledo 4 1.2 TSI	KG3	1.2	77	10.12 -	CBZB	4	0,7	IZFR6P7	97153		
Toledo 4 1.4 TSI	KG3	1.4	90	10.12 -	CAXA	4	0,9	PZFR6R	5758		
Toledo 4 1.6 TDI	KG3	1.6	77	10.12 -	CAYC	4	█	Y1002AS	8888	57	
Toledo 4 1.6 TDI	KG3	1.6	77	10.12 -	CLNA	4	█	Y1002AS	8888	57	

**SKODA****FAVORIT / FORMAN**

135 LE / LSE		1.3		08.89 - 08.92		4	0,8	BKR6ES	3783	28	LPG 1
135 LX / GLX		1.3		01.93 - 96		4	0,8	BKR6ES	3783	28	LPG 1
135 Favorit L / LS		1.3		04.88 - 95		4	0,8	BCPR5ES	6130	32	LPG 3
135 Favorit LE / LSE		1.3		08.89 - 95		4	0,8	BKR6ES	3783	28	LPG 1
135 Favorit LX / GLX		1.3		01.93 - 95		4	0,8	BKR6ES	3783	28	LPG 1
135 Forman L / LS		1.3		08.90 - 95		4	0,8	BCPR5ES	6130	32	LPG 3
135 Forman LE / LSE		1.3		02.91 - 95		4	0,8	BKR6ES	3783	28	LPG 1
135 Forman LX / GLX		1.3		01.93 - 95		4	0,8	BKR6ES	3783	28	LPG 1
136 Favorit				90 - 92		4	0,8	BCPR6E	1269	12	LPG 3
136 Favorit				93 - 95	mit Catalysator	4		BCPR6ET	2197		LPG 3
136 Favorit				93 - 95		4	0,9	BKR6E	6962	28	LPG 1

**CITIGO**

Citigo 1.0	NF1/NF2	1.0	44	10.11 -	CHYA	3	1,0	ZKER6A-10EG	96596		
Citigo 1.0	NF1/NF2	1.0	55	10.11 -	CHYB	3	1,0	ZKER6A-10EG	96596		

**FABIA 1**

Fabia 1 1.0	6Y2	1.0	37	10.00 - 08.02	AQV	4		BKR6ETA-10	7998		
Fabia 1 1.0	6Y2	1.0	37	10.00 - 08.02	ARV	4		BKR6ETA-10	7998		
Fabia 1 1.4 16V	6Y2/6Y5	1.4	55	05.04 - 12.07	BKY	4	0,9	ZFR5P-G	6893		LPG 6
Fabia 1 1.4	6Y2/6Y5	1.4	59	05.06 - 12.07	BUD	4	1,1	ZFR6T-11G	5960		
Fabia 1 1.2	6Y2 / 6Y5	1.2	40	07.01 - 05.04	AWY	3	0,9	ZFR5P-G	6893		LPG 6
Fabia 1 1.2 Fgst —> 6Y-8B451106* Fgst —> 6Y-84035536*	6Y2 / 6Y5	1.2	40	05.04 - 12.07	BMD	3	0,9	ZFR5P-G	6893		LPG 6
Fabia 1 1.2 Fgst 6Y-8B451107—>* Fgst 6Y-84035537—>*	6Y2 / 6Y5	1.2	40	05.04 - 12.07	BMD	3	1,1	ZFR6T-11G	5960		
Fabia 1 1.2 Fgst —> 6Y-8B451106* Fgst —> 6Y-84035536*	6Y2 / 6Y5	1.2	47	11.04 - 12.07	BME	3	0,9	ZFR5P-G	6893		LPG 6
Fabia 1 1.2 Fgst 6Y-8B451107—>* Fgst 6Y-84035537—>*	6Y2 / 6Y5	1.2	47	11.04 - 12.07	BME	3	1,1	ZFR6T-11G	5960		
Fabia 1 1.2	6Y2 / 6Y5	1.2	47	01.03 - 12.04	AZQ	3	0,9	ZFR5P-G	6893		LPG 6
Fabia 1 1.4	6Y2/6Y5	1.4	44	04.00 - 03.03	AZE	4	0,8	PFR6Q	6458	37	LPG 1
Fabia 1 1.4	6Y2/6Y5	1.4	44	04.00 - 03.03	AZF	4	0,8	PFR6Q	6458	37	LPG 1
Fabia 1 1.4	6Y2/6Y5	1.4	50	08.99 - 05.03	AME	4		BKUR5ET-10	7553		LPG 1
Fabia 1 1.4	6Y2/6Y5	1.4	50	08.99 - 01.01	ATZ	4		BKUR5ET-10	7553		LPG 1
Fabia 1 1.4	6Y2/6Y5	1.4	50	08.00 - 05.03	AQW	4		BKUR5ET-10	7553		LPG 1
Fabia 1 1.4 16V	6Y2/6Y5	1.4	55	10.99 - 08.03	AUA	4		BKUR6ET-10	2397	24	LPG 1
Fabia 1 1.4 16V Automatic	6Y2/6Y5	1.4	55	10.99 - 08.03	AUA	4	1,1	PZFR5D-11	7968	34	LPG 6
Fabia 1 1.4 16V Automatic	6Y2/6Y5	1.4	55	04.02 - 05.04	BBY	4	1,1	PZFR5D-11	7968	34	LPG 6
Fabia 1 1.4 16V	6Y2/6Y5	1.4	55	04.02 - 05.04	BBY	4		BKUR6ET-10	2397	24	LPG 1
Fabia 1 1.4 TDI	6Y2/6Y5	1.4	55	04.03 - 10.05	AMF	3	█	Y-741U	6943	20	
Fabia 1 1.4 16V	6Y2/6Y5	1.4	74	10.99 - 08.03	AUB	4		BKUR6ET-10	2397	24	LPG 1
Fabia 1 1.4 16V	6Y2/6Y5	1.4	74	05.02 - 12.07	BBZ	4		BKUR6ET-10	2397	24	LPG 1
Fabia 1 1.9 SDI	6Y2/6Y5	1.9	47	11.99 - 03.08	ASY	4	█	Y-732J	5605	4	

Fgst = Chassis No.

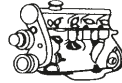
Code *l* kW

Cyl.

Stock-No.  
**VLINE**  
BY-PROWERYK\*\*

LPG/CNG

**SKODA  
FABIA 1**

Fabia 1 1.9 TDI	6Y2/6Y5	1.9	74	01.00 - 10.05	ATD →6Y-2-451087	4	<input checked="" type="checkbox"/>	Y-732J	5605	4	
Fabia 1 1.9 TDI	6Y2/6Y5	1.9	74	01.00 - 10.05	ATD 6Y-2-451088 →	4	<input checked="" type="checkbox"/>	Y-741U	6943	20	
Fabia 1 1.9 TDI	6Y2/6Y5	1.9	74	10.05 - 12.07	AXR	4	<input checked="" type="checkbox"/>	Y-741U	6943	20	
Fabia 1 1.9 TDI RS	6Y2	1.9	96	06.03 - 10.05	ASZ	4	<input checked="" type="checkbox"/>	Y-741U	6943	20	
Fabia 1 1.9 TDI RS	6Y2	1.9	96	10.05 - 04.07	BLT	4	<input checked="" type="checkbox"/>	Y-741U	6943	20	
Fabia 1 2.0	6Y2/6Y5	2.0	85	12.99 - 12.07	AZL	4		BKUR6ET-10	2397	24	LPG 1

**FABIA 2**

Fabia 2 1.2	542/545	1.2	44	12.06 - 03.09	BBM	3	0,9	ZFR5P-G	6893		LPG 6
Fabia 2 1.2	542/545	1.2	44	03.09 - 11.11	CHFA	3	1,1	ZFR6T-11G	5960		
Fabia 2 1.2	542/545	1.2	44	11.11 -	CGPB	3	1,1	ZFR6T-11G	5960		
Fabia 2 1.2	542/545	1.2	51	03.09 - 03.10	CGPA	3	1,1	ZFR6T-11G	5960		
Fabia 2 1.2 Fgst → 5J-8B501225* Fgst → 5J-83074394*	542/545	1.2	52	01.07 - 05.09	BZG	3	0,9	ZFR5P-G	6893		LPG 6
Fabia 2 1.2 Fgst 5J-8B501226 →* Fgst 5J-83074395 →*	542/545	1.2	52	01.07 - 05.09	BZG	3	1,1	ZFR6T-11G	5960		
Fabia 2 1.2 Fgst 5J-8B501226 →* Fgst 5J-83074395 →*	542/545	1.2	52	01.08 - 09.10	CEVA	3	1,1	ZFR6T-11G	5960		
Fabia 2 1.2 TDI	542/545	1.2	55	03.10 -	CFWA	4	<input checked="" type="checkbox"/>	Y1002AS	8888	57	
Fabia 2 1.2 TDI	542/545	1.2	55	03.10 -	CFWA	3	<input checked="" type="checkbox"/>	Y1002AS	8888	57	
Fabia 2 1.2 TSI	542/545	1.2	63	03.10 -	CBZA	4	0,7	IZFR6P7	97153		
Fabia 2 1.2 TSI	542/545	1.2	77	03.10 -	CBZB	4	0,7	IZFR6P7	97153		
Fabia 2 1.4 TDI	542/545	1.4	51	10.05 - 03.10	BNM	3	<input checked="" type="checkbox"/>	Y-741U	6943	20	
Fabia 2 1.4 TDI	542/545	1.4	59	10.05 - 03.10	BNV	3	<input checked="" type="checkbox"/>	Y-741U	6943	20	
Fabia 2 1.4 TDI	542/545	1.4	59	01.07 - 03.10	BMS	3	<input checked="" type="checkbox"/>	CZ104	9826	52	
Fabia 2 1.4	542/545	1.4	63	03.10 -	CGGB	4	1,1	ZFR6T-11G	5960		
Fabia 2 1.4	542/545	1.4	63	01.07 - 03.10	BXW	4	1,1	ZFR6T-11G	5960		
Fabia 2 1.4 TSI RS	542/545	1.4	132	05.10 -	CAVE	4	0,8	SIZFR6B8EG	96209		
Fabia 2 1.4 TSI RS	542/545	1.4	132	05.10 -	CTHE	4	0,8	SIZFR6B8EG	96209		
Fabia 2 1.6 TDI	542/545	1.6	55	04.10 -	CAYA	4	<input checked="" type="checkbox"/>	Y1002AS	8888	57	
Fabia 2 1.6 TDI	542/545	1.6	66	03.10 -	CAYB	4	<input checked="" type="checkbox"/>	Y1002AS	8888	57	
Fabia 2 1.6	542/545	1.6	77	04.07 -	BTS	4	1,1	ZFR6T-11G	5960		
Fabia 2 1.6	542/545	1.6	77	06.10 -	CFNA	4	1,1	ZFR6T-11G	5960		
Fabia 2 1.6 TDI	542/545	1.6	77	03.10 -	CAYC	4	<input checked="" type="checkbox"/>	Y1002AS	8888	57	
Fabia 2 1.9 TDI	542/545	1.9	77	04.07 - 03.10	BLS	4	<input checked="" type="checkbox"/>	CZ104	9826	52	
Fabia 2 1.9 TDI	542/545	1.9	77	04.07 - 03.10	BSW	4	<input checked="" type="checkbox"/>	Y-741U	6943	20	

**FELICIA**

Felicia		1.0	37	08.99 -	AHT	4		BKR6ETA-10	7998		
Felicia 135i		1.3	40	10.94 - 07.96	MPI	4		BKUR5ET-10	7553		LPG 1
Felicia		1.3	40	08.96 - 08.01	AMG	4		BKUR5ET-10	7553		LPG 1
Felicia		1.3	43	10.94 - 07.96		4	0,8	BCPR5ES	6130	32	LPG 3
Felicia 135i		1.3	43	08.96 -	AMJ	4	0,8	BCPR5ES	6130	32	LPG 3
Felicia 136i		1.3	50	10.94 - 07.96	136B	4	0,8	BCPR6ES	2330	12	LPG 3
Felicia 136i		1.3	50	10.94 - 07.96	136M	4	0,8	BKR6ES	3783	28	LPG 1
Felicia		1.3	50	08.96 - 08.01	AMH	4		BKUR5ET-10	7553		LPG 1
Felicia		1.4	74	99 -		4		BKUR6ET-10	2397	24	LPG 1
Felicia		1.6	55	05.95 - 08.01	AEE	4		BUR6ET	3172	1	LPG 2
Felicia D		1.9	47	10.95 - 08.01	AEF	4	<input checked="" type="checkbox"/>	Y-918J	6285	2	
Felicia D		1.9	47	97 -	AEY	4	<input checked="" type="checkbox"/>	Y-732J	5605	4	

Fgst = Chassis No.

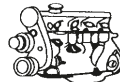
Code *l* kW

Cyl.



Stock-No.

**SKODA****OCTAVIA 1**

Octavia 1 1.4	1U2/1U5	1.4	44	02.99 - 03.01	AMD	4		BKUR6ET-10	2397	24	LPG 1
Octavia 1 1.4 16V Automatik	1U2/1U5	1.4	55	08.00 - 01.02	AXP	4	1,1	PZFR5D-11	7968	34	LPG 6
Octavia 1 1.4 16V	1U2/1U5	1.4	55	08.00 - 01.02	AXP	4		BKUR6ET-10	2397	24	LPG 1
Octavia 1 1.4 16V	1U2/1U5	1.4	55	01.02 - 12.10	BCA	4		BKUR6ET-10	2397	24	LPG 1
Octavia 1 1.6	1U2/1U5	1.6	55	10.96 - 09.04	AEE	4		BUR6ET	3172	1	LPG 2
Octavia 1 1.6	1U2/1U5	1.6	74	02.97 - 12.07	AEH	4		BKUR6ET-10	2397	24	LPG 1
Octavia 1 1.6	1U2/1U5	1.6	74	08.98 - 12.07	AKL	4		BKUR6ET-10	2397	24	LPG 1
Octavia 1 1.6	1U2/1U5	1.6	75	08.00 - 04.02	AVU	4		BKUR6ET-10	2397	24	LPG 1
Octavia 1 1.6	1U2/1U5	1.6	75	04.02 - 12.10	BFQ	4		BKUR6ET-10	2397	24	LPG 1
Octavia 1 1.8 20V	1U2/1U5	1.8	92	10.96 - 07.00	AGN	4		BKUR6ET-10	2397	24	LPG 1
Octavia 1 1.8 T	1U2/1U5	1.8	110	05.98 - 12.10	AGU	4	0,8	PFR6Q	6458	37	LPG 1
Octavia 1 1.8 T	1U2/1U5	1.8	110	08.00 - 05.06	ARX	4	0,8	PFR6Q	6458	37	LPG 1
Octavia 1 1.8 T	1U2/1U5	1.8	110	01.00 - 07.00	ARZ	4	0,8	PFR6Q	6458	37	LPG 1
Octavia 1 1.8 T	1U2/1U5	1.8	110	08.00 - 12.10	AUM	4	0,8	PFR6Q	6458	37	LPG 1
Octavia 1 1.8 T RS	1U2/1U5	1.8	132	12.00 - 01.06	AUQ	4	0,8	PFR6Q	6458	37	LPG 1
Octavia 1 1.9 SDI	1U2/1U5	1.9	50	05.97 - 12.03	AGP	4	▣	Y-732J	5605	4	
Octavia 1 1.9 SDI	1U2/1U5	1.9	50	08.00 - 12.03	AQM	4	▣	Y-732J	5605	4	
Octavia 1 1.9 TDI	1U2/1U5	1.9	66	10.96 - 03.10	AGR	4	▣	Y-732J	5605	4	
Octavia 1 1.9 TDI	1U2/1U5	1.9	66	08.00 - 03.10	ALH	4	▣	Y-732J	5605	4	
Octavia 1 1.9 TDI 4x4	1U5	1.9	74	08.00 - 01.06	ATD	4	▣	Y-732J	5605	4	
Octavia 1 1.9 TDI	1U2/1U5	1.9	74	10.05 - 12.10	AXR	4	▣	Y-732J	5605	4	
Fgst → 1U-22598796											
Fgst → 1U-28558122											
Octavia 1 1.9 TDI	1U2/1U5	1.9	74	10.05 - 12.10	AXR	4	▣	Y-741U	6943	20	
Fgst 1U-22598797→											
Fgst 1U-28558123→											
Octavia 1 1.9 TDI	1U2/1U5	1.9	81	08.97 - 01.06	AHF	4	▣	Y-732J	5605	4	
Octavia 1 1.9 TDI	1U2/1U5	1.9	81	10.00 - 01.06	ASV	4	▣	Y-732J	5605	4	
Octavia 1 1.9 TDI	1U2/1U5	1.9	96	09.02 - 09.04	ASZ	4	▣	Y-741U	6943	20	
Octavia 1 2.0	1U2/1U5	2.0	85	05.99 - 05.07	APK	4		BKUR6ET-10	2397	24	LPG 1
Octavia 1 2.0	1U2/1U5	2.0	85	05.99 - 03.02	AQY	4		BKUR6ET-10	2397	24	LPG 1
Octavia 1 2.0	1U2/1U5	2.0	85	11.99 - 09.04	AZH	4		BKUR6ET-10	2397	24	LPG 1
Octavia 1 2.0	1U2/1U5	2.0	85	09.00 - 01.05	AEG	4		BKUR6ET-10	2397	24	LPG 1
Octavia 1 2.0	1U5	2.0	85	03.02 - 01.06	AZJ	4	1,1	PZFR5D-11	7968	34	LPG 6
Octavia 1 2.0 4x4	1U5	2.0	88	11.99 - 04.01	ATF	4	1,1	PZFR5D-11	7968	34	LPG 6

**OCTAVIA 2**

Octavia 2 1.2 TSI	1Z3/1Z5	1.2	77	02.10 -	CBZB	4	0,7	IZFR6P7	97153		
Octavia 2 1.4	1Z3/1Z5	1.4	55	05.04 - 05.06	BCA	4		BKUR6ET-10	2397	24	LPG 1
Octavia 2 1.4	1Z3/1Z5	1.4	59	05.06 -	BUD	4	1,1	ZFR6T-11G	5960		
Octavia 2 1.4 TSI	1Z3/1Z5	1.4	90	11.08 -	CAXA	4	0,9	PZFR6R	5758		
Octavia 2 1.6	1Z3/1Z5	1.6	75	05.04 - 05.05	BGU	4		BKUR6ET-10	2397	24	LPG 1
Octavia 2 1.6	1Z3/1Z5	1.6	75	05.05 -	BSE	4		BKUR6ET-10	2397	24	LPG 1
Octavia 2 1.6	1Z3/1Z5	1.6	75	05.05 -	BSF	4		BKUR6ET-10	2397	24	LPG 1
Octavia 2 1.6	1Z3/1Z5	1.6	75	11.07 - 05.10	CCSA	4		BKUR6ET-10	2397	24	LPG 1
Octavia 2 1.6 LPG	1Z3/1Z5	1.6	75	08.09 -	CHGA	4		BKUR6ET-10	2397	24	LPG 1
Octavia 2 1.6	1Z3/1Z5	1.6	75	05.10 -	CMXA	4		BKUR6ET-10	2397	24	LPG 1
Octavia 2 1.6 TDI	1Z3/1Z5	1.6	77	06.09 -	CAYC	4	▣	Y1002AS	8888	57	
Octavia 2 1.6 FSI	1Z3/1Z5	1.6	85	02.04 - 10.08	BLF	4		ZFR6S-Q	6449		
Octavia 2 1.8 TSI 4x4	1Z5	1.8	112	03.09 -	CDAB	4	0,8	PFR7S8EG	1675		PFR8S8EG
Octavia 2 1.8 TSI	1Z3/1Z5	1.8	118	06.07 - 10.08	BZB	4	0,8	PFR7S8EG	1675		PFR8S8EG
Octavia 2 1.8 TSI	1Z3/1Z5	1.8	118	11.08 -	CDA A	4	0,8	PFR7S8EG	1675		PFR8S8EG

Fgst = Chassis No.

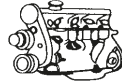
Code *l* kW

Cyl.

Stock-No.  
**VLINE**  
BY-PROFIT/2018\*\*

LPG/CNG

**SKODA  
OCTAVIA 2**

Octavia 2 1.9 TDI	1Z3/1Z5	1.9	77	05.04 - 12.10	BJB	4	☑	Y-607AS	7560	50	
Octavia 2 1.9 TDI	1Z3/1Z5	1.9	77	05.04 - 02.06	BKC	4	☑	Y-607AS	7560	50	
Octavia 2 1.9 TDI	1Z3/1Z5	1.9	77	05.06 - 12.10	BLS	4	☑	Y-607AS	7560	50	
Octavia 2 1.9 TDI	1Z3/1Z5	1.9	77	03.06 - 12.10	BXE	4	☑	Y-607AS	7560	50	
Octavia 2 2.0 TDI	1Z3/1Z5	2.0	81	03.10 - 06.13	CFHF	4	☑	Y1002AS	8888	57	
Octavia 2 2.0 TDI	1Z3/1Z5	2.0	81	03.10 - 06.13	CLCA	4	☑	Y1002AS	8888	57	
Octavia 2 2.0 TDI	1Z3/1Z5	2.0	100	05.04 - 10.08	AZV	4	☑	YE14	7768	48	
Octavia 2 2.0 TDI 16V	1Z3/1Z5	2.0	100	05.04 -	BKD	4	☑	YE14	7768	48	
Octavia 2 2.0 TDI	1Z3/1Z5	2.0	103	11.05 - 12.05	BMM	4	☑	CZ104	9826	52	
Octavia 2 2.0 TDI	1Z3/1Z5	2.0	103	01.06 - 05.10	BMM	4	☑	Y-607AS	7560	50	
Octavia 2 2.0 TDI 16V	1Z3/1Z5	2.0	103	03.10 -	CFHC	4	☑	Y1002AS	8888	57	
Octavia 2 2.0 TDI 16V	1Z3/1Z5	2.0	103	02.10 -	CLCB	4	☑	Y1002AS	8888	57	
Octavia 2 2.0 FSI	1Z3/1Z5	2.0	110	11.04 - 11.05	BLR	4		PZFR5N-11T	7742		
Octavia 2 2.0 FSI 4x4	1Z5	2.0	110	11.04 - 11.05	BLX	4		PZFR5N-11T	7742		
Octavia 2 2.0 FSI	1Z3/1Z5	2.0	110	11.04 - 11.05	BLY	4	0,9	BKR6E	6962	28	LPG 1
Octavia 2 2.0 FSI 4x4	1Z5	2.0	110	11.05 - 10.08	BVX	4		PZFR5N-11T	7742		
Octavia 2 2.0 FSI	1Z3/1Z5	2.0	110	11.05 - 10.08	BVY	4		PZFR5N-11T	7742		
Octavia 2 2.0 FSI	1Z3/1Z5	2.0	110	11.05 - 10.08	BVZ	4	0,9	BKR6E	6962	28	LPG 1
Octavia 2 2.0 TDI RS	1Z3/1Z5	2.0	125	06.08 -	BMN	4	☑	Y1002AS	8888	57	
Octavia 2 2.0 TDI RS	1Z3/1Z5	2.0	125	04.06 - 05.08	BMN	4	☑	CZ304	9864	55	
Octavia 2 2.0 TDI RS	1Z3/1Z5	2.0	125	04.06 -	CEGA	4	☑	Y1002AS	8888	57	
Octavia 2 2.0 TSI RS	1Z3/1Z5	2.0	147	10.05 - 10.08	BWA	4	0,8	PFR7S8EG	1675		PFR8S8EG
Octavia 2 2.0 TSI RS	1Z3/1Z5	2.0	147	11.08 -	CCZA	4	0,8	PFR7S8EG	1675		PFR8S8EG

**OCTAVIA 3**

Octavia 3 1.2 TSI	5E3/5E5	1.2	63	11.12 -	CJZB	4	0,8	PZKER7A8EGS	94968		
Octavia 3 1.2 TSI	5E3/5E5	1.2	77	11.12 -	CJZA	4	0,8	PZKER7A8EGS	94968		
Octavia 3 1.4 TSI	5E3/5E5	1.4	103	11.12 -	CHPA	4	0,8	PZKER7A8EGS	94968		
Octavia 3 1.6 TDI	5E3/5E5	1.6	77	11.12 -	CLHA	4	☑	Y1002AS	8888	57	
nur für Zyl. ohne Drucksensor											
Octavia 3 2.0 TDI	5E3/5E5	2.0	110	11.12 -	CKFC	4	☑	Y1002AS	8888	57	
nur für Zyl. ohne Drucksensor											

**PICKUP**

Pickup 135 L		1.3		06.90 - 96	u.Cat.	4	0,8	BCPR5ES	6130	32	LPG 3
Pickup 135 LE		1.3		10.91 - 96		4	0,8	BKR6ES	3783	28	LPG 1
Pickup 135 LX		1.3		01.93 - 96		4	0,8	BKR6ES	3783	28	LPG 1
Pickup		1.9	47	97 -	AEY	4	☑	Y-732J	5605	4	
Pick-up 135i		1.3	40	96 -	135M	4		BKUR5ET-10	7553		LPG 1
Pick-up 136i		1.3	50	96 -	136M	4		BKUR5ET-10	7553		LPG 1

**RAPID**

Rapid 1.2	NH3	1.2	55	07.12 -	CGPC	3	1,1	ZFR6T-11G	5960		
Rapid 1.2 TSI	NH3	1.2	63	07.12 -	CBZA	4	0,7	IZFR6P7	97153		
Rapid 1.2 TSI	NH3	1.2	77	07.12 -	CBZB	4	0,7	IZFR6P7	97153		
Rapid 1.4 TSI	NH3	1.4	90	07.12 -	CAXA	4	0,9	PZFR6R	5758		
Rapid 1.6 TDI	NH3	1.6	77	07.12 -	CAYC	4	☑	Y1002AS	8888	57	

**ROOMSTER**

Roomster 1.2 Fgst → 5J-8B600480* Fgst → 5J-85036340*	5J	1.2	47	05.06 - 01.07	BME	3	0,9	ZFR5P-G	6893		LPG 6
Roomster 1.2 Fgst 5J-8B600481 →>* Fgst 5J-85036341 →>*	5J	1.2	47	05.06 - 01.07	BME	3	1,1	ZFR6T-11G	5960		ZFR6T-11G
Roomster 1.2	5J	1.2	51	03.09 -	CGPA	3	1,1	ZFR6T-11G	5960		ZFR6T-11G

Fgst = Chassis No.



Code *l* kW

Cyl.

Stock-No.  
**VEINE**  
BY-POMPEZI\*

LPG/CNG

**SKODA****ROOMSTER**

Roomster 1.2 Fgst → 5J-8B600480* Fgst → 5J-85036340*	5J	1.2	52	01.07 - 03.09	BZG	3	0,9	ZFR5P-G	6893		LPG 6
Roomster 1.2 Fgst 5J-8B600481 →* Fgst 5J-85036341 →*	5J	1.2	52	01.07 - 03.09	BZG	3	1,1	ZFR6T-11G	5960		ZFR6T-11G
Roomster 1.2 TDI	5J	1.2	55	03.10 -	CFWA	3	█	Y1002AS	8888	57	
Roomster 1.2 TSI	5J	1.2	63	03.10 -	CBZA	4	0,7	IZFR6P7	97153		IZFR6P7
Roomster 1.2 TSI	5J	1.2	77	03.10 -	CBZB	4	0,7	IZFR6P7	97153		IZFR6P7
Roomster 1.4 TDI	5J	1.4	51	07.06 -	BNM	3	█	Y-741U	6943	20	
Roomster 1.4 TDI	5J	1.4	59	07.06 -	BMS	3	█	CZ104	9826	52	
Roomster 1.4 TDI	5J	1.4	59	05.06 -	BNV	3	█	Y-741U	6943	20	
Roomster 1.4	5J	1.4	63	05.06 -	BXW	4	1,1	ZFR6T-11G	5960		ZFR6T-11G
Roomster 1.4	5J	1.4	63	03.10 -	CGGB	4	1,1	ZFR6T-11G	5960		ZFR6T-11G
Roomster 1.6 TDI	5J	1.6	66	03.10 -	CAYB	4	█	Y1002AS	8888	57	
Roomster 1.6	5J	1.6	77	05.06 -	BTS	4	1,1	ZFR6T-11G	5960		ZFR6T-11G
Roomster 1.6	5J	1.6	77	06.10 -	CFNA	4	1,1	ZFR6T-11G	5960		ZFR6T-11G
Roomster 1.6 TDI	5J	1.6	77	03.10 -	CAYC	4	█	Y1002AS	8888	57	
Roomster 1.9 TDI	5J	1.9	74	03.06 - 05.06	AXR	4	█	Y-741U	6943	20	
Roomster 1.9 TDI	5J	1.9	77	11.06 -	BLS	4	█	CZ104	9826	52	
Roomster 1.9 TDI	5J	1.9	77	05.06 -	BSW	4	█	Y-741U	6943	20	

**SUPERB 1**

Superb 1 1.8 Turbo	3U4	1.8	110	10.01 - 03.08	AWT	4	0,8	PFR6Q	6458	37	LPG 1
Superb 1 1.9 TDI	3U4	1.9	74	06.02 - 10.05	AVB	4	█	Y-741U	6943	20	
Superb 1 1.9 TDI	3U4	1.9	77	10.05 - 05.07	BSV	4	█	CZ104	9826	52	
Superb 1 1.9 TDI	3U4	1.9	85	01.07 - 03.08	BPZ	4	█	CZ104	9826	52	
Superb 1 1.9 TDI	3U4	1.9	96	10.01 - 03.08	AWX	4	█	Y-741U	6943	20	
Superb 1 1.9 TDI	3U4	1.9	96	01.04 - 03.08	AVF	4	█	Y-741U	6943	20	
Superb 1 2.0	3U4	2.0	85	12.01 - 03.08	AZM	4		BKUR6ET-10	2397	24	LPG 1
Superb 1 2.0 TDI	3U4	2.0	103	10.05 - 03.08	BSS	4	█	CZ104	9826	52	
Superb 1 2.5 V6 TDI	3U4	2.5	114	12.01 - 08.03	AYM	6	█	Y-501U	3786	31	
Superb 1 2.5 V6 TDI	3U4	2.5	120	06.03 - 03.08	BDG	6	█	Y-501U	3786	31	
Superb 1 2.8 V6	3U4	2.8	140	05.02 - 03.08	BBG	6		BKR6EKUB	3584		LPG 1
Superb 1 2.8 V6	3U4	2.8	142	12.01 - 03.08	AMX	6		BKR6EKUB	3584		LPG 1

**SUPERB 2**

Superb 2 1.4 TSI	3T4/3T5	1.4	92	08.08 -	CAXC	4	0,9	PZFR6R	5758		
Superb 2 1.6 TDI	3T4/3T5	1.6	77	09.10 -	CAYC	4	█	Y1002AS	8888	57	
Superb 2 1.8 TSI	3T4/3T5	1.8	112	03.09 -	CDAB	4	0,8	PFR7S8EG	1675		PFR8S8EG
Superb 2 1.8 TSI	3T4/3T5	1.8	118	03.08 - 05.09	BZB	4	0,8	PFR7S8EG	1675		PFR8S8EG
Superb 2 1.8 TSI	3T4/3T5	1.8	118	09.08 -	CDAA	4	0,8	PFR7S8EG	1675		PFR8S8EG
Superb 2 1.9 TDI	3T4/3T5	1.9	77	07.08 -	BLS	4	█	Y-607AS	7560	50	
Superb 2 1.9 TDI	3T4/3T5	1.9	77	03.08 -	BXE	4	█	Y-607AS	7560	50	
Superb 2 2.0 TDI	3T4/3T5	2.0	103	01.09 -	BKD	4	█	YE14	7768	48	
Superb 2 2.0 TDI	3T4/3T5	2.0	103	03.08 - 03.10	BMP	4	█	CZ104	9826	52	
Superb 2 2.0 TDI	3T4/3T5	2.0	103	01.09 -	CFFB	4	█	Y1002AS	8888	57	
Superb 2 2.0 TDI	3T4/3T5	2.0	103	01.09 -	CLJA	4	█	Y1002AS	8888	57	
Superb 2 2.0 TDI	3T4/3T5	2.0	125	06.08 - 05.10	CBBB	4	█	Y1002AS	8888	57	
Superb 2 2.0 TDI	3T4/3T5	2.0	125	05.10 -	CFGB	4	█	Y1002AS	8888	57	
Superb 2 2.0 TSI	3T4/3T5	2.0	147	05.10 -	CCZA	4	0,8	PFR7S8EG	1675		PFR8S8EG
Superb 2 3.6 V6 4x4	3T4/3T5	3.6	191	09.08 -	CDVA	6	0,8	ILZKR8A	94290		

**YETI**

Yeti 1.2 TSI	5L	1.2	77	09.09 -	CBZB	4	0,7	IZFR6P7	97153		
--------------	----	-----	----	---------	------	---	-----	---------	-------	--	--

Fgst = Chassis No.

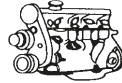
Code *l* kW

Cyl.



Stock-No.



LPG/CNG

**SKODA  
YETI**

Yeti 1.4 TSI	5L	1.4	90	06.10 -	CAXA	4	0,9	PZFR6R	5758		
Yeti 1.6 TDI	5L	1.6	77	11.10 -	CAYC	4		Y1002AS	8888	57	
Yeti 1.8 TSI 4x4	5L	1.8	112	11.09 -	CDAB	4	0,8	PFR7S8EG	1675		PFR8S8EG
Yeti 1.8 TSI 4x4	5L	1.8	118	05.09 -	CDA A	4	0,8	PFR7S8EG	1675		PFR8S8EG
Yeti 2.0 TDI	5L	2.0	81	11.09 -	CFHA	4		Y1002AS	8888	57	
Yeti 2.0 TDI 4x4	5L	2.0	81	11.09 -	CFHF	4		Y1002AS	8888	57	
Yeti 2.0 TDI	5L	2.0	103	05.09 - 11.09	CBDB	4		Y1002AS	8888	57	
Yeti 2.0 TDI	5L	2.0	103	11.09 -	CFHC	4		Y1002AS	8888	57	
Yeti 2.0 TDI 4x4	5L	2.0	125	11.09 - 05.10	CEGA	4		Y1002AS	8888	57	
Yeti 2.0 TDI 4x4	5L	2.0	125	11.09 -	CFJA	4		Y1002AS	8888	57	

**SMART  
CITY-COUPÉ**

Smart	MC01	0.6	33	10.98 - 01.04	M 160 ... Twin Spark	3		BKR6EKE	5649		
Smart	MC01	0.6	40	10.98 - 01.04	M 160 ... Twin Spark	3		BKR6EKE	5649		
Smart	MC01	0.7	37	10.02 - 01.04	M 160/1 Twin Spark	3		LKR8A	5214		LKR8A
Smart	MC01	0.7	60	10.02 - 01.04	M 160/1 Twin Spark	3		LKR8A	5214		LKR8A
Smart CDI	MC01	0.8	29	07.98 - 01.04	OM 660 DE 08 LA	3		Y-543J	5618	46	

**CROSSBLADE**

Smart Crossblade		0.6	52	10.02 - 01.04	M 160 ... Twin Spark	3		BKR6EKE	5649		
------------------	--	-----	----	---------------	----------------------	---	--	---------	------	--	--

**FORTWO 1**

Smart fortwo	450	0.7	37	01.04 -	M 160/1 Twin Spark	3		LKR8A	5214		LKR8A
Smart fortwo	450	0.7	45	01.04 -	M 160/1 Twin Spark	3		LKR8A	5214		LKR8A
Smart fortwo Cdi	450	0.8	30	01.04 -	OM 660	3		Y-543J	5618	46	

**FORTWO 2**

Smart fortwo 2 Cdi	451	0.8	33	03.07 -	OM 660.950	3		Y-543J	5618	46	
Smart fortwo 2	451	1.0	45	03.07 -	M 132.910	3	0,9	LKR7B-9	5847		
Smart fortwo 2	451	1.0	52	03.07 -	M 132.910	3	0,9	LKR7B-9	5847		
Smart fortwo 2 Turbo	451	1.0	62	03.07 -	M 132.930	3	0,9	LKR7B-9	5847		
Smart fortwo Brabus	451	1.0	72	01.08 -	M 132.930	3	0,9	LKR7B-9	5847		

**ROADSTER / COUPÉ**

Smart Roadster	452	0.7	45	10.02 - 11.05	M 160/1 Twin Spark	3		LKR8A	5214		
Smart Roadster	452	0.7	60	06.03 - 11.05	M 160/1 Twin Spark	3		LKR8A	5214		
Smart Roadster Brabus	452	0.7	74	12.03 - 11.05	M 160/1 Twin Spark	3		LKR8A	5214		

**FORFOUR**

Smart forfour	454	1.1	55	01.04 - 06.06	M 134.910	3	1,1	LFR6C-11	5788		
Smart forfour	454	1.3	70	01.04 - 06.06	M 135.930	4	1,1	LFR6C-11	5788		
Smart forfour Cdi	454	1.5	50	09.04 - 06.06	OM 639.939	3		YE13	8643		
Smart forfour Cdi	454	1.5	70	09.04 - 06.06	OM 639.939	3		YE13	8643		
Smart forfour	454	1.5	80	01.04 - 06.06	M 135.950	4	1,1	LFR6C-11	5788		
Smart forfour Brabus	454	1.5	130	05.05 - 06.06	M 122.950	4	0,8	ILZFR6C-K	6645		

**SSANGYONG  
ACTYON**

Actyon 200 Xdi		2.0	100	07.07 -	D20DT	4		Y-536J	95061	81	
Actyon Sports 200 Xdi		2.0	104	10.06 -	D20DT	4		Y-536J	95061	81	

**KORANDO**

Korando 2.0		2.0	100	07.96 -	M161E20 M111.940	4	0,8	BCP5ES	7496	16	LPG 3
-------------	--	-----	-----	---------	------------------	---	-----	--------	------	----	-------

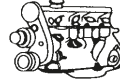
Code *l* kW

Cyl.

Stock-No.  
**VEFINE**  
E-FORWARD\*

LPG/CNG

**SSANGYONG****KORANDO**

Korando 2.2 D		2.2	51	01.93 - 12.96	DC 23	4	☑	Y-710J	7880		
Korando 2.3 D		2.3	55	03.97 -	OM 601 DM	4	☑	Y-916J	5906	6	
Korando 2.3 TD		2.3	73	03.99 - 03.00		4	☑	Y-916J	5906	6	
Korando 2.3		2.3	110	09.96 - 02.99	M161E23 M111.970	4	0,8	BCP5ES	7496	16	LPG 3
Korando 2.9 D		2.9	73	12.96 -	MB-OM 602	5	☑	Y-916J	5906	6	
Korando 2.9 TD		2.9	88	03.99 - 03.00		5	☑	Y-916J	5906	6	
Korando 3.2		3.2	162	09.96 - 03.00	M162E32 M104...	6	0,8	BCP5ES	7496	16	LPG 3
Korando 3.2 LPG		3.2	162	07.97 - 03.00		6	0,8	BKR5EIX	6341		LPG 1

**KYRON**

Kyron 2.0 Xdi		2.0	100	01.10 -	D20DT	4	☑	Y-536J	95061	81	
Kyron 2.0 Xdi		2.0	104	05.05 -	D20DT	4	☑	Y-536J	95061	81	
Kyron 2.7 Xdi		2.7	120	03.06 -	D27DT	5	☑	Y-536J	95061	81	
Kyron 2.7 Xdi		2.7	121	05.05 -	D27DT	5	☑	Y-536J	95061	81	
Kyron 3.2		3.2	162	03.08 -	G32D	6	0,8	BCP5ES	7496	16	LPG 3

**MUSSO**

Musso 2.0		2.0	100	05.96 -	M161E20 M111.940	4	0,8	BCP5ES	7496	16	LPG 3
Musso 2.3 D		2.3	58	07.93 - 01.00	MB-OM 601	4	☑	Y-916J	5906	6	
Musso 2.3 TD		2.3	73	03.99 - 03.00		4	☑	Y-916J	5906	6	
Musso 2.3		2.3	110	05.96 - 02.99	M161E23 M111.970	4	0,8	BCP5ES	7496	16	LPG 3
Musso 2.9 D		2.9	73	07.93 - 01.00	MB-OM 602	5	☑	Y-916J	5906	6	
Musso 2.9 TD		2.9	88	03.99 -		5	☑	Y-916J	5906	6	
Musso Sports 2.9 TD		2.9	88	03.04 -		5	☑	Y-916J	5906	6	
Musso 3.2		3.2	162	01.96 -	M162E32 M104...	6	0,8	BCP5ES	7496	16	LPG 3

**REXTON**

Rexton RX 230 4x4		2.3	110	05.02 - 08.06	G23D	4	0,8	BCP5ES	7496	16	LPG 3
Rexton 2.7 Xdi 4x4		2.7	118	03.11 -	D27DT	5	☑	Y-536J	95061	81	
Rexton 2.7 Xdi		2.7	120	07.04 -	D27DT	5	☑	Y-536J	95061	81	
Rexton 2.7 Xdi		2.7	121	03.05 - 08.06	D27DT	5	☑	Y-536J	95061	81	
Achtung: Glühkerze für 11V											
Rexton 2.7 Xdi		2.7	121	03.05 - 08.06	D27DT	5	☑	Y-537AS	9994		
Achtung: Glühkerze für 5.5V											
Rexton 2.7 Xdi Turbo 4x4		2.7	132	03.11 -	D27DTP	5	☑	Y-536J	95061	81	
Rexton 2.7 D 4x4		2.7	137	05.06 -	D27DTP	5	☑	Y-536J	95061	81	
Achtung: Glühkerze für 11V											
Rexton 2.7 D 4x4		2.7	137	05.06 -	D27DTP	5	☑	Y-537AS	9994		
Achtung: Glühkerze für 5.5V											
Rexton RX 290s		2.9	88	04.02 -		5	☑	Y-916J	5906	6	
Rexton RX 320s		3.2	162	04.02 - 08.06	G32D	6	0,8	BCP5ES	7496	16	LPG 3

**RODIUS**

Rodius 2.7 Xdi		2.7	120	05.05 -	D27DT	5	☑	Y-536J	95061	81	
Rodius 2.7 Xdi		2.7	121	05.05 -	D27DT	5	☑	Y-536J	95061	81	
Rodius 3.2		3.2	162	07.07 -	G32D	6	0,8	BCP5ES	7496	16	LPG 3

**STEYR**

Puch 290 GD		2.9	72	08.93 -	OM602	5	☑	Y-916J	5906	6	
Puch 300 GD		3.0	83	09.89 -	OM617/603	6	☑	Y-916J	5906	6	
Puch 350 GTD		3.5	100	09.91 -	OM617/603	6	☑	Y-916J	5906	6	

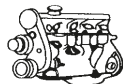
Code *l* kW

Cyl.

Stock-No.  
**VELINE**  
10-17-19-20-21-22-23-24-25-26-27-28-29-30-31-32-33-34-35-36-37-38-39-40-41-42-43-44-45-46-47-48-49-50-51-52-53-54-55-56-57-58-59-60-61-62-63-64-65-66-67-68-69-70-71-72-73-74-75-76-77-78-79-80-81-82-83-84-85-86-87-88-89-90-91-92-93-94-95-96-97-98-99-100

LPG/CNG

**SUBARU FORESTER**

Forester		2.0	90	09.97 - 02	EJ20J	4	1,1	BCPR6ES-11	7121	11	LPG 3
Forester		2.0	92	09.97 -	EJ20	4	1,1	BKR6E-11	2756	14	LPG 1
Forester		2.0	110	01.08 -	EJ204	4	1,1	SILFR6A11	5468		
Forester		2.0	116	09.05 - 02.08	EJ20	4	0,8	ILFR6B	6481		
Forester		2.0	116	03.08 -	EJ20	4	0,8	ILFR6B	6481		
Forester 2.0 Turbo		2.0	130	03.99 - 02	EJ20	4	0,9	PFR6B	3500		PFR7B
Forester 2.5 Turbo		2.5	155	05 -	EJ25	4	0,8	PFR6G	4793		PFR7G
Forester		2.5	169	06 - 02.08	EJ25	4	0,8	ILFR6B	6481		
Forester		2.5	169	06.08 -	EJ255	4	0,8	ILFR6B	6481		
Forester 2.0 X	SJ13	2.0	110	08.12 -	FB20A / FB20B	4	1,1	SILZKAR7B11	93482		

**IMPREZA**

Impreza 1.5R		1.5	79	09.07 -	EJ15	4	0,8	ILFR6B	6481		
Impreza 1,6		1.6	66	93 - 00	EJ16	4	1,1	BKR6E-11	2756	14	LPG 1
Impreza		1.6	70	12.00 - 03	EJ16	4	1,1	BKR6E-11	2756	14	LPG 1
Impreza		1.6	70	03 - 06	EJ16	4	0,8	PFR6G	4793		PFR7G
Impreza 1,8		1.8	76	93 - 00	EJ18	4	1,1	BKR6E-11	2756	14	LPG 1
Impreza		2.0	92	12.00 -	EJ20	4	1,1	BKR6E-11	2756	14	LPG 1
Impreza 2.0 RS		2.0	92	11.04 -	EJ20	4	1,1	BKR6E-11	2756	14	LPG 1
Impreza 2.0		2.0	110	01.08 - 02.10	EJ204	4	1,1	SILFR6A11	5468		
Impreza 2.0		2.0	110	03.10 -	EJ204	4	1,1	SILFR6C11	7505		
Impreza 2.0R		2.0	110	09.07 -	EK20	4	0,8	ILFR6B	6481		
Impreza R		2.0	118	06 -	EJ20	4	0,8	ILFR6B	6481		
Impreza Turbo		2.0	155	05.94 - 07.96	EJ20	4	0,8	PFR6G	4793		PFR7G
Impreza Turbo		2.0	160	03.94 - 00	EJ20	4	0,9	PFR6B	3500		PFR7B
Impreza WRX Turbo		2.0	160	12.00 -	EJ20	4	0,9	PFR6B	3500		PFR7B
Impreza WRX Turbo		2.0	165	11.02 -	EJ20	4	0,9	PFR6B	3500		PFR7B
Impreza WRX Turbo		2.0	169	06 -	EJ25	4	0,8	ILFR6B	6481		
Impreza WRX Sti		2.0	195	03 -	EJ20	4	0,8	PFR6G	4793		PFR7G
Impreza WRX Sti		2.0	236	02.04 -		4	0,8	PFR6G	4793		PFR7G
Impreza WRX		2.5	169	09.05 -	EJ25	4	0,8	ILFR6B	6481		
Impreza 2.5		2.5	169	08 -	N/A	4	0,8	ILFR6B	6481		
Impreza WRX Sti St1		2.5	206	09.05 -	EJ25	4	0,8	ILFR6B	6481		
Impreza WRX Sti		2.5	206	06 -	EJ25	4	0,8	ILFR6B	6481		
Impreza WRX Sti (GRF)		2.5	221	01.08 -	EJ25	4		SILFR6A	7913		

**JUSTY**

Justy 1.0		1.0	52	07 -	1KR-FE Daihatsu engine	3	1,1	ILFR6T11	4904		
Justy 1000		1.0		85 - 03	EF10 Cat.	4	1,1	BPR6ES-11	4824	13	LPG 2
Justy 1200		1.2	55	87 - 03	EF12/EF12 Cat.	4	1,1	BPR6ES-11	4824	13	LPG 2
Justy 1300		1.3	50	10.95 - 03	G13BA	4	0,8	BPR6ES	7822	2	LPG 2
Justy G3X		1.3	69	09.03 -	M13A DOHC	4	1,1	BKR6E-11	2756	14	LPG 1
Justy G3X		1.5	73	09.03 -	M15A DOHC	4	1,1	IFR6J11	7658		

**LEGACY**

Legacy 2,0 Sedan		2.0	84	92 - 95	EJ20/4	4	1,1	BKR6E-11	2756	14	LPG 1
Legacy 2,0 Super Station		2.0	84	92 - 95	EJ20	4	1,1	BKR6E-11	2756	14	LPG 1
Legacy		2.0	85	05.94 -	EJ20	4	1,1	BKR6E-11	2756	14	LPG 1
Legacy 2,0		2.0	92	12.98 - 03	EJ20	4	1,1	BKR6E-11	2756	14	LPG 1
Legacy IV 2.0	B13BL	2.0	101	09.03 - 10.05	EJ20	4	1,1	BKR6E-11	2756	14	LPG 1
Legacy IV 2.0	B13BL	2.0	110	06.03 - 04.09	EJ204	4	0,8	ILFR6B	6481		
Legacy V 2.0	B14BM	2.0	110	04.09 -	EJ204	4	1,1	SILFR6C11	7505		

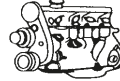
Code *l* kW

Cyl.

Stock-No.  
**V-TIME**  
E-POWER\*

LPG/CNG

**SUBARU****LEGACY**

Legacy IV 2.0	B13BL	2.0	121	06.05 - 04.09	EJ20X	4	0,8	ILFR6B	6481		
Legacy 2,0 Turbo Sedan		2.0	147	92 - 93	EJ20	4	0,8	PFR6B	3500		LPG 1
Legacy 2,0 Turbo Sup.Stat.		2.0	147	92 - 93	EJ20	4	0,8	PFR6B	3500		LPG 1
Legacy 2,0 Turbo		2.0	147	93 - 96	EJ20	4	0,8	PFR6G	4793		PFR7G
Legacy		2.2	94	05.94 - 02	EJ22	4	1,1	BKR6E-11	2756	14	LPG 1
Legacy 2,2 Station		2.2	96	94 - 02	EJ22	4	1,1	BKR6E-11	2756	14	LPG 1
Legacy 2,2 Sedan		2.2	100	90 - 93	EJ22	4	1,1	BKR6E-11	2756	14	LPG 1
Legacy 2,2 Super Station		2.2	100	90 - 94	EJ22/4	4	1,1	BKR6E-11	2756	14	LPG 1
Legacy Outback		2.5	110	96 - 02	EJ25	4	1,1	PFR6B-11	4014		PFR7B
Legacy 2,5 Outback		2.5	115	12.98 - 03	EJ25	4	1,1	BKR6E-11	2756	14	LPG 1
Legacy IV 2.5	B13BL	2.5	121	09.03 - 04.09	EJ25	4	1,1	PFR5B-11	2300		PFR6B
Legacy V 2.5	B14BM	2.5	123	09.09 -	EJ253	4	1,1	SIFR6A11	0127		
Legacy H6-3.0		3.0	154	01 - 03		6	1,1	PLFR6A-11	7654		LPG 7
Legacy Outback H6-3.0		3.0	154	01 - 03		6	1,1	PLFR6A-11	7654		LPG 7
Legacy IV 3.0 R	B13BL	3.0	180	09.03 - 06.09	EZ30	6	0,8	ILFR6B	6481		
Legacy 3.6		3.6	188	04.09 -	EZ5 H6	6	1,1	SILFR6C11	7505		

**LIBERO**

Libero 1200		1.2	38	87 - 00	EF12	4	1,1	BPR6ES-11	4824	13	LPG 2
-------------	--	-----	----	---------	------	---	-----	-----------	------	----	-------

**OUTBACK**

Outback 2.5 (BL, BP)		2.5	121	09.03 -	EJ25	4	1,1	PFR5B-11	2300		PFR6B
Outback 2.5 (BM, BR)	B14BR	2.5	123	09.09 -	EJ253	4	1,1	SIFR6A11	0127		
Outback 3.0 R (BL, BP)		3.0	180	11.03 -	EZ30	6	0,8	ILFR6B	6481		
Outback 3.6 R (BM, BR)		3.6	191	09.09 -	EZ36D	6	1,1	SILFR6C11	7505		

**PLEO**

Pleo (RA1,RA2)		0.66		10.01 - 01.04	EN07	4		KR8BI	4347		
----------------	--	------	--	---------------	------	---	--	-------	------	--	--

**R1**

R1 (RJ1,RJ2)		0.66		06 -	EN07	4		KR8BI	4347		
--------------	--	------	--	------	------	---	--	-------	------	--	--

**R2**

R2 (RC1,RC2)		0.66		12.03 -	EN07	4		KR8BI	4347		
--------------	--	------	--	---------	------	---	--	-------	------	--	--

**SVX**

SVX		3.3	162	92 - 12.97	EG33	6	1,1	PFR6G-11	5555		PFR7G
-----	--	-----	-----	------------	------	---	-----	----------	------	--	-------

**TRIBECA**

Tribeca B9		3.0	184	06 -	EZ30	6	0,8	ILFR6B	6481		
Tribeca B9		3.6	190	09.07 -	EZ36D	6		SILFR6A	7913		

**VIVIO**

Vivio		0.7		03.92 -	MFI	4	1,1	BKR6E-11	2756	14	LPG 1
Vivio		0.7		03.92 -	Vergaser/Carb	4	1,1	BKR5E-11	6953	33	LPG 1

**XV**

XV 1.6i	G33	1.6	84	03.12 -	FB16A / FB16B	4	1,1	SILZKAR7B11	93482		
XV 2.0i	G33	2.0	110	03.12 -	FB20A / FB20B	4	1,1	SILZKAR7B11	93482		

**SUZUKI****ALTO**

Alto (HA24V)		0.6		01.05 -	K6A	3		KR7AI	7789		
Alto (SB308)		0.8	29	86 - 92	F8B	3	0,9	BPR5ES	7422	6	LPG 2
Alto (SH410)		1.0	39	94 - 00	G10B	4	0,8	BPR5EY	2828	9	LPG 2

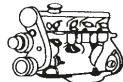

Code *l* kW

Cyl.



Stock-No.

V-*LINE*  
10-15-20-25-30-35-40-45-50-55-60-65-70-75-80-85-90-95-100-105-110-115-120-125-130-135-140-145-150-155-160-165-170-175-180-185-190-195-200-205-210-215-220-225-230-235-240-245-250-255-260-265-270-275-280-285-290-295-300-305-310-315-320-325-330-335-340-345-350-355-360-365-370-375-380-385-390-395-400-405-410-415-420-425-430-435-440-445-450-455-460-465-470-475-480-485-490-495-500-505-510-515-520-525-530-535-540-545-550-555-560-565-570-575-580-585-590-595-600-605-610-615-620-625-630-635-640-645-650-655-660-665-670-675-680-685-690-695-700-705-710-715-720-725-730-735-740-745-750-755-760-765-770-775-780-785-790-795-800-805-810-815-820-825-830-835-840-845-850-855-860-865-870-875-880-885-890-895-900-905-910-915-920-925-930-935-940-945-950-955-960-965-970-975-980-985-990-995-1000

LPG/CNG

**SUZUKI****ALTO**

Alto (AMF310)		1.0	50	04.09 -	K10B	3	1,1	IKR6G11	7980		
Alto (SH410)		1.0	53	94 - 12.00	G10B	4	0,8	BPR5EY	2828	9	LPG 2
Alto		1.0		01.01 -	G10B	4	0,9	BKR6E	6962	28	LPG 1
Alto (FF)		1.1	46	06.02 -	K10A / F10D DOHC 16V	4	0,8	DCPR7E	3932		LPG 8
Alto Lapin HE21S		1.6		01.02 -	K6A...	4	0,8	DCPR7E	3932		LPG 8

**BALENO**

Baleno (SY413)		1.3	63	04.95 -	G13BB	4	0,9	BKR6E	6962	28	LPG 1
Baleno (SY416)		1.6	72	04.95 -	G16B	4	0,9	BKR6E	6962	28	LPG 1
Baleno		1.6		95 -	G16A (16V)	4	0,9	BKR6E	6962	28	LPG 1
Baleno (SY418)		1.8	89	03.96 - 12.00	J18A	4	1,1	BKR6E-11	2756	14	LPG 1
Baleno (SY418)		1.8	89	11.00 -	16V	4	1,1	IFR6J11	7658		
Baleno D		1.9	46	98 -		4		Y-924J	7906	1	
Baleno TD		1.9	55	98 -		4		Y-924J	7906	1	

**CAPPUCCINO**

Cappuccino 660 12V Turbo		0.66	47	09.91 -	F6A DOHC Cat.	3	0,8	DCPR7EVX	1179		LPG 8
Cappuccino 660 12V Turbo		0.66	47	05.95 -	K6A DOHC Cat.	3	0,8	DCPR7EVX	1179		LPG 8

**CARRY**

Carry (DC51T/B,DD51T)		0.66		09.91 - 01.99	F6A 4Valve	3	0,8	DCPR7E	3932		LPG 8
Carry (DE51V,DF51V)		0.66		09.91 - 01.99	F6A 2Valve Turbo	3	0,9	BPR5E	7281	6	LPG 2
Carry (DE51V,DF51V)		0.66		09.91 - 01.99	F6A 4Valve	3	0,8	DCPR7E	3932		LPG 8
Carry (DC51T,DD51T)		0.66		04.97 - 01.99	F6A 2Valve Turbo	3	0,7	PGR5A	3987		
Carry (DA52T,DB52T)		0.66		01.99 - 05.00	F6A 2Valve Turbo	3	0,9	BPR5E	7281	6	LPG 2
Carry (DA52T,DB52T)		0.66		01.99 - 09.01	F6A 4Valve	3	0,8	DCPR7E	3932		LPG 8
Carry (DA62T)		0.66		09.01 - 05.02	K6A 4Valve DOHC	3	0,8	DCPR7E	3932		LPG 8
Carry (DA63T)		0.66		05.02 -	K6A 4Valve DOHC	3	0,8	DCPR7E	3932		LPG 8
Carry (DA63T)		0.66		05.02 -	K6A 4Valve DOHC	3		KR7AI	7789		
Carry		1.3		06.99 -	G13BB	4	0,9	BKR6E	6962	28	LPG 1
Carry Super (SK410)		1.0	31	92 - 99	F10A Cat.	4	0,9	BPR5ES	7422	6	LPG 2
Carry Super (SK410)		1.0	33	87 - 99	F10A u.Cat.	4	0,9	BPR5ES	7422	6	LPG 2
Carry Van		1.3		99 -	G13BB	4	0,9	BKR6E	6962	28	LPG 1

**ESCUDO**

Escudo		1.6	71	08.90 - 11.97	G16A	4	0,9	BKR6E	6962	28	LPG 1
Escudo		1.6	71	12.97 - 04.00	G16A	4	1,1	BKR6E-11	2756	14	LPG 1
Escudo		1.6	71	05.00 -	G16A	4	1,1	IFR6E11	6741		
Escudo		2.0		12.94 - 10.96	H20A	4	0,9	BKR6E	6962	28	LPG 1
Escudo		2.0		10.96 - 11.97	J20A	4	0,9	BKR6E	6962	28	LPG 1
Escudo		2.0		11.97 - 04.00	J20A	4	1,1	BKR6E-11	2756	14	LPG 1
Escudo		2.0		04.00 -	H25A	6	1,1	IFR5J11	7418		IFR6J11
Escudo		2.0		04.00 - 04.05	J20A	4	1,1	IFR5J11	7418		IFR6J11
Escudo (TD54W)		2.0		05.05 -	J20A	4	1,1	IFR6J11	7658		
Escudo		2.5		10.96 - 11.97	H25A	6	0,9	BKR6E	6962	28	LPG 1
Escudo		2.5		03.98 - 04.00	H25A	6	1,1	BKR6E-11	2756	14	LPG 1
Escudo (TD94W)		2.7		06.05 -	H27A	4	1,1	IFR6J11	7658		

**GRAND VITARA**

Grand Vitara		1.6	69	03.98 -	G16A / G16B	4	1,1	BKR6E-11	2756	14	LPG 1
Grand Vitara (only D)		1.6	69	01 -	G16A / G16B	4	1,1	IFR6J11	7658		
Grand Vitara (JB416)		1.6	78	04.05 -	M16A VVT	4	1,1	IFR6J11	7658		
Grand Vitara 1.9 DDIS (JB419D)		1.9	95	10.05 -	F9Q	4		Y-732J	5605	4	
Grand Vitara 1.9 DDIS Euro V (JT)		1.9	95	03.06 - 08.08	F9QB	4		Y1036AS	96062		

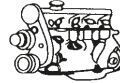
Code *l* kW

Cyl.



Stock-No.

**SUZUKI****GRAND VITARA**

Grand Vitara TDiC (SQ420D)		2.0	64	05.00 -	RF	4	☑	Y-701J	1566	39	
Grand Vitara Tdi II (SQ420D)		2.0	80	03.01 -	RHZ	4	☑	Y-504J	1441	24	
Grand Vitara TD XL7(JA420D)		2.0	80	04 -	RHW	4	☑	Y-504J	1441	24	
Grand Vitara D		2.0	81	04.01 -	HDi PSA	4	☑	Y-504J	1441	24	
Grand Vitara		2.0	94	01.98 - 09.00	J20A	4	1,1	IFR6J11	7658		
Grand Vitara (JB420)		2.0	103	09.05 -	J20A	4	1,1	IFR5J11	7418		IFR6J11
Grand Vitara (JB420)		2.0	103	09.05 -	M20A	4	1,1	IFR5E11	7994		IFR6E11
Grand Vitara		2.0		10.00 -	J20	4	1,1	IFR5J11	7418		IFR6J11
Grand Vitara 2.4 (JB424)		2.4	122	06.08 -	J24B	4	1,1	SILFR6A11	5468		
Grand Vitara 2.4 (JB424)		2.4	124	06.08 -	J24B	4	1,1	SILFR6A11	5468		
Grand Vitara V6 (SV620)		2.5	106	04.98 - 09.00	H25	6	1,1	BKR6E-11	2756	14	LPG 1
Grand Vitara V6 (SV620)		2.5	125	01.98 -	H25A	6	1,1	BKR6E-11	2756	14	LPG 1
Grand Vitara		2.5		10.00 -	H25	6	1,1	IFR5J11	7418		IFR6J11
Grand Vitara V6		2.7	127	09.01 -	H27A	6	1,1	IFR5J11	7418		IFR6J11
Grand Vitara XL7 (UBD) JB627W		2.7	135	04.03 - 08.08	H27A	6	1,1	IFR6J11	7658		

**IGNIS**

Ignis II 1.3 DDiS	RM413D	1.3	51	09.03 -	Z13DT	4	☑	Y8003J	97256	62	
Ignis 1.3	RG413	1.3	61	10.00 - 09.03	M13A	4	1,1	IFR6J11	7658		
Ignis II 1.3	RM413	1.3	69	10.03 -	M13A mit VVT	4	1,1	IFR6J11	7658		
Ignis II 1.5	RM415	1.5	73	08.03 -	M15A mit VVT	4	1,1	IFR6J11	7658		
Ignis II 1.5i Sport	RG415	1.5	80	08.03 -	M15A	4	1,1	IFR6J11	7658		

**JIMNY**

Jimny Cabrio		1.3	59	10.98 -	G13BB	4	0,9	BKR6E	6962	28	LPG 1
Jimny		1.3	60	05.01 - 07.04	M13A	4	1,1	IFR6J11	7658		
Jimny		1.3	63	08.05 -	M13A	4	1,1	IFR6J11	7658		
Jimny DDiS (SN415D)	SN415D	1.5	48	12.03 -	K9K	4	☑	Y-732J	5605	4	
Jimny DDiS (SN415D)	SN415D	1.5	63	08.05 -	K9K 266	4	☑	Y-732J	5605	4	

**KIZASHI**

Kizashi 2.4	FR	2.4	131	10.10 -	J24B	4	1,1	SILFR6A11	5468		
-------------	----	-----	-----	---------	------	---	-----	-----------	------	--	--

**LIANA**

Liana		1.3	66	03.01 - 01.04	M13A	4	1,1	BKR6E-11	2756	14	LPG 1
Liana		1.3	66	02.04 -	M13A	4	1,1	IFR6J11	7658		
Liana DDiS (RH414D)	RH414D	1.4	66	07.04 -	DV4 8HY	4	☑	YE04	1684	40	
Liana		1.6	78	03.01 - 01.04		4	1,1	BKR6E-11	2756	14	LPG 1
Liana		1.6	78	02.04 -	M16A	4	1,1	IFR6J11	7658		

**SAMURAI**

Samurai		1.0	33	90 -	F10A	4	0,9	BPR5ES	7422	6	LPG 2
Samurai (SJ413)		1.3	51	90 -	G13BA Cat.	4	0,9	BPR5ES	7422	6	LPG 2
Samurai		1.3	51	92 -	G13BA	4	0,9	BPR5ES	7422	6	LPG 2
Samurai Pick-up		1.3	51	10.99 - 10.00	G13BA	4	0,9	BPR5ES	7422	6	LPG 2
Samurai TD		1.9	46	09.98 -	XUD9	4	☑	Y-924J	7906	1	

**SPLASH**

Splash 1.0 (A5B310)		1.0	48	01.08 - 07.11	K10B	3	1,1	IKR6G11	7980		
Splash 1.2 (A5B412)		1.2	63	01.08 -	K12B	4	1,1	IKR6G11	7980		
Splash 1.2 VWT (A5B412)		1.2	69	09.10 -	K12B	4	1,1	IKR6G11	7980		
Splash 1.3 DDiS (A5B413D)		1.3	55	01.08 -	D13A	4	☑	Y8003J	97256	62	

**SWIFT II**

Swift II 1.0	SF310	1.0	37	03.89 - 05.01	G10A	3	0,8	BPR6ES	7822	2	LPG 2
Swift II 1.0	SF310	1.0	39	09.91 - 05.01	G10A	3	0,8	BPR6ES	7822	2	LPG 2
Swift II 1.3	SF413	1.3	50	03.89 - 05.01	G13A	4	0,8	BPR6ES	7822	2	LPG 2

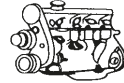
Code *l* kW

Cyl.



Stock-No.



LPG/CNG

**SUZUKI  
SWIFT II**

Swift II 1.3 4WD	SF413	1.3	50	03.89 - 05.01	G13A	4	0,8	BPR6ES	7822	2	LPG 2
Swift II 1.3 Gti	SF413	1.3	74	03.89 - 05.01	G13B	4	0,8	BPR6ES	7822	2	LPG 2
Swift II 1.6	SF416	1.6	68	01.90 - 05.01	G16B	4	0,9	BKR6E	6962	28	LPG 1

**SWIFT III**

Swift III 1.3 DDiS	RS413D	1.3	52	08.05 -	Z13DT	4	<input checked="" type="checkbox"/>	Y8003J	97256	62	
Swift III 1.3 DDiS	RS413D	1.3	55	10.07 -	D13A / Z13DTJ	4	<input checked="" type="checkbox"/>	Y8003J	97256	62	
Swift III 1.3 4X4	RS413	1.3	66	01.06 -	M13A	4	1,1	IFR6J11	7658		
Swift III 1.3	RS413	1.3	68	02.05 -	M13A	4	1,1	IFR6J11	7658		
Swift III 1.5	RS415	1.5	75	02.05 -	M15A	4	1,1	IFR6J11	7658		
Swift III 1.6 Sport	RS416	1.6	92	05.06 -	M16A	4	1,1	IFR6J11	7658		

**SWIFT IV**

Swift IV 1.2	AZG41	1.2	66	10.10 -	K12B	4	1,1	IKR6G11	7980		
Swift IV 1.2	AZG41	1.2	69	10.10 -	K12B	4	1,1	IKR6G11	7980		
Swift IV 1.6	AZG41	1.6	100	01.12 -	M16A	4	1,1	SILFR6A11	5468		

**SX4 I**

SX4 I 1.5	RW415	1.5	73	06.06 -	M15A	4	1,1	IFR6J11	7658		
SX4 I 1.5 VWT	RW415	1.5	82	07.09 -	M15A VWT	4	1,1	IFR6J11	7658		
SX4 I 1.6 VWT	RW416	1.6	79	06.06 -	M16A VWT	4	1,1	IFR6J11	7658		
SX4 I 1.6 VWT	RW416	1.6	82	07.09 -	M16A VWT	4	1,1	IFR6J11	7658		
SX4 I 1.6 VWT	RW416	1.6	88	07.09 -	M16A VWT	4	1,1	IFR6J11	7658		
SX4 I 1.9 DDiS	RW419D	1.9	88	06.06 -	D19AA	4	<input checked="" type="checkbox"/>	Y1030J	90828	70	
SX4 I 2.0 DDiS	RW420D	2.0	99	07.09 -	D20AA	4	<input checked="" type="checkbox"/>	Y9003AS	94251	78	

**SX4 II**

SX4 II 1.6 VWT	AKK416	1.6	88	08.13 -	M16A	4	1,1	SILFR6A11	5468		
SX4 II 1.6 DDiS	AKK416D	1.6	88	08.13 -	D16AA	4	<input checked="" type="checkbox"/>	Y9003AS	94251	78	

**VITARA**

Vitara (SE416) Typ 2		1.6	59	- 98	G16A SOHC	4	0,9	BPR5ES	7422	6	LPG 2
Vitara		1.6	59	91 - 98	G16B Cat.	4	0,8	BPR6ES	7822	2	LPG 2
Vitara (SE416) Typ 1		1.6	60	88 - 98	G16A SOHC Cat.	4	0,9	BPR5ES	7422	6	LPG 2
Vitara		1.6	60	91 - 98	G16A	4	0,9	BPR5ES	7422	6	LPG 2
Vitara Long		1.6	71	91 - 98	G16B SOHC Cat.	4	0,9	BKR6E	6962	28	LPG 1
Vitara 16V		1.6	71	04.95 - 98	G16A	4	0,9	BKR6E	6962	28	LPG 1
Vitara		1.6		10.00 -	G16A	4	1,1	IFR6E11	6741		
Vitara TD		1.9	50	04.96 - 03.98	XUD9A	4	<input checked="" type="checkbox"/>	Y-924J	7906	1	
Vitara TD		1.9	55	97 - 98		4	<input checked="" type="checkbox"/>	Y-924J	7906	1	
Vitara TD		1.9	66	05.00 -	XUD... PSA Group	4	<input checked="" type="checkbox"/>	Y-924J	7906	1	
Vitara D		2.0	52	12.94 - 03.98	RFL-4	4	<input checked="" type="checkbox"/>	Y-701J	1566	39	
Vitara (SV620)		2.0	100	06.95 -	H20A	6	0,9	BKR6E	6962	28	LPG 1
Vitara		2.0			J20A	6	0,9	BKR6E	6962	28	LPG 1
Vitara V6 (SV620)		2.5	125	05.98 -	H25A	6	1,1	BKR6E-11	2756	14	LPG 1
Vitara		1.6	70	09.93 - 98	G16B	4	0,9	BKR6E	6962	28	LPG 1

**WAGON R+**

Wagon R+ 12V		1.0	44	03.05 -	Z10XEP	3	1,1	ZFR5F-11	2262		LPG 6
Wagon R+ (SR410)		1.0	48	97 -	K10A	4	0,8	DCPR7E	3932		LPG 8
Wagon R+		1.0	55	02.04 -	G10	4	1,1	BPR6ES-11	4824	13	LPG 2
Wagon R+		1.2	51	98 -	K12A	4	0,8	DCPR7E	3932		LPG 8
Wagon R+ 16V		1.2	59	03.05 -	Z12XEP	4	1,1	ZFR5F-11	2262		LPG 6
Wagon R+ DDiS (RB413D)		1.3	51	09.03 -	Z13DT	4	<input checked="" type="checkbox"/>	Y8003J	97256	62	
Wagon R GL		1.3	56	04.00 -	G13BB	4	1,1	BKR6E-11	2756	14	LPG 1

Code *l* kW

Cyl.



Stock-No.

FINE

E-POWER

LPG/CNG

**SUZUKI****WAGON R+**

Wagon R+		1.3	68	02.04 -	M13A mit VVT	4	1,1	IFR6J11	7658		
Wagon R+		1.3	69		G13BB	4	1,1	BKR6E-11	2756	14	LPG 1

**X-90**

X-90		1.6	71	10.95 -	G16A	4	0,9	BKR6E	6962	28	LPG 1
X-90		1.6	71	03.96 -	G16B/G16W	4	0,9	BKR6E	6962	28	LPG 1

**TOFAS**

131 Dogan S/SX/SLX		1.6	55	06.92 -		4	0,8	BPR6ES	7822	2	LPG 2
131 Kartal SL / SLX		1.6	55	06.92 -		4	0,8	BPR6ES	7822	2	LPG 2
Tempra		1.6	63	11.90 -		4	0,8	BPR6ES	7822	2	LPG 2
Tempra i.e.		2.0	88	07.92 -		4	0,8	BPR6ES	7822	2	LPG 2

**TOFAS / FIAT**

Brava 16V		1.2		11.98 - 09.01	16V	4	0,9	DCPR8E-N	5692		LPG 8
Brava 1.4 12V		1.4		10.95 - 10.98	12V	4		BKR6EKC	2848	26	LPG 1
Bravo 16V		1.2		11.98 - 09.01	16V	4	0,9	DCPR8E-N	5692		LPG 8
Bravo 1.4 12V		1.4		10.95 - 10.98	12V	4		BKR6EKC	2848	26	LPG 1
Doblo 16V		1.3		11.01 -	MPI 16V	4	0,9	DCPR8E-N	5692		LPG 8
Marea 1.4 12V		1.4		10.96 - 02.99	12V	4		BKR6EKC	2848	26	LPG 1
Marea 2.0 20V		2.0		10.96 - 02.99	20V	4		BKR6EKC	2848	26	LPG 1
Palio 1.2 i.e.		1.2		10.01 -	16V	4	0,9	DCPR8E-N	5692		LPG 8
Palio Weekend 1.2 i.e.		1.2		10.01 -	16V	4	0,9	DCPR8E-N	5692		LPG 8
Palio 16V		1.3		03.00 -	MPI 16V	4	0,9	DCPR8E-N	5692		LPG 8
Palio Weekend 16V		1.3		03.00 -	MPI 16V	4	0,9	DCPR8E-N	5692		LPG 8
Palio 1.4 i.e.		1.4		03.98 - 09.01		4		BKR5EK	7956	23	LPG 1
Palio Weekend 1.4 i.e.		1.4		09.98 - 06.01		4		BKR5EK	7956	23	LPG 1
Siena 16V		1.3		03.00 -	MPI 16V	4	0,9	DCPR8E-N	5692		LPG 8
Siena 1.4 i.e.		1.4		05.98 - 06.01		4		BKR5EK	7956	23	LPG 1
Stilo 16V		1.2		10.01 -	16V	4	0,9	DCPR8E-N	5692		LPG 8
Stilo 1.6 16V		1.6		10.01 -	16V	4	0,9	BKR5EZ	7642	36	LPG 1
Stilo S.W. 1.6 16V		1.6		01.03 -	16V	4	0,9	BKR5EZ	7642	36	LPG 1
Stilo 1.8 16V		1.8		10.01 -	16V	4	0,9	BKR6EZ	4619	38	LPG 1
Stilo S.W. 1.8 16V		1.8		01.03 -	16V	4	0,9	BKR6EZ	4619	38	LPG 1

**TOYOTA****4 RUNNER**

4 Runner 2.4		2.4	82	89 - 95	22R/22RE Cat.	4	0,8	BPR5EY	2828	9	LPG 2
4 Runner 2.4 TD		2.4		01.90 - 12.96	2L-T	4	☑	Y-715R	5376		
4 Runner 2.4 D		2.5		01.93 -	2L-T	4	☑	Y-715R	5376		
4 Runner 2.7	RZN185	2.7	112	98 - 12.99	3RZ-FE	6	0,8	BKR5EYA	2087		LPG 1
4 Runner 2.7	VZN185	2.7	112	98 - 12.99	3RZ-FE	6	0,8	BKR5EYA	2087		LPG 1
4 Runner 2.7	RZN180, 185, VZN180 185	2.7		01.00 -	3RZ-FE	6	0,8	BKR5EYA	2087		LPG 1
4 Runner 2.8 D		2.8		93 - 96	3L	4	☑	Y-715R	5376		
4 Runner 2.8 D		2.8		01.93 - 96	3L	4	☑	Y-715R	5376		
4 Runner 3.0 D	KZN185	3.0	92	10.93 - 03.96	1KZ-T	4	☑	Y1013J	94470	63	
4 Runner 3.0		3.0	105	89 - 96	3VZ-E Cat.	6	0,8	BKR5EYA	2087		LPG 1

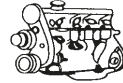
Code *l* kW

Cyl.



Stock-No.



LPG/CNG

**TOYOTA  
4 RUNNER**

4 Runner 3.4	RZN185	3.4	136	98 - 12.99	5VZ-FE	6		BKR5EKB-11	3967		
4 Runner 3.4	VZN185	3.4	136	98 - 12.99	5VZ-FE	6		BKR5EKB-11	3967		
4 Runner 3.4	RZN180,	3.4		01.00 -	5VZ-FE	6		BKR5EKB-11	3967		
	185,										
	VZN180										
	185										
4 Runner 4.0	GRN210,	4.0		01.04 -	1GR-FE	6	1,1	LFR6C-11	5788		
	215										

**AURIS I**

Auris I 1.33 VWT-i	NRE150	1.33	73	01.10 - 09.12	1NR-FE	4	1,1	ILKAR7B11	4912		
Auris I 1.33 VWT-i	NRE150	1.33	74	11.08 - 01.10	1NR-FE	4	1,1	ILKAR7B11	4912		
Auris I 1.4 D-4D	ADE150,	1.4	66	03.07 - 09.12	1ND-TV	4		Y-542J	5513	45	
	157,										
	NDE150,										
	151										
Auris I 1.4 VWT-i	ZRE151	1.4	71	10.06 - 09.12	4ZZ-FE	4	1,1	BKR5EYA-11	2526	39	LPG 1
Auris I 1.6 VWT-i	ZRE151	1.6	91	10.06 - 09.12	1ZR-FE	4	1,1	ILKAR7B11	4912		
Auris I 1.6	ZRE151	1.6	97	12.08 - 09.12	1ZR-FAE	4	1,1	ILKAR7B11	4912		
Auris I 1.8 Hybrid	ZWE150	1.8	73	09.10 - 09.12	2ZR-FXE	4	1,1	ILKAR7B11	4912		
Auris I 1.8	ZZE150,	1.8	100	10.06 - 09.12	2ZR-FE	4	1,1	ILKAR7B11	4912		
	ZRE151,152										
Auris I 1.8	ZRE152H	1.8	108	02.09 - 09.12	2ZR-FAE	4	1,1	ILKAR7B11	4912		
Auris I 2.2 D-CAT	NDE150,	2.2	130	03.07 -	2ADFHV	4		Y1012J	92083	65	
	ADE150,157										

**AURIS II**

Auris II 1.33 VWT-i	NRE180	1.33	73	10.12 -	1NR-FE	4	1,1	ILKAR7B11	4912		
Auris II 1.5		1.5	80	10.12 -	1NZ-FE	4	1,1	ILKAR7B11	4912		
Auris II 1.6	ZRE181,185	1.6	97	10.12 -	1ZR-FAE	4	1,1	ILKAR7B11	4912		
Auris II 1.8 Hybrid	ZWE186	1.8	73	10.12 -	2ZR-FXE	4	1,1	ILKAR7B11	4912		
Auris II 1.8		1.8	103	10.12 -	2ZR-FAE	4	1,1	ILKAR7B11	4912		
Auris II 1.8		1.8	106	10.12 -	2ZR-FAE	4	1,1	ILKAR7B11	4912		

**AVALON**

Avalon 3.0	MCX20	3.0		01.01 - 12.01	1MZ-FE	6		BKR6EKB-11	3583		
Avalon 3.0	MCX20	3.0		01.02 -	1MZ-FE	6		BKR6EKP-11	3452		

**AVENSIS**

Avensis (AT220,221,ST220)		1.6	81	04.98 -	4A-FE	4	1,1	BKR6EYA-11	4073		LPG 1
Avensis (AZT220)		1.6		01.02 -	3ZZ-FE	4	1,1	BKR5EYA-11	2526	39	LPG 1
Avensis (ST220)		1.6		01.02 -	3ZZ-FE	4	1,1	BKR5EYA-11	2526	39	LPG 1
Avensis (ZZT220, 221)		1.6		01.02 -	3ZZ-FE	4	1,1	BKR5EYA-11	2526	39	LPG 1
Avensis (ZZT250,251)(AZT250)		1.6		09.03 -	3ZZ-FE	4	1,1	BKR5EYA-11	2526	39	LPG 1
Avensis (AT220,221,ST220)		1.8	81	01.98 -	7A-FE	4	1,3	BKR6EP-13	2550		
Avensis (ST220)		1.8	95	01.02 -	1ZZ-FE	4	1,1	BKR5EYA-11	2526	39	LPG 1
Avensis (ZZT220, 221)		1.8	95	01.02 -	1ZZ-FE	4	1,1	BKR5EYA-11	2526	39	LPG 1
Avensis (AZT220)		1.8		01.02 -	1ZZ-FE	4	1,1	BKR5EYA-11	2526	39	LPG 1
Avensis (ZZT250,251)(AZT250)		1.8		09.03 -	1ZZ-FE	4	1,1	BKR5EYA-11	2526	39	LPG 1
Avensis (CT220)		2.0	66	01.98 -	2C-T	4		Y-532J	7782		
Avensis (CT220)		2.0	66	01.98 -	2C-TE	4		Y-532J	7782		
Avensis (AT220,221,ST220)		2.0	94	01.98 -	3S-FE	4		BKR6EKP-11	3452		

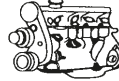

Code *l* kW

Cyl.



Stock-No.

V-TIME  
E-FORWARD  
LPG/CNG**TOYOTA****AVENSIS**

Avensis (AZT220)		2.0	110	07.00 - 02.03	1AZ-FSE	4	1,1	HB6BIX-11P	5705		
Avensis (AZT220)		2.0		01.02 -	3S-FE	4		BKR6EKB-11	3583		
Avensis (ST220)		2.0		01.02 -	3S-FE	4		BKR6EKB-11	3583		
Avensis (ZZT220, 221)		2.0		01.02 -	3S-FE	4		BKR6EKB-11	3583		
Avensis (1AZ-FE)		2.0		01.03 -	1AZ-FE with 3way cat	4	1,1	IFR6T11	4589		
Avensis (1AZ-FE)		2.0		01.03 -	1AZ-FE without cat	4	1,1	BKR6EYA-11	4073		LPG 1
Avensis (AZT250 / W)		2.0	108	03.03 - 10.08	1AZ-FSE	4	1,1	HB6BIX-11P	5705		
Avensis 2.2D-Cat (ADT251)		2.2	130	06.05 - 10.08	2ADFHV	4	■	Y1012J	92083	65	
Avensis (AZT251/ W)		2.4	120	10.03 - 10.08	2AZ-FSE	4	1,1	HB6BIX-11P	5705		
Avensis 2 (ZZT250;251)(AZT250)		1.6	81	03.03 - 09	3ZZ-FE	4	1,1	BKR5EYA-11	2526	39	LPG 1
Avensis 2 (ZZT250;251)(AZT250)		1.8	95	03.03 - 09	1ZZ-FE	4	1,1	BKR5EYA-11	2526	39	LPG 1
Avensis 2 (CDT250) D- Cat		2.0	85	03.03 - 04.06	1CD-FTV	4	■	Y-531J	5467	44	
Avensis 2 (ATZ250)		2.0	110	01.03 - 09	1AZ-FE V V T-i	4	1,1	IFR6T11	4589		
Avensis 3 (ZRT270)		1.6	81	04.08 -	1ZRFAE	4	1,1	ILKAR7B11	4912		
Avensis 3 (ZRT270)		1.6	97	11.08 -	1ZRFAE	4	1,1	ILKAR7B11	4912		
Avensis 3 (ZRT271)		1.8	108	11.08 -	2ZRFAE	4	1,1	ILKAR7B11	4912		
Avensis 3 (ZRT272)		2.0	112	11.08 -	3ZRFAE	4	1,1	ILKAR7B11	4912		
Avensis 3 D-CAT (ADT271)		2.2	130	02.09 -	2ADFHV	4	■	Y1012J	92083	65	

**AVENSIS VERSO**

Avensis Verso 2.0	ACM20	2.0	110	05.01 -	1AZ-FE	4	1,1	IFR6T11	4589		
Avensis Verso 2.4	ACM20	2.4		01.04 -	2AZ-FE	4	1,1	BKR6EYA-11	4073		LPG 1

**AYGO**

Aygo 1.0		1.0	50	05.05 -	1KR-FE	3	1,1	LFR6C-11	5788		
Aygo 1.4 Hdi		1.4	52	06.05 -		4	■	YE05	91322	73	

**CAMRY**

Camry (SV20,21,25,VZV21)		2.0	89	86 -	3S-FE Cat.	4	1,1	BCPR6EY-11	3720		LPG 3
Camry (SV20,21,25,VZV21)		2.0	94	87 -	3S-FE	4	1,1	BCPR6EY-11	3720		LPG 3
Camry (ACV30,31)		2.0		08.01 -	1AZ-FE	4	1,1	IFR6T11	4589		
Camry (MCV30)		2.0		08.01 -	1AZ-FE	4	1,1	IFR6T11	4589		
Camry (SXV10,VCV10)		2.2	100	92 -	5S-FE	4	1,1	BKR6EYA-11	4073		LPG 1
Camry MCV20		2.2	100	08.96 - 12.99	5S-FE with 3way cat	4		BKR6EKP-11	3452		
Camry MCV20		2.2	100	08.96 - 12.99	5S-FE without 3way cat	4		BKR6EKB-11	3583		
Camry SXV20		2.2	100	08.96 - 12.99	5S-FE with 3way cat	4		BKR6EKP-11	3452		
Camry SXV20		2.2	100	08.96 - 12.99	5S-FE without 3way cat	4		BKR6EKB-11	3583		
Camry (MCV20)		2.2		98 - 12.99	5S-FE	4		BKR6EKP-11	3452		
Camry (SVX20)		2.2		98 - 12.99	5S-FE	4		BKR6EKP-11	3452		
Camry (SVX20, MCV20)		2.2		01.00 -	5S-FE	4		BKR6EKB-11	3583		
Camry (ACV30,31)		2.4	112	08.01 -	2AZ-FE	4	1,1	IFR6T11	4589		
Camry (MCV30)		2.4	112	08.01 -	2AZ-FE	4	1,1	IFR6T11	4589		
Camry (ACV 40)		2.4	116	01.06 -	2AZ-FE	4	1,1	IFR6T11	4589		
Camry (SV21,25,VZV21)		2.5	118	88 - 92	2VZ-FE Cat.	6	1,1	BCPR6EP-11	3350		LPG 3
Camry (SVX20, MCV20)		3.0	137	01.00 -	1MZ-FE V6	6		BKR6EKP-11	3452		
Camry (SXV10,VCV10)		3.0	138	92 -	3VZ-FE	6	1,1	BCPR6EP-11	3350		LPG 3
Camry MCV20		3.0	138	08.96 - 12.99	1MZ-FE with 3way cat	6		BKR6EKP-11	3452		
Camry MCV20		3.0	138	08.96 - 12.99	1MZ-FE without 3way cat	6		BKR6EKB-11	3583		
Camry SXV20		3.0	138	08.96 - 12.99	1MZ-FE with 3way cat	6		BKR6EKP-11	3452		
Camry SXV20		3.0	138	08.96 - 12.99	1MZ-FE without 3way cat	6		BKR6EKB-11	3583		
Camry (ACV30,31)		3.0		08.01 -	1MZ-FE	6	1,1	IFR6T11	4589		

Code *l* kW

Cyl.



Stock-No.

V-**LINE**

10-15-20-25-30-35-40-45-50-55-60-65-70-75-80-85-90-95-100-105-110-115-120-125-130-135-140-145-150-155-160-165-170-175-180-185-190-195-200-205-210-215-220-225-230-235-240-245-250-255-260-265-270-275-280-285-290-295-300-305-310-315-320-325-330-335-340-345-350-355-360-365-370-375-380-385-390-395-400-405-410-415-420-425-430-435-440-445-450-455-460-465-470-475-480-485-490-495-500-505-510-515-520-525-530-535-540-545-550-555-560-565-570-575-580-585-590-595-600-605-610-615-620-625-630-635-640-645-650-655-660-665-670-675-680-685-690-695-700-705-710-715-720-725-730-735-740-745-750-755-760-765-770-775-780-785-790-795-800-805-810-815-820-825-830-835-840-845-850-855-860-865-870-875-880-885-890-895-900-905-910-915-920-925-930-935-940-945-950-955-960-965-970-975-980-985-990-995-1000

LPG/CNG

**TOYOTA  
CAMRY**

Camry (MCV30)		3.0		08.01 -	1MZ-FE	6	1,1	IFR6T11	4589		
---------------	--	-----	--	---------	--------	---	-----	---------	------	--	--

**CARINA E**

Carina E (AT190,191,ST191)		1.6	77	93 - 97	4A-FE Lean Burn engine	4	1,3	BKR6EP-13	2550		
Carina E (AT190,191,ST191)		1.6		93 - 97	4A-FE Standard engine	4	0,8	BKR6EYA	2249		LPG 1
Carina E (AT190,191,ST191)		1.8	79	95 -	7A-FE	4	1,3	BKR6EP-13	2550		
Carina E (AT190,191,ST191)		2.0	98	93 - 97	3S-FE Cat.	4	1,1	BKR6EYA-11	4073		LPG 1
Carina E (AT190,191,ST191)		2.0	116	93 -	3S-GE Cat.	4	0,8	BKR6EP-8	2215		LPG 1
Carina E		2.0		02.92 -	2C	4		Y-703R	3782		
Carina E (DK)		1.6		92 -	4A-FE Cat.	4	0,8	BKR6EYA	2249		LPG 1
Carina E (DK)		1.6		92 -	4A-FE Cat. Lean Burn	4	1,3	BKR6EP-13	2550		
Carina E (DK)		1.8		92 -	7A-FE Cat. Lean Burn	4	1,3	BKR6EP-13	2550		
Carina E (DK)		2.0		92 -	3S-FE Cat.	4	1,1	BKR6EYA-11	4073		LPG 1
Carina E (DK)		2.0		92 -	3S-FE Cat. Lean Burn	4	1,1	BKR6EP-11	2978		LPG 1

**CARINA II**

Carina II (AT171,177,ST171)		1.6	66	87 - 92	4A-F Cat.	4	0,8	BCRE527Y	2074		
Carina II (AT171,177,ST171)		1.6	72	90 - 92	4A-FE	4	0,8	BCPR5EY	1266		LPG 3
Carina II (AT171,177,ST171)		1.6	72	90 - 92	4A-FE Cat.	4	1,1	BCPR6EIX-11	4919		LPG 3
Carina II (AT171,177,ST171)		1.6	72	90 - 92	4A-FE with EGR	4	0,8	BCPR5EY	1266		LPG 3
Carina II (AT171,177,ST171)		1.6	72	90 - 92	4A-FE without EGR	4	1,1	BCPR6EIX-11	4919		LPG 3
Carina II (AT171,177,ST171)		2.0	89	88 - 92	3S-F	4	1,1	BCPR6EY-11	3720		LPG 3
Carina II (AT171,177,ST171)		2.0	98	88 - 92	3S-FE Cat.	4	1,1	BCPR6EY-11	3720		LPG 3
Carina II		2.0		93 -	2C	4		Y-703R	3782		

**CELICA**

Celica (AT180,ST182,184,185)		1.6	77	90 - 94	4A-FE	4	0,8	BCPR5EY	1266		LPG 3
Celica (AT200,ST202,204,205)		1.8	85	03.94 -	7A-FE	4	0,8	BKR6EYA	2249		LPG 1
Celica S (ZZT230)		1.8	105	08.99 -	1ZZ-FE	4	1,1	BKR5EYA-11	2526	39	LPG 1
Celica (ZZT230,231)		1.8		08.99 -	1ZZ-FE	4	1,1	BKR5EYA-11	2526	39	LPG 1
Celica (ZZT230,231)		1.8		08.99 -	2ZZ-GE	4	1,1	IFR6T11	4589		
Celica (AT200,ST202,204,205)		2.0	95	94 -	3S-FE	4	1,1	BKR6EYA-11	4073		LPG 1
Celica (AT180,200,ST182,184, 185,202,204,205)		2.0	115	90 -	3S-GE Cat.	4	0,8	BKR6EP-8	2215		LPG 1
Celica (AT180,200,ST182,184, 185,202,204,205)		2.0	129	03.94 -	3S-GE	4	0,8	BKR6EP-8	2215		LPG 1
Celica		2.0		90 - 99	3S-GTE	4	0,8	BKR6EP-8	2215		LPG 1
Celica (AT200)		2.0		98 -	3S-GE	4	0,8	BKR6EP-8	2215		LPG 1
Celica (ST202,204,205)		2.0		98 -	3S-GE	4	0,8	BKR6EP-8	2215		LPG 1
Celica (AT180,ST182,184,185)		2.2	100	91 -	5S-FE Cat.	4	1,1	BKR6EP-11	2978		LPG 1
Celica (AT200)		2.2		98 -	5S-FE	4	1,1	BKR6EP-11	2978		LPG 1
Celica (ST202,204,205)		2.2		98 -	5S-FE	4	1,1	BKR6EP-11	2978		LPG 1
Celica Turbo (AT200,ST202,204,205)		2.0	150	90 -	3S-GTE	4	0,8	BKR6EP-8	2215		LPG 1

**COROLLA**

Corolla (EE80,90,97,100,105, AE82,92,95,101)		1.3	55	86 - 92	2E	4	1,1	BPR6EY-11	4228	10	LPG 2
Corolla (EE90,97,AE92,95)		1.3	55	90 - 92	2E-E	4	0,8	BPR5EY	2828	9	LPG 2
Corolla (EE105)		1.3	63	07.97 - 07	2E	4	0,8	BPR6EY	6427		LPG 2
Corolla 1.33 (NRE150)		1.33	74	10.08 -	1NR-FE	4	1,1	ILKAR7B11	4912		
Corolla (EE100,101,105,AE101,102)		1.3		92 - 97	4E-FE	4	0,8	BKR5EYA	2087		LPG 1
Corolla (EE100,101,105,AE101,102)		1.3		93 - 97	2E	4	0,8	BPR6EY	6427		LPG 2
Corolla (EE100,101,105,AE101,102)		1.3		94 - 07	2E	4	0,8	BPR6EY	6427		LPG 2
Corolla (EE100,101,105,AE101,102)		1.3		95 - 12.99	2E o.Cat.	4	1,1	BPR5EY-11	3028		LPG 2

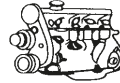
Code *l* kW

Cyl.

Stock-No.  
**VEFINE**  
E-FORUM

LPG/CNG

**TOYOTA****COROLLA**

Corolla		1.3		07.97 - 12.99	4E-FE	4	1,1	BKR5EYA-11	2526	39	LPG 1
Corolla (AE110,111,112,115)		1.3		98 - 12.99	2E	4	0,8	BPR6EY	6427		LPG 2
Corolla (AE110,111,112,115)		1.3		98 - 12.99	4E-FE	4		BKR5EKB-11	3967		
Corolla (EE110,111)		1.3		98 - 12.99	2E	4	0,8	BPR6EY	6427		LPG 2
Corolla (EE110,111)		1.3		98 - 12.99	4E-FE (16V DOHC)	4		BKR5EKB-11	3967		
Corolla (EE110,111,AE110-112,115, ZZE111,112)		1.3		01.00 - 07	2E	4	0,8	BPR6EY	6427		LPG 2
Corolla (EE110,111,AE110-112,115, ZZE111,112)		1.3		01.00 - 07	4E-FE	4		BKR5EKB-11	3967		
Corolla (NZE120,121)		1.3		10.01 - 07	2NZ-FE	4	1,1	BKR5EYA-11	2526	39	LPG 1
Corolla (ZZE120,121,122,123)		1.3		10.01 - 07	2NZ-FE	4	1,1	BKR5EYA-11	2526	39	LPG 1
Corolla (EE100,101,105,AE101,102)		1.4	65	92 - 94	4E-FE	4	0,8	BKR6EYA	2249		LPG 1
Corolla Luna D-4D		1.4	66	04 - 07	1ND-TV	4		Y-542J	5513	45	
Corolla (EE110,111,AE110-112,115, ZZE111,112)		1.4	71	01.00 - 07	4ZZ-FE	4	1,1	BKR5EYA-11	2526	39	LPG 1
Corolla (NZE120,121 ZZE120,121, 122,123)		1.4	71	01.02 - 07	4ZZ-FE	4	1,1	BKR5EYA-11	2526	39	LPG 1
Corolla EE110,111,AE110,111,112,115		1.4		01.98 - 07	4E-FE	4		BKR5EKB-11	3967		
Corolla (NZE120,121)		1.4		10.01 - 07	4ZZ-FE	4	1,1	BKR5EYA-11	2526	39	LPG 1
Corolla (ZZE120,121,122,123)		1.4		10.01 - 07	4ZZ-FE	4	1,1	BKR5EYA-11	2526	39	LPG 1
Corolla (AE110,111,112,115)		1.5		98 - 12.99	5A-FE	4	1,1	BKR5EYA-11	2526	39	LPG 1
Corolla (EE110,111)		1.5		98 - 12.99	5A-FE	4	1,1	BKR5EYA-11	2526	39	LPG 1
Corolla (EE110,111,AE110-112, 115,ZZE111,112)		1.5		01.00 - 07	5A-FE	4	1,1	BKR5EYA-11	2526	39	LPG 1
Corolla (NZE120,121)		1.5		10.01 - 07	1NZ-FE	4	1,1	BKR5EYA-11	2526	39	LPG 1
Corolla (ZZE120,121,122,123)		1.5		10.01 - 07	1NZ-FE	4	1,1	BKR5EYA-11	2526	39	LPG 1
Corolla (EE90,97,100,101,105, AE92,95,101,102)		1.6	66	87 - 12.99	4A-F	4	0,8	BCRE527Y	2074		
Corolla		1.6	81	07.97 - 07	4A-FE	4	1,1	BKR5EYA-11	2526	39	LPG 1
Corolla (EE110,111,AE110-112,115, ZZE111,112)		1.6	81	01.00 - 07	3ZZ-FE	4	1,1	BKR5EYA-11	2526	39	LPG 1
Corolla (NZE120,121)		1.6	81	10.01 - 07	3ZZ-FE	4	1,1	BKR5EYA-11	2526	39	LPG 1
Corolla (ZZE120,121,122,123)		1.6	81	10.01 - 07	3ZZ-FE	4	1,1	BKR5EYA-11	2526	39	LPG 1
Corolla (ZZE121)		1.6	81	11.01 - 07	3ZZ-FE	4	1,1	BKR5EYA-11	2526	39	LPG 1
Corolla (EE100,101,105,AE101,102)		1.6	84	92 - 94	4A-FE	4	0,8	BKR6EYA	2249		LPG 1
Corolla (EE90,97,AE92,95)		1.6	85	90 -	4A-GE Cat.	4	0,8	BKR6EP-8	2215		LPG 1
Corolla		1.6	85	93 -	4A-GE Cat.	4	0,8	BKR6EYA	2249		LPG 1
Corolla 1.6 (ZRE151)		1.6	91	11.06 - 12.08	1ZR-FE	4	1,1	ILKAR7B11	4912		
Corolla 1.6 (ZRE151)		1.6	97	01.09 -	1ZR-FAE / 1ZR-FE	4	1,1	ILKAR7B11	4912		
Corolla (EE100,101,105,AE101,102)		1.6		95 - 12.99	4A-FE	4	0,8	BKR6EYA	2249		LPG 1
Corolla (AE110,111,112,115)		1.6		98 - 12.99	4A-F	4	0,8	BCRE527Y	2074		
Corolla (AE110,111,112,115)		1.6		98 - 12.99	4A-FE	4	0,8	BKR6EYA	2249		LPG 1
Corolla (EE110,111)		1.6		98 - 12.99	4A-F	4	0,8	BCRE527Y	2074		
Corolla (EE110,111)		1.6		98 - 12.99	4A-FE	4	0,8	BKR6EYA	2249		LPG 1
Corolla (EE110,111,AE110-112,115, ZZE111,112)		1.6		01.00 - 07	4A-F	4	0,8	BCRE527Y	2074		
Corolla (EE110,111,AE110-112,115, ZZE111,112)		1.6		01.00 - 07	4A-FE	4	0,8	BKR6EYA	2249		LPG 1
Corolla Spacio (AE111)		1.6		01.00 - 07	4A-FE	4	0,8	BKR6EYA	2249		LPG 1
Corolla (NZE120,121)		1.8	99	10.01 - 07	1ZZ-FE	4	1,1	BKR5EYA-11	2526	39	LPG 1
Corolla (ZZE120,121,122,123)		1.8	99	10.01 - 07	1ZZ-FE	4	1,1	BKR5EYA-11	2526	39	LPG 1



Code *l* kW

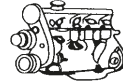

Cyl.



Stock-No.

LPG/CNG

## TOYOTA COROLLA

Corolla (NZE120,121)	1.8	141	10.01 - 07	2ZZ-GE	4	1,1	IFR6T11	4589		
Corolla (ZZE120,121,122,123)	1.8	141	10.01 - 07	2ZZ-GE	4	1,1	IFR6T11	4589		
Corolla (ZZE123) Sport	1.8	141	02 - 07	2ZZ-GE	4	1,1	IFR6T11	4589		
Corolla (ZZE123) Sport	1.8	160	10.05 - 02.07	2ZZ-GE	4	1,1	IFR6T11	4589		
Corolla	1.8		12.92 -	1C	4	<input checked="" type="checkbox"/>	Y-703R	3782		
Corolla (EE100,101,105,AE101,102)	1.8		93 - 12.99	7A-FE	4	0,8	BKR6EYA	2249		LPG 1
Corolla (AE110,111,112,115)	1.8		98 - 12.99	7A-FE	4	0,8	BKR6EYA	2249		LPG 1
Corolla (EE110,111)	1.8		98 - 12.99	7A-FE	4	0,8	BKR6EYA	2249		LPG 1
Corolla (EE110,111,AE110-112,115, ZZE111,112)	1.8		01.00 -	7A-FE	4	0,8	BKR6EYA	2249		LPG 1
Corolla 2.0 D-4D (E11,CDE110)	2.0	66	09.00 - 01.02	1CD-FTV	4	<input checked="" type="checkbox"/>	Y-531J	5467	44	
Corolla 2.0 D-4D (E12,CDE120)	2.0	66	01.02 - 05.04	1CD-FTV	4	<input checked="" type="checkbox"/>	Y-531J	5467	44	
Corolla 2.0 D-4D (E12,CDE120)	2.0	81	11.01 - 04.03	1CD-FTV	4	<input checked="" type="checkbox"/>	Y-531J	5467	44	
Corolla 2.0 D-4D (E12,CDE120)	2.0	85	05.03 - 05.08	1CD-FTV	4	<input checked="" type="checkbox"/>	Y-531J	5467	44	
Corolla 4WD	1.6	84	93 -	4A-FE	4	0,8	BCPR5EY	1266		LPG 3
Corolla 4WD	1.6		95 -	4A-FE	4	0,8	BCPR5EY	1266		LPG 3

## COROLLA VERSO

Corolla Verso (ZZE121, 122)	1.6		09.01 - 07	3ZZ-FE	4	1,1	BKR5EYA-11	2526	39	LPG 1
Corolla Verso (ZNR10)	1.6		08.05 - 07	3ZZ-FE	4	1,1	BKR5EYA-11	2526	39	LPG 1
Corolla Verso (ZNR10)	1.8	99	08.05 - 07	1ZZ-FE	4	1,1	BKR5EYA-11	2526	39	LPG 1
Corolla Verso D-4D(E12,CDE120)	2.0	66	01.02 - 05.04	1CD-FTV	4	<input checked="" type="checkbox"/>	Y-531J	5467	44	
Corolla Verso D-4D(CE120,CDE120)	2.0	85	10.01 - 07	1CD-FTV	4	<input checked="" type="checkbox"/>	Y-531J	5467	44	
Corolla Verso D-4D(ZER,CUR10)	2.0	85	04.04 - 08.05	1CD-FTV	4	<input checked="" type="checkbox"/>	Y-531J	5467	44	
Corolla Verso (ZZE121, 122)	2.0		09.01 - 07	1ZZ-FE	4	1,1	BKR5EYA-11	2526	39	LPG 1
Corolla Verso (AUR10) D-Cat	2.2	130	08.05 - 03.09	2ADFHV	4	<input checked="" type="checkbox"/>	Y1012J	92083	65	

## CORONA

Corona (AT171,177,ST171)	1.6	66	88 - 92	4A-F Cat.	4	0,8	BCRE527Y	2074		
Corona (AT171,177,ST171)	1.6	72	90 - 92	4A-FE	4	1,1	BCPR6EIX-11	4919		LPG 3
Corona (AT171,177,ST171)	1.6	75	90 - 92	4A-FE	4	0,8	BCPR5EY	1266		LPG 3
Corona (AT220,221,ST220)	1.6	81	04.98 -	4A-FE	4	1,3	BKR6EP-13	2550		
Corona (AT190,ST191)	1.6		93 -	4A-FE	4	1,1	BKR5EYA-11	2526	39	LPG 1
Corona (ST210, AT210)	1.6		01.00 -	4A-FE	4	0,8	BKR6EYA	2249		LPG 1
Corona (AZT220)	1.6		01.02 -	3ZZ-FE	4	1,1	BKR5EYA-11	2526	39	LPG 1
Corona (ST220)	1.6		01.02 -	3ZZ-FE	4	1,1	BKR5EYA-11	2526	39	LPG 1
Corona (ZZT220, 221)	1.6		01.02 -	3ZZ-FE	4	1,1	BKR5EYA-11	2526	39	LPG 1
Corona (AT220,221,ST220)	1.8	81	01.98 -	7A-FE	4	1,3	BKR6EP-13	2550		
Corona (AZT220)	1.8		01.02 -	1ZZ-FE	4	1,1	BKR5EYA-11	2526	39	LPG 1
Corona (ST220)	1.8		01.02 -	1ZZ-FE	4	1,1	BKR5EYA-11	2526	39	LPG 1
Corona (ZZT220, 221)	1.8		01.02 -	1ZZ-FE	4	1,1	BKR5EYA-11	2526	39	LPG 1
Corona (AT220,221,ST220)	2.0	94	01.98 -	3S-FE	4		BKR6EKP-11	3452		
Corona (AT190,191,ST191)	2.0	98	93 -	3S-FE	4	1,1	BKR6EYA-11	4073		LPG 1
Corona (AT171,177,ST171)	2.0	116	92 -	3S-GE	4	0,8	BKR6EP-8	2215		LPG 1
Corona	2.0		93 -	2C	4	<input checked="" type="checkbox"/>	Y-703R	3782		
Corona (ST210, AT210)	2.0		01.00 -	3S-FE	4		BKR6EKB-11	3583		
Corona (AZT220)	2.0		01.02 -	3S-FE	4		BKR6EKB-11	3583		
Corona (ST220)	2.0		01.02 -	3S-FE	4		BKR6EKB-11	3583		
Corona (ZZT220, 221)	2.0		01.02 -	3S-FE	4		BKR6EKB-11	3583		

## CROWN

Crown	2.0		93 -	1G-FE	4	0,8	BKR6EYA	2249		LPG 1
-------	-----	--	------	-------	---	-----	---------	------	--	-------

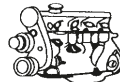
Code *l* kW

Cyl.



Stock-No.

**TOYOTA****CROWN**

Crown (GS151)		2.0	98 -	1G-FE	4	1,1	BKR5EYA-11	2526	39	LPG 1
Crown (JZS155)		2.0	98 -	1G-FE	4	1,1	BKR5EYA-11	2526	39	LPG 1
Crown		2.5	93 -	2L	4	☑	Y-715R	5376		
Crown (GS151)		2.9	98 -	2JZ-GE with 3way cat.	6		BKR5EKB-11	3967		
Crown (GS151)		2.9	98 -	2JZ-GE without 3way cat.	6	0,8	BKR6EYA	2249		LPG 1
Crown (JZS155)		2.9	98 - 12.99	2JZ-GE with 3way cat.	6		BKR5EKB-11	3967		
Crown (JZS155)		2.9	98 -	2JZ-GE without 3way cat.	6	0,8	BKR6EYA	2249		LPG 1
Crown		3.0	93 - 12.99	2JZ-GE	6	0,8	BKR6EYA	2249		LPG 1
Crown (JZS155)		3.0	01.00 -	2JZ-GE	6		BKR5EKP-11	4302		

**DYNA**

Dyna (KDY220,230,250,260)		2.5	65	08.01 - 08.06	2KD-FTV	4	☑	Y-531J	5467	44	
Dyna (KDY220,230,250,260)		2.5	75	08.01 -	2KD-FTV	4	☑	Y-531J	5467	44	
Dyna 2500				93 -	2L		☑	Y-715R	5376		
Dyna 2800		2.8		93 -	3L	4	☑	Y-715R	5376		
Dyna 3000		3.0		93 -	B / 11B	4	☑	Y-197T	2190		
Dyna 3000		3.0		93 -	B / 11B	4	☑	Y-147T	7493		
Dyna 3700				93 -	14B		☑	Y-197T	2190		
Dyna 3700				93 -	14B		☑	Y-147T	7493		

**ECHO**

Echo (SCP10,NCP10,11,12,13)		1.0		01.99 -	1SZ-FE	4	0,8	BKR5EYA	2087		LPG 1
Echo Verso (NCP20,21 ,22)		1.3	63	08.99 -	2NZ-FE	4	1,1	BKR5EYA-11	2526	39	LPG 1
Echo (NCP10,11,12,13, SCP10)		1.3		01.01 -	2NZ-FE	4	1,1	BKR5EYA-11	2526	39	LPG 1
Echo (NCP10,11,12,13, SCP10)		1.5	78	01.01 - 12.01	1NZ-FE	4	1,1	BKR5EYA-11	2526	39	LPG 1
Echo (NCP10,11,12,13, SCP10)		1.5	78	01.02 -	1NZ-FE	4	0,8	BKR5EYA	2087		LPG 1
Echo (NCP20, 21, 22)		1.5	78	01.02 -	1NZ-FE	4	0,8	BKR5EYA	2087		LPG 1
Echo NLP10		1.4	55	02 -	1ND-TV	4	☑	Y-542J	5513	45	
Echo Verso NLP20/22		1.4		02 -	1ND-TV	4	☑	Y-542J	5513	45	

**HIACE**

Hiace 3700				93 -	14B 12V		☑	Y-147T	7493		
Hiace 3700				93 -	14B 24V		☑	Y-197T	2190		
Hiace		1.8		95 -	2Y o.Cat.	4	0,8	BPR5EY	2828	9	LPG 2
Hiace (RZH102,103,104,109, 112-115,119,125)		2.0	74	90 - 98	1R-Z	4	0,8	BPR5EY	2828	9	LPG 2
Hiace (RZH102-105,112-115,125, 135,153,155)		2.0		98 -	1RZ	4	0,8	BP5EY	7327		LPG 2
Hiace (RZH102,103,104,109, 112-115,119,125)		2.4	88	90 -	2R-ZE	4	1,1	BPR5EP-11	3971		
Hiace		2.4		09.83 - 92	2L	4	☑	Y-118T1	2951		
Hiace Super Glow System		2.4		09.83 - 92	2L	4	☑	Y-118R	2187		
Hiace Super Glow System		2.4		09.83 - 92	2L	4	☑	Y-118R	2187		
Hiace (RZH102,103,104,109, 112-115,119,125)		2.4		90 -	2R-Z	4	0,8	BP5EY	7327		LPG 2
Hiace 2500 (LH102-104,112-115,125)		2.4		93 -	2L	4	☑	Y-715R	5376		
Hiace (RZH102-105,112-115,125, 135,153, 155)		2.4		98 -	2RZ	4	0,8	BP5EY	7327		LPG 2
Hiace (RZH102-105,112-115,125, 135,153,155)		2.4		98 -	2RZ-E	4	1,1	BPR5EP-11	3971		
Hiace (RCH12,13,19,22,23,29)		2.4		01.00 -	2RZ-E	4	1,1	BPR5EP-11	3971		
Hiace (KLH12,KLH18,KLH22,KLH28)		2.5	65	08.01 - 08.06	2KD-FTV	4	☑	Y-531J	5467	44	

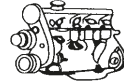

Code *l* kW

Cyl.

Stock-No.  
**V-LINE**  
BY-PRO/VER\*\*

LPG/CNG

**TOYOTA  
HIACE**

Hiace 2.5 D-4D (KLH12, KLH22)		2.5	70	09.06 -	2KD-FTV	4	☑	Y-531J	5467	44	
Hiace (KLH12, KLH18, KLH22, KLH28)		2.5	75	08.01 - 08.06	2KD-FTV	4	☑	Y-531J	5467	44	
Hiace 2.5 D-4D (KLH12, KLH22)		2.5	86	09.06 -	2KD-FTV	4	☑	Y-531J	5467	44	
Hiace (LH102-104, 112-115, 125)		2.5		98 -	2L	4	☑	Y-715R	5376		
Hiace (RCH12, 13, 19, 22, 23, 29)		2.7	105	01.00 - 03	3RZ-FE	6	0,8	IFR5T-8N	3508		
Hiace (RCH 13, 19, 23, 29)		2.7		01.04 -	3RZ-FE	4	1,1	IFR5T11	4996		
Hiace 2800		2.8		93 -	3L	4	☑	Y-715R	5376		
Hiace (LH102-104, 112-115, 125)		2.8		98 -	3L	4	☑	Y-715R	5376		
Hiace 3000		3.0		93 -	B / 11B 12V	4	☑	Y-147T	7493		
Hiace 3000		3.0		93 -	B / 11B 24V	4	☑	Y-197T	2190		

**HILUX**

Hilux				09.83 - 92	2L	4	☑	Y-118T1	2951		
Hilux Super Glow System				09.83 - 92	2L	4	☑	Y-118R	2187		
Hilux		1.8	61	88 - 94	2Y	4	0,8	BPR5EY	2828	9	LPG 2
Hilux		1.8		95 -	2Y	4	0,8	BP5EY	7327		LPG 2
Hilux (TGN10, 11, 15, 16, 26, 36)		2.0	100	07.05 -	1TR-FE	4	1,1	LFR6C-11	5788		
Hilux		2.0		88 - 94	3Y, 3Y-C	4	0,8	BPR5EY	2828	9	LPG 2
Hilux		2.0		95 -	3Y	4	0,8	BP5EY	7327		LPG 2
Hilux(RZN142, 144, 147-149, 154, 168, 169, 173, 174, 193)		2.0		01.01 -	1RZ	4	0,8	BP5EY	7327		LPG 2
Hilux(RZN142, 144, 147-149, 154, 168, 169, 173, 174, 193)		2.0		01.01 -	1RZ-E	4	0,8	BPR5EY	2828	9	LPG 2
Hilux(VZN 167, 172)		2.0		01.01 -	1RZ	4	0,8	BP5EY	7327		LPG 2
Hilux		2.2		88 - 94	4Y, 4Y-C	4	0,8	BPR5EY	2828	9	LPG 2
Hilux		2.2		95 -	4Y	4	0,8	BP5EY	7327		LPG 2
Hilux		2.4	84	88 -	22R-E Cat.	4	0,8	BPR5EY	2828	9	LPG 2
Hilux Super Glow System		2.4		09.83 - 92	2L	4	☑	Y-118R	2187		
Hilux		2.4		88 -	22R	4	0,8	BPR5EY	2828	9	LPG 2
Hilux 2500		2.4		93 -	2L	4	☑	Y-715R	5376		
Hilux (VZN 167, 172)		2.4		01.01 -	2RZ-FE	6	0,8	BKR5EYA	2087		LPG 1
Hilux(RZN142, 144, 147-149, 154, 168, 169, 173, 174, 193)		2.4		01.01 -	2RZ-FE	6	0,8	BKR5EYA	2087		LPG 1
Hilux 2.5 D-4D (KDN145, 150, 165, 170, 190)		2.5	65	08.01 - 08.05	2KD-FTV	4	☑	Y-531J	5467	44	
Hilux 2.5 D-4D (KUN15)		2.5	75	06.06 -	2KD-FTV	4	☑	Y-531J	5467	44	
Hilux 2.5 D-4D (KUN15)		2.5	88	06.06 -	2KD-FTV	4	☑	Y-531J	5467	44	
Hilux 2.5 D-4D (KUN25)		2.5	106	12.07 -	2KD-FTV	4	☑	Y-531J	5467	44	
Hilux (TNG10, 11, 15, 16, 26, 36)		2.7	118	07.05 -	2TR-FE	4	1,1	LFR6C-11	5788		
Hilux		2.7		96 -	3RZ-FE	6	0,8	BKR5EYA	2087		LPG 1
Hilux(RZN142, 144, 147-149, 154, 168, 169, 173, 174, 193)		2.7		01.01 -	3RZ-F	6	0,8	BKR5EYA	2087		LPG 1
Hilux(RZN142, 144, 147-149, 154, 168, 169, 173, 174, 193)		2.7		01.01 -	3RZ-FE	6	0,8	BKR5EYA	2087		LPG 1
Hilux 2800		2.8		93 -	3L	4	☑	Y-715R	5376		
Hilux		3.0	105	89 -	3VZ-E	6	0,8	BKR5EYA	2087		LPG 1
Hilux 3.0 D-4D (KUN26)		3.0	126	08.05 -	1KD-FTV	4	☑	Y-531J	5467	44	
Hilux		3.4		96 -	5VZ-FE	6		BKR5EKB-11	3967		
Hilux (GGN15, 25)		4.0	175	07.05 -	1GR-FE	6	1,1	LFR6C-11	5788		
Hilux (GRN215W)		4.0		08.05 -	1GR-FE	6	1,1	LFR6C-11	5788		

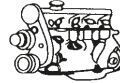
Code *l* kW

Cyl.

Stock-No.  
**V-TUNE**  
E-POWER\*

LPG/CNG

**TOYOTA****IQ**

iQ 1.0 WT-i	KGJ10	1.0	50	11.08 -	1KR-FE	3	1,1	ILFR5T11	96779		ILFR6T11
iQ 1.3	NGJ10	1.33	72	05.09 -	1NR-FE	4	1,1	ILKAR7B11	4912		
iQ 1.4 D-4D	NUJ10	1.4	66	11.08 -	1ND-TV	4		Y-542J	5513	45	

**LAND CRUISER**

Land Cruiser 2.5 D		2.5		90 -	2L 2.5L	4		Y-715R	5376		
Land Cruiser 2.5 D		2.5		93 -	2L-T	4		Y-715R	5376		
Land Cruiser 2.7	RZJ90,95, VZJ90,95	2.7		05.96 -	3RZ-F	6	0,8	BKR5EYA	2087		LPG 1
Land Cruiser 2.7	RZJ90,95, VZJ90,95	2.7		05.96 -	3RZ-FE	6	0,8	BKR5EYA	2087		LPG 1
Land Cruiser 2.7	RZJ120,125) (GRJ120,12	2.7		01.03 -	3RZ-FE with 3way cat.	4	1,1	BKR5EYA-11	2526	39	LPG 1
Land Cruiser 2.7	RZJ120,125) (GRJ120,125	2.7		01.03 -	3RZ-FE without 3way cat.	4	0,8	BKR5EYA	2087		LPG 1
Land Cruiser 2.7	TRJ120,125) (GRJ120, 125	2.7		01.05 -	2TR-FE	6	1,1	ILFR6T11	4904		
Land Cruiser 2.8 D		2.8		93 -	3L	4		Y-715R	5376		
Land Cruiser 2.8 D	KZJ90,95	2.8		98 -	3L	4		Y-715R	5376		
Land Cruiser 2.8 D	LJ90,95	2.8		98 -	3L	4		Y-715R	5376		
Land Cruiser 3.0 D	KZJ90,95	3.0	92	98 -	1KZ-T	4		Y1013J	94470	63	
Land Cruiser 3.0 D	KZJ90,95	3.0	92	98 -	1KZ-TE	4		Y1013J	94470	63	
Land Cruiser 3.0 D	LJ90,95	3.0	92	98 -	1KZ-T	4		Y1013J	94470	63	
Land Cruiser 3.0 D	LJ90,95	3.0	92	98 -	1KZ-TE	4		Y1013J	94470	63	
Land Cruiser 3.0 D-4D	KDJ90, KDJ95,J9	3.0	120	10.00 - 08.02	1KD-FTV	4		Y-531J	5467	44	
Land Cruiser 3.0 D-4D	KDJ120, KDJ125,J12	3.0	120	09.02 - 10.06	1KD-FTV	4		Y-531J	5467	44	
Land Cruiser 3.0 D-4D	KDJ125,J12	3.0	122	08.04 - 10.06	1KD-FTV	4		Y-531J	5467	44	
Land Cruiser 3.0 D-4D	KDJ120, KDJ125,J12	3.0	127	01.07 -	1KD-FTV	4		Y-531J	5467	44	
Land Cruiser 3.0 D-4D	KDJ 150,J15	3.0	127	01.10 -	1KD-FTV	4		Y-531J	5467	44	
Land Cruiser 3.0 D-4D	KDJ 150, KDJ155,J15	3.0	140	01.10 -	1KD-FTV	4		Y-531J	5467	44	
Land Cruiser 3.0 D-4D	KZJ120	3.0		09.02 -	1KD-FTV	4		Y-531J	5467	44	
Land Cruiser 3.0 D-4D	LJ120,125	3.0		09.02 -	1KD-FTV	4		Y-531J	5467	44	
Land Cruiser 3.4 D	RZJ90,95, VZJ90,95	3.4	131	05.96 -	5VZ-FE	6		BKR5EKB-11	3967		
Land Cruiser 4.0	FJ62,70,73, 75,RJ70	4.0	107	88 -	3F	6	0,8	BPR4EY	2128		LPG 2
Land Cruiser 4.0	FJ62,70,73, 75,RJ70	4.0	115	01.90 - 08.92	3F-E Cat.	6	1,1	BPR5EY-11	3028		LPG 2
Land Cruiser 4.0	RZJ120,125, GRJ120,125	4.0	183	02 -	1GR-FE	6	1,1	LFR6C-11	5788		
Land Cruiser 4.0	20W/121W	4.0		08.05 -	1GR-FE	6	1,1	LFR6C-11	5788		
Land Cruiser 4.0	TRJ120, 125, GRJ120, 125	4.0		01.05 -	1GR-FE	6	1,1	LFR6C-11	5788		
Land Cruiser 4.0	J15	4.0	183	01.10 -	1GR-FE	6	1,1	ILFR6T11	4904		
Land Cruiser 150 4.0 V6 Dual VTI	J15	4.0	205	01.10 -	1GR-FE	6	1,1	ILFR6T11	4904		
Land Cruiser 150 4.0 V6 Dual VTI	J15	4.0	207	01.10 -	1GR-FE	6	1,1	ILFR6T11	4904		
Land Cruiser 4.2 D	HDJ100	4.2		98 -	1HD-T	6		Y-532J	7782		
Land Cruiser 4.2 D	HZJ105	4.2		98 -	1HD-T	6		Y-532J	7782		

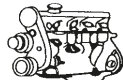
Code *l* kW

Cyl.



Stock-No.



LPG/CNG

**TOYOTA  
LAND CRUISER**

Land Cruiser 4.5		4.5		93 -	1FZ-FE	6	0,8	BKR5EYA	2087		LPG 1
Land Cruiser 4.5	FZJ80	4.5		96 -	1FZ-F	6	0,8	BKR5EYA	2087		LPG 1
Land Cruiser 4.5	FZJ100,105	4.5		98 - 12.99	1FZ-FE	6		BKR5EKB-11	3967		
Land Cruiser 4.5	FZJ70,73,75	4.5		98 - 12.99	1FZ-F	6	0,8	BKR5EYA	2087		LPG 1
Land Cruiser 4.5	FZJ70,73,75	4.5		98 - 12.99	1FZ-FE	6	0,8	BKR5EYA	2087		LPG 1
Land Cruiser 4.5	UZJ100	4.5		98 - 12.99	1FZ-FE	6		BKR5EKB-11	3967		
Land Cruiser 4.5	FZJ71,74, 78,79	4.5		01.00 -	1FZ-FE	6		BKR5EKB-11	3967		
Land Cruiser 4.5	UZJ100, FZJ100,105	4.5		01.01 -	1FZ-FE	6		BKR5EKB-11	3967		
Land Cruiser 4.5	FZJ100,105	4.5		01.02 -	1FZ-FE	6		BKR5EKB-11	3967		
Land Cruiser 4.5	UZJ100	4.5		01.02 -	1FZ-FE	6		BKR5EKB-11	3967		
Land Cruiser 4.6	URJ202W	4.6		09 -	1UR-FE	8	1,1	LF6AIX-11	6619		
Land Cruiser 4.7 V8	FZJ100,105	4.7	173	01.98 -	2UZ-FE	8	1,1	IFR6T11	4589		
Land Cruiser 4.7 V8	UZJ100	4.7	173	01.98 -	2UZ-FE	8	1,1	IFR6T11	4589		
Land Cruiser 4.7 V8	UZJ100, FZJ100,105	4.7		01.01 -	2UZ-FE with 3way cat.	8	1,1	IFR6T11	4589		
Land Cruiser 4.7 V8	UZJ200	4.7	212	08.07 -	2UZ-FE	8	1,1	IFR6T11	4589		

**LITEACE**

Liteace 1.5	KR41,42	1.5		98 -	5K	4	0,8	BPR5EY	2828	9	LPG 2
Liteace 1.5	SR40	1.5		98 -	5K	4	0,8	BPR5EY	2828	9	LPG 2
Liteace 1.8	KM30,36,37	1.8		89 -	2Y-C	4	0,8	BP5EY	7327		LPG 2
Liteace 1.8	KM30,36,37, YM30,35	1.8		90 -	2Y Cat.	4	0,8	BP5EY	7327		LPG 2
Liteace 1.8	KM30,36,37, YM30,35	1.8		90 -	2Y-C Cat.	4	1,1	BPR5EP-11	3971		
Liteace 1.8	KM30,36,37, YM30,35	1.8		90 -	2Y-CU Cat.	4	0,8	BP5EY	7327		LPG 2
Liteace 1.8	KR41,42	1.8		98 -	7K	4	0,8	BPR5EY	2828	9	LPG 2
Liteace 1.8	SR40	1.8		98 -	7K	4	0,8	BPR5EY	2828	9	LPG 2
Liteace 1.8	KR42,SR40	1.8		01.00 -	7K-E	4	1,1	BPR5EY-11	3028		LPG 2
Liteace 2.0	KM30,36,37	2.0		93 -	3Y	4	0,8	BP5EY	7327		LPG 2
Liteace 2.0	KR41,42	2.0		98 -	3S-FE	4		BKR6EKB-11	3583		
Liteace 2.0	SR40	2.0		98 -	3S-FE	4		BKR6EKB-11	3583		
Liteace 2.2		2.2		93 -	4Y-E	4	1,1	BPR5EP-11	3971		

**MR 2**

MR 2 1.8	ZZW30	1.8	103	12.99 -	1ZZ-FE	4	1,1	BKR5EYA-11	2526	39	LPG 1
MR 2 2.0	SW20	2.0	115	90 - 93	3S-GE Cat.	4	0,8	BKR6EP-8	2215		LPG 1
MR 2 2.0	SW20	2.0	118	89 - 92	3S-GE	4	0,8	BKR6EYA	2249		LPG 1
MR 2 2.0	SW20	2.0	129	94 -	3S-GE	4	0,8	BKR6EP-8	2215		LPG 1
MR 2 2.0	SW20	2.0		93 -	3S-GTE	4	0,8	BKR6EP-8	2215		LPG 1
MR 2 2.2	SW20	2.2	89	90 -	3S-FE Cat.	4	1,1	BKR6EYA-11	4073		LPG 1
MR 2 2.2		2.2		93 -	5S-FE	4	1,1	BKR6EP-11	2978		LPG 1

**PASEO**

Paseo 1.5	EL54	1.5	66	07.95 - 12.97	5E-FE (only Europe)	4	0,8	BKR5EYA	2087		LPG 1
Paseo 1.5	EL54	1.5		01.98 - 07.99	5E-FE (only Europe)	4	1,1	BKR5EP-11	3440		LPG 1

**PICNIC**

Picnic 2.0	SXM10	2.0	94	09.96 - 09.01	3S-FE	4		BKR6EKP-11	3452		
------------	-------	-----	----	---------------	-------	---	--	------------	------	--	--

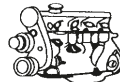
Code *l* kW

Cyl.



Stock-No.

**TOYOTA****PICNIC**

Picnic 2.0	ACM20	2.0	110	05.01 -	1AZ-FE	4	1,1	IFR6T11	4589		
Picnic 2.2 TD	CXM10	2.2	66	98 -	3C-TE	4		Y1013J	94470	63	

**PREVIA**

Previa 2.0 D-4D	ACR3,CLR30	2.0	85	03.01 - 12.05	1CD-FTV	4		Y-531J	5467	44	
Previa 2.4	TCR10,11, 20,21	2.4	97	05.90 - 00	2TZ-FE Cat.	4	1,1	BKR5EP-11	3440		LPG 1
Previa 2.4	TCR10,11, 20,21	2.4	97	05.90 -	2TZ-FE 3 way Cat.	4	0,8	BKR5EYA	2087		LPG 1
Previa 2.4	ACR30,50	2.4	115	03.00 -	2AZ-FE	4	1,1	IFR6T11	4589		
Previa 2.4	TCR10,11, 20,21	2.4		96 -	2TZ-FE without Cat.	4	0,8	BKR5EYA	2087		LPG 1

**PRIUS**

Prius 1.5 Hybrid	NHW11	1.5	53	05.00 - 03	1NZ-FXE	4	1,1	IFR5T11	4996		
Prius 1.5 Hybrid	NHW20	1.5	57	03 - 09	1NZ-FXE	4	1,1	IFR5T11	4996		
Prius 1.8 Hybrid	ZVW30	1.8	72	04.09 -	2ZR-FXE	4	1,1	ILKAR7B11	4912		

**PRIUS PLUS**

Prius Plus 1.8 Hybrid	ZVW40	1.8	73	03.12 -	2ZR-FXE	4	1,1	ILKAR7B11	4912		
-----------------------	-------	-----	----	---------	---------	---	-----	-----------	------	--	--

**RAV 4**

RAV 4 1.8	ZCA25,26	1.8	92	05.00 -	1ZZ-FE	4	1,1	BKR5EYA-11	2526	39	LPG 1
RAV 4 2.0 D		2.0	85	06.01 - 10.05	1CD-FTV	4		Y-531J	5467	44	
RAV 4 2.0	SXA10,11	2.0	95	06.94 - 09.97	3S-FE	4	1,1	BKR6EKB-11	3583		
RAV 4 2.0	SXA10,11	2.0	95	10.97 - 06.00	3S-FE	4		BKR6EKP-11	3452		
RAV 4 2.0	ZSA30,35	2.0	116	12.08 -	3ZRFAE	4	1,1	ILKAR7B11	4912		
RAV 4 2.0	ZCA25,26	2.0		05.00 -	1AZ-FE	4	1,1	IFR6T11	4589		
RAV 4 2.0	ACA30, 33,38	2.0		11.05 - 01.07	1AZ-FE	4	1,1	IFR6T11	4589		
RAV 4 2.0	ACA30,31, 33,38	2.0		01.07 -	1AZ-FE	4	1,1	IFR6T11	4589		
RAV 4 2.4	ZCA25,26	2.4		01.04 -	2AZ-FE	4	1,1	IFR6T11	4589		
RAV 4 2.4	ACA31, 33,38	2.4	125	11.05 -	2AZ-FE	4	1,1	IFR6T11	4589		
RAV 4 2.4	ACA31W, 36W	2.4		11.05 -	2AZ-FE	4	1,1	IFR6T11	4589		
RAV 4 2.4	ACA30,31, 33,38	2.4		01.07 -	2AZ-FE	4	1,1	IFR6T11	4589		

**STARLET**

Starlet 1.0		1.0	40	85 - 92	1E	4	0,8	BPR6EY	6427		LPG 2
Starlet 1.3	EP80,81	1.3	53	88 - 92	2E	4	1,1	BPR5EY-11	3028		LPG 2
Starlet 1.3	EP80,81	1.3	53	93 -	2E	4	0,8	BPR6EY	6427		LPG 2
Starlet 1.3	EP70,71,76	1.3	55	88 -	2E-C	4	1,1	BPR6EY-11	4228	10	LPG 2
Starlet 1.3	EP80,81	1.3	55	90 - 12.95	2E-E Cat.	4	0,8	BPR5EY	2828	9	LPG 2
Starlet 1.3		1.3	55	93 -	4A-FE	4	1,1	BKR5EYA-11	2526	39	LPG 1
Starlet 1.3	EP80,81	1.3	55	02.96 - 03.97	4E-FE	4	0,8	BKR5EYA	2087		LPG 1
Starlet 1.3	EP90,91	1.3	55	98 - 99	4E-FE	4	0,8	BKR5EYA	2087		LPG 1
Starlet 1.3		1.3		95 -	2E-E	4	0,8	BPR4EY	2128		LPG 2
Starlet 1.3	EP90,91	1.3		98 -	2E	4	0,8	BPR6EY	6427		LPG 2
Starlet 1.5		1.5		90 - 92	1N	4		Y-715R	5376		
Starlet 1.5		1.5		93 -	1N	4		Y-715R	5376		

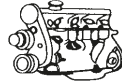
Code *l* kW

Cyl.



Stock-No.

LPG/CNG

## TOYOTA SUPRA

Supra	JZA80	3.0	165	93 - 94	2JZ-GE	6	1,1	BKR5EP-11	3440		LPG 1
Supra Turbo	MA70	3.0	175	87 - 92	7M-GTE	6	0,8	BCPR6EPN-8	5275		LPG 3
Supra V6 Biturbo	JZA80	3.0	243	93 - 94	2JZ-GTE	6	1,1	BKR6EP-11	2978		LPG 1
Supra	MA70	3.0		90 - 92	7M-GE	6	0,9	BCPR6EY	1146		LPG 3
Supra	JZA80	3.0		95 - 95	2JZ-GE	6	1,1	BKR6EP-11	2978		LPG 1
Supra	JZA80	3.0		95 -	2JZ-GTE	6	1,1	BKR6EP-11	2978		LPG 1
Supra	JZA80	3.0		96 -	2JZ-GE	6	0,8	BKR6EYA	2249		LPG 1

## TARAGO

Tarago		2.4	97	90 -	2TZ-FE	4	1,1	BKR5EP-11	3440		LPG 1
Tarago	ACR30	2.4		03.00 -	2AZ-FE	4	1,1	IFR6T11	4589		

## TERCEL

Tercel 1.3	EL50,53	1.3		98 -	2E	4	0,8	BPR6EY	6427		LPG 2
Tercel 1.5	AL25	1.5	50	88 -	3A-C Cat.	4	1,1	BPR5EY-11	3028		LPG 2
Tercel 1.5		1.5		93 -	3E-E	4	1,1	BPR5EY-11	3028		LPG 2
Tercel 1.5	EL50,53	1.5		98 -	5E-FE	4		BKR5EKB-11	3967		

## TOWNACE

Townace 1.5	KR41,42	1.5		98 -	5K	4	0,8	BPR5EY	2828	9	LPG 2
Townace 1.5	SR40	1.5		98 -	5K	4	0,8	BPR5EY	2828	9	LPG 2
Townace 1.8	KR41,42	1.8		98 -	7K	4	0,8	BPR5EY	2828	9	LPG 2
Townace 1.8	SR40	1.8		98 -	7K	4	0,8	BPR5EY	2828	9	LPG 2
Townace 1.8	KR42,SR40	1.8		01.00 -	7K-E	4	1,1	BPR5EY-11	3028		LPG 2
Townace 2.0	KR41,42	2.0		98 -	3S-FE	4		BKR6EKB-11	3583		
Townace 2.0	SR40	2.0		98 -	3S-FE	4		BKR6EKB-11	3583		

## URBAN CRUISER

Urban Cruiser 1.3	NSP110	1.33	73	04.10 -	1NR-FE	4	1,1	ILKAR7B11	4912		
Urban Cruiser 1.3	NSP110	1.33	74	01.09 -	1NR-FE	4	1,1	ILKAR7B11	4912		
Urban Cruiser 1.4 D-4D	NSP110	1.4	66	01.09 -	1ND-TV	4	<input checked="" type="checkbox"/>	Y-542J	5513	45	

## VERSO

Verso 1.6	ZGR20	1.6	81	04.09 -	1ZRFAE	4	1,1	ILKAR7B11	4912		
Verso 1.6	ZGR20	1.6	97	04.09 -	1ZRFAE	4	1,1	ILKAR7B11	4912		
Verso 1.8	ZGR21	1.8	95	04.09 -	2ZRFAE	4	1,1	ILKAR7B11	4912		
Verso 1.8	ZGR21	1.8	108	04.09 -	2ZRFAE	4	1,1	ILKAR7B11	4912		

## VERSO S

Verso S 1.33 WTi	NSP120	1.33	73	11.10 -	1NR-FE	4	1,1	ILKAR7B11	4912		
------------------	--------	------	----	---------	--------	---	-----	-----------	------	--	--

## YARIS

Yaris 1.0 16V	NCP10,11,12,13	1.0	48	01.99 -	1SZ-FE	4	0,8	BKR5EYA	2087		LPG 1
Yaris 1.0 16V Japan production	SCP10	1.0	48	01.99 -	1SZ-FE	4	0,8	BKR5EYA	2087		LPG 1
Yaris 1.0 16V France production	SCP10	1.0	48	01.01 -	1SZ-FE	4	1,1	BKR6EYA-11	4073		LPG 1
Yaris 1.0 WTi	KSP90	1.0	51	08.05 -	1KR-FE	3	1,1	LFR6C-11	5788		
Yaris 1.0 WTi	NCP90,91	1.0	51	08.05 -	1KR-FE	3	1,1	LFR6C-11	5788		
Yaris 1.0	SCP90,	1.0		11.05 -	1KR-FE	3	1,1	LFR6C-11	5788		
	NCP90,91										
Yaris 1.0 WTi	KSP130	1.0	51	09.11 -	1KR-FE	3	1,1	ILFR5T11	96779		ILFR6T11
Yaris 1.3 16V(NCP10,11,12,13)(SCP10		1.3	63	01.01 -	2NZ-FE	4	1,1	BKR5EYA-11	2526	39	LPG 1
Yaris 1.3 (NCP10,11,12,13)(SCP10,12)		1.3	64	04.02 -	2SZ-FE	4	0,8	BKR5EYA	2087		LPG 1
Yaris 1.3 WTi	KSP90,	1.3	64	08.05 - 11.06	2NZ-FE	4	1,1	BKR5EYA-11	2526	39	LPG 1
	ZSP90										



Code *l* kW

Cyl.

Stock-No.  
**VEFINE**  
E-POWER

LPG/CNG

**TOYOTA****YARIS**

Yaris 1.3 VVTi	NCP90,91	1.3	64	08.05 - 11.06	2NZ-FE	4	1,1	BKR5EYA-11	2526	39	LPG 1
Yaris 1.3	KSP90, SCP90	1.3		11.05 -	2SZ-FE	4	0,8	BKR5EYA	2087		LPG 1
Yaris 1.3	NCP92,93	1.3		01.06 -	2NZ-FE	4	1,1	BKR5EYA-11	2526	39	LPG 1
Yaris 1.3 VVTi	KSP130	1.33	73	09.11 -	1NR-FE	4	1,1	ILKAR7B11	4912		
Yaris 1.4 D-4D	NLP10	1.4	55	12.01 -	1ND-TV	4		Y-542J	5513	45	
Yaris 1.4	NLP90	1.4	55	11.05 -	1ND-TV	4		Y-542J	5513	45	
Yaris 1.4 D-4D		1.4	66	02.06 -	1ND-TV	4		Y-542J	5513	45	
Yaris 1.5	NCP10,11, 12,SCP10	1.5	78	01.01 - 12.01	1NZ-FE	4	1,1	BKR5EYA-11	2526	39	LPG 1
Yaris 1.5	NCP20, 21,22	1.5	78	01.02 -	1NZ-FE	4	0,8	BKR5EYA	2087		LPG 1
Yaris 1.5TS (NCP10,11,12,13)(SCP10)		1.5	78	01.02 -	1NZ-FE	4	0,8	BKR5EYA	2087		LPG 1
Yaris 1.5	KSP90, ZSP90	1.5	78	08.05 - 11.06	1NZ-FE	4	0,8	BKR5EYA	2087		LPG 1
Yaris 1.5	NCP90,91	1.5	78	02.06 - 11.06	1NZ-FE	4	0,8	BKR5EYA	2087		LPG 1
Yaris 1.5	NCP92,93	1.5		01.06 -	1NZ-FE	4	0,8	BKR5EYA	2087		LPG 1
Yaris TS	ZSP90	1.8	97	11.06 -	2ZR-FE	4	1,1	ILKAR7B11	4912		

**YARIS VERSO**

Yaris Verso 1.3	NCP20, 21,22	1.3	63	08.99 -	2NZ-FE	4	1,1	BKR5EYA-11	2526	39	LPG 1
Yaris Verso 1.5	NCP20, 21,22	1.5	78	01 - 12.00	1NZ-FE	4	1,1	BKR5EYA-11	2526	39	LPG 1

**TVR**

280 i		2.8				6	0,8	BPR6ES	7822	2	LPG 2
280 s		2.8				6	0,8	BPR6ES	7822	2	LPG 2
290 i		2.9				6	0,8	BPR6ES	7822	2	LPG 2
350 i		3.5				8	0,8	BPR6ES	7822	2	LPG 2
400		4.0				8	0,8	B7ECS	2528		
450		4.5				8	0,8	B7ECS	2528		
Cerbera		4.0		09.98 -	IL6 4.0L	6	0,9	DCPR8E	4339		LPG 8
Cerbera		4.2	306	95 -	AJP (TVR engine)	8		BKR5EYU	3964		
Chimaera		4.0			V8 Rover	8	0,8	B7ECS	2528		
Chimaera		4.3			V8 Rover	8	0,8	B7ECS	2528		
Chimaera		5.0			V8 Rover	8	0,8	B7ECS	2528		
Griffith		3.9				8	0,8	B7ECS	2528		
Griffith		4.3				8	0,8	B7ECS	2528		
Griffith		4.5				8	0,8	B7ECS	2528		
Griffith 500		5.0		95 -	V8 Rover	8	0,8	B7ECS	2528		
S2						6	0,8	BCPR6ES	2330	12	LPG 3
S3					non Cat.	6	0,8	BCPR6ES	2330	12	LPG 3
S3					With Cat.	6	1,0	BPR6EFS	3623	7	LPG 5
S3C		2.9				6	1,0	BPR6EFS	3623	7	LPG 5
Speed		3.9			39	8	0,8	B7ECS	2528		
Speed		4.3			43	8	0,8	B7ECS	2528		
Tamora		3.6			IL6	6	0,9	DCPR8E	4339		LPG 8
Tasmin		2.0				4	0,6	APR6FS	2922		
Tasmin		2.8				6	0,8	BCPR6ES	2330	12	LPG 3

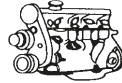
Code *l* kW

Cyl.



Stock-No.



LPG/CNG

**TVR**

Tuscan		3.5				8	0,9	BPR5ES	7422	6	LPG 2
Tuscan Speed Six		4.0	09.98 -			6	0,9	DCPR8E	4339		LPG 8

**VOLVO****240**

240 2.0		2.0	77	08.88 - 08.92		4	0,8	BPR6ES	7822	2	LPG 2
240 2.0		2.0	86	08.87 - 07.92	B200E	4	0,8	BPR6ES	7822	2	LPG 2
240 2.3		2.3	85	08.84 - 08.93	B230F Cat.	4	0,8	BPR6ES	7822	2	LPG 2
240 2.3		2.3	96	08.87 - 07.92	B230E	4	0,8	BPR6ES	7822	2	LPG 2
240 2.3		2.3		08.92 -	B230FD	4	0,8	BPR6ES	7822	2	LPG 2

**440**

440 1.6	445	1.6	62	02.92 - 12.95	B16F Cat.	4	0,7	ZGR5B	7345		
440 1.7	445	1.7	58	09.88 - 12.96	B18K/B Cat.	4	0,8	BPR6ES	7822	2	LPG 2
440 1.7	445	1.7	64	09.88 - 02.92	B18KPD Cat.	4	0,7	ZGR5B	7345		
440 1.7	445	1.7	70	09.88 - 03.92	B18F Cat.	4	0,7	ZGR5B	7345		
440 1.7	445	1.7	75	09.89 - 12.96	B18FP Cat.	4	0,7	ZGR5B	7345		
440 1.7	445	1.7	88	09.88 - 07.96	B18FTM/FT Cat.	4	0,8	BPR7ES	2023	19	BPR8EIX
440 1.8	445	1.8	66	09.91 - 07.96	B18U Cat.	4	0,7	ZGR5B	7345		
440 1.8	445	1.8	69	09.91 - 12.95	B18 u. Cat.	4	0,8	BPR6ES	7822	2	LPG 2
440 1.9 TD	445	1.9	66	01.93 - 12.96	Renault F8Q Turbo	4	☑	Y-933J	7947	25	
440 2.0	445	2.0	81	08.92 - 07.95	B20F Cat.	4	0,8	BPR7ES	2023	19	BPR8EIX
440 2.0	445	2.0	81	09.92 -	B20U Cat.	4	0,8	BPR7ES	2023	19	BPR8EIX

**460**

460 1.7	464	1.7	66	03.90 - 12.95	B18KP/EP/ Cat	4	0,8	BPR6ES	7822	2	LPG 2
460 1.7	464	1.7	75	01.90 - 09.92	B18FP Cat.	4	0,7	ZGR5B	7345		
460 1.7	464	1.7	88	01.90 - 12.95	B18FT Cat.	4	0,8	BPR7ES	2023	19	BPR8EIX
460 1.8	464	1.8	66	09.91 - 12.95	B18U Cat.	4	0,7	ZGR5B	7345		
460 1.8	464	1.8	69	09.91 - 12.95	B18 u. Cat.	4	0,8	BPR6ES	7822	2	LPG 2
460 1.9 TD	464	1.9	66	06.94 - 08.97	D 19 T	4	☑	Y-933J	7947	25	
460 2.0	464	2.0	81	09.92 - 12.95	B20F Cat.	4	0,8	BPR7ES	2023	19	BPR8EIX

**480**

480i 1.7		1.7	75	10.89 - 09.92	B18FP Cat.	4	0,7	ZGR5B	7345		
480i 1.7		1.7	88	03.88 - 07.96	B18FT Cat.	4	0,8	BPR7ES	2023	19	BPR8EIX
480i 2.0		2.0	81	09.92 - 12.95	B20F Cat.	4	0,8	BPR7ES	2023	19	BPR8EIX

**740**

740i 2.0Turbo	744/745	2.0	105	08.86 - 07.92	B200ET/FT Cat.	4	0,8	BPR6ES	7822	2	LPG 2
740i 2.3	744/745	2.3	85	08.87 - 07.95	B230F Cat.	4	0,8	BPR6ES	7822	2	LPG 2
740i 2.3	744/745	2.3	96	08.84 - 07.92	B230E/B230F Cat.	4	0,8	BPR6ES	7822	2	LPG 2
740i 2.3 16V	744/745	2.3	111	04.88 - 08.92	B234F Cat.	4	0,8	BPR6ES	7822	2	LPG 2
740 2.4 D	744/745	2.4	60	04.84 - 07.92	D 24	6	☑	Y-918J	6285	2	
740 2.4 TD	744/745	2.4	80	04.87 - 07.92	D 24 T	6	☑	Y-918J	6285	2	
740 2.4 TD (air condition)	744/745	2.4	85	08.87 - 07.92	D 24 TIC	6	☑	Y-918J	6285	2	

**760**

760i 2.3 Turbo	764/765	2.3	114	08.84 - 07.92	B230ET/FT Cat.	4	0,8	BPR6ES	7822	2	LPG 2
760 2.4 TD	764/765	2.4	85	08.87 - 07.92	D 24 TIC	6	☑	Y-918J	6285	2	

**780**

780 2.4 TD		2.4	85	08.85 -	D 24 TIC	6	☑	Y-918J	6285	2	
------------	--	-----	----	---------	----------	---	---	--------	------	---	--

**850**

850 2.0	LS/LW	2.0	93	08.94 - 12.96	B520S	5		BKR6ETUC	3384		LPG 1
850 2.0	LS/LW	2.0	105	09.91 - 12.96	B5204F/B5204S	5		BKR6ETUC	3384		LPG 1
850 2.0T	LS/LW	2.0	154	02.93 - 12.96	B5204T	5	0,8	BCPR6ES	2330	12	LPG 3

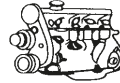
Code *l* kW

Cyl.



Stock-No.

V-TIME  
E-FORWARD  
LPG/CNG**VOLVO****850**

850 2.3 T5 R	LS/LW	2.3	177	94 -	B5234T5	5	0,8	BKR7EIX	2667		BKR8EIX
850 2.3 T5 R	LS/LW	2.3	184	08.95 - 12.96	B5234T	5	0,8	BKR7EIX	2667		BKR8EIX
850 2.5	LS/LW	2.5	103	06.91 - 07.94	B5252	5		BKR6ETUC	3384		LPG 1
850 2.5	LS/LW	2.5	106	08.94 - 12.96	B5252S	5		BKR6ETUC	3384		LPG 1
850 2.5	LS/LW	2.5	125	09.91 - 12.96	B5254F	5		BKR6ETUC	3384		LPG 1
850 2.5 AWD	LS/LW	2.5	142	04.96 - 12.96	B5254T	5		PFR6B	3500		LPG 1

**940**

940i 2.0	944/945	2.0	82	09.90 - 07.94	B200E/B200F	4	0,8	BPR6ES	7822	2	LPG 2
940i 2.0 Turbo	944/945	2.0	105	01.91 - 07.94	B200FT	4	0,8	BPR6ES	7822	2	LPG 2
940i 2.3	944/945	2.3	96	09.90 - 12.94	B230F	4	0,8	BPR6ES	7822	2	LPG 2
940i 2.3	944/945	2.3	96	08.90 - 12.94	B230FB	4	0,8	BPR6ES	7822	2	LPG 2
940i 2.3	944/945	2.3	99	12.94 -	B230GK	4	0,8	BPR6ES	7822	2	LPG 2
940i 2.3 Turbo Intercooler	944/945	2.3	121	08.90 - 07.94	B230FT	4	0,8	BPR6ES	7822	2	LPG 2
940i 2.3	944/945	2.3	126	08.94 - 10.98	B230FT / FK	4	0,8	BPR6ES	7822	2	LPG 2
940 2.4 TD	944/945	2.4	80	09.90 - 08.93	D 24 T	6	▣	Y-918J	6285	2	
940 2.4 TD	944/945	2.4	85	09.90 -	D 24 TIC	6	▣	Y-918J	6285	2	
940 2.4 TD Intercooler	945	2.4	90	01.94 -	D 24 T	6	▣	Y-918J	6285	2	

**960**

960i 2.0 16V Turbo Intercooler	964/965	2.0	140	09.90 -	B204FT	4	0,8	BPR6ES	7822	2	LPG 2
960i 2.3 Turbo Intercooler	964/965	2.3	121	09.90 -	B230FT / FK	4	0,8	BPR6ES	7822	2	LPG 2
960 2.4 TD Intercooler	964/965	2.4	85	09.91 -	D 24 TIC	6	▣	Y-918J	6285	2	
960 2.5	964/965	2.5	125	09.94 - 12.96	B6254F/G/S	6	0,8	BCPR6ES	2330	12	LPG 3
960i 2.8	964/965	2.8	125	09.90 -	B280E	6	0,6	BP7EFS	3526		
960 2.9	964/965	2.9	150	09.90 - 07.94	B6304F	6	0,8	BCPR6ES	2330	12	LPG 3
960 2.9	964/965	2.9	150	07.94 - 12.96	B6304S	6		BKR6ETUC	3384		LPG 1
960 3.0	964/965	3.0	135	09.94 -	B6304F	6	0,8	BCPR6ES	2330	12	LPG 3
960 3.0	964/965	3.0	150	09.94 -	B6304F/G	6	0,8	BCPR6ES	2330	12	LPG 3

**C 30**

C 30 1.6		1.6	74	11.06 -	B4164S3	4	1,3	TR5B-13	4559		LPG 4
C 30 1.6 D		1.6	80	11.06 -	D4164T	4	▣	YE04	1684	40	
C 30 1.8		1.8	92	11.06 -	B4184S11	4	1,3	TR6AP-13	5809		LPG 5
C 30 1.8 Flexfuel		1.8	92	01.07 -	B4184S8	4	1,3	TR6AP-13	5809		LPG 5
C 30 2.0 D		2.0	100	11.06 -	D4204T	4	▣	Y1005J	7957	56	
C 30 2.0		2.0	107	11.06 -	B4204S3	4	1,3	TR6AP-13	5809		LPG 5
C 30 2.0 Flexfuel		2.0	107	01.10 -	B4204S4	4	1,3	TR6AP-13	5809		LPG 5
C 30 D 5 to chassis no. 62745		2.4	120	11.06 - 07.10	D5244T9	5	▣	Y8008AS	91440	74	
C 30 2.4		2.4	125	11.06 -	B5244S4	5		LFR6D	4704		
C 30 D 5 to chassis no. 62745		2.4	132	11.06 - 07.10	D5244T8 / T13	5	▣	Y8008AS	91440	74	
C 30 T 5		2.5	162	10.06 -	B5254T3	5	0,8	ILFR6B	6481		
C 30 T 5		2.5	169	03.07 -	B5254T7	5	0,8	ILFR6B	6481		

**C 70 1**

C 70 2.0 T		2.0	120	03.00 - 10.05	B5204T4	5	0,8	PFR6B	3500		LPG 1
C 70 2.0		2.0	132	03.97 - 10.05	B5204T2	5	0,8	BCPR7ES	3330		BCPR7EIX
C 70 2.0 T		2.0	166	01.97 - 10.05	B5204T3	5	0,8	BCPR7ES	3330		BCPR7EIX
C 70 2.3 T5		2.3	176	03.97 - 10.05	B5234T3	5	0,8	PFR6B	3500		LPG 1
C 70 2.3 T5		2.3	180	07.02 - 10.05	B5234T9	5	0,8	PFR6B	3500		LPG 1
C 70 2.4 T		2.4	142	08.99 - 10.05	B5244T	5	0,8	PFR6B	3500		LPG 1
C 70 2.4 T		2.4	147	07.02 - 10.05	B5244T7	5	0,8	PFR6B	3500		LPG 1

Code *l* kW

Cyl.



Stock-No.



LPG/CNG

**VOLVO****C 70 1**

C 70 2.5		2.5	121	03.99 - 09.02	B5254S	5		BKR6ETUC	3384		LPG 1
C 70 2.5		2.5	125	11.99 - 10.05	B5244S	5		BKR6ETUC	3384		LPG 1
C 70 2.5 T		2.5	142	03.97 - 10.05	B5254T	5	0,8	PFR6B	3500		LPG 1

**C 70 2**

C 70 2.0 D		2.0	100	03.07 -	D4204T	4	<input checked="" type="checkbox"/>	Y1005J	7957	56	
C 70 2.4		2.4	103	03.06 -	B5244S5	5		LFR6D	4704		LFR6D
C 70 2.4		2.4	125	03.06 -	B5244S4	5		LFR6D	4704		LFR6D
C 70 D5 to chassis no. 49640		2.4	132	03.06 -	D5244T8 / T13	5	<input checked="" type="checkbox"/>	Y8008AS	91440	74	
C 70 T5		2.5	162	03.06 -	B5254T3	5	0,8	ILFR6B	6481		ILFR6B
C 70 T5		2.5	169	11.05 -	B5254T7	5	0,8	ILFR6B	6481		ILFR6B

**S 40 1**

S 40 1.6		1.6	77	09.95 - 08.99	B4164S	4		BKR6ETUC	3384		LPG 1
S 40 1.6		1.6	80	03.99 - 12.03	B4164S2	4		BKR6ETUC	3384		LPG 1
S 40 1.8		1.8	85	07.95 - 08.99	B4184S	4		BKR6ETUC	3384		LPG 1
S 40 1.8 Bi-Fuel		1.8	90	03.99 - 12.03	B4184S9	4		BKR6ETUC	3384		LPG 1
S 40 1.8		1.8	90	03.99 - 12.03	B4184S2	4		BKR6ETUC	3384		LPG 1
S 40 1.8 GDI		1.8	92	06.01 - 12.03	B4184SJ	4	0,6	IZFR6B	3116		
S 40 1.9D		1.9	66	07.95 - 08.99	D4192T	4	<input checked="" type="checkbox"/>	Y-933J	7947	25	
S 40 1.9D		1.9	75	07.00 - 12.03	D4192T4 / Di	4	<input checked="" type="checkbox"/>	Y-732J	5605	4	
S 40 1.9D		1.9	85	07.00 - 12.03	D4192T3 / DI	4	<input checked="" type="checkbox"/>	Y-732J	5605	4	
S 40 T4		1.9	147	05.97 - 07.00	B4194T / T2	4	0,8	PFR6G	4793		PFR7G
S 40 2.0		2.0	100	07.95 - 12.03	B4204S/B4204S2	4		BKR6ETUC	3384		LPG 1
S 40 2.0		2.0	103	07.95 - 08.99	B4204S	4		BKR6ETUC	3384		LPG 1
S 40 2.0 T		2.0	120	10.97 - 12.03	B4204T3	4	0,8	PFR6B	3500		LPG 1
S 40 T4		2.0	147	07.00 - 12.03	B4204T5	4	0,8	PFR6B	3500		LPG 1

**S 40 2**

S 40 II 1.6		1.6	74	01.05 -	B4164S3	4	1,3	TR5B-13	4559		LPG 4
S 40 II 1.6 D to engine no. 16125		1.6	81	01.05 - 12.11	D4164T	4	<input checked="" type="checkbox"/>	YE04	1684	40	
S 40 II 1.6 D from engine no. 16126		1.6	81	01.05 - 12.11	D4164T	4	<input checked="" type="checkbox"/>	YE05	91322	73	
S 40 II 1.8		1.8	92	04.04 - 09.10	B4184S11	4	1,3	TR6AP-13	5809		LPG 5
S 40 II 1.8 Flexfuel		1.8	92	04.04 - 09.10	B4184S8	4	1,3	TR6AP-13	5809		LPG 5
S 40 II 2.0 D		2.0	98	07.05 - 12.06	D4204T2	4	<input checked="" type="checkbox"/>	Y1005J	7957	56	
S 40 II 2.0 D		2.0	100	01.04 - 09.10	D4204T	4	<input checked="" type="checkbox"/>	Y1005J	7957	56	
S 40 II 2.0		2.0	107	10.06 -	B4204S3	4	1,3	TR6AP-13	5809		LPG 5
S 40 II 2.0 Flexfuel		2.0	107	01.10 -	B4204S4	4	1,3	TR6AP-13	5809		LPG 5
S 40 II 2.4		2.4	103	01.04 - 09.10	B5244S5	5		LFR6D	4704		
S 40 II 2.4i		2.4	125	01.04 - 09.10	B5244S4	5		LFR6D	4704		
S 40 II 2.4 D5 to chassis no. 380303		2.4	132	03.06 - 07.10	D5244T8	5	<input checked="" type="checkbox"/>	Y8008AS	91440	74	
S 40 II T5		2.5	162	01.04 - 05.08	B5254T3	5	0,8	ILFR6B	6481		
S 40 II T5		2.5	169	03.07 -	B5254T7	5	0,8	ILFR6B	6481		

**S 60 1**

S 60 2.0 T		2.0	132	09.01 - 07.04	B5204T5	5	0,8	PFR6B	3500		LPG 1
S 60 2.0 T		2.0	132	08.04 - 03.10	B5204T5	5	0,8	ILFR6B	6481		
S 60 2.3 T		2.3	147	00 -	B5234T7	5	0,8	PFR6B	3500		LPG 1
S 60 T5		2.3	184	11.00 - 04.10	B5234T3	5	0,8	PFR6B	3500		LPG 1
S 60 2.4 D		2.4	93	09.05 - 03.10	D5244T7	5	<input checked="" type="checkbox"/>	Y8008AS	91440	74	
S 60 2.4 D		2.4	96	12.01 -	D5244T2	5	<input checked="" type="checkbox"/>	YE12	7794		
S 60 2.4		2.4	103	11.00 -	B5244S2	5		BKR6ETUC	3384		LPG 1

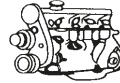
Code *l* kW

Cyl.

Stock-No.  
**V-TIME**  
B-FORMER

LPG/CNG

**VOLVO****S 60 1**

S 60 Bi-Fuel CNG (DK)		2.4	103	06.00 -	B5244SG	5		BKR6ETUC	3384		LPG 1
S 60 Bi-Fuel LPG		2.4	103	06.02 -	B5244SG2	5		BKR6ETUC	3384		LPG 1
S 60 2.4 D		2.4	120	07.01 -	D5244T	5	☑	YE12	7794		
S 60 2.4 D		2.4	120	01.07 - 03.10	D5244T5	5	☑	Y8008AS	91440	74	
S 60 2.4		2.4	125	11.00 -	B5244S	5		BKR6ETUC	3384		LPG 1
S 60 2.4 D5		2.4	136	09.05 - 03.10	D5244T4	5	☑	Y8008AS	91440	74	
S 60 2.4 T		2.4	147	11.00 -	B5244T3	5	0,8	PFR6B	3500		LPG 1
S 60 T5		2.4	191	04.04 -	B5244T5	5	0,8	ILFR6B	6481		
S 60		2.4		10.00 -	B5244T	5	0,8	PFR6B	3500		LPG 1
S 60 2.5T		2.5	154	02.04 - 04.10	B5254T2	5	0,8	PFR6B	3500		LPG 1
S 60 R 2.5T		2.5	220	03.03 -	B5254T4	5	0,8	ILFR6B	6481		

**S 60 2**

S 60 II T3		1.6	110	04.10 -	B4164T3	4	0,8	ILZTR6A8G	94769		
S 60 II T4		1.6	132	04.10 -	B4164T	4	0,8	ILZTR6A8G	94769		
S 60 II T4F Flexfuel		1.6	132	04.11 -	B4164T2	4	0,8	ILZTR6A8G	94769		
S 60 II D3		2.0	120	04.10 -	D5204T2 / T3	5	☑	Y8008AS	91440	74	
S 60 II 2.0 T		2.0	149	04.10 - 05.11	B4204T6	4	0,8	ILTR6G8G	96621		
S 60 II T5		2.0	176	04.10 -	B4204T7	4	0,8	ILTR6G8G	96621		
S 60 II D5		2.4	151	04.10 - 07.11	D5244T10	5	☑	Y8008AS	91440	74	
S 60 II D5		2.4	158	06.11 -	D5244T11 / T15	5	☑	Y8008AS	91440	74	

**S 70**

S 70 2.0	P80	2.0	93	01.97 - 11.00	B5202S	5		BKR6ETUC	3384		LPG 1
S 70 2.0	P80	2.0	105	01.97 - 11.00	B5204F	5		BKR6ETUC	3384		LPG 1
S 70 2.0	P80	2.0	120	01.97 - 11.00	B5204T4	5	0,8	PFR6B	3500		LPG 1
S 70 2.0	P80	2.0	132	01.97 - 11.00	B5204T2	5	0,8	BCPR7ES	3330		BCPR7EIX
S 70 2.0 Turbo	P80	2.0	154	01.97 - 11.00	B5204T	5	0,8	BCPR7ES	3330		BCPR7EIX
S 70 2.0 Turbo	P80	2.0	166	01.97 - 11.00	B5204T3	5	0,8	BCPR7ES	3330		BCPR7EIX
S 70 2.3	P80	2.3	120	99 -	B5234S	5	0,8	BKR6ES	3783	28	LPG 1
S 70 2.3	P80	2.3	166	09.97 -	B5234T	5	0,8	BCPR7ES	3330		BCPR7EIX
S 70 2.3	P80	2.3	177	99 -	B5234T5	5	0,8	BCPR7ES	3330		BCPR7EIX
S 70 2.3	P80	2.3	177	99 -	B5234T6	5	0,8	BCPR7ES	3330		BCPR7EIX
S 70 2.3	P80	2.3	184	01.97 - 11.00	B5234T3	5	0,8	BKR7EIX	2667		BKR8EIX
S 70 2.3	P80	2.3	184	01.97 - 11.00	B5234T4	5	0,9	BKR7E	6097		BKR8EIX
S 70 2.3	P80	2.3	184	01.97 - 11.00	B5234T8	5	0,9	BKR7E	6097		BKR8EIX
S 70 2.4	P80	2.4	103	08.99 - 11.00	B5244S2	5		BKR6ETUC	3384		LPG 1
S 70 2.4 Blu-Fuel	P80	2.4	103	07.97 - 09.00	B5244S2/B5244SG	5		BKR6ETUC	3384		LPG 1
S 70 2.4	P80	2.4	125	01.97 - 11.00	B5244S	5		BKR6ETUC	3384		LPG 1
S 70 2.4 T	P80	2.4	142	01.97 - 11.00	B5244T	5	0,8	PFR6B	3500		LPG 1
S 70 2.4	P80	2.4	195	99 -	B5244T2	5	0,8	BCPR7ES	3330		BCPR7EIX
S 70 2.5 BiFuel	P80	2.5	103	07.99 - 11.00	B5244SG	5		BKR6ETUC	3384		LPG 1
S 70 2.5 TDi	P80	2.5	103	01.97 -	D5252 (Audi)	5	☑	Y-732J	5605	4	
S 70 2.5 10V	P80	2.5	106	01.97 - 11.00	B5252S	5		BKR6ETUC	3384		LPG 1
S 70 2.5 BiFuel	P80	2.5	106	10.98 - 11.00	GB5252S	5		BKR6ETUC	3384		LPG 1
S 70 2.5 20V	P80	2.5	121	06.98 - 11.00	B5254S	5		BKR6ETUC	3384		LPG 1
S 70 2.5 T5	P80	2.5	142	11.96 - 04.99	B5254T	5	0,8	PFR6B	3500		LPG 1

**S 80 1**

S 80 2.0 T	TS	2.0	132	12.99 - 12.04	B5204T5	5	0,8	PFR6B	3500		LPG 1
S 80 2.0 T	TS	2.0	132	01.05 - 07.06	B5204T5	5	0,8	ILFR6B	6481		
S 80 2.0 T	TS	2.0	166	06.98 - 07.06	B5204T3	5	0,8	BCPR7ES	3330		BCPR7EIX

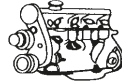

Code *l* kW

Cyl.

Stock-No.  
**VE LINE**  
BY-PROXY/2018\*\*

LPG/CNG

**VOLVO****S 80 1**

S 80 2.3 T	TS	2.3	147	99 - 07.06	B5234T7	5	0,8	PFR6B	3500		LPG 1
S 80 2.4 D	TS	2.4	96	10.01 - 07.06	D5244T2	5		YE12	7794		
S 80 2.4	TS	2.4	103	01.99 - 07.06	B5244S2	5		BKR6ETUC	3384		LPG 1
S 80 2.4 Bi-Fuel CNG	TS	2.4	103	09.01 - 07.06	B5244SG	5		BKR6ETUC	3384		LPG 1
S 80 2.4 Bi-Fuel LPG	TS	2.4	103	09.01 - 07.06	B5244SG2	5		BKR6ETUC	3384		LPG 1
S 80 2.4 D	TS	2.4	120	08.01 - 07.06	D5244T	5		YE12	7794		
S 80 2.4	TS	2.4	125	05.98 - 07.06	B5244S	5		BKR6ETUC	3384		LPG 1
S 80 2.4	TS	2.4	147	08.00 - 09.03	B5244T3	5	0,8	PFR6B	3500		LPG 1
S 80 2.4 T	TS	2.4	147	06.00 - 07.06	B5244T3	5	0,8	PFR6B	3500		LPG 1
S 80 2.5 D	TS	2.5	103	01.99 - 07.06	D5252T	5		Y-732J	5605	4	
S 80 2.5 T AWD	TS	2.5	154	07.03 - 07.06	B5254T2	5	0,8	PFR6B	3500		LPG 1
S 80 2.8 T6	TS	2.8	200	05.98 - 07.06	B6284T	6	0,8	PFR6B	3500		LPG 1
S 80 2.9	TS	2.9	144	06.01 - 07.06	B6294S / S2	6		BKR6ETUC	3384		LPG 1
S 80 2.9	TS	2.9	147	03.99 - 07.06	B6294S	6		BKR6ETUC	3384		LPG 1
S 80 3.0	TS	3.0	147	05.98 - 07.06	B6304S3	6		BKR6ETUC	3384		LPG 1
S 80 3.0	TS	3.0	150	06.99 - 07.06	B6304S	6	0,8	BKR6ES	3783	28	LPG 1
S 80 3.0 T6	TS	3.0	200	06.01 - 07.06	B6294T	6	0,8	PFR6B	3500		LPG 1

**S 80 2**

S 80 II T4	AS	1.6	132	10.10 -	B4164T	4	0,8	ILZTR6A8G	94769		
S 80 II T4F Flexfuel	AS	1.6	132	05.11 -	B4164T2	4	0,8	ILZTR6A8G	94769		
S 80 II 2.0 D	AS	2.0	100	11.07 -	D4204T	4		Y1005J	7957	56	
S 80 II 2.0	AS	2.0	107	11.07 -	B4204S3	4	1,3	TR6AP-13	5809		LPG 5
S 80 II 2.0 Flexfuel	AS	2.0	107	01.08 -	B4204S4	4	1,3	TR6AP-13	5809		LPG 5
S 80 II D3	AS	2.0	120	01.10 -	D5204T2 / T3	5		Y8008AS	91440	74	
S 80 II 2.0 T	AS	2.0	149	01.10 -	B4204T6	4	0,8	ILTR6G8G	96621		
S 80 II T5	AS	2.0	177	10.10 -	B4204T7	4	0,8	ILTR6G8G	96621		
S 80 II 2.4 D	AS	2.4	120	03.06 - 03.11	D5244T5 / T19	5		Y8008AS	91440	74	
S 80 II D5	AS	2.4	136	03.06 - 05.09	D5244T4	5		Y8008AS	91440	74	
S 80 II 2.5 T	AS	2.5	147	11.07 -	B5254T6 / T8	5	0,8	ILFR6K8	94040		
S 80 II 2.5 T FlexFuel	AS	2.5	170	01.10 -	B5254T11	5	0,8	ILFR6K8	94040		
S 80 II T6 AWD	AS	3.0	210	05.07 - 03.10	B6304T2	6	0,8	ILFR6B	6481		
S 80 II 3.2 S	AS	3.2	175	01.08 - 03.10	B6324S	6	0,8	ILFR6B	6481		

**S 90**

S 90 2.4		2.4	120	97 -	B6244F	6	0,8	BCPR6ES	2330	12	LPG 3
S 90 2.5		2.5	125	97 -	B6254F	6	0,8	BCPR6ES	2330	12	LPG 3
S 90 2.5		2.5	125	97 -	B6254G	6	0,8	BCPR6ES	2330	12	LPG 3
S 90 3.0		3.0	132	01.97 - 05.98	B6304S2	6	0,8	BKR6ES	3783	28	LPG 1
S 90 3.0		3.0	150	97 -	B6304F	6	0,8	BCPR6ES	2330	12	LPG 3
S 90 3.0		3.0	150	01.97 - 05.98	B6304G	6	0,8	BCPR6ES	2330	12	LPG 3
S 90 3.0		3.0	150	01.97 -	B6304S	6	0,8	BKR6ES	3783	28	LPG 1

**V 40 1**

V 40 1.6	VW	1.6	77	12.95 - 08.99	B4164S	4		BKR6ETUC	3384		LPG 1
V 40 1.6	VW	1.6	80	03.99 - 05.04	B4164S2	4		BKR6ETUC	3384		LPG 1
V 40 1.8	VW	1.8	85	07.95 - 08.99	B4184S	4		BKR6ETUC	3384		LPG 1
V 40 1.8 Bi-Fuel	VW	1.8	90	03.99 - 06.04	B4184S9	4		BKR6ETUC	3384		LPG 1
V 40 1.8	VW	1.8	90	03.99 - 06.04	B4184S2	4		BKR6ETUC	3384		LPG 1
V 40 1.8 GDI	VW	1.8	92	08.97 - 04.04	B4184SJ	4	0,6	IZFR6B	3116		
V 40 1.8 i	VW	1.8	92	04.98 - 09.00	B4184SM/SJ	4	0,8	IZFR6B	3116		
V 40 1.9 D	VW	1.9	66	02.96 - 06.04	D4192T	4		Y-933J	7947	25	
V 40 1.9 DI	VW	1.9	70	03.99 - 07.00	D4192T2	4		Y-740U	4818	22	

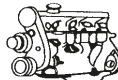
Code *l* kW

Cyl.



Stock-No.



LPG/CNG

**VOLVO****V 40 1**

V 40 1.9 D	VW	1.9	75	07.00 - 06.04	D4192T4 / DI	4	☑	Y-732J	5605	4	
V 40 1.9 D	VW	1.9	85	07.00 - 06.04	D4192T3 / DI	4	☑	Y-732J	5605	4	
V 40 T4	VW	1.9	147	05.97 - 07.00	B4194T / T2	4	0,8	PFR6G	4793		PFR7G
V 40 1.9 DCI	VW	1.9		07.00 - 06.04	dCi Renault	4	☑	Y-732J	5605	4	
V 40 2.0	VW	2.0	100	07.95 - 06.04	B4204S/B4204S2	4		BKR6ETUC	3384		LPG 1
V 40 2.0	VW	2.0	103	07.95 - 08.99	B4204S	4		BKR6ETUC	3384		LPG 1
V 40 2.0 T	VW	2.0	120	06.00 - 04.04	B4204T3	4	0,8	PFR6B	3500		LPG 1
V 40 2.0 T4	VW	2.0	147	07.00 - 06.04	B4204T5	4	0,8	PFR6B	3500		LPG 1

**V 40 2**

V 40 II T2		1.6	88	04.13 -	B4164T4	4	0,8	ILZTR6A8G	94769		
V 40 II T3		1.6	110	03.12 -	B4164T3	4	0,8	ILZTR6A8G	94769		
V 40 II T4		1.6	132	03.12 -	B4164T	4	0,8	ILZTR6A8G	94769		

**V 50**

V 50 1.6	MW	1.6	74	01.05 -	B4164S3	4	1,3	TR5B-13	4559		LPG 4
V 50 1.6 D to chassis no. 16125	MW	1.6	80	01.05 -	D4164T	4	☑	YE04	1684	40	
V 50 1.6 D from chassis no. 16126	MW	1.6	80	01.05 -	D4164T	4	☑	YE05	91322	73	
V 50 1.8	MW	1.8	92	04.04 -	B4184S11	4	1,3	TR6AP-13	5809		LPG 5
V 50 1.8 Flexfuel	MW	1.8	92	01.05 -	B4184S8	4	1,3	TR6AP-13	5809		LPG 5
V 50 2.0 D	MW	2.0	98	07.05 - 12.06	D4204T2	4	☑	Y1005J	7957	56	
V 50 2.0 D	MW	2.0	100	04.04 - 09.10	D4204T	4	☑	Y1005J	7957	56	
V 50 2.0	MW	2.0	107	10.06 -	B4204S3	4	1,3	TR6AP-13	5809		LPG 5
V 50 2.0 Flexfuel	MW	2.0	107	01.10 -	B4204S4	4	1,3	TR6AP-13	5809		LPG 5
V 50 2.4	MW	2.4	103	04.04 -	B5244S5	5		LFR6D	4704		
V 50 2.4 D to chassis no. 396178	MW	2.4	120	05.07 - 09.10	D5244T9	5	☑	Y8008AS	91440	74	
V 50 2.4i	MW	2.4	125	04.04 -	B5244S4	5		LFR6D	4704		
V 50 2.4 D5 to chassis no. 396178	MW	2.4	132	03.06 -	D5244T8 / T13	5	☑	Y8008AS	91440	74	
V 50 T5	MW	2.5	162	04.04 -	B5254T3	5	0,8	ILFR6B	6481		
V 50 T5	MW	2.5	169	03.07 -	B5254T7	5	0,8	ILFR6B	6481		

**V 60**

V 60 T3		1.6	110	09.10 -	B4164T3	4	0,8	ILZTR6A8G	94769		
V 60 T4		1.6	132	09.10 -	B4164T	4	0,8	ILZTR6A8G	94769		
V 60 T4F Flexfuel		1.6	132	04.11 -	B4164T2	4	0,8	ILZTR6A8G	94769		
V 60 D3		2.0	120	09.10 - 08.11	D5204T2 / T3	5	☑	Y8008AS	91440	74	
V 60 2.0 T		2.0	149	09.10 -	B4204T6	4	0,8	ILTR6G8G	96621		
V 60 T5		2.0	176	09.10 -	B4204T7	4	0,8	ILTR6G8G	96621		
V 60 D5		2.4	151	09.10 -	D5244T10	5	☑	Y8008AS	91440	74	
V 60 2.4 D5		2.4	158	06.11 -	D5244T11 / T15	5	☑	Y8008AS	91440	74	

**V 70 1**

V 70 1 2.0	P80	2.0	93	01.97 - 03.00	B5202S	5	0,8	BKR6ES	3783	28	LPG 1
V 70 1 2.0	P80	2.0	105	01.97 - 03.00	B5204S	5	0,8	BKR6ES	3783	28	LPG 1
V 70 1 2.0 T	P80	2.0	120	01.97 - 08.00	B5204T4	5	0,8	BKR6EVX	3539		LPG 1
V 70 1 2.0 T	P80	2.0	132	01.97 - 03.00	B5204T2	5	0,8	BKR6EVX	3539		LPG 1
V 70 1 2.0 T	P80	2.0	155	01.97 - 03.00	B5204T	5	0,8	BCPR7ES	3330		BCPR7EIX
V 70 1 2.0 T	P80	2.0	166	01.97 - 03.00	B5204T3	5	0,8	BCPR7ES	3330		BCPR7EIX
V 70 1 2.3 T5	P80	2.3	176	99 - 03.00	B5234T5	5	0,8	BCPR7ES	3330		BCPR7EIX
V 70 1 2.3 T5	P80	2.3	176	99 - 03.00	B5234T6	5	0,8	BCPR7ES	3330		BCPR7EIX
V 70 1 2.3 T	P80	2.3	184	04.97 - 03.00	B5234T4	5	0,8	BKR6EVX	3539		LPG 1
V 70 1 2.3 T	P80	2.3	184	01.97 - 03.00	B5234T8	5	0,8	BKR6EVX	3539		LPG 1
V 70 1 2.3 T	P80	2.3	184	01.97 - 03.00	B5234T3	5	0,8	BKR7EVX	3544		BKR8EIX

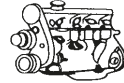
Code *l* kW

Cyl.



Stock-No.



B-POWER/BK

LPG/CNG

**VOLVO****V 70 1**

V 70 1 2.4	P80	2.4	103	08.99 - 03.00	B5244S2	5	0,8	BKR6ES	3783	28	LPG 1
V 70 1 2.4 Bi-Fuel CNG	P80	2.4	103	08.99 - 03.00	B5244SG	5		LPG 1	1496		LPG 1
V 70 1 2.4 Bi-Fuel LPG	P80	2.4	103	08.99 - 03.00	B5244SG2	5		LPG 1	1496		LPG 1
V 70 1 2.4 T	P80	2.4	142	01.97 - 03.00	B5244T	5	0,8	BKR6EVX	3539		LPG 1
V 70 1 2.4 T	P80	2.4	195	03.99 - 03.00	B5244T2	5	0,8	BCPR7ES	3330		BCPR7EIX
V 70 1 2.5 D	P80	2.5	103	01.97 - 03.00	D5252T	5	☑	Y-732J	5605	4	
V 70 1 2.5 10V	P80	2.5	106	01.97 - 03.00	B5252S	5	0,8	BKR6ES	3783	28	LPG 1
V 70 2.5 BiFuel	P80	2.5	106	10.98 - 08.99	GB5252S	5		BKR6ETUC	3384		LPG 1
V 70 1 2.5 20V	P80	2.5	125	01.97 - 05.00	B5254S	5	0,8	BKR6ES	3783	28	LPG 1
V 70 1 2.5 T	P80	2.5	142	01.97 - 03.00	B5254T	5	0,8	BKR6EVX	3539		LPG 1

**V 70 2**

V 70 II 2.0	P80	2.0	107	10.07 -	B4204S3	4	1,3	TR6AP-13	5809		LPG 5
V 70 II 2.0 Flexfuel	P80	2.0	107	01.08 -	B4204S4	4	1,3	TR6AP-13	5809		LPG 5
V 70 II 2.0 T	P80	2.0	132	07.01 - 08.07	B5204T5	5	0,8	PFR6B	3500		LPG 1
V 70 II 2.3 T5	P80	2.3	184	03.00 - 08.07	B5234T3	5	0,8	PFR6B	3500		LPG 1
V 70 II 2.4 D	P80	2.4	93	05.05 - 07.07	D5244T7	5	☑	Y8008AS	91440	74	
V 70 II 2.4 D	P80	2.4	96	12.01 -	D5244T2	5	☑	YE12	7794		
V 70 II 2.4 D5	P80	2.4	120	08.01 - 07.06	D5244T	5	☑	YE12	7794		
V 70 II 2.4 D5	P80	2.4	120	08.06 - 07.07	D5244T5	5	☑	Y8008AS	91440	74	
V 70 II 2.4	P80	2.4	125	03.00 -	B5244S	5		BKR6ETUC	3384		LPG 1
V 70 II 2.4 D5	P80	2.4	136	12.05 - 07.07	D5244T4	5	☑	Y8008AS	91440	74	
V 70 II 2.4 T	P80	2.4	147	03.00 - 08.07	B5244T3	5	0,8	PFR6B	3500		LPG 1
V 70 II 2.4 T5	P80	2.4	191	04.04 - 07.07	B5244T5	5	0,8	ILFR6B	6481		ILFR6B
V 70 II 2.5 T	P80	2.5	154	04.04 - 08.07	B5254T2	5	0,8	PFR6B	3500		LPG 1
V 70 II R 2.5 T AWD	P80	2.5	220	03.03 -	B5254T4	5	0,8	ILFR6B	6481		ILFR6B

**V 70 3**

V 70 III T4		1.6	132	10.10 -	B4164T	4	0,8	ILZTR6A8G	94769		
V 70 III T4F Flexfuel		1.6	132	05.11 -	B4164T2	4	0,8	ILZTR6A8G	94769		
V 70 III 2.0 D		2.0	100	08.07 - 12.10	D4204T	4	☑	Y1005J	7957	56	
V 70 III D3		2.0	120	03.10 -	D5204T2 / T3	5	☑	Y8008AS	91440	74	
V 70 III 2.0 T		2.0	149	01.10 -	B4204T6	4	0,8	ILTR6G8G	96621		
V 70 III T5		2.0	177	01.10 -	B4204T7	4	0,8	ILTR6G8G	96621		
V 70 III 2.4 D		2.4	120	08.07 -	D5244T5	5	☑	Y8008AS	91440	74	
V 70 III 2.4 D		2.4	129	05.09 -	D5244T14	5	☑	Y8008AS	91440	74	
V 70 III D5		2.4	136	08.07 -	D5244T4	5	☑	Y8008AS	91440	74	
V 70 III D5		2.4	158	06.11 -	D5244T11 / T15	5	☑	Y8008AS	91440	74	
V 70 III 2.5 T		2.5	147	08.07 -	B5254T6 / T8	5	0,8	ILFR6K8	94040		
V 70 III 2.5 T FlexFuel		2.5	170	10.09 -	B5254T11	5	0,8	ILFR6K8	94040		
V 70 III T6 AWD		3.0	210	08.07 -	B6304T2	6	0,8	ILFR6B	6481		
V 70 III 3.2		3.2	175	08.07 -	B6324S	6	0,8	ILFR6B	6481		

**V 90**

V 90 2.4		2.4	120	97 -	B6244F	6	0,8	BCPR6ES	2330	12	LPG 3
V 90 2.5		2.5	125	97 -	B6254F	6	0,8	BCPR6ES	2330	12	LPG 3
V 90 2.5		2.5	125	97 -	B6254G	6	0,8	BCPR6ES	2330	12	LPG 3
V 90 2.9		2.9	150	97 -	B6304F	6	0,8	BCPR6ES	2330	12	LPG 3
V 90 2.9		2.9	150	97 -	B6304G	6	0,8	BCPR6ES	2330	12	LPG 3
V 90 3.0		3.0	132	01.97 -	B6304S2	6	0,8	BKR6ES	3783	28	LPG 1
V 90 3.0		3.0	150	01.97 -	B6304S	6	0,8	BKR6ES	3783	28	LPG 1

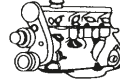
Code *l* kW

Cyl.



Stock-No.

V-TIME  
E-POWER  
LPG/CNG**VOLVO****XC60**

XC60 2.0 T		2.0	149	01.10 -	B4204T6	4	0,8	ILTR6G8G	96621		
XC60 T5		2.0	177	09.10 -	B4204T7	4	0,8	ILTR6G8G	96621		
XC60 2.4 D		2.4	120	05.08 -	D5244T5 / T16	5	☑	Y8008AS	91440	74	
only for EURO III and EURO IV											
XC60 D5 AWD		2.4	136	05.08 - 12.09	D5244T4	5	☑	Y8008AS	91440	74	
only for EURO III and EURO IV											
XC60 3.0 T6 AWD		3.0	210	10.08 -	B6304T2	6	0,8	ILFR6B	6481		

**XC70 1**

XC70 2.4D5		2.4	120	09.02 -	D5244T5	5	☑	YE12	7794		
XC70 2.4 D5 AWD		2.4	136	05.05 - 07.07	D5244T4	5	☑	Y8008AS	91440	74	
XC70 2.4T		2.4	147	09.00 - 09.02	B5244T3	5	0,8	PFR6B	3500		LPG 1
XC70 2.5T		2.5	154	09.02 - 08.07	B5254T2	5	0,8	PFR6B	3500		LPG 1
XC70 3.0 T6 AWD		3.0	210	01.08 -	B6304T2	6	0,8	ILFR6B	6481		ILFR6B
XC70 3.2 AWD		3.2	175	02.07 -	B6324S	6	0,8	ILFR6B	6481		ILFR6B

**XC70 2**

XC70 II D3 AWD		2.0	120	08.11 -	D5204T2 / T3	5	☑	Y8008AS	91440	74	
XC70 II 2.4 D AWD		2.4	120	08.07 -	D5244T5 / T16	5	☑	Y8008AS	91440	74	
XC70 II 2.4 D		2.4	129	01.10 -	D5244T14	5	☑	Y8008AS	91440	74	
XC70 II D5 AWD		2.4	136	08.07 -	D5244T4	5	☑	Y8008AS	91440	74	
XC70 II D5 AWD		2.4	158	06.11 -	D5244T11 / T15	5	☑	Y8008AS	91440	74	

**XC90**

XC90 D5		2.4	120	02.03 -	D5244T	5	☑	YE12	7794		
XC90 D5		2.4	120	03.11 -	D5244T5	5	☑	Y8008AS	91440	74	
XC90 D5		2.4	136	05.05 -	D5244T4	5	☑	Y8008AS	91440	74	
XC90 D5		2.4	147	11.10 -	D5244T18	5	☑	Y8008AS	91440	74	
XC90 2.5T		2.5	154	10.02 -	B5254T2	5	0,8	PFR6B	3500		LPG 1
XC90 T6 Biturbo		2.9	200	10.02 -	B6294T	6	0,8	PFR6B	3500		LPG 1
XC90 3.2		3.2	175	05.06 -	B6324S	6	0,8	ILFR6B	6481		
XC90 4.4		4.4	232	11.04 -	B8444S	8	1,1	IFR6B-11	5368		

**VW****AMAROK**

Amarok 2.0 TDI	2HA/2HB	2.0	90	09.10 -	CDBA	4	☑	Y1002AS	8888	57	
Amarok 2.0 TDI	2HA/2HB	2.0	90	09.10 -	CNFA	4	☑	Y1002AS	8888	57	
Amarok 2.0 TDI	2HA/2HB	2.0	103	05.12 -	CNFB	4	☑	Y1002AS	8888	57	
Amarok 2.0 TSI	2HA/2HB	2.0	118	12.10 -	CFPA	4	0,8	PFR7S8EG	1675		PFR8S8EG
Amarok 2.0 BiTDI	2HA/2HB	2.0	120	09.10 -	CDCA	4	☑	Y1002AS	8888	57	
Amarok 2.0 BiTDI 4motion	2HA/2HB	2.0	132	11.11 -	CNEA	4	☑	Y1002AS	8888	57	
Amarok 2.0 BiTDI 4motion	2HA/2HB	2.0	132	11.11 -	CSHA	4	☑	Y1002AS	8888	57	

**BEETLE (NEW BEETLE)**

Beetle 1.4 (9C1 / 1C1)	9C1/1C1	1.4	55	08.01 -	BCA	4	1,1	PZFR5D-11	7968	34	LPG 6
Beetle 1.6 (9C1 / 1C1)	9C1/1C1	1.6	74	11.99 - 10.00	AWH	4		BKUR6ET-10	2397	24	LPG 1
Beetle 1.6 (9C1 / 1C1)	9C1/1C1	1.6	74	06.00 -	AYD	4		BKUR6ET-10	2397	24	LPG 1
Beetle 1.6 (9C1 / 1C1)	9C1/1C1	1.6	75	06.02 -	BFS	4		BKUR6ET-10	2397	24	LPG 1
Beetle 1.8 T (9C1 / 1C1)	9C1/1C1	1.8	110	01.98 - 06.00	AGU	4	0,8	PFR6Q	6458	37	LPG 1
Beetle 1.8 T (9C1 / 1C1)	9C1/1C1	1.8	110	01.99 - 06.00	APH	4	0,8	PFR6Q	6458	37	LPG 1
Beetle 1.8 T (9C1 / 1C1)	9C1/1C1	1.8	110	07.99 - 10.00	AVC	4	0,8	PFR6Q	6458	37	LPG 1
Beetle 1.8 T (9C1 / 1C1)	9C1/1C1	1.8	110	10.00 -	AWU	4	0,8	PFR6Q	6458	37	LPG 1
Beetle 1.8 T (9C1 / 1C1)	9C1/1C1	1.8	110	06.00 - 06.04	AWV	4	0,8	PFR6Q	6458	37	LPG 1

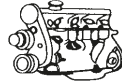
Code *l* kW

Cyl.



Stock-No.



LPG/CNG

**VW  
BEETLE (NEW BEETLE)**

Beetle 1.8 T (9C1 / 1C1)	9C1/1C1	1.8	110	07.04 -	BKF	4	0,8	PFR6Q	6458	37	LPG 1
Beetle 1.8 T (9C1 / 1C1)	9C1/1C1	1.8	132	06.02 - 06.04	AWP	4	0,8	PFR6Q	6458	37	LPG 1
Beetle 1.9 TDI (9C1 / 1C1)	9C1/1C1	1.9	66	01.98 - 06.04	ALH	4	█	Y-732J	5605	4	
Beetle 1.9 TDI (9C1 / 1C1)	9C1/1C1	1.9	74	10.00 -	ATD	4	█	Y-741U	6943	20	
Beetle 1.9 TDI (9C1 / 1C1)	9C1/1C1	1.9	74	10.00 - 10.01	ATD	4	█	Y-732J	5605	4	
Beetle 1.9 TDI (9C1 / 1C1)	9C1/1C1	1.9	74	06.03 -	AXR	4	█	Y-741U	6943	20	
Beetle 1.9 TDI (9C1 / 1C1)	9C1/1C1	1.9	74	07.05 - 12.06	BEW	4	█	CZ104	9826	52	
Beetle 1.9 TDI (9C1 / 1C1)	9C1/1C1	1.9	77	07.05 -	BSW	4	█	Y-741U	6943	20	
Beetle 2.0 (9C1 / 1C1)	9C1/1C1	2.0	85	01.98 - 05.01	AEG	4		BKUR6ET-10	2397	24	LPG 1
Beetle 2.0 (9C1 / 1C1)	9C1/1C1	2.0	85	08.98 -	AQY	4		BKUR6ET-10	2397	24	LPG 1
Beetle 2.0 (9C1 / 1C1)	9C1/1C1	2.0	85	03.00 -	APK	4		BKUR6ET-10	2397	24	LPG 1
Beetle 2.0 (9C1 / 1C1)	9C1/1C1	2.0	85	06.01 -	AZJ	4	1,1	PZFR5D-11	7968	34	LPG 6
Beetle 2.0 (9C1 / 1C1)	9C1/1C1	2.0	85	06.02 - 07.03	AZG	4	1,1	PZFR5D-11	7968	34	LPG 6
Beetle 2.0 (9C1 / 1C1)	9C1/1C1	2.0	85	01.03 -	BER	4	1,1	PZFR5D-11	7968	34	LPG 6
Beetle 2.0 (9C1 / 1C1)	9C1/1C1	2.0	85	07.04 -	BEV	4	1,1	PZFR5D-11	7968	34	LPG 6
Beetle 2.0 (9C1 / 1C1)	9C1/1C1	2.0	85	03.07 -	CBPA	4		BKUR6ET-10	2397	24	LPG 1
Beetle 2.0 (9C1 / 1C1)	9C1/1C1	2.0	85	07.05 -	BHP	4		BKUR6ET-10	2397	24	LPG 1
Beetle 2.3 V5 (9C1 / 1C1)	9C1/1C1	2.3	125	10.00 -	AQN	5	1,1	PZFR5D-11	7968	34	LPG 6
Beetle 2.5 Fgst → 1C-6-413 286*	9C1/1C1	2.5	110	07.05 -	BPR	5	1,1	PZFR5J-11	7743		LPG 6
Beetle 2.5 Fgst → 1C-6-413 286*	9C1/1C1	2.5	110	07.05 -	BPS	5	1,1	PZFR5J-11	7743		LPG 6
Beetle 3.2 RSI (9C1 / 1C1)	9C1/1C1	3.2	165	10.00 - 05.01	AXJ	6	1,1	PZFR5D-11	7968	34	LPG 6

**BEETLE**

Beetle 2 1.2 TSI	5C1	1.2	77	10.11 -	CBZB	4	0,7	IZFR6P7	97153		
Beetle 2 1.4 TSI	5C1	1.4	118	10.11 -	CAVD	4	0,8	SIZFR6B8EG	96209		
Beetle 2 1.4 TSI	5C1	1.4	118	10.11 -	CNWA	4	0,8	SIZFR6B8EG	96209		
Beetle 2 1.4 TSI	5C1	1.4	118	10.11 -	CTHD	4	0,8	SIZFR6B8EG	96209		
Beetle 2 1.4 TSI	5C1	1.4	118	10.11 -	CTKA	4	0,8	SIZFR6B8EG	96209		
Beetle 2 1.6 TDI	5C1	1.6	77	10.11 -	CAYC	4	█	Y1002AS	8888	57	
Beetle 2 2.0 TSI	5C1	2.0	147	10.11 -	CBFA	4	0,8	PFR7S8EG	1675		PFR8S8EG
Beetle 2 2.0 TSI	5C1	2.0	147	10.11 -	CCTA	4	0,8	PFR7S8EG	1675		PFR8S8EG

**BORA**

Bora 1.4	1J2 / 1J6	1.4	55	10.98 - 05.05	AHW	4		BKUR6ET-10	2397	24	LPG 1
Bora 1.4	1J2 / 1J6	1.4	55	05.00 - 10.01	AXP	4		BKUR6ET-10	2397	24	LPG 1
Bora 1.4	1J2 / 1J6	1.4	55	10.01 - 05.05	BCA	4		BKUR6ET-10	2397	24	LPG 1
Bora 1.4 16V	1J2 / 1J6	1.4	55	09.98 - 05.00	AKQ	4		BKUR6ET-10	2397	24	LPG 1
Bora 1.4 16V	1J2 / 1J6	1.4	55	05.99 - 05.00	APE	4		BKUR6ET-10	2397	24	LPG 1
Bora 1.4 Automatic	1J2 / 1J6	1.4	55	05.00 - 10.01	AXP	4	1,1	PZFR5D-11	7968	34	LPG 6
Bora 1.6 China	1J2 / 1J6	1.6	74	10.04 -	BJH	4	0,9	BKR6E	6962	28	LPG 1
Bora 1.6	1J2 / 1J6	1.6	74	09.98 - 06.02	AEH	4		BKUR6ET-10	2397	24	LPG 1
Bora 1.6	1J2 / 1J6	1.6	74	09.98 - 05.03	AKL	4		BKUR6ET-10	2397	24	LPG 1
Bora 1.6	1J2 / 1J6	1.6	74	05.99 - 09.00	APF	4		BKUR6ET-10	2397	24	LPG 1
Bora 1.6	1J2 / 1J6	1.6	74	09.00 - 04.02	AVU	4		BKUR6ET-10	2397	24	LPG 1
Bora 1.6	1J2 / 1J6	1.6	75	05.02 - 05.05	BFQ	4		BKUR6ET-10	2397	24	LPG 1
Bora 1.6 16V	1J2 / 1J6	1.6	77	11.99 - 05.00	ATN	4		BKUR6ET-10	2397	24	LPG 1
Bora 1.6 16V	1J2 / 1J6	1.6	77	05.00 - 10.00	AUS	4		BKUR6ET-10	2397	24	LPG 1
Bora 1.6 16V	1J2 / 1J6	1.6	77	11.01 - 05.05	BCB	4	1,1	PZFR6J-11	3586		LPG 6
Bora 1.6 16V	1J2 / 1J6	1.6	77	09.00 - 11.01	AZD	4	1,1	PZFR6J-11	3586		LPG 6
Bora 1.6 FSI	1J2 / 1J6	1.6	81	08.01 - 05.05	BAD	4		ZFR6S-Q	6449		
Bora 1.8	1J2 / 1J6	1.8	92	09.98 - 10.00	AGN	4		BKUR6ET-10	2397	24	LPG 1
Bora 1.8 T	1J2 / 1J6	1.8	110	09.00 - 05.03	AGU	4	0,8	PFR6Q	6458	37	LPG 1

Fgst = Chassis No.



Code *l* kW

Cyl.

Stock-No.  
**VW**  
B-POLYMER\*

LPG/CNG

**VW****BORA**

Bora 1.8 T	1J2 / 1J6	1.8	110	09.00 - 04.01	ARX	4	0,8	PFR6Q	6458	37	LPG 1
Bora 1.8 T	1J2 / 1J6	1.8	110	09.00 - 05.05	AUM	4	0,8	PFR6Q	6458	37	LPG 1
Bora 1.8 T	1J2 / 1J6	1.8	132	05.02 - 05.05	AUQ	4	0,8	PFR6Q	6458	37	LPG 1
Bora 1.9 SDI	1J2 / 1J6	1.9	50	11.98 - 05.05	AQM	4	█	Y-732J	5605	4	
Bora 1.9 SDI	1J2 / 1J6	1.9	50	05.00 - 04.01	AGP	4	█	Y-732J	5605	4	
Bora 1.9 TDI	1J2 / 1J6	1.9	66	10.98 - 09.02	AGR	4	█	Y-732J	5605	4	
Bora 1.9 TDI	1J2 / 1J6	1.9	66	09.98 - 05.03	ALH	4	█	Y-732J	5605	4	
Bora 1.9 TDI Fgst → 1J-2-600000	1J2 / 1J6	1.9	74	05.00 - 05.05	ATD	4	█	Y-732J	5605	4	
Bora 1.9 TDI Fgst → 1J-2-600000	1J2 / 1J6	1.9	74	05.01 - 05.05	AXR	4	█	Y-732J	5605	4	
Bora 1.9 TDI Fgst 1J-2-600001 →	1J2 / 1J6	1.9	74	05.00 - 05.05	ATD	4	█	Y-741U	6943	20	
Bora 1.9 TDI Fgst 1J-2-600001 →	1J2 / 1J6	1.9	74	05.01 - 05.05	AXR	4	█	Y-741U	6943	20	
Bora 1.9 TDI	1J2 / 1J6	1.9	81	09.98 - 05.05	AHF	4	█	Y-732J	5605	4	
Bora 1.9 TDI	1J2 / 1J6	1.9	81	05.00 - 05.05	ASV	4	█	Y-732J	5605	4	
Bora 1.9 TDI	1J2 / 1J6	1.9	85	11.98 - 07.01	AJM	4	█	Y-732J	5605	4	
Bora 1.9 TDI	1J2 / 1J6	1.9	85	05.00 - 07.01	AUY	4	█	Y-732J	5605	4	
Bora 1.9 TDI Fgst → 1J-2-600000	1J2 / 1J6	1.9	96	04.01 - 05.05	ASZ	4	█	Y-732J	5605	4	
Bora 1.9 TDI Fgst 1J-2-600001 →	1J2 / 1J6	1.9	96	04.01 - 05.05	ASZ	4	█	Y-741U	6943	20	
Bora 1.9 TDI Fgst → 1J-2-600000	1J2 / 1J6	1.9	110	09.00 - 05.05	ARL	4	█	Y-732J	5605	4	
Bora 1.9 TDI Fgst 1J-2-600001 →	1J2 / 1J6	1.9	110	09.00 - 05.05	ARL	4	█	Y-741U	6943	20	
Bora 2.0	1J2 / 1J6	2.0	85	11.98 - 05.05	APK	4		BKUR6ET-10	2397	24	LPG 1
Bora 2.0	1J2 / 1J6	2.0	85	09.98 - 05.05	AQY	4		BKUR6ET-10	2397	24	LPG 1
Bora 2.0	1J2 / 1J6	2.0	85	04.00 - 06.01	AZH	4		BKUR6ET-10	2397	24	LPG 1
Bora 2.0	1J2 / 1J6	2.0	85	05.01 - 05.05	AZJ	4	1,1	PZFR5D-11	7968	34	LPG 6
Bora 2.3 V5	1J2 / 1J6	2.3	110	09.98 - 02.01	AGZ	5		BKR5EKUP	2890		
Bora 2.3 V5	1J2 / 1J6	2.3	125	09.00 - 05.05	AQN	5	1,1	PZFR5D-11	7968	34	LPG 6
Bora 2.8 V6 4motion	1J2 / 1J6	2.8	150	05.01 - 05.03	BDE	6	1,1	PZFR5D-11	7968	34	LPG 6
Bora 2.8 V6 4motion	1J2 / 1J6	2.8	150	05.99 - 05.00	AQP	6	1,1	PZFR5D-11	7968	34	LPG 6
Bora 2.8 V6 4motion	1J2 / 1J6	2.8	150	05.00 - 04.01	AUE	6	1,1	PZFR5D-11	7968	34	LPG 6

**CADDY 1**

Caddy 1 1.6 D	14	1.6	40	08.90 - 07.92	ME	4	█	Y-918J	6285	2	
Caddy 1 1.8	14	1.8	70	08.85 - 07.92	JH	4		BUR6ET	3172	1	LPG 2

**CADDY 2**

Caddy 2 1.4	9K9A /9K9B	1.4	44	11.95 - 12.97	AEX	4		BUR6ET	3172	1	LPG 2
Caddy 2 1.4	9K9A /9K9B	1.4	44	11.97 - 09.00	AKV	4		BUR6ET	3172	1	LPG 2
Caddy 2 1.4	9K9A /9K9B	1.4	44	12.97 - 06.03	APQ	4		BUR6ET	3172	1	LPG 2
Caddy 2 1.4	9K9A /9K9B	1.4	44	09.00 - 06.03	AUD	4	1,1	PZFR5D-11	7968	34	LPG 6
Caddy 2 1.4	9K9A /9K9B	1.4	55	09.00 - 06.03	AUA	4		BKUR6ET-10	2397	24	LPG 1
Caddy 2 1.6	9K9A /9K9B	1.6	55	11.95 - 05.97	1F	4		BUR5ET	3377	22	LPG 2
Caddy 2 1.6	9K9A /9K9B	1.6	55	06.96 - 12.00	AEE	4		BUR6ET	3172	1	LPG 2
Caddy 2 1.9 D	9K9A /9K9B	1.9	47	11.95 - 06.03	1Y	4	█	Y-918J	6285	2	
Caddy 2 1.9 D	9K9A /9K9B	1.9	47	06.96 - 12.00	AEF	4	█	Y-918J	6285	2	
Caddy 2 1.9 SDI	9K9A /9K9B	1.9	47	11.95 - 09.00	AEY	4	█	Y-732J	5605	4	
Caddy 2 1.9 SDI	9K9A /9K9B	1.9	47	09.00 - 06.03	AYQ	4	█	Y-732J	5605	4	
Caddy 2 1.9 TDI	9K9A /9K9B	1.9	66	10.96 - 09.00	AHU	4	█	Y-732J	5605	4	
Caddy 2 1.9 TDI	9K9A /9K9B	1.9	66	09.97 - 09.00	ALE	4	█	Y-732J	5605	4	
Caddy 2 1.9 TDI	9K9A /9K9B	1.9	66	09.00 - 06.03	ALH	4	█	Y-732J	5605	4	

Fgst = Chassis No.

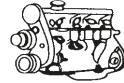
Code *l* kW

Cyl.



Stock-No.



LPG/CNG

**VW  
CADDY 3**

Caddy 3 1.2 TSI	2KB/2KJ/ 2KA/2KH	1.2	63	09.10 -	CBZA	4	0,7	IZFR6P7	97153		
Caddy 3 1.2 TSI	2KB/2KJ/ 2KA/2KH	1.2	77	09.10 -	CBZB	4	0,7	IZFR6P7	97153		
Caddy 3 1.4	2KB/2KJ/ 2KA/2KH	1.4	55	02.04 - 05.06	BCA	4		BKUR6ET-10	2397	24	LPG 1
Caddy 3 1.4	2KB/2KJ/ 2KA/2KH	1.4	59	05.06 -	BUD	4	1,1	ZFR6T-11G	5960		
Caddy 3 1.6	2KB/2KJ/ 2KA/2KH	1.6	75	04.04 - 05.05	BGU	4		BKUR6ET-10	2397	24	LPG 1
Caddy 3 1.6	2KB/2KJ/ 2KA/2KH	1.6	75	06.05 -	BSE	4		BKUR6ET-10	2397	24	LPG 1
Caddy 3 1.6	2KB/2KJ/ 2KA/2KH	1.6	75	06.05 -	BSF	4		BKUR6ET-10	2397	24	LPG 1
Caddy 3 1.6 China	2KB/2KJ/ 2KA/2KH	1.6	74	05 -	BRY	4	0,9	BKR6E	6962	28	LPG 1
Caddy 3 1.6 TDI	2KB/2KJ/ 2KA/2KH	1.6	55	08.10 -	CAYE	4		Y1002AS	8888	57	
Caddy 3 1.6 TDI	2KB/2KJ/ 2KA/2KH	1.6	75	08.10 -	CAYD	4		Y1002AS	8888	57	
Caddy 3 1.9 TDI	2KB/2KJ/ 2KA/2KH	1.9	55	09.05 -	BSU	4		Y-607AS	7560	50	
Caddy 3 1.9 TDI	2KB/2KJ/ 2KA/2KH	1.9	77	02.04 -	BJB	4		Y-607AS	7560	50	
Caddy 3 1.9 TDI	2KB/2KJ/ 2KA/2KH	1.9	77	06.05 -	BLS	4		Y-607AS	7560	50	
Caddy 3 2.0 EcoFuel CNG	2KB/2KJ/ 2KA/2KH	2.0	80	04.06 -	BSX	4	0,9	BKR6E	6962	28	LPG 1
Caddy 3 2.0 SDI	2KB/2KJ/ 2KA/2KH	2.0	52	02.04 -	BDJ	4		Y-741U	6943	20	
Caddy 3 2.0 SDI	2KB/2KJ/ 2KA/2KH	2.0	52	06.05 -	BST	4		Y-741U	6943	20	
Caddy 3 2.0 TDI	2KB/2KJ/ 2KA/2KH	2.0	103	09.07 -	BMM	4		Y-607AS	7560	50	
Caddy 3 2.0 TDI	2KB/2KJ/ 2KA/2KH	2.0	103	11.10 -	CFHC	4		Y1002AS	8888	57	
Caddy 3 2.0 TDI 4motion	2KB/2KJ/ 2KA/2KH	2.0	81	10.10 -	CFHF	4		Y1002AS	8888	57	

**CC**

CC 1.4 TSI	358	1.4	118	11.11 -	CKMA	4	0,6	SIZFR6A6D	91629		
CC 1.8 TSI	358	1.8	118	11.11 - 10.12	CDAA	4	0,8	PFR7S8EG	1675		PFR8S8EG
CC 2.0 TDI	358	2.0	100	11.11 -	CFFA	4		Y1002AS	8888	57	
CC 2.0 TDI	358	2.0	103	11.11 -	CFFB	4		Y1002AS	8888	57	
CC 2.0 TDI	358	2.0	125	11.11 -	CFGB	4		Y1002AS	8888	57	
CC 2.0 TDI	358	2.0	125	11.11 -	CLLA	4		Y1002AS	8888	57	
CC 2.0 TDI	358	2.0	130	12.12 -	CFGC	4		Y1002AS	8888	57	
CC 2.0 TSI	358	2.0	155	11.11 -	CCZB	4	0,8	PFR7S8EG	1675		PFR8S8EG
CC 3.6 FSI V6 4motion	358	3.6	220	11.11 -	BWS	6	0,8	ILZKR8A	94290		

**CORRADO**

Corrado 1.8 16V	531	1.8	98	04.89 - 07.92	KR	4		BCPR7ET	2164		BCPR7EIX
-----------------	-----	-----	----	---------------	----	---	--	---------	------	--	----------

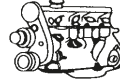
Code *l* kW

Cyl.



Stock-No.



LPG/CNG

VW

**CORRADO**

Corrado 2.0	53l	2.0	85	04.93 - 09.94	2E	4		BUR6ET	3172	1	LPG 2
Corrado 2.0	53l	2.0	85	07.94 - 07.95	ADY	4		BUR6ET	3172	1	LPG 2
Corrado 2.0 16V	53l	2.0	100	08.91 - 07.95	9A	4		BKUR7ET	7873		
Corrado 2.8 VR6	53l	2.8	128	08.91 - 01.96	AAA	6		BKR5EKUP	2890		
Corrado 2.8 VR6	53l	2.8	132	08.91 - 06.95	AAA	6		BKR5EKU	3964		
Corrado 2.8 VR6	53l	2.8	132	07.95 - 01.96	AAA	6		BKR5EKUP	2890		
Corrado 2.9 VR6	53l	2.9	140	08.91 - 07.95	ABV	6		BKR5EKU	3964		

**CRAFTER**

Crafter 2.0 TDI	2E/2F	2.0	80	05.11 -	CKTB	4		Y1002AS	8888	57	
Crafter 2.0 TDI	2E/2F	2.0	100	05.11 -	CKTC	4		Y1002AS	8888	57	
Crafter 2.0 TDI	2E/2F	2.0	105	10.11 -	CKUC	4		Y1002AS	8888	57	
Crafter 2.0 TDI	2E/2F	2.0	120	07.11 -	CKUB	4		Y1002AS	8888	57	
Crafter 2.5 TDI	2E/2F	2.5	65	04.06 - 07.11	BJJ	5		Y-607AS	7560	50	
Crafter 2.5 TDI	2E/2F	2.5	65	04.06 - 07.11	BJJ	5		CZ104	9826	52	
nur für Fzg. mit keramischer GK											
Crafter 2.5 TDI	2E/2F	2.5	65	05.09 - 07.11	CEBA	5		Y-607AS	7560	50	
Crafter 2.5 TDI	2E/2F	2.5	65	05.09 - 07.11	CEBA	5		CZ104	9826	52	
nur für Fzg. mit keramischer GK											
Crafter 2.5 TDI	2E/2F	2.5	80	04.06 - 07.11	BJK	5		Y-607AS	7560	50	
Crafter 2.5 TDI	2E/2F	2.5	80	04.06 - 07.11	BJK	5		CZ104	9826	52	
nur für Fzg. mit keramischer GK											
Crafter 2.5 TDI	2E/2F	2.5	80	05.09 - 07.11	CEBB	5		Y-607AS	7560	50	
Crafter 2.5 TDI	2E/2F	2.5	80	05.09 - 07.11	CEBB	5		CZ104	9826	52	
nur für Fzg. mit keramischer GK											
Crafter 2.5 TDI	2E/2F	2.5	100	04.06 -	BJL	5		Y-607AS	7560	50	
Crafter 2.5 TDI	2E/2F	2.5	100	04.06 -	BJL	5		CZ104	9826	52	
nur für Fzg. mit keramischer GK											
Crafter 2.5 TDI	2E/2F	2.5	100	05.09 -	CECA	5		Y-607AS	7560	50	
Crafter 2.5 TDI	2E/2F	2.5	100	05.09 -	CECA	5		CZ104	9826	52	
nur für Fzg. mit keramischer GK											
Crafter 2.5 TDI	2E/2F	2.5	120	04.06 - 07.11	BJM	5		Y-607AS	7560	50	
Crafter 2.5 TDI	2E/2F	2.5	120	04.06 - 07.11	BJM	5		CZ104	9826	52	
nur für Fzg. mit keramischer GK											
Crafter 2.5 TDI	2E/2F	2.5	120	05.09 - 07.11	CECB	5		Y-607AS	7560	50	
Crafter 2.5 TDI	2E/2F	2.5	120	05.09 - 07.11	CECB	5		CZ104	9826	52	
nur für Fzg. mit keramischer GK											

**EOS 1**

Eos 1.4 TSI	1F7	1.4	90	11.07 - 10.10	CAXA	4	0,9	PZFR6R	5758		PZFR6R
Eos 1.4 TSI	1F7	1.4	118	05.08 - 10.10	CAVD	4	0,9	PZFR6R	5758		PZFR6R
Eos 1.6 FSI	1F7	1.6	85	05.06 - 05.08	BLF	4		ZFR6S-Q	6449		ZFR6S-Q
Eos 2.0 FSI	1F7	2.0	110	05.06 - 05.08	BVY	4		PZFR5N-11T	7742		PZFR5N-11T
Eos 2.0 FSI	1F7	2.0	110	05.06 - 05.08	BVZ	4	0,9	BKR6E	6962	28	LPG 1
Eos 2.0 TDI	1F7	2.0	103	05.06 - 05.08	BMM	4		Y-607AS	7560	50	
Eos 2.0 TDI	1F7	2.0	103	05.08 - 11.10	CBAB	4		Y-609AS	5849	49	
Eos 2.0 TSI	1F7	2.0	147	05.06 - 11.10	BWA	4	0,8	PFR7S8EG	1675		PFR8S8EG
Eos 2.0 TSI	1F7	2.0	147	11.07 - 11.10	CCTA	4	0,8	PFR7S8EG	1675		PFR8S8EG
Eos 2.0 TSI	1F7	2.0	147	05.08 - 11.10	BPY	4	0,8	PFR7S8EG	1675		PFR8S8EG
Eos 2.0 TSI	1F7	2.0	147	05.08 - 11.10	CAWB	4	0,8	PFR7S8EG	1675		PFR8S8EG
Eos 2.0 TSI	1F7	2.0	147	05.09 - 11.10	CCZA	4	0,8	PFR7S8EG	1675		PFR8S8EG
Eos 2.0 TSI	1F7	2.0	155	11.09 - 11.10	CCZB	4	0,8	PFR7S8EG	1675		PFR8S8EG

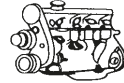
Code *l* kW

Cyl.



Stock-No.



LPG/CNG

**VW  
EOS 1**

Eos 3.2 V6	1F7	3.2	184	05.06 - 05.09	BUB	6	0,9	IZKR7B	7563		IZKR7B
Eos 3.2 V6	1F7	3.2	184	05.06 - 05.09	CBRA	6	0,9	IZKR7B	7563		IZKR7B
Eos 3.6 V6	1F7	3.6	191	05.09 - 10.10	CDVA	6	0,9	ILZKR7A	1961		ILZKR7A

**EOS 2**

Eos 1.4 TSI	1F8	1.4	90	11.10 -	CAXA	4	0,9	PZFR6R	5758		PZFR6R
Eos 1.4 TSI	1F8	1.4	118	11.10 -	CAVD	4	0,8	SIZFR6B8EG	96209		
Eos 2.0 TDI	1F8	2.0	100	11.10 -	CFHB	4	█	Y1002AS	8888	57	
Eos 2.0 TDI	1F8	2.0	100	11.10 -	CFFA	4	█	Y1002AS	8888	57	
Eos 2.0 TDI	1F8	2.0	103	11.10 -	CFFB	4	█	Y1002AS	8888	57	
Eos 2.0 TDI	1F8	2.0	103	11.10 -	CFHC	4	█	Y1002AS	8888	57	
Eos 2.0 TSI	1F8	2.0	155	11.10 -	CCZB	4	0,8	PFR7S8EG	1675		PFR8S8EG

**FOX**

Fox 1.2	5Z1	1.2	40	04.05 -	BMD	3	0,9	ZFR5P-G	6893		LPG 6
Fox 1.2	5Z1	1.2	40	04.05 -	CHFB	3	1,1	ZFR6T-11G	5960		
Fox 1.2	5Z1	1.2	44	09.10 -	CHFA	3	1,1	ZFR6T-11G	5960		
Fox 1.4	5Z1	1.4	55	04.05 -	BKR	4	1,1	PZFR5D-11	7968	34	LPG 6
Fox 1.4 TDI	5Z1	1.4	51	04.05 -	BNM	3	█	Y-741U	6943	20	

**GOLF 2**

Golf 2 1.3	19E / 1G1	1.3	40	08.89 - 07.92	NZ	4		BUR6ET	3172	1	LPG 2
Golf 2 1.3	19E / 1G1	1.3	40	01.89 - 07.92	2G	4		BUR6ET	3172	1	LPG 2
Golf 2 1.6 TD	19E / 1G1	1.6	44	08.89 - 07.92	1V	4	█	Y-918J	6285	2	
Golf 2 1.6	19E / 1G1	1.6	51	08.85 - 07.92	PN	4		BUR5ET-10	7264	21	LPG 2
Golf 2 1.6	19E / 1G1	1.6	53	07.91 - 07.92	ABX	4		BP5ET-10	5156		LPG 2
Golf 2 1.6	19E / 1G1	1.6	55	08.83 - 07.92	EW	4		BUR5ET-10	7264	21	LPG 2
Golf 2 1.6	19E / 1G1	1.6	55	08.86 - 07.92	ABN	4		BUR5ET-10	7264	21	LPG 2
Golf 2 1.8	19E / 1G1	1.8	66	08.83 - 07.93	EX	4		BUR6ET	3172	1	LPG 2
Golf 2 1.8	19E / 1G1	1.8	70	08.83 - 07.93	JH	4		BUR6ET	3172	1	LPG 2

**GOLF 3**

Golf 3 1.4	1H1 / 1H5	1.4	44	11.91 - 07.95	ABD	4		BUR5ET	3377	22	LPG 2
Golf 3 1.4	1H1 / 1H5	1.4	44	07.95 - 12.97	AEX	4		BUR6ET	3172	1	LPG 2
Golf 3 1.6	1H1 / 1H5	1.6	55	08.92 - 09.94	ABU	4		BUR6ET	3172	1	LPG 2
Golf 3 1.6	1H1 / 1H5	1.6	55	10.94 - 07.95	AEA	4		BUR6ET	3172	1	LPG 2
Golf 3 1.6	1H1 / 1H5	1.6	55	07.95 - 12.97	AEE	4		BUR6ET	3172	1	LPG 2
Golf 3 1.6	1H1 / 1H5	1.6	74	10.94 - 12.95	AEK	4		BKUR5ET	2789	29	LPG 1
Golf 3 1.6	1H1 / 1H5	1.6	74	01.96 - 10.00	AFT	4		BKUR6ET-10	2397	24	LPG 1
Golf 3 1.6	1H1 / 1H5	1.6	74	04.97 - 10.00	AKS	4		BKUR5ET	2789	29	LPG 1
Golf 3 1.8	1H1 / 1H5	1.8	55	07.91 - 10.00	AAM	4		BUR5ET	3377	22	LPG 2
Golf 3 1.8	1H1 / 1H5	1.8	55	12.97 - 10.00	ANN	4		BUR5ET	3377	22	LPG 2
Golf 3 1.8	1H1 / 1H5	1.8	66	12.97 - 10.00	ANP	4		BUR6ET	3172	1	LPG 2
Golf 3 1.8	1H1 / 1H5	1.8	66	11.91 - 07.95	ABS	4		BUR6ET	3172	1	LPG 2
Golf 3 1.8	1H1 / 1H5	1.8	66	08.91 - 12.97	ACC	4		BUR6ET	3172	1	LPG 2
Golf 3 1.8	1H1 / 1H5	1.8	66	10.94 - 10.00	ADZ	4		BUR6ET	3172	1	LPG 2
Golf 3 1.8	1H1 / 1H5	1.8	66	01.98 -	ADD	4		BUR6ET	3172	1	LPG 2
Golf 3 1.9 SDI	1H1 / 1H5	1.9	47	07.95 - 02.99	AEY	4	█	Y-732J	5605	4	
Golf 3 1.9 D	1H1 / 1H5	1.9	48	11.91 - 08.98	1Y	4	█	Y-918J	6285	2	
Golf 3 1.9 TD	1H1 / 1H5	1.9	55	11.91 - 08.98	AAZ	4	█	Y-918J	6285	2	
Golf 3 1.9 TDI	1H1 / 1H5	1.9	66	07.93 - 07.96	1Z	4	█	Y-732J	5605	4	
Golf 3 1.9 TDI	1H1 / 1H5	1.9	66	07.96 - 06.00	AHU	4	█	Y-732J	5605	4	
Golf 3 1.9 TDI	1H1 / 1H5	1.9	66	05.96 - 12.01	ALE	4	█	Y-732J	5605	4	

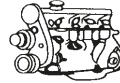
Code *ℓ* kW

Cyl.

Stock-No.  
**VW**LPG/CNG  
**VW****VW****GOLF 3**

Golf 3 1.9 TDI	1H1 / 1H5	1.9	81	02.96 - 08.99	AFN	4	☑	Y-732J	5605	4	
Golf 3 2.0 GUS	1H1 / 1H5	2.0	79	01.95 - 12.97	AEP	4		BUR6ET	3172	1	LPG 2
Golf 3 2.0 USA	1H1 / 1H5	2.0	85	03.92 - 07.95	ABA	4		BKR5EIX	6341		LPG 1
Golf 3 2.0	1H1 / 1H5	2.0	85	11.91 - 09.94	2E	4		BUR6ET	3172	1	LPG 2
Golf 3 2.0	1H1 / 1H5	2.0	85	10.94 - 05.96	ADY	4		BUR6ET	3172	1	LPG 2
Golf 3 2.0	1H1 / 1H5	2.0	85	07.95 - 12.01	AGG	4		BUR6ET	3172	1	LPG 2
Golf 3 2.0	1H1 / 1H5	2.0	85	04.97 - 04.00	AKR	4		BUR6ET	3172	1	LPG 2
Golf 3 2.0 USA	1H1 / 1H5	2.0	85	02.94 - 07.98	ADC	4		BKR5EIX	6341		LPG 1
Golf 3 2.0 GTI 16V	1H1 / 1H5	2.0	110	08.92 - 07.94	ABF	4		BKUR6ET-10	2397	24	LPG 1
Golf 3 2.8 VR6	1H1 / 1H5	2.8	128	01.92 - 06.95	AAA	6		BKR5EKU	3964		
Golf 3 2.8 VR6	1H1 / 1H5	2.8	128	07.95 - 12.97	AAA	6		BKR5EKUP	2890		
Golf 3 2.9 VR6 Synchro	1H1 / 1H5	2.9	140	10.94 - 12.97	ABV	6		BKR5EKU	3964		

**GOLF 4**

Golf 4 1.4	1J1 / 1J5	1.4	44	12.97 - 05.98	APQ	4		BUR6ET	3172	1	LPG 2
Golf 4 1.4	1J1 / 1J5	1.4	55	10.97 - 06.06	AHW	4		BKUR6ET-10	2397	24	LPG 1
Golf 4 1.4	1J1 / 1J5	1.4	55	10.97 - 05.00	AKQ	4		BKUR6ET-10	2397	24	LPG 1
Golf 4 1.4	1J1 / 1J5	1.4	55	05.99 - 05.00	APE	4		BKUR6ET-10	2397	24	LPG 1
Golf 4 1.4	1J1 / 1J5	1.4	55	10.01 - 06.06	BCA	4		BKUR6ET-10	2397	24	LPG 1
Golf 4 1.4 Automatic	1J1 / 1J5	1.4	55	05.00 - 10.01	AXP	4	1,1	PZFR5D-11	7968	34	LPG 6
Golf 4 1.4 Schaltgetriebe	1J1 / 1J5	1.4	55	05.00 - 10.01	AXP	4		BKUR6ET-10	2397	24	LPG 1
Golf 4 1.6 China	1J1 / 1J5	1.6	74	11.05 -	BJH	4	0,9	BKR6E	6962	28	LPG 1
Golf 4 1.6	1J1 / 1J5	1.6	74	10.97 - 05.03	AKL	4		BKUR6ET-10	2397	24	LPG 1
Golf 4 1.6	1J1 / 1J5	1.6	74	01.98 - 05.04	AEH	4		BKUR6ET-10	2397	24	LPG 1
Golf 4 1.6	1J1 / 1J5	1.6	74	05.99 - 08.00	APF	4		BKUR6ET-10	2397	24	LPG 1
Golf 4 1.6	1J1 / 1J5	1.6	74	09.00 - 04.02	AVU	4		BKUR6ET-10	2397	24	LPG 1
Golf 4 1.6	1J1 / 1J5	1.6	75	05.02 - 06.06	BFQ	4		BKUR6ET-10	2397	24	LPG 1
Golf 4 1.6	1J1 / 1J5	1.6	77	11.99 - 05.00	ATN	4		BKUR6ET-10	2397	24	LPG 1
Golf 4 1.6	1J1 / 1J5	1.6	77	05.00 - 10.00	AUS	4		BKUR6ET-10	2397	24	LPG 1
Golf 4 1.6	1J1 / 1J5	1.6	77	09.00 - 11.01	AZD	4	1,1	PZFR6J-11	3586		LPG 6
Golf 4 1.6	1J1 / 1J5	1.6	77	11.01 - 06.06	BCB	4	1,1	PZFR6J-11	3586		LPG 6
Golf 4 1.6 China	1J1 / 1J5	1.6	78	04 -	AWB	4	0,8	BKR5E	7938	35	LPG 1
Golf 4 1.6 FSI	1J1 / 1J5	1.6	81	08.01 - 06.06	BAD	4		ZFR6S-Q	6449		
Golf 4 1.6 FSI	1J1 / 1J5	1.6	85	10.03 - 07.04	BAG	4		ZFR6S-Q	6449		
Golf 4 1.8	1J1 / 1J5	1.8	92	07.98 - 10.00	AGN	4		BKUR6ET-10	2397	24	LPG 1
Golf 4 1.8 China	1J1 / 1J5	1.8	92	09.05 -	BAF	4		BKUR6ET-10	2397	24	LPG 1
Golf 4 1.8 T	1J1 / 1J5	1.8	110	05.99 - 04.01	ARZ	4	0,8	PFR6Q	6458	37	LPG 1
Golf 4 1.8 T	1J1 / 1J5	1.8	110	09.00 - 05.06	AUM	4	0,8	PFR6Q	6458	37	LPG 1
Golf 4 1.8 T USA	1J1 / 1J5	1.8	110	12.99 - 09.00	AWD	4	0,8	PFR6Q	6458	37	LPG 1
Golf 4 1.8 T GTI	1J1 / 1J5	1.8	110	10.97 - 05.03	AGU	4	0,8	PFR6Q	6458	37	LPG 1
Golf 4 1.8 T USA	1J1 / 1J5	1.8	110	08.00 -	AWW	4	0,8	PFR6Q	6458	37	LPG 1
Golf 4 1.8 T GTI	1J1 / 1J5	1.8	132	06.01 - 05.04	AUQ	4	0,8	PFR6Q	6458	37	LPG 1
Golf 4 1.9 SDI	1J1 / 1J5	1.9	50	10.97 - 04.01	AGP	4	☑	Y-732J	5605	4	
Golf 4 1.9 SDI	1J1 / 1J5	1.9	50	11.98 - 05.06	AQM	4	☑	Y-732J	5605	4	
Golf 4 1.9 TDI	1J1 / 1J5	1.9	66	10.97 - 09.02	AGR	4	☑	Y-732J	5605	4	
Golf 4 1.9 TDI	1J1 / 1J5	1.9	66	10.97 - 05.03	ALH	4	☑	Y-732J	5605	4	
Golf 4 1.9 TDI Fgst → 1J-2-600000	1J1 / 1J5	1.9	74	02.00 - 06.06	ATD	4	☑	Y-732J	5605	4	
Golf 4 1.9 TDI Fgst → 1J-2-600000	1J1 / 1J5	1.9	74	05.01 - 06.06	AXR	4	☑	Y-732J	5605	4	
Golf 4 1.9 TDI Fgst 1J-2-600001 →	1J1 / 1J5	1.9	74	02.00 - 06.06	ATD	4	☑	Y-741U	6943	20	
Golf 4 1.9 TDI Fgst 1J-2-600001 →	1J1 / 1J5	1.9	74	05.01 - 06.06	AXR	4	☑	Y-741U	6943	20	
Golf 4 1.9 TDI	1J1 / 1J5	1.9	81	10.97 - 05.06	AHF	4	☑	Y-732J	5605	4	

Fgst = Chassis No.

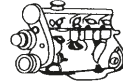

Code *l* kW

Cyl.

Stock-No.  
**V-FLINE**  
VW-FAW/FAW/FAW

LPG/CNG

**VW  
GOLF 4**

Golf 4 1.9 TDI	1J1 / 1J5	1.9	81	08.99 - 10.00	AVG	4	█	Y-732J	5605	4	
Golf 4 1.9 TDI	1J1 / 1J5	1.9	81	05.00 - 05.06	ASV	4	█	Y-732J	5605	4	
Golf 4 1.9 TDI	1J1 / 1J5	1.9	85	05.99 - 07.01	AJM	4	█	Y-732J	5605	4	
Golf 4 1.9 TDI	1J1 / 1J5	1.9	85	01.00 - 07.01	AUY	4	█	Y-732J	5605	4	
Golf 4 1.9 TDI Fgst → 1J-2-600000	1J1 / 1J5	1.9	96	04.01 - 05.06	ASZ	4	█	Y-732J	5605	4	
Golf 4 1.9 TDI Fgst 1J-2-600001 →	1J1 / 1J5	1.9	96	04.01 - 05.06	ASZ	4	█	Y-741U	6943	20	
Golf 4 1.9 TDI Fgst → 1J-2-60 0000	1J1 / 1J5	1.9	110	09.00 - 05.06	ARL	4	█	Y-732J	5605	4	
Golf 4 1.9 TDI Fgst 1J-2-600001 →	1J1 / 1J5	1.9	110	09.00 - 05.06	ARL	4	█	Y-741U	6943	20	
Golf 4 2.0	1J1 / 1J5	2.0	85	08.98 - 05.03	APK	4		BKUR6ET-10	2397	24	LPG 1
Golf 4 2.0	1J1 / 1J5	2.0	85	08.98 - 06.06	AQY	4		BKUR6ET-10	2397	24	LPG 1
Golf 4 2.0	1J1 / 1J5	2.0	85	06.99 - 06.00	ATU	4	0,8	PFR6Q	6458	37	LPG 1
Golf 4 2.0	1J1 / 1J5	2.0	85	04.00 - 06.01	AZH	4		BKUR6ET-10	2397	24	LPG 1
Golf 4 2.0	1J1 / 1J5	2.0	85	05.01 - 04.02	AZG	4	1,1	PZFR5D-11	7968	34	LPG 6
Golf 4 2.0	1J1 / 1J5	2.0	85	05.01 - 06.06	AZJ	4	1,1	PZFR5D-11	7968	34	LPG 6
Golf 4 2.0	1J1 / 1J5	2.0	85	05.02 - 06.06	BEH	4	1,1	PZFR5D-11	7968	34	LPG 6
Golf 4 2.0 USA	1J1 / 1J5	2.0	85	06.98 -	AEG	4		BKUR6ET-10	2397	24	LPG 1
Golf 4 2.0 Cabrio	1J1 / 1J5	2.0	85	06.00 - 06.02	AWF	4	0,8	PFR6Q	6458	37	LPG 1
Golf 4 2.0 Cabrio	1J1 / 1J5	2.0	85	06.00 - 06.02	AWG	4	0,8	PFR6Q	6458	37	LPG 1
Golf 4 2.3 V5	1J1 / 1J5	2.3	110	10.97 - 02.01	AGZ	5		BKR5EKUP	2890		
Golf 4 2.3 V5	1J1 / 1J5	2.3	125	09.00 - 05.06	AQN	5	1,1	PZFR5D-11	7968	34	LPG 6
Golf 4 2.8 V6 USA	1J1 / 1J5	2.8	130	03.98 - 05.00	AFP	6		BKR5EKUP	2890		
Golf 4 2.8 V6	1J1 / 1J5	2.8	150	05.01 - 06.05	BDE	6	1,1	PZFR5D-11	7968	34	LPG 6
Golf 4 2.8 V6	1J1 / 1J5	2.8	150	05.99 - 05.00	AQP	6	1,1	PZFR5D-11	7968	34	LPG 6
Golf 4 2.8 V6	1J1 / 1J5	2.8	150	01.00 - 04.01	AUE	6	1,1	PZFR5D-11	7968	34	LPG 6
Golf 4 3.2 V6 R32	1J1 / 1J5	3.2	177	06.02 - 05.04	BFH	6	0,9	IZKR7B	7563		
Golf 4 3.2 V6 R32	1J1 / 1J5	3.2	177	11.03 - 06.06	BML	6	0,9	IZKR7B	7563		

**GOLF 5**

Golf 5 1.4	1K1/1K5	1.4	55	01.05 - 05.06	BCA	4		BKUR6ET-10	2397	24	LPG 1
Golf 5 1.4	1K1/1K5	1.4	59	05.06 - 11.08	BUD	4	1,1	ZFR6T-11G	5960		
Golf 5 1.4 FSI	1K1/1K5	1.4	66	10.03 - 12.04	BKG	4		ZFR6S-Q	6449		
Golf 5 1.4 FSI	1K1/1K5	1.4	66	11.04 - 07.06	BLN	4		ZFR6S-Q	6449		
Golf 5 1.4 TSI	1K1/1K5	1.4	90	07.07 - 11.08	CAXA	4	0,9	PZFR6R	5758		
Golf 5 1.4 TSI	1K1/1K5	1.4	103	05.06 - 05.07	BMV	4	0,9	PZFR6R	5758		
Golf 5 1.4 TSI GT	1K1/1K5	1.4	125	11.05 - 11.08	BLG	4	0,9	PZFR6R	5758		
Golf 5 1.6	1K1/1K5	1.6	75	01.04 - 06.05	BGU	4		BKUR6ET-10	2397	24	LPG 1
Golf 5 1.6	1K1/1K5	1.6	75	05.05 - 11.08	BSE	4		BKUR6ET-10	2397	24	LPG 1
Golf 5 1.6	1K1/1K5	1.6	75	05.05 - 11.08	BSF	4		BKUR6ET-10	2397	24	LPG 1
Golf 5 1.6	1K1/1K5	1.6	75	11.07 - 12.08	CCSA	4		BKUR6ET-10	2397	24	LPG 1
Golf 5 1.6 FSI	1K1/1K5	1.6	85	10.03 - 07.04	BAG	4		ZFR6S-Q	6449		
Golf 5 1.6 FSI	1K1/1K5	1.6	85	05.04 - 07.05	BLP	4		ZFR6S-Q	6449		
Golf 5 1.6 FSI	1K1/1K5	1.6	85	01.05 - 01.09	BLF	4		ZFR6S-Q	6449		
Golf 5 1.9 TDI	1K1/1K5	1.9	66	05.04 - 02.06	BRU	4	█	Y-607AS	7560	50	
Golf 5 1.9 TDI	1K1/1K5	1.9	66	02.06 - 01.09	BXF	4	█	Y-607AS	7560	50	
Golf 5 1.9 TDI	1K1/1K5	1.9	66	05.07 - 01.09	BXJ	4	█	Y-607AS	7560	50	
Golf 5 1.9 TDI	1K1/1K5	1.9	77	10.03 - 05.06	BKC	4	█	Y-607AS	7560	50	
Golf 5 1.9 TDI	1K1/1K5	1.9	77	02.06 - 11.08	BXE	4	█	Y-607AS	7560	50	
Golf 5 1.9 TDI only with DPF	1K1/1K5	1.9	77	06.05 - 05.07	BLS	4	█	CZ104	9826	52	
Golf 5 1.9 TDI without DPF	1K1/1K5	1.9	77	06.05 - 05.07	BLS	4	█	Y-607AS	7560	50	
Golf 5 2.0 SDI	1K1/1K5	2.0	55	01.04 - 05.07	BDK	4	█	Y-607AS	7560	50	
Golf 5 2.0 TDI	1K1/1K5	2.0	100	10.03 - 05.07	AZV	4	█	YE14	7768	48	

Fgst = Chassis No.

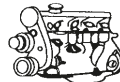
Code *l* kW

Cyl.



Stock-No.



LPG/CNG

VW

**GOLF 5**

Golf 5 2.0 TDI	1K1/1K5	2.0	100	10.08 - 11.09	CBAA	4	☑	Y1002AS	8888	57	
Golf 5 2.0 TDI	1K1/1K5	2.0	100	07.08 - 11.08	CBDA	4	☑	Y1002AS	8888	57	
Golf 5 2.0 TDI	1K1/1K5	2.0	103	10.03 - 05.07	BKD	4	☑	YE14	7768	48	
Golf 5 2.0 TDI	1K1/1K5	2.0	103	12.04 - 11.08	BMM	4	☑	Y-607AS	7560	50	
Golf 5 2.0 TDI	1K1/1K5	2.0	103	02.08 -	CBDB	4	☑	Y1002AS	8888	57	
Golf 5 2.0 FSI	1K1/1K5	2.0	110	10.03 - 05.04	AXW	4		PZFR5N-11T	7742		
Golf 5 2.0 FSI	1K1/1K5	2.0	110	05.04 - 07.07	BLX	4		PZFR5N-11T	7742		
Golf 5 2.0 FSI	1K1/1K5	2.0	110	05.04 - 07.07	BLY	4	0,9	BKR6E	6962	28	LPG 1
Golf 5 2.0 FSI	1K1/1K5	2.0	110	01.05 - 07.07	BLR	4		PZFR5N-11T	7742		
Golf 5 2.0 FSI	1K1/1K5	2.0	110	11.05 - 11.08	BVX	4		PZFR5N-11T	7742		
Golf 5 2.0 FSI	1K1/1K5	2.0	110	05.05 - 11.08	BVY	4		PZFR5N-11T	7742		
Golf 5 2.0 FSI	1K1/1K5	2.0	110	11.05 - 11.08	BVZ	4	0,9	BKR6E	6962	28	LPG 1
Golf 5 2.0 TDI	1K1/1K5	2.0	125	11.05 - 11.08	BMN	4	☑	CZ304	9864	55	
Golf 5 GTI	1K1	2.0	147	09.04 - 01.06	AXX	4	0,8	PFR7S8EG	1675		PFR8S8EG
Golf 5 GTI	1K1	2.0	147	11.05 - 02.09	BWA	4	0,8	PFR7S8EG	1675		PFR8S8EG
Golf 5 GTI	1K1	2.0	147	03.08 - 02.09	CAWB	4	0,8	PFR7S8EG	1675		PFR8S8EG
Golf 5 GTI	1K1	2.0	169	09.06 - 11.08	BYD	4	0,8	PFR7S8EG	1675		PFR8S8EG
Golf 5 R32	1K1	3.2	184	05.05 - 11.08	BUB	6	0,9	IZKR7B	7563		

**GOLF 6**

Golf 6 1.2 TSI	5K1/AJ5	1.2	63	05.10 - 11.12	CBZA	4	0,7	IZFR6P7	97153		
Golf 6 1.2 TSI	5K1/AJ5	1.2	77	05.09 - 11.12	CBZB	4	0,7	IZFR6P7	97153		
Golf 6 1.4	5K1/AJ5	1.4	59	01.09 - 11.12	CGGA	4	1,1	ZFR6T-11G	5960		
Golf 6 1.4 TSI	5K1/AJ5	1.4	90	05.08 - 11.12	CAXA	4	0,9	PZFR6R	5758		
Golf 6 1.4 TSI	5K1/AJ5	1.4	118	07.08 - 11.12	CAVD	4	0,8	SIZFR6B8EG	96209		
Golf 6 1.4 TSI	5K1/AJ5	1.4	118	10.08 - 11.12	CNWA	4	0,8	SIZFR6B8EG	96209		
Golf 6 1.4 TSI	5K1/AJ5	1.4	118	10.08 - 11.12	CTHD	4	0,8	SIZFR6B8EG	96209		
Golf 6 1.6	5K1/AJ5	1.6	75	11.08 - 11.12	CCSA	4		BKUR6ET-10	2397	24	LPG 1
Golf 6 1.6 BiFuel (LPG)	5K1/AJ5	1.6	75	03.09 - 11.12	CHGA	4		BKUR6ET-10	2397	24	LPG 1
Golf 6 1.6	5K1/AJ5	1.6	75	05.10 - 11.12	CMXA	4		BKUR6ET-10	2397	24	LPG 1
Golf 6 1.6 TDI	5K1/AJ5	1.6	66	12.08 - 11.12	CAYB	4	☑	Y1002AS	8888	57	
Golf 6 1.6 TDI	5K1/AJ5	1.6	77	02.09 - 11.12	CAYC	4	☑	Y1002AS	8888	57	
Golf 6 1.8 TSI	5K1	1.8	118	06.09 - 01.11	CDAA	4	0,8	PFR7S8EG	1675		PFR8S8EG
Golf 6 2.0 TDI	5K1/AJ5	2.0	81	10.08 - 11.12	CBDC	4	☑	Y1002AS	8888	57	
Golf 6 2.0 TDI	5K1/AJ5	2.0	100	10.08 - 11.12	CBAA	4	☑	Y1002AS	8888	57	
Golf 6 2.0 TDI	5K1/AJ5	2.0	100	10.08 - 11.12	CFFA	4	☑	Y1002AS	8888	57	
Golf 6 2.0 TDI	5K1/AJ5	2.0	103	10.08 - 11.12	CFFB	4	☑	Y1002AS	8888	57	
Golf 6 2.0 TDI	5K1/AJ5	2.0	103	10.08 - 11.12	CBAB	4	☑	Y1002AS	8888	57	
Golf 6 2.0 TDI	AJ5	2.0	103	11.09 -	CFHC	4	☑	Y1002AS	8888	57	
Golf 6 2.0 TDI GTD	5K1	2.0	125	04.09 - 11.09	CBBB	4	☑	Y1002AS	8888	57	
Golf 6 2.0 TDI GTD	5K1	2.0	125	05.10 - 11.12	CFGB	4	☑	Y1002AS	8888	57	
Golf 6 2.0 GTI	5K1	2.0	155	04.09 - 11.12	CCZB	4	0,8	PFR7S8EG	1675		PFR8S8EG
Golf 6 2.0 GTI	5K1	2.0	173	05.11 - 11.12	CDLG	4	0,8	PFR7S8EG	1675		PFR8S8EG
Golf 6 2.0 TSI R 4motion	5K1	2.0	188	11.09 - 11.12	CDLC	4	0,8	PFR7S8EG	1675		PFR8S8EG
Golf 6 2.0 TSI R 4motion	5K1	2.0	199	11.09 -	CDLF	4	0,8	PFR7S8EG	1675		PFR8S8EG
Golf 6 Cabriolet 1.2 TSI	517	1.2	77	03.11 -	CBZB	4	0,7	IZFR6P7	97153		
Golf 6 Cabriolet 1.4 TSI	517	1.4	90	06.11 -	CAXA	4	0,9	PZFR6R	5758		
Golf 6 Cabriolet 1.4 TSI	517	1.4	118	03.11 -	CAVD	4	0,8	SIZFR6B8EG	96209		
Golf 6 Cabriolet 1.6 TDI	517	1.6	77	03.11 -	CAYC	4	☑	Y1002AS	8888	57	
Golf 6 Cabriolet 2.0 TDI	517	2.0	103	11.11 -	CFHC	4	☑	Y1002AS	8888	57	
Golf 6 Cabriolet 2.0 TSI GTI	517	2.0	155	06.11 -	CCZB	4	0,8	PFR7S8EG	1675		PFR8S8EG

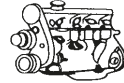
Code *l* kW

Cyl.

Stock-No.  
**VLINE**  
RE-PROGRAMMIERBAR

LPG/CNG

**VW  
GOLF 7**

Golf 7 1.2 TSI	5G1	1.2	63	08.12 -	CJZB	4	0,8	PZKER7A8EGS	94968		
Golf 7 1.2 TSI	5G1	1.2	77	08.12 -	CJZA	4	0,8	PZKER7A8EGS	94968		
Golf 7 1.4 TGI CNG	5G1	1.4	81	06.13 -	CPWA	4	0,8	PZKER7A8EGS	94968		
Golf 7 1.4 TSI	5G1	1.4	90	11.12 -	CMBA	4	0,8	PZKER7A8EGS	94968		
Golf 7 1.4 TSI	5G1	1.4	103	08.12 -	CHPA	4	0,8	PZKER7A8EGS	94968		
Golf 7 1.4 TSI	5G1	1.4	103	08.12 -	CPTA	4	0,8	PZKER7A8EGS	94968		
Golf 7 1.6 TDI	5G1	1.6	66	04.13 -	CLHB	4		Y1002AS	8888	57	
nur für Zylinder ohne Drucksensor											
Golf 7 1.6 TDI	5G1	1.6	66	04.13 -	CRKA	4		Y1002AS	8888	57	
nur für Zylinder ohne Drucksensor											
Golf 7 1.6 TDI	5G1	1.6	66	04.13 -	CXXA	4		Y1002AS	8888	57	
nur für Zylinder ohne Drucksensor											
Golf 7 1.6 TDI	5G1	1.6	77	08.12 -	CLHA	4		Y1002AS	8888	57	
nur für Zylinder ohne Drucksensor											
Golf 7 1.6 TDI	5G1	1.6	81	01.13 -	CRKB	4		Y1002AS	8888	57	
nur für Zylinder ohne Drucksensor											
Golf 7 1.6 TDI	5G1	1.6	81	05.13 -	CXXB	4		Y1002AS	8888	57	
nur für Zylinder ohne Drucksensor											
Golf 7 2.0 TDI	5G1	2.0	110	08.12 -	CRBC	4		Y1002AS	8888	57	
nur für Zylinder ohne Drucksensor											
Golf 7 2.0 TDI	5G1	2.0	110	08.12 -	CRLB	4		Y1002AS	8888	57	
nur für Zylinder ohne Drucksensor											
Golf 7 2.0 GTD	5G1	2.0	135	04.13 -	CUNA	4		Y1002AS	8888	57	
nur für Zylinder ohne Drucksensor											

**GOLF PLUS**

Golf Plus 1.2 TSI	5M1	1.2	63	05.10 -	CBZA	4	0,7	IZFR6P7	97153		
Golf Plus 1.2 TSI	5M1	1.2	77	11.09 -	CBZB	4	0,7	IZFR6P7	97153		
Golf Plus 1.4	5M1	1.4	55	01.05 - 05.06	BCA	4		BKUR6ET-10	2397	24	LPG 1
Golf Plus 1.4	5M1	1.4	59	05.06 -	BUD	4	1,1	ZFR6T-11G	5960		
Golf Plus 1.4	5M1	1.4	59	10.08 -	CGGA	4	1,1	ZFR6T-11G	5960		
Golf Plus 1.4 FSI	5M1	1.4	66	07.05 - 05.06	BLN	4		ZFR6S-Q	6449		
Golf Plus 1.4 TSI	5M1	1.4	90	07.07 -	CAXA	4	0,9	PZFR6R	5758		
Golf Plus 1.4 TSI	5M1	1.4	103	05.06 - 06.08	BMY	4	0,9	PZFR6R	5758		
Golf Plus 1.4 TSI	5M1	1.4	118	05.08 - 12.08	CAVD	4	0,8	SIZFR6B8EG	96209		
Golf Plus 1.4 TSI	5M1	1.4	125	05.06 - 06.08	BLG	4	0,9	PZFR6R	5758		
Golf Plus 1.6 TDI	5M1	1.6	66	05.09 -	CAYB	4		Y1002AS	8888	57	
Golf Plus 1.6	5M1	1.6	75	05.05 - 12.08	BSE	4		BKUR6ET-10	2397	24	LPG 1
Golf Plus 1.6	5M1	1.6	75	05.05 - 12.08	BSF	4		BKUR6ET-10	2397	24	LPG 1
Golf Plus 1.6	5M1	1.6	75	11.07 - 12.08	CCSA	4		BKUR6ET-10	2397	24	LPG 1
Golf Plus 1.6 BiFuel (LPG)	5M1	1.6	75	05.09 -	CHGA	4		BKUR6ET-10	2397	24	LPG 1
Golf Plus 1.6 TDI	5M1	1.6	77	02.09 -	CAYC	4		Y1002AS	8888	57	
Golf Plus 1.6 FSI	5M1	1.6	85	01.05 - 05.08	BLF	4		ZFR6S-Q	6449		
Golf Plus 1.9 TDI	5M1	1.9	66	05.05 - 02.06	BRU	4		Y-607AS	7560	50	
Golf Plus 1.9 TDI	5M1	1.9	66	02.06 - 12.08	BXF	4		Y-607AS	7560	50	
Golf Plus 1.9 TDI	5M1	1.9	66	05.07 - 12.08	BXJ	4		Y-607AS	7560	50	
Golf Plus 1.9 TDI	5M1	1.9	77	01.05 - 05.06	BKC	4		Y-607AS	7560	50	
Golf Plus 1.9 TDI only with DPF	5M1	1.9	77	06.05 - 05.07	BLS	4		CZ104	9826	52	
Golf Plus 1.9 TDI without DPF	5M1	1.9	77	06.05 - 05.07	BLS	4		Y-607AS	7560	50	
Golf Plus 1.9 TDI	5M1	1.9	77	02.06 - 01.09	BXE	4		Y-607AS	7560	50	
Golf Plus 2.0 TDI	5M1	2.0	81	03.09 - 05.11	CBDC	4		Y1002AS	8888	57	

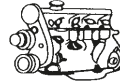
Code *l* kW

Cyl.

Stock-No.  
**V-TIME**  
**TDI-POWER**

LPG/CNG

**VW****GOLF PLUS**

Golf Plus 2.0 TDI	5M1	2.0	81	03.09 - 05.11	CLCA	4	☑	Y1002AS	8888	57	
Golf Plus 2.0 TDI	5M1	2.0	100	05.05 - 05.07	AZV	4	☑	YE14	7768	48	
Golf Plus 2.0 TDI	5M1	2.0	100	01.09 -	CBDA	4	☑	Y1002AS	8888	57	
Golf Plus 2.0 TDI	5M1	2.0	100	01.09 -	CFHB	4	☑	Y1002AS	8888	57	
Golf Plus 2.0 TDI	5M1	2.0	103	10.03 - 01.05	BKD	4	☑	YE14	7768	48	
Golf Plus 2.0 TDI	5M1	2.0	103	12.05 - 05.09	BMM	4	☑	Y-607AS	7560	50	
Golf Plus 2.0 TDI	5M1	2.0	103	10.08 -	CBDB	4	☑	Y1002AS	8888	57	
Golf Plus 2.0 TDI	5M1	2.0	103	10.08 -	CFHC	4	☑	Y1002AS	8888	57	
Golf Plus 2.0 FSI	5M1	2.0	110	05.05 - 07.07	BLR	4		PZFR5N-11T	7742		
Golf Plus 2.0 FSI	5M1	2.0	110	05.05 - 07.07	BLY	4	0,9	BKR6E	6962	28	LPG 1
Golf Plus 2.0 FSI	5M1	2.0	110	05.05 - 06.08	BVY	4		PZFR5N-11T	7742		
Golf Plus 2.0 FSI	5M1	2.0	110	05.05 - 06.08	BVZ	4	0,9	BKR6E	6962	28	LPG 1

**JETTA 2**

Jetta 2 1.3	19E / 1G2	1.3	40	06.87 - 12.91	2G	4		BUR6ET	3172	1	LPG 2
Jetta 2 1.3	19E / 1G2	1.3	40	06.87 - 12.91	MH	4		BUR6ET	3172	1	LPG 2
Jetta 2 1.3	19E / 1G2	1.3	40	06.87 - 12.91	NZ	4		BUR6ET	3172	1	LPG 2
Jetta 2 1.6 D	19E / 1G2	1.6	40	01.84 - 10.91	JP	4	☑	Y-918J	6285	2	
Jetta 2 1.6 TD	19E / 1G2	1.6	44	01.90 - 10.91	1V	4	☑	Y-918J	6285	2	
Jetta 2 1.6	19E / 1G2	1.6	51	10.86 - 10.91	PN	4		BUR5ET-10	7264	21	LPG 2
Jetta 2 1.6	19E / 1G2	1.6	53	03.86 - 10.91	RF	4		BUR5ET-10	7264	21	LPG 2
Jetta 2 1.6	19E / 1G2	1.6	55	01.84 - 07.92	EZ	4		BUR5ET-10	7264	21	LPG 2
Jetta 2 1.6	19E / 1G2	1.6	55	01.86 - 07.92	ABN	4		BUR5ET-10	7264	21	LPG 2
Jetta 2 1.6 TD	19E / 1G2	1.6	59	08.89 - 10.91	SB	4	☑	Y-918J	6285	2	
Jetta 2 1.8	19E / 1G2	1.8	66	08.84 - 10.91	GU	4		BUR6ET	3172	1	LPG 2
Jetta 2 1.8	19E / 1G2	1.8	66	08.87 - 10.91	RP	4		BUR6ET	3172	1	LPG 2
Jetta 2 1.8 Synchro	19E / 1G2	1.8	72	08.88 - 07.91	1P	4		BUR6ET	3172	1	LPG 2
Jetta 2 1.8	19E / 1G2	1.8	79	01.87 - 10.91	PF	4		BUR6ET	3172	1	LPG 2
Jetta 2 1.8	19E / 1G2	1.8	82	01.84 - 10.91	PB	4		BUR6ET	3172	1	LPG 2
Jetta 2 1.8 16V	19E / 1G2	1.8	95	08.86 - 10.91	PL	4		BKUR7ET	7873		PFR7Q
Jetta 2 1.8 16V	19E / 1G2	1.8	102	06.87 - 12.89	KR	4		BCPR7ET	2164		BCPR7EIX

**JETTA 3**

Jetta 3 1.4 TSI	1K2	1.4	90	07.07 - 10.10	CAXA	4	0,9	PZFR6R	5758		
Jetta 3 1.4 TSI	1K2	1.4	103	07.06 - 06.08	BMV	4	0,9	PZFR6R	5758		
Jetta 3 1.4 TSI	1K2	1.4	118	07.08 - 10.10	CAVD	4	0,9	PZFR6R	5758		
Jetta 3 1.4 TSI	1K2	1.4	125	07.06 - 06.08	BLG	4	0,9	PZFR6R	5758		
Jetta 3 1.6	1K2	1.6	75	08.05 - 10.10	BSE	4		BKUR6ET-10	2397	24	LPG 1
Jetta 3 1.6	1K2	1.6	75	10.05 - 10.10	BSF	4		BKUR6ET-10	2397	24	LPG 1
Jetta 3 1.6 FSI	1K2	1.6	85	09.05 - 06.08	BLF	4		ZFR6S-Q	6449		
Jetta 3 1.9 TDI	1K2	1.9	77	08.05 - 02.06	BKC	4	☑	Y-607AS	7560	50	
Jetta 3 1.9 TDI	1K2	1.9	77	08.05 -	BLS	4	☑	CZ104	9826	52	
Jetta 3 1.9 TDI	1K2	1.9	77	09.05 -	BXE	4	☑	Y-607AS	7560	50	
Jetta 3 1.9 TDI (USA)	1K2	1.9	74	01.05 -	BRM	4	☑	CZ104	9826	52	
Jetta 3 2.0 FSI	1K2	2.0	110	08.05 - 11.05	BLR	4		PZFR5N-11T	7742		
Jetta 3 2.0 FSI	1K2	2.0	110	10.05 - 11.05	BLY	4	0,9	BKR6E	6962	28	LPG 1
Jetta 3 2.0 FSI	1K2	2.0	110	12.05 - 06.08	BVY	4		PZFR5N-11T	7742		
Jetta 3 2.0 FSI	1K2	2.0	110	12.05 - 06.08	BVZ	4	0,9	BKR6E	6962	28	LPG 1
Jetta 3 2.0 TDI	1K2	2.0	100	09.05 -	AZV	4	☑	YE14	7768	48	
Jetta 3 2.0 TDI	1K2	2.0	103	08.05 - 06.08	BKD	4	☑	YE14	7768	48	
Jetta 3 2.0 TDI	1K2	2.0	103	10.05 - 06.08	BMM	4	☑	Y-607AS	7560	50	
Jetta 3 2.0 TDI	1K2	2.0	125	06.06 - 06.08	BMN	4	☑	CZ304	9864	55	

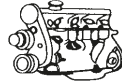
Code *l* kW

Cyl.

Stock-No.  
**VLINE**  
ID-PROFIT/VER\*\*

LPG/CNG

**VW  
JETTA 3**

Jetta 3 2.0 TSI	1K2	2.0	147	09.05 - 10.10	BPY	4	0,8	PFR7S8EG	1675		PFR8S8EG
Jetta 3 2.0 TSI	1K2	2.0	147	09.05 - 10.10	BWA	4	0,8	PFR7S8EG	1675		PFR8S8EG
Jetta 3 2.0 TSI	1K2	2.0	147	09.05 - 10.10	CAWB	4	0,8	PFR7S8EG	1675		PFR8S8EG
Jetta 3 2.0 TSI	1K2	2.0	147	09.05 - 10.10	CBFA	4	0,8	PFR7S8EG	1675		PFR8S8EG
Jetta 3 2.5	1K2	2.5	125	07.07 -	CCCA	5	1,1	ZFR6T-11G	5960		

**JETTA 4**

Jetta 4 1.2 TSI	162	1.2	77	02.11 -	CBZB	4	0,7	IZFR6P7	97153		
Jetta 4 1.4 TSI	162	1.4	90	05.11 -	CAXA	4	0,9	PZFR6R	5758		
Jetta 4 1.4 TSI	162	1.4	90	05.11 -	CMSB	4	0,9	PZFR6R	5758		
Jetta 4 1.4 TSI Hybrid	162	1.4	110	07.12 -	CNLA	4	0,8	PZKER7A8EGS	94968		
Jetta 4 1.4 TSI	162	1.4	118	02.11 -	CAVA	4	0,8	SIZFR6B8EG	96209		
Jetta 4 1.4 TSI	162	1.4	118	02.11 -	CAVD	4	0,8	SIZFR6B8EG	96209		
Jetta 4 1.6 TDI	162	1.6	77	02.11 -	CAYC	4		Y1002AS	8888	57	
Jetta 4 2.0 TDI	162	2.0	103	02.11 -	CFFB	4		Y1002AS	8888	57	
Jetta 4 2.0 TDI	162	2.0	103	02.11 -	CLCB	4		Y1002AS	8888	57	
Jetta 4 2.0 TSI	162	2.0	147	02.11 -	CBFA	4	0,8	PFR7S8EG	1675		PFR8S8EG
Jetta 4 2.0 TSI	162	2.0	147	02.11 -	CCTA	4	0,8	PFR7S8EG	1675		PFR8S8EG
Jetta 4 2.0 TSI	162	2.0	147	02.11 -	CCZA	4	0,8	PFR7S8EG	1675		PFR8S8EG

**KÄFER**

Käfer (MEXICO IMPORT)		1.6	34	01.93 -	ACD	4	0,8	BP5ESA	2285		
-----------------------	--	-----	----	---------	-----	---	-----	--------	------	--	--

**LT**

LT		2.3	105	05.96 - 11.01	AGL	4		BKUR5ET	2789	29	LPG 1
LT		2.4	51	08.92 - 12.95	ACT	6		Y-918J	6285	2	
LT		2.4	51	08.89 - 03.96		5		Y-918J	6285	2	
LT		2.4	66	08.82 - 07.92	DL	6	0,7	BP6ESZ	7639		LPG 2
LT		2.4	70	08.88 - 12.95	1E	6	0,7	BP6ESZ	7639		LPG 2
LT		2.5	65	04.06 -	BJJ	5		CZ104	9826	52	
LT TD		2.4	55	12.82 - 07.92	DW	6		Y-918J	6285	2	
LT TD		2.4	68	12.82 - 03.96		5		Y-918J	6285	2	
LT TD		2.4	70	08.91 - 12.95	ACL	6		Y-918J	6285	2	
LT TD		2.4	75	12.82 - 07.92	DV	6		Y-918J	6285	2	
LT TD 4X4		2.4	55	09.85 - 03.96		5		Y-918J	6285	2	
LT TDI		2.5	61	04.01 - 07.06	BBE	5		Y-732J	5605	4	
LT TDI		2.5	66	05.99 - 04.01	APA	5		Y-732J	5605	4	
LT TDI		2.5	70	04.01 - 07.06	BBF	5		Y-732J	5605	4	
LT TDI		2.5	75	05.96 - 05.99	AHD	5		Y-732J	5605	4	
LT TDI		2.5	80	05.99 - 07.06	ANJ	5		Y-732J	5605	4	
LT TDI		2.5	80	12.02 - 07.06	AVR	5		Y-732J	5605	4	
LT 28 D		2.4	51	08.88 - 12.95	1S	6		Y-918J	6285	2	
LT 28 D TD		2.4	68	12.82 -		6		Y-918J	6285	2	
LT 28 SDI		2.5	55	05.96 -		5		Y-732J	5605	4	
LT 28 TDi		2.8	92	05.96 -		6		Y-732J	5605	4	
LT 31 D		2.4	51	08.88 - 12.95	1S	6		Y-918J	6285	2	
LT 31 D TD		2.4	68	12.82 -		6		Y-918J	6285	2	
LT 35 SDI		2.5	55	05.96 - 04.01	AGX	5		Y-732J	5605	4	
LT 35 TDi		2.8	92	05.96 -		5		Y-732J	5605	4	
LT 40 D		2.4	51	08.88 - 12.95	1S	6		Y-918J	6285	2	
LT 40 D / TD 4X4		2.4	55	09.85 -		4		Y-918J	6285	2	
LT 40 D TD		2.4	68	12.82 -		4		Y-918J	6285	2	
LT 45 D / TD		2.4	55	09.85 -		4		Y-918J	6285	2	



Code *l* kW

Cyl.



Stock-No.



LPG/CNG

VW

**LT**

LT TDI		2.5	80	04.06 -	BJK	5		CZ104	9826	52	
LT TDI		2.5	100	04.06 -	BJL	5		CZ104	9826	52	
LT TDI		2.5	120	04.06 -	BJM	5		CZ104	9826	52	

**LUPO**

Lupo 1.0	6X1/6E1	1.0	37	10.98 - 05.00	AHT	4		BKR6ETA-10	7998		
Lupo 1.0	6X1/6E1	1.0	37	10.98 - 05.00	ALL	4		BUR6ET	3172	1	LPG 2
Lupo 1.0	6X1/6E1	1.0	37	01.99 - 05.00	AER	4		BUR6ET	3172	1	LPG 2
Lupo 1.0	6X1/6E1	1.0	37	05.99 - 07.05	ALD	4	0,9	ZFR5P-G	6893		LPG 6
Lupo 1.0	6X1/6E1	1.0	37	05.99 - 05.00	ANV	4	0,9	ZFR5P-G	6893		LPG 6
Lupo 1.0	6X1/6E1	1.0	37	05.00 - 07.05	AUC	4	0,9	ZFR5P-G	6893		LPG 6
Lupo 1.2 TDI 3L	6X1/6E1	1.2	45	06.99 - 11.00	ANY	3		Y-732J	5605	4	
Lupo 1.2 TDI 3L >6x-2-005 000	6X1/6E1	1.2	45	11.00 - 07.05	AYZ	3		Y-732J	5605	4	
Lupo 1.2 TDI 3L 6x-2-005 001>	6X1/6E1	1.2	45	11.00 - 07.05	AYZ	3		Y-741U	6943	20	
Lupo 1.4	6X1/6E1	1.4	44	09.00 - 07.05	AUD	4	0,9	ZFR5P-G	6893		LPG 6
Lupo 1.4	6X1/6E1	1.4	55	07.98 - 05.99	AKQ	4		BKUR6ET-10	2397	24	LPG 1
Lupo 1.4	6X1/6E1	1.4	55	01.99 - 07.05	AHW	4		BKUR6ET-10	2397	24	LPG 1
Lupo 1.4	6X1/6E1	1.4	55	05.99 - 09.00	APE	4		BKUR6ET-10	2397	24	LPG 1
Lupo 1.4	6X1/6E1	1.4	55	05.00 - 04.02	AUA	4		BKUR6ET-10	2397	24	LPG 1
Lupo 1.4	6X1/6E1	1.4	55	04.02 - 07.05	BBY	4		BKUR6ET-10	2397	24	LPG 1
Lupo 1.4	6X1/6E1	1.4	74	05.99 - 10.00	AFK	4		BKUR6ET-10	2397	24	LPG 1
Lupo 1.4	6X1/6E1	1.4	74	05.99 - 05.00	ANM	4		BKUR6ET-10	2397	24	LPG 1
Lupo 1.4	6X1/6E1	1.4	74	05.99 - 05.00	AQQ	4		BKUR6ET-10	2397	24	LPG 1
Lupo 1.4	6X1/6E1	1.4	74	05.00 - 07.05	AUB	4		BKUR6ET-10	2397	24	LPG 1
Lupo 1.4 FSI	6X1/6E1	1.4	77	09.00 - 11.03	ARR	4		ZFR6S-Q	6449		
Lupo 1.4 TDI Fgst >6x-2-005 000	6X1/6E1	1.4	55	05.99 - 07.05	AMF	3		Y-732J	5605	4	
Lupo 1.4 TDI Fgst 6x-2-005 001>	6X1/6E1	1.4	55	05.99 - 07.05	AMF	3		Y-741U	6943	20	
Lupo 1.6 GTI	6X1/6E1	1.6	92	06.00 - 07.05	AVY	4		BKUR6ET-10	2397	24	LPG 1
Lupo 1.7 SDI	6X1/6E1	1.7	42	10.98 - 07.05	AKU	3		Y-732J	5605	4	

**PASSAT 3**

Passat 3 1.6	35i/3A2/3A5	1.6	55	08.89 - 07.92	ABN	4		BUR5ET-10	7264	21	LPG 2
Passat 3 1.6 TD	35i/3A2/3A5	1.6	59	08.89 - 10.93	SB	4		Y-918J	6285	2	
Passat 3 1.6	35i/3A2/3A5	1.6	74	10.94 - 12.95	AEK	4		BKUR5ET	2789	29	LPG 1
Passat 3 1.6	35i/3A2/3A5	1.6	74	12.95 - 12.96	AFT	4		BKUR6ET-10	2397	24	LPG 1
Passat 3 1.8	35i/3A2/3A5	1.8	55	08.90 - 12.96	AAM	4		BUR5ET	3377	22	LPG 2
Passat 3 1.8	35i/3A2/3A5	1.8	66	08.91 - 09.94	ABS	4		BUR6ET	3172	1	LPG 2
Passat 3 1.8	35i/3A2/3A5	1.8	66	08.94 - 12.96	ADZ	4		BUR6ET	3172	1	LPG 2
Passat 3 1.8 GUS	35i/3A2/3A5	1.8	85	01.97 - 04.00	AFY	4		BKUR6ET-10	2397	24	LPG 1
Passat 3 1.8 16V	35i/3A2/3A5	1.8	100	04.88 - 07.92	KR	4		BCPR7ET	2164		BCPR7EIX
Passat 3 1.9 D	35i/3A2/3A5	1.9	47	05.89 - 10.93	1Y	4		Y-918J	6285	2	
Passat 3 1.9 TD	35i/3A2/3A5	1.9	55	03.91 - 12.96	AAZ	4		Y-918J	6285	2	
Passat 3 1.9 TDI	35i/3A2/3A5	1.9	66	10.93 - 12.96	1Z	4		Y-732J	5605	4	
Passat 3 1.9 TDI	35i/3A2/3A5	1.9	66	10.93 - 08.96	AHU	4		Y-732J	5605	4	
Passat 3 1.9 TDI	35i/3A2/3A5	1.9	81	03.96 - 08.96	AFN	4		Y-732J	5605	4	
Passat 3 2.0 China	35i/3A2/3A5	2.0	79	03.95 - 12.96	AEP	4		BUR6ET	3172	1	LPG 2
Passat 3 2.0	35i/3A2/3A5	2.0	85	03.90 - 09.94	2E	4		BUR6ET	3172	1	LPG 2
Passat 3 2.0	35i/3A2/3A5	2.0	85	06.93 - 12.94	ACX	4		BUR6ET	3172	1	LPG 2
Passat 3 2.0	35i/3A2/3A5	2.0	85	10.94 - 12.95	ADY	4		BUR6ET	3172	1	LPG 2
Passat 3 2.0	35i/3A2/3A5	2.0	85	07.96 - 12.96	AGG	4		BUR6ET	3172	1	LPG 2
Passat 3 2.0 16V	35i/3A2/3A5	2.0	100	04.88 - 10.93	9A	4		BKUR7ET	7873		
Passat 3 2.0 16V	35i/3A2/3A5	2.0	110	07.94 - 12.96	ABF	4		BKUR6ET-10	2397	24	LPG 1

Fgst = Chassis No.

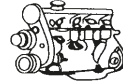
Code *l* kW

Cyl.

Stock-No.  
**V-FLINE**  
VW-PARTNO/2018\*\*

LPG/CNG

**VW  
PASSAT 3**

Passat 3 2.8 VR6	35i/3A2/3A5	2.8	128	06.91 - 06.95	AAA	6	BKR5EKU	3964		
Passat 3 2.8 VR6	35i/3A2/3A5	2.8	128	07.95 - 12.96	AAA	6	BKR5EKUP	2890		
Passat 3 2.8 VR6 USA	35i/3A2/3A5	2.8	142	10.94 - 12.95	AHA	6	BKR6EKUB	3584		LPG 1
Passat 3 2.9 VR6 Synchro	35i/3A5	2.9	135	07.94 - 06.95	ABV	6	BKR5EKU	3964		
Passat 3 2.9 VR6 Synchro	35i/3A5	2.9	135	07.95 - 12.96	ABV	6	BKR5EKUP	2890		

**PASSAT 4**

Passat 4 1.6	3B2 / 3B5	1.6	74	10.96 - 08.00	AHL	4	BKUR6ET-10	2397	24	LPG 1
Passat 4 1.6	3B2 / 3B5	1.6	74	01.97 - 10.97	ADP	4	BKUR6ET-10	2397	24	LPG 1
Passat 4 1.6	3B2 / 3B5	1.6	74	07.99 - 08.00	ANA	4	BKUR6ET-10	2397	24	LPG 1
Passat 4 1.6	3B2 / 3B5	1.6	74	01.99 - 08.00	ARM	4	BKUR6ET-10	2397	24	LPG 1
Passat 4 1.6	3B3 / 3B6	1.6	75	10.00 - 05.05	ALZ	4	BKUR6ET-10	2397	24	LPG 1
Passat 4 1.8	3B2 / 3B5	1.8	92	12.96 - 01.99	ADR	4	BKUR6ET-10	2397	24	LPG 1
Passat 4 1.8	3B2 / 3B5	1.8	92	01.99 - 08.00	APT	4	BKUR6ET-10	2397	24	LPG 1
Passat 4 1.8	3B2 / 3B5	1.8	92	02.99 - 08.00	ARG	4	BKUR6ET-10	2397	24	LPG 1
Passat 4 1.8 T	3B2 / 3B5	1.8	110	10.96 - 12.98	AEB	4	0,8 PFR6Q	6458	37	LPG 1
Passat 4 1.8 T	3B2 / 3B5	1.8	110	01.99 - 08.00	ANB	4	0,8 PFR6Q	6458	37	LPG 1
Passat 4 1.8 T	3B2 / 3B5	1.8	110	01.99 - 08.00	APU	4	0,8 PFR6Q	6458	37	LPG 1
Passat 4 1.8 T	3B3 / 3B6	1.8	110	10.00 - 05.05	AWT	4	0,8 PFR6Q	6458	37	LPG 1
Passat 4 1.8 T China	3B3 / 3B6	1.8	110	12.05 -	BGC	4	0,8 PFR6Q	6458	37	LPG 1
Passat 4 1.8 T USA	3B2 / 3B5	1.8	110	08.99 - 05.00	ATW	4	0,8 PFR6Q	6458	37	LPG 1
Passat 4 1.8 T USA	3B2 / 3B5	1.8	110	05.00 - 08.00	AUG	4	0,8 PFR6Q	6458	37	LPG 1
Passat 4 1.8 T USA	3B3 / 3B6	1.8	125	02.01 - 05.05	AWM	4	0,8 PFR6Q	6458	37	LPG 1
Passat 4 1.9 TDI	3B2 / 3B5	1.9	66	05.98 - 08.00	AHH	4	Y-732J	5605	4	
Passat 4 1.9 TDI Fgst → 3B-2-350-000	3B2/3B3/ 3B5/3B6	1.9	74	10.00 - 05.05	AVB	4	Y-732J	5605	4	
Passat 4 1.9 TDI Fgst 3B-2-350-001 →	3B2/3B3/ 3B5/3B6	1.9	74	10.00 - 05.05	AVB	4	Y-741U	6943	20	
Passat 4 1.9 TDI	3B2 / 3B5	1.9	81	08.99 - 08.00	AVG	4	Y-732J	5605	4	
Passat 4 1.9 TDI	3B2 / 3B5	1.9	85	01.99 - 12.99	AJM	4	Y-732J	5605	4	
Passat 4 1.9 TDI	3B2 / 3B5	1.9	85	01.00 - 08.00	ATJ	4	Y-732J	5605	4	
Passat 4 1.9 TDI Fgst → 3B-2-350-000	3B3 / 3B6	1.9	96	10.00 - 05.05	AVF	4	Y-732J	5605	4	
Passat 4 1.9 TDI Fgst 3B-2-350-001 →	3B3 / 3B6	1.9	96	10.00 - 05.05	AVF	4	Y-741U	6943	20	
Passat 4 1.9 TDI Fgst → 3B-2-350-000	3B3 / 3B6	1.9	96	10.00 - 05.05	AWX	4	Y-732J	5605	4	
Passat 4 1.9 TDI Fgst 3B-2-350-001 →	3B3 / 3B6	1.9	96	10.00 - 05.05	AWX	4	Y-741U	6943	20	
Passat 4 2.0	3B3 / 3B6	2.0	85	10.00 - 05.05	AZM	4	BKUR6ET-10	2397	24	LPG 1
Passat 4 2.0	3B3 / 3B6	2.0	85	12.05 -	BFF	4	0,8 PFR6Q	6458	37	LPG 1
Passat 4 2.0 20V	3B3 / 3B6	2.0	96	11.01 - 05.05	ALT	4	BKUR5ET-10	7553		LPG 1
Passat 4 2.3 V5	3B2 / 3B5	2.3	110	10.96 - 08.00	AGZ	5	BKR5EKUP	2890		
Passat 4 2.3 V5	3B3 / 3B6	2.3	125	01.01 - 05.05	AZX	5	1,1 PZFR5D-11	7968	34	LPG 6
Passat 4 2.5 TDI V6	3B2/3B3/ 3B5/3B6	2.5	110	08.98 - 08.00	AFB	6	Y-501U	3786	31	
Passat 4 2.5 TDI V6	3B2/3B3/ 3B5/3B6	2.5	110	05.99 - 05.03	AKN	6	Y-501U	3786	31	
Passat 4 2.5 TDI V6	3B3 / 3B6	2.5	120	05.03 - 05.05	BDG	6	Y-501U	3786	31	
Passat 4 2.5 TDI V6 4motion	3B3 / 3B6	2.5	132	01.03 - 05.05	BAU	6	Y-501U	3786	31	
Passat 4 2.5 TDI V6 4motion	3B3 / 3B6	2.5	132	01.03 - 05.05	BDH	6	Y-501U	3786	31	
Passat 4 2.8 V6 China / GUS	3B2/3B3/ 3B5/3B6	2.8	132	09.97 - 09.99	AGE	6	BKR6EKUB	3584		LPG 1
Passat 4 2.8 V6 China	3B2/3B3/ 3B5/3B6	2.8	140	10.00 - 05.05	BBG	6	BKR6EKUB	3584		LPG 1
Passat 4 2.8 V6	3B2 / 3B5	2.8	142	06.97 - 12.98	ACK	6	BKR6EKUB	3584		LPG 1

Fgst = Chassis No.

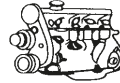
Code *l* kW

Cyl.

Stock-No.  
**V-TIME**  
BY-PROMOTER

LPG/CNG

**VW****PASSAT 4**

Passat 4 2.8 V6 Synchro	3B2 / 3B5	2.8	142	08.97 - 12.98	ALG	6		BKR6EKUB	3584		LPG 1
Passat 4 2.8 V6	3B2 / 3B5	2.8	142	01.99 - 08.00	APR	6		BKR6EKUB	3584		LPG 1
Passat 4 2.8 V6 4motion	3B2 / 3B5	2.8	142	01.99 - 08.00	AQD	6		BKR6EKUB	3584		LPG 1
Passat 4 2.8 4motion	3B3 / 3B6	2.8	142	10.00 - 05.05	AMX	6		BKR6EKUB	3584		LPG 1
Passat 4 2.8 4motion	3B3 / 3B6	2.8	142	10.00 - 05.05	ATQ	6		BKR6EKUB	3584		LPG 1
Passat 4 4.0 W8 4motion	3B3 / 3B6	4.0	202	09.01 - 09.04	BDN	8		BKR6EKUE	7892		

**PASSAT 5**

Passat 5 1.4 TSI	3C2/3C5	1.4	90	05.07 -	CAXA	4	0,9	PZFR6R	5758		
Passat 5 1.4 TSI Ecofuel CNG	3C2/3C5	1.4	110	01.09 -	CDGA	4	0,6	SIZFR6A6D	91629		
Passat 5 1.4 TSI Multifuel	3C2/3C5	1.4	118	11.10 -	CKMA	4	0,6	SIZFR6A6D	91629		
Passat 5 1.4 TSI	3C2/3C5	1.4	118	11.12 -	CTHD	4	0,8	SIZFR6B8EG	96209		
Passat 5 1.6	3C2/3C5	1.6	75	05.05 - 05.07	BSE	4		BKUR6ET-10	2397	24	LPG 1
Passat 5 1.6	3C2/3C5	1.6	75	05.05 -	BSF	4		BKUR6ET-10	2397	24	LPG 1
Passat 5 1.6 TDI	3C2/3C5	1.6	77	08.10 -	CAYC	4	█	Y1002AS	8888	57	
Passat 5 1.6 FSI	3C2/3C5	1.6	85	03.05 -	BLF	4		ZFR6S-Q	6449		
Passat 5 1.8 TSI	3C2/3C5	1.8	112	02.11 -	CDAB	4	0,8	PFR7S8EG	1675		PFR8S8EG
Passat 5 1.8 TSI	3C2/3C5	1.8	112	11.08 - 05.10	CGYA	4	0,8	PFR7S8EG	1675		PFR8S8EG
Passat 5 1.8 TSI	3C2/3C5	1.8	118	06.07 - 11.10	BZB	4	0,8	PFR7S8EG	1675		PFR8S8EG
Passat 5 1.8 TSI	3C2/3C5	1.8	118	11.09 - 10.12	CDAA	4	0,8	PFR7S8EG	1675		PFR8S8EG
Passat 5 1.9 TDI	3C2/3C5	1.9	77	03.05 - 02.06	BKC	4	█	Y-607AS	7560	50	
Passat 5 1.9 TDI	3C2/3C5	1.9	77	06.05 - 05.07	BLS	4	█	Y-607AS	7560	50	
Passat 5 1.9 TDI	3C2/3C5	1.9	77	02.06 - 11.08	BXE	4	█	Y-607AS	7560	50	
Passat 5 2.0 TDI	3C2/3C5	2.0	81	11.08 - 11.10	CBDC	4	█	Y1002AS	8888	57	
Passat 5 2.0 TDI	3C2/3C5	2.0	88	11.05 - 05.07	BWV	4	█	CZ304	9864	55	
Passat 5 2.0 TDI	3C2/3C5	2.0	90	06.05 -	BVD	4	█	CZ104	9826	52	
Passat 5 2.0 TDI	3C2/3C5	2.0	90	06.05 - 02.06	BVE	4	█	CZ304	9864	55	
Passat 5 2.0 TDI	3C2/3C5	2.0	100	03.05 - 05.07	BMA	4	█	CZ304	9864	55	
Passat 5 2.0 TDI	3C2/3C5	2.0	100	06.07 - 04.09	BMA	4	█	YE14	7768	48	
Passat 5 2.0 TDI	3C2/3C5	2.0	100	01.08 -	CBAA	4	█	Y-609AS	5849	49	
Passat 5 2.0 TDI	3C2/3C5	2.0	100	11.10 -	CFFA	4	█	Y1002AS	8888	57	
Passat 5 2.0 TDI	3C2/3C5	2.0	103	03.05 - 05.07	BKP	4	█	CZ304	9864	55	
Passat 5 2.0 TDI	3C2/3C5	2.0	103	06.07 - 11.10	BKP	4	█	YE14	7768	48	
Passat 5 2.0 TDI	3C2/3C5	2.0	103	03.05 - 05.08	BMP	4	█	CZ104	9826	52	
Passat 5 2.0 TDI	3C2/3C5	2.0	103	05.07 - 11.10	CBAB	4	█	Y-609AS	5849	49	
Passat 5 2.0 TDI	3C2/3C5	2.0	103	08.10 -	CFFB	4	█	Y1002AS	8888	57	
Passat 5 2.0 TDI	3C2/3C5	2.0	105	01.09 -	CBAC	4	█	Y1002AS	8888	57	
Passat 5 2.0 FSI	3C2/3C5	2.0	110	03.05 - 11.05	BLR	4		PZFR5N-11T	7742		
Passat 5 2.0 FSI	3C2/3C5	2.0	110	09.05 - 11.05	BLX	4		PZFR5N-11T	7742		
Passat 5 2.0 FSI	3C2/3C5	2.0	110	03.05 - 11.05	BLY	4	0,9	BKR6E	6962	28	LPG 1
Passat 5 2.0 FSI	3C2/3C5	2.0	110	11.05 - 11.10	BVX	4		PZFR5N-11T	7742		
Passat 5 2.0 FSI	3C2/3C5	2.0	110	11.05 - 11.10	BVY	4		PZFR5N-11T	7742		
Passat 5 2.0 FSI	3C2/3C5	2.0	110	11.05 - 11.10	BVZ	4	0,9	BKR6E	6962	28	LPG 1
Passat 5 2.0 TDI	3C2/3C5	2.0	120	10.05 - 05.09	BUZ	4	█	CZ304	9864	55	
Passat 5 2.0 TDI	3C2/3C5	2.0	125	02.06 - 11.10	BMR	4	█	CZ304	9864	55	
Passat 5 2.0 TDI	3C2/3C5	2.0	125	05.08 - 11.10	CBBB	4	█	Y-609AS	5849	49	
Passat 5 2.0 TDI	3C2/3C5	2.0	125	08.10 -	CFGB	4	█	Y1002AS	8888	57	
Passat 5 2.0 TDI	3C2/3C5	2.0	125	08.10 -	CLLA	4	█	Y1002AS	8888	57	
Passat 5 2.0 TSI	3C2/3C5	2.0	125	12.07 - 11.10	CCTA	4	0,8	PFR7S8EG	1675		PFR8S8EG
Passat 5 2.0 TSI	3C2/3C5	2.0	125	12.07 - 11.10	CCTB	4	0,8	PFR7S8EG	1675		PFR8S8EG
Passat 5 2.0 TDI	3C2/3C5	2.0	130	12.12 -	CFGC	4	█	Y1002AS	8888	57	

Code *l* kW

Cyl.



Stock-No.



LPG/CNG

**VW  
PASSAT 5**

Passat 5 2.0 TSI	3C2/3C5	2.0	147	07.05 - 11.05	AXX	4	0,8	PFR7S8EG	1675		PFR8S8EG
Passat 5 2.0 TSI	3C2/3C5	2.0	147	11.07 - 01.10	CAWB	4	0,8	PFR7S8EG	1675		PFR8S8EG
Passat 5 2.0 TSI	3C2/3C5	2.0	147	11.09 - 11.10	CCZA	4	0,8	PFR7S8EG	1675		PFR8S8EG
Passat 5 2.0 TSI	3C2/3C5	2.0	147	08.05 - 07.10	BPY	4	0,8	PFR7S8EG	1675		PFR8S8EG
Passat 5 2.0 TSI	3C2/3C5	2.0	147	11.05 - 12.07	BWA	4	0,8	PFR7S8EG	1675		PFR8S8EG
Passat 5 2.0 TSI	3C2/3C5	2.0	155	11.10 -	CCZB	4	0,8	PFR7S8EG	1675		PFR8S8EG
Passat 5 3.2 FSI 4motion	3C2/3C5	3.2	184	09.05 - 05.07	AXZ	6	0,9	ILZKR7A	1961		
Passat 5 3.6 R36 4motion	3C2/3C5	3.6	220	04.07 - 11.10	BWS	6	0,8	ILZKR8A	94290		

**PHAETON**

Phaeton 3.0 V6 TDI	3D2	3.0	171	09.04 - 05.07	BMK	6		Y-609AS	5849	49	
Phaeton 3.0 V6 TDI	3D2	3.0	172	06.07 - 10.08	CARA	6		Y-609AS	5849	49	
Phaeton 3.0 V6 TDI	3D2	3.0	176	05.08 - 05.10	CEXA	6		Y-609AS	5849	49	
Phaeton 3.2 V6	3D2	3.2	177	05.02 - 05.05	AYT	6	0,9	IZKR7B	7563		
Phaeton 3.2 V6	3D2	3.2	177	08.03 - 10.08	BKL	6	0,9	IZKR7B	7563		
Phaeton 3.6 V6	3D2	3.6	206	11.08 - 05.10	CHNA	6	0,9	ILZKR7A	1961		
Phaeton 3.6 V6	3D2	3.6	206	05.10 -	CMVA	6	0,9	ILZKR7A	1961		
Phaeton 4.2 V8	3D2	4.2	246	08.03 -	BGH	8		BKR6EQUA	6872		LPG 1
Phaeton 4.2 V8	3D2	4.2	246	05.03 - 07.03	BGJ	8		BKR6EQUA	6872		LPG 1
Phaeton 5.0 V10 TDI	3D2	5.0	230	12.02 - 10.06	AJS	10		Y-741U	6943	20	
Phaeton 6.0 W12	3D2	6.0	309	05.02 - 05.05	BAN	12	1,1	PZFR6J-11	3586		LPG 6
Phaeton 6.0 W12	3D2	6.0	309	10.03 -	BAP	12	1,1	PZFR6J-11	3586		LPG 6
Phaeton 6.0 W12	3D2	6.0	331	05.05 - 10.08	BRN	12	1,1	PZFR6J-11	3586		LPG 6
Phaeton 6.0 W12	3D2	6.0	331	05.05 - 10.08	BTT	12	1,1	PZFR6J-11	3586		LPG 6

**POLO 2**

Polo 2 1.0	86C	1.0	33	08.89 - 01.92	HZ	4		BUR6ET	3172	1	LPG 2
Polo 2 1.0	86C	1.0	33	08.89 - 12.92	ACM	4		BUR6ET	3172	1	LPG 2
Polo 2 1.0	86C	1.0	33	10.90 - 07.94	AAU	4		BUR5ET	3377	22	LPG 2
Polo 2 1.3	86C	1.3	40	08.89 - 12.92	NZ	4		BUR6ET	3172	1	LPG 2
Polo 2 1.3	86C	1.3	40	01.89 - 07.94	2G	4		BUR6ET	3172	1	LPG 2
Polo 2 1.3	86C	1.3	40	01.91 - 07.94	AAV	4		BUR5ET	3377	22	LPG 2
Polo 2 1.3	86C	1.3	55	01.90 - 07.94	3F	4		BUR6ET	3172	1	LPG 2
Polo 2 1.4 D	86C	1.4	35	10.90 - 07.94	1W	4		Y-918J	6285	2	

**POLO 3**

Polo 3 1.0	6N1	1.0	33	10.94 - 06.96	AEV	4		BUR6ET	3172	1	LPG 2
Polo 3 1.0	6N1	1.0	37	07.96 - 12.99	AER	4		BUR6ET	3172	1	LPG 2
Polo 3 1.0	6N1	1.0	37	08.97 - 12.99	ALL	4		BUR6ET	3172	1	LPG 2
Polo 3 1.0	6N2	1.0	37	10.99 - 09.01	ALD	4	1,1	PZFR5D-11	7968	34	LPG 6
Polo 3 1.0	6N2	1.0	37	10.99 - 09.01	AUC	4	1,1	PZFR5D-11	7968	34	LPG 6
Polo 3 1.3	6N1	1.3	40	10.94 - 04.97	ADX	4		BUR6ET	3172	1	LPG 2
Polo 3 1.4	6N2	1.4	40	10.99 - 09.01	AKP	4	1,1	PZFR5D-11	7968	34	LPG 6
Polo 3 1.4	6N1	1.4	44	07.95 - 12.97	AEX	4		BUR6ET	3172	1	LPG 2
Polo 3 1.4	6N1	1.4	44	05.97 - 12.99	AKV	4		BUR6ET	3172	1	LPG 2
Polo 3 1.4	6N1	1.4	44	11.97 - 12.99	APQ	4		BUR6ET	3172	1	LPG 2
Polo 3 1.4	6N2	1.4	44	01.98 - 12.99	ANX	4		BUR6ET	3172	1	LPG 2
Polo 3 1.4	6N2	1.4	44	10.99 - 09.01	AKK	4	1,1	PZFR5D-11	7968	34	LPG 6
Polo 3 1.4 Classic / Variant	6KV2 / 6KV5	1.4	44	10.99 - 08.00	ANW	4	1,1	PZFR5D-11	7968	34	LPG 6
Polo 3 1.4	6N2	1.4	44	10.99 - 09.01	AUD	4	1,1	PZFR5D-11	7968	34	LPG 6
Polo 3 1.4 16V	6N2	1.4	55	10.99 - 09.01	AHW	4		BKUR6ET-10	2397	24	LPG 1



Code *l* kW

Cyl.

Stock-No.  
**VW**

LPG/CNG

**VW****POLO 3**

Polo 3 1.4 16V	6N2	1.4	55	10.99 - 06.00	APE	4		BKUR6ET-10	2397	24	LPG 1
Polo 3 1.4 16V	6N2	1.4	55	10.99 - 01.02	AUA	4		BKUR6ET-10	2397	24	LPG 1
Polo 3 1.4 TDI	6N2	1.4	55	10.99 - 05.05	AMF	3	▣	Y-741U	6943	20	
Polo 3 1.4 16V	6N1	1.4	74	04.96 - 12.99	AFH	4		BKUR6ET-10	2397	24	LPG 1
Polo 3 1.4 16V	6N2	1.4	74	10.99 - 09.01	AFK	4		BKUR6ET-10	2397	24	LPG 1
Polo 3 1.4 16V	6N2	1.4	74	07.99 - 05.00	AQQ	4		BKUR6ET-10	2397	24	LPG 1
Polo 3 1.4 16V	6N2	1.4	74	05.00 - 06.02	AUB	4		BKUR6ET-10	2397	24	LPG 1
Polo 3 1.6 Classic	6KV2	1.6	55	10.94 - 09.97	1F	4		BUR5ET	3377	22	LPG 2
Polo 3 1.6	6N1	1.6	55	10.94 - 07.95	AEA	4		BUR6ET	3172	1	LPG 2
Polo 3 1.6	6N1	1.6	55	07.95 - 12.99	AEE	4		BUR6ET	3172	1	LPG 2
Polo 3 1.6 Classic / Variant	6KV2 / 6KV5	1.6	55	07.98 - 09.01	ALM	4		BUR6ET	3172	1	LPG 2
Polo 3 1.6 Classic / Variant	6KV2 / 6KV5	1.6	74	12.95 - 08.99	AFT	4		BKUR6ET-10	2397	24	LPG 1
Polo 3 1.6 Classic / Variant	6KV2 / 6KV5	1.6	74	10.99 - 09.01	AEH	4		BKUR6ET-10	2397	24	LPG 1
Polo 3 1.6 Classic / Variant	6KV2 / 6KV5	1.6	74	10.99 - 09.01	AKL	4		BKUR6ET-10	2397	24	LPG 1
Polo 3 1.6 Classic / Variant	6KV2 / 6KV5	1.6	74	03.00 - 10.00	APF	4		BKUR6ET-10	2397	24	LPG 1
Polo 3 1.6 Classic / Variant	6KV2 / 6KV5	1.6	74	07.00 - 09.01	AUR	4		BKUR6ET-10	2397	24	LPG 1
Polo 3 1.6 GTI	6N1	1.6	88	08.98 - 12.99	AJV	4		BKUR6ET-10	2397	24	LPG 1
Polo 3 1.6 GTI	6N2	1.6	92	11.99 - 09.01	ARC	4		BKUR6ET-10	2397	24	LPG 1
Polo 3 1.6 GTI	6N2	1.6	92	05.00 - 09.01	AVY	4		BKUR6ET-10	2397	24	LPG 1
Polo 3 1.7 SDI	6N1	1.7	42	04.97 - 12.99	AHG	4	▣	Y-732J	5605	4	
Polo 3 1.7 SDI	6N1 / 6N2	1.7	42	08.97 - 04.00	AKU	3	▣	Y-732J	5605	4	
Polo 3 1.7 SDI Classic / Variant	6KV2 / 6KV5	1.7	44	11.97 - 08.99	AKW	4	▣	Y-732J	5605	4	
Polo 3 1.8 Classic	6KV2	1.8	66	03.98 - 09.01	ADD	4		BUR6ET	3172	1	LPG 2
Polo 3 1.9 D	6N1 / 6N2	1.9	47	10.94 - 12.99	AEF	4	▣	Y-918J	6285	2	
Polo 3 1.9 SDI Classic / Variant	6KV2 / 6KV5	1.9	47	12.95 - 08.99	AEY	4	▣	Y-732J	5605	4	
Polo 3 1.9 SDI	6N1 / 6N2	1.9	47	07.96 - 09.01	AGD	4	▣	Y-732J	5605	4	
Polo 3 1.9 SDI	6N2	1.9	47	10.99 - 09.01	ASX	4	▣	Y-732J	5605	4	
Polo 3 1.9 SDI Classic / Variant	6KV2 / 6KV5	1.9	50	10.99 - 09.01	AGP	4	▣	Y-732J	5605	4	
Polo 3 1.9 SDI Classic / Variant	6KV2 / 6KV5	1.9	50	10.99 - 09.01	AQM	4	▣	Y-732J	5605	4	
Polo 3 1.9 TDI Classic / Variant	6KV2 / 6KV5	1.9	66	01.97 - 08.99	AHU	4	▣	Y-732J	5605	4	
Polo 3 1.9 TDI Variant	6KV5	1.9	66	11.97 - 08.99	ALE	4	▣	Y-732J	5605	4	
Polo 3 1.9 TDI Classic / Variant	6KV2 / 6KV5	1.9	66	10.99 - 09.01	AGR	4	▣	Y-732J	5605	4	
Polo 3 1.9 TDI Classic / Variant	6KV2 / 6KV5	1.9	66	10.99 - 09.01	ALH	4	▣	Y-732J	5605	4	
Polo 3 1.9 TDI Classic / Variant	6KV2 / 6KV5	1.9	81	06.98 - 08.99	AFN	4	▣	Y-732J	5605	4	
Polo 3 1.9 TDI Classic / Variant	6KV2 / 6KV5	1.9	81	10.99 - 09.01	ASV	4	▣	Y-732J	5605	4	

**POLO 4**

Polo 4 1.2	9N	1.2	40	01.02 - 05.04	AWY	3	0,9	ZFR5P-G	6893		LPG 6
Polo 4 1.2	9N	1.2	40	05.04 - 05.07	BMD	3	0,9	ZFR5P-G	6893		LPG 6
Polo 4 1.2	9N	1.2	44	05.07 - 11.09	BBM	3	0,9	ZFR5P-G	6893		LPG 6
Polo 4 1.2	9N	1.2	47	11.04 - 07.07	BME	3	0,9	ZFR5P-G	6893		LPG 6
Polo 4 1.2 12V	9N	1.2	47	11.01 - 05.04	AZQ	3	0,9	ZFR5P-G	6893		LPG 6
Polo 4 1.2	9N	1.2	52	05.07 - 11.09	BZG	3	0,9	ZFR5P-G	6893		LPG 6
Polo 4 1.4 TDI	9N	1.4	51	04.05 - 11.09	BNM	3	▣	Y-741U	6943	20	
Polo 4 1.4 TDI	9N	1.4	51	05.06 - 11.09	BWB	3	▣	CZ104	9826	52	
Polo 4 1.4 16V	9N	1.4	55	11.01 - 05.04	BBY	4		BKUR6ET-10	2397	24	LPG 1
Polo 4 1.4 16V	9N	1.4	55	05.04 - 05.08	BKY	4	0,9	ZFR5P-G	6893		LPG 6
Polo 4 1.4 16V Automatic	9N	1.4	55	11.01 - 05.04	BBY	4	1,1	PZFR5D-11	7968	34	LPG 6
Polo 4 1.4 TDI	9N	1.4	55	11.01 - 05.05	BAY	3	▣	Y-741U	6943	20	
Polo 4 1.4 16V	9N	1.4	59	05.06 - 11.09	BUD	4	1,1	ZFR6T-11G	5960		
Polo 4 1.4 TDI	9N	1.4	59	10.05 - 11.09	BMS	3	▣	CZ104	9826	52	
Polo 4 1.4 TDI	9N	1.4	59	04.05 - 11.09	BNV	3	▣	Y-741U	6943	20	

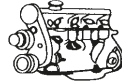

Code *l* kW

Cyl.



Stock-No.



LPG/CNG

**VW  
POLO 4**

Polo 4 1.4 FSI	9N	1.4	63	02.02 - 07.06	AXU	4		ZFR6S-Q	6449		
Polo 4 1.4 16V	9N	1.4	74	05.02 - 05.08	BBZ	4		BKUR6ET-10	2397	24	LPG 1
Polo 4 1.6 16V	9N	1.6	77	05.06 - 11.09	BTS	4	1,1	ZFR6T-11G	5960		
Polo 4 1.8 GTI	9N	1.8	110	09.05 - 11.09	BJX	4	0,8	PFR6Q	6458	37	LPG 1
Polo 4 1.8 GTI Cup Edition	9N	1.8	132	05.06 - 11.09	BBU	4	0,8	PFR6Q	6458	37	LPG 1
Polo 4 1.9 SDI	9N	1.9	47	11.01 - 11.09	ASY	4		Y-732J	5605	4	
Polo 4 1.9 TDI	9N	1.9	74	11.01 - 11.09	ATD	4		Y-741U	6943	20	
Polo 4 1.9 TDI	9N	1.9	74	11.01 - 11.09	AXR	4		Y-741U	6943	20	
Polo 4 1.9 TDI	9N	1.9	74	05.06 - 11.09	BMT	4		Y-607AS	7560	50	
Polo 4 1.9 TDI	9N	1.9	96	11.03 - 11.09	ASZ	4		Y-741U	6943	20	
Polo 4 1.9 TDI	9N	1.9	96	05.04 - 11.09	BLT	4		Y-741U	6943	20	

**POLO 5**

Polo 5 1.2	6R	1.2	44	06.09 -	CGPB	3	1,1	ZFR6T-11G	5960		
Polo 5 1.2	6R	1.2	51	06.09 -	CGPA	3	1,1	ZFR6T-11G	5960		
Polo 5 1.2 TDI	6R	1.2	55	10.09 -	CFWA	3		Y1002AS	8888	57	
Polo 5 1.2 TSI	6R	1.2	66	05.11 -	CBZC	4	0,7	IZFR6P7	97153		
Polo 5 1.2 TSI	6R	1.2	77	06.09 -	CBZB	4	0,7	IZFR6P7	97153		
Polo 5 1.4 BiFuel	6R	1.4	60	03.10 - 01.11	CMAA	4	1,1	ZFR6T-11G	5960		
Polo 5 1.4	6R	1.4	63	06.09 -	CGGB	4	1,1	ZFR6T-11G	5960		
Polo 5 1.4 TSI BlueGT	6R	1.4	103	07.12 -	CPTA	4	0,8	PZKER7A8EGS	94968		
Polo 5 GTI	6R	1.4	132	05.10 -	CAVE	4	0,8	SIZFR6B8EG	96209		
Polo 5 1.6 TDI	6R	1.6	55	05.09 -	CAYA	4		Y1002AS	8888	57	
Polo 5 1.6 BiFuel	6R	1.6	60	01.11 -	CNKA	4	1,1	ZFR6T-11G	5960		
Polo 5 1.6 RUS	6R	1.6	63	11.10 - 04.12	CFNB	4	1,1	ZFR6T-11G	5960		
Polo 5 1.6 TDI	6R	1.6	66	06.09 -	CAYB	4		Y1002AS	8888	57	
Polo 5 1.6 RUS	6R	1.6	77	05.10 -	CFNA	4	1,1	ZFR6T-11G	5960		
Polo 5 1.6 TDI	6R	1.6	77	05.09 -	CAYC	4		Y1002AS	8888	57	
Polo 5 1.6 TDI	6R	1.6	77	05.09 -	CLNA	4		Y1002AS	8888	57	
Polo 5 2.0 TSI WRC	6R	2.0	162	08.13 -	CDLJ	4	0,8	PFR7S8EG	1675		

**SCIROCCO 2**

Scirocco 2 1.8	53B	1.8	66	08.83 - 07.92	EX	4		BUR6ET	3172	1	LPG 2
Scirocco 2 1.8	53B	1.8	70	11.85 - 07.92	JH	4		BUR6ET	3172	1	LPG 2
Scirocco 2 1.8 GLI/GTI	53B	1.8	82	08.82 - 07.92	DX	4		BUR6ET	3172	1	LPG 2
Scirocco 2 1.8 GTI 16V	53B	1.8	95	02.86 - 07.92	PL	4		BKUR7ET	7873		

**SCIROCCO 3**

Scirocco 3 1.4 TSI	137	1.4	90	11.08 -	CAXA	4	0,9	PZFR6R	5758		
Scirocco 3 1.4 TSI	137	1.4	118	08.08 - 10.12	CAVD	4	0,9	PZFR6R	5758		
Scirocco 3 2.0 TDI	137	2.0	103	08.08 -	CBDB	4		Y1002AS	8888	57	
Scirocco 3 2.0 TDI	137	2.0	125	05.09 -	CBBB	4		Y1002AS	8888	57	
Scirocco 3 2.0 TDI	137	2.0	130	01.13 -	CFGC	4		Y1002AS	8888	57	
Scirocco 3 2.0 TSI	137	2.0	147	08.08 -	CAWB	4	0,8	PFR7S8EG	1675		PFR8S8EG
Scirocco 3 2.0 TSI	137	2.0	155	11.09 -	CCZB	4	0,8	PFR7S8EG	1675		PFR8S8EG
Scirocco 3 2.0 TSI R	137	2.0	188	11.09 -	CDLC	4	0,8	PFR7S8EG	1675		PFR8S8EG
Scirocco 3 2.0 TSI R	137	2.0	195	11.09 -	CDLA	4	0,8	PFR7S8EG	1675		PFR8S8EG

**SHARAN 1**

Sharan 1 1.8 T	7M6/7M8/ 7M9	1.8	110	11.97 - 02.00	AJH	4	0,8	PFR6Q	6458	37	LPG 1
Sharan 1 1.9 TDI	7M6/7M8/ 7M9	1.9	66	09.95 - 07.96	1Z	4		Y-732J	5605	4	

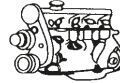
Code *l* kW

Cyl.

Stock-No.  
**V-TIME**  
B-Power

LPG/CNG

**VW****SHARAN 1**

Sharan 1 1.9 TDI	7M6/7M8/ 7M9	1.9	66	08.96 - 02.00	AHU	4	☑	Y-732J	5605	4	
Sharan 1 1.9 TDI	7M6/7M8/ 7M9	1.9	66	03.99 - 03.00	ANU	4	☑	Y-741U	6943	20	
Sharan 1 1.9 TDI	7M8	1.9	81	02.96 - 07.99	AFN	4	☑	Y-732J	5605	4	
Sharan 1 1.9 TDI	7M8	1.9	81	08.99 - 02.00	AVG	4	☑	Y-732J	5605	4	
Sharan 1 2.0	7M6/7M8/ 7M9	2.0	85	09.95 - 02.00	ADY	4		BKUR6ET-10	2397	24	LPG 1
Sharan 1 2.8 VR6	7M8	2.8	128	09.95 - 03.98	AAA	6		BKR5EKUP	2890		
Sharan 1 2.8 VR6	7M8	2.8	128	04.98 - 02.00	AMY	6		BKR5EKUP	2890		

**SHARAN 2**

Sharan 2 1.8 T	7M6/7M8/ 7M9	1.8	110	04.00 - 05.05	AWC	4	0,8	PFR6Q	6458	37	LPG 1
Sharan 2 1.9 TDI	7M6/7M9	1.9	85	04.00 - 03.10	AUY	4	☑	Y-741U	6943	20	
Sharan 2 1.9 TDI	7M6/7M9	1.9	85	11.05 - 03.10	BVK	4	☑	Y-741U	6943	20	
Sharan 2 1.9 TDI	7M6/7M9	1.9	96	11.02 - 03.10	ASZ	4	☑	Y-741U	6943	20	
Sharan 2 1.9 TDI	7M6	1.9	110	01.05 - 05.07	BTB	4	☑	Y-741U	6943	20	
Sharan 2 2.0 LPG	7M6/7M8/ 7M9	2.0	85	04.00 - 03.10	ATM	4		BKUR6ET-10	2397	24	LPG 1
Sharan 2 2.0 TDI	7M6	2.0	100	11.05 - 03.10	BVH	4	☑	CZ104	9826	52	
Sharan 2 2.0 TDI	7M6	2.0	103	11.05 - 03.10	BRT	4	☑	CZ104	9826	52	
Sharan 2 2.8 V6	7M6/7M9	2.8	150	04.00 - 03.10	AYL	6	1,1	PZFR5D-11	7968	34	LPG 6

**SHARAN 3**

Sharan 3 1.4 TSI	7N1	1.4	110	05.10 -	CAVA	4	0,8	SIZFR6B8EG	96209		
Sharan 3 2.0 TDI	7N1	2.0	85	06.11 -	CFFE	4	☑	Y1002AS	8888	57	
Sharan 3 2.0 TDI	7N1	2.0	100	05.10 -	CFFA	4	☑	Y1002AS	8888	57	
Sharan 3 2.0 TDI	7N1	2.0	103	05.10 -	CFFB	4	☑	Y1002AS	8888	57	
Sharan 3 2.0 TDI	7N1	2.0	125	08.10 -	CFGB	4	☑	Y1002AS	8888	57	
Sharan 3 2.0 TDI	7N1	2.0	130	01.13 -	CFGC	4	☑	Y1002AS	8888	57	
Sharan 3 2.0 TSI	7N1	2.0	147	11.10 -	CCZA	4	0,8	PFR7S8EG	1675		PFR8S8EG

**TRANSPORTER**

T 3 1.7 D		1.7	42	10.86 - 07.92	KY	4	☑	Y-918J	6285	2	
T 3 1.9		1.9	44	08.89 - 07.92	DF	4		BUR6ET	3172	1	LPG 2
T 3 1.9		1.9	57	08.82 - 07.92	DG	4		BUR6ET	3172	1	LPG 2
T 3 2.1		2.1	64	08.86 - 07.92	SR	4	0,7	B6ES	7310		
T 3 2.1		2.1	68	08.85 - 07.92	SS	4	0,7	B6ES	7310		
T 3 2.1		2.1	70	08.85 - 07.92	MV	4	0,7	B6ES	7310		
T 3 2.1		2.1	82	08.84 - 07.92	DJ	4		BUR6ET	3172	1	LPG 2
T 4 1.8		1.8	49	09.90 - 07.92	PD	4		BUR6ET	3172	1	LPG 2
T 4 1.9 D		1.9	44	09.90 - 12.95	1X	4	☑	Y-918J	6285	2	
T 4 1.9 TD		1.9	50	10.92 - 04.02	ABL	4	☑	Y-918J	6285	2	
T 4 2.0		2.0	62	09.90 - 06.03	AAC	4		BUR5ET	3377	22	LPG 2
T 4 2.4 D		2.4	55	04.97 - 06.03	AJA	5	☑	Y-918J	6285	2	
T 4 2.5 TDI		2.5	65	05.98 - 09.03	AJT	5	☑	Y-732J	5605	4	
T 4 2.5 TDI		2.5	65	10.01 - 09.03	AYY	5	☑	Y-732J	5605	4	
T 4 2.5 TDI		2.5	75	11.99 - 09.03	AUF	5	☑	Y-732J	5605	4	
T 4 2.5 TDI		2.5	75	04.01 - 09.03	AXL	5	☑	Y-732J	5605	4	
T 4 2.5		2.5	81	09.90 - 12.93	AAF	5		BPR5EKU	5685		LPG 2
T 4 2.5		2.5	81	08.93 - 10.96	ACU	5		BUR5ET	3377	22	LPG 2
T 4 2.5		2.5	81	05.95 - 12.95	AEN	5		BUR5ET	3377	22	LPG 2

Code *l* kW

Cyl.



Stock-No.



10-15-20-25-30-35-40-45-50-55-60-65-70-75-80-85-90-95-100-105-110-115-120-125-130-135-140-145-150-155-160-165-170-175-180-185-190-195-200-205-210-215-220-225-230-235-240-245-250-255-260-265-270-275-280-285-290-295-300-305-310-315-320-325-330-335-340-345-350-355-360-365-370-375-380-385-390-395-400-405-410-415-420-425-430-435-440-445-450-455-460-465-470-475-480-485-490-495-500-505-510-515-520-525-530-535-540-545-550-555-560-565-570-575-580-585-590-595-600-605-610-615-620-625-630-635-640-645-650-655-660-665-670-675-680-685-690-695-700-705-710-715-720-725-730-735-740-745-750-755-760-765-770-775-780-785-790-795-800-805-810-815-820-825-830-835-840-845-850-855-860-865-870-875-880-885-890-895-900-905-910-915-920-925-930-935-940-945-950-955-960-965-970-975-980-985-990-995-1000

LPG/CNG

**VW  
TRANSPORTER**

T 4 2.5		2.5	81	08.96 - 09.03	AET	5		BUR5ET	3377	22	LPG 2
T 4 2.5 China / GUS		2.5	81	08.96 - 06.03	AEU	5		BUR5ET	3377	22	LPG 2
T 4 2.5		2.5	85	05.99 - 12.99	APL	5		BKUR5ET	2789	29	LPG 1
T 4 2.5		2.5	85	12.99 - 06.03	AVT	5		BKUR5ET	2789	29	LPG 1
T 4 2.5 TDI		2.5	111	07.99 - 09.00	AHY	5	☑	Y-732J	5605	4	
T 4 D		2.4	57	09.90 - 04.98	AAB	5	☑	Y-918J	6285	2	
T 4 TDI		2.5	75	09.95 - 06.03	ACV	5	☑	Y-732J	5605	4	
T 4 TDI		2.5	75	04.01 - 09.03	AYC	5	☑	Y-732J	5605	4	
T 4 TDI		2.5	111	09.00 - 09.03	AXG	5	☑	Y-732J	5605	4	
T 4 2.8 VR6		2.8	103	01.96 - 05.00	AES	6		BKR5EKUP	2890		
T 4 2.8 V6		2.8	150	05.00 - 09.03	AMV	6	1,1	PZFR5D-11	7968	34	LPG 6
T 4 2.8 V6 USA		2.8	150	05.00 - 06.03	AXK	6	1,1	PZFR5D-11	7968	34	LPG 6
T 5 1.9 TDI		1.9	62	01.06 -	BRR	4	☑	Y-607AS	7560	50	
T 5 1.9 TDI		1.9	63	04.03 - 05.07	AXC	4	☑	Y-741U	6943	20	
T 5 1.9 TDI		1.9	75	01.06 -	BRS	4	☑	Y-607AS	7560	50	
T 5 1.9 TDI		1.9	77	04.03 - 05.07	AXB	4	☑	Y-741U	6943	20	
T 5 2.0 TDI		2.0	62	09.09 -	CAAA	4	☑	Y1002AS	8888	57	
T 5 2.0 TDI		2.0	75	09.09 -	CAAB	4	☑	Y1002AS	8888	57	
T 5 2.0		2.0	85	11.03 - 05.07	AXA	4		BKUR6ET-10	2397	24	LPG 1
T 5 2.0 TDI		2.0	103	09.09 -	CCHA	4	☑	Y1002AS	8888	57	
T 5 2.0 TDI		2.0	103	09.09 -	CAAC	4	☑	Y1002AS	8888	57	
T 5 2.0 TSI		2.0	110	05.11 -	CJKB	4	0,8	PFR7S8EG	1675		PFR8S8EG
T 5 2.0 BiTDI		2.0	132	09.09 -	CFCA	4	☑	Y1002AS	8888	57	
T 5 2.0 TSI		2.0	150	05.11 -	CJKA	4	0,8	PFR7S8EG	1675		PFR8S8EG
T 5 2.5 TDI		2.5	96	04.03 - 05.07	AXD	5	☑	Y-741U	6943	20	
T 5 2.5 TDI		2.5	96	01.06 -	BNZ	5	☑	CZ104	9826	52	
T 5 2.5 TDI		2.5	120	11.03 -	BLJ	5	☑	Y-741U	6943	20	
T 5 2.5 TDI		2.5	128	04.03 - 05.07	AXE	5	☑	Y-741U	6943	20	
T 5 2.5 TDI		2.5	128	01.06 -	BPC	5	☑	CZ104	9826	52	
T 5 3.2 V6		3.2	170	02.04 - 05.07	BDL	6	0,9	IZKR7B	7563		IZKR7B
T 5 3.2 V6		3.2	173	02.04 -	BKK	6	0,9	IZKR7B	7563		IZKR7B

**TARO**

Taro 1.8		2.2	69	06.89 - 07.94	4Y	4	1,1	BPR5EY-11	3028		LPG 2
Taro 2.2		1.8	61	02.89 - 09.94	2Y	4	1,1	BPR5EY-11	3028		LPG 2

**TIGUAN**

Tiguan 1.4 TSI	5N	1.4	90	08.10 -	CAXA	4	0,9	PZFR6R	5758		
Tiguan 1.4 TSI	5N	1.4	110	11.07 - 11.08	BWK	4	0,8	SIZFR6B8EG	96209		
Tiguan 1.4 TSI	5N	1.4	110	05.08 -	CAVA	4	0,8	SIZFR6B8EG	96209		
Tiguan 1.4 TSI	5N	1.4	118	05.11 -	CAVD	4	0,8	SIZFR6B8EG	96209		
Tiguan 2.0 TDI	5N	2.0	81	05.10 -	CFFD	4	☑	Y1002AS	8888	57	
Tiguan 2.0 TDI	5N	2.0	100	11.07 - 05.10	CBAA	4	☑	Y1002AS	8888	57	
Tiguan 2.0 TDI	5N	2.0	100	05.10 -	CFFA	4	☑	Y1002AS	8888	57	
Tiguan 2.0 TDI	5N	2.0	103	11.07 -	CBAB	4	☑	Y1002AS	8888	57	
Tiguan 2.0 TDI	5N	2.0	103	11.09 -	CFFB	4	☑	Y1002AS	8888	57	
Tiguan 2.0 TDI	5N	2.0	103	11.10 -	CLJA	4	☑	Y1002AS	8888	57	
Tiguan 2.0 TDI	5N	2.0	120	02.08 - 05.10	CBBA	4	☑	Y1002AS	8888	57	
Tiguan 2.0 TDI	5N	2.0	125	02.08 - 07.09	CBBB	4	☑	Y1002AS	8888	57	
Tiguan 2.0 TDI	5N	2.0	125	05.10 -	CFGB	4	☑	Y1002AS	8888	57	
Tiguan 2.0 TSI	5N	2.0	125	11.07 -	CCTA	4	0,8	PFR7S8EG	1675		PFR8S8EG
Tiguan 2.0 TSI	5N	2.0	125	01.08 -	CAWA	4	0,8	PFR7S8EG	1675		PFR8S8EG

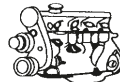
Code *l* kW

Cyl.



Stock-No.

V-TIME  
E-POWER

LPG/CNG

VW

**TIGUAN**

Tiguan 2.0 TSI	5N	2.0	125	11.09 -	CCZC	4	0,8	PFR7S8EG	1675		PFR8S8EG
Tiguan 2.0 TDI	5N	2.0	130	11.12 -	CFGC	4		Y1002AS	8888	57	
Tiguan 2.0 TSI	5N	2.0	132	05.11 -	CCZD	4	0,8	PFR7S8EG	1675		PFR8S8EG
Tiguan 2.0 TSI	5N	2.0	147	11.07 - 05.10	CAWB	4	0,8	PFR7S8EG	1675		PFR8S8EG
Tiguan 2.0 TSI	5N	2.0	147	11.09 -	CCZA	4	0,8	PFR7S8EG	1675		PFR8S8EG
Tiguan 2.0 TSI	5N	2.0	155	05.11 -	CCZB	4	0,8	PFR7S8EG	1675		PFR8S8EG

**TOUAREG 1**

Touareg 2.5 TDI	7LA/7L6/ 7L7	2.5	120	07.03 - 11.06	BLK	5		Y-741U	6943	20	
Touareg 2.5 TDI	7LA/7L6/ 7L7	2.5	120	01.06 - 05.10	BPD	5		CZ104	9826	52	
Touareg 2.5 TDI	7LA/7L6/ 7L7	2.5	128	01.03 - 11.06	BAC	5		Y-741U	6943	20	
Touareg 2.5 TDI	7LA/7L6/ 7L7	2.5	128	01.06 - 05.10	BPE	5		CZ104	9826	52	
Touareg 3.0 TDI	7LA/7L6/ 7L7	3.0	155	04.06 - 11.07	BUN	6		Y-609AS	5849	49	
Touareg 3.0 TDI	7LA/7L6/ 7L7	3.0	155	11.07 - 05.10	CASB	6		Y-609AS	5849	49	
Touareg 3.0 TDI	7LA/7L6/ 7L7	3.0	165	11.04 - 05.08	BKS	6		Y-609AS	5849	49	
Touareg 3.0 TDI	7LA/7L6/ 7L7	3.0	176	01.08 - 05.10	CASC	6		Y-609AS	5849	49	
Touareg 3.0 TDI	7LA/7L6/ 7L7	3.0	177	11.07 - 05.10	CASA	6		Y-609AS	5849	49	
Touareg 3.2	7LA/7L6/ 7L7	3.2	162	11.02 - 05.04	AZZ	6	0,9	IZKR7B	7563		IZKR7B
Touareg 3.2	7LA/7L6/ 7L7	3.2	162	05.03 - 05.04	BKJ	6	0,9	IZKR7B	7563		IZKR7B
Touareg 3.2	7LA/7L6/ 7L7	3.2	162	05.04 - 11.06	BMV	6	0,9	IZKR7B	7563		IZKR7B
Touareg 3.2	7LA/7L6/ 7L7	3.2	162	05.04 - 11.06	BMX	6	0,9	IZKR7B	7563		IZKR7B
Touareg 3.2 USA	7LA/7L6/ 7L7	3.2	162	08.03 - 05.04	BAA	6	0,9	IZKR7B	7563		IZKR7B
Touareg 3.6 FSI	7LA/7L6/ 7L7	3.6	206	10.05 - 05.10	BHK	6	0,9	ILZKR7A	1961		ILZKR7A
Touareg 4.2	7LA/7L6/ 7L7	4.2	228	12.02 - 11.06	AXQ	8		BKR6EQUA	6872		LPG 1
Touareg 4.2	7LA/7L6/ 7L7	4.2	258	12.06 - 05.10	BAR	8		PFR6W-TG	5547		
Touareg 5.0 V10 TDI	7LA/7L6/ 7L7	5.0	230	11.04 - 05.10	BLE	10		CZ104	9826	52	
Touareg 5.0 V10 TDI	7LA/7L6/ 7L7	5.0	230	11.02 - 11.06	AYH	10		Y-741U	6943	20	
Touareg WR 12	7LA/7L6/ 7L7	6.0	316	08.04 - 05.10	BJN	12	1,1	PZFR6J-11	3586		LPG 6

**TOUAREG 2**

Touareg 3.0 Hybrid	7P5	3.0	245	04.10 -	CGEA	6	0,8	PFR8S8EG	94460		PFR8S8EG
--------------------	-----	-----	-----	---------	------	---	-----	----------	-------	--	----------

Code *l* kW

Cyl.



Stock-No.

VLINE  
10-15-20-25-30-35-40-45-50-55-60-65-70-75-80-85-90-95-100-105-110-115-120-125-130-135-140-145-150-155-160-165-170-175-180-185-190-195-200-205-210-215-220-225-230-235-240-245-250-255-260-265-270-275-280-285-290-295-300-305-310-315-320-325-330-335-340-345-350-355-360-365-370-375-380-385-390-395-400-405-410-415-420-425-430-435-440-445-450-455-460-465-470-475-480-485-490-495-500-505-510-515-520-525-530-535-540-545-550-555-560-565-570-575-580-585-590-595-600-605-610-615-620-625-630-635-640-645-650-655-660-665-670-675-680-685-690-695-700-705-710-715-720-725-730-735-740-745-750-755-760-765-770-775-780-785-790-795-800-805-810-815-820-825-830-835-840-845-850-855-860-865-870-875-880-885-890-895-900-905-910-915-920-925-930-935-940-945-950-955-960-965-970-975-980-985-990-995-1000

LPG/CNG

**VW  
TOUAREG 2**

Touareg 3.0 Hybrid	7P5	3.0	245	04.10 -	CGFA	6	0,8	PFR8S8EG	94460		PFR8S8EG
Touareg 3.6 FSI	7P5	3.6	206	04.10 -	CGRA	6	0,9	ILZKR7A	1961		ILZKR7A

**TOURAN**

Touran 1.2 TSI	1T3	1.2	77	05.10 -	CBZB	4	0,7	IZFR6P7	97153		
Touran 1.4 TSI	1T1/1T2	1.4	103	02.06 - 05.10	BMV	4	0,8	SIZFR6B8EG	96209		
Touran 1.4 TSI	1T2/1T3	1.4	103	11.08 -	CAVC	4	0,8	SIZFR6B8EG	96209		
Touran 1.4 TSI	1T2	1.4	125	11.06 - 11.08	BLG	4	0,9	PZFR6R	5758		
Touran 1.4 TSI	1T2/1T3	1.4	125	11.08 -	CAVB	4	0,8	SIZFR6B8EG	96209		
Touran 1.4 TSI Ecofuel CNG	1T2/1T3	1.4	110	05.09 -	CDGA	4	0,6	SIZFR6A6D	91629		
Touran 1.6 TDI	1T3	1.6	66	05.10 -	CAYB	4	<input checked="" type="checkbox"/>	Y1002AS	8888	57	
Touran 1.6	1T1/1T2	1.6	75	07.03 - 05.05	BGU	4		BKUR6ET-10	2397	24	LPG 1
Touran 1.6	1T1/1T2	1.6	75	06.05 - 05.10	BSE	4		BKUR6ET-10	2397	24	LPG 1
Touran 1.6	1T1/1T2	1.6	75	06.05 - 05.10	BSF	4		BKUR6ET-10	2397	24	LPG 1
Touran 1.6 FSI	1T1/1T2	1.6	85	02.03 - 05.04	BAG	4		ZFR6S-Q	6449		
Touran 1.6 FSI	1T1/1T2	1.6	85	05.04 - 05.05	BLP	4		ZFR6S-Q	6449		
Touran 1.6 FSI	1T1/1T2	1.6	85	02.05 - 01.07	BLF	4		ZFR6S-Q	6449		
Touran 1.6 TDI	1T3	1.6	77	05.10 -	CAYC	4	<input checked="" type="checkbox"/>	Y1002AS	8888	57	
Touran 1.9 TDI	1T1/1T2	1.9	66	11.04 - 02.06	BRU	4	<input checked="" type="checkbox"/>	Y-607AS	7560	50	
Touran 1.9 TDI	1T1/1T2	1.9	66	02.06 - 05.10	BXF	4	<input checked="" type="checkbox"/>	Y-607AS	7560	50	
Touran 1.9 TDI	1T1/1T2	1.9	66	06.06 - 05.10	BXJ	4	<input checked="" type="checkbox"/>	Y-607AS	7560	50	
Touran 1.9 TDI	1T1	1.9	74	02.03 - 05.04	AVQ	4	<input checked="" type="checkbox"/>	Y-607AS	7560	50	
Touran 1.9 TDI	1T1/1T2	1.9	77	08.03 - 02.06	BKC	4	<input checked="" type="checkbox"/>	Y-607AS	7560	50	
Touran 1.9 TDI	1T1/1T2	1.9	77	06.05 - 05.10	BLS	4	<input checked="" type="checkbox"/>	Y-607AS	7560	50	
Touran 1.9 TDI	1T1/1T2	1.9	77	02.06 - 05.10	BXE	4	<input checked="" type="checkbox"/>	Y-607AS	7560	50	
Touran 2.0 Ecofuel CNG	1T1/1T2	2.0	80	02.06 - 05.09	BSX	4	0,9	BKR6E	6962	28	LPG 1
Touran 2.0 TDI	1T3	2.0	81	05.10 -	CLCA	4	<input checked="" type="checkbox"/>	Y1002AS	8888	57	
Touran 2.0 FSI	1T1	2.0	110	10.03 - 05.04	AXW	4		PZFR5N-11T	7742		
Touran 2.0 FSI	1T1	2.0	110	10.03 - 01.04	BHD	4		PZFR5N-11T	7742		
Touran 2.0 FSI	1T1	2.0	110	05.04 - 11.05	BLX	4		PZFR5N-11T	7742		
Touran 2.0 FSI	1T1	2.0	110	05.04 - 11.05	BLY	4	0,9	BKR6E	6962	28	LPG 1
Touran 2.0 FSI	1T1	2.0	110	02.05 - 11.05	BLR	4		PZFR5N-11T	7742		
Touran 2.0 FSI	1T1	2.0	110	11.05 - 01.07	BVY	4		PZFR5N-11T	7742		
Touran 2.0 FSI	1T1	2.0	110	11.05 - 01.07	BVZ	4	0,9	BKR6E	6962	28	LPG 1
Touran 2.0 TDI	1T1/1T2	2.0	100	02.03 - 05.10	AZV	4	<input checked="" type="checkbox"/>	YE14	7768	48	
Touran 2.0 TDI	1T1/1T2	2.0	103	08.03 - 05.10	BKD	4	<input checked="" type="checkbox"/>	YE14	7768	48	
Touran 2.0 TDI	1T1/1T2	2.0	103	12.05 - 05.10	BMM	4	<input checked="" type="checkbox"/>	Y-607AS	7560	50	
Touran 2.0 TDI	1T3	2.0	103	05.10 -	CFHC	4	<input checked="" type="checkbox"/>	Y1002AS	8888	57	
Touran 2.0 TDI	1T1/1T2	2.0	125	12.05 - 05.10	BMN	4	<input checked="" type="checkbox"/>	CZ304	9864	55	
Touran 2.0 TDI	1T3	2.0	125	05.10 - 01.13	CFJA	4	<input checked="" type="checkbox"/>	Y1002AS	8888	57	
Touran 2.0 TDI	1T3	2.0	130	01.13 -	CFJB	4	<input checked="" type="checkbox"/>	Y1002AS	8888	57	

**UP**

Up 1.0	121	1.0	44	08.11 -	CHYA	3	1,0	ZKER6A-10EG	96596		
Up 1.0	121	1.0	55	08.11 -	CHYB	3	1,0	ZKER6A-10EG	96596		

**VENTO**

Vento 1.4	1H2	1.4	44	11.91 - 07.95	ABD	4		BUR5ET	3377	22	LPG 2
Vento 1.4	1H2	1.4	44	07.95 - 12.97	AEX	4		BUR6ET	3172	1	LPG 2
Vento 1.6	1H2	1.6	55	08.92 - 09.94	ABU	4		BUR6ET	3172	1	LPG 2
Vento 1.6	1H2	1.6	55	10.94 - 07.95	AEA	4		BUR6ET	3172	1	LPG 2
Vento 1.6	1H2	1.6	55	07.95 - 12.97	AEE	4		BUR6ET	3172	1	LPG 2



Code *l* kW

Cyl.

Stock-No.  
**VW**

LPG/CNG

**VW****VENTO**

Vento 1.6	1H2	1.6	74	10.94 - 12.95	AEK	4		BKUR5ET	2789	29	LPG 1
Vento 1.6	1H2	1.6	74	01.96 - 10.00	AFT	4		BKUR6ET-10	2397	24	LPG 1
Vento 1.8	1H2	1.8	55	07.91 - 10.00	AAM	4		BUR5ET	3377	22	LPG 2
Vento 1.8	1H2	1.8	66	11.91 - 07.95	ABS	4		BUR6ET	3172	1	LPG 2
Vento 1.8	1H2	1.8	66	10.94 - 10.00	ADZ	4		BUR6ET	3172	1	LPG 2
Vento 1.9 SDI	1H2	1.9	47	07.95 - 12.97	AEY	4	☑	Y-732J	5605	4	
Vento 1.9 D	1H2	1.9	48	01.92 - 12.97	1Y	4	☑	Y-918J	6285	2	
Vento 1.9 TD	1H2	1.9	55	01.92 - 12.97	AAZ	4	☑	Y-918J	6285	2	
Vento 1.9 TDI	1H2	1.9	66	07.93 - 07.96	1Z	4	☑	Y-732J	5605	4	
Vento 1.9 TDI	1H2	1.9	66	08.96 - 12.97	AHU	4	☑	Y-732J	5605	4	
Vento 1.9 TDI	1H2	1.9	66	05.96 - 12.01	ALE	4	☑	Y-732J	5605	4	
Vento 1.9 TDI	1H2	1.9	81	02.96 - 12.97	AFN	4	☑	Y-732J	5605	4	
Vento 2.0	1H2	2.0	85	11.91 - 09.94	2E	4		BUR6ET	3172	1	LPG 2
Vento 2.0	1H2	2.0	85	10.94 - 05.96	ADY	4		BUR6ET	3172	1	LPG 2
Vento 2.0	1H2	2.0	85	07.95 - 12.01	AGG	4		BUR6ET	3172	1	LPG 2
Vento 2.0	1H2	2.0	85	04.97 - 04.00	AKR	4		BUR6ET	3172	1	LPG 2
Vento 2.8 VR6	1H2	2.8	128	01.92 - 06.95	AAA	6		BKR5EKU	3964		

**WIESMANN**

Coupè GT MF4		4.4	245	05 - 05	N62 B44	8		BKR6EQUP	3199	30	LPG 1
Coupè GT MF4		4.8	270	09.05 -	N62 B48	8	1,1	IZFR6H11	4294		
Coupè GT MF5		5.0	373	07 -	S85 B50	10		LKR8AP	4471		
Roadster MF28		2.8	142	95 -	M52 B28	6		BKR6EK	2288	20	LPG 1
Roadster MF3		3.2	236	95 - 11.01	S50 B32	6	0,7	PKR7A	3641		
Roadster MF3		3.2	252	12.01 -	S54 B32	6		DCPR8EKP	7415		
Roadster MF4-S		4.0	309	03.09 -	S65 B40	8		LKR8AP	4471		

# Conversion Chart

## Vergleichsliste

## Tableau de comparaison thermique

## Tabla de conversión equivalencias

## Jämförelsetabell

## Převodní tabulky

**Note:** This chart is furnished as a guide. Due to differences in design, materials, etc., plugs produced by various manufacturers do not have exactly the same heat range. See recommendations sections for specific engine application.

**Anmerkung:** Diese Liste dient nur zur Information. Wegen der Unterschiede von Konstruktion, Werkstoffen usw. haben die Zündkerzen von verschiedenen Herstellern keinen miteinander übereinstimmenden Wärmebereich. Siehe unsere Empfehlungen für die richtige Anwendung der Zündkerzen.

**Notes:** Cette liste est donnée comme guide. A cause de la différence en dessin, matériels etc., les bougies d'allumage produites par divers fabricans n'ont pas exactement la même gamme thermique. Voir section d'affectations pour utilisation exacte.

**Notas:** Este cuadro se sirve de quia. Bujías que se producen por varios fabricantes no poseen exactamente el mismo alcance térmico debido a las diferencias en diseño, materiales etc. Véase sección de aplicaciones para el uso correcto.

**Observera:** Denna tabell är endast avsedd som vägledning. På grund av avvikelser i utförande, material m.m. kan tändstift av olika fabrikat ej ha exakt samma värmetal. Se rekommendations-tabellen för respektive motor.

**Upozornění:** Převodní tabulky slouží pouze pro srovnávací účely. Zapalovací svíčky od různých výrobců nemají kvůli rozdílné konstrukci, použitému materiálu apod. srovnatelný rozsah tepelných hodnot. Pro správný výběr zapalovací svíčky je třeba se řídit doporučeními firmy NGK v aplikačních tabulkách tohoto katalogu.



ACDelco	→ NGK	V-Line
41-101	ITR4A15	
41-600	TR55IX	
41-601	BPR6ES	2
41-602	FR5	
41-603	FR4	
41-606	TR55	
41-608	FR45	
41-610	FR4	
41-611	FR45	
41-627	BKR4E-11	
41-628	FR4	
41-812	TR6IX	
41-900	TR5	
41-902	TR55	
41-904	TR5	
41-905	UR4	
41-906	TR5	
41-907	TR5	
41-908	BPR5EFIX-13P	
41-910	TR5	
41-913	TR55	
41-919	TR55	
41-921	TR55	
41-928	TR55-1	
41-929	TR55	
41-932	TR55	
41-933	PTR4B-15	
41-936	TR55	
41-940	TR55	
41-942	TR55	
41-943	TR55	
41-947	TR55	
41-948	TR4IX	
41-950	PTR5C-13	
41-952	BPR5EFIX-13P	
41-963	PTR5C-13	
41-974	PZTR5A-15	
41-983	PZTR5A-15	
41-987	PTR5C-13	
40 TS	BP7FS	
41 F	B6HS-10	
41 TS	BP6FS	
41 XL	B9ES	
41 XLS	BP7ES	
42 F	B6HS	
42 FF	B6HS	
42 FS	BP6HS	18
42 S	BP6S	
42 TS	BP6FS	
42 XL	B8ES	
42 XLS	BP6ES	4
43 F	B6HS	

ACDelco	→ NGK	V-Line
43 FFS	BP6HS	18
43 FS	BP6HS	18
43 N	B7ES	
43 S	BP6S	
43 TS	BP6FS	
43 XL	B7ES	
43 XLS	BP6ES	4
44	B6S	
44 F	B5HS	
44 FF	B5HS	
44 FFS	BP5HS	
44 N	B6ES	
44 NS	BP5ES	8
44 S	BP5S	
44 TS	BP5FS	
44 XL	B6ES	
44 XLO	BP5ES	8
44 XLS	BP5ES	8
45	B-4	
45 F	B5HS	
45 FF	B5HS	
45 FFS	BP5HS	
45 L	B-4L	
45 NS	BP5ES	8
45 S	BP5S	
45 TS	BP4FS	
45 XL	B6ES	
45 XLS	BP5ES	8
46	B-4	
46 F	B5HS	
46 FF	B5HS	
46 FFS	BP5HS	
46 N	B5ES	
46 S	BP5S	
46 TS	BP4FS	
46 XL	B5ES	
46 XLS	BP4ES	
47 FF	B-4H	
47 S	BP-4	
47 XL	B4ES	
48	B-4	
83 CTS	AP6FS	
83 TS	AP6FS	
84 T	A6FS	
84 TS	AP5FS	
85 TS	AP5FS	
86 TS	AP5FS	
412 XLS	BP7ES	
414 XLS	BP6ES	4
420 Z	B-4H	
422 Z	B5HS	
425 F	B6HS	



ACDelco	→ NGK	V-Line
425 Z	B6HS	
426 FS	BP6HS	18
430 Z	B7HS	
436 XLS	BP9ES	
438 XLS	BP8ES	
440 T	B7FS	
440 XLS	BP8ES	
445 Z	B8HS	
B 43	B6S	
B 44 FS	BP5HS	
B 44 S	BP5S	
B 45	B-4	
B 4021	B6S	
B 4031	B-4	
C 41	B7S	
C 42 CFS	BP6HS	18
C 42 CLTS	BP6EFS	5
C 42 CXLS	BP6ES	4
C 42 LTS	BP6EFS	5
C 42 N	B7ES	
C 42 XLS	BP5ES	8
C 43	B6S	
C 43 CXLS	BP6ES	4
C 43 L	B-6L	
C 43 N	B6ES	
C 44	B6S	
C 44 N	B6ES	
C 44 NS	BP5ES	8
C 44 S	BP5S	
C 44 XL	B6ES	
C 45	B-4	
C 45 L	B-4L	
C 46	B-4	
C 47	B-4	
C 47 W	B-4	
C 49	B-2	
C 73	G-2Z	
C 75	G-2Z	
C 81	AB-8	
C 82	AB-7	
C 82 T	A7FS	
C 83	AB-7	
C 83 T	A6FS	
C 84 T	A6FS	
C 85	AB-6	
C 85 TS	AP5FS	
C 86	AB-6	
C 87	AB-6	
C 88	AB-2	
C 88 L	AB-2	
C 421	B6S	
CFR 1 CLS	BCPR7ES	

ACDelco	→ NGK	V-Line
CFR 2 CLS	BKR6ES	28
CR 42 CFS	BPR6FS	
CR 42 CXLS	BPR6ES	2
CR 42 N	BR7ES	
CR 43	BR6S	
CR 43 CXLS	BPR6ES	2
CR 43 K	BR6S	
CR 43 N	BR6ES	
CR 43 S	BP6S	
CR 43 TS	BPR5FS-11	
CR 43 TSM	BPR5FS-11	
CR 44 N	BR6ES	
CR 44 NS	BPR5ES	6
CR 44 TS	BPR5FS-11	
CR 45 TS	UR4	
CR 83 T	AR6FS	
CS 40	BM7A	
CS 41	BM7A	
CS 41 T	BM7F	
CS 42	BM7A	
CS 42 S	BM7A	
CS 42 T	BM6F	
CS 45	BM6A	
CS 45 T	BM6F	
CS 49	BM4A	
CSR 45	BMR6A	
FR 2 LS	BKR6ES	28
FR 2 LSK	BKR6ES	28
FR 3 CLS	BKR5ES	35
FR 3 CLS 6	BKR5ES-11	33
FR 3 LM	ZFR5A-11	
FR 3 LS	BKR5ES	35
FR 3 LS 6	BKR5ES-11	33
FR 3 LSJ	BKR4E-11	
FR 3 LSK	BKR5ES	35
FR 4 LE	ZFR4F-11	
FR 4 LSJ	BKR4E-11	
FR 5 LS	BKR5ES	35
LM 46	B4-LM	
LM 49	B4-LM	
M 40 FF	B9HS	
M 40 FFX	B9HS-10	
M 41 FF	B8HS	
M 41 K	B8S	
M 42 FF	B7HS	
M 42 K	B7S	
M 43 FF	B6HS	
M 43 S	BP6S	
M 44 B	B6S	
M 44 C	B6S	
M 44 L	B-6L	
M 45	B-4	



ACDelco	→ NGK	V-Line
M 45 FF	B5HS	
M 47	B-4	
M 86	AB-6	
MB 42 K	B6S	
MC 41	B8S	
MC 41 F	B8HS	
MC 42	B8S	
MC 42 F	B7HS	
MC 44	B7S	
MC 104 F	C6HSA	
MC 121 F	D10HS	
MC 122 F	D8HA	
MC 124 FS	D6HA	
MR 42 K	BR6S	
MR 42 LTS	BPR6EFS	7
MR 43 LTS	BPR6EFS	7
MR 43 T	BR6FS	
MR 44 C	BR6S	
MR 44 T	BR5FS	
MR 45	B-4	
R 41 CF	BR7HS	
R 41 CXL	BR9ES	
R 41 CXLS	BPR7ES	19
R 41 TS	BPR6FS	
R 42 CF	BR6HS	
R 42 CFS	BPR6HS	3
R 42 CLTS	BPR6EFS	7
R 42 CT	BR6FS	
R 42 CTS	BPR6FS	
R 42 CXL	BR8ES	
R 42 CXLS	BPR6ES	2
R 42 FS	BPR6HS	3
R 42 LTS	BPR6EFS	7
R 42 LTSM	BPR5EFS-13	
R 42 S	BP6S	
R 42 T	BR6FS	
R 42 TS	BPR6FS	
R 42 TSM	BPR6FS	
R 42 TX	BR6FS	
R 42 XL	BR8ES	
R 42 XLS	BPR6ES	2
R 42 XLSM	ZGR5C	
R 43	BR6S	
R 43 C	BR6S	
R 43 CFS	BPR6HS	3
R 43 CNTSE	TR5-1	
R 43 CS	BP6S	
R 43 CT	BR6FS	
R 43 CTS	BPR6FS	
R 43 CTS 6	BPR6FS	
R 43 CXL	BR7ES	
R 43 CXLS	BPR6ES	2

ACDelco	→ NGK	V-Line
R 43 FS	BPR6HS	3
R 43 LTS	BPR6EFS	7
R 43 LTSE	TR4	
R 43 LTSX	BPR6EFS-13	
R 43 N	BR7ES	
R 43 NTSE	TR5-1	
R 43 S	BP6S	
R 43 T	BR6FS	
R 43 TS	BPR6FS	
R 43 TSK	BPR6FS	
R 43 TSX	BPR6FS	
R 43 TX	BR6FS	
R 43 XL	BR7ES	
R 43 XLS	BPR6ES	2
R 44	BR6S	
R 44 CF	BR5HS	
R 44 CNTSE	TR5-1	
R 44 CXL	BR6ES	
R 44 CXLS	BPR5ES	6
R 44 F	BR5HS	
R 44 LTS	BPR5EFS	
R 44 LTS 6	BPR5EFS-13	
R 44 LTS 6K	BPR5EFS-13	
R 44 LTSM	TR4	
R 44 LTSM 6	TR4	
R 44 N	BR6ES	
R 44 NS	BPR5ES	6
R 44 NTSE	TR5-1	
R 44 S	BP5S	
R 44 T	BR5FS	
R 44 TS	BPR5FS	
R 44 TSX	BPR5FS-15	
R 44 TX	BR5FS	
R 44 XL	BR6ES	
R 44 XLS	BPR5ES	6
R 44 XLS 6	BPR4ES-13	
R 44 XLSE	ZGR5C	
R 44 XLSM	ZGR5C	
R 45	BR6S	
R 45 LTS 6	BPR5EFS-13	
R 45 LTS 6K	BPR5EFS-13	
R 45 NS	BPR5ES	6
R 45 NSX	BPR5ES-13	
R 45 NTSE	TR5-1	
R 45 S	BP5S	
R 45 T	BR5FS	
R 45 TS	BPR4FS	
R 45 TSX	BPR4FS-15	
R 45 XL	BR6ES	
R 45 XLS	BPR5ES	6
R 46	BR6S	
R 46 LTS	BPR5EFS	





ACDelco	→ NGK	V-Line
R 46 N	BR5ES	
R 46 S	BP-4	
R 46 SZ	XR45IX	
R 46 T	BR5FS	
R 46 TS	BPR4FS	
R 46 TSX	BPR4FS-15	
R 46 TX	BR5FS	
R 46 XL	BR5ES	
R 46 XLS	BPR4ES	
R 47 S	BP-4	
R 83 CT	AR6FS	
R 83 CTS	APR6FS	
R 83 TS	APR6FS	
R 84 TS	APR5FS	
R 85 TS	APR5FS	
R 415 TS	BPR6FS	
R 425 LTS	BPR6EFS	7
R 425 TS	BPR6FS	
R 426 FS	BPR6HS	3
S 40 F	B9HS	
S 40 FR	BR9HS	
S 40 XL	B10ES	
S 40 XLG	B9ECS	
S 40 XLR	BR8ES	
S 41 F	B8HS	
S 41 FG	B7HCS	
S 41 FR	BR8HS	
S 41 XL	B9ES	
S 41 XLG	B8ECS	
S 41 XLR	BR9ES	
S 42	B7S	
S 42 F	B7HS	
S 42 FR	BR7HS	
S 42 XL	B8ES	
S 42 XLR	BR8ES	
S 43 XL	B7ES	
S 43 XLR	BR7ES	
S 44	B6S	
S 44 F	B5HS	
S 44 XL	B6ES	
S 45 F	B5HS	
S 46	B-4	
S 81 F	AB-8	
S 82 F	AB-8	
S 83 F	AB-7	
S 85 F	AB-6	
S 102 F	C7HSA	
S 104 F	C6HSA	
S 121 F	D8HA	
S 121 XL	D8EA	
S 122 F	D8HA	
S 123 XL	D7EA	

ACDelco	→ NGK	V-Line
S 124 FS	D6HA	
S 404 XLG	B10EG	
S 408 XLG	B9EG	
SB 41	B7S	
SN 46	B-4	
SV 4 XL	BUE	
SV 41 XL	BUE	
TC 42	B8S	
TC 45	B6S	
TC 49	B-2	
TC 81	AB-8	
TC 82	AB-8	
TC 83	AB-7	
TC 85	AB-6	
TC 86	AB-6	
V 40 FFK	BUHW-2	
V 40 FFM	BUHW	
V 40 FFS	BUH	
VB 40 FFM	BUHXW-1	
VR 40 FFK	BUZHW-2	
VR 40 FFM	BUZHW	
<b>ALFA ROMEO =&gt; FIAT Group</b>		
<b>AMG =&gt; MERCEDES</b>		
<b>ASTON MARTIN → NGK V-Line</b>		
723 116	BCPR6E	12
<b>AUDI =&gt; VW Group</b>		
<b>AUTOLITE / TUNER → NGK V-Line</b>		
12	BP7FS	
13	BP6FS	
14	BP6FS	
15	BP5FS	
16	BP4FS	
23	BPR6FS	
24	BPR6FS	
25	BPR5FS	
26	BPR4FS-15	
27	BPR4FS-15	
32	AP7FS	
33	AP6FS	
34	AP6FS	
35	AP5FS	
36	AP5FS	
37	AP5FS	
43	APR6FS	
44	APR6FS	



AUTOLITE / TUNER	→ NGK	V-Line
45	APR5FS	
46	APR5FS	
52	BP7ES	
53	BP6ES	4
54	BP6ES	4
55	BP5ES	8
56	BP5ES	8
57	BP4ES	
62	BP7ES	
63	BPR6ES	2
64	BPR6ES	2
65	BPR5ES	6
66	BPR5ES	6
67	BPR4ES	
73	BP6S	
74	BP6S	
75	BP5S	
76	BP5S	
77	BP-4	
84	BP6S	
85	BP5S	
86	BP-4	
87	BP-4	
94	BP7EFS	
102	BP7EFS	
103	BPR6EFS	7
104	BPR6EFS	7
105	BPR5EFS	
106	BPR5EFS	
112	A9FS	
113	A7FS	
115	A6FS	
117	A6FS	
124	AR6FS	
135	B7FS	
136	BR6FS	
143	BR6FS	
144	BR6FS	
145	BR6FS	
146	BR5FS	
147	BR5FS	
156	AP5FS	
166	APR5FS	
175	BP5S	
203	BPR6FS	
215	B-6L	
216	B-6L	
217	B-4L	
218	B-4L	
235	BM6A	
245	BMR6A	
253	BM7A	

AUTOLITE / TUNER	→ NGK	V-Line
254	BM6A	
255	BM6A	
258	BM4A	
273	BP6HS	18
274	BP6HS	18
275	BP5HS	
276	BP5HS	
283	BPR7HS	
284	BPR6HS	3
292	B8S	
294	B6S	
295	B-4	
297	B-4	
298	B-2	
302	BR6S	
303	BR6S	
304	BR6S	
306	B-4	
308	B-2	
312	B8S	
313	B7S	
314	B6S	
315	B6S	
316	B6S	
317	B-4	
318	B-2	
344	AR6FS	
353	B8S	
354	B6S	
355	B6S	
356	B-4	
357	B-4	
358	B-2	
363	BR6S	
372	AB-8	
373	AB-7	
374	AB-7	
375	AB-6	
376	AB-6	
377	AB-6	
378	AB-6	
379	AB-2	
386	AB-6	
393	B7ES	
394	B6ES	
395	B5ES	
396	B5ES	
397	B5ES	
398	B4ES	
402	BR8ES	
403	BR6ES	
404	BR6ES	



AUTOLITE / TUNER	→ NGK	V-Line
405	BR5ES	
406	BR5ES	
411	B9HS	
413	B7HS	
414	B6HS	
415	B5HS	
416	B5HS	
417	B-4H	
424	B6HS	
425	BR5HS	
426	BR5HS	
436	B-6L	
437	B-4L	
472	B9EFS	
483	BR7EFS	
494	B-6L	
495	B-6L	
497	B-4L	
515	BP5HS	
516	BP5HS	
517	BP-4H	
535	B5HS	
536	B-4H	
584	AR6FS	
603	BPR6EFS-13	
604	BPR6EFS-13	
605	BPR6EFS-13	
646	BPR5ES-13	
664	BPR6FS	
665	BPR5FS-15	
666	BPR4FS-15	
667	BPR4FS-15	
683	BR6FS	
684	BR6FS	
685	BR6FS	
687	BR5FS	
723	BPR6FS	
724	BPR6FS	
725	BPR5FS-11	
726	BPR4FS	
727	BPR4FS-11	
744	APR5FS	
746	APR5FS	
747	APR5FS	
763	TR5-1	
764	BPR6EFS	7
765	BPR5EFS	
766	BPR5EFS	
784	AR6FS	
804	AR6FS	
865	BPR5EFS	
884	BPR6EFS-13	

AUTOLITE / TUNER	→ NGK	V-Line
915	ZGR5C	
925	ZGR5C	
935	BPR5ES	6
945	BPR5ES	6
985	ZFR4F-11	
996	B-6L	
2272	AB-7	
2413	B10EGP	
2414	B10EG	
2415	B9EG	
2416	B8EG	
2417	B7ECS	
2543	TR5-1	
2544	TR5-1	
2545	TR5-1	
2546	TR5-1	
2585	BPR5ES	6
2592	B10ES	
2593	B9ES	
2594	B9ES	
2611	B10ES	
2612	B9ES	
2613	B9ES	
2614	B8ES	
2615	B7ES	
2616	B6ES	
2634	B9HS-10	
2635	B8HS	
2636	B7HS	
2652	B9HS-10	
2653	B7HS	
2654	B7HS	
2655	B6HS	
2656	B5HS	
2675	B-6L	
2676	B-6L	
2695	AB-8	
2696	AB-7	
2697	AB-6	
2715	D8HA	
2716	D6HA	
2735	D6HA	
2755	D8EA	
2772	AB-8	
2775	AB-6	
2794	C8HSA	
2795	C7HSA	
2796	C6HSA	
3012	B8S	
3013	B7S	
3014	B6S	
3017	B-4	



AUTOLITE / TUNER	→ NGK	V-Line
3035	AB-6	
3055	A6FS	
3116	AB-6	
3203	BPR6ES	2
3204	BPR6ES	2
3205	BPR5ES	6
3206	BPR5ES	6
3207	BPR5ES	6
3224	BP6S	
3225	BP5S	
3226	BP5S	
3227	BP5S	
3243	BPR6EFS	7
3244	BPR6EFS	7
3245	BPR5EFS	
3246	BPR5EFS	
3264	B7FS	
3265	BR6FS	
3266	BR5FS	
3267	BR5FS	
3286	APR6FS	
3303	BPR6FS	
3325	B-6L	
3327	B-4L	
3364	BPR6HS	3
3382	BR6S	
3383	BR6S	
3384	BR6S	
3386	BR6S	
3388	BR6S	
3404	AR6FS	
3423	B8S	
3426	BR6S	
3462	BR7ES	
3463	BR6ES	
3464	BR6ES	
3465	BR5ES	
3466	BR5ES	
3485	BR5HS	
3486	BR5HS	
3507	B-6L	
3565	BPR5EFS	
3586	BPR5ES-13	
3604	BPR5FS-15	
3605	BPR4FS-15	
3606	BPR4FS-15	
3607	BPR4FS-15	
3624	BR6FS	
3625	BR6FS	
3627	BR5FS	
3684	BR7HS	
3686	BR6HS	

AUTOLITE / TUNER	→ NGK	V-Line
3702	BR9ES	
3703	BR9ES	
3704	BR8ES	
3705	BR6ES	
3706	BR6ES	
3724	BPR5EFS	
3885	ZGR5C	
3896	ZGR5C	
3922	BCPR7ES	
3924	BKR6ES	28
3926	BKR5ES	35
3954	D8EA	
3964	DR8ES-L	
3985	BPR5FS-15	
4043	BPR6ES-11	13
4052	B9ES	
4053	B9ES	
4054	B8ES	
4055	B7ES	
4056	B6ES	
4062	BR9ES	
4063	BR9ES	
4092	B7HS	
4093	B7HS	
4113	BP6HS	18
4114	BP6HS	18
4123	BPR6HS	3
4132	D8EA	
4164	D7EA	
4173	D8HA	
4193	C7HSA	
4203	CR7HS	
4251	BP8ES	
4252	BP7ES	
4253	BP6ES	4
4263	BPR6ES	2
4265	BPR5ES	6
4275	BP5S	
5143	TR5-1	
5224	BKR5E	35
9062	BUR6ET	1
9063	BUR6ET	1
9064	BP5ET	
9921	BCPR6ET	
AP 63	PFR6B	
APP 392 411	BKR5EP-11	
<b>BENTLEY =&gt; VW Group</b>		
<b>BERU → NGK V-Line</b>		
12-5 DU	D7EA	
12 ZR-6 SP2	PLZKBR7A-G	



BERU	→ NGK	V-Line
12 ZR-6 SP03	PLZKBR7A-G	
12 ZR-6 SPP21	PLZKBR7A-G	
12 ZR-7 SP03	PLZKBR7A-G	
14-2 AS1	B9HCS	
14-3 A1	B8HS	
14-3 AS1	BR8HIX	
14-3 AU	B8HS	
14-3 CS1	BR8EIX	
14-3 DP2	BR8EIX	
14-4 A1	B8HS	
14-4 A2	B7HS	
14-4 AS1	BR8HIX	
14-4 AU	B7HS	
14-4 B2	BP7HS	
14-4 C1	B8ES	
14-4 C2	B7ES	
14-4 CS1	BR8EIX	
14-4 DP0	BP7ES	
14-5 A	B7HS	
14-5 AU	B7HS	
14-5 B	BP7HS	
14-5 BU	BP7HS	
14-5 C	B7ES	
14-5 CS	B7ECS	
14-5 D	BP7ES	
14-5 D1	BP7ES	
14-5 DP1	BP7ES	
14-5 DTU	BUR6ET	1
14-5 DU	BP7ES	
14-5 DU0	BP7ES	
14-5 E	B7S	
14-5 F	BP6S	
14-6 B	BP6HS	18
14-6 BU	BP6HS	18
14-6 C	B6ES	
14-6 D	BP6ES	4
14-6 D1	BP6ES	4
14-6 DP0	BP6ES	4
14-6 DTU	BUR6ET	1
14-6 DU	BP6ES	4
14-6 DU0	BP6ESZ	
14-7 A	B6HS	
14-7 AU	B6HS	
14-7 B	BP6HS	18
14-7 BU	BP6HS	18
14-7 C	B6ES	
14-7 CU	B6ES	
14-7 D	BP6ES	4
14-7 DTU	BUR6ET	1
14-7 DU	BP6ES	4
14-7 DU0	BP6ESZ	
14-7 E	B6S	

BERU	→ NGK	V-Line
14-7 F	BP6S	
14-8 A	B5HS	
14-8 AU	B5HS	
14-8 B	BP5HS	
14-8 BU	BP5HS	
14-8 C	B5ES	
14-8 C1	B6ES	
14-8 D	BP5ES	8
14-8 DTU	BP5ET-10	
14-8 DU	BP5ES	8
14-8 DU0	BP5ESZ	
14-8 E	B-4	
14-8 F	BP5S	
14-8 LUR	ZGR5A	15
14-9 C	B5ES	
14-9 D	BP5ES	8
14-9 DTU	BP5ET	
14-9 DU	BP5ES	8
14-9 DU0	BP5ESZ	
14-9 EU0	B4-LM	
14-10 A	B-4H	
14-10 B	BP4HS	
14-10 C	B4ES	
14-10 D	BP4ES	
14-10 E	B-4	
14-10 F	BP-4	
14 F-5 DU	BCP7ES	
14 F-6 DPUR021	PFR7Q	
14 F-6 DSR	BKR6ES	28
14 F-6 DTU	BCP6ET	
14 F-6 DU0	BCP6ES	17
14 F-6 DU0R	BKR6ES	28
14 F-7 DPUR02	PFR6Q	37
14 F-7 DPURX2	IFR6D10	
14 F-7 DU	BCP6ES	17
14 F-7 DU0	BCP6ES	17
14 F-7 DU0R	BKR6ES	28
14 F-7 HPURX2	PZFR5D-11	34
14 F-7 LDUR	BKR6EK	20
14 F-7 LDUR4	BKR6EK	20
14 F-8 DU	BCP5ES	16
14 F-8 DU0	BCP5ES	16
14 F-8 DU4	BCP5ES	16
14 F-8 DUR	BKR6EZB	
14 F-8 LDUSR	BKR6EK	20
14 F-8 LUR	ZFR5F	
14 F-9 DU0	BCP5ES	16
14 FGH-6 DTUR	BKUR6ET	27
14 FGH-7 DPURX2	IFR6D10	
14 FGH-7 DTURX	BKUR6ET-10	24
14 FGH-8 DPURX2	IFR5D10	
14 FGH-8 DTURW	BKUR5ET	29





BERU	→ NGK	V-Line
14 FGR-6 DDU	BKR6EKUB	
14 FGR-7 CTU	BCPR7ET	
14 FR-5 DTU	BCPR7ET	
14 FR-5 DU	BCPR7ES	
14 FR-6 DU	BKR6ES	28
14 FR-6 DUX	BKR6ES-11	14
14 FR-6 LDU	BKR6EK	20
14 FR-6 LDU3	BKR6EKE	
14 FR-6 LDUW	BKR6EKC	26
14 FR-7 DQUP7	BKR6EQUP	30
14 FR-7 DU	BKR6ES	28
14 FR-7 DUX	BKR6ES-11	14
14 FR-7 KPU	BKR6EP-8	
14 FR-7 KPUV	BCPR6EP-11	
14 FR-7 KPUX	BCPR6EP-11	
14 FR-7 KU	BKR6EY	
14 FR-7 KU0	BKR6EYA	
14 FR-7 KU0X	BKR6EYA-11	
14 FR-7 LDU	BKR6EK	20
14 FR-7 LUX	ZFR6F-11	
14 FR-7 MU2	LFR6B	
14 FR-8 DU	BKR5ES	35
14 FR-8 DUX	BKR5ES-11	33
14 FR-8 HU	BCRE527Y	
14 FR-8 KU	BKR5EY	
14 FR-8 KU0U	BKR5EYA-11	39
14 FR-8 KU0	BKR5EYA	
14 FR-8 LDUOX4	BKR5EK	23
14 FR-8 LU2	ZFR5F-11	
14 G-8 DTU	BUR5ET	22
14 GH-7 DTUR	BUR6ET	1
14 GH-8 DTUR	BUR5ET	22
14 GH-8 DTURX	BUR5ET-10	21
14 GR-8 DTU	BPR5EKU	
14 K-5 DU	BP7EFS	
14 K-5 DU0	BP7EFS	
14 K-6 D	BP6EFS	5
14 K-6 DU	BP6EFS	5
14 K-6 DU0	BP6EFS	5
14 K-7 D	BP6EFS	5
14 K-7 DU	BP6EFS	5
14 K-7 DU0	BP6EFS	5
14 K-8 DU	BP5EFS	
14 K-8 DU0	BP5EFS	
14 K-9 DU	BP5EFS	
14 K-9 DU0	BP5EFS	
14 KGR-6 KQU	BUR6EFSZ	
14 KR-6 BU	BPR6FS	
14 KR-6 DU	BPR6EFS	7
14 KR-7 DU	BPR6EFS	7
14 KR-7 DUX	BPR6EFS-13	
14 KR-8 DPU0V	TR55IX	

BERU	→ NGK	V-Line
14 KR-8 MPX	PTR5A-13	25
14 KR-8 MUV	PTR5A-13	25
14 KR-8 STUX	LTR6B-10T	
14 R-5 DU	BPR7ES	19
14 R-6 B	BPR6HS	3
14 R-6 BU	BPR6HS	3
14 R-6 D	BPR6ES	2
14 R-6 DU	BPR6ES	2
14 R-6 DUX	BPR6ES-11	13
14 R-7 B	BPR6HS	3
14 R-7 BU	BPR6HS	3
14 R-7 CU	BR6ES	
14 R-7 D	BPR6ES	2
14 R-7 DU	BPR6ES	2
14 R-7 DUX	BPR6ES-11	13
14 R-8 DU	BPR5ES	6
14 R-8 DUX	BPR5ES-11	
14 R-9 DU	BPR5ES	6
14 R-9 EU0	BR4-LM	
14 R-11 F	BP-4	
14 S-5 A	BL-6H	
14 S-5 F	BPM7A	
14 S-7 A	BL-6H	
14 S-7 F	BPM6A	
14 S-8 F	BPM6A	
14 SR-6 F	BPMR6A	
14 X-AU	B6HS	
14 Z-2 C1	BR9EIX	
14 Z-3 A1	B9HS	
14 Z-3 AU	B9HS	
14 Z-3 C1	B9ES	
14 Z-3 CU	B9ES	
14 Z-4 AU	B8HS	
14 Z-6 A2	B6HS	
14 Z-7 AU	B7HS	
18-4 A1	AB-7	
18-4 A2	AB-7	
18-5 A	AB-7	
18-5 AS	AB-7	
18-5 AU	AB-7	
18-7 A	AB-6	
18-7 AU	AB-7	
18-8 A	AB-6	
18-10 A	AB-6	
18-10 AU	AB-6	
18-12 B	AB-2	
18 K-6 BU	AP6FS	
18 K-7 B	AP6FS	
18 K-7 BU	AP6FS	
18 K-8 B	AP5FS	
18 K-8 BU	AP5FS	
18 K-12 B	AP5FS	



<b>BERU</b>	<b>→ NGK</b>	<b>V-Line</b>
45/18	AP5FS	
95/14	B-4H	
95/14/3	B4ES	
95/14/3A	BP4ES	
95/14/5	B-4	
95/14/5A	BP-4	
95/14A	BP4HS	
95/18	AB-6	
125/14/3	B5ES	
125/14/3A	BP5ES	8
145/14	B5HS	
145/14/3	B5ES	
145/14/3A	BP5ES	8
145/14/5	B-4	
145/14/5A	BP5S	
145/14/5AMX	BPM6A	
145/18	AB-6	
145/18K	AP5FS	
145/1A	BP5HS	
160/14/3	B6ES	
175/14	B6HS	
175/14/3	B6ES	
175/14/3A	BP6ES	4
175/14/5	B6S	
175/14/5A	BP6S	
175/14/5AMX	BPM6A	
175/14/UK4	BL-6H	
175/14A	BP6HS	18
175/18	AB-6	
175/18K	AP6FS	
190/14 Z	B6HS	
200/14/3	B6ES	
200/14/3A	BP6ES	4
200/14/3K	BP6EFS	5
200/14A	BP6HS	18
215/14/3A	BP6ES	4
225/14	B7HS	
225/14/3	B7ES	
225/14/3A	BP7ES	
225/14/3S	B7ECS	
225/14/5	B7S	
225/14/5A	BP6S	
225/14/5AMX	BPM7A	
225/14/UK4	BL-6H	
225/14A	BP7HS	
225/18	AB-7	
225/18S	AB-7	
230/14/3A	BP7ES	
235/14/3P	BP7ES	
240/14	B7HS	
240/14/3	B7ES	
240/14 A	BP7HS	

<b>BERU</b>	<b>→ NGK</b>	<b>V-Line</b>
240/14 S	BR8HIX	
240/18	AB-7	
260/14	B8HS	
260/14/3	B8ES	
260/14 S	BR8HIX	
260/18	AB-8	
265/14/3P	BR8EIX	
280/14	B8HS	
280/14/3S	BR8EIX	
280/14/3Z	B9ES	
280/14Z	B9HS	
310/14/3Z	BR9EIX	
310/14S	B9HCS	
D 175/14	B6HS	
D 175/14/3	B6ES	
D 200/14/3A	BP6ES	4
D 215/14/3	B7ES	
D 230/14/3A	BP7ES	
RS 16	BPR6HIX	
RS 18	BPR7HIX	
RS 33	BPR5EIX	
RS 35	BPR6EIX	
RS 37	BPR7EIX	
RS 39	BPR7EIX	
Z 1	BP5ES	8
Z 2	BP5ET-10	
Z 3	ZGR5A	15
Z 4	ZFR5F	
Z 5	BCP5ES	16
Z 6	BP5EFS	
Z 7	BP5EFS	
Z 8	BPR5ES	6
Z 9	BPR5ES-11	
Z 10	BP6HS	18
Z 11	BP6ES	4
Z 12	BUR6ET	1
Z 13	BKR6ES	28
Z 14	BKR6EK	20
Z 15	BKR6ES	28
Z 16	BKR6ES-11	14
Z 17	BP6EFS	5
Z 18	BP6EFS	5
Z 19	BPR6HS	3
Z 20	BPR6ES	2
Z 21	BPR6ES-11	13
Z 22	BP6ES	4
Z 23	BKR6ES	28
Z 24	BKR6ES	28
Z 25	BP6EFS	5
Z 26	BPR6EFS	7
Z 27	BPR6ES	2
Z 28	BPR6ES-11	13



BERU	→ NGK	V-Line
Z 29	BCP7ES	
Z 30	BCPR7ES	
Z 31	BP7EFS	
Z 32	AP6FS	
Z 33	AP6FS	
Z 35	D7EA	
Z 37	B9HS	
Z 38	B9ES	
Z 39	B8HS	
Z 40	B7HS	
Z 41	BP7HS	
Z 42	BP7ES	
Z 43	BP7ES	
Z 44	BUR6ET	1
Z 45	BCPR7ET	
Z 46	BP7EFS	
Z 47	BPR7ES	19
Z 48	BP6HS	18
Z 49	BPR6FS	
Z 50	BP6ESZ	
Z 51	BUR6ET	1
Z 52	BCP6ET	
Z 53	BCP6ET	
Z 54	BCP6ES	17
Z 55	BP6EFS	5
Z 56	BP6EFS	5
Z 57	B6HS	
Z 58	B6ES	
Z 59	BR6ES	
Z 60	BCPR7ET	
Z 61	BP6ESZ	
Z 62	BP6ESZ	
Z 63	BCP6ES	17
Z 64	BCP6ES	17
Z 67	BPR6EFS-13	
Z 68	B5HS	
Z 69	BP5ESZ	
Z 70	BP5ESZ	
Z 71	BCP5ES	16
Z 72	BKR5ES	35
Z 73	BKR5ES-11	33
Z 74	BKR5EK	23
Z 75	BUR5ET	22
Z 76	BP5ES	8
Z 77	BP5ESZ	
Z 78	BP5ET	
Z 79	BCP5ES	16
Z 80	BP5EFS	
Z 81	BP5EFS	
Z 82	BPR5ES	6
Z 83	B4-LM	
Z 84	BR4-LM	

BERU	→ NGK	V-Line
Z 85	B6HS	
Z 86	AB-7	
Z 87	AB-7	
Z 88	AB-6	
Z 89	BKUR6ET	27
Z 90	BKUR6ET-10	24
Z 91	BUR6ET	1
Z 92	BUR5ET	22
Z 93	BUR5ET-10	21
Z 94	BPR5EKU	
Z 95	BPR6EFS	7
Z 97	PTR5A-13	25
Z 98	BKR6EK	20
Z 99	BKR6ES-11	14
Z 100	BCP5ES	16
Z 101	BKR6EK	20
Z 103	BP7ES	
Z 104	BP6ES	4
Z 105	BKR6ES	28
Z 106	BPMR6A	
Z 107	BP-4	
Z 112	B-4	
Z 116	BKR6EK	20
Z 118	BP5HS	
Z 122	IFR5D10	
Z 132	BPM6A	
Z 144	BUR6EFSZ	
Z 145	BKR6EKUB	
Z 148	TR55IX	
Z 149	BCPR6EP-11	
Z 150	BCPR6EP-11	
Z 151	BKR6EP-8	
Z 152	BCRE527Y	
Z 153	BKR5EY	
Z 154	BKR5EYA	
Z 155	BKR6EY	
Z 156	BKR6EYA	
Z 157	BKR6EYA-11	
Z 158	ZFR6F-11	
Z 171	IFR6D10	
Z 176	PZFR5D-11	34
Z 177	PTR5A-13	25
Z 184	LFR6B	
Z 185	PFR7Q	
Z 188	PFR6Q	37
Z 194	BKR6EKE	
Z 203	ZFR5F-11	
Z 222	LTR6B-10T	
Z 227	BKR6EZB	
Z 233	PLZKBR7A-G	
Z 237	BKR6EQUP	30
Z 245	BKR6EKC	26



BERU	→ NGK	V-Line
Z 246	BKUR5ET	29
Z 249	BKR5EYA-11	39
Z 265	BPM7A	
Z 282	IFR6D10	
Z 288	PLZKBR7A-G	
Z 336	PLZKBR7A-G	
0 001 245 700	D7EA	
0 001 325 701	BP5ES	8
0 001 325 704	BP5ESZ	
0 001 325 705	BCP5ES	16
0 001 325 710	BP5ET	
0 001 330 104	BUR5ET	22
0 001 330 112	BUR5ET-10	21
0 001 330 113	BUR5ET	22
0 001 330 119	BKUR5ET	29
0 001 330 501	BKR6EK	20
0 001 330 702	BP5ES	8
0 001 330 707	BCP5ES	16
0 001 330 709	BP5ET-10	
0 001 330 713	BP5ESZ	
0 001 330 717	ZFR5F	
0 001 330 718	ZGR5A	15
0 001 330 725	BCP5ES	16
0 001 330 726	BP5ESZ	
0 001 330 731	BCP5ES	16
0 001 330 780	BKR6EZB	
0 001 330 904	IFR5D10	
0 001 335 107	BKUR6ET-10	24
0 001 335 108	BUR6ET	1
0 001 335 702	BP6ES	4
0 001 335 707	B6ES	
0 001 335 709	BUR6ET	1
0 001 335 714	BP6ESZ	
0 001 335 721	BCP6ES	17
0 001 335 725	BCP6ES	17
0 001 335 729	BKR6ES	28
0 001 335 732	BKR6EK	20
0 001 335 737	BP6ESZ	
0 001 335 905	IFR6D10	
0 001 335 910	IFR6D10	
0 001 335 911	PZFR5D-11	34
0 001 335 914	PFR6Q	37
0 001 340 103	BKUR6ET	27
0 001 340 702	BP6ES	4
0 001 340 704	BUR6ET	1
0 001 340 706	BCP6ET	
0 001 340 707	BP6ESZ	
0 001 340 716	BCP6ES	17
0 001 340 717	BCP6ET	
0 001 340 723	BKR6ES	28
0 001 340 806	BKR6ES	28
0 001 340 903	BP6ES	4

BERU	→ NGK	V-Line
0 001 340 908	PFR7Q	
0 001 345 702	BP7ES	
0 001 345 704	BUR6ET	1
0 001 345 711	BP7ES	
0 001 345 720	BCP7ES	
0 001 350 903	BP7ES	
0 001 355 700	B9ES	
0 001 400 701	B6HS	
0 001 430 700	BP5HS	
0 001 430 701	B5HS	
0 001 435 700	BP6HS	18
0 001 435 705	B6HS	
0 001 440 700	BP6HS	18
0 001 445 700	BP7HS	
0 001 445 702	B7HS	
0 001 450 702	B8HS	
0 001 455 702	B9HS	
0 001 529 302	B-4	
0 001 625 700	BP5EFS	
0 001 625 702	BP5EFS	
0 001 630 700	BP5EFS	
0 001 630 704	BP5EFS	
0 001 635 700	BP6EFS	5
0 001 635 709	BP6EFS	5
0 001 640 700	BP6EFS	5
0 001 640 704	BP6EFS	5
0 001 640 705	BP6EFS	5
0 001 645 700	BP7EFS	
0 001 645 703	BP7EFS	
0 001 735 700	AP6FS	
0 001 740 700	AP6FS	
0 001 820 700	AB-6	
0 001 835 700	AB-7	
0 001 845 700	AB-7	
0 002 235 901	PLZKBR7A-G	
0 002 240 902	PLZKBR7A-G	
0 002 240 907	PLZKBR7A-G	
0 002 240 911	PLZKBR7A-G	
0 002 325 700	BPR5ES	6
0 002 330 204	BKR5EYA-11	39
0 002 330 701	BPR5ES	6
0 002 330 702	BPR5ES-11	
0 002 330 703	BKR5ES	35
0 002 330 704	BKR5ES-11	33
0 002 330 706	BPR5EKU	
0 002 330 710	BKR5EK	23
0 002 330 712	BCRE527Y	
0 002 330 713	BKR5EY	
0 002 330 714	BKR5EYA	
0 002 330 794	ZFR5F-11	
0 002 335 100	BCPR7ET	
0 002 335 500	BKR6EK	20



BERU	→ NGK	V-Line
0 002 335 701	BPR6ES	2
0 002 335 704	BR6ES	
0 002 335 706	BPR6ES-11	13
0 002 335 707	BKR6ES	28
0 002 335 708	BKR6ES-11	14
0 002 335 712	BKR6EY	
0 002 335 713	BKR6EYA	
0 002 335 714	BKR6EYA-11	
0 002 335 715	ZFR6F-11	
0 002 335 719	LFR6B	
0 002 335 902	BCPR6EP-11	
0 002 335 903	BCPR6EP-11	
0 002 335 904	BKR6EP-8	
0 002 335 911	BKR6EQUP	30
0 002 340 102	BKR6EKUB	
0 002 340 500	BKR6EK	20
0 002 340 501	BKR6EKE	
0 002 340 504	BKR6EKC	26
0 002 340 701	BPR6ES	2
0 002 340 702	BKR6ES	28
0 002 340 703	BPR6ES-11	13
0 002 340 704	BKR6ES-11	14
0 002 345 701	BPR7ES	19
0 002 345 702	BCPR7ES	
0 002 345 704	BCPR7ET	
0 002 435 701	BPR6HS	3
0 002 515 400	BP-4	
0 002 630 701	PTR5A-13	25
0 002 630 715	LTR6B-10T	
0 002 630 900	TR55IX	
0 002 635 700	BPR6EFS	7
0 002 635 701	BPR6EFS-13	
0 002 640 100	BUR6EFSZ	
0 002 640 700	BPR6EFS	7
0 002 640 701	BPR6FS	
0 002 640 900	PTR5A-13	25
0 004 525 700	B4-LM	
0 004 525 701	BR4-LM	
0 004 535 402	BPM6A	
0 004 540 401	BPMR6A	
0 004 545 401	BPM7A	
<b>BM3 (BULGARIA+VMZ) =&gt; BRISK</b>		
BMW	→ NGK	V-Line
11 12 7 675 485	KR9CI	
12 12 0 022 902	DCPR8EKP	
12 12 0 030 548	BKR6EQUP	30
12 12 0 031 708	BKR7EQUP	
12 12 0 032 134	IZFR6H11	
12 12 0 032 136	BKR6EQU	

BMW	→ NGK	V-Line
12 12 0 032 137	ILZFR6D11	
12 12 0 032 273	LKR8AP	
12 12 0 034 094	R6601-9	
12 12 0 034 098	PLZKBR7A-G	
12 12 0 035 531	ILZKBR7A-8G	
12 12 0 035 747	PFR7B	
12 12 0 035 915	PLZFR6A-11S	
12 12 0 037 607	BKR6EQUP	30
12 12 0 037 608	BKR6EQUP	30
12 12 0 038 349	ZKBR7A-HTU	
12 12 0 038 507	SIZKBR8A8HS	
12 12 0 141 871	BKR6EQUP	30
12 12 1 342 836	BKR7EKC	
12 12 1 404 310	PKR7A	
12 12 1 435 955	BKR6EQUP	30
12 12 1 435 956	BKR6EQUP	30
12 12 1 704 399	BKR6EK	20
12 12 2 158 165	PLZKBR7A-G	
12 12 2 158 252	IZFR6H11	
12 12 2 158 253	PLZFR6A-11S	
12 12 2 163 332	PLZKBR7A-G	
12 12 2 343 144	D8EA	
12 12 7 521 111	PLZFR6A-11S	
12 12 7 521 112	ILZFR6D11	
12 12 7 523 457	BKR6EQU	
12 12 7 526 799	IZFR6H11	
12 12 7 534 226	PLZKBR7A-G	
12 12 7 550 011	ZKBR7A-HTU	
12 12 7 550 011 02	ZKBR7A-HTU	
12 12 7 556 979	BKR7EQUP	
12 12 7 570 106	ILZKBR7A-8G	
12 12 7 570 106.02	ILZKBR7A-8G	
12 12 7 600 994	SIZKBR8A8HS	
12 12 7 650 676	BKR7EKC	
12 12 7 650 676.3	BKR7EKC	
12 12 7 653 439	CR8EB	
12 12 7 653 771	BKR7EKC	
12 12 7 664 404	DR8EB	
12 12 7 671 301	DCPR8EKC	
12 12 7 671 302	BKR7EKC	
12 12 7 677 560	DCPR8EKC	
12 12 7 681 415	BKR7EKC	
12 12 7 699 116	KR9CI	
12 12 7 710 636	CR9EKB	
12 12 7 710 681	MAR9B-JDS	
12 12 7 719 772	LMAR9D-J	
12 12 7 722 278	MAR9B-JDS	
12 12 7 726 112	MAR8B-JDS	
12 12 7 728 634	DCPR8EKC	
12 12 7 728 635	KR9CI	
12 12 7 728 657	LMAR8AI-8	
12 12 7 830 787	DCPR8EKP	





<b>BMW</b>	<b>→ NGK</b>	<b>V-Line</b>
12 12 7 830 787.3	DCPR8EKP	
12 12 7 835 198	LKR8AP	
12 12 8 532 942	LMAR8D-J	
12 12 9 061 870	ZFR5F	
12 12 9 063 428	BKR6EK	20
12 12 9 064 617	BKR6EK	20
12 12 9 064 619	BKR6EK	20
12 12 9 064 656	BKR6EK	20
12 12 9 065 366	BKR6EK	20
12 12 9 069 048	PKR7A	
12 12 9 071 003	BKR6EQUP	30
91 47 1 210 043	PFR7B	
<b>BOSCH</b>	<b>→ NGK</b>	<b>V-Line</b>
877 1207	R2349-10	
888 1101	R2349-11	
D 6 BC	AP6FS	
D 7 AC	A6FS	
D 7 BC	AP6FS	
D 8 BC	AP5FS	
D 9 BC	AP5FS	
D 10 BC	AP5FS	
DR 6 BC	APR6FS	
DR 7 BC	APR6FS	
DR 8 BC	APR5FS	
DR 9 BC	APR5FS	
DR 10 BC	APR5FS	
F 03 DAR	BKR6EK	20
F 04 DAR	BKR6EK	20
F 2 CS	R7433-9	
F 2 DTC	R6888A-9	
F 3 CS	R7433-9	
F 4 CS	R7433-8	
F 5 DC	BCP7ES	
F 5 DPOR	PFR7B	
F 5 DTC	BCP7ET	
F 5 KPP 332SB	PFR7S8EG	
F 6 DC	BCP6ES	17
F 6 DCO	BCP6ES	17
F 6 DCOR	BKR6ES	28
F 6 DCX	BCP6ES-11	
F 6 DPOR	PFR6Q	37
F 6 DSR	BKR6EIX	
F 6 DTC	BCP6ET	
F 6 KPP 332S	PFR6Q	37
F 6 LTCR	BKUR7ET	
F 6 MPP 332	ILFR6A	
F 7 DC	BCP6ES	17
F 7 DCO	BCP6ES	17
F 7 DCOR	BKR6ES	28
F 7 DCX	BCP6ES-11	
F 7 DER	BKR6ES	28

<b>BOSCH</b>	<b>→ NGK</b>	<b>V-Line</b>
F 7 DPER	PFR6G-11	
F 7 DPP 332	IFR6D10	
F 7 DTC	BCP6ET	
F 7 HER 02	ZFR6T-11G	
F 7 HPP 22	PFR6Q	37
F 7 HPP 222	PZFR5D-11	34
F 7 HPP 222U	PZFR6J-11	
F 7 HPPRX	PZFR5D-11	34
F 7 KPP 332U	PFR6X-11	
F 7 KTCR	BKUR6ET-10	24
F 7 LCOR2	ZFR6F-11	
F 7 LCR	ZFR6A-11	
F 7 LDCR	BKR6EK	20
F 7 LTCR	BKUR6ET-10	24
F 8 DC	BCP5ES	16
F 8 DCO	BCP5ES	16
F 8 DCO R	BKR5ES	35
F 8 DC4	BCP5ES	16
F 8 DCX	BCP5ES-11	
F 8 DPER	IFR5D10	
F 8 DPP 332	IFR5D10	
F 8 KTCR	BKUR5ET	29
F 8 LCR	ZFR5F	
F 8 LCR2	ZFR5F	
F 8 LDCR	BKR6EK	20
F 9 DCO	BCPR4ES-11	
F 9 LCR	ZFR4F-11	
FGR 5 KQEO	BKR7EQUP	
FGR 6 KQC	BKR6EQUP	30
FGR 6 KQE	BKR6EQUP	30
FGR 7 DQE+	BKR6EKUB	
FGR 7 DQEO	BKR6EKUB	
FGR 7 DQP	BKR6EQUP	30
FGR 7 DQP+	BKR6EQUP	30
FGR 7 KQC	BKR6EQUP	30
FGR 7 KQE	BKR6EQUP	30
FGR 7 KQEO	BKR6EQUA	
FGR 8 KQE	BKR5EKUP	
FGR 8 KQEO	BKR5EQUA	
FGR 8 MQPE	PLFR5A-11	
FLR 8 LDCU	BKR5EK	23
FLR 8 LDCU+	BKR5EK	23
FQR 8 DE	BKR6EZB	
FQR 8 LEU2	ZFR5F-11	
FR 5 DC	BCPR7ES	
FR 5 DCX	BCPR7ES-11	
FR 5 DTC	BCPR7ET	
FR 5 KPP 332S	PFR7S8EG	
FR 5 LDC	BKR7EKC	
FR 6 D 133	IFR6J11	
FR 6 DC	BKR6ES	28
FR 6 DC+	BKR6ES	28



<b>BOSCH</b>	<b>→ NGK</b>	<b>V-Line</b>
FR 6 DC0	BKR6EK	20
FR 6 DC2	BKR6ES	28
FR 6 DCX	BKR6ES-11	14
FR 6 DDC	BKR7EKC	
FR 6 DTC	BCPR6ET	
FR 6 DTCW	BKR5EKC	
FR 6 HI 332	PZFR6R	
FR 6 KDC	BKR6EZ	38
FR 6 KDC+	BKR6EZ	38
FR 6 KDE0	BKR6EKE	
FR 6 KTC	BKUR6ET	27
FR 6 LDC	BKR6EK	20
FR 6 MPP 10	PLFR6A-11	
FR 6 MPP 332	ILFR6A	
FR 7 DC	BKR6ES	28
FR 7 DC+	BKR6ES	28
FR 7 DC0	BKR6ES	28
FR 7 DC2	BKR6ES	28
FR 7 DC4	BKR6ES	28
FR 7 DCX	BKR6ES-11	14
FR 7 DCX+	BKR6ES-11	14
FR 7 DE	BKR6EZ	38
FR 7 DPP+	PFR6B	
FR 7 DPP 10	BKR6EIX	
FR 7 DPP 22U	PFR6N-11	
FR 7 DPP 33	PFR6Q	37
FR 7 DQP	BKR6EQUP	30
FR 7 DTC	BCPR6ET	
FR 7 HCOX	ZFR5E-11	
FR 7 HPP 33+	PZFR5D-11	34
FR 7 KC	BKR6EY	
FR 7 KC+	BKR6EY	
FR 7 KCU	BKR6EYA-11	
FR 7 KCW	BKR6EP-13	
FR 7 KCX	BKR6EY-11	
FR 7 KCX+	BKR6EY-11	
FR 7 KDC	BKR6EZ	38
FR 7 KI30	FR6EI	
FR 7 KPP 33+	PFR6Q	37
FR 7 KPP 332	IZFR6H11	
FR 7 LC2	BKR6ES	28
FR 7 LCX	ZFR6F-11	
FR 7 LCX+	ZFR6F-11	
FR 7 LDC	BKR6EK	20
FR 7 LDC+	BKR6EK	20
FR 7 LDU	BKR6EK	20
FR 7 ME	LFR6A	
FR 7 MPP 10	PLFR6A	
FR 7 NI 33	ILFR6B	
FR 7 NI 332S	ILFR6K8	
FR 7 NPP 332	ILZFR6D11	
FR 7 SI 30	ILZFR6C-11K	

<b>BOSCH</b>	<b>→ NGK</b>	<b>V-Line</b>
FR 8 DC	BKR5ES	35
FR 8 DC+	BKR5ES	35
FR 8 DC0	BKR5ES	35
FR 8 DCX	BKR5ES-11	33
FR 8 DCX+	BKR5ES-11	33
FR 8 DE	BKR5ES	35
FR 8 DPP 33	PFR5R-11	
FR 8 DPP 33+	PFR5R-11	
FR 8 DS	BKR5EIX	
FR 8 DX	BKR5ES-11	33
FR 8 HDC	BKR5EKB-11	
FR 8 HDC+	BKR5EKB-11	
FR 8 KCU	BKR5EYA-11	39
FR 8 KDC	BKR5EK	23
FR 8 LCX	ZFR6F-11	
FR 8 LDC	BKR5EK	23
FR 8 LDC4	BKR5EK	23
FR 8 ME	LFR5B	
FR 8 SPP 332	ILFR5B11	
FR 9 DC	BKR5ES	35
FR 9 DCX	BCPR4ES-11	
FR 9 HC	ZFR4F-11	
FR 10 DCX	BCPR4ES-11	
FR 7 HC+	ZFR6T-11G	
H 2 CS	B9EFS	
H 3 CS	B8EFS	
H 5 DC	BP7EFS	
H 5 DC0	BP7EFS	
H 6 BC	BP6FS	
H 6 DC	BP6EFS	5
H 6 DC0	BP6EFS	5
H 7 CC	BR6EF	
H 7 DC	BP6EFS	5
H 7 DC0	BP6EFS	5
H 7 DCY	BP6EFS-13	
H 8 BC	BP5FS	
H 8 DC	BP5EFS	
H 8 DC0	BP5EFS	
H 8 DCX	BP5EFS-13	
H 9 BC	BP4FS	
H 9 BCY	BPR4FS-15	
H 9 DC	BP5EFS	
H 9 DC0	BP5EFS	
H 10 BC	BP4FS	
H 10 C	BP4FS	
HGR 6 KQC	BUR6EFSZ	
HGR 7 KQC	BUR6EFSZ	
HLR 8 STEX	LTR6B-10T	
HR 6 BC	BPR6FS	
HR 6 DC	BPR6EFS	7
HR 6 DC+	BPR6EFS	7
HR 6 DS	BPR6EFS	7



<b>BOSCH</b>	<b>→ NGK</b>	<b>V-Line</b>
HR 7 DC	BPR6EFS	7
HR 7 DC+	BPR6EFS	7
HR 7 DCX	BPR6EFS-13	
HR 7 DCX+	BPR6EFS-13	
HR 7 DCY	BPR6EFS-15	
HR 7 DCY+	BPR6EFS-15	
HR 7 MPP+	PTR5A-13	25
HR 7 MPP 302	PTR5A-13	25
HR 8 AC	BR5FS	
HR 8 ACY	BR5FS	
HR 8 BC	BPR5FS	
HR 8 BCY	BPR5FS-15	
HR 8 DC+	BPR5EFS	
HR 8 DPP 22U	PTR5D-10	31
HR 8 LCO	TR5-1	
HR 8 MCV+	TR5B-13	
HR 8 MEV	TR5B-13	
HR 9 AC	BR5FS	
HR 9 ACY	BR5FS	
HR 9 BC	BPR4FS	
HR 9 BC+	BPR4FS	
HR 9 BCY	BPR4FS-15	
HR 9 BCY+	BPR4FS-15	
HR 9 DC	BPR5EFS	
HR 9 DCX	BPR5EFS-13	
HR 9 DCY+	TR55	
HR 10 AC	BR5FS	
HR 10 ACY	BR5FS	
HR 10 BC	BPR4FS	
HR 10 BCX	BPR4FS-11	
HR 10 BCY	BPR4FS-15	
HS 5 E	BM7F	
HS 8 E	BM6F	
M 4 AC	AB-7	
M 5 AC	AB-7	
M 7 AC	AB-7	
M 8 AC	AB-6	
M 8 AC0	AB-6	
M 10 AC	AB-6	
M 10 AC0	AB-6	
M 12 B	AP5FS	
U 3 CC	C7E	
U 4 AC	C6HSA	
U 5 AC	C5HSA	
U 6 AC	CR4HSA	
UR 2 AS	CR8HS	
UR 2 CC	CR8E	
UR 3 AC	CR7HSA	
UR 3 AS	CR7HS	
UR 3 CC	CR7E	
UR 4 AS	CR6HS	
UR 6 AC	CR6HS	

<b>BOSCH</b>	<b>→ NGK</b>	<b>V-Line</b>
USR 7 AC	CMR6H	
VR 8 SE	LZKAR7A	
VR 8 SEW	LZKAR7A	
W 2 AC	B9HS	
W 2 AS	BR9HIX	
W 2 C0	B10ES	
W 2 CC	B10ES	
W 2 CS	BR10EIX	
W 3 A0	B8HS	
W 3 AC	B8HS	
W 3 AS	BR8HIX	
W 3 C0	B9ES	
W 3 CC	B9ES	
W 3 CS	BR9EIX	
W 3 DP	BPR8EIX	
W 3 DP0	BPR8EIX	
W 3 DP2	BP8ES	
W 4 AC	B8HS	
W 4 AS	BR8HIX	
W 4 CC	B8ES	
W 4 CPX	B8ES	
W 4 CS	BR8EIX	
W 4 DP	BPR7EIX	
W 4 DP0	BPR8EIX	
W 4 E2	B7S	
W 5 AC	B7HS	
W 5 AS	BR7HIX	
W 5 BC	BP7HS	
W 5 BC	BP7HS-10	
W 5 CC	B7ES	
W 5 CCX	B7ES-11	
W 5 CS	BR7EIX	
W 5 DC	BP7ES	
W 5 DC0	BP7ES	
W 5 DCX	BP7ES-11	
W 5 DTC	BUR6ET	1
W 5 EC	B7S	
W 6 AC	B6HS	
W 6 BC	BP6HS	18
W 6 DC	BP6ES	4
W 6 DC0	BP6ESZ	
W 6 DCX	BP6ES-11	
W 6 DTC	BUR6ET	1
W 6 LTCR	BUR6ET	1
W 7 AC	B6HS	
W 7 AC	B6HS-5	
W 7 A00	B6HS	
W 7 BC	BP6HS	18
W 7 BC	BP6HS-10	
W 7 CC	B6ES	
W 7 CC0	B6ES	
W 7 CCX	B6ES-11	



BOSCH	→ NGK	V-Line
W 7 DC	BP6ES	4
W 7 DC0	BP6ESZ	
W 7 DCR	BPR6ES	2
W 7 DCX	BP6ES-11	
W 7 DTC	BUR6ET	1
W 7 DX	BP6ES-11	
W 7 EC	B6S	
W 7 FC	BP6S	
W 7 LTCR	BUR6ET	1
W 8 AC	B5HS	
W 8 BC	BP5HS	
W 8 CC	B5ES	
W 8 CCX	B5ES	
W 8 DC	BP5ES	8
W 8 DC0	BP5ES	8
W 8 DCX	BP5ES-11	
W 8 DCY	BP5ES-13	
W 8 DTC	BP5ET	
W 8 DTC	BP5ET-10	
W 8 EC	B6S	
W 8 FC	BP5S	
W 8 LCR	ZGR5A	15
W 8 LDCR	BUR6ET	1
W 8 LTCR	BUR5ET-10	21
W 9 AC	B5HS	
W 9 AC0	B5HS	
W 9 CC	B4ES	
W 9 DC	BP5ES	8
W 9 DC0	BP5ES	8
W 9 DCX	BP5ES-11	
W 9 DTC	BP5ET	
W 9 EC	B-4	
W 9 EC0	B4-LM	
W 9 FC	BP5S	
W 9 LC	ZGR5A	15
W 06 CS	B11EGV	
W 07 AS	BR10HIX	
W 07 CS	B10EGV	
W 08 AS	BR9HIX	
W 08 CS	B10EGV	
W 10 AC	B-4H	
W 10 CC	B4ES	
W 10 DC	BP4ES	
W 10 EC	B-4	
W 10 FC	BP-4	
W 12 A	B-4H	
W 12 E	B-2	
WEA	BUH	
WEC	BUE	
WET 1	BUH	
WET 2	BUE	
WR 2 CC	BR10ES	

BOSCH	→ NGK	V-Line
WR 3 CC	BR9ES	
WR 3 CS	BR9EIX	
WR 3 CTC	BR9ET	
WR 4 AC	BR8HS	
WR 4 CC	BR8ES	
WR 5 AC	BR7HS	
WR 5 CC	BR7ES	
WR 5 DC	BPR7ES	19
WR 5 DC+	BPR7ES	19
WR 5 DS	BPR7EIX	
WR 6 BC	BPR6HS	3
WR 6 DC	BPR6ES	2
WR 6 DC+	BPR6ES	2
WR 6 DCX	BPR6ES-11	13
WR 6 DS	BPR6EIX	
WR 6 DTC	BUR6ET	1
WR 7 AC	BR6HS	
WR 7 BC	BPR6HS	3
WR 7 BC+	BPR6HS	3
WR 7 CC	BR6ES	
WR 7 CCX	BR6ES-11	
WR 7 DC	BPR6ES	2
WR 7 DC+	BPR6ES	2
WR 7 DC2	BPR6ES	2
WR 7 DCX	BPR6ES-11	13
WR 7 DCX+	BPR6ES-11	13
WR 7 DS	BPR6EIX	
WR 7 DTC	BUR6ET	1
WR 7 EC	BR6S	
WR 7 F	BP6S	
WR 7 LTC+	BUR6ET	1
WR 8 AC	BR5HS	
WR 8 BC	BPR5HS	
WR 8 BC+	BPR5HS	
WR 8 CC	BR5ES	
WR 8 DC	BPR5ES	6
WR 8 DC+	BPR5ES	6
WR 8 DC0	BPR5ES	6
WR 8 DC4	BPR5ES	6
WR 8 DCX	BPR5ES-11	
WR 8 DCX+	BPR5ES-11	
WR 8 DS	BPR5EIX	
WR 8 EC	BR6S	
WR 8 FC	BP5S	
WR 8 HP	ZGR5C	
WR 8 LC+	ZGR5A	15
WR 8 LTC+	BUR5ET-10	21
WR 9 A0	BR5HS	
WR 9 CC	BR5ES	
WR 9 DC	BPR5ES	6
WR 9 DC+	BPR5ES	6
WR 9 DCX	BPR5ES-11	



BOSCH	→ NGK	V-Line
WR 9 DCX+	BPR5ES-11	
WR 9 DCY	BPR5ES-13	
WR 9 DS	BPR5EIX	
WR 9 EC	BR6S	
WR 9 ECO	BR6S	
WR 9 FC	BP5S	
WR 9 FCY	BP5S	
WR 9 HC	ZGR5C	
WR 9 LC	ZGR5A	15
WR 9 LS	ZGR5A	15
WR 10 AC	BR4HS	
WR 10 E	BR6S	
WR 10 FC	BP-4	
WR 10 FCY	BP-4	
WR 10 LC	ZGR5B	
WR 10 LCV	BPR4ES-13	
WR 11 E0	BR4-LM	
WS 5 E	BM7A	
WS 5 F	BPM7A	
WS 6 E	BM6A	
WS 6 F	BPM6A	
WS 7 E	BM6A	
WS 7 F	BPM6A	
WS 8 E	BM6A	
WS 8 F	BPM6A	
WS 9 EC	BM4A	
WSR 5 F	BPMR7A	
WSR 6 E	BMR6A	
WSR 6 F	BPMR7A	
WSR 7 F	BPMR6A	
WSR 9 EC	BMR4A	
X 3 CP0	D9EA	
X 4 CS	D8EA	
X 5 CC	D8EA	
X 5 DC	DP7EA-9	
XR 2 AS	DR8HS	
XR 2 CS	DR8ES	
XR 4 AS	DR8HS	
XR 4 CS	DR8ES	
XR 4 DC	DPR8EA-9	
XR 5 DC	DPR7EA-9	
XR 6 CC	DR7EA	
XR 7 LDC	DPR7EA-9	
Y 6 DC	DCP6E	
YR 5 DDE	KR9CI	
YR 5 LDE	DCPR8EKC	
YR 6 LDE	DCPR8EKC	
YR 6 NPP 332	PLKR7B8E	
YR 7 DC+	ZKR7A-10	
YR 7 DE	DCPR8E-N	
YR 7 MPP 33	PLKR7A	
ZQR 8 SI 302	PLZKBR7A-G	

BOSCH	→ NGK	V-Line
ZR 7 SI 332 S	PLZKBR7A-G	
+1	BPR6ES	2
+2	BUR6ET	1
+3	BPR5ES	6
+4	BUR5ET-10	21
+5	BPR6EFS	7
+6	BKR5ES	35
+7	BKR6EK	20
+8	BKR6ES	28
+9	BKR5EK	23
+10	BPR6HS	3
+11	BKR6ES-11	14
+12	BPR6ES	2
+13	BKR6ES	28
+14	BPR5EFS	
+15	BPR7ES	19
+16	BPR5ES	6
+17	PTR5A-13	25
+18	BPR6EFS	7
+19	BKR5ES-11	33
+20	BPR5HS	
+21	BPR6ES-11	13
+22	BPR5ES-11	
+23	BKR6EKUB	
+24	PFR6B	
+25	BPR4FS	
+26	TR55	
+27	BPR5ES-11	
+31	BKR6EY-11	
+32	ZFR6F-11	
+33	BPR4FS-15	
+34	ZGR5A	15
+36	BKR5EKB-11	
+37	BPR6EFS-15	
+39	TR5B-13	
+45	PFR5R-11	
+46	BPR6EFS-13	
+47	BKR6EY	
+48	BKR6EQU	30
+50	PFR6Q	37
+52	PZFR5D-11	34
+53	BKR6EZ	38
0 241 040 501	CR4HSA	
0 241 045 001	C5HSA	
0 241 050 002	C6HSA	
0 241 056 501	C7E	
0 241 140 500	DCP6E	
0 241 145 003	DP7EA-9	
0 241 145 504	DP7EA-9	
0 241 145 507	D8EA	
0 241 150 502	D8EA	
0 241 200 500	BUH	





BOSCH	→ NGK	V-Line
0 241 209 003	B-4H	
0 241 219 536	BP-4	
0 241 219 537	BP4FS	
0 241 219 540	B-4H	
0 241 219 541	B4ES	
0 241 219 542	BP4ES	
0 241 219 543	B-4H	
0 241 219 554	B-4	
0 241 225 013	BP5ES	8
0 241 225 543	BP4FS	
0 241 225 545	BP5ES	8
0 241 225 547	B4ES	
0 241 225 548	B-4	
0 241 225 549	B5HS	
0 241 225 550	BP5ES	8
0 241 225 555	BPR4FS-15	
0 241 225 556	BP5ES	8
0 241 225 558	BP5EFS	
0 241 225 573	BP5EFS	
0 241 225 574	BCPR4ES-11	
0 241 225 576	BP5ET	
0 241 225 582	BP5ES-11	
0 241 225 585	ZGR5A	15
0 241 225 589	BM4A	
0 241 225 590	B4-LM	
0 241 229 059	ZGR5A	15
0 241 229 060	BP5ET-10	
0 241 229 061	BP5ES	8
0 241 229 062	BP5ES	8
0 241 229 541	BM6F	
0 241 229 560	BM6A	
0 241 229 561	BPM6A	
0 241 229 574	BP5ES	8
0 241 229 578	BP5HS	
0 241 229 579	B5ES	
0 241 229 580	B6S	
0 241 229 588	BP5ES	8
0 241 229 593	BP5S	
0 241 229 594	BP5FS	
0 241 229 596	BP5ES-11	
0 241 229 604	B5HS	
0 241 229 612	B5HS	
0 241 229 617	BP5EFS	
0 241 229 619	BP5ET	
0 241 229 634	BCP5ES	16
0 241 229 639	ZFR5F	
0 241 229 641	BP5HS	
0 241 229 649	BP5EFS	
0 241 229 657	ZFR5F	
0 241 229 661	BUR6ET	1
0 241 229 663	BUR5ET-10	21
0 241 229 665	BUR5ET	22

BOSCH	→ NGK	V-Line
0 241 229 666	BKR6EK	20
0 241 229 676	BKUR5ET	29
0 241 229 682	BCP5ES-11	
0 241 229 684	BKR5ES	35
0 241 229 704	IFR5D10	
0 241 229 713	BCP5ES	16
0 241 229 926	BP5ES	8
0 241 235 089	B6ES	
0 241 235 098	B6ES	
0 241 235 099	BPR6ES	2
0 241 235 103	BP6ESZ	
0 241 235 108	BCP6ET	
0 241 235 563	BP6ES	4
0 241 235 564	BP6HS	18
0 241 235 566	BM6A	
0 241 235 567	BPM6A	
0 241 235 574	B6ES	
0 241 235 585	BP6HS-10	
0 241 235 594	B6S	
0 241 235 602	BP6ES	4
0 241 235 607	B6HS	
0 241 235 610	BP6ES-11	
0 241 235 619	B6HS-5	
0 241 235 623	BP6S	
0 241 235 633	BUR6ET	1
0 241 235 635	BP6EFS	5
0 241 235 636	BP6EFS	5
0 241 235 638	BR6EF	
0 241 235 643	BUR6ET	1
0 241 235 646	BP6EFS-13	
0 241 235 668	BP6EFS	5
0 241 235 673	BCP6ES	17
0 241 235 674	ZFR6A-11	
0 241 235 676	BCP6ES	17
0 241 235 681	BP6EFS	5
0 241 235 685	BCP6ES-11	
0 241 235 690	BKR6EK	20
0 241 235 692	ZFR6F-11	
0 241 235 693	BP6ESZ	
0 241 235 698	BUR6ET	1
0 241 235 705	BP6ESZ	
0 241 235 706	BKUR6ET-10	24
0 241 235 715	PZFR5D-11	34
0 241 235 736	BKR6ES	28
0 241 235 739	IFR6D10	
0 241 240 057	BP6ESZ	
0 241 240 058	BP6ESZ	
0 241 240 524	BP6EFS	5
0 241 240 530	BP6ES	4
0 241 240 532	BP6HS	18
0 241 240 539	BP6ES	4
0 241 240 542	BCP6ES	17



<b>BOSCH</b>	<b>→ NGK</b>	<b>V-Line</b>
0 241 240 543	BP6FS	
0 241 240 558	BUR6ET	1
0 241 240 563	BP6EFS	5
0 241 240 564	BCP6ET	
0 241 240 569	BCP6ES-11	
0 241 240 574	BP6ES-11	
0 241 240 578	BP6EFS	5
0 241 240 585	BKR6EIX	
0 241 240 587	BKR6ES	28
0 241 240 592	BKUR7ET	
0 241 240 600	BM6A	
0 241 240 601	BPM6A	
0 241 240 603	B6HS	
0 241 240 631	ILFR6A	
0 241 245 070	BUR6ET	1
0 241 245 539	BM7F	
0 241 245 552	BP7ES	
0 241 245 553	BP7HS	
0 241 245 554	BM7A	
0 241 245 555	BPM7A	
0 241 245 570	BP7EFS	
0 241 245 574	BR7HIX	
0 241 245 575	BR7EIX	
0 241 245 580	B7HS	
0 241 245 581	B7ES	
0 241 245 592	B7S	
0 241 245 599	BP7ES	
0 241 245 602	B7HS	
0 241 245 603	B7ES	
0 241 245 619	BP7HS	
0 241 245 636	BP7EFS	
0 241 245 641	PFR7B	
0 241 245 642	BCP7ES	
0 241 245 646	BP7HS-10	
0 241 248 531	B8HS	
0 241 248 534	B8ES	
0 241 248 538	B8ES	
0 241 248 540	B8HS	
0 241 250 502	BPR8EIX	
0 241 250 512	BPR8EIX	
0 241 250 526	R7433-8	
0 241 252 521	BR8HIX	
0 241 255 505	B8EFS	
0 241 255 507	R7433-9	
0 241 256 512	B8HS	
0 241 256 514	BR8HIX	
0 241 256 515	BR9EIX	
0 241 256 517	BPR8EIX	
0 241 256 519	B8HS	
0 241 256 522	B9ES	
0 241 260 507	B9HS	
0 241 260 508	B10ES	

<b>BOSCH</b>	<b>→ NGK</b>	<b>V-Line</b>
0 241 260 510	B9EFS	
0 241 260 512	R7433-9	
0 241 262 505	BR9HIX	
0 241 262 506	BR10EIX	
0 241 268 505	BR9HIX	
0 241 268 506	B10EGV	
0 241 274 504	BR10HIX	
0 241 274 505	B10EGV	
0 241 280 503	B11EGV	
0 241 309 501	AP5FS	
0 241 319 510	AP5FS	
0 241 319 512	AB-6	
0 241 319 513	AB-6	
0 241 325 509	AP5FS	
0 241 329 520	AP5FS	
0 241 329 525	AB-6	
0 241 329 526	AB-6	
0 241 335 516	AP6FS	
0 241 335 520	A6FS	
0 241 335 524	AB-7	
0 241 335 526	AB-7	
0 241 340 501	AP6FS	
0 241 345 512	AB-7	
0 241 350 505	AB-7	
0 242 035 500	CMR6H	
0 242 040 500	CR6HS	
0 242 050 500	CR6HS	
0 242 055 500	CR7HS	
0 242 055 501	CR7HSA	
0 242 055 502	CR7E	
0 242 060 500	CR8HS	
0 242 060 501	CR8E	
0 242 129 503	LZKAR7A	
0 242 129 508	LZKAR7A	
0 242 129 512	PLZKBR7A-G	
0 242 135 500	DPR7EA-9	
0 242 135 501	DCPR8E-N	
0 242 135 509	PLKR7A	
0 242 135 515	ZKR7A-10	
0 242 135 518	PLZKBR7A-G	
0 242 140 500	DR7EA	
0 242 140 504	DCPR8EKC	
0 242 140 512	PLKR7B8E	
0 242 145 500	DPR7EA-9	
0 242 145 501	DPR7EA-9	
0 242 145 503	DCPR8EKC	
0 242 145 504	KR9CI	
0 242 150 500	DR8HS	
0 242 150 501	DR8ES	
0 242 150 505	DPR8EA-9	
0 242 160 501	DR8ES	
0 242 215 502	BR4-LM	



BOSCH	→ NGK	V-Line
0 242 219 004	BR4HS	
0 242 219 511	BPR4FS-15	
0 242 219 512	BP-4	
0 242 219 513	BP-4	
0 242 219 514	BR5FS	
0 242 219 515	BR5FS	
0 242 219 516	BPR4FS	
0 242 219 517	BPR4FS-11	
0 242 219 519	BCPR4ES-11	
0 242 219 520	BP-4	
0 242 219 529	ZGR5B	
0 242 219 530	BPR4ES-13	
0 242 225 522	BR6S	
0 242 225 523	BR5ES	
0 242 225 524	BPR5ES	6
0 242 225 525	BPR5ES-13	
0 242 225 526	BP5S	
0 242 225 527	BP5S	
0 242 225 528	ZGR5C	
0 242 225 529	BR5FS	
0 242 225 530	BR5FS	
0 242 225 531	BPR4FS	
0 242 225 532	BPR4FS-15	
0 242 225 533	BPR5EFS	
0 242 225 534	BPR5EFS-13	
0 242 225 536	BR6S	
0 242 225 537	ZFR4F-11	
0 242 225 538	BPR5EIX	
0 242 225 539	ZGR5A	15
0 242 225 548	BPR5ES-11	
0 242 225 549	BCPR4ES-11	
0 242 225 550	BPR5ES	6
0 242 225 582	BKR5ES	35
0 242 225 599	BPR5ES	6
0 242 225 612	BMR4A	
0 242 225 622	BPR4FS	
0 242 225 623	TR55	
0 242 225 624	BPR5ES-11	
0 242 225 641	BPR4FS-15	
0 242 225 859	BPR5ES	6
0 242 225 861	BPR5ES	6
0 242 229 524	BR6S	
0 242 229 525	BP5S	
0 242 229 526	BR5FS	
0 242 229 528	BPR5FS	
0 242 229 529	BPR5FS-15	
0 242 229 530	BKR5ES-11	33
0 242 229 531	BPR5ES	6
0 242 229 533	BR5ES	
0 242 229 534	BR5HS	
0 242 229 537	BPR5EIX	
0 242 229 538	BPR5ES	6

BOSCH	→ NGK	V-Line
0 242 229 566	BPR5ES-11	
0 242 229 568	BKR5ES	35
0 242 229 570	BPR5ES	6
0 242 229 576	ZFR6F-11	
0 242 229 587	BKR5ES	35
0 242 229 589	BPR5HS	
0 242 229 591	BKR5EK	23
0 242 229 594	BKR5ES	35
0 242 229 598	BKR5EIX	
0 242 229 605	BKR5EK	23
0 242 229 607	BPR5ES	6
0 242 229 610	BPR5HS	
0 242 229 613	BKR5EKUP	
0 242 229 626	BKR5EK	23
0 242 229 628	BKR5EK	23
0 242 229 630	LFR5B	
0 242 229 634	PLFR5A-11	
0 242 229 635	BKR5EYA-11	39
0 242 229 641	PTR5D-10	31
0 242 229 648	BKR5EQUPA	
0 242 229 650	TR5B-13	
0 242 229 654	BKR5EK	23
0 242 229 655	BPR5EFS	
0 242 229 656	BPR5ES	6
0 242 229 657	BPR5HS	
0 242 229 658	BUR5ET-10	21
0 242 229 659	BKR5ES	35
0 242 229 660	BKR5ES-11	33
0 242 229 661	LTR6B-10T	
0 242 229 671	BKR5EKB-11	
0 242 229 673	BKR5ES	35
0 242 229 687	BPR5ES-11	
0 242 229 699	ZFR5F-11	
0 242 229 708	ILFR5B11	
0 242 229 713	PFR5R-11	
0 242 229 724	BKR6EZB	
0 242 229 779	ZGR5A	15
0 242 229 781	BKR5EKB-11	
0 242 229 785	TR5B-13	
0 242 229 878	BKR5EK	23
0 242 229 879	BPR5EFS	
0 242 229 880	BPR5ES	6
0 242 229 881	BPR5HS	
0 242 229 882	BUR5ET-10	21
0 242 229 883	BKR5ES	35
0 242 229 884	BKR5ES-11	33
0 242 229 885	BPR5ES-11	
0 242 229 887	BKR5EK	23
0 242 229 925	PFR5R-11	
0 242 229 982	BPR5ES	6
0 242 230 500	PFR5R-11	
0 242 235 511	BPR6ES	2



BOSCH	→ NGK	V-Line
0 242 235 522	BPR6HS	3
0 242 235 525	BPR6EIX	
0 242 235 529	BPR6ES	2
0 242 235 530	BPR6ES-11	13
0 242 235 532	BR6ES	
0 242 235 533	BR6HS	
0 242 235 537	BPR6ES	2
0 242 235 538	BPR6EFS	7
0 242 235 542	BPR6EFS	7
0 242 235 543	BR6ES-11	
0 242 235 544	BKR6ES-11	14
0 242 235 551	BKR6ES	28
0 242 235 554	BR6S	
0 242 235 564	BCPR6ET	
0 242 235 567	ZFR6F-11	
0 242 235 571	BUR6ET	1
0 242 235 577	BPR6EFS-15	
0 242 235 579	BKR6ES	28
0 242 235 587	BKR6ES	28
0 242 235 588	BKR6ES	28
0 242 235 589	BKR6EK	20
0 242 235 590	BUR6ET	1
0 242 235 592	BPR6EFS-13	
0 242 235 597	BKR6ES	28
0 242 235 599	BKR6EY	
0 242 235 602	BKR6EY-11	
0 242 235 605	BKR6EK	20
0 242 235 607	BUR6EFSZ	
0 242 235 609	BKR6EZ	38
0 242 235 610	BKR6EP-13	
0 242 235 616	BKR6ES	28
0 242 235 617	BKR6EQUP	30
0 242 235 624	BKR6ES	28
0 242 235 630	BPR6ES	2
0 242 235 636	LFR6A	
0 242 235 640	BKR6EZ	38
0 242 235 642	BKR6EKUB	
0 242 235 651	BPMR6A	
0 242 235 656	BKR6EQUP	30
0 242 235 659	BKR6EYA-11	
0 242 235 661	BPR6EFS	7
0 242 235 663	BPR6ES	2
0 242 235 664	BUR6ET	1
0 242 235 665	BPR6HS	3
0 242 235 666	BKR6ES	28
0 242 235 667	BKR6ES-11	14
0 242 235 668	BKR6EK	20
0 242 235 690	PFR6N-11	
0 242 235 692	ZFR5E-11	
0 242 235 699	BKR6EIX	
0 242 235 707	BPR6ES-11	13
0 242 235 715	BKR6EQUA	

BOSCH	→ NGK	V-Line
0 242 235 740	PFR6Q	37
0 242 235 743	PLFR6A	
0 242 235 748	BKR6EKUB	
0 242 235 749	PFR6B	
0 242 235 767	PTR5A-13	25
0 242 235 769	ILZFR6C-11K	
0 242 235 776	IZFR6H11	
0 242 235 908	BPR6EFS	7
0 242 235 909	BPR6ES	2
0 242 235 910	BUR6ET	1
0 242 235 911	BPR6HS	3
0 242 235 912	BKR6ES	28
0 242 235 913	BKR6ES-11	14
0 242 235 914	BKR6EK	20
0 242 235 915	BPR6ES-11	13
0 242 235 916	PTR5A-13	25
0 242 235 917	BKR6EKUB	
0 242 235 918	PFR6B	
0 242 235 930	BPR6ES	2
0 242 235 931	BUR6ET	1
0 242 235 979	BPR6EFS-13	
0 242 235 980	BKR6EY	
0 242 235 981	BKR6EQUP	30
0 242 235 982	PFR6Q	37
0 242 235 984	PZFR5D-11	34
0 242 235 985	BKR6EY-11	
0 242 235 986	ZFR6F-11	
0 242 236 510	ILZFR6D11	
0 242 236 528	ILFR6B	
0 242 236 541	BKR6EY-11	
0 242 236 542	ZFR6F-11	
0 242 236 543	BPR6EFS-15	
0 242 236 560	BPR6EFS-13	
0 242 236 561	BKR6EY	
0 242 236 562	BKR6EQUP	30
0 242 236 564	PFR6Q	37
0 242 236 565	ZFR6T-11G	
0 242 236 566	PZFR5D-11	34
0 242 236 577	ILFR6K8	
0 242 240 511	BPR6ES	2
0 242 240 514	BPR6EFS	7
0 242 240 516	BPR6EIX	
0 242 240 519	BPR6EFS	7
0 242 240 520	BPR6FS	
0 242 240 526	BKR6ES	28
0 242 240 528	BCPR6ET	
0 242 240 531	BPR6ES-11	13
0 242 240 539	BKR6ES-11	14
0 242 240 546	BUR6ET	1
0 242 240 547	BKR5EKC	
0 242 240 557	BKR6EK	20
0 242 240 561	BPR6HS	3



<b>BOSCH</b>	<b>→ NGK</b>	<b>V-Line</b>
0 242 240 562	BKR6EZ	38
0 242 240 565	BKR7EKC	
0 242 240 566	BKR6EK	20
0 242 240 569	BUR6EFSZ	
0 242 240 572	BKUR6ET	27
0 242 240 576	BPMR7A	
0 242 240 579	BPR6ES	2
0 242 240 582	BMR6A	
0 242 240 584	BKR6EKE	
0 242 240 587	BKR6EQUF	30
0 242 240 591	BPR6EFS	7
0 242 240 592	BPR6ES	2
0 242 240 593	BKR6ES	28
0 242 240 619	ILFR6A	
0 242 240 648	BKR6EZ	38
0 242 240 665	PZFR6R	
0 242 240 848	BPR6EFS	7
0 242 240 849	BPR6ES	2
0 242 240 850	BKR6ES	28
0 242 240 851	BKR6ES	28
0 242 245 018	BKR7EKC	
0 242 245 514	BPR7EIX	
0 242 245 515	BCPR7ES	
0 242 245 517	BR7HS	
0 242 245 521	BR7ES	
0 242 245 533	BPMR7A	
0 242 245 536	BCPR7ES	
0 242 245 537	BPR7ES	19
0 242 245 539	BCPR7ET	
0 242 245 550	BCPR7ES-11	
0 242 245 552	BPR7ES	19
0 242 245 559	BKR7EQUF	
0 242 245 576	PFR7S8EG	
0 242 245 812	BPR7ES	19
0 242 250 503	BR8ES	
0 242 250 506	BR8HS	
0 242 255 501	BR9ET	
0 242 255 502	BR9ES	
0 242 255 504	BR9EIX	
0 242 260 001	BR10ES	
0 242 319 501	APR5FS	
0 242 325 501	APR5FS	
0 242 329 503	APR5FS	
0 242 335 504	APR6FS	
0 242 340 501	APR6FS	
F 000 KE0 017	BKUR6ET-10	24
F 000 KE0 P34	BPR6ES	2
F 5KP P33 2GF	PFR8S8EG	
<b>BOSNA =&gt; ENKER</b>		

<b>BRISK</b>	<b>→ NGK</b>	<b>V-Line</b>
B 12 YC	DP9EA-9	
B 14 YC	DP8EA-9	
B 15 YC	DP7EA-9	
D 12 YC	BCP7ES	
D 14 Y	BCP7ES	
D 14 YC	BCP7ES	
D 15 Y	BCP6ES	17
D 15 YC	BCP6ES	17
D 17 Y	BCP5ES	16
D 17 YC	BCP5ES	16
DOX 15 LE 1	ZFR6T-11G	
DR 12 YC	BKR7E	
DR 14 YC	BKR7E	
DR 14 ZC	ZFR7F-11	
DR 14 ZC 1	BCPR7ES-11	
DR 15 YC	BKR6ES	28
DR 15 Z	BKR6ES	28
DR 15 Z 1	BKR6ES-11	14
DR 17 YC	BKR5ES	35
F 14 YC	AP7FS	
F 15 YC	AP6FS	
FR 14 YC	APR6FS	
FR 15 YC	APR6FS	
G 12 YC	BP7EFS	
G 14 Y	BP7EFS	
G 14 YC	BP7EFS	
G 15 Y	BP6EFS	5
G 15 YC	BP6EFS	5
G 17 Y	BP5EFS	
G 17 YC	BP5EFS	
GR 15 YC	BPR6EFS	7
GR 17 YC	BPR5EFS	
K 15 YC	BP6S	
K 17 C	B6S	
K 17 Y	BP5S	
K 19	B-4	
L 08 JW	B10EGV	
L 08 W	B11EGV	
L 10 JW	B8EGV	
L 12 W	BR9EIX	
L 12 Y	BP8ES	
L 12 YC	BP8ES	
L 14	B8ES	
L 14 C	B8ES	
L 14 Y	BP7ES	
L 14 YC	BP7ES	
L 15	B7ES	
L 15 C	B7ES	
L 15 W	BR7EIX	
L 15 Y	BP6ES	4
L 15 YC	BP6ES	4
L 17	B6ES	





<b>BRISK</b>	<b>→ NGK</b>	<b>V-Line</b>
L 17 C	B6ES	
L 17 W	BR7EIX	
L 17 Y	BP5ES	8
L 17 YC	BP5ES	8
L 19 C	B5ES	
LR 12 YC	BPR8ES	
LR 12 ZC	BPR8ES	
LR 14 TXS	BUR6ET	1
LR 14 YC	BPR7ES	19
LR 14 ZC	BPR7ES	19
LR 14 ZC 1	BPR7ES-11	
LR 15 TXS	BUR6ET	1
LR 15 YC	BPR6ES	2
LR 15 Z	BPR6ES	2
LR 15 Z 1	BPR6ES-11	13
LR 17 YC	BPR5ES	6
N 08 W	BR10HIX	
N 12 W	BR9HIX	
N 12 Y	BP8HS	
N 12 YC	BP8HS	
N 14	B8HS	
N 14 C	B8HS	
N 14 Y	BP7HS	
N 14 YC	BP7HS	
N 15	B7HS	
N 15 C	B7HS	
N 15 W	BR8HIX	
N 15 Y	BP6HS	18
N 15 YC	BP6HS	18
N 17	B6HS	
N 17 C	B6HS	
N 17 W	BR7HIX	
N 17 Y	BP5HS	
N 17 YC	BP5HS	
N 19	B5HS	
N 19 C	B5HS	
NR 12 YC	BPR8HS	
NR 15 YC	BPR6HS	3
<b>BUICK =&gt; GM</b>		
<b>CADILLAC =&gt; GM</b>		
<b>CHAMPION</b>	<b>→ NGK</b>	<b>V-Line</b>
860	A6FS	
2301	BPR5ES-11	
2322	BPR4ES-11	
2332	BPR6ES	2
2338	BKR6ES	28
2415	BPR5ES	6
2430	BKR5E-11	33
3322	BPR5EIX-11	

<b>CHAMPION</b>	<b>→ NGK</b>	<b>V-Line</b>
3344	BKR6EIX-11	
3407	TR5-1IX	
5828	BZ7HS-10	
5843	BM7A	
5846	BM6A	
5847	BM6F	
5861	B2-LM	
5883	BR7HS	
5931	BR6HS	
5933	B6HS	
5939	BPR7HS	
88 091	DPR7EA-9	
9 179 100	PFR6G	
9 202 064	BKR6EKUB	
A 4 HC	DP9EA-9	
A 5 YC	DP9EA-9	
A 6	D8EA	
A 6 G	DR8EIX	
A 6 GC	DR8EIX	
A 6 HC	DP8EA-9	
A 6 Y	DP8EA-9	
A 6 YC	DP8EA-9	
A 8	D7EA	
A 8 Y	DP7EA-9	
A 8 YC	DP7EA-9	
A 10	D7EA	
A 50 R	R2349-11	
A 51 R	R2525-10	
A 53 C	R2349-11	
A 53 R	R2349-11	
A 55 C	R2525-10	
A 55 R	R2525-10	
A 55 V	R2349-11	
A 57 CST	R2525-10	
A 57 G	R2525-10	
A 59 C	D9EA	
A 59 G	DR9EIX	
A 59 GC	DCPR9EIX	
A 61	D9EA	
A 61 G	DR9EIX	
BL 4	B7FS	
BL 5	B7FS	
BL 6	BR6FS	
BL 7 Y	BP7FS	
BL 8	BR6FS	
BL 9 Y	BP6FS	
BL 11 Y	BP5FS	
BL 13 Y	BP5FS	
BN 2	B9EFS	
BN 6 Y	BP7EFS	
BN 7 Y	BP6EFS	5
BN 9 Y	BP6EFS	5



CHAMPION	→ NGK	V-Line
BN 12 Y	BP5EFS	
BN 89 Y	BP6EFS	5
C 6 BYC	BCP7ET	
C 6 VPYC	BKR7EIX-11	
C 6 YCC	BCP7ES	
C 7 Y	BCP7ES	
C 7 YC	BCP7ES	
C 7 YCC	BCP7ES	
C 7 YCX	BCP7ES	
C 9 MCC	ZFR5F	
C 9 Y	BCP6ES	17
C 9 YC	BCP6ES	17
C 9 YCC	BCP6ES	17
C 9 YCX	BCP6ES	17
C 10 YCC	BCP6ES	17
C 11 YCC	BCP5ES	16
C 12 YCC	BK5E	
C 55	R7436-10	
C 55 R	R7436-10	
C 57	R7436-9	
C 57 A	R7436-10	
C 57 C	R7436-9	
C 57 CX	R7434-10	
C 57 JC 4	R7436-10	
C 57 YCST	R7436-9	
C 59	R7436-9	
C 59 C	R7436-9	
C 61	R7436-8	
C 281 YC	BCP6ES	17
CJ 3	BM7A	
CJ 4	BM7A	
CJ 6	BM7A	
CJ 6 Y	BPM7A	
CJ 7 Y	BPM7A	
CJ 8	BM6A	
CJ 8 Y	BPM6A	
CJ 11	BM6A	
CJ 14	BM4A	
CJ 17 LM	B4-LM	
CJ 86	BM6A	
D 6	AB-8	
D 9	AB-6	
D 9 J	AB-6	
D 10	AB-6	
D 14	AB-6	
D 16	AB-6	
D 16 J	AB-6	
D 21	AB-6	
D 23	AB-6	
DJ 6 J	BM7F	
DJ 6 Y	BPM7F	
DJ 7 J	BM6F	

CHAMPION	→ NGK	V-Line
DJ 7 Y	BPM6F	
DJ 8 J	BM6F	
EON 1	BKR6ES	28
EON 2	BKR5ES	35
EON 3	BPR5EFS	
EON 4	TR5A-10	
EON 5	BPR6ES	2
EON 6	BPR5ES	6
F 7 Y	AP7FS	
F 7 YC	AP7FS	
F 7 YCC	AP7FS	
F 9 Y	AP6FS	
F 9 YC	AP6FS	
F 10	A6FS	
F 10 C	A6FS	
F 11 Y	AP5FS	
F 11 YC	AP5FS	
F 14 Y	AP5FS	
F 62 Y	AP8FS	
F 81 Y	AP8FS	
F 82	A8FS	
F 83 Y	AP8FS	
FN 507 Y	BCP7ES	
G 1	C9E	
G 2	C8E	
G 54 V	R0045J-10	
G 55	C9E	
G 56 R	R0373A-10	
G 58	C9E	
G 59 C	C7E	
G 61	C8E	
G 63	C8E	
G 63 R	CR8EIX	
H 03	B6S	
H 8	B-6L	
H 8 C	B-6L	
H 8 J	B-6L	
H 10	B-6L	
H 10 C	B-6L	
H 10 J	B-6L	
H 11	B-4L	
H 12	B-4L	
J 4	B7S	
J 4 C	B7S	
J 4 J	B7S	
J 5	B7S	
J 6	B6S	
J 6 C	B6S	
J 6 J	B6S	
J 7	B6S	
J 7 J	B6S	
J 8	B6S	



CHAMPION	→ NGK	V-Line
J 8 C	B6S	
J 8 J	B6S	
J 10 Y	BP6S	
J 11	B-4	
J 11 C	B-4	
J 11 J	B-4	
J 11 Y	BP5S	
J 12 J	B-2	
J 12 Y	BP5S	
J 12 YC	BP5S	
J 13 Y	BP5S	
J 14	B-2	
J 14 J	B-2	
J 14 Y	BP5S	
J 14 YC	BP5S	
J 17 LM	B4-LM	
J 18 Y	BP-4	
J 18 YC	BP-4	
J 19 LM	B2-LM	
K 3 G	AB-8	
K 5 G	AB-8	
K 7	AB-8	
K 8	AB-8	
K 8 G	AB-8	
K 9	AB-7	
K 13	AB-6	
K 15 J	AB-6	
L 2 G	BR9HIX	
L 3 G	BR8HIX	
L 4 G	BR7HIX	
L 4 J	B7HS	
L 5	B7HS	
L 6 G	BR7HIX	
L 6 VC	BU8H	
L 7 J	B6HS	
L 9 G	BR6HIX	
L 9 J	B6HS	
L 10	B6HS	
L 12 Y	BP5HS	
L 14	B-4H	
L 15 Y	BP4HS	
L 19 V	BUH	
L 20 V	BUH	
L 55 G	BR10HIX	
L 61 Y	BP8HS	
L 64 Y	BP7HS	
L 66 Y	BP6HS	18
L 76 V	BUHW	
L 77 J	B7HS	
L 77 J 4	B7HS-10	
L 77 JC	B7HS	
L 77 JC 4	B7HS-10	

CHAMPION	→ NGK	V-Line
L 77 V	BUHW	
L 78	B7HS	
L 78 C	B7HS	
L 78 V	BUHW-2	
L 78 YC	BP7HS-10	
L 78 YC 6	BP8HS-15	
L 81	B7HS	
L 81 Y	BP7HS	
L 82	B6HS	
L 82 C	B6HS	
L 82 Y	BP6HS	18
L 82 YC	BP6HS	18
L 82 YCC	BP6HS	18
L 85	B6HS	
L 85 Y	BP6HS	18
L 86	B6HS	
L 86 C	B6HS	
L 86 CC	B6HS	
L 87 Y	BP6HS	18
L 87 YC	BP6HS	18
L 87 YCC	BP6HS	18
L 90	B5HS	
L 90 C	B5HS	
L 92 LCC	BP5HA	
L 92 Y	BP5HS	
L 92 YC	BP5HS	
L 92 YC 4	BP5HS-10	
L 95 Y	BP4HS	
L 288	B5HS	
N 1	B10ES	
N 1 C	B10ES	
N 2	B9ES	
N 2 C	B9ES	
N 2 G	BR9EIX	
N 3	B8ES	
N 3 C	B8ES	
N 3 G	BR8EIX	
N 4	B7ES	
N 4 C	B7ES	
N 4 G	BR7EIX	
N 4 YC	BP9ES	
N 5	B6ES	
N 5 C	B6ES	
N 5 G	B6EVX	
N 6	B6ES	
N 6 BYC	BUR6ET	1
N 6 GY	BPR8EIX	
N 6 Y	BP8ES	
N 6 YC	BP8ES	
N 6 YCC	BP8ES	
N 7	B7ES	
N 7 BMC	BUR6ET	1



CHAMPION	→ NGK	V-Line
N 7 BYC	BUR6ET	1
N 7 GY	BPR7EIX	
N 7 Y	BP7ES	
N 7 YC	BP7ES	
N 7 YCC	BP7ES	
N 7 YCX	BP7ES	
N 8	B6ES	
N 8 GY	BPR6EIX	
N 8 L	ZGR5C	
N 8 Y	BP6ES	4
N 9 BMC	BPR5EKU	
N 9 BYC	BUR6ET	1
N 9 BYC 4	BP5ET-10	
N 9 Y	BP6ES	4
N 9 YC	BP6ES	4
N 9 YC 4	BP6ES-11	
N 9 YCC	BP6ES	4
N 9 YCE	BP5ES	8
N 9 YCX	BP6ES	4
N 10 PY	BPR6EIX	
N 10 Y	BP6ES	4
N 10 Y 4	BP6ES-11	
N 10 YC	BP5ES	8
N 11 Y	BP5ES	8
N 11 YC	BP5ES	8
N 11 YC 4	BP5ES-11	
N 11 YCC	BP5ES	8
N 12 Y	BP5ES	8
N 12 YC	BP5ES	8
N 12 YCC	BP5ES	8
N 13 L	ZGR5C	
N 13 Y	BP5ES	8
N 14 LY	ZGR5C	
N 14 Y	BP5ES	8
N 16 Y	BP4ES	
N 16 YC	BP4ES	
N 19 V	BUE	
N 21	B4ES	
N 54 R	B10EG	
N 55 G	B105EGV	
N 56 R	B105EGP	
N 57	B10ES	
N 57 G	B105EGV	
N 57 R	B10EG	
N 59 G	B95EGV	
N 60	B9ES	
N 60 R	B8EG	
N 60 Y	BPR10EVX	
N 62 R	B8EG	
N 63 Y	BP9ES	
N 64 Y	BP8ES	
N 65 Y	BP7ES	

CHAMPION	→ NGK	V-Line
N 66 Y	BP6ES	4
N 74 C	BUR6EB-11	
N 79 Y	BP6ES	4
N 80	B10EG	
N 80 G	B11EGV	
N 82	B10EG	
N 82 G	B105EGV	
N 84	B9EG	
N 84 G	B95EGV	
N 86	B9EG	
N 86 G	B9EGV	
N 87	B8EG	
N 87 G	B8EGV	
N 89 GY	BP6ES	4
N 89 Y	BP5ES	8
N 92 Y	BP4ES	
N 178 B	BR8EM	
N 180 B	B7EM	
N 279 YC	BP7ES	
N 281 YC	BP6ES	4
N 288	B5ES	
OBL 9 Y	BPR6FS	
OE 001	BP6ES	4
OE 002	BKR6ES	28
OE 003	BCP6ES	17
OE 004	BPR6ES	2
OE 005	BKR6ES	28
OE 006	BPR6ES	2
OE 007	BP6HS	18
OE 008	BPR7ES	19
OE 009	BP6EFS	5
OE 010	BP7ES	
OE 011	BPR6EFS	7
OE 012	BUR6ET	1
OE 013	BKR5ES	35
OE 014	BCPR7ES	
OE 015	BP5ES	8
OE 016	BKR6ES	28
OE 017	BCP7ES	
OE 018	BPR7ES	19
OE 019	BKR5EK	23
OE 020	BPR6EFS	7
OE 021	BCPR6ET	
OE 022	BP6ES	4
OE 023	BCP6ES	17
OE 024	BKR6E-11	14
OE 025	BUR6ET	1
OE 026	BKR6EK	20
OE 027	BUR5ET-10	21
OE 028	BP5ET-10	
OE 030	BKR6EKC	26
OE 031	PTR5A-13	25



CHAMPION	→ NGK	V-Line
OE 032	BKUR6ET-10	24
OE 033	BKR6EZ	38
OE 034	BKR6ES	28
OE 035	LFR5B	
OE 036	BP6EFS	5
OE 037	B6HS	
OE 038	BP6HS	18
OE 039	BKR6ES-11	14
OE 040	B9ES	
OE 041	ZFR5F	
OE 042	BPR5ES	6
OE 043	BCPR7ES	
OE 044	BUR6ET	1
OE 045	BPR5ES	6
OE 046	BP7ES	
OE 048	BPR6ES-11	13
OE 049	BPR5ES-11	
OE 050	BP7EFS	
OE 051	BPR5ES	6
OE 052	DCPR9EIX	
OE 053	APR6FS	
OE 054	APR6FS	
OE 055	BP5ES	8
OE 056	BKR7ES-11	
OE 057	BCP5ES	16
OE 058	BCP7ES	
OE 059	BP5HS	
OE 060	ZGR5B	
OE 061	AP7FS	
OE 063	BKR6ES-11	14
OE 064	BPR6HS	3
OE 065	BP5ES	8
OE 067	BP7EFS	
OE 068	B8ES	
OE 070	BP6HS	18
OE 071	BPR6HS	3
OE 074	B6ES	
OE 075	BCP7ES	
OE 076	BCP7ET	
OE 077	BCPR6ET	
OE 078	BR8EIX	
OE 079	B7ES	
OE 080	BKR7ES-11	
OE 084	BP8ES	
OE 085	BKR5EKU	
OE 086	BR6HS	
OE 087	BP8ES	
OE 088	BKR5E	35
OE 089	ZFR6F-11	
OE 090	BP7EFS	
OE 091	BR9ES	
OE 092	CR9E	

CHAMPION	→ NGK	V-Line
OE 093	BKR5EZ	36
OE 094	BCPR7ES	
OE 095	BUR6ET	1
OE 096	B6HS	
OE 098	BR7ES	
OE 100	BPR5EKU	
OE 102	BKR6EZ	38
OE 103	DCPR9EIX	
OE 104	BP6HS	18
OE 105	GR4	
OE 106	BP5ES	8
OE 107	BPR7ES-11	
OE 108	BR8ES	
OE 109	BUR6ET	1
OE 110	BCPR7ES	
OE 111	BPR6ES	2
OE 112	DR8EIX	
OE 114	BRE527Y-11	
OE 115	ZFR5N	
OE 116	BPR8ES	
OE 119	BKR6ES	28
OE 122	PMR7A	
OE 124	PFR5J-11	
OE 125	BR9EIX	
OE 127	BKR5E	35
OE 129	BKR7EIX-11	
OE 130	LZKAR7B	
OE 132	DP8EA-9	
OE 134	PFR5J-11	
OE 136	PFR6J-11	
OE 138	PFR5G-11	
OE 141	BKR6EIX	
OE 143	PFR6G-9	
OE 144	BKUR6ET-10	24
OE 146	PFR5G-13E	
OE 151	BPR5EFS	
OE 152	BKR5E-11	33
OE 154	ZFR5F-11	
OE 155	APR6FS	
OE 156	ZGR5C	
OE 160	ZFR4F-11	
OE 161	GR4	
OE 162	BR6ES	
OE 163	LZTR4A-11	
OE 165	R7436-9	
OE 166	C7E	
OE 167	PLZTR5A-13	
OE 168	TR5IX	
OE 169	R5724-9	
OE 171	BPR6FS	
OE 172	B9EG	
OE 173	R2525-10	





CHAMPION	→ NGK	V-Line
OE 174	PTR5A-13	25
OE 175	LF5AP-11	
OE 178	LF5B	
OE 190	IFR5G11	
OE 197	PLKR7A	
OE 198	ZFR6V-G	
OE 199	DCPR8E	
OE 201	LZKR6B-10E	
OJ 11 Y	BP6S	
OJ 12 Y	BP5S	
OJ 13 Y	BP5S	
ON 3	BR8ES	
ON 11 Y	BP5ES	8
ON 12 Y	BP5ES	8
P 6	D10HS	
P 7	D8HA	
P 7 G	DR8HS	
P 7 Y	D8HA	
P 8 Y	D6HA	
P 10 Y	D6HA	
PA 5 HC	D7EA	
PA 7 HC	D7EA	
PG 2 PHP	PMR8A	
PG 4 PHP	PMR7A	
PG 7 C	C7E	
PL 7 YC 4	BP6HS-10	
PL 9 YC	BP6HS	18
PN 5 C	B8ES	
PRL 5 SC	BR6HSA	
PRL 9 SC	BR4HSA	
PRZ 9 HC	CR7HSA	
PZ 7 HC	C7HSA	
PZ 9 HC	C6HSA	
Q 504 V	R2349-10	
QC 9 MC 4	ZFR6F-11	
QC 10 PEPB	IZFR6N-E	
QC 12 PEP	PZFR6H	
QC 12 PEPB	IZFR6N-E	
QC 12 YC	BKR5ES	35
QC 501 V	R7434-10	
QJ 17 LM	BR4-LM	
QJ 19 LM	BR2-LM	
QL 6 VC	BU8H	
QL 7 J 5	BR6HS	
QL 16 V	BUZ8H	
QL 76 V	BUZHW	
QL 77 CC	BR8HS	
QL 77 J 4	BZ7HS-10	
QL 77 JC 4	BZ7HS-10	
QL 78 C	BR7HS	
QL 78 V	BUZHW-2	
QL 78 YC	BPR7HS	

CHAMPION	→ NGK	V-Line
QL 82 C	BR6HS	
QL 82 YC	BPR6HS	3
QL 86	BR6HS	
QL 86 C	BR6HS	
QL 87 YC	BPR6HS	3
QL 92 LCC	BP8HS-10	
QN 2	BR9ES	
QN 2 C	BR9ES	
QN 2 G	BR9EIX	
QN 3	BR8ES	
QN 3 C	BR8ES	
QN 84	BR9EG	
QN 86	BR8EG	
R 6	D8EA	
R 6 G	DR8EIX	
R 6 J	D8EA	
R 8	D7EA	
R 10	D6EA	
R 54 G	R2525-10	
RA 2 HC	DPR7EA-9	
RA 4 HCC	DCPR8E	
RA 4 HXC	DCPR9EIX	
RA 6	DR8ES-L	
RA 6 Y	DPR7EA-9	
RA 6 YC	DPR7EA-9	
RA 7 YC	DCPR8E	
RA 8 GHC	DCPR6E	
RA 8 HC	DCPR7E	
RA 8 Y	DPR7EA-9	
RA 8 YC	DPR7EA-9	
RA 59 GC	DCPR9EIX	
RA 59 PP	DCPR9EIX	
RAX 92 C	DR9EA	
RAX 92 DC	JR9C	
RAX 92 YC	DPR7EA-9	
RAX 94 C	DR8EA	
RAX 94 YC	DPR7EA-9	
RAX 96 C	DR7EA	
RAX 96 YC	DPR7EA-9	
RBL 8	BR6FS	
RBL 9 Y	BPR6FS	
RBL 11 Y	BPR5FS	
RBL 11 Y 6	BPR5FS-15	
RBL 12	BR5FS	
RBL 13 Y	BPR5FS	
RBL 13 Y 6	BPR5FS-15	
RBL 15 Y	BPR4FS	
RBL 15 Y 4	BPR4FS-11	
RBL 15 Y 6	BPR4FS-15	
RBL 16 Y	BPR4FS	
RBL 17 Y	BPR4FS	
RBL 17 Y 6	BPR4FS-15	



CHAMPION	→ NGK	V-Line
RBL 86	BR6FS	
RBL 126	BR5FS	
RBN 9 Y	BPR6EFS	7
RBN 12 Y	BPR5EFS	
RBN 13 Y	BPR5EFS	
RBN 14 Y	BPR5EFS	
RC 6 VPYC	BKR7EIX-11	
RC 6 YC	BCPR7ES	
RC 6 YCC	BCPR7ES	
RC 7 BMC	BCPR6ET	
RC 7 BYC 4	BCPR6ET	
RC 7 GYC	BKR7EIX-11	
RC 7 GYG	BKR6EIX	
RC 7 Y	BCPR7ES	
RC 7 YC	BCPR7ES	
RC 7 YC 4	BKR7ES-11	
RC 7 YCC	BCPR7ES	
RC 7 YCC 4	BKR7ES-11	
RC 8 BYC	BKR6EKC	26
RC 8 DMC	BKR6EK	20
RC 8 PYCB	PFR6G-9	
RC 8 PYP	PFR6J-11	
RC 8 PYP 4	PFR6G-11	
RC 8 PYPB 4	PFR5G-13E	
RC 8 VTYC 4	BKUR6ET-10	24
RC 8 YC	BKR5E	35
RC 8 YC 4	BKR5E-11	33
RC 8 YCC	BKR6ES	28
RC 8 YCL	BKR6ES	28
RC 9 BMC	BKR5EKU	
RC 9 MC 4	ZFR5F-11	
RC 9 MCC 4	ZFR6F-11	
RC 9 TMC	BKR6EKUB	
RC 9 YC	BKR6ES	28
RC 9 YC 4	BKR6ES-11	14
RC 9 YC 5	BKR6E-11	14
RC 9 YCC	BKR6ES	28
RC 9 YCC 4	BKR6E-11	14
RC 9 YCN 4	BKR6E-11	14
RC 10 DMC	BKR5EK	23
RC 10 ECC	ZFR6F-11	
RC 10 MCC	ZFR6V-G	
RC 10 PYC	BKR6EIX	
RC 10 PYP 4	PFR5J-11	
RC 10 PYPB 4	PFR5G-11	
RC 10 YC	BKR5E	35
RC 10 YC 4	BKR6ES-11	14
RC 10 YCC	BKR6ES	28
RC 10 YCL	BKR5EZ	36
RC 11 LCC 4	BRE527Y-11	
RC 11 PYPB 4	PFR5G-11	
RC 12 ECC	ZFR5N	

CHAMPION	→ NGK	V-Line
RC 12 LYC	ZFR5F	
RC 12 MC4	PZFR5F-11	
RC 12 MC 5	ZFR5F-11	
RC 12 MCC 4	ZFR5F-11	
RC 12 PEC5	ZFR5LP-13G	
RC 12 PYP	PFR5J-11	
RC 12 YC	BKR5ES	35
RC 12 YC5	FR45	
RC 14 ES	ZFR5LP-13G	
RC 14 YC	BKR5ES	35
RC 14 YC 4	BKR5E-11	33
RC 87 PYC	BKUR6ET-10	24
RC 87 YC	BKR6ES	28
RC 87 YCC	BKR6EZ	38
RC 87 YCL	BKR6EZ	38
RC 89 YCC	BKR5EZ	36
RC 503 C	R7433-8	
RCJ 4	BMR7A	
RCJ 6	BMR7A	
RCJ 6 Y	BPMR7A	
RCJ 7 Y	BPMR7A	
RCJ 8	BMR6A	
RCJ 8 Y	BPMR6A	
RCJ 501 H	BPMR4A	
RD 9	AB-6	
RD 14	AB-6	
RD 16	AB-6	
RD 16 J	AB-6	
RDJ 6 J	BM7F	
RDJ 7 J	BMR6F	
RDJ 7 Y	BPMR6F	
RDJ 8 J	BMR6F	
RE 7 PYC 5	PTR5A-13	25
RE 7 YCC	PTR5A-13	25
RE 10 LC	TR5-11X	
RE 10 PMC 5	PTR5A-13	25
RE 10 YC 4	BKR5ES-11	33
RE 14 MCC 4	LZTR4A-11	
RE 14 MCC 4 /T04	LZTR4A-11	
RE 14 MCC 5	LZTR4A-11	
RE 14 PLP 5	PLZTR5A-13	
REA 8 MCL	LZKAR7A	
REA 8 MX	LZKAR7B	
REA 12 WMB 4	LZKAR6AP-11	
REC 9 MCLX	LF5B	
REC 9 YCL	LF5B	
REC 10 PYC 4	LF5AP-11	
REC 10 WYPB 4	IFR5G11	
RER 8 MC	LZKR6B-10E	
RER 8 YC	PLKR7A	
RES 9 YCC 4	PTR5A-13	25
RF 7 YC	APR6FS	



CHAMPION	→ NGK	V-Line
RF 7 YCC	APR6FS	
RF 9 Y	APR6FS	
RF 9 Y 5	APR6FS	
RF 9 YC	APR6FS	
RF 10	AR6FS	
RF 10 C	AR6FS	
RF 11 Y	APR6FS	
RF 11 YC	APR6FS	
RF 14 Y	APR5FS	
RFN 14 LY	ZFR4F-11	
RG 2 PHP	CR8EIX	
RG 4 HC	CR9E	
RG 4 PHP	PMR7A	
RG 6 YC	CR8EB	
RG 6 YCA	CPR8E	
RG 6 YCH	CPR8E	
RG 92 C	CR9E	
RG 92 DC	CR9EK	
RG 94 C	CR8E	
RGU 92 C	CR9EH-9	
RGU 94 C	CR8EH-9	
RH 10 C	B-6L	
RH 18 Y	B-4L	
RJ 6	BR6S	
RJ 6 C	BR6S	
RJ 6 J	BR6S	
RJ 7	BR6S	
RJ 8	BR6S	
RJ 8 C	BR6S	
RJ 8 J	BR6S	
RJ 10 Y	BP6S	
RJ 11	BR6S	
RJ 11 Y	BP5S	
RJ 12	BR6S	
RJ 12 Y	BP5S	
RJ 12 YC	BP5S	
RJ 14 CC	XR4	
RJ 14 Y	BP5S	
RJ 14 YC	BP5S	
RJ 17 LM	BR4-LM	
RJ 18 Y	BP-4	
RJ 18 YC	BP-4	
RJ 18 YC 6	XR45IX	
RJ 19 LM	BR2-LM	
RJ 20 Y	BP-4	
RL 4 J	BR7HS	
RL 7 J	BR6HS	
RL 12 Y	BPR6HS	3
RL 19	BR5HS	
RL 77 J	BR7HS	
RL 78	BR7HS	
RL 78 C	BR7HS	

CHAMPION	→ NGK	V-Line
RL 82	BR6HS	
RL 82 C	BR6HS	
RL 82 Y	BPR6HS	3
RL 82 YC	BPR6HS	3
RL 82 YCC	BPR6HS	3
RL 85	BR6HS	
RL 86	BR6HS	
RL 86 C	BR6HS	
RL 87 Y	BPR6HS	3
RL 87 YC	BPR6HS	3
RL 90	BR5HS	
RL 95 YC	BPR5HS	
RN 1 C	BR10ES	
RN 2	BR9ES	
RN 2 C	BR9ES	
RN 2 G	BR9EIX	
RN 3	BR8ES	
RN 3 C	BR8ES	
RN 3 G	BR8EIX	
RN 4	BR7ES	
RN 4 C	BR7ES	
RN 5	BR6ES	
RN 5 C	BR6ES	
RN 6	BR6ES	
RN 6 Y	BPR8ES	
RN 6 YC	BPR8ES	
RN 7 GY	BPR7EIX	
RN 7 Y	BPR7ES	19
RN 7 YC	BPR7ES	19
RN 7 YCC	BPR7ES	19
RN 7 YCC 4	BPR7ES-11	
RN 8	BR5ES	
RN 8 L	ZGR5C	
RN 8 VTYC 4	BUR6ET	1
RN 9 BMC	BPR5EKU	
RN 9 GY	BPR6EIX	
RN 9 LCC	ZGR5B	
RN 9 Y	BPR6ES	2
RN 9 YC	BPR6ES	2
RN 9 YC 4	BPR6ES-11	13
RN 9 YCC	BPR6ES	2
RN 10 GY	BPR6EIX	
RN 10 PYP 4	PGR5A-11	
RN 10 VTYC	BUR5ET	22
RN 10 VTYC 4	BUR5ET-10	21
RN 10 Y	BPR6ES	2
RN 10 Y 4	BPR6ES-11	13
RN 10 YC	BPR6ES	2
RN 11 Y	BPR5ES	6
RN 11 YC	BPR5ES	6
RN 11 YC 4	BPR5ES-11	
RN 11 YCC	BPR5ES	6



CHAMPION	→ NGK	V-Line
RN 12 GY	BPR5EIX	
RN 12 MC 4	BPR4EY-11	
RN 12 Y	BPR5ES	6
RN 12 YC	BPR5ES	6
RN 12 YC 4	BPR5ES-11	
RN 12 YC 6	BPR5ES-13	
RN 12 YCC	BPR5ES	6
RN 13 L	ZGR5C	
RN 13 LYC	ZGR5C	
RN 14 LY	ZGR5C	
RN 14 MC 5	BPR4EY-11	
RN 14 PMP 5	GR4	
RN 14 Y	BPR5ES	6
RN 14 Y 6	BPR5ES-13	
RN 14 YC	GR4	
RN 16 Y	BPR4ES	
RN 16 YC 5	BPR4ES-13	
RN 16 YC 6	BPR4EY-11	
RN 57 YC	BR10EG	
RN 74 C	BUR6EB-11	
RN 180 B	BR7EM	
RP 7	DR8HS	
RP 10 HC	DR5HS	
RS 5 C	BR7EFS	
RS 9 YC	BPR6EFS	7
RS 9 YCC	BPR6EFS	7
RS 10 LC	TR5-1	
RS 12 PYP	TR5IX	
RS 12 YC	BPR5EFS	
RS 12 YC 6	BPR5EFS-13	
RS 13 LYC	TR4	
RS 14 LC	TR5-1	
RS 14 LYC	TR4	
RS 14 PYP	TR4IX	
RS 14 YC	BPR5EFS	
RS 14 YC6	TR55IX	
RS 15 LYC	TR4	
RS 16 YC	TR4	
RV 8 C	BR6FS	
RV 8 C 6	BR6FS	
RV 9 YC	BPR6FS	
RV 12 C	BR5FS	
RV 12 C 6	BR5FS	
RV 12 YC	BPR5FS	
RV 12 YC 6	BPR5FS-15	
RV 15 YC	BPR4FS	
RV 15 YC4	BPR4FS-11	
RV 15 YC6	BPR4FS-15	
RV 17 YC	BPR4FS	
RV 17 YC6	BPR4FS-15	
RV 91 MC	BR6FS	
RV 92 YC	BPR5FS	

CHAMPION	→ NGK	V-Line
RZ 7 C	CMR7H	
RZ 94 C	CR8HSA	
RZ 96 C	CR7HSA	
RZN 12 Y	BPR5EFS	
RZN 12 Y 5	BPR5EFS	
S 6 YC	BP7EFS	
S 7 YC	BP7EFS	
S 7 YCC	BP7EFS	
S 9 YC	BP6EFS	5
S 9 YCC	BP6EFS	5
S 59 C	R5724-9	
S 59 CST	R5724-9	
S 279 YC	BP6EFS	5
S 281 YC	BP6EFS	5
S 379 YC	BP7EFS	
UD 16	AB-6	
UF 9 Y	AP6FS	
UF 11 Y	AP6FS	
UJ 2 J	B8S	
UJ 4 J	B7S	
UJ 6	B6S	
UJ 8	B6S	
UJ 12	B-2	
UJ 81 C	B7S	
UJ 81 J	B7S	
UK 10	AB-6	
UL 4 J	B7HS	
UL 17 V	BUHXW-1	
UL 18 V	BUHX	
UL 77 V	BUHXW-1	
UL 81 C	B7HS	
UL 81 J	B7HS	
UL 82 Y	BP7HS	
UN 19 V	BUE	
UN 79 Y	BP6ES	4
V 4 C	B7FS	
V 9 YC	BP6FS	
V 12 YC	BP5FS	
V 61	R5673-8	
V 63 C	R5673-7	
XC 12 PEPB	PZFR6H	
XC 92 YC	BKR5E	35
XJ 10 Y	BP6S	
Y 82	CM-6	
Z 6	C8HSA	
Z 7 G	CR7HIX	
Z 8	C7HSA	
Z 9 Y	C7HSA	
Z 10	C6HSA	
Z 10 G	CR7HIX	
Z 12	C6HSA	



<b>CHEVROLET =&gt; GM</b>		
<b>CHRYSLER</b>	<b>→ NGK</b>	<b>V-Line</b>
04606 402 AB	LZTR4A-11	
04606 591 AB	ZFR5LP-13G	
04886 204	BP5HS	
04886 205	BP5ES-A	
04886 206	BP6ES	4
04886 207	BP5FS	
04886 208	BP4FS	
04886 210	BP5EFS	
04886 211	TR4	
04886 213	BPR5ES-11	
04886 214	BPR4ES-11	
04886 215	BCPR5ES	32
04886 217	BPR5ES-A	
04886 219	BKR6ES	28
04887 030	ZFR5F-11	
04887 031	BKR5ES-11	33
04887 032	PFR5J-11	
S2LZT R4A 11	LZTR4A-11	
<b>CITROËN =&gt; PSA</b>		
<b>DACIA =&gt; RENAULT</b>		
<b>DAEWOO =&gt; GM</b>		
<b>DAIHATSU</b>	<b>→ NGK</b>	<b>V-Line</b>
90048-51006-000	B8ES	
90048-51008-000	B7ES	
90048-51015-000	B6ES	
90048-51020-000	B-4H	
90048-51022-000	B6HS	
90048-51033-000	B5ES	
90048-51034-000	BP6ES	4
90048-51034-010	BP6ES	4
90048-51035-000	BP6EY	
90048-51038-000	B6ES	
90048-51039-000	BPR6EK-A	
90048-51040-000	BPR6EK-A	
90048-51041-000	BPR6EY	
90048-51044-000	BPR5EY	9
90048-51047-010	BP5EY	
90048-51048-000	BPR5EY	9
90048-51049-000	BPR4EY-11	
90048-51050-000	BPR5EY-11	
90048-51053	BP5EY	
90048-51053-000	BP5EY	
90048-51054	BPR5EY	9
90048-51054-000	BPR5EY	9
90048-51055-000	BP6ES	4
90048-51058-000	BE527Y-11	

<b>DAIHATSU</b>	<b>→ NGK</b>	<b>V-Line</b>
90048-51059	BPR6EY	
90048-51059-000	BPR6EY	
90048-51062-000	BPR5EY-11	
90048-51063	BPR5EY-11	
90048-51063-000	BPR5EY-11	
90048-51069-000	BP6EY	
90048-51072-000	BP5ES	8
90048-51073-000	BPR6EK-A	
90048-51074-000	BPR6EK-A	
90048-51077-000	BPR6EKN	
90048-51079-000	BKR7E-11	
90048-51081-000	BPR5EY-11	
90048-51082-000	BPR5EY	9
90048-51084-000	BPR7EKN	
90048-51086-000	BPR6EK-A	
90048-51087-000	BPR6EK-A	
90048-51091-000	BPR5EY-11	
90048-51092-000	BPR6EY-11	10
90048-51093-000	BPR5EY-11	
90048-51093-A	BPR5EY-11	
90048-51095-000	BPR6ES	2
90048-51096-000	BPR6ES	2
90048-51097	BP-2E	
90048-51097-000	BP-2E	
90048-51099-000	BKR6E-11	14
90048-51100	BKR6E-11	14
90048-51100-000	BKR6E-11	14
90048-51101-000	BPR5EY	9
90048-51102-000	BPR6EKN	
90048-51103-000	BPR7EKN	
90048-51104-000	BPR6EKN	
90048-51105-000	BPR7EKN	
90048-51107-000	BPR6EKB-L	
90048-51108-000	BPR6EKB-L	
90048-51108-1	BPR6EKB-L	
90048-51110-000	BCPR7EKD	
90048-51111-000	BCPR6ED	
90048-51112	BCPR7EKD	
90048-51112-000	BCPR7EKD	
90048-51113	BCPR6ED	
90048-51113-000	BCPR6ED	
90048-51114	BPR5ES	6
90048-51114-000	BPR5ES	6
90048-51115-000	BPR6EKB-L	
90048-51116	BPR6EKB	
90048-51116-000	BPR6EKB	
90048-51117-000	PFR6B-11	
90048-51118-000	PFR6B-11	
90048-51121-000	BPR4EY	
90048-51123	BKR6EY-11	
90048-51123-000	BKR6EY-11	
90048-51125-000	BPR5EJ	





DAIHATSU	→ NGK	V-Line
90048-51126	BPR5EJ	
90048-51126-000	BPR5EJ	
90048-51130-000	BPR5EKB	
90048-51131	BPR5EKB	
90048-51131-000	BPR5EKB	
90048-51131-1	BPR5EKB	
90048-51133-000	BCPR6EKD	
90048-51134	BCPR6EKD	
90048-51134-000	BCPR6EKD	
90048-51134-1	BCPR6EKD	
90048-51136-000	BKUR6EK	
90048-51137	BKUR6EK	
90048-51137-000	BKUR6EK	
90048-51140	BPR6EKB	
90048-51143-000	BKUR7EK	
90048-51144	BKUR7EK	
90048-51144-000	BKUR7EK	
90048-51145	BKR4E	
90048-51151-000	BKR6E	28
90048-51152	BKR6E	28
90048-51152-000	BKR6E	28
90048-51154-000	BKR6EKC	26
90048-51155	BKR7EKC	
90048-51155-000	BKR6EKC	26
90048-51156-000	R7433-9	
90048-51158-000	BKR5E-11	33
90048-51158-008	BKR5E-11	33
90048-51159-000	BKUR6EK-9	
90048-51160	BKUR6EK-9	
90048-51160-000	BKUR6EK-9	
90048-51161	BKR7E	
90048-51161-000	BKR7E	
90048-51162	IFR7F-6D	
90048-51162-000	PFR7N-D	
90048-51163-000	BKR6EYA-11	
90048-51165	BKR5EKC	
90048-51165-000	BKR5EKC	
90048-51166	PFR6G	
90048-51166-000	PFR6G	
90048-51173	IFR6J11	
90048-51173-000	IFR6J11	
90048-51175-000	BKR6EKPA	
90048-51185-000	ILFR6T11	
90048-51187	IKR7C	
90048-51196	DCPR7EA-9	
90048-51200	IKR7D	
90919-01026-000	BP5EY	
90919-01056-000	BP4EY	
90919-01059-000	BP5EY	
90919-01060-000	BP4EY	
90919-01061-000	BP5EY	
90919-01065-000	BPR4EY	

DAIHATSU	→ NGK	V-Line
90919-01085-000	BP4EY-11	
90919-01086-000	BP4EY-11	
90919-01087-000	BP5EK-A	
90919-01106-000	BP4EY-11	
90919-01115-000	BPR5EP-11	
90919-01116-000	BPR5EP-11	
90919-01117-000	BE529Y-11	
90919-01118-000	BE529Y-11	
90919-01177-000	BKR5EYA	
90919-01181-000	BKR6EP-8	
90919-01202-000	BKR6EKB-11	
99113-39236-10	AB-6	
99113-39236-200	AB-6	
99123-11236-100	AB-7	
99123-11236-220	AB-7	
99251-30200-100	B-4	
99520-21236-132	B8HS	
99906-850P9-006	BPR6HS	3
99906-850P9-009	BR7ES	
99906-850P9-011	BPR5ES-11	
99906-850P9-012	BPR6ES-11	13
99906-850P9-013	BPR5ES-13	
99906-850P9-015	BPR5EIX-11	
99906-850P9-017	BRE527Y-11	
99906-850P9-018	BRE529Y-11	
99906-910P9-002	BR6HS	
99906-910P9-003	BR8HS	
99906-910P9-004	BPR5HS	
99906-910P9-005	BPR6HS	3
99906-910P9-006	BR5ES	
99906-910P9-007	BR6ES	
99906-910P9-008	BR7ES	
99906-910P9-009	BR8ES	
99906-910P9-011	BPR5ES-11	
99906-910P9-012	BPR6ES-11	13
99906-910P9-013	BPR5EIX-11	
99906-910P9-015	BPR4EY-11	
99906-910P9-017	BPR6EY-11	10
99906-910P9-020	BPR6E	2
99906-910P9-021	BCPR5E-11	
99906-910P9-022	BCPR5EY-11	
99906-910P9-023	BCPR6E-11	11
99906-910P9-024	BCPR6EY-11	
99906-910X9-001	BPR5EIX-11	
99906-910X9-002	BPR6EIX-11	
99906-910X9-003	BPR7EIX	
99906-910X9-004	BCPR5EIX-11	
99906-910X9-005	BCPR6EIX-11	
99906-910X9-006	BKR5EIX-11	
99906-910X9-007	BKR6EIX-11	
99906-910X9-008	BPR6HIX	
99906-910X9-009	BPR7HIX	



DAIHATSU	→ NGK	V-Line
99906-910X9-010	BR6HIX	
99906-910X9-011	BR7HIX	
99906-910X9-012	BR8EIX	
99906-910X9-013	BR9EIX	
99906-910X9-014	DR8EIX	
99906-910X9-015	DR9EIX	
99906-910X9-016	DPR8EIX-9	
99906-910X9-017	DPR9EIX-9	
99906-910X9-018	DCPR7EIX	
99906-910X9-019	ZFR5FIX-11	
99906-910X9-020	ZFR6FIX-11	
99906-910X9-021	CR8EHIX-9	
99906-910X9-022	CR9EHIX-9	
99906-910X9-023	CR8EIX	
99906-910X9-024	B8HCS	
99906-910X9-026	BPR5EIX	
99906-910X9-027	BPR6EIX	
99906-910X9-028	BKR5EIX	
99906-910X9-029	BKR6EIX	
99906-910X9-030	BKR7EIX-11	
99934-00691-100	BPR6EIX	
99934-01691-100	BPR5EIX	
99934-02691-100	B6EVX	
99934-03691-100	BR7EIX	
99934-05691-100	BP5ES-11	
99934-06691-100	BP6ES-11	
99934-07685-100	BP5EY-11	
99934-07691-100	BP5HS	
99934-08685-100	BP6EY-11	
99934-08691-100	BP5ES-13	
99934-09685-100	BP6HS	18
99934-09691-100	BP6HS	18
99934-10685-100	BP-2E	
99934-10691-100	BP4EY	
99934-12685-100	BP5HS	
99934-13685-100	BP6ES-11	
99934-14685-100	BP5ES-13	
NDIK 16	BKR5EIX-11	
NDIK 16 A	BKR5EIX-11	
NDIK 20	BKR6EIX-11	
NDIK 20 A	BKR6EIX-11	
NDIQ 16	BCPR5EIX-11	
NDIQ 16 A	BCPR5EIX-11	
NDIQ 20	BCPR6EIX-11	
NDIQ 20 A	BCPR6EIX-11	
NDIW 16	BPR5EIX-11	
NDIW 16 A	BPR5EIX-11	
NDIW 20	BPR6EIX-11	
NDIW 20 A	BPR6EIX-11	
NDIW 22	BPR7EIX	
NDIW 22 A	BPR7EIX	
NDIXU 22	DCPR7EIX	

DAIHATSU	→ NGK	V-Line
NDIXU 22 A	DCPR7EIX	
DELPHI	→ NGK	V-Line
41 970	PTR5C-13	
DENSO	→ NGK	V-Line
FK 20 HBR 11	DFH6B-11A	
FXE 20 HR 11	DILKAR6A11	
FXE 22 HR 11	DF7H-11B	
FXE 24 HR 11	DF8H-11B	
IA 01-32	R7282A-105	
IA 01-34	R7282A-11	
IAE 01-32	R7282-105	
IAE 01-34	R7282-11	
IK 01-24	R7434-8	
IK 01-27	R7434-9	
IK 01-31	R7434-10	
IK 02-24	R7434-8	
IK 02-27	R7434-9	
IK 02-31	R7434-10	
IK 16	BKR5EIX-11	
IK 20	BKR6EIX-11	
IK 24 C 11	FR8BI-11	
IK 27 C 11	FR9BI-11	
IKH 01-24	R7438-8	
IKH 01-27	R7438-9	
IKH 01-31	R7438-10	
IKH 16	LFR5AIX-11	
IKH 20	LFR6AIX-11	
IQ 01-24	R7436-8	
IQ 01-27	R7436-9	
IQ 01-31	R7436-10	
IQ 02-24	R7436-8	
IQ 02-27	R7436-9	
IQ 02-31	R7436-10	
IQ 16	BCPR5EIX-11	
IQ 20	BCPR6EIX-11	
IRE 01-34	R7420-11	
IT 16	TR5IX	
IT 20	TR6IX	
IT 22	TR7IX	
IT 24	TR8IX	
ITF 16	UR5IX	
ITF 20	UR6IX	
IU 01-27	R0373A-9	
IU 01-31	R0373A-10	
IU 01-34	R0373A-11	
IU 22	CR7EIX	
IU 24	CR8EIX	
IU 27	B8HCS	



DENSO	→ NGK	V-Line
IU 27 D	CR9EIA-9	
IUF 22	CR7HIX	
IUF 24	CR8HIX	
IUH 24	CR8EHIX-9	
IUH 27	CR9EHIX-9	
IUH 27 D	IMR9A-9H	
IW 01-24	R7376-8	
IW 01-27	R7376-9	
IW 01-31	R7376-10	
IW 06-27	R7376-9	
IW 06-31	R7376-10	
IW 16	BPR5EIX-11	
IW 20	BPR6EIX-11	
IW 22	BPR7EIX	
IW 24	BR8EIX	
IW 27	BR9EIX	
IW 31	BR10EIX	
IWF 20	BPR6HIX	
IWF 22	BR7HIX	
IWF 24	BR8HIX	
IWF 27	BR9HIX	
IWM 01-32	R7282-105	
IWM 24	BR8ECMIX	
IWM 27	BR9ECMIX	
IWM 31	BR10ECMIX	
IX 22 B	DPR7EIX-9	
IX 24	DR8EIX	
IX 24 B	DPR8EIX-9	
IX 27	DR9EIX	
IX 27 B	DPR9EIX-9	
IXU 01-27	R2525-9	
IXU 01-31	R2525-10	
IXU 01-34	R2349-11	
IXU 22	DCPR7EIX	
IXU 22 C	KR7AI	
IY 24	ER8EHIX	
IY 27	ER9EHIX	
J 16 AR-U 11	BRE527Y-11	
J 16 A-U 11	BE527Y-11	
J 16 AY	BPR5EY-11	
J 16 AYR	BPR5EJ	
J 16 BR-U	BRE529Y	
J 16 BR-U 11	BRE529Y-11	
J 16 B-U 11	BE529Y-11	
J 16 CR-U	ZGR5A	15
J 16 C-U	BPR5EY	9
J 20 AY	BPR6EY-11	10
K 14 PR-U 11	BKR4E-11	
K 14 P-U 11	BKR5E-11	33
K 16 DTR-S 11	ZFR5G	
K 16 GPR-U 11	ZFR5E-11	
K 16 HPR-U 11	LFR5A-11	

DENSO	→ NGK	V-Line
K 16 PR-L 11	BKR5E-N-11	
K 16 PR-P 11	BKR5EIX	
K 16 PR-TP 11	BKR5EIX-11	
K 16 PR-U	BKR5E	35
K 16 PR-U 11	BKR5E-11	33
K 16 PRUR	BKR5E	35
K 16 PRZ-U 11	BKR5EIX-11	
K 16 PSR-B 8	FR5EI	
K 16 P-U	BK5E	
K 16 P-U 11	BK5E-11	
K 16 R-U	BKR5EYA	
K 16 R-U 11	BKR5EYA-11	39
K 16 RZ-U 11	BKR5EIX-11	
K 16 TNRS 9	BKR5EKC	
K 16 TR 11	BKR5EKB-11	
K 16 U	BKR5EYA	
K 16 U 11	BKR5EYA-11	39
K 20 DTR-S 11	ZFR6G	
K 20 HR-U	LFR6B	
K 20 HR-U 11	LFR6C-11	
K 20 PBR	BKUR6ET	27
K 20 PBR-S 10	BKUR6ET-10	24
K 20 PR-L 11	BKR6E-N-11	
K 20 PR-TP 11	BKR6EIX-11	
K 20 PR-U	BKR6E	28
K 20 PR-U 11	BKR6E-11	14
K 20 PR-U 9 S	BKR6E-9S	
K 20 PRUR	BKR6E	28
K 20 PRZ-U 11	BKR6EIX-11	
K 20 PSR-B 8	FR6EI	
K 20 P-U	BK6E	
K 20 P-U 11	BK6E-11	
K 20 R-U	BKR6EYA	
K 20 R-U 11	BKR6EY-11	
K 20 RZ	BKR6EIX	
K 20 RZ-U 11	BKR6EIX-11	
K 20 TMR 11	BKR6EKC-N-11	
K 20 TNR	BKR6EKC	26
K 20 TNR-S	BKUR6EK	
K 20 TNRS 9	BKUR6EK-9	
K 20 TR 11	BKR6EKB-11	
K 20 TRX	BKR6EQU	
K 20 TXR	BKR6EKUB	
K 20 U	BKR6EYA	
K 20 U 11	BKR6EYA-11	
K 22 P 11	BK7EK-N-11	
K 22 PB	BCP7ET	
K 22 PBR-S	BKUR7ET	
K 22 PR-L 11	BKR7E-N-11	
K 22 PR-TP 11	BKR7EIX-11	
K 22 PR-U	BKR7E	
K 22 PR-U 11	BKR7E-11	



DENSO	→ NGK	V-Line
K 22 PRUR	BKR7E	
K 22 PRZ-U	BKR7EIX	
K 22 PRZ-U 11	BKR7EIX-11	
K 22 P-U 11	BK7E-11	
K 22 TM 11	BK7EK-N-11	
K 22 TMR	BKR7EKC-N	
K 22 TMR 11	BKR7EKC-N-11	
K 22 TNR	BKR7EKC	
K 22 TNRS	BKUR7EK	
K 24 PR-U 11	BKR8E-11	
K 29 AZ	R7434-10	
KJ 14 CR 11	ZFR4F-11	
KJ 14 CR-L 11	ZFR4F-11	
KJ 16 CR	ZFR5F	
KJ 16 CR 11	ZFR5J-11	
KJ 16 CR-L 11	ZFR5F-11	
KJ 16 CR-U 11	ZFR5F-11	
KJ 20 CR 11	ZFR6J-11	
KJ 20 CR-L 11	ZFR6F-11	
KJ 20 CR-U 11	ZFR6F-11	
KJ 20 DR-M 11	ZFR6K-11	
KJ 20 SR 11	ZFR6FIX-11	
KJ 22 CR 11	ZFR7F-11	
KJ 22 CR-L 8	ZFR7F	
KJ 22 CR-L 11	ZFR7F-11	
KJ 206 CR-L 11	ZFR6F-11	
L 14 U	AB-6	
M 17	AB-6	
M 22	AB-7	
M 24 S	AB-8	
MA 14 P-U	AP5FS	
MA 16 PR-U	APR5FS	
MA 16 PR-U 11	APR5FS	
MA 16 PR-U 15	APR5FS	
MA 16 P-U	AP5FS	
MA 17 P-U	AP6FS	
MA 20 PR-U	APR6FS	
MA 20 P-U	AP6FS	
MA 20 R-U	AR6FS	
MA 20 R-U 11	AR6FS	
MW 9	AB-2	
MW 17	AB-6	
MW 22	AB-7	
P 16 PR 8	PGR5A	
P 16 PR 11	PGR5A-11	
P 16 R	BPR5EP-11	
P 16 R 13	BPR5EP-11	
P 20 PR 8	PGR6A	
P 20 PR 11	PGR6A-11	
P 20 R 8	BPR6EP-8	
P 22 PR 8	PGR7A	
PK 16 PR 11	PFR5B-11	

DENSO	→ NGK	V-Line
PK 16 PR-L 11	PFR5G-11	
PK 16 PR-P 11	PFR5J-11	
PK 16 R 11	BKR5EP-11	
PK 16 TR 11	BKR5EKP-11	
PK 16 TR 13	BKR5EKP-13	
PK 20 GR 8	BKR6EPA-8	
PK 20 PR 11	PFR6B-11	
PK 20 PR-L 11	PFR6G-11	
PK 20 PR-L 13	PFR6G-13	
PK 20 PRP	PFR6J	
PK 20 PR-P 8	PFR6J	
PK 20 PR-P 11	PFR6J-11	
PK 20 PRTP	PFR6M	
PK 20 PTR-S 9	BKR6EKPA	
PK 20 R 8	BKR6EP-8	
PK 20 R 11	BKR6EP-11	
PK 20 R 13	BKR6EP-13	
PK 20 RP 8	BKR6EP-N-8	
PK 20 TR 11	BKR6EKP-11	
PK 22 PR 8	PFR7B	
PK 22 PR 11	PFR7B-11	
PK 22 PR-L 11	PFR7G-11	
PK 22 PR-L 11 S	PFR7G-11S	
PK 22 PRTP	PFR7M	
PKJ 16 CR 8	PZFR5F	
PKJ 16 CR-L 11	PZFR5F-11	
PKJ 16 CR-L 13	PZFR5F-13	
PKJ 20 CR 8	PZFR6F	
PKJ 20 CR-L 11	PZFR6F-11	
PKJ 20 CR-M 11	PZFR6F-11	
PQ 16 R	BCPR5EIX-11	
PQ 16 R 8	BCPR5EP-8	
PQ 16 R 13	BCPR5EIX-11	
PQ 20 R	BCPR6EP-11	
PQ 20 R 8	BCPR6EP-8	
PQ 20 R 13	BCPR6EIX-11	
PQ 20 R-P 8	BCPR6EP-N-8	
PQ 20 R-P 11	BCPR6EIX-11	
PT 16 EPR-C 13	PTR5C-13	
PT 16 EPR-L 13	PTR5D-10	31
PT 16 VR 13	PTR5A-13	25
PTJ 16 R 15	PZTR5A-15	
Q 14 R-U 11	BCPR4EY-11	
Q 16 PR-TP 11	BCPR5EIX-11	
Q 16 PR-U	BCPR5E	32
Q 16 PR-U 11	BCPR5EY-11	
Q 16 PRU-L 11	BCPR5EY-N-11	
Q 16 PRZ-U 11	BCPR5EIX-11	
Q 16 P-U 11	BCPR5EY-11	
Q 16 R-U	BCPR5EY	
Q 16 R-U 11	BCPR5EY-11	
Q 16 RZ-U 11	BCPR5EIX-11	



DENSO	→ NGK	V-Line
Q 16 U 11	BCPR5EY-11	
Q 16 Z-U 11	BCPR5EIX-11	
Q 20 PR-P 11	BCPR6EIX-11	
Q 20 PR-U	BKR6E	28
Q 20 PR-U 11	BCPR6EY-11	
Q 20 PRU-L 11	BCPR6EY-N-11	
Q 20 PRZ-U 11	BCPR6EIX-11	
Q 20 P-U	BCP6ES	17
Q 20 P-U 11	BKR6E-11	14
Q 20 R-U	BCPR6EY	
Q 20 R-U 11	BCPR6EY-11	
Q 20 RZ-U 11	BCPR6EIX-11	
Q 20 U	BCP6E	17
Q 20 U 11	BKR6E-11	14
Q 20 Z-U 11	BCPR6EIX-11	
Q 22 PR-P 11	BKR7EIX-11	
Q 22 PR-U	BCPR7ES	
Q 22 PR-U 11	BCPR7ES-11	
Q 22 PRU-L 11	BCPR7EY-N-11	
Q 22 PRZ-U	BCP7EVX	
Q 22 PRZ-U 11	BKR7EIX-11	
Q 22 P-U	BCP7ES	
Q 22 P-U 11	BKR7E-11	
Q 27 AZ	R7435-9	
QJ 16 AR-U	BCRE527Y	
QJ 16 C 11	ZFR5A-11	
QJ 16 CR 11	ZFR5A-11	
QJ 20 C 11	ZFR6A-11	
QJ 20 CR 11	ZFR6A-11	
QJ 22 CR 11	ZFR7F-11	
QL 20 PR-U	BCPR6ED	
QL 20 TRS	BCPR6EKD	
QL 22 TRS	BCPR7EKD	
RU 01-31	R0045Q-10	
RU 01-34	R0045Q-11	
S 22 PR-A 7	IGR7A	
S 27	SD9A	
S 29	SD10A	
S-29 A	SD10A	
S-31 A	SD11A	
SC 20 HR 11	ILKAR7B11	
SD 29 A	SD10A	
SF 10	BUHX	
SF 24	BU8H	
SF 50	BUHW	
SF 51	BUHW-2	
SK 16 HR 11	ILFR5T11	
SK 16 PR-A 11	IFR5E11	
SK 16 PR-E11	IFR5E11	
SK 16 PR-E13	IFR5E13	
SK 16 PR-L 11	IFR5G-11K	
SK 16 R-P 8	IFR5T-8N	

DENSO	→ NGK	V-Line
SK 20 BGR 11	HB6AIX-11P	
SK 20 BR 11	HB6BIX-11P	
SK 20 HPR-L 11	ILFR6J-11K	
SK 20 HR 11	ILFR6T11	
SK 20 PR-A8	IFR6S	
SK 20 PR-A 11	IFR6E11	
SK 20 PR-L9	IFR6C	
SK 20 R 8-G	LPG1	
SK 20 R 11	IFR6T11	
SK 22 PR-M 11	IFR7G-11KS	
SK 22 PR-M 11 S	IFR7G-11KS	
SKJ 16 DR-M 11	IZFR5K11	
SKJ 20 DR-M 11	IZFR6K11	
SKJ 20 DR-M 11 S	IZFR6K11NS	
SKJ 20 DR-M 13	IZFR6K13	
SVK 20 RZ 8	BKR6EP-8	
SVK 20 RZ 11	IFR6J11	
SXU 22 HCR 11 S	ILZKR7B11GS	
SXU 22 HDR 8	ILKR7B8	
SXU 22 PR 9	IKR7C	
T 14 PR-U	BPR4FS	
T 14 PR-U 15	BPR4FS-15	
T 16 EPR-U	BPR5EFS	
T 16 EX-U	BP5EFS	
T 16 PR-U	BPR5FS	
T 16 PR-U 11	BPR5FS-11	
T 16 PR-U 15	BPR5FS-15	
T 16 P-U	BP5FS	
T 16 R-U	BR5FS	
T 16 RU 15	BR5FS	
T 16 U 15	YR55IX	
T 20 EPR-U	BPR6EFS	7
T 20 EPR-U 15	BPR6EFS-15	
T 20 EP-U	BP6EFS	5
T 20 EPU 15	BPR6EFS-15	
T 20 EX-U	BP6EFS	5
T 20 MP-U	BPM6F	
T 20 M-U	BM6F	
T 20 PR-U	BPR6FS	
T 20 PR-U 15	BPR6FS	
T 20 P-U	BP6FS	
T 20 R-U	BR6FS	
T 20 R-U 15	BR6FS	
T 22 EP-U	BP7EFS	
T 22 MP-U	BPM7F	
T 22 M-U	BM7F	
TR 20	B6HS	
TR 22	B7HS	
TR 22-10	B7HS-10	
TR 24	B8HS	
TR 24-10	B8HS-10	
U 14 FSRUB	CR4HSB	





DENSO	→ NGK	V-Line
U 14 FSUB	C4HSB	
U 16 FER-9	CR5EH-9	
U 16 FSL	C5HSA	
U 16 FSRL	CR5HSA	
U 16 FSR-U	CR5HSA	
U 16 FSRUB	CR5HSB	
U 16 FS-U	C5HSA	
U 16 FSUB	C5HSB	
U 17 F	C5HSA	
U 20 EPR-9	CPR6EA-9	
U 20 ESR-N	CR6E	
U 20 FS	C6HSA	
U 20 FSL	C6HSA	
U 20 FSRL	CR6HS	
U 20 FSR-U	CR6HSA	
U 20 FS-U	C6HSA	
U 20 M-U	CM-6	
U 21 FB	C6HSA	
U 22 EPR-U	CPR7EA-9	
U 22 ESN	C7E	
U 22 ESRN	CR7E	
U 22 ETR	CR7EK	
U 22 FER 9	CR7EH-9	
U 22 FS	C7HSA	
U 22 FSG-U	CR7HIX	
U 22 FSL	C7HSA	
U 22 FSRL	CR7HS	
U 22 FSR-U	CR7HSA	
U 22 FS-U	C7HSA	
U 22 FSZ-U	CR7HIX	
U 24 ESN	C8E	
U 24 ESRN	CR8E	
U 24 ESRNB	CR8EB	
U 24 ESRNZ-U	CR8EIX	
U 24 ETR	CR8EK	
U 24 FB	C8HSA	
U 24 FE 9	C8EH-9	
U 24 FER 9	CR8EH-9	
U 24 FER 9 S	CR8EH-9S	
U 24 FERZ-U 9	CR8EHIX-9	
U 24 FS	C8HSA	
U 24 FSL	C8HSA	
U 24 FSRC	LR8A	
U 24 FSR-U	CR8HS	
U 24 FSRZ-U	CR8HIX	
U 24 FS-U	C8HSA	
U 24 FSZ-U	CR8HIX	
U 27 ESN	C9E	
U 27 ESNZ-U	CR9EIX	
U 27 ESRN	CR9E	
U 27 ESRNB	CR9EB	
U 27 ESRNZ-U	CR9EIX	

DENSO	→ NGK	V-Line
U 27 ETR	CR9EK	
U 27 FE 9	C9EH-9	
U 27 FER 9	CR9EH-9	
U 27 FERZ-U 9	CR9EHIX-9	
U 27 FEZ-U 9	CR9EHIX-9	
U 31 ESRN	CR10E	
U 31 ETR	CR10EK	
VK 16 PRZ 11	IFR5L11	
VK 20	IZFR6H11	
VK 20 PRZ 11	IFR6L11	
VK 20 T	LPG1	
VK 22	IFR7F-6D	
VK 24 PRZ 11	IFR8H11	
VK 27 PRZ 11	IFR9H11	
VKA 20	HB6AIX-11P	
VKB 20	HB6BIX-11P	
VKH 16	ILZFR5B	
VKH 20	ILZFR6D11	
VKJ 20 RZ-M 11	IZFR6F11	
VNH 27 Z	IMR9B-9H	
VUH 24 D	IMR8C-9H	
VUH 27 D	IMR9C-9H	
VUH 27 ES	IMR9C-9HES	
VUH 27 Z	IMR9A-9H	
VW 20 T	LPG2	
VX 22 BC	IJR7A9	
VX 22 BZ	IJR7A9	
W 9	B-2	
W 9 EP	BP-2E	
W 9 EPR	BPR2ES	
W 9 EXR-U	BPR2ES	
W 9 EX-U	BP-2E	
W 9 FP	BP-2H	
W 9 FPL	BP2HS	
W 9 FPLUL	BP2HS	
W 9 FPUL	BP2HS	
W 9 LMRUS	BR2-LM	
W 9 LMUS	B2-LM	
W 9 P	BP-4	
W 9 PR-U	BP-4	
W 9 P-U	BP-4	
W 9 U	B-2	
W 14	B-4	
W 14 E	B4ES	
W 14 EKR-S 11	BUR4EB-11	
W 14 EP	BP4ES	
W 14 EPR	BPR4ES	
W 14 EPR 11	BPR4ES-11	
W 14 EPR-U	BPR4ES	
W 14 EP-U	BP4ES	
W 14 EXR-U	BPR4EY	
W 14 EXR-U 11	BPR4EY-11	



DENSO	→ NGK	V-Line
W 14 EXR-U 13	BPR4ES-13	
W 14 EXRZ-U	GR4IX	
W 14 EX-U	BP4EY	
W 14 EX-U 11	BP4EY-11	
W 14 EX-U 13	BPR4ES-13	
W 14 EXZ-U	GR4IX	
W 14 F	B-4H	
W 14 FP	BP-4H	
W 14 FPL	BP4HS	
W 14 FPLUL	BP4HA	
W 14 FPR	BPR-4H	
W 14 FPRL	BPR4HS	
W 14 FPR-U	BPR-4H	
W 14 FPR-UL	BPR4HS	
W 14 FPR-UL 10	BPR4HS-10	
W 14 FP-U	BP-4H	
W 14 FP-UL	BP4HS	
W 14 FP-UL 10	BP4HS-10	
W 14 FRL	BR4HSA	
W 14 FR-U	BR4HS	
W 14 F-U	B-4H	
W 14 F-U 10	B-4H-10	
W 14 L	B-4L	
W 14 LMR-US	BR4-LM	
W 14 LM-U	B4-LM	
W 14 LM-US	B4-LM	
W 14 MPR-U 10	BPMR4A	
W 14 MP-U 10	BPM4A-10	
W 14 MR-U	BMR4A	
W 14 M-U	BM4A	
W 14 M-US	BM4A	
W 14 P	BP5S	
W 14 PR-U	BP-4	
W 14 P-U	BP-4	
W 14 U	B-4	
W 14 U 10	B-4	
W 14 US	B-4	
W 16 DTRS	BPR5EKB	
W 16 EKR-S 11	BUR5EB-11	
W 16 EK-S 11	BUR5EB-11	
W 16 EP	BP5ES	8
W 16 E-P 11	BP5ES-11	
W 16 EPB	BP5EY	
W 16 EPB 10	BP5ET-10	
W 16 EPG-U	BPR5EIX	
W 16 EPR	BPR5ES	6
W 16 EPR 11	BPR5ES-11	
W 16 EPR-S 11	BUR5EA-11	
W 16 EPR-U	BPR5ES	6
W 16 EPR-U 10	BPR5E-11	
W 16 EPR-U 11	BPR5ES-11	
W 16 EP-U	BP5ES	8

DENSO	→ NGK	V-Line
W 16 EP-U 10	BP5ES-11	
W 16 EP-U 11	BP5EY-11	
W 16 EPZ-U	BPR5EIX	
W 16 ES	B5ES	
W 16 ES-L 11	BR5ES	
W 16 ESRL	BR5ES	
W 16 ESR-L 11	BUR5EB-11	
W 16 ESR-U	BR5ES	
W 16 ES-U	B5ES	
W 16 ETL	BPR5EY	9
W 16 ETRS	BPR5EIX-11	
W 16 ETS	BP5EK-A	
W 16 EX	BP5EY	
W 16 EXR-U	BPR5EY	9
W 16 EXR-U 11	BPR5EY-11	
W 16 EXR-U 13	BPR5ES-13	
W 16 EXRZ-U	BPR5EIX	
W 16 EX-U	BP5EY	
W 16 EX-U 11	BP5EY-11	
W 16 EX-U 13	BP5ES-13	
W 16 EXZ-U	BPR5EIX	
W 16 FP	BP5HS	
W 16 FPL	BP5HA	
W 16 FPR	BPR5HS	
W 16 FPR-U	BPR5HS	
W 16 FP-U	BP5HS	
W 16 FPU 10	BP5HS-10	
W 16 FPUL	BP5HA	
W 16 FS	B5HS	
W 16 FSR	BR5HS	
W 16 FS-U	B5HS	
W 16 LS	B-6L	
W 16 PR-U	BP5S	
W 16 P-U	BP5S	
W 17	B6S	
W 17 ES	BR6ES	
W 17 FP	BP6HS	18
W 17 P	BP6S	
W 17 PR-U	BP6S	
W 17 P-U	BP6S	
W 20 DTRSA	BPR6EKB-L	
W 20 EA	B6EM	
W 20 EAR	BR6EM	
W 20 EKR-S 11	BUR6EB-11	
W 20 EK-S 11	BUR6EB-11	
W 20 EP	B6ES	
W 20 E-P 11	BP6ES-11	
W 20 EPB	BUR6ET	1
W 20 EPBR-S	BUR6ET	1
W 20 EPG-U	BPR6EIX	
W 20 EPR	BPR6ES	2
W 20 EPR 11	BPR6ES-11	13



DENSO	→ NGK	V-Line
W 20 EPR-S 11	BUR6EA-11	
W 20 EPR-U	BPR6ES	2
W 20 EPR-U 10	BPR6ES-11	13
W 20 EPR-U 11	BPR6ES-11	13
W 20 EPRZ-U	BPR6EIX	
W 20 EPRZ-U 11	BPR6EIX-11	
W 20 EP-S 11	BUR6EA-11	
W 20 EP-U	BP6ES	4
W 20 EP-U 10	BP6ES-11	
W 20 EP-U 11	BP6ES-11	
W 20 EPZ-U	BPR6EIX	
W 20 ES	B6ES	
W 20 ESG-U	B6EVX	
W 20 ESL	BR6ES	
W 20 ES-L 11	BUR6EB-11	
W 20 ESR	BR6ES	
W 20 ESRL	BR6ES	
W 20 ESR-L 11	BUR6EB-11	
W 20 ESR-U	BR6ES	
W 20 ES-U	B6ES	
W 20 ES-U 11	B6ES-11	
W 20 ESZ-U	B6EVX	
W 20 ET	BPR6EK-A	
W 20 ETL	BPR6EKN	
W 20 ETR	BPR6EK-A	
W 20 ETR-L	BPR6EKN	
W 20 ETR-L 8	BPR6EKN	
W 20 ETRS	BPR6EK-A	
W 20 ETS	BPR6EK-A	
W 20 EXR-U	BPR6EY	
W 20 EXR-U11	BPR6EY-11	10
W 20 EXR-U 13	BPR6EIX-11	
W 20 EXRZ-U	BPR6EIX	
W 20 EX-U	BP6EY	
W 20 EX-U 11	BP6EY-11	
W 20 EX-U 13	BP6ES-13	
W 20 EXZ-U	BPR6EIX	
W 20 FP	BP6HS	18
W 20 FPL	BP6HSA	
W 20 FPR	BPR6HS	3
W 20 FPRL	BPR6HSA	
W 20 FPR-U	BPR6HS	3
W 20 FPR-U 10	BPR6HS-10	
W 20 FPRU-L 10	BPR6HS-10	
W 20 FP-U	BP6HS	18
W 20 FP-U 10	BP6HS-10	
W 20 FRL	BR6HSA	
W 20 FS	B6HS	
W 20 FSG-U	BR6HIX	
W 20 FSR	BR6HS	
W 20 FSR-U	BR6HS	
W 20 FS-U	B6HS	

DENSO	→ NGK	V-Line
W 20 FSU 10	B6HS-10	
W 20 FSZ-U	BR6HIX	
W 20 M	BM6A	
W 20 MPRU 10	BPMR6A-10	
W 20 MP-U	BPM6A	
W 20 MPU 10	BPM6A-10	
W 20 MR-U	BMR6A	
W 20 M-U	BM6A	
W 20 MUS	BM6A	
W 20 PR-U	BP6S	
W 20 P-U	BP6S	
W 20 S	B6S	
W 20 SR-U	BR6S	
W 20 S-U	B6S	
W 21 ES-L 11	BR6EB-L-11	
W 21 ESR-L 11	BR6EB-L-11	
W 22	B7S	
W 22 EA	B7EM	
W 22 EAR	BR7EM	
W 22 EB	BR7ET	
W 22 EBR	BR7ET	
W 22 EDR	BR7EQ	
W 22 EDR 14	BR7EQ-14	
W 22 EKR-S 11	BUR7EB-11	
W 22 EK-S 11	BUR7EB-11	
W 22 EP	BP7ES	
W 22 E-P 11	BP7ES-11	
W 22 EPB	BP7ET	
W 22 EPG-U	BPR7EIX	
W 22 EPR	BPR7ES	19
W 22 EPR 11	BPR7ES-11	
W 22 EPR-S 11	BUR7EA-11	
W 22 EPR-U	BPR7ES	19
W 22 EPR-U 11	BPR7ES-11	
W 22 EPRZ-U	BPR7EIX	
W 22 EP-S 11	BUR7EA-11	
W 22 EP-U	BP7ES	
W 22 EP-U 11	BP7ES-11	
W 22 EPZ-U	BPR7EIX	
W 22 ES	B7ES	
W 22 ESG-U	BR7EIX	
W 22 ESL	BR7ES	
W 22 ES-L 11	BUR7EB-11	
W 22 ESR	BR7ES	
W 22 ESRL	BR7ES	
W 22 ESR-L 11	BUR7EB-11	
W 22 ESR-U	BR7ES	
W 22 ES-U	B7ES	
W 22 ES-U 11	B7ES-11	
W 22 ESZ-U	BR7EIX	
W 22 ETL	BPR7EKN	
W 22 ETRL	BPR7EKN	



DENSO	→ NGK	V-Line
W 22 ETR-L 8	BPR7EKN	
W 22 EXR-U	BPR7EIX	
W 22 EXR-U 11	BPR7EY-11	
W 22 EX-U	BP7EY	
W 22 FP	BP7HS	
W 22 FPR	BPR7HS	
W 22 FPR-U	BPR7HS	
W 22 FPRZ-U	BPR7HIX	
W 22 FP-U	BP7HS	
W 22 FP-U 10	BP7HS-10	
W 22 FPUS	BP7HS	
W 22 FS	B7HS	
W 22 FSG-U	BR7HIX	
W 22 FSR	BR7HS	
W 22 FSR-U	BR7HS	
W 22 FS-U	B7HS	
W 22 FSZ-U	BR7HIX	
W 22 M	BM7A	
W 22 MPR-U	BPMR7A	
W 22 MP-U	BPM7A	
W 22 MPUS	BPM7A	
W 22 M-U	BM7A	
W 22 MUS	BM7A	
W 22 S	B7S	
W 22 S-U	B7S	
W 24	B8S	
W 24 EMRC	BR8ECM	
W 24 EP	BP8ES	
W 24 E-P 11	BP8ES	
W 24 EPR	BPR8ES	
W 24 EPR-U	BPR8ES	
W 24 EPRZ-U	BPR8EIX	
W 24 EP-U	BP8ES	
W 24 ES	B8ES	
W 24 ESG-U	BR8EIX	
W 24 ESR	BR8ES	
W 24 ESR-U	BR8ES	
W 24 ESRV	BR8EG	
W 24 ESRZ-U	BR8EIX	
W 24 ES-U	B8ES	
W 24 ES-U 11	B8ES	
W 24 ESV	B8EG	
W 24 ESZ-U	B8EGV	
W 24 FP	BP8HS	
W 24 FPL	BPR8HSA	
W 24 FPR	BPR8HS	
W 24 FPRL	BPR8HSA	
W 24 FPR-U 10	BPR8HS-10	
W 24 FP-U	BP8HS	
W 24 FRL	BR8HSA	
W 24 FS	B8HS	
W 24 FSG-U	BR8HIX	

DENSO	→ NGK	V-Line
W 24 FSR	BR8HS	
W 24 FSR-U 10	BR8HS-10	
W 24 FS-U	B8HS	
W 24 FS-U 10	B8HS-10	
W 24 FSZ-U	BR8HIX	
W 24 S	B8S	
W 24 S-U	B8S	
W 25 EA	BR8EM	
W 25 EAR	BR8EM	
W 25 EB	BR8ET	
W 25 EBR	BR8ET	
W 25 EDR	BR8EQ	
W 25 EDR 14	BR8EQ-14	
W 25 EN	B8EG	
W 25 EPT	B8EGP	
W 25 FC	B8HCS	
W 25 FN	BR8HIX	
W 27 EBR	BR9ET	
W 27 EDR	BR9EQ-14	
W 27 EDR 14	BR9EQ-14	
W 27 EMRC	BR9ECM	
W 27 EMRZ-U	BR9ECMIX	
W 27 EN	B9EG	
W 27 EPT	BR9EIX	
W 27 ES	B9ES	
W 27 ESC	B9ECS	
W 27 ESG-U	BR9EIX	
W 27 ESR	BR9ES	
W 27 ESR-U	BR9ES	
W 27 ESRV	BR9EG	
W 27 ESRZ-U	BR9EIX	
W 27 ES-U	B9ES	
W 27 ESV	B9EG	
W 27 ESZ-U	B9EGV	
W 27 FC	B9HCS	
W 27 FN	BR9HIX	
W 27 FS	B9HS	
W 27 FSG-U	BR9HIX	
W 27 FSR	BR9HS	
W 27 FSR-U 10	BR9HS-10	
W 27 FS-U	B9HS	
W 27 FS-U 10	B9HS-10	
W 27 FSZ-U	BR9HIX	
W 29 EBR	BR10ET	
W 29 EPT	B95EGP	
W 29 ESG-U	B95EGV	
W 29 ESRV	BR10EG	
W 29 ESV	B10EG	
W 29 ESZ-U	B95EGV	
W 31 EMRC	BR10ECM	
W 31 EMRZ-U	BR10ECMIX	
W 31 EN	B10EG	



DENSO	→ NGK	V-Line
W 31 EPT	B10EGP	
W 31 ES	B10ES	
W 31 ESG-U	BR10EIX	
W 31 ESR-U	BR10ES	
W 31 ESRZ-U	BR10EIX	
W 31 ES-U	B10ES	
W 31 ESZ-U	B10EGV	
W 31 FS	B10HS	
W 31 FSG-U	BR10HIX	
W 31 FSZ-U	BR10HIX	
W 32 EPT	B105EGP	
W 34 EN	B11EG	
W 34 ESZ-U	B11EGV	
WA 20 M	BM6F	
WA 20 M-U	BM6F	
WA 22 M	BM7F	
WA 22 M-U	BM7F	
X 16 EPR-U 9	DPR5EA-9	
X 16 EP-U 9	DPR5EA-9	
X 16 FSR-U	DR5HS	
X 16 FS-U	D5HS	
X 20 EPR-U 9	DPR6EA-9	
X 20 EP-U 9	DP6EA-9	
X 20 ES-U	D6EA	
X 20 FSR-U	DR6HS	
X 20 FS-U	D6HA	
X 22 EPRGL	PJR7A	
X 22 EPR-U 9	DPR7EA-9	
X 22 EPRZ-U 9	DPR7EIX-9	
X 22 EP-U	DP7EA-9	
X 22 EP-U 9	DP7EA-9	
X 22 EPZ-U 9	DPR7EIX-9	
X 22 ESR-U	DR7ES	
X 22 ES-U	D7EA	
X 22 GPR-U	DPR7Z	
X 22 GP-U	DPR7Z	
X 24 EPR-U 9	DPR7EA-9	
X 24 EPRZ-U 9	DPR8EIX-9	
X 24 EP-U	DP8EA-9	
X 24 EP-U 9	DP8EA-9	
X 24 EPZ-U 9	DPR8EIX-9	
X 24 ESG-U	DR8EIX	
X 24 ESR-U	DR8ES-L	
X 24 ESRZ-U	DR8EIX	
X 24 ESRZ-U 9	DR8EIX	
X 24 ES-U	D8EA	
X 24 ESZ-U	DR8EIX	
X 24 ESZ-U 9	DR8EIX	
X 24 FSR-U	DR8HS	
X 24 FS-U	D8HA	
X 24 GPR-U	DPR8Z	
X 24 GP-U	DP8Z	

DENSO	→ NGK	V-Line
X 27 EPR-U 9	DPR7EA-9	
X 27 EPRZ-U 9	DPR9EIX-9	
X 27 EP-U 9	DP9EA-9	
X 27 EPZ-U 9	DPR9EIX-9	
X 27 ESR-U	DR8ES	
X 27 ESRZ-U	DR9EIX	
X 27 ESRZ-U 9	DR9EIX	
X 27 ES-U	D9EA	
X 27 ESZ-U	DR9EIX	
X 27 ESZ-U 9	DR9EIX	
X 27 ET	J9A	
X 27 ETR	JR9B	
X 27 GPR-U	DPR9Z	
X 27 GP-U	DP9Z	
X 29 ESZ-U	DR9EIX	
X 31 ES-U	D10EA	
X 31 ETR	JR10B	
XE 20 HR-U 9	LZKAR7A	
XU 20 EPR-U	DCPR6E	
XU 20 EP-U	DCP6E	
XU 22 EPP	DCPR7EIX	
XU 22 EPR	DCPR7E	
XU 22 EPRP	DCPR7EIX	
XU 22 EPR-U	DCPR7E	
XU 22 EPRZ-U	DCPR7EIX	
XU 22 EP-U	DCP7E	
XU 22 EPZ-U	DCPR7EIX	
XU 22 HDR 9	LKR7B-9	
XU 24 EPRP	DCPR8EIX	
XU 24 EPR-U	DCPR8E	
XU 24 EPRZ-U	DCPR8EIX	
XU 24 EP-U	DCPR8E	
XU 24 EPZ-U	DCPR8EIX	
XU 27 EPR-U	DCPR9E	
XU 27 EPRZ-U	DCPR9EIX	
Y 24 FERC	ER8EH	
Y 27 FER	ER9EH	
Y 27 FERC	ER9EH	
Y 31 FERC	ER10EH	
Z 20 ES-U	D6EA	
ZXU 20 PR 11	IKR6G11	
ZXU 22 PR 11	IKR6G11	
D 1	BUR6ET	1
D 2	BPR6ES	2
D 3	BPR6HS	3
D 4	BP6ES	4
D 5	BP6EFS	5
D 6	BPR5ES	6
D 7	BPR6EFS	7
D 8	BP5ES	8
D 9	BPR5EY	9
D 10	BPR6EY-11	10





DENSO	→ NGK	V-Line
D 11	BCPR6EY-11	
D 12	BKR6E	28
D 13	BPR6ES-11	13
D 14	BKR6E-11	14
D 15	ZGR5A	15
D 17	BCP6ES	17
D 18	BP6HS	18
D 19	BPR7ES	19
D 20	BKR6EKUB	
D 21	BKR5E-11	33
D 22	BKR6E	28
D 23	BCPR7ES	
D 24	BP5EY	
D 25	BP6EY	
D 26	BPR6EY	
D 27	BP7ES	
D 28	AP6FS	
D 29	BUR6ET	1
D 30	BKR5EYA	
D 31	BKR6EYA	
D 32	BKR5EYA-11	39
D 33	BKR6EY-11	
D 34	ZFR4F-11	
D 35	ZFR5F-11	
D 36	ZFR5E-11	
D 37	ZFR5J-11	
D 38	ZFR6J-11	
D 39	BCPR5EY	
D 40	BCPR5EY-11	
D 41	BCPR6EY-11	
D 42	BCPR5E	32
D 43	BCPR5EY-11	
D 44	ZFR6A-11	
D 45	BP4EY	
D 47	BP5EY-11	
D 49	BP6EY-11	
D 51	BUR6EB-11	
D 53	BR8EQ-14	
D 54	B5ES	
D 55	B6ES	
D 56	B7ES	
D 57	B5HS	
D 58	B6HS	
D 59	BPR5EFS	
D 62	BP5FS	
D 63	BPR5FS	
D 64	BPR5FS-11	
D 65	BPR5FS-15	
D 66	BR5FS	
D 67	BPR6FS	
D 69	BPR6FS	
D 71	BP5HS	

DENSO	→ NGK	V-Line
D 73	BPR4FS	
D 74	BP7HS	
D 76	BKUR6ET-10	24
D 77	BKR5E	35
D 79	SD10A	
D 80	SD11A	
D 81	APR6FS	
D 85	BP4ES	
D 86	BPR5EY-11	
D 89	BRE529Y	
D 93	BP5S	
D 94	BKR6EKB-11	
D 95	BRE529Y-11	
D 96	BCPR5EY-11	
D 98	APR5FS	
D 99	BKR5EKB-11	
D 100	BPR5ES-11	
D 101	BKR5E-N-11	
D 102	BCPR6EY	
D 103	BKR5EIX	
D 104	BKUR6EK	
D 105	BKUR6ET	27
D 106	ZFR6F-11	
D 109	BR9EQ-14	
D 110	ZFR6K-11	
D 112	BKR6EKC	26
D 116	BKR7E-11	
D 117	BKR6E-N-11	
D 118	LF6C-11	
D 130	BP5EY-11	
D 135	BR6ES	
D 135	BR8ES	
D 136	BR7ES	
D 137	BPR4EY-11	
D 138	BUR6EA-11	
D 139	BPR5E-11	
D 140	BPR4ES	
D 141	BPR6EFS-15	
D 143	BCRE527Y	
D 144	BR6FS	
D 145	BRE527Y-11	
D 148	BKR7E	
D 149	BKR5EIX-11	
D 150	BUR7EB-11	
D 151	BCPR4EY-11	
D 152	ZFR4F-11	
D 153	BCPR7ES-11	
D 155	ZFR5A-11	
D 156	BKR8E-11	
D 160	BPR4FS-15	
D 162	BP6FS	
D 163	BP7EFS	



DENSO	→ NGK	V-Line
D 164	BKUR7ET	
D 165	BP7ET	
D 166	LFR5A-11	
D 167	LZKAR7A	
D 168	FR6EI	
D 171	LKR7B-9	
I 01	BCPR5EIX-11	
I 02	BCPR6EIX-11	
I 03	BKR5EIX-11	
I 04	BKR6EIX-11	
I 05	BPR5EIX-11	
I 06	BPR6EIX-11	
I 07	BPR7EIX	
I 08	DCPR7EIX	
I 16	BR8EIX	
I 17	BR9EIX	
I 19	BR10EIX	
I 25	TR5IX	
I 26	TR6IX	
I 27	TR7IX	
I 28	TR8IX	
I 30	UR5IX	
I 31	UR6IX	
I 35	FR8BI-11	
I 36	FR9BI-11	
I 43	LFR5AIX-11	
I 44	LFR6AIX-11	
I 61	CR7EIX	
I 62	CR8EIX	
I 63	B8HCS	
I 68	CR8EHIX-9	
I 69	CR9EHIX-9	
I 72	DR8EIX	
I 73	DR9EIX	
I 75	DPR7EIX-9	
I 76	DPR8EIX-9	
I 77	DPR9EIX-9	
I 78	BPR6HIX	
I 79	BR7HIX	
I 80	BR8HIX	
I 81	BR9HIX	
I 83	CR7HIX	
I 84	CR8HIX	
I 88	IMR9A-9H	
I 90	CR9EIA-9	
I 91	BR8ECMIX	
I 92	BR9ECMIX	
I 93	BR10ECMIX	
I 100	ER8EHIX	
I 101	ER9EHIX	
P 1	BCPR6EP-11	
P 2	BCPR5EIX-11	

DENSO	→ NGK	V-Line
P 3	BPR5EP-11	
P 6	BKR6EP-11	
P 8	BKR5EP-11	
P 10	PZFR5F-11	
P 11	PZFR6F-11	
P 12	BKR6EKP-11	
P 13	PGR5A-11	
P 14	PFR6J-11	
P 15	PFR6G-11	
P 16	PTR5A-13	25
P 17	BKR5EKP-11	
P 18	PTR5D-10	31
P 19	PZFR5F	
P 21	PGR6A-11	
P 22	PFR5B-11	
P 23	BCPR6EP-8	
P 24	PGR5A	
P 25	BKR6EP-13	
P 26	BKR6EP-8	
P 27	PFR6J	
P 28	PFR6B-11	
P 29	BCPR6EIX-11	
P 30	PFR7G-11S	
P 31	PFR7B	
P 32	BKR6EPA-8	
P 35	PZTR5A-15	
P 36	BCPR6EP-N-8	
P 38	BKR5EKP-13	
P 40	PGR6A	
P 41	PFR5J-11	
P 46	PZFR5F-13	
P 47	PZFR6F-11	
P 50	PFR6G-13	
P 51	BCPR5EP-8	
P 52	PZFR6F	
P 53	BPR6EP-8	
P 54	BPR5EP-11	
P 55	PGR7A	
P 62	BCPR6EIX-11	
P 63	PFR7B-11	
P 80	BKR6EKPA	
R 01	R7434-8	
R 02	R7434-9	
R 03	R7434-10	
R 05	R7434-9	
R 06	R7434-10	
R 24	R7282A-105	
R 25	R7282A-11	
R 31	R2525-9	
R 32	R2525-10	
R 33	R2349-11	
R 47	R7282-105	



DENSO	→ NGK	V-Line
R 48	R7282-11	
S 2	IFR6T11	
S 3	IFR5T-8N	
S 7	IFR6C	
S 11	HB6BIX-11P	
S 13	IGR7A	
S 14	IFR5E11	
S 17	IFR7G-11KS	
S 18	BKR6EP-8	
S 19	IZFR6K11	
S 20	ZFR6FIX-11	
S 21	IFR6S	
S 22	IFR5E11	
S 24	IZFR6K13	
S 25	IFR6E11	
S 27	ILFR5T11	
S 29	IFR7G-11KS	
S 32	IZFR5K11	
S 33	ILFR6T11	
S 34	IFR5G-11K	
S 37	IKR7C	
S 41	IZFR6K11NS	
S 42	ILFR6J-11K	
S 43	ILKR7B8	
S 45	DILKAR6A11	
S 48	ILKAR7B11	
S 49	DF7H-11B	
S 52	IFR6J11	
S 54	IKR6G11	
S 59	DF8H-11B	
S 61	ILZKR7B11GS	
S 64	HB6AIX-11P	
S 65	DFH6B-11A	
V 04	IZFR6H11	
V 10	IFR7F-6D	
V 14	IJR7A9	
V 17	ILZFR5B	
V 18	ILZFR6D11	
V 25	HB6BIX-11P	
V 26	IMR8C-9H	
V 27	IMR9C-9H	
V 31	IMR9B-9H	
V 33	IZFR6F11	
V 42	IMR9C-9HES	
3004	BPR5EP-11	
3005	BCPR5EIX-11	
3006	BCPR5EY-11	
3009	BCPR6EY-11	
3011	BP4EY	
3013	BPR4EY	
3018	BP5ES	8
3025	B5ES	

DENSO	→ NGK	V-Line
3027	BP5EY	
3032	BPR5EY-11	
3034	B5HS	
3036	BP5S	
3043	BP6ES	4
3046	BUR6EA-11	
3049	BPR6ES-11	13
3051	B6ES	
3057	BR6ES	
3062	BP6EY	
3066	BPR6EY	
3067	BPR6EY-11	10
3068	BP6HS	18
3070	BPR6HS	3
3073	B6HS	
3074	BR6HIX	
3075	B6S	
3085	BP7ES	
3088	BPR7ES	19
3089	BPR7ES-11	
3093	B7ES	
3095	BR7EIX	
3098	BR7ES	
3103	BR8ET	
3107	BR9ET	
3110	BR5ES	
3111	SD11A	
3112	ZFR6A-11	
3113	BCPR6EP-N-8	
3114	PGR5A-11	
3115	PGR6A-11	
3117	BCPR6EP-11	
3119	BKR5EYA	
3120	BKR5EYA-11	39
3121	BKR6E-11	14
3122	BKR6EYA	
3123	BCPR5EP-8	
3125	BCP6ES	17
3127	BKR6EP-8	
3128	BKR6EP-11	
3129	BCPR5EY	
3130	BKR5E-11	33
3131	ZFR5J-11	
3132	ZFR5F-11	
3133	ZFR6J-11	
3134	BKR5EP-11	
3135	ZFR5E-11	
3139	BKR6EY-11	
3140	BCPR6EY	
3141	PFR6J-11	
3142	PFR6G-11	
3144	BKR6E-N-11	



DENSO	→ NGK	V-Line
3156	BCPR5EIX-11	
3157	BCPR6EIX-11	
3158	BCP7EVX	
3161	BKR5EIX-11	
3163	BKR6EIX-11	
3165	BKR7E	
3167	ZFR4F-11	
3168	PFR6B-11	
3169	ZFR6F-11	
3172	PFR6G-13	
3174	PFR5J-11	
3175	PZFR5F	
3179	DCPR7E	
3184	BCPR5EY-11	
3186	BCPR5EY-11	
3187	BCPR6EY-11	
3192	BKR7E-11	
3194	BKR5EKB-11	
3195	BKR6EKB-11	
3196	BKUR6EK	
3197	BKUR7EK	
3199	BP5EY-11	
3201	BPR5ES-11	
3210	BPR5EY	9
3213	BPR5ES-13	
3226	BKR6EP-13	
3231	BPR5EIX	
3235	BCRE527Y	
3239	BPR5EP-11	
3242	DCPR7EIX	
3244	BCPR6EIX-11	
3245	PFR6J	
3246	PZFR5F-11	
3247	PZFR6F-11	
3253	BKR6EKPB-11	
3255	BCP7ES	
3256	ZGR5A	15
3262	BKR6EIX-11	
3264	PFR5B-11	
3273	PFR7B	
3275	PFR5G-11	
3277	BPR6EKN	
3281	BPR7EIX	
3285	BPR5EIX-11	
3289	BKR5EKPB-11	
3290	BKR7EIX	
3291	BPR6EIX	
3293	BKR5EIX	
3297	IFR6T11	
3299	BKR7E-N-11	
3302	PGR7A	
3303	IFR5T-8N	

DENSO	→ NGK	V-Line
3304	BKR6EKC	26
3305	BKUR6EK-9	
3306	PGR6A	
3307	IFR6C	
3310	BR10ET	
3312	DCPR8E	
3313	DCPR9E	
3314	DCPR9EIX	
3323	BPR6EIX-11	
3333	BKR6E	28
3344	BPR6ES	2
3345	BPR5ES	6
3346	BCPR5E	32
3347	BCPR7ES	
3348	ZFR7F-11	
3349	BKR5E	35
3354	IGR7A	
3372	IFR7G-11KS	
3373	BKR6EP-8	
3374	ZFR6K-11	
3377	IZFR6K11	
3378	ZFR6FIX-11	
3379	BCPR7ES-11	
3380	BKR6EKPA	
3381	LFR6C-11	
3400	IFR5E11	
3403	IFR6S	
3412	IFR5E11	
3413	ZFR5F	
3418	IFR6E11	
3424	BKR6E	28
3427	LZKAR7A	
3432	IZFR6K11NS	
3434	IKR7C	
3437	FR5EI	
3439	DILKAR6A11	
3441	ILKR7B8	
3444	ILKAR7B11	
3449	IFR6J11	
4019	BP5HS	
4021	BP7HS	
4025	B7HS	
4026	BR7HIX	
4027	B7S	
4028	BP8ES	
4030	B8ES	
4032	B8EGV	
4048	B9EGV	
4057	B95EGV	
4093	DP8EA-9	
4097	DPR8EIX-9	
4136	BPR8ES	



DENSO	→ NGK	V-Line
4167	DR8EIX	
4172	DR9EIX	
4189	CR8EIX	
4201	CR7EK	
5008	APR5FS	
5012	AP6FS	
5013	APR6FS	
5022	BPR5EFS	
5027	BPR5FS-15	
5031	BP6EFS	5
5032	BPR6EFS	7
5035	BPR6FS	
5040	BP7EFS	
5060	BKUR6ET	27
5061	BKUR6ET-10	24
5062	BKUR7ET	
5063	BKR6EKUB	
5064	BP5ET-10	
5065	BUR6ET	1
5066	BP7ET	
5067	BUR6ET	1
5068	PTR5A-13	25
5069	BCP7ET	
5070	PTR5D-10	31
5077	PZTR5A-15	
5301	BCPR5EIX-11	
5302	BCPR6EIX-11	
5303	BKR5EIX-11	
5304	BKR6EIX-11	
5305	BPR5EIX-11	
5306	BPR6EIX-11	
5307	BPR7EIX	
5308	DCPR7EIX	
5316	BR8EIX	
5317	BR9EIX	
5325	TR5IX	
5326	TR6IX	
5327	TR7IX	
5328	TR8IX	
5330	UR5IX	
5331	UR6IX	
5343	LFR5AIX-11	
5344	LFR6AIX-11	
5361	CR7EIX	
5362	CR8EIX	
5372	DR8EIX	
5376	DPR8EIX-9	
5378	BPR6HIX	
5379	BR7HIX	
5604	ILZFR6H11	
5615	IFR6L11	
5616	IFR8H11	

DENSO	→ NGK	V-Line
5617	ILZFR5B	
5618	ILZFR6D11	
5623	HB6AIX-11P	
5625	HB6BIX-11P	
5630	IFR9H11	
6054	B6HS	
6076	LFR5A-11	
DODGE => CHRYSLER		
ENKER	→ NGK	V-Line
F 45 CP	BP4HS	
F 50 C	B5HS	
F 55 CP	BP5HS	
F 65 CP	BP6HS	18
F 75 C	B6HS	
F 80 C	B7HS	
F 85 CP	BP7HS	
F 100 C	B8HS	
FA 50	B-4L	
FA 70	B-6L	
FE 30 C	B4ES	
FE 35 CP	BP4ES	
FE 45 CP	BP5ES	8
FE 50 C	B5ES	
FE 55 CP	BP5ES	8
FE 55 CPD	BP5ET	
FE 65 CP	BP6ES	4
FE 65 CPD	BUR6ET	1
FE 70 C	B6ES	
FE 75 C	B7ES	
FE 80 C	B8ES	
FE 85 CP	BP7ES	
FE 85 CPD	BP7ET	
FE 85 CPU	BP7ET	
FE 95 CP	BP8ES	
FE 100 C	B9ES	
FET 65 CP	BP5EFS	
FET 75 CP	BP6EFS	5
FS 20	B-2	
FS 30	B-4	
FS 50 CP	BP5S	
FS 55 CP	BP6S	
FS 70	B6S	
FS 75 C	B7S	
FS 80	B8S	
FT 45 CP	BP5FS	
FT 55 CP	BP6FS	
FT 85 CP	BP7FS	
M 30	AB-2	
M 60	AB-6	





<b>ENKER</b>	<b>→ NGK</b>	<b>V-Line</b>
M 75	AB-7	
M 80	AB-8	
MT 45 CP	AP5FS	
MT 55 CP	AP6FS	
MT 65 CP	AP7FS	
SFE 55 CP	BKR5ES	35
SFE 65 CP	BKR6ES	28
SFE 65 CPD	BCP6ET	
SFE 65 CPR	BPR5ES	6
SFE 85 CP	BCPR7ES	
SFE 85 CPD	BCP7ET	
T 70	C6HSA	
T 90	C7HSA	
<b>EYQUEM</b>	<b>→ NGK</b>	<b>V-Line</b>
30 AM	B-4L	
50 AM	B-6L	
50 M	B5HS	
70 M	B6HS	
75 LM	B6ES	
75 M	B6HS	
100 M	B8HS	
200	B-4H	
300 AM	B-4L	
400 J	BR5FS	
406	BP6HS	18
450 JS	BPR4FS-15	
450 L	B5ES	
480 CS	BP5S	
500 AM	B-6L	
500 C	B6S	
500 CM	B6S	
500 CS	BP5S	
500 J	BR6FS	
500 JS	BPR4FS	
500 M	B5HS	
505 JS	BP5FS	
520 CS	BP5S	
550 CS	BP5S	
550 JS	BPR5FS	
550 LS	BP5ES	8
550 S	BP4HS	
580 LS	BP5ES	8
580 S	BP4HS	
600 CS	BP5S	
600 JS	BPR6FS	
600 L	B6ES	
600 LS	BP6ES	4
600 S	BP5HS	
700	B6HS	
700 CM	B6S	

<b>EYQUEM</b>	<b>→ NGK</b>	<b>V-Line</b>
705 JS	BP7FS	
705 L	B6ES	
705 S	BP6HS	18
707 LS	BP6ES	4
750	BP6HS	18
750 L	B6ES	
750 LJS	BP6EFS	5
750 LS	BP6ES	4
753 LJS	BP6EFS	5
755	B6HS	
755 CM	B6S	
755 L	B6ES	
755 LJS	BP6EFS	5
755 LS	BP6ES	4
755 M	B6HS	
755 S	BP6HS	18
775 SX	BP6HS	18
775 X	B6HS	
800 L	B6ES	
800 LJS	BP6EFS	5
800 LS	BP6ES	4
802 L	B6ES	
803 LJS	BP6EFS	5
805 L	B6ES	
805 LJS	BP7EFS	
805 LJSP	TR7IX	
805 LP	BR8EIX	
850	B7HS	
850 LS	BP7ES	
883 LJP	B8EFS	
1000	B8HS	
1000 CM	B7S	
1000 L	B8ES	
1000 M	B8HS	
1100	B9HS	
1100 L	B8ES	
1150 L	B9ES	
C 32	B5HS	
C 32 LS	BP5ES	8
C 32 S	BP5HS	
C 42 LJS 3	BP6EFS	5
C 42 S	BP6HS	18
C 52 LS	BP5ES	8
C 62	B7HS	
C 62 LJS	BP6EFS	5
C 62 LS	BP6ES	4
C 62 LS 3 X	BP5ET	
C 62 S	BP7HS	
C 72 LJS	BP7EFS	
C 72 LS	BP7ES	
C 72 LS 3 X	BUR6ET	1
C 82 LJS	BP7EFS	



EYQUEM	→ NGK	V-Line
C 82 LS	BP7ES	
C 82 LS 3 X	BP7ET	
C 92 LS	BP8ES	
D 775	D6HA	
D 800 L	D7EA	
D 900 L	D8EA	
D 1000	D8HA	
D 1000 L	D9EA	
D 1050 L	D9EA	
FC 42 LS	BCP5ES	16
FC 52 LS	BCP5ES	16
FC 58 LS	BCP6ES	17
FC 62 LS	BCP6ES	17
FC 62 LS 2	BCP6ES	17
FC 62 LS 3	BCP6ET	
FC 62 LS 3 X	BCP6ET	
FC 72 LS	BCP7ES	
FC 82 LS	BCPR7E	
FC 82 LS 1	BCP7ES	
FC 82 LS 2	BCP7ES	
FN 52 LS	BK5ESZ	
K 200 M	AB-6	
K 300 JS	AP5FS	
K 300 M	AB-6	
K 350 JS	AP5FS	
K 450 JS	AP5FS	
K 500 M	AB-6	
K 550 JS	AP6FS	
K 600 M	AB-6	
K 750 M	AB-7	
KC 62 JS	AP6FS	
R 850	BR7HS	
R 1000	BR8HS	
R 1000 L	BR8ES	
RC 32 LS 5	BPR4ES-11	
RC 42 S	BPR6HS	3
RC 52 LS	BPR5EY	9
RC 52 LS 5	BPR5EY-11	
RC 52 LZ 3 EX	BUR5ET	22
RC 52 LZE	ZGR5A	15
RC 58 LZ 3 EX	BUR6ET	1
RC 62 HJSDP	PTR5A-13	25
RC 62 LJS	BPR6EFS	7
RC 62 LS	BPR6ES	2
RC 62 LS 5	BPR6ES-11	13
RC 62 S	BPR7HS	
RC 82 LS	BPR7ES	19
RC 82 LS 5	BPR7EY-11	
RFC 42 LS	BKR5ES	35
RFC 42 LS 2 E	BKR5EK	23
RFC 42 LZ 2 E	BKR6EK	20
RFC 50 LZ 2 E	BKR5EK	23

EYQUEM	→ NGK	V-Line
RFC 52 LS	BKR5ES	35
RFC 52 LS 3	BKR6ETUC	
RFC 52 LS 5	BKR5ES-11	33
RFC 52 LSP	BKR6EK	20
RFC 52 LZ 3 EX	BKUR5ET	29
RFC 52 LZE	ZFR5F	
RFC 52 LZK	BKR5EZ	36
RFC 57 LS 3	BCPR6ET	
RFC 58 LS	BKR6ES	28
RFC 58 LS 2 E	BKR6EK	20
RFC 58 LS 3	BCPR6ET	
RFC 58 LS 5	BKR6ES-11	14
RFC 58 LSP	BKR6EZ	38
RFC 58 LZ	BKR6EY	
RFC 58 LZ 2	BKR6EKC	26
RFC 58 LZ 2 E	BKR6EK	20
RFC 58 LZ 3 EX	BKUR6ET	27
RFC 58 LZ 5	BKR6EY-11	
RFC 58 LZDP	PFR6G-9	
RFC 58 LZE 5	ZFR6F-11	
RFC 62 LS 3	BKR6ES-11	14
RFC 62 LS 3 X	BCPR6ET	
RFC 62 LS 5	BKR6ES-11	14
RFC 62 LZ 3 X	BKUR7ET	
RFC 82 LS	BCPR7ES	
RFC 82 LS 5	BCPR7ES-11	
RFCLZ 3 X	BKUR7ET	
RFN 52 HZ	LF6R5B	
RFN 52 HZ 3 A	LF6R5B	
RFN 58 HZ	LF6R6B	
RFN 58 LZ	BKR6EK	20
T 850	C7HSA	
XKC 62 JS	APR6FS	

#### FERRARI => FIAT Group

FIAT Group	→ NGK	V-Line
15 57 43	PKR9B	
16 83 25	PMR8A	
16 94 83	PMR7A	
19 26 37	PMR8B	
31 32 53 225	DCPR8E	
46 14 47 31	DCPR8E	
46 22 92 51	BP6ES	4
46 41 33 860	BKR6EKC	26
46 41 70 10	BKR6E	28
46 44 96 90	BKR6EKPA	
46 46 38 01	BKR6EKC	26
46 47 20 21	BKR6EKC	26
46 47 51 64	BCPR7ET	
46 48 03 07	BKR6EKC	26



FIAT Group	→ NGK	V-Line
46 48 03 09	BKR5EKC	
46 48 03 62	BKR6E	28
46 48 12 73	DCPR8E	
46 48 42 73	DCPR8E	
46 52 15 29	BKR6EKPA	
46 52 15 30	PMR7A	
46 53 19 17	DCPR8EKC	
46 53 19 18	BKR5EZ	36
46 54 84 78	BKR6EZ	38
46 54 95 76	BKR6EKPA	
46 54 95 77	PMR7A	
46 55 09 92	CR7EKC	
46 75 05 45	DCPR8E-N	
46 75 96 88	BP6E	4
46 82 32 99	DCPR7E-N	
50 40 82 651	IFR7F-6D	
55 18 26 23	FR5CP	
55 18 88 57	DCPR7E-N-10	
55 19 07 88	ZKR7A-10	
55 21 06 85	IKR9J8	
55 21 72 32	ILKAR7D6G	
55 23 23 60	ZKR7AI-8	
55 24 00 46	LKR7DI-12	
55 24 98 68	IKR9J8	
58 94 58 5	BPR7ES	19
58 94 58 6	BKR6E	28
58 94 58 8	BCPR7ES	
58 96 82 4	BKR6EKC	26
59 84 03 6	BPR6ES	2
60 33 02 211	BP7HS	
60 50 45 63	BP6ES	4
60 51 28 48	BCP6ET	
60 51 29 29	B7ES	
60 56 90 86	PGR6A	
60 56 99 57	PFR6B	
60 57 99 03	PFR6B	
60 59 74 90	BCP7ES	
60 59 94 95	PMR7A	
60 80 03 25	BPR7ES	19
60 80 60 24	BUR6ET	1
60 81 06 89	PFR6B	
71 71 16 38	BKR6E	28
71 71 16 39	BPR6ES	2
71 71 16 40	BPR6ES	2
71 71 18 06	BPR6ES	2
71 71 18 08	BKR6E	28
71 73 98 67	ZFR5F-11	
71 75 02 23	IFR6J11	
75 46 51 9	BKR6E	28
75 54 43 6	BPR7ES	19
75 54 44 2	BP6ES	4
75 54 44 4	BPR6ES	2

FIAT Group	→ NGK	V-Line
75 54 44 5	BP6HS	18
75 65 47 6	BR8ES	
76 86 64 3	BUR6ET	1
77 60 38 1	BPR7ES	19
77 60 38 2	BPR6ES	2
77 60 38 3	BKR6E	28
77 60 38 4	BCPR7ES	
77 69 24 3	BCPR6ET	
77 72 45 3	BKR6E	28
77 72 51 5	BPR7ES	19
79 10 24 72 04	BPR6EFS	7
7FY SR	BPR7ES	19
7FY SSR	BPR7ES	19
7GB YSR4	BCPR7ET	
7GY SSR	BCPR7ES	
96 14 73 86 80	BKR6EK	20
96 18 49 45 80	BKR5EK	23
96 18 57 18 80	BKR6EK	20
96 19 62 45 80	BKR5EK	23
96 39 81 43 80	BKR6EZ	38
9FY SSR	BPR6ES	2
9GY SSR	BKR6E	28

FORD	→ NGK	V-Line
10 32 705	BKR5EKUP	
10 77 002	PTR5A-13	25
11 20 170	PZFR5D-11	34
12 02 935	PLTR6A-10G	
12 04 572	PTR6F-13	
12 19 309	TR5B-13	
12 55 464	TR5B-13	
13 07 093	PTR6D-13G	
13 15 691	ITR6F13	
13 62 012	TR5B-13	
13 69 704	TR6AP-13	
13 79 739	ILTR5A-13G	
14 93 001	TR5B-13	
15 05 812	PLFR6A	
15 42 499	ZKR7A-10	
16 85 720	ILZTR6A8G	
35 39 125	PTR5D-10	31
43 31 810	PTR5D-13	
51 00 429	ILTR6G8G	
1M50-12405-CA	PLTR6A-10G	
1S7J-12405-DA	PTR6F-13	
1S7J-12405-EB	PTR6D-13G	
1S7J-18344-EB	PTR6D-13G	
3S4J-12405-AB	ITR6F13	
3S4J-18344-AB	ITR6F13	
4M5G-12405-XC	TR5B-13	
4M5G-12405-XE	TR5B-13	
5M5G-12405-AA	TR6AP-13	



<b>FORD</b>	<b>→ NGK</b>	<b>V-Line</b>
5M5G-18344-AA	TR6AP-13	
6118-61240-5BB	ILTR5A-13G	
6M5J-12405-AA	PLFR6A	
6M8G-12405-BB	ILTR5A-13G	
95VW-12405-DA	BKR5EKUP	
9A6G-12405-AA	ILTR6G8G	
9A6G-12405-BA	ILTR6H8G	
9A6G-12405-CA	ILTR6H8G	
9S51-12405-AA	ZKR7A-10	
AYFS-092FE-C	PLTR6A-10G	
BM5G-12405-CA	ILZTR6A8G	
F43E-12405-EB	PTR5D-13	
XS4F-12405-DA	PTR5A-13	25
YM21-12405-AA	PZFR5D-11	34
YN2F-12405-A2A	TR5B-13	
YN2J-12405-AA	TR5B-13	

<b>GM</b>	<b>→ NGK</b>	<b>V-Line</b>
12 14 046	PFR6T-G	
12 14 060	PFR6D10G	
12 14 065	DILFR7B10G	
12 14 066	IFR7X7G	
12 14 528	ZFR6BP-G	
48 11 581	ILTR5D	
5 958 780	BCP5EVX	
9 399 866	PFR6H-10	
12 556 183	PTR5C-13	
12 561 466	PTR5C-13	
12 563 707	PZTR5A-15	
12 565 030	PTR4B-15	
12 568 387	ITR4A15	
12 571 535	PTR5C-13	
12 578 277	PZTR5A-15	
12 620 540	ILTR5D	
12 787 099	PFR6T-10G	
12 788 884	PLFR6C-10G	
24 504 873	PTR4B-15	
30 520 467	BCPR6ES-11	11
32 000 330	BCPR7ES-11	
55 182 623	FR5CP	
55 562 534	PFR6T-G	
55 564 215	BKR7ESC-11	
55 564 748	DILFR7B10G	
55 564 763	ZFR6BP-G	
55 565 219	ZFR6V-G	
55 571 391	PFR6D10G	
55 576 026	IFR7X7G	
92 141 875	BPR6EFS-15	
93 161 199	PFR6G-9	
96 464 000	DCPR8E	

<b>HONDA</b>	<b>→ NGK</b>	<b>V-Line</b>
1 633 098	R0409B-10	
30717002 / 0	DR9EA	
12260-RL6-G010	ILZKR7B11GS	
12290-P5M-A000	PZFR6F-11	
12290-P73-J001	PFR7G-11	
12290-PCX-0000	PFR7G-11S	
12290-PCX-9999-TA	PFR7G-11S	
12290-PCX-J000	PFR7G-11S	
12290-PFD-J000	IFR6C	
12290-PGE-A01	PZFR6F-11	
12290-PNA-0030	IZFR6K13	
12290-PND-A010-M1	IZFR6K11	
12290-PNE-0030	ZFR6K-11	
12290-PRB-A010-M1	IFR7G-11KS	
12290-R60-U010-M1	IZFR6K11NS	
12290-RB0-J01	DIFR6D13	
12290-RB0-J110-M1	DIFR6D13	
12290-RB0-JB11	DIFR6D13	
12290-RB1-0030	IZFR6K13	
12290-RB1-0031	IZFR6K13	
12290-RB0-J11	DIFR6D13	
12290-RL6-G01	ILZKR7B11GS	
12290-RL6-G010-M1	ILZKR7B11GS	
12290-RMX-0030	ILFR6J-11K	
12290-RMX-0130	ILFR6J-11K	
12290-RSH-0030	IFR6G-11K	
12290-RW0-003	DILFR6J11	
12290-RW0-003	DILFR6J11	
31901-NN2-0030	BR6ES	
31901-NX4-7020-M1	R7376-10	
31901-NX4-9010	R7376-10	
31908-KRN-A41	R0451B-8	
31908-KRN-A410-M1	R0451B-8	
31908-KTW-901	LMAR8A-9	
31908-KTW-9010-M1	LMAR8A-9	
31908-KTW-9011-M1	LMAR8A-9	
31908-MGC-003	LMAR8A-9S	
31908-MGC-0031	LMAR8A-9S	
31908-MGC-A0000	LMAR8A-9S	
31908-ZZ3-0030	LMAR6C-9	
31908-ZZ3-A0031	LMAR6C-9	
31909-MEN-A31	SILMAR9A9S	
31909-MEN-A310-M1	SILMAR9A9S	
31909-MGC-0031	LMAR8A-9S	
31910-MEE-R110-M1	R0409B-10	
31910-MEN-A31	SILMAR10A9S	
31911-HW1-671	IMR9D-9H	
31911-HW1-6710-M1	IMR9D-9H	
31911-KRN-731	R0409B-8	
31911-KRN-7310-M1	R0409B-8	
31911-KSK-731	BR9EG-N-8	
31911-KSK-7310-M1	BR9EG-N-8	



HONDA	→ NGK	V-Line
31911-MBT-F21	IJR8B9	
31911-MBT-F210-M1	IJR8B9	
31911-MBW-E11	IMR8C-9H	
31911-MBW-E111-M1	IMR8C-9H	
31911-MBW-E112-M1	IMR8C-9H	
31911-MEE-J01	IMR8C-9HES	
31911-MEE-J010-M1	IMR8C-9HES	
31911-MEE-J011-M1	IMR8C-9HES	
31912-KRN-731	R0409B-9	
31912-MBW-E11	IMR9C-9H	
31912-MBW-E110	IMR9C-9H	
31912-MBW-E111-M1	IMR9C-9H	
31912-MBW-E112-M1	IMR9C-9H	
31912-MCW-0030	IMR9B-9H	
31912-MEE-0000	IMR9C-9H	
31912-MEE-J01	IMR8C-9HES	
31912-MEL-0030	IMR9C-9HES	
31912-MEL-A	IMR9C-9HES	
31912-MFL-0030	IMR9E-9HES	
31912-MGH-641	IMR8E-9HES	
31915-Z0H-0030	CMR5H	
31915-Z0H-0031	CMR5H	
31916-KPH-901	CPR6EA-9	
31916-KPH-9010-M1	CPR6EA-9	
31916-KRM-841	CPR8EA-9	
31916-KRM-8410-M1	CPR8EA-9	
31916-KRM-8413-M1	CPR8EA-9	
31916-KWB-601	CPR6EA-9S	
31916-MEH-0030	SIMR8A9	
31916-Z0H-003	CMR6H	
31916-ZX2-003	ZFR6K-11E	
31916-ZY3-0030	IZFR6F11	
31916-ZY3-0032	IZFR6F11	
31916-ZY3-004	IZFR6F11	
31917-KPH-901	CPR7EA-9	
31918-MEB-671	IFR8H11	
31918-MEB-6710-M1	IFR8H11	
31918-MEB-672	IFR9H11	
31919-MEB-671	IFR9H11	
31919-MEB-6710-M1	IFR9H11	
31919-MEB-672	IFR8H11	
31919-ZX2-0030	ZFR6K-11E	
3191W-Z0M-5400	BPR4ES	
3191W-Z0M-5500	BPR5ES	6
3191W-Z0M-5600	BPR6ES	2
31921-MBW-E12	IMR8C-9H	
31922-MBW-E12	IMR9C-9H	
31922-MEL-003	IMR9C-9HES	
31922-MFL-003	IMR9E-9HES	
31922-MOW-004	IMR9B-9H	
31926-KRM-841	CPR9EA-9	
31940-NX5-7520-M1	R7282-105	

HONDA	→ NGK	V-Line
31940-NX5-9410	R7282-105	
31988-GEV-761	ER8EH-N	
31988-GEV-7611-M1	ER8EH-N	
31999-KW6-6500	B9ECS	
89819-99010	BPR5ES	6
89839-99010	BPR6ES	2
94701-00408	CR9EIA-9	
98049-58716	ER8EH	
98049-59716	ER9EH	
98049-59726	ER9EH	
98049-60716	ER10EH	
98052-56471	CM-6	
98056-54718	CR4HSA	
98056-54750	C4HSB	
98056-54757	CR4HSB	
98056-54770	C4HSB	
98056-54777	CR4HSB	
98056-55713	C5HSA	
98056-55718	CR5HSA	
98056-55726	CR5HSA	
98056-55750	C5HSB	
98056-55757	CR5HSB	
98056-55770	C5HSB	
98056-55777	CR5HSB	
98056-56713	C6HSA	
98056-56713-00	C6HSA	
98056-56713-01	C6HSA	
98056-56716	CR6HS	
98056-56717	C6HA	
98056-56717-00	CR6HSA	
98056-56718	CR6HSA	
98056-5671R-00	CR6HSA	
98056-56723	C6HSA	
98056-56726	CR6HSA	
98056-57713	C7HSA	
98056-57713-00	C7HSA	
98056-57713-0A	C7HSA	
98056-57716	CR7HS	
98056-57718	CR7HSA	
98056-5771R-00	CR7HSA	
98056-57726	CR7HSA	
98056-57918	CR7HSA-9	
98056-58713	C8HSA	
98056-58716	CR8HS	
98056-58717	C8HA	
98056-58718	CR8HSA	
98059-55916	CR5EH-9	
98059-56916	CR6EH-9	
98059-57817-00	CR7E	
98059-57910	CR7EH-9	
98059-57916	CR7EH-9	
98059-57916-00	CR7E	





HONDA	→ NGK	V-Line
98059-57926	CR7EH-9	
98059-58816	CR8E	
98059-58816-H0	CR8E	
98059-58817-00	CR8E	
98059-58910	C8EH-9	
98059-58916	CR8EH-9	
98059-58916-00	CR8E	
98059-5891F	CR8EHIX-9	
98059-58920	C8EH-9	
98059-58926	CR8EH-9	
98059-5892D	IMR8C-9H	
98059-589J6	CR8EH-9S	
98059-589K6	CR8EH-9S	
98059-59816	CR9E	
98059-59816-H0	CR9E	
98059-59910	C9EH-9	
98059-59916	CR9EH-9	
98059-5991F	CR9EHIX-9	
98059-5991U	IMR9A-9H	
98059-5992U	IMR9C-9H	
98059-599U	CR9EHI-9	
98059-60916	CR10EH-9	
98061-57611	DPR7Z	
98061-57616	DPR7Z	
98061-58611	DP8Z	
98061-58616	DPR8Z	
98061-59611	DP9Z	
98061-59616	DPR9Z	
98066-54710	DR4HS	
98066-54716	DR4HS	
98066-55710	D5HS	
98066-55716	DR5HS	
98066-55740	D5HS	
98066-56710	D6HA	
98066-56716	DR6HS	
98066-56717	D6HA	
98066-56726	DR6HS	
98066-58710	D8HA	
98066-58714	D8HA	
98066-58716	DR8HS	
98066-58717	D8HA	
98066-60710	D10HS	
98069-38716	DR8ES-L	
98069-38719	DR8ES-L	
98069-55911	DPR5EA-9	
98069-55916	DPR5EA-9	
98069-56717	D6EA	
98069-56911	DP6EA-9	
98069-56916	DPR6EA-9	
98069-5691U	IJR6A9	
98069-5697Q	DCPR6E	
98069-5697Q-HE	DCPR6EIX	

HONDA	→ NGK	V-Line
98069-57716	DR7ES	
98069-57717	D7EA	
98069-57717-00	D7EA	
98069-57717-02	D7EA	
98069-57719	DR7ES	
98069-5771P	DR7EA	
98069-5771P-00	DR7EA	
98069-5771R	DR8EA	
98069-57726	DR7EA	
98069-5777P	DR7EB	
98069-57911	DP7EA-9	
98069-57912	DPR7EIX-9	
98069-57916	DPR7EA-9	
98069-57916-00	DPR7EA-9	
98069-5791U	IJR7A9	
98069-57922	DPR7EIX-9	
98069-5792U	IJR7A9	
98069-5797Q	DCPR7E	
98069-58716	DR8ES	
98069-58717	D8EA	
98069-58717-01	D8EA	
98069-58719	DR8ES	
98069-5871P	DR8EA	
98069-5871P-00	DR8EA	
98069-58726	DR8EA	
98069-58911	DP8EA-9	
98069-58912	DPR8EIX-9	
98069-58916	DPR8EA-9	
98069-58916-03	DPR8EA-9	
98069-5891F	DPR8EIX-9	
98069-58922	DPR8EIX-9	
98069-58926	DPR7EA-9	
98069-59717	D9EA	
98069-59911	DP9EA-9	
98069-59912	DPR9EIX-9	
98069-59916	DPR9EA-9	
98069-5991F	DPR9EIX-9	
98069-59926	DPR7EA-9	
98069-60717	D10EA	
98073-52710	B-2	
98073-54710	B-4	
98073-54740	BM4A	
98073-54744	BMR4A	
98073-54750	BM4A	
98073-54754	BMR4A	
98073-54771	BPM4A	
98073-54776	BPMR4A	
98073-54941	BPM4A-10	
98073-54944	BPMR4A-10	
98073-54951	BPM4A-10	
98073-56740	BM6A	
98073-56741	BPM6A	



HONDA	→ NGK	V-Line
98073-56744	BMR6A	
98073-56750	BM6A	
98073-56941	BPM6A-10	
98073-56944	BPMR6A-10	
98073-57944	BPMR7A	
98076-52711	BP2HS	
98076-52716	BPR2HS	
98076-52717	BPR2HS	
98076-52719	BP2HS	
98076-54710	B-4H	
98076-54711	BP4HS	
98076-54713	BP4HSA	
98076-54715	BPR4HSA	
98076-54716	BR4HS	
98076-54716-00	BR4HS	
98076-54717	BPR4HS	
98076-54719	BP4HS	
98076-5471G	BR4HSA	
98076-54720	BR4HS	
98076-54746	BR4HS	
98076-54747	BPR4HS	
98076-54770	B-4H	
98076-54780	B-4H	
98076-54821-CDI	BR4HS	
98076-54911	BP4HS-10	
98076-54911-CDI	BR4HS	
98076-54914	BPR4HS-10	
98076-54917	BPR4HS-10	
98076-54919	BP4HS-10	
98076-54921	BP4HS-10	
98076-54921-CDI	BR4HS	
98076-54944	BPR4HS-10	
98076-54947	BPR4HS-10	
98076-55711	BP5HS	
98076-55716	BR5HS	
98076-55717	BPR5HS	
98076-55719	BP5HS	
98076-55747	BPR5HS	
98076-56710	B6HS	
98076-56711	B6HS	
98076-56711-00	BP6HSA	
98076-56713	BP6HSA	
98076-56715	BPR6HSA	
98076-56716	BR6HS	
98076-56717	BPR6HS	3
98076-56719	BP6HS	18
98076-56719-02	BP6HS	18
98076-5671G	BR6HSA	
98076-5671G-00	BR6HSA	
98076-5671M	B6HSA	
98076-56721	BP6HS	18
98076-56725	BPR6HSA	

HONDA	→ NGK	V-Line
98076-56729	BPR6HS	3
98076-5672G	BR6HSA	
98076-56740	B6HS	
98076-56741	B6HS	
98076-56747	BPR6HS	3
98076-56756	BPR6HS	3
98076-56917	BPR6HS-10	
98076-56927	BPR6HS-10	
98076-57710	B7HS	
98076-57711	BP7HS	
98076-57716	BR7HS	
98076-57717	BPR7HS	
98076-57719	BP7HS	
98076-57719-01	BP7HS	
98076-57740	B7HS	
98076-58710	B8HS	
98076-58711	BP8HS	
98076-58713	BPR8HSA	
98076-58715	BPR8HSA	
98076-58716	BR8HS	
98076-58717	BPR8HS	
98076-58719	BP8HS	
98076-5871G	BR8HSA	
98076-5871G-00	BR8HSA	
98076-5871G-01	BR8HSA	
98076-5872G	BR8HSA	
98076-58740	B8HS	
98076-58747	BPR8HS	
98076-59710	B9HS	
98076-59716	BR9HS	
98076-59740	B9HS	
98079-52876	BPR2ES	
98079-54148	BCPR4ES-11	
98079-5414G	ZFR4F-11	
98079-54173	BUR4EB-11	
98079-54817	BPR4ES	
98079-54841	BP4ES	
98079-54846	BPR4ES	
98079-55132	BPR5EY-11	
98079-55140	BCPR5EY-11	
98079-55141	BP5EY-11	
98079-55144	BP5ES-11	
98079-55145	BPR5ES-11	
98079-55146	BPR5EY-11	
98079-55147	BCPR5ES-11	
98079-55148	BCPR5E-11	
98079-55149	BCPR5EY-11	
98079-5514A	BCPR5EY-N-11	
98079-5514B	BCPR5E-11	
98079-5514E	BKR5E-11	33
98079-5514E-H0	BKR5E-11	33
98079-5514F	BCPR5EIX-11	



HONDA	→ NGK	V-Line
98079-5514G	ZFR5F-11	
98079-5514G-01	ZFR5F-11	
98079-5514H	PFR5G-11	
98079-5514J	BKR5E-N-11	
98079-5514N	PZFR5F-11	
98079-5514N-01	PZFR5F-11	
98079-5514P	ZFR5J-11	
98079-5514P-H0	ZFR5J-11	
98079-55155	BPR5E-11	
98079-55158	BCPR5E-11	
98079-5515E	BKR5E-11	33
98079-5515G	ZFR6F-11	
98079-5515H	PFR5G-11	
98079-5515J	BKR5E-N-11	
98079-5515N	PZFR5F-11	
98079-5515U	IFR5L11	
98079-55173	BUR5EB-11	
98079-55174	BUR5EB-11	
98079-55176	BUR5EB-11	
98079-55178	BUR5EB-11	
98079-5517S	PFR5L-11	
98079-5517U	IFR5L11	
98079-5517V	IFR5G-11K	
98079-55183	BUR5EB-11	
98079-55810	B5ES	
98079-55811	BP5ES	8
98079-55816	BR5ES	
98079-55817	BPR5ES	6
98079-55840	B5ES	
98079-55841	BP5ES	8
98079-55841-03	BP5ES	8
98079-55844	BPR5EIX	
98079-55846	BPR5ES	6
98079-55847	BR5ES	
98079-55848	BR5ES	
98079-55849	BR5ES	
98079-55855	BPR5E	6
98079-5585C	BKR5E	35
98079-5585V	ZGR5A	15
98079-55876	BPR5ES	6
98079-55876-H0	BPR5ES	6
98079-5587G	ZFR5F	
98079-5587V	ZGR5A	15
98079-55941	BP5EY	
98079-55946	BPR5EY	9
98079-55A4N	PZFR5F-13	
98079-55A5N	PZFR5F-13	
98079-56115	BPR6ES-11	13
98079-5611R-00	ZFR6F-11	
98079-56132	BPR6EY-11	10
98079-56140	BKR6E-11	14
98079-56144	BP6ES-11	

HONDA	→ NGK	V-Line
98079-56145	BPR6ES-11	13
98079-56146	BPR6EY-11	10
98079-56147	BCPR6ES-11	11
98079-56148	BCPR6E-11	11
98079-56149	BCPR6EY-11	
98079-5614A	BCPR6EY-N-11	
98079-5614B	BKR6E-11	14
98079-5614E	BKR6E-11	14
98079-5614F	BCPR6EIX-11	
98079-5614G	ZFR6F-11	
98079-5614G-01	ZFR6F-11	
98079-5614H	PFR6G-11	
98079-5614J	BKR6E-N-11	
98079-5614J-01	BKR6E-N-11	
98079-5614N	PZFR6F-11	
98079-5614P	ZFR6J-11	
98079-5614P-00	ZFR6J-11	
98079-56155	BPR6ES-11	13
98079-56158	BCPR6EY-11	
98079-5615E	BKR6E-11	14
98079-5615F	BCPR6EIX-11	
98079-5615G	ZFR6F-11	
98079-5615H	PFR6G-11	
98079-5615J	BKR6E-N-11	
98079-5615N	PZFR6F-11	
98079-5615U	IFR6L11	
98079-56173	BUR6EB-11	
98079-56174	BUR6EB-11	
98079-56175	BP6EY-11	
98079-56179	BUR6EB-11	
98079-5617S	PFR6L-11	
98079-5617T	PFR6N-11	
98079-5617U	IFR6L11	
98079-5617V	IFR6G-11K	
98079-56183	BUR6EB-11	
98079-56614	B6EVX	
98079-56810	B6ES	
98079-56811	BP6ES	4
98079-56817	BR6ES	
98079-56832	BPR6EY	
98079-56840	B6ES	
98079-56841	BP6ES	4
98079-56844	BPR6EIX	
98079-56846	BPR6ES	2
98079-56847	BR6ES	
98079-56849	BR6ES	
98079-56854	BP6ES	4
98079-56855	BPR6ES	2
98079-5685C	BKR6E	28
98079-56871-H0	BP6ES	4
98079-56874	B6EVX	
98079-56876-H0	BPR6ES	2



HONDA	→ NGK	V-Line
98079-56941	BP6EY	
98079-56946	BPR6EY	
98079-5695U	IFR6C	
98079-5697U	IFR6C	
98079-569BE	BKR6E-9S	
98079-569CE	BKR6E-9S	
98079-56A7H	PFR6G-13	
98079-56A7S	PFR6L-13	
98079-57144	BP7ES-11	
98079-57145	BPR7ES-11	
98079-57146	BPR7EY-11	
98079-57147	BCPR7ES-11	
98079-57148	BCPR7E-11	
98079-57149	BCPR7EY-11	
98079-5714A	BCPR7EY-N-11	
98079-5714B	BCPR7E-11	
98079-5714E	BKR7E-11	
98079-5714F	BKR7EIX-11	
98079-5714G	ZFR7F-11	
98079-5714H	PFR7G-11	
98079-5714J	BKR7E-N-11	
98079-5714P	ZFR7J-11	
98079-57155-01	BPR7ES-11	
98079-57158	BCPR7E-11	
98079-5715E	BKR7E-11	
98079-5715F	BKR7EIX-11	
98079-5715G	ZFR7F-11	
98079-5715H	PFR7G-11	
98079-5715J	BKR7E-N-11	
98079-5715V	IFR7G-11KS	
98079-57171	BPR7EY-11	
98079-57173	BUR7EB-11	
98079-57174	BUR7EB-11	
98079-57175	BR6EB-L-11	
98079-57176	BR6ES	
98079-57177	BUR7EB-11	
98079-57178	BUR7EB-11	
98079-57179	BPR7EY-11	
98079-5717V	IFR7G-11KS	
98079-57183	BUR7EB-11	
98079-571BH	PFR7G-11S	
98079-571BV	IFR7G-11KS	
98079-571CH	PFR7G-11S	
98079-571CV	IFR7G-11KS	
98079-57614	BR7EIX	
98079-57810	B7ES	
98079-57811	BP7ES	
98079-57811-01	BP7ES	
98079-57816	BR7ES	
98079-57840	B7ES	
98079-57841	BP7ES	
98079-57846	BPR7ES	19

HONDA	→ NGK	V-Line
98079-57847	BR7ES	
98079-57848	BR7ES	
98079-57849	BR7ES	
98079-57855	BPR7ES	19
98079-5785C	BKR7E	
98079-5785G	ZFR7F	
98079-57874	BR7EIX	
98079-57876	BR7ES	
98079-57877	BR7ES	
98079-5787G	ZFR7F	
98079-5787T	PFR7N-D	
98079-57941	BP7EY	
98079-57946	BPR7EIX	
98079-5814E	BKR8E-11	
98079-5815E	BKR8E-11	
98079-5815U	FR8BI-11	
98079-5817U	FR8BI-11	
98079-58644	BR8EIX	
98079-58646	BR8EIX	
98079-58648	B8EG	
98079-58649	BR8EG	
98079-58678	B8EG	
98079-58679	BR8EG	
98079-58810	B8ES	
98079-58810-01	B8ES	
98079-58812	B9ECS	
98079-58816	BR8ES	
98079-58819	BR8ECS	
98079-58840	B8ES	
98079-58841	BP8ES	
98079-58842	B8ECS	
98079-58845	BR8ECM	
98079-58846	BR8ES	
98079-58847	BPR8ES	
98079-58857	BR8ES	
98079-58870	B8ES	
98079-58872	B8ECS	
98079-58875	BR8ECM	
98079-58876	BR8ES	
98079-5915U	FR9BI-11	
98079-5917U	FR9BI-11	
98079-59644	BR9EIX	
98079-59646	BR9EIX	
98079-59648	B9EG	
98079-59649	BR9EG	
98079-59659	BR9EG	
98079-59678	B9EG	
98079-59679	BR9EG	
98079-59810	B9ES	
98079-59811	B9ES	
98079-59812	B9ECS	
98079-59816	BR9ES	



HONDA	→ NGK	V-Line
98079-59819	BR9ECS	
98079-59840	B9ES	
98079-59842	B9ECS	
98079-59845	BR9ECM	
98079-59847	BR9ES	
98079-59855	BR9ECM	
98079-59870	B9ES	
98079-59872	B9ECS	
98079-59875	BR9ECM	
98079-59876	BR9ES	
98079-60616	BR10EIX	
98079-60646	BR10EIX	
98079-60648	B10EG	
98079-60649	BR10EG	
98079-60676	BR10EIX	
98079-60678	B10EG	
98079-60679	BR10EG	
98079-60817	BR10ES	
98079-60819	BR10ECS	
98079-60842	B10ECS	
98079-60845	BR10ECM	
98079-60872	B10ECS	
98079-60875	BR10ECM	
9807B-5515W	IZFR5K11	
9807B-5517W	IZFR5K11	
9807B-5615P	ZFR6K-11	
9807B-5615W	IZFR6K11	
9807B-5617C-00	IZFR6K-11E	
9807B-5617P	ZFR6K-11	
9807B-5617P-00	ZFR6K-11	
9807B-5617W	IZFR6K11	
9807B-561BW	IZFR6K-11S	
9807B-56A5W	IZFR6K13	
9807B-56A7W	IZFR6K13	
98179-56841	BP6ES	4
9859-5998H	IMR9A-9H	
9861-5515J	ZFR5FIX-11	
9861-5515K	BKR5EIX-11	
9861-5615J	ZFR6FIX-11	
9861-5615K	BKR6EIX-11	
9861-5615Q	BCPR6EIX-11	
9868-5615K	BKR6EIX-11	
9869-5798B	IJR7A9	
98735-4776	BPMR4A	
H9859-5998H	IMR9A-9H	
H9861-5515J	ZFR5FIX-11	
H9861-5515K	BKR5EIX-11	
H9861-5615J	ZFR6FIX-11	
H9861-5615K	BKR6EIX-11	
H9861-5615Q	BCPR6EIX-11	
H9868-5615K	BKR6EIX-11	
H9869-5798B	IJR7A9	

HYUNDAI/KIA	→ NGK	V-Line
00259-18110	BP6ES	4
09482-00538	IFR5G11	
OK01A-18110	BKR5E	35
OK01C-18110	BKR6E-11	14
OK2AA-18110	BKR6E	28
OK558-18110	PFR6N-11	
18811-08061	BPR6ES	2
18811-11051	BPR5ES-11	
18814-08061	BKR6ES	28
18814-08062	BKR6ES	28
18814-11051	BKR5ES-11	33
18814-11061	BKR6ES-11	14
18814-25000	IFR5E11	
18817-11051	PFR5N-11	
18822-08091	BP6ES-11	
18823-11091	BKR5ES-11	33
18827-09080	PLKR7A	
18829-11050	ZFR5F-11	
18840-11051	ILFR5B11	
18841-11051	LFR5A-11	
18842-08061	PLFR6A	
18843-10062	LKR6D-10E	
18854-10080	LZKR6B-10E	
18855-10060	LZKR6B-10E	
27410-23700	IFR5G11	

#### INFINITI => NISSAN

ISOLATOR	→ NGK	V-Line
6 B	BP6HS	18
7 A	B6HS	
7 B	BP6HS	18
7 D	BP6ES	4
A 5 D	BP7EFS	
A 7 D	BP6EFS	5
FM 14145 / 2	BP5ES	8
FM 14175 / 2	BP6ES	4
FM 14200 / 2	BP6ES	4
FM 14225 / 2	BP7ES	
M 14145	B5HS	
M 14175	B6HS	
M 14175 / 2	B6ES	
M 14225	B7HS	
M 14240	B8HS	
M 14260	B9HS	
M 1495	B-4H	
M 18225	AB-7	
M 18240	AB-7	
PM 14225	BP7HS	
U 7 D	BCP6ES	17
U 8 D	BCP5ES	16





<b>ISOLATOR</b>	<b>→ NGK</b>	<b>V-Line</b>
ZM 14-260	B8HS	
<b>ISUZU</b>	<b>→ NGK</b>	<b>V-Line</b>
5-8138-0001-0	BPR5ES	6
5-8138-0003-0	BPR5EIX	
5-8138-0004-0	BPR6EIX	
5-8138-0005-0	BP5ES	8
5-8138-0006-0	BP6ES	4
5-8138-0007-0	BP5EY	
5-8138-0008-0	BP6EY	
5-8138-0012-0	BP5EY	
5-8138-0013-0	BP6EY	
5-8600-3122-0	ZFR5F-11	
5-8600-3124-0	ZFR6F-11	
5-8600-7635-0	BKR5E-11	33
5-8600-7636-0	ZFR5J-11	
5-8600-7639-0	ZFR6J-11	
5-8600-7642-0	ZFR7J-11	
5-8601-3957-0	PZFR5F-13	
5-8610-3379-0	BPR4ES-11	
5-8610-3380-0	BPR5ES-11	
5-8610-3381-0	BPR6ES-11	13
5-8610-3382-0	BPR7ES-11	
5-8610-3385-0	PFR5B-11	
5-8610-3386-0	PFR6B-11	
5-8610-3387-0	PFR7B-11	
5-8610-3389-0	PGR5A-11	
5-8610-3390-0	PGR6A-11	
5-8610-3391-0	PGR7A-11	
5-8612-1749-0	BKR5ES-11	33
5-8612-1750-0	BKR6ES-11	14
5-8612-3951-0	BKR5E-11	33
5-8612-3952-0	BKR6E-11	14
5-8612-3953-0	BKR7E-11	
8-9412-0560-0	BPR5ES-11	
8-9412-0561-0	BPR5EY-11	
8-9412-0562-0	BPR6EY-11	10
8-9416-0627-0	BPR6EY	
8-9421-7232-0	BPR6ES-11	13
8-9421-9943-0	BPR6ES	2
8-9423-5966-0	BP5ES-11	
8-9423-7203-0	BP5EY-11	
8-9424-1059-0	BP6ES-11	
8-9425-2270-0	BP6EY-11	
8-9432-8372-0	BKR6E-11	14
8-9432-8373-0	BKR7E-11	
8-9432-8374-0	BKR6E-11	14
8-9432-8375-0	BKR7E-11	
8-9701-2928-0	BKR6E	28
8-9701-2930-0	BKR6E	28
8-9701-2931-0	BKR7E	

<b>ISUZU</b>	<b>→ NGK</b>	<b>V-Line</b>
8-9711-1376-0	PFR5B-11	
8-9717-0268-0	BKR5EIX-11	
9-8251-3103-0	BP6ES	4
9-8251-3105-0	B6ES	
9-8251-3106-0	BP5ES	8
9-8251-3107-0	B5ES	
9-8251-3113-0	B7ES	
<b>IVECO</b>	<b>→ NGK</b>	<b>V-Line</b>
88 032 415	IFR7F-6D	
88 033 433	IGR7E-3D	
504 082 651	IFR7F-6D	
<b>JAGUAR</b>	<b>→ NGK</b>	<b>V-Line</b>
7R83-12405-AA	TR6AP-13E	
8W-12405-AAA	ILKAR7C10	
8W93-12405-ABB	ILKAR7C10	
AJ 84575	IFR5N10	
AJ 812146	ILKAR7C10	
C2A 1535	IFR5N10	
C2P 23089	ILKAR7C10	
C2S 46895	TR6AP-13E	
EAC 8554	BR7EFS	
EBC 004021	BR7EF	
EBC 4021	BR7EF	
LR 019 484	ILKAR7C10	
NCA 3850 DA / 2	BKR6EIX-11	
NCA 3850 FA / 2	BKR6EVXA-13	
NCA 3850 HA / 2	PFR6G-13E	
<b>KIA =&gt; HYUNDAI/KIA</b>		
<b>LAMBORGHINI =&gt; VW Group</b>		
<b>LANCIA =&gt; FIAT Group</b>		
<b>LAND ROVER</b>	<b>→ NGK</b>	<b>V-Line</b>
4550 157	IFR5N10	
LR 005 483	ILFR6B	
LR 019 484	ILKAR7C10	
LR 025605	ILTR6G8G	
LR 032 080	ILKAR7C10	
<b>LEXUS =&gt; TOYOTA</b>		
<b>LOTUS</b>	<b>→ NGK</b>	<b>V-Line</b>
A 100 E 6277 S	BKR6E	28
A 910 E 7009 F	BPR6EKN	





MARELLI	→ NGK	V-Line
061 830 176 304	BP6HS	18
061 830 210 304	BP6ES	4
061 830 211 304	BPR6ES	2
061 830 215 304	BP6EFS	5
061 830 254 304	BKR6E	28
061 830 257 304	BPR6HS	3
061 830 258 304	BP5HS	
061 830 262 304	BPR6EFS	7
061 850 023 304	PTR5A-13	25
062 000 611 304	B6HS	
062 000 654 304	BP6HS	18
062 000 739 304	BP6ES	4
062 000 740 304	BPR6ES	2
062 000 754 304	BP6HS	18
7 LCR	BKR6E	28
7 LPR	BKR6E	28
8 LCR	BCPR7ES	
8 LDCR	PTR5A-13	25
8 LPR	BCPR7ES	
AW 5 C	BM6A	
AW 56 C	BM7A	
CM 1 N	AB-2	
CM 2 N	AB-2	
CM 3 N	AB-6	
CM 4 N	AB-6	
CM 5 N	AB-6	
CM 6 N	AB-7	
CU 7 N	C7HSA	
CW 2 C	B-2	
CW 2 CJ	B-2	
CW 2 L	B4ES	
CW 2 N	B-4H	
CW 3 C	B-4	
CW 3 CJ	B-4	
CW 3 CP	BP-4	
CW 3 L	B4ES	
CW 3 N	B-4H	
CW 4 A	B5ES	
CW 4 C	B-4	
CW 4 CJ	B-4	
CW 4 CP	BP-4	
CW 4 L	B4ES	
CW 4 LP	BP4ES	
CW 4 N	B-4H	
CW 4 NJ	B-4H	
CW 5 C	B-4	
CW 5 CP	BP5S	
CW 5 L	B5ES	
CW 5 LJ	B5ES	
CW 5 LP	BP5ES	8
CW 5 LS	B5ES	
CW 5 LSZ	B5ES	

MARELLI	→ NGK	V-Line
CW 5 N	B5HS	
CW 5 NJ	B5HS	
CW 5 NP	BP5HS	
CW 5 NR	BR5HS	
CW 5 NS	B5HS	
CW 5 NSZ	B5HS	
CW 6 C	B6S	
CW 6 CE	BM6A	
CW 6 CJ	B6S	
CW 6 L	B5ES	
CW 6 LJ	B5ES	
CW 6 LP	BP5ES	8
CW 6 LR	BR5ES	
CW 6 LS	B5ES	
CW 6 LSZ	B5ES	
CW 6 N	B6HS	
CW 6 NE	BM6A	
CW 6 NJ	B6HS	
CW 6 NP	BP6HS	18
CW 6 NPR	BPR6HS	3
CW 6 NR	BR6HS	
CW 7 C	B6S	
CW 7 L	B6ES	
CW 7 LCR	BKR6E	28
CW 7 LJ	B6ES	
CW 7 LP	BP6ES	4
CW 7 LPH	BP6ES	4
CW 7 LPR	BPR6ES	2
CW 7 LR	BR6ES	
CW 7 N	B6HS	
CW 7 NJ	B6HS	
CW 7 NP	BP6HS	18
CW 7 NPR	BPR6HS	3
CW 7 NR	BR6HS	
CW 8 CJ	B7S	
CW 8 L	B7ES	
CW 8 LCR	BCPR7ES	
CW 8 LJ	B7ES	
CW 8 LP	BP7ES	
CW 8 LPR	BPR7ES	19
CW 8 LPS	BP7ES	
CW 8 N	B7HS	
CW 8 NP	BP7HS	
CW 8 NR	BR7HS	
CW 9 L	B8ES	
CW 9 LJ	B8ES	
CW 9 LP	BP8ES	
CW 9 N	B8HS	
CW 10 L	B8EG	
CW 11 L	B9EG	
CW 12 L	B9EG	
CW 12 NV	BUH	



MARELLI	→ NGK	V-Line
CW 13 L	B10EG	
CW 14 L	B10EG	
CW 25 N	B-4H	
CW 55 N	B5HS	
CW 67 L	B6ES	
CW 67 LP	BP6ES	4
CW 67 N	BP6HS	18
CW 67 NJ	B6HS	
CW 67 NR	BR6HS	
CW 67 P	BP5ES	8
CW 75 LP	BP6ES	4
CW 78 L	B6ES	
CW 78 LP	BP6ES	4
CW 78 LPR	BPR6ES	2
CW 78 LPS	BP6ES	4
CW 89 LP	BP7ES	
CW 101 L	B85EGV	
CW 112 L	B9EG	
CW 225 A	B6HS	
CW 250 A	B7HS	
CW 260 N	B7HS	
CWC 6 NJ	B6HS	
CWC 7 NJ	B6HS	
CWC 9 NJ	B7HS	
CWC 12 NJ	B8HS	
CWC 67 NJ	B6HS	
CWF 11 L	BR8EIX	
CWP 5 N	BR6HIX	
CWP 6 N	BR6HIX	
CWP 7 L	B6EVX	
CWP 7 N	BR6HIX	
CWP 8 L	BR7EIX	
CWP 8 N	BR7HIX	
CWP 9 L	BR8EIX	
CWP 9 N	BR8HIX	
CWP 10 L	BR9EIX	
CWP 10 N	BR9HIX	
CWP 11 L	B10EGV	
CX 6 N	D6HA	
CX 8 L	D8EA	
CX 8 N	D8HA	
DW 4 CJR	BR6S	
F 6 NC	BP5HS	
F 6 NCR	BPR5HS	
F 7 LC	BP6ES	4
F 7 LCR	BPR6ES	2
F 7 NC	BP6HS	18
F 7 NCR	BPR6HS	3
F 8 LC	BP7ES	
F 8 LCR	BPR7ES	19
FC 6 N	B5HS	
FC 7 N	B6HS	

MARELLI	→ NGK	V-Line
FC 9 L	BP8ES	
SW 5 C	BM6F	
T 7 LC	BP6EFS	5
T 7 LCR	BPR6EFS	7
T 8 LC	BP7EFS	
TM 2 NP	AP5FS	
TM 4 NP	AP6FS	
TW 4 LP	BP5EFS	
TW 5 NP	BP5FS	
TW 6 NP	BP6FS	
TW 7 LP	BP6EFS	5
TW 7 LPR	BPR6EFS	7
TW 7 NP	BP6FS	
TW 78 LP	BP6EFS	5
TW 78 LPR	BPR6EFS	7
TW 78 NPR	BPR6FS	
<b>MASERATI =&gt; FIAT Group</b>		
<b>MAYBACH =&gt; MERCEDES</b>		
MAZDA	→ NGK	V-Line
0000-18-1690	BPR6ES	2
0000-18-3648	BR7ET	
0000-18-3649	BR8ET	
0000-18-8914	BPR5ES	6
0000-18-B601	BPR5ES-11	
0000-18-BP01	BKR5E-11	33
0000-18-BP03	BKR6E-11	14
0000-18-BP47	BKR5E	35
0000-18-F201	ZFR6A-11	
0000-18-F203	ZFR5A-11	
0000-18-F285	ZFR6F-11	
0000-18-F287	ZFR5F-11	
0000-18-JE41	BKR5EIX-11	
0000-18-KJ11	PZFR6F	
0000-18-KJ13	PZFR5F	
0000-18-L3Y1	ILTR6A-13G	
0000-18-L3Y2	ILTR5A-13G	
0000-18-L3Y3	ILTR6A-8G	
0000-18-N201	BR8EQ-14	
0000-18-N203	BR9EQ-14	
0000-18-N328	BUR8EQ	
0000-18-N329	BUR6EQ	
0000-18-N342	BUR9EQ	
0000-18-N343	BUR7EQ	
0000-18-N3A1	BUR9EQP	
0000-18-N3A2	BUR7EQP	
0000-18-N3A3	BUR8EQP	
0000-18-N3A4	BUR6EQP	
0000-18-N3Y1	RE9B-T	
0000-18-N3Y2L	RE7C-L	



MAZDA	→ NGK	V-Line
0000-18-N3Y8	RE7C-L	
0190-18-110	B6HS	
0222-18-110	BP6EY	
0243-18-110	C6HA	
0259-18-110	BP6ES	4
0370-18-110	BPR6EIX	
0371-18-110	BPR5EIX	
0376-18-110	BPR7EIX	
0418-18-110A	B7ES	
0419-18-110	B7ES	
0420-18-110	B8ES	
0512-18-110	B6ES	
0660-18-110	BP5ES	8
0745-18-110	BP7ES	
0801-18-600	BR6EM	
0802-18-600	BR7EM	
0803-18-600	BR8EM	
0865-18-600	B6EM	
0866-18-600	B7EM	
0867-18-600	BR8EM	
0868-18-600	B9EM	
1001-77-550	BP4EY	
1002-77-550	BP5EY	
1003-77-550	BP6EY	
1409-18-110	BP5ES-13	
1410-18-110	BP5ES-13	
1482-18-600A	BR8EQ	
1483-18-600	BR8EQ	
1534-18-110	BP5EY	
1690-18-110	BPR6ES	2
1A01-18-110	PGR5A	
1A02-18-110	KR7AI	
1A03-18-110	IKR7A	
1A04-18-110	DCPR6E	
1A06-18-110	DCPR8E	
1A08-18-110	ZGR5A	15
1A10-18-110	GR5AI-10	
1A50-18-110	BKR6E	28
1A53-18-110	BKR6E-11	14
1A61-18-110	DCPR7EIX	
1N00-18-110	BKR4E-11	
1N04-18-110	BKR5EY-11	
1N06-18-110	BKR6EY-11	
1N07-18-110	PFR4G-11	
1N08-18-110	PFR5G-11	
1N09-18-110	PFR6G-11	
1N11-18-110	FR7AI-D	
1N15-18-110	LFR5A-11	
1N17-18-110	LFR6A-11	
1N19-18-110	LZKAR6AP-11	
1N21-18-110	LFR4AP-11	
1N22-18-110	LFR5AP-11	

MAZDA	→ NGK	V-Line
1UD0-18-110	BPR5EIX-11	
1UD1-18-110	BPR6EIX-11	
1UD2-18-110	BPR7EIX	
1UD3-18-110	BKR5EIX-11	
1UD4-18-110	BKR6EIX-11	
1UD6-18-110	BCPR5EIX-11	
1UD7-18-110	BCPR6EIX-11	
1UD9-18-110	DCPR7EIX	
1UN0-18-110	BPR5EIX	
1UN1-18-110	BPR6EIX	
1UN2-18-110	BPR7EIX	
1UN3-18-110	BPR5EIX-11	
1UN4-18-110	BPR6EIX-11	
1UN6-18-110	BKR5EIX	
1UN7-18-110	BKR6EIX	
1UN9-18-110	BKR5EIX-11	
1UNA-18-110	BKR6EIX-11	
1UNC-18-110	BCPR5EIX-11	
1UND-18-110	BCPR6EIX-11	
1UNF-18-110	DCPR7EIX	
1UNG-18-110	ZFR5FIX-11	
1UNH-18-110	ZFR6FIX-11	
1UXJ-18-110	BPR5EFIX-13P	
1Y00-18-110	BPR5ES	6
1Y01-18-110	BPR6ES	2
1Y03-18-110	BPR5ES-11	
1Y06-18-110	BKR5E	35
1Y07-18-110	BKR6E	28
1Y09-18-110	BKR5E-11	33
1Y0A-18-110	BKR6E-11	14
1Y0B-18-110	BKR7E-11	
1Y0F-18-110	DCPR7E	
1Y0G-18-110	ZFR5F-11	
1Y0H-18-110	ZFR6F-11	
1Y0K-18-110	BPR5ES-13	
1Y0L-18-110	BRE527Y-11	
2182-18-600	BR7EM	
2183-18-600	BR8EM	
2328-18-600	B7EM	
2359-18-600	BR8EM	
242-18-110	C6HSA	
3648-18-600	BR7ET	
3649-18-600	BR8ET	
3710-18-110	BP6ES-13	
3743-18-600	BR7ET	
3744-18-600	BR8ET	
3953-18-110	BPR5EY	9
3954-18-110	BPR6EY	
4075-18-110	BP4ES	
4095-18-110	BP4EY	
4096-18-110A	BPR4ES-13	
418-18-110	B7ES	





MAZDA	→ NGK	V-Line
4882-18-110	BP-2E	
4884-18-110	BPR2ES	
4885-18-110	BPR2ES	
4894-18-110	BP-2E	
6M8G-12-405BB	ILTR5A-13G	
8042-18-110	BPR6EIX-11	
8182-18-600	BR7EQ	
8248-18-600	BR8ET	
8344-18-600	BR9ET	
8526-18-600	B6EM	
8865-18-600	B6EM	
8914-18-110	BPR5ES	6
A501-18-110	BP6E	4
A502-18-110	BP6ES	4
AY02-18-110	DCP7E	
AY01-18-110	DCP7E	
AZ08-18-110	BPR5E	6
AZ09-18-110	BPR5E	6
AZ28-18-110	DCPR7EIX	
AZ29-18-110	DCPR7EIX	
B601-18-110	BPR5ES-11	
B602-18-110	BPR5EY-11	
B64N-18-110	BRE527Y-11	
B64P-18-110	BRE527Y-11	
B660-18-110	BKR6E-11	14
B667-18-110	BKR6E-11	14
B672-18-110	BPR5ES	6
B695-18-110	BCPR6E	12
B696-18-110	BCPR6E	12
B6B3-18-110	BCPR5E-11	
B6B4-18-110	BCPR5E-11	
BBYV-18-110	R7436-10	
BBYV-18-11Z	R7436-9	
BP01-18-110	BKR5E-11	33
BP02-18-110	BKR5E-11	33
BP03-18-110	BKR6E-11	14
BP04-18-110	BKR6E-11	14
BP05-18-110	BKR7E-11	
BP06-18-110	BKR7E-11	
BP07-18-110	BKR6ES-11	14
BP09-18-110	BKR6ES-11	14
BP47-18-110	BKR5E	35
BP47-18-110P00	BKR5E	35
BP48-18-110	BKR5E	35
BP49-18-110	BKR6E	28
BP50-18-110	BKR6E	28
BP51-18-110	BKR7E	
BPY1-18-110	BKR5E-11	33
BPY3-18-110	BKR6E-11	14
E356-18-110	BE527Y-11	
E357-18-110	BE527Y-11	
F201-18-110	ZFR6A-11	

MAZDA	→ NGK	V-Line
F202-18-110A	ZFR6A-11	
F203-18-110	ZFR5A-11	
F204-18-110	ZFR5A-11	
F205-18-110	ZFR7F-11	
F210-18-110	BCPR5E	32
F211-18-110	BCPR5E	32
F220-18-110	BCPR6E-11	11
F221-18-110	BCPR6EY-11	
F261-18-110	ZFR6F-11	
F285-18-110	ZFR6F-11	
F286-18-110	ZFR6J-11	
F287-18-110	ZFR5F-11	
F288-18-110	ZFR5J-11	
F289-18-110	ZFR7F-11	
F293-18-110	ZFR5F-11	
F2C5-18-110	ZFR6F-11	
F2C7-18-110	ZFR6F-11	
F806-18-110	BPR4ES-13	
F8B1-18-110	ZFR6A-11	
F8B2-18-110A	ZFR6A-11	
F8B3-18-110	ZFR5F-11	
F8B5-18-110	ZFR7F-11	
F8B7-18-110	ZFR4F-11	
F8L6-18-110	ZFR4F-11	
F8L7-18-110	ZFR4F-11	
F8L8-18-110	BPR4ES-13	
F8L9-18-110	BPR4ES-13	
FE3N-18-110	BCPR7E-11	
FE6E-18-110	BCPR7E-11	
FE6F-18-110	BCPR7E-11	
FE79-18-110	BPR6ES-11	13
FE82-18-110	BPR6EY-11	10
FEDK-18-110	BPR5ES-13	
FEDM-18-110	BPR5ES-13	
FEEG-18-110	BPR6ES-13	
FEEH-18-110	BPR6EIX-11	
FEFB-18-110	BPR6ES-11	13
JE03-18-110	BCPR7E	
JE26-18-110	BCPR5EIX-11	
JE27-18-110	BCPR6EIX-11	
JE28-18-110	BCPR5EIX-11	
JE41-18-110	BKR5EIX-11	
JE42-18-110	BKR5EIX-11	
JE43-18-110	BKR6EIX-11	
JE44-18-110	BKR6EIX-11	
JE45-18-110	BKR7EIX-11	
JE46-18-110	BKR7EIX-11	
JF03-18-110	BCPR5E-11	
JF04-18-110	BCPR5E-11	
KJ11-18-110	PZFR6F	
KJ12-18-110	PZFR6F	
KJ13-18-110	PZFR5F	



MAZDA	→ NGK	V-Line
KJ14-18-110	PZFR5F	
L303-18-110	TR5AI-13	
L341-18-110	ITR6F13	
L3BD-18-110	SILTR6A7G	
L3G2-18-110	ILTR6A-13G	
L3K9-18-110	ILTR6A-8G	
L3K9-18-110A	ILTR6A-8G	
L3Y1-18-110	ILTR6A-13G	
L3Y2-18-110	ILTR5A-13G	
L3Y3-18-110	ILTR6A-8G	
L3Y4-18-110	ITR6F13	
L3YD-18-110	SILTR6A7G	
L813-18-110	ITR6F13	
L814-18-110	BPR6EF-13	
LFG1-18-110	ILTR5A-13G	
LFY1-18-110	TR5B-13	
LFY3-18-110	BPR5EFS-13	
N201-18-600	BR8EQ-14	
N202-18-600	BR8EQ-14	
N203-18-600	BR9EQ-14	
N212-18-600	BR7EQ-14	
N212-18-600A	BR7EQ-14	
N218-18-600	BR8EQ-14	
N225-18-600A	BUR9EQ	
N236-18-600	BUR9EQ	
N238-18-600	BUR8EQ	
N245-18-600	SD10A	
N246-18-600	BR9EQ-14	
N253-18-600	BR9EQ-14	
N322-18-110	BR10ET	
N328-18-110	BUR8EQ	
N329-18-110	BUR6EQ	
N331-18-110	SD10A	
N333-18-110	SD11A	
N335-18-110	SD9A	
N338-18-110	SD11A	
N339-18-110	SD10A	
N340-18-110	BUR9EQ	
N341-18-110	BUR7EQ	
N342-18-110	BUR9EQ	
N343-18-110	BUR7EQ	
N390-18-110	BUR5EQ	
N3A1-18-110	BUR9EQP	
N3A2-18-110	BUR7EQP	
N3A3-18-110	BUR8EQP	
N3A4-18-110	BUR6EQP	
N3H1-18-110C	RE9B-T	
N3H1-18-110D	RE9B-T	
N3H2-18-110C	RE7C-L	
N3H5-18-110	RE7C-L	
N3H5-18-110A	RE7C-L	
N3H8-18-110A	RE9B-T	

MAZDA	→ NGK	V-Line
N3H8-18-110B	RE9B-T	
N3H9-18-110A	RE8C-L	
N3J1-18-110	RE8C-L	
N3J1-18-110A	RE8C-L	
N3M1-18-1BXA	RE7C-L	
N3M1-18-1BXB	RE7C-L	
N3Y1-18-110	RE9B-T	
N3Y1-18-110A	RE9B-T	
N3Y1-18-110A9U	RE9B-T	
N3Y1-18-S30	RE7C-L	
N3Y1-18-S30	RE9B-T	
N3Y1-18-S30L	RE7C-L	
N3Y1-18-S30T	RE9B-T	
N3Y2-18-110	RE7C-L	
N3Y2-18-110L	RE7C-L	
N3Y2-18-S30	RE8C-L	
N3Y2-18-S30	RE9B-T	
N3Y2-18-S30L	RE8C-L	
N3Y2-18-S30T	RE9B-T	
N3Y3-18-S30	RE7C-L	
N3Y3-18-S30	RE9B-T	
N3Y4-18-110	RE9B-T	
N3Y4-18-110A	RE9B-T	
N3Y4-18-S30	RE8C-L	
N3Y4-18-S30	RE9B-T	
N3Y5-18-110	RE8C-L	
N3Y5-18-110L	RE8C-L	
N3Y6-18-110	RE7C-L	
N3Y6-18-110L	RE7C-L	
N3Y8-18-110	RE7C-L	
N3Y8-18-110A	RE7C-L	
N3Y8-18-110A9U	RE7C-L	
N3Z1-18-110	RE8C-L	
N3Z1-18-110A	RE8C-L	
N3Z2-18-110	RE7C-L	
N3Z2-18-110A	RE7C-L	
N3Z4-18-110	RE7C-L	
N3Z5-18-110	RE8C-L	
N3ZZ2-18-110A	RE7C-L	
PBP01-18-110AA	BKR5E-11	33
TF50-18-110	BKR6EIX	
ZJY6-18-110	IFR5E13	
ZR03-18-110	R6725-115	
ZZS1-18-110	DCPR7E	
ZZS2-18-110	DCPR7E	
ZZS4-18-110	BPR5EY	9
ZZSI-18-110	DCPR7E	
MERCEDES	→ NGK	V-Line
A 002 159 18 03	BP7ES	
A 002 159 22 03	BP5ES	8



MERCEDES	→ NGK	V-Line
A 002 159 24 03	BP6ES	4
A 002 159 27 03	BP7ES	
A 002 159 28 03	BP6ES	4
A 002 159 29 03	BP5ES	8
A 002 159 31 03	BP5ES	8
A 002 159 41 03	BP6ES	4
A 002 159 42 03	BP6ES	4
A 002 159 48 03	BP5ES	8
A 002 159 49 03	BP6EFS	5
A 002 159 56 03	BP6EFS	5
A 002 159 57 03	BP5EFS	
A 002 159 58 03	BP5EFS	
A 002 159 64 03	BP7EFS	
A 002 159 65 03	BP7EFS	
A 002 159 68 03	BP6EFS	5
A 002 159 69 03	BP6EFS	5
A 002 159 76 03	BP5EFS	
A 002 159 77 03	BCP5ES	16
A 003 159 04 03	BP5EFS	
A 003 159 05 03	BP5EFS	
A 003 159 06 03	BP6EFS	5
A 003 159 07 03	BP6EFS	5
A 003 159 08 03	BP7EFS	
A 003 159 10 03	BP5ESZ	
A 003 159 11 03	BP5ESZ	
A 003 159 12 03	BP6ESZ	
A 003 159 13 03	BP6ESZ	
A 003 159 14 03	BP7ES	
A 003 159 16 03	BCP6ES	17
A 003 159 30 03	BCP5ES	16
A 003 159 31 03	BCP6ES	17
A 003 159 33 03	BP7EFS	
A 003 159 34 03	BP6EFS	5
A 003 159 35 03	BP6EFS	5
A 003 159 36 03	BP5EFS	
A 003 159 37 03	BCP5ES	16
A 003 159 40 03	BP5EFS	
A 003 159 41 03	BP5EFS	
A 003 159 42 03	BCP5ES	16
A 003 159 45 03	BP6ESZ	
A 003 159 46 03	BP5ESZ	
A 003 159 47 03	BP5ESZ	
A 003 159 56 03	BP7ES	
A 003 159 57 03	BP6ESZ	
A 003 159 75 03	BKUR5ET	29
A 003 159 76 03	BKUR5ET	29
A 003 159 78 03	BKR6ES	28
A 003 159 81 03	PFR5R-11	
A 003 159 90 03	BKUR5ET	29
A 003 159 91 03	BKR5EKUP	
A 003 159 92 03	BKR6EKE	
A 003 159 94 03	PFR5R-11	

MERCEDES	→ NGK	V-Line
A 003 159 96 03	IFR5D10	
A 003 159 96 03 26	IFR5D10	
A 003 159 97 03	IFR6D10	
A 003 159 97 03 26	IFR6D10	
A 004 159 13 03	ILFR6A	
A 004 159 14 03	IFR6Q-G	
A 004 159 15 03	LKR8A	
A 004 159 19 03	PFR5R-11	
A 004 159 25 03	SILZKR7A-S	
A 004 159 25 63	SILZKR7A-S	
A 004 159 30 03	BKR6EZB	
A 004 159 34 03	PLKR6A	
A 004 159 36 03	BKR6EZB	
A 004 159 39 03	ILZKAR7A10	
A 004 159 44 03	PLKR7B8E	
A 004 159 45 03	ILFR6A	
A 004 159 49 03	PLKR7A	
A 004 159 50 03	PFR5R-11	
A 004 159 58 03	PLKR7B8E	
A 122 159 00 03	ILZFR6C-K	
A 132 159 00 03	LKR7B-9	
A 376 159 72 03	T7204A	
MN 195 922	ILZFR6C-11K	
Q0 003 085 V005 00 000	BKR6EKE	
Q0 012 468 V001 00 0000	LKR8A	
Q0 012 468 V002 00 0000	LKR8A	

MERCURY	→ NGK	V-Line
121 27	BP6HS-10	
123 43	BP8HS-10	
123 43 B	BP8HS-10	
136 86 B2	BU8H	
136 86 Q	BU8H	
141 035 50	BUZHW	
141 035 68	BUZ8H	
141 03 Q	BUZHW-2	
148 145 68	BPZ8HS-15	
148 14 Q	BPZ8HS-10	
177 195 47	BPR7HS-10	
194 24	BP8HS-15	
197 96	BPR6HS-10	
338 432 20	IZFR6J	
338 432 20 Q	IZFR6J	
338 892 46 Q39	ILFR6G-E	
338 895 97 Q	IZFR5G	
338 896 80	ILFR6G	
338 896 80 001	ILFR6G	
412 63 B	B7HS-10	
412 63 M	B7HS-10	
595 71 B	BR6FS	
803 507	DCPR6E	
803 990	TR5IX	



MERCURY	→ NGK	V-Line
803 991	BR6FVX	
809 679	BR9ES	
809 679 B	BR9ES	
809 680	BR8ES	
809 680 B	BR8ES	
810 883	BPR6ES	2
813 413	B7S	
813 414 1	BP7HS	
813 415	B8S	
813 421 4	R5673-8	
813 423	BPR6HS	3
813 469	B6S	
813 471 1	BR6ES	
816 336 Q	BPR6EFS	7
816 737 B2	BP8H-N-10	
816 737 Q	BP8H-N-10	
816 837 B2	BPZ8H-N-10	
816 837 Q	BPZ8H-N-10	
821 916	BR7HS	
823 70 M1	B6HS	
823 71 B	B7HS	
823 71 M	B7HS	
823 72 M	B8HS	
824 406 8	BR8HS-10	
824 406 8 B	BR8HS-10	
827 858 Q	DPR6EA-9	
827 859	CR6HS	
828 938	BR7ES	
828 942	BR7HS-10	
828 943	BPR8ES	
828 945	BR8HS	
828 987	B8ES	
843 220 Q	IZFR6J	
843 825	BR9ECS	
846 75 M	B5HS	
852 868 140	DR5HS	
855 717 1	ZFR5F-11	
859 495 Q	LFR5A-11	
881 284 Q	LFR6A-11	
885 185	BPR8EIX	
889 246 Q39	ILFR6G	
889 423	PZFR6H	
889 597 Q	IZFR5G	
892 567 Q	IZFR5J	
896 322	B6HS-10	
898 829 001	LFR4A-E	
8M 000 6613	ILFR6G-E	
8M 000 7910	IZFR7M	
8M 000 7919	IZFR7M	
8M 000 9927	IZFR7M	
971 80 B	BUHW	
971 80 Q	BUHW	

MERCURY	→ NGK	V-Line
971 82 B	BUHW-2	
971 82 Q	BUHW-2	
971 84	BP7HS-10	
971 86	B9HS-10	
971 86 B	B9HS-10	
973 89	BPR6FS	
<b>MG =&gt; ROVER</b>		
<b>MINI =&gt; BMW</b>		
MITSUBISHI	→ NGK	V-Line
1822 A002	IFR6B-K	
1822 A005	ILZFR6C-K	
1822 A011	ILKR7B8	
1822 A021	ILKR8E6	
1822 A022	ILFR7H	
1822 A030	FR5EI	
1822 A068	DIFR5C11	
1822 A069	DIFR6C11	
1822 A079	DILKR8B6	
1822 A085	DILFR5A11	
1822 A086	LZFR5BI-11	
801 001	B-4	
801 033	B7HS	
MD 313 442	PFR5G-11	
MD 313 443	PFR6G-11	
MD 314 766	BKR7EKC-N	
MD 319 517	PFR6G	
MD 320 543	BKR7EKC-N-11	
MD 320 572	BKR5E	35
MD 321 150	BKR6EKC-N-11	
MD 322 771	PFR6B-11	
MD 331 057	ZFR5F-11	
MD 336 367	IZFR6B	
MD 338 492	BPR4ES	
MD 338 991	PGR7A	
MD 342 386	PZFR5F-11	
MD 343 277	PGR6A	
MD 348 296	PZFR5B	
MD 351 467	PZFR5C	
MD 355 067	BKR6EKUC	
MD 357 531	PFR6J	
MD 358 200	ZFR6F-11	
MD 358 201	ZFR6F-11	
MD 358 202	ZFR6F-11	
MD 360 019	IZFR6B	
MD 361 067	IFR5E11	
MD 362 097	ZFR5F-11	
MD 362 098	ZFR5F-11	
MD 362 902	BKR5EKUC	
MD 365 108	BPR5EKU	



<b>mitsubishi</b>	<b>→ NGK</b>	<b>V-Line</b>
MD 366 819	IZFR5C	
MD 371 434	IGR7A	
MD 371 435	IGR7A	
MD 372 421	BKR5EKUD	
MD 372 422	BKR6EKUD	
MD 372 553	IFR5E11	
MD 372 588	IFR6E11	
MD 373 645	IFR6E11	
MD 374 841	IGR7A-G	
MD 375 642	BKR5ETUA	
MD 378 582	IFR6B	
MN 119 256	ILZFR5B	
MN 119 487	IFR6S	
MN 119 500	IGR6A11	
MN 128 362	LFR6C-11	
MN 158 596	LZFR6AI	
MN 163 235	FR5EI	
MN 163 236	FR6EI	
MN 163 807	FR6EI	
MN 176 628	ILZFR6C-11K	
MN 1822 A002	IFR6B-K	
MN 195 922	ILZFR6C-11K	
MS 851 022	BP5ES	8
MS 851 023	BP6ES	4
MS 851 024	BP7ES	
MS 851 027	BP5ES-11	
MS 851 028	BP6ES-11	
MS 851 029	BP7ES-11	
MS 851 097	BP5EY	
MS 851 101	BP4EY	
MS 851 102	BP5EY	
MS 851 104	BP6EY	
MS 851 106	BP4EY-11	
MS 851 107	BP5EY-11	
MS 851 108	BP6EY-11	
MS 851 111	B-4	
MS 851 113	B6S	
MS 851 121	BP-4	
MS 851 126	BPR6E	2
MS 851 132	B5HS	
MS 851 133	B6HS	
MS 851 134	B7HS	
MS 851 162	B5ES	
MS 851 163	B6ES	
MS 851 164	B7ES	
MS 851 165	B8ES	
MS 851 174	BR7ES	
MS 851 181	BP4ES	
MS 851 182	BP5ES	8
MS 851 182 A	BP5ES	8
MS 851 183	BP6ES	4
MS 851 184	BP7ES	

<b>mitsubishi</b>	<b>→ NGK</b>	<b>V-Line</b>
MS 851 187	BP5ES-11	
MS 851 188	BP6ES-11	
MS 851 189	BP7ES-11	
MS 851 192	BP6ES	4
MS 851 207	BP5ES-11	
MS 851 208	BP6ES-11	
MS 851 212	BP5ES	8
MS 851 213	BP6ES	4
MS 851 215	BP7ES	
MS 851 217	BPR5ES	6
MS 851 218	BPR6ES	2
MS 851 219	BPR7ES	19
MS 851 227	BPR5ES-11	
MS 851 228	BPR6ES-11	13
MS 851 229	BPR7ES-11	
MS 851 230	BPR4ES-11	
MS 851 232	BPR5ES	6
MS 851 233	BPR6ES	2
MS 851 234	BPR7ES	19
MS 851 235	BPR5ES	6
MS 851 236	BPR6ES	2
MS 851 237	BPR5ES-11	
MS 851 238	BPR6ES-11	13
MS 851 239	BPR7ES-11	
MS 851 242	BP4EY	
MS 851 243	BP5EY	
MS 851 244	BP6EY	
MS 851 246	BP4EY-11	
MS 851 247	BP5EY-11	
MS 851 248	BP6EY-11	
MS 851 253	BUR6EA-11	
MS 851 254	BUR7EA-11	
MS 851 263	G-2Z	
MS 851 272	BUR5EA-11	
MS 851 273	BUR6EA-11	
MS 851 274	BUR7EA-11	
MS 851 283	BP6E	4
MS 851 286	BP5EY	
MS 851 287	BP6EY	
MS 851 292	PGR6A-11	
MS 851 301	PGR5A-11	
MS 851 302	PGR6A-11	
MS 851 316	DCPR6E	
MS 851 317	DCPR7E	
MS 851 327	DCPR7EIX	
MS 851 332	PFR6B-11	
MS 851 335	PFR5J-11	
MS 851 336	PFR6J-11	
MS 851 346	PFR6M	
MS 851 347	PFR7M	
MS 851 351	BK5E	
MS 851 352	BK6E	





MITSUBISHI	→ NGK	V-Line
MS 851 353	BK6E	
MS 851 354	BK5E	
MS 851 357	BKR5E-11	33
MS 851 358	BKR6E-11	14
MS 851 359	BKR7E-11	
MS 851 361	BK5E-11	
MS 851 362	BK6E-11	
MS 851 363	BK7E-11	
MS 851 364	BK5E-11	
MS 851 365	BK6E-11	
MS 851 366	BK7E-11	
MS 851 367	BKR5E	35
MS 851 368	BKR6E	28
MS 851 382	BKR6E	28
MS 851 387	BKR5E-11	33
MS 851 388	BKR6E-11	14
MS 851 396	DCPR6E	
MS 851 397	DCPR7E	
MS 851 402	BPR5E	6
MS 851 403	BPR6ES-11	13
MS 851 408	BPR6ES-11	13
MS 851 412	BPR5ES	6
MS 851 413	BPR6ES	2
MS 851 414	BPR7ES	19
MS 851 417	BPR5ES-11	
MS 851 418	BPR6ES-11	13
MS 851 419	BPR7ES-11	
MS 851 428	BUR6EA-11	
MS 851 429	BUR7EA-11	
MS 851 437	BP5EY	
MS 851 438	BP6ES	4
MS 851 439	BP7ES	
MS 851 447	BUR6EA-11	
MS 851 448	BUR5EA-11	
MS 851 454	BR7ES	
MS 851 463	PGR6A-11	
MS 851 473	PFR6B-11	
MS 851 478	BPR6ES-11	13
MS 851 486	DCPR6E	
MS 851 487	DCPR7E	
MS 851 497	DCPR7EIX	
MS 851 501	PFR5J-11	
MS 851 502	PFR6J-11	
MS 851 506	PFR6J	
MS 851 721	BK5E	
MS 851 722	BK6E	
MS 851 727	BKR5E-11	33
MS 851 728	BKR6E-11	14
MS 851 729	BKR7E-11	
MS 851 732	BK6E-11	
MS 851 737	BKR5E	35
MS 851 738	BKR6E	28

MITSUBISHI	→ NGK	V-Line
MS 851 783	BK7EK-N-11	
MS 851 861	PFR6J	
MS 851 872	BK7EK-N-11	
MS 851 881	BPR6EKN	
MS 851 882	BPR7EKN	
MZ 602 020	BKR5EIX-11	
MZ 602 021	BKR6EIX-11	
MZ 602 026	BCPR5EIX-11	
MZ 602 027	BCPR6EIX-11	
MZ 602 032	BPR5EIX-11	
MZ 602 033	BPR6EIX-11	
MZ 602 034	BPR7EIX	
MZ 602 035	BR8EIX	
MZ 602 036	BR9EIX	
MZ 602 037	DCPR7EIX	
MZ 602 060	BPR5EIX-11	
MZ 602 061	BPR6EIX-11	
MZ 602 062	BPR7EIX	
MZ 602 063	BCPR5EIX-11	
MZ 602 064	BCPR6EIX-11	
MZ 602 065	BKR5EIX-11	
MZ 602 066	BKR6EIX-11	
MZ 602 067	DCPR7EIX	
MZ 602 068	ZFR5FIX-11	
MZ 602 069	ZFR6FIX-11	
MZ 602 070	BPR5EIX	
MZ 602 071	BPR6EIX	
MZ 602 072	BKR5EIX	
MZ 602 073	BKR6EIX	
MZ 602 074	LPG2	
MZ 602 075	LPG1	
MZ 602 081	BKR7EIX-11	
S MD 313 443	PFR6G-11	
S MN 158 596	LZFR6AI	
SS MS 851 364	BK5E-11	
Z2 152 944	BPR6ES-11	13
Z2 152 945	BPR6ES	2
Z2 152 946	BR7ES	
Z2 152 947	BPR7ES	19
Z2 152 948	BPR7ES-11	
Z2 152 949	BCPR7ES-11	
Z2 152 950	BCPR6ES-11	11
MOTORCRAFT	→ NGK	V-Line
1 Y 00	BPR5ES	6
1 Y 01	BPR6ES	2
1 Y 03	BPR5ES-11	
1 Y 06	BKR5E	35
1 Y 07	BKR6E	28
1 Y 09	BKR5E-11	33
1 Y 0 A	BKR6E-11	14
1 Y 0 B	BKR7E-11	



MOTORCRAFT	→ NGK	V-Line
1 Y 0 F	DCPR7E	
1 Y 0 G	ZFR5F-11	
1 Y 0 H	ZFR6F-11	
1 Y 0 K	BPR5ES-13	
1 Y 0 L	BRE527Y-11	
A 1	B8S	
A 11	B-2	
A 11 NX	BM4A	
A 11 U	B-2	
A 11 X	B-2	
A 1 CU	B8S	
A 1 X	B8S	
A 2	B7S	
A 21 X	B8S	
A 22	BP6S	
A 22 CU	BP6S	
A 22 NX	BPM7A	
A 2 NX	BM7A	
A 2 X	B7S	
A 3	B6S	
A 32	BP6S	
A 3 CU	B6S	
A 3 NX	BM6A	
A 3 X	B6S	
A 4	B6S	
A 42	BP5S	
A 42 CU	BP5S	
A 5	B6S	
A 52	BP5S	
A 52 CU	BP5S	
A 5 CU	B6S	
A 5 X	B6S	
A 7	B-4	
A 7 LM	B4-LM	
A 7 N	BM6A	
A 7 NU	BM6A	
A 7 NX	BM6A	
A 7 U	B-4	
A 7 X	B-4	
A 82	BP-4	
A 9	B-4	
A 901	B8S	
A 9 X	B-4	
AE 1 C	B7HS	
AE 1 X	B7HS	
AE 2	B7HS	
AE 22	BP6HS	18
AE 22 C	BP6HS	18
AE 2 C	B7HS	
AE 2 X	B7HS	
AE 3	B6HS	
AE 32	BP6HS	18

MOTORCRAFT	→ NGK	V-Line
AE 32 C	BP6HS	18
AE 3 C	B6HS	
AE 3 X	B6HS	
AE 4	B5HS	
AE 42	BP5HS	
AE 4 X	B5HS	
AE 52	BP5HS	
AE 6	B5HS	
AE 62	BP5HS	
AE 7	B-4H	
AE 8	B-4H	
AE 901	B9HS	
AE 901 X	B9HS-10	
AE 92	BP-4H	
AER 32	BPR6HS	3
AER 4	BR5HS	
AER 4 X	BR5HS	
AF 12	BP7FS	
AF 2	B7FS	
AF 22	BP6FS	
AF 3	BR6FS	
AF 32	BP6FS	
AF 3 NX	BM7F	
AF 42	BP5FS	
AF 52	BP4FS	
AF 5 NX	BM6F	
AG 1	B8ES	
AG 12	BP7ES	
AG 12 C	BP7ES	
AG 12 CU	BP7ES	
AG 1 C	B8ES	
AG 1 X	B8ES	
AG 2	B7ES	
AG 203	B11EGP	
AG 22	BP6ES	4
AG 224	BP6ES-11	
AG 22 C	BP6ES	4
AG 22 CU	BP6ES	4
AG 23	B7ECS	
AG 252	BP6ES	4
AG 252 C	BP6ES	4
AG 25 C	B7EM	
AG 2 C	B7ES	
AG 2 CU	B7ES	
AG 2 X	B7ES	
AG 3	B6ES	
AG 32 A	BP6ES	4
AG 32 C	BP6ES	4
AG 32 CU	BP6ES	4
AG 34 CU	BP6EY	
AG 34 CU 11	BP6EY-11	
AG 3 C	B6ES	



MOTORCRAFT	→ NGK	V-Line
AG 3 X	B6ES	
AG 4	B5ES	
AG 403	B10EGP	
AG 403 C	B10EGP	
AG 42	BP5ES	8
AG 42 CU	BP5ES	8
AG 44	ZGR5C	
AG 44 CU	BP5EY	
AG 5	B5ES	
AG 501	B10ES	
AG 501 X	B10EGV	
AG 52	BP5ES	8
AG 54	ZGR5C	
AG 54 CU	BP4EY	
AG 5 CU	B5ES	
AG 603	BR9EIX	
AG 603 C	BR9EIX	
AG 7	B5ES	
AG 701	B9ES	
AG 701 C	B9ES	
AG 701 CU	B9ES	
AG 701 X	B9EGV	
AG 82	BP4ES	
AG 9	B4ES	
AG 901	B9ES	
AG 901 C	B9ES	
AG 901 CU	B9ES	
AG 901 X	B8EGV	
AG 902	BP8ES	
AG 903	B8EG	
AG 9 U	B4ES	
AGF 12	BP7EFS	
AGF 12 C	BP7EFS	
AGF 22 C	BP6EFS	5
AGF 32 CU	BP6EFS	5
AGFS 22 C 1	BPR6EFS	7
AGFS 22 FE 1	PTR6F-13	
AGFS 22 FE 13 J	PTR6D-13G	
AGFS 22 IPJ	ITR6F13	
AGFS 22 YPC	ITR6F13	
AGFS 32 C 1	BPR6EFS	7
AGKO	BUE	
AGN 42	BP5ES	8
AGP 12 C	BCP7ES	
AGP 22 C	BCP6ES	17
AGP 701 C	R7436-10	
AGPR 12 C	BCPR7ES	
AGPR 12 P	BKR7EIX-11	
AGPR 12 PP	PFR7B-11	
AGPR 12 PP 11	PFR7B-11	
AGPR 12 PP 8	PFR7B	
AGPR 22 C	BKR6ES	28

MOTORCRAFT	→ NGK	V-Line
AGPR 22 C 1	BKR6ES-11	14
AGPR 22 CD	BKR6ES	28
AGPR 22 CD 1	BKR6ES-11	14
AGPR 22 P	BKR6EIX-11	
AGPR 22 PP	PFR6B-11	
AGPR 22 PPJ	PFR6B-11	
AGPR 32 C	BKR6ES	28
AGPR 32 CD 1	BKR6ES-11	14
AGPR 32 PD	BKR5EKUP	
AGPR 902 C	BCPR9ES-11	
AGPR 902 P	R7436-9	
AGPS 12 C	BCPR7ES	
AGPS 12 P 1	BKR7EIX-11	
AGPS 22 C	BKR6ES	28
AGPS 22 C 1	BKR6ES-11	14
AGPS 22 P	BKR6EIX-11	
AGPS 22 P 1	BKR6EIX-11	
AGPS 22 PP 1	PFR6B-11	
AGPS 32 C	BKR6ES	28
AGPS 32 C 1	BKR6ES-11	14
AGPS 44 F	PZFR5D-11	34
AGPS 44 F 11	PZFR5D-11	34
AGPS 44 F 11 J	PZFR5D-11	34
AGR 12 C	BPR7ES	19
AGR 16 C	BR8ET	
AGR 1 X	BR8ES	
AGR 21	BR6ES	
AGR 22	BPR6ES	2
AGR 22 C	BPR6ES	2
AGR 22 CU	BPR6ES	2
AGR 2 C	BR7ES	
AGR 31	BR6ES	
AGR 32	BPR6ES	2
AGR 32 C	BPR6ES	2
AGR 32 CU	BPR6ES	2
AGR 34 CU	BPR6EY	
AGR 3 X	BR6ES	
AGR 41	BR5ES	
AGR 42	BPR5ES	6
AGR 42 C	BPR5ES	6
AGR 42 CU	BPR5ES	6
AGR 44 CU	BPR5EY	9
AGR 44 CU 11	BPR5EY-11	
AGR 47 CU 11	ZGR5B-11	
AGR 51	BR5ES	
AGR 52	BPR5ES	6
AGR 54 CU	BPR5EY	9
AGR 701 X	BR9EIX	
AGR 82	BPR4ES	
AGR 901 X	BR8EIX	
AGRF 22	BPR6EFS	7
AGRF 226	BPR6EFS-13	



<b>MOTORCRAFT</b>	<b>→ NGK</b>	<b>V-Line</b>
AGRF 22 C	BPR6EFS	7
AGRF 22 C 1	BPR6EFS	7
AGRF 22 PP 1	PTR5D-10	31
AGRF 32	BPR6EFS	7
AGRF 326	BPR6EFS-13	
AGRF 32 C 1	BPR6EFS	7
AGRF 42	BPR5EFS	
AGRF 52	BPR5EFS	
AGRP 52	ZFR4F-11	
AGS 22 C	BPR6ES	2
AGS 32 C	BPR5ES	6
AGS 32 C 11	BPR5ES-11	
AGS 42 CC	BPR4ES	
AGSF 22 FM 1	TR5IX	
AGSF 22 FSCM	PTR6D-13G	
AGSF 22 PGM	PTR6F-13	
AGSF 22 PM	PTR6F-13	
AGSF 22 PP	PTR6F-13	
AGSF 22 PPJ	PTR6F-13	
AGSF 22 PPM	PTR6F-13	
AGSF 22 WM	BPR5EFS	
AGSF 22 YPC	ITR6F13	
AGSF 24 C	TR5-1	
AGSF 24 N	TR55-1	
AGSF 32 C	BPR5EFS	
AGSF 32 FEC	PTR5F-11	
AGSF 32 FEM	PTR5D-10	31
AGSF 32 FM	PTR5D-13	
AGSF 32 W	TR55IX	
AGSF 32 WM	ITR6F13	
AGSF 32 YPC	TR5AI-13	
AGSF 34 C	TR5-1	
AGSP 32	BKR6ES-11	14
AGSP 32 C	BKR6ES-11	14
AGSP 32 FP	PFR5G-11	
AGSP 32 PR	PFR6B-11	
AGSP 33 C	ZFR6F-11	
AGSP 52	BKR5ES	35
AL 11	B-4L	
AL 5	B-6L	
AL 5 X	B-6L	
AL 7	B-6L	
AL 7 U	B-6L	
AL 7 X	B-6L	
AL 9	B-4L	
AL 9 X	B-4L	
AR 21 X	BR6S	
AR 31	BR6S	
AR 32	BP6S	
AR 41	BR6S	
AR 42	BP5S	
AR 51	BR6S	

<b>MOTORCRAFT</b>	<b>→ NGK</b>	<b>V-Line</b>
AR 52	BP5S	
AR 7 N	BMR6A	
AR 82	BP-4	
ARF 2	BR6FS	
ARF 22	BPR6FS	
ARF 22 C	BPR6FS	
ARF 22 CU	BPR6FS	
ARF 26	BR6FS	
ARF 3	BR6FS	
ARF 32	BPR6FS	
ARF 326	BPR6FS	
ARF 32 C 6	BPR6FS	
ARF 32 M	BPR6FS	
ARF 36	BR6FS	
ARF 4	BR5FS	
ARF 41 CU 15	BR5FS	
ARF 42	BPR5FS	
ARF 426	BPR5FS-15	
ARF 42 CU	BPR5FS	
ARF 46	BR5FS	
ARF 52	BPR4FS	
ARF 526	BPR4FS-15	
ARF 6	BR5FS	
ARF 62	BPR4FS	
ARF 626	BPR4FS-15	
ARF 8	BR5FS	
ARF 86	BR5FS	
ASF 32	BPR6FS	
ASF 32 C	BPR6FS	
ASF 32 M	BPR6FS	
ASF 32 P	UR5IX	
ASF 42	BPR5FS-11	
ASF 426 C	BPR5FS-15	
ASF 42 C	BPR5FS-11	
ASF 42 P	UR4IX	
ASF 44 P	UR4IX	
ASF 52	BPR4FS	
ASF 526	BPR4FS-15	
AT 1	B8S	
AT 10	B-2	
AT 2	B7S	
AT 3	B6S	
AT 4	B6S	
AT 42	BP5S	
AT 42 M	BP5S	
AT 4 A	B6S	
AT 6	B6S	
AT 8	B-4	
ATL 3	B-6L	
ATL 4	B-6L	
ATL 8	B-4L	
AV 1 X	B8HS	



MOTORCRAFT	→ NGK	V-Line
AV 22 CU	BP6HS	18
AV 2 CU	B7HS	
AV 2 X	B7HS	
AV 3 CU	B6HS	
AV 4	B5HS	
AV 42	BP5HS	
AV 52	BP5HS	
AV 6	B-4H	
AV 6 CU	B-4H	
AV 701 CU 10	B9HS-10	
AV 82	BP-4H	
AV 901 CU	B9HS	
AV 901 X 4	B9HS-10	
AVKO	BUH	
AVKOD	BUHW	
AVZKO	BUHX	
AWRF 32	BPR6EFS	7
AWRF 325	BPR6EFS-13	
AWRF 42	BPR5EFS	
AWSF 22 C	BPR6EFS	7
AWSF 22 E	TR6IX	
AWSF 22 F	PTR6D-13	
AWSF 22 FM	TR5IX	
AWSF 22 FM 1	TR5IX	
AWSF 22 FS	PTR6D-13G	
AWSF 24 C	TR5-1	
AWSF 32	BPR6EFS	7
AWSF 32 C	BPR6EFS	7
AWSF 32 E	TR55IX	
AWSF 32 EE	TR55IX	
AWSF 32 F	PTR5D-10	31
AWSF 32 FM	TR5IX	
AWSF 32 P	TR5IX	
AWSF 32 PM	TR5IX	
AWSF 32 PP	TR5IX	
AWSF 34	TR5-1	
AWSF 34 C	TR5-1	
AWSF 34 PP	TR5-1IX	
AWSF 42	BPR5EFS	
AWSF 42 C	BPR5EFS	
AWSF 42 EE	TR55IX	
AWSF 42 PP	TR55IX	
AWSF 44 C	TR5-1	
AWSF 52 C	BPR5EFS	
AWSF 54	TR5-1	
AWSF 54 C	TR5-1	
AWSFA 32 C	BPR5EFS	
AYFS 22 C	PTR5A-13	25
AYFS 22 FE 1 J	PLTR6A-10G	
AYFS 22 FPM 1	PTR5A-13	25
AYFS 22 PP	PTR5A-13	25
AYFS 22 PP 1	PTR5A-13	25

MOTORCRAFT	→ NGK	V-Line
AYFS 32 CJ	TR5B-13	
AYRF 22 P	PTR5A-13	25
AYRF 22 PP	PTR5A-13	25
AYSF 32 YPC	ILTR5A-13G	
AZ 2	B7S	
AZ 3	B6S	
AZ 9	B-4	
AZ 901	B8S	
AZFS 22 C	PTR5A-13	25
AZFS 22 PP	PTR5A-13	25
AZFS 32 FE	PTR5A-13	25
B 2	AB-8	
B 2 W	AB-8	
B 3 W	AB-7	
B 3 X	AB-7	
B 4	AB-7	
B 4 X	AB-7	
B 6	AB-6	
B 6 W	AB-6	
B 8	AB-6	
B 8 X	AB-6	
B 9	AB-6	
BF 1	A7FS	
BF 12	AP8FS	
BF 22	AP6FS	
BF 22 C	AP6FS	
BF 22 CU	AP6FS	
BF 22 CX	AP6FS	
BF 22 X	AP6FS	
BF 3	A6FS	
BF 32	AP6FS	
BF 32 CU	AP6FS	
BF 32 CX	AP6FS	
BF 32 X	AP6FS	
BF 42	AP5FS	
BF 42 CU	AP5FS	
BF 601	A9FS	
BF 82	AP5FS	
BF 901	A8FS	
BF 92	AP5FS	
BFS 22 C	APR6FS	
BFS 32 C	APR6FS	
BFS 32 C 1	APR6FS	
BR 8	AB-6	
BRF 22	APR6FS	
BRF 22 C	APR6FS	
BRF 31	AR6FS	
BRF 314	AR6FS	
BRF 32	APR6FS	
BRF 3 M	AR6FS	
BRF 42	APR5FS	
BRF 82	APR5FS	





<b>MOTORCRAFT</b>	<b>→ NGK</b>	<b>V-Line</b>
BSF 31	AR6FS	
BSF 314	AR6FS	
BSF 82	APR5FS	
BSF 92	APR5FS	
BT 10	AB-6	
BT 15	AB-2	
BT 2	AB-8	
BT 3	AB-7	
BT 4	AB-7	
BT 6	AB-6	
BT 8	AB-6	
BT 9	AB-6	
BTF 1	A7FS	
BTF 3	A6FS	
BTF 31	A6FS	
BTF 42	AP5FS	
BTF 6	A6FS	
BTRF 42	APR5FS	
BZ 8	AB-6	
HE 1	D10HS	
HE 2	D8HA	
HE 3	D6HA	
HG 2	D8EA	
HG 22	D8EA	
HG 2 CU	D8EA	
HGR 2 C	DR8ES-L	
HV 2	D8HA	
HV 22	D6HA	
HV 3	D6HA	
PE 3	C6HSA	
PV 2	C7HSA	
PV 3	C6HSA	
TT 4	G-2Z	
TT 8	G-2Z	

**NHSP LD => TORCH**

<b>NISSAN</b>	<b>→ NGK</b>	<b>V-Line</b>
22401-01B14	BPR5ES-11	
22401-01M14	BP4ES-L-11	
22401-01P14	BCPR4ES-11	
22401-01P15	BCPR5ES-11	
22401-01P16	BCPR6ES-11	11
22401-01P17	BCPR7ES-11	
22401-01P75	BCPR5ES-11	
22401-01P76	BCPR6ES-11	11
22401-01P90	BCPR5ES-11	
22401-01P91	BCPR6ES-11	11
22401-02P15	BCPR5E-11	
22401-02P16	BCPR6E-11	11
22401-02P17	BCPR7E-11	
22401-03300	B-4	

<b>NISSAN</b>	<b>→ NGK</b>	<b>V-Line</b>
22401-08U15	PFR5K-11	
22401-08U75	PFR5K-11	
22401-0P615	PFR5F-11A	
22401-0P616	PFR6F-11A	
22401-0P675	PFR5F-11A	
22401-0P676	PFR6F-11A	
22401-10F14	BCPR4ES-11	
22401-10F15	BCP5ES	16
22401-10F16	BCP6ES	17
22401-10F17	BCP7ES	
22401-10P15	BCPR5E-11	
22401-10P16	BKR6E-11	14
22401-10P17	BCPR7E-11	
22401-11200	BC6ES	
22401-12E14	BCPR4ES-11	
22401-12E15	BCPR5ES	32
22401-12E16	BCPR6ES	12
22401-12E17	BCPR7ES	
22401-12E76	BCPR6ES	12
22401-18V15	PGR5A	
22401-18V16	PGR6A	
22401-18V17	PGR7A	
22401-19V15	BCP5ES	16
22401-19V16	BCP6ES	17
22401-19V17	BCP7ES	
22401-19V65	BCPR5ES	32
22401-19V66	BCPR6ES	12
22401-1A50A	ILFR5B11	
22401-1F720	BKR5E-11	33
22401-1HC1B	LZKAR6AP-11	
22401-1KC1C	DILKAR7C9H	
22401-1KC7C	DILKAR7C9H	
22401-1KT1B	DILZKAR6A11	
22401-1KT7B	DILZKAR6A11	
22401-1N506	BKR6E-N	
22401-1N516	BKR6E-N	
22401-1N567	PFR7G-11	
22401-1P114	PFR4G-11	
22401-1P115	PFR5G-11	
22401-1P116	PFR6G-11	
22401-1P117	PFR7G-11	
22401-1P175	PFR5G-11	
22401-1P175-Q0	PFR5G-11	
22401-1P175-VA	PFR5G-11	
22401-1P176	PFR6G-11	
22401-1P176-VA	PFR6G-11	
22401-1P176-WS	PFR6G-11	
22401-1W615	FR5AP-10	
22401-1W675	FR5AP-10	
22401-20J04	BKR4E	
22401-20J05	BKR5E	35
22401-20J05-Q0	BKR5E	35



NISSAN	→ NGK	V-Line
22401-20J05-SN	BKR5E	35
22401-20J05-VA	BKR5E	35
22401-20J05-W0	BKR5E	35
22401-20J06	BKR6E	28
22401-20J07	BKR7E	
22401-20J16	BKR6E	28
22401-21B15	BPR5E	6
22401-21B16	BPR6E	2
22401-21B17	BPR7E	19
22401-27N15	PFR5B-11	
22401-27N15-VA	PFR5B-11	
22401-27N15-VB	PFR5B-11	
22401-27N16	PFR6B-11	
22401-27N64	PFR4B-11	
22401-27N65	PFR5B-11	
22401-27N66	PFR6B-11	
22401-27N67	PFR7B-11	
22401-27T15	PGR5A-11	
22401-27T65	PGR5A-11	
22401-27T66	PGR6A-11	
22401-2J200	BKR5EY-11	
22401-2J200-Q0	BKR5EY-11	
22401-2J200-VA	BKR5EY-11	
22401-2J206	BKR6EY-11	
22401-2J206-VA	BKR6EY-11	
22401-30R14	ZFR4E-11	
22401-30R15	ZFR5E-11	
22401-30R16	ZFR6E-11	
22401-30R75	ZFR5E-11	
22401-30R75-W1	ZFR5E-11	
22401-37P15	PFR5B-11C	
22401-37P16	PFR6B-11C	
22401-37P76	PFR6B-11C	
22401-40F15	ZFR5D-11	
22401-40P15	PFR5B-11B	
22401-40P65	PFR5B-11B	
22401-40P66	PFR6B-11B	
22401-40V05	BCP5E	16
22401-40V06	BCP6E	17
22401-40V07	BCPR7E	
22401-50Y04	BKR4E-11	
22401-50Y05	BKR5E-11	33
22401-50Y05-Q0	BKR5E-11	33
22401-50Y05-VA	BKR5E-11	33
22401-50Y05-W0	BKR5E-11	33
22401-50Y06	BKR6E-11	14
22401-50Y07	BKR7E-11	
22401-50Y75	BKR5E-11	33
22401-50Y75-W0	BKR5E-11	33
22401-53J04	BKR4EY	
22401-53J05	BKR5EY	
22401-53J05-VA	BKR5EY	

NISSAN	→ NGK	V-Line
22401-53J06	BKR6EY	
22401-53J06-RB	BKR6EY	
22401-53J06-VA	BKR6EY	
22401-53J07	BKR7EY	
22401-53J15	PFR5B-9	
22401-53J65	PFR5B-9	
22401-53J66	PFR6B-9	
22401-53J67	PFR7B-9	
22401-53V15	PFR5B-9	
22401-53V16	PFR6B	
22401-53V17	PFR7B	
22401-54C68	PFR8B-9	
22401-55V17	PFR7B-D	
22401-58S15	PFR5A-11	
22401-58S16	PFR6A-11	
22401-58S17	PFR7A-11	
22401-59S16	PFR6A-11	
22401-5M015	PLFR5A-11	
22401-5M016	PLFR6A-11	
22401-5M075	PLFR5A-11	
22401-5M075-Q0	PLFR5A-11	
22401-5M075-SN	PLFR5A-11	
22401-5M075-VA	PLFR5A-11	
22401-5M075-W0	PLFR5A-11	
22401-60V06	BCPR6ES-11	11
22401-6N215	LZFR5AQP	
22401-85E15	BKR5ES-11	33
22401-85E16	BKR6ES-11	14
22401-85E17	BKR7ES-11	
22401-85E75	BKR5ES-11	33
22401-85E76	BKR6ES-11	14
22401-88G75	BKR5EY	
22401-88G75-WS	BKR5EY	
22401-88G76	BKR6EY	
22401-88G76-WS	BKR6EY	
22401-8H314	LFR4AP-11	
22401-8H315	LFR5AP-11	
22401-8H375	LFR5AP-11	
22401-8H375-VA	LFR5AP-11	
22401-8H515	LFR5A-11	
22401-8H516	LFR6A-11	
22401-8H575	LFR5A-11	
22401-8H575-Q0	LFR5A-11	
22401-8H616	PLFR6A-9	
22401-8H676	PLFR6A-9	
22401-97E15	PFR5C-11	
22401-97E65	PFR5C-11	
22401-98E06	BKR6ES-11	14
22401-9E075	FR5AP-10	
22401-AG215	PFR5P-11	
22401-AG275	PFR5P-11	
22401-AG315	BKR5EQUPA	



NISSAN	→ NGK	V-Line
22401-AJ415	FR5AP-11	
22401-AL615	LFR5AQP	
22401-AL875	LFR5BP-11	
22401-AR015	LFR5AQP	
22401-AR716	LFR6A	
22401-BC01B	LFR5E-11	
22401-CK81	PLZKAR6A-11	
22401-CK81B	PLZKAR6A-11	
22401-CK87B	PLZKAR6A-11	
22401-CK87B-VA	PLZKAR6A-11	
22401-EA015	PLZKAR6A-11	
22401-ED815	LZKAR6AP-11	
22401-ED875	LZKAR6AP-11	
22401-ED875-Q0	LZKAR6AP-11	
22401-ED875-SN	LZKAR6AP-11	
22401-ED875-VA	LZKAR6AP-11	
22401-EW61B	DILKAR6A11	
22401-EW61C	DF7H-11B	
22401-EW67B	DILKAR6A11	
22401-F6516	PFR6A-11A	
22401-FU412	FR2A-D	
22401-FU42A	FR2B-D	
22401-HC000	BPR5ES-13	
22401-HC001	BPR6ES-13	
22401-JA01B	DILKAR6A11	
22401-JA07B	DILZKAR6A11	
22401-JK01D	DF8H-11B	
22401-L1600	BP-2E	
22401-M7714	B4ES	
22401-M7715	B5ES	
22401-M7716	B6ES	
22401-M7717	B7ES	
22401-M7915	BR5ES	
22401-M7916	BR6ES	
22401-M7917	BR7ES	
22401-N8714	BP4ES-11	
22401-N8715	BP5ES-11	
22401-N8716	BP6ES-11	
22401-N8717	BP7ES-11	
22401-N8785	BP5ES-11	
22401-N8786	BP6ES-11	
22401-N8789	BP6ES-11	
22401-N8790	BP5ES-11	
22401-N8791	BP6ES-11	
22401-P8314	BPR4ES-11	
22401-P8315	BPR5ES-11	
22401-P8316	BPR6ES-11	13
22401-P8317	BPR7ES-11	
22401-P8385-PC	BPR5ES-11	
22401-P8386-PC	BPR6ES-11	13
22401-P8389	BPR4ES-11	
22401-P8390	BPR5ES-11	

NISSAN	→ NGK	V-Line
22401-P8391	BPR6ES-11	13
22401-P8614	BR4ES	
22401-P8616	BR6ES-11	
22401-P8617	BR7ES	
22401-P8816	B6ES-11	
22401-P8817	B7ES-11	
22401-S6015	BP5ES-13	
22401-S6016	BP6ES-13	
22401-V0515	BP5ES	8
22401-V0516	BP6ES	4
22401-V1414	BPR4ES	
22401-V1414-WL	BPR4ES	
22401-V1415	BPR5ES	6
22401-V1416	BPR6ES	2
22401-V1417	BPR7ES	19
22401-V1484-PC	BPR4ES	
22401-V1485-PC	BPR5ES	6
22401-V1486-PC	BPR6ES	2
22401-V1490	BPR5ES	6
22401-V1491	BPR6ES	2
22401-V5014	BCPR4ES-11	
22401-V5015	BCP5ES-11	
22401-V5016	BCP6ES-11	
22401-V5017	BKR7E-11	
22401-V5085	BCP5ES-11	
22401-V5086	BCP6ES-11	
22401-VB000	BPR5E-11	
22401-VB006	BPR6E-11	
22401-VR306	IGR6B-10D	
22401-W8914	BP4ES	
22401-W8914-WL	BP4ES	
22401-W8915	BP5ES	8
22401-W8915-SA	BP5ES	8
22401-W8916	BP6ES	4
22401-W8917	BP7ES	
22401-W8985	BP5ES	8
22401-W8985-PC	BP5ES	8
22401-W8986	BP6ES	4
22401-W8986-PC	BP6ES	4
22401-W8990	BP5ES	8
22401-W8991	BP6ES	4
22401-W9815	BPR5ES	6
22401-W9816	BPR6ES	2
22401-W9817	BPR7ES	19
22401-WA016	PFR6G-9	
22401-WA066	PFR6G-9	
22401-WA067	PFR7G-9	
22401-WD517	FR7AI-D	
22401-Y9015	BCPR5ET	
22401-Y9016	BCPR6ET	
22401-Y9017	BCPR7ET	
22401-Y9065	BCPR5ET	



NISSAN	→ NGK	V-Line
22401-Y9066	BCP6ET	
22401-Y9067	BCP7ET	
22401-Y9215	BPR5ES	6
22401-Y9264	BP4ES	
22401-Y9265	BP5ES	8
22401-Y9266	BP6ES	4
22401-ZE01B	DILFR5A11	
B2401-4A00A	IKR6G11	
B2401-89900	BPR5EIX	
B2401-89904	BP5EY	
B2401-89905	BP6EY	
B2401-89906	BCPR5EIX-11	
B2401-89907	BCPR6EIX-11	
B2401-89908	BPR5EY	9
B2401-89909	BPR6EY	
B2401-M7715	B5ES	
B2401-M7915	BR5ES	
B2401-V1415	BPR5ES	6
B2401-V1416	BPR6ES	2
B2401-W8914	BP4ES	
B2401-W8915	BP5ES	8
B2401-W8916	BP6ES	4
B2401-W8917	BP7ES	
BY480-BKR5E	BKR5EIX	
BY480-BKR6E	BKR6EIX	
BY480-BPR5E	BPR5EIX	
BY480-BPR6E	BPR6EIX	
BY480-BPR7E	BPR7EIX	
BY480-BPR8E	BPR8EIX	
BY480-BPR9E	BPR9EIX	
BY480-DCPR7	DCPR7EIX	
BY481-BCPR5	BCPR5EIX-11	
BY481-BCPR6	BCPR6EIX-11	
BY481-BKR5E	BKR5EIX-11	
BY481-BKR6E	BKR6EIX-11	
BY481-BKR7E	BKR7EIX-11	
BY481-BPR5E	BPR5EIX-11	
BY481-BPR6E	BPR6EIX-11	
BY481-LFR5A	LFR5AIX-11	
BY481-LFR6A	LFR6AIX-11	
BY481-ZFR5F	ZFR5FIX-11	
BY481-ZFR6F	ZFR6FIX-11	
BY482-BKR6E	LPG1	
BY482-BPR6E	LPG2	
BY483-HB6AI	HB6AIX-11P	
BY483-HB6BI	HB6BIX-11P	
OPEL	→ NGK	V-Line
12 14 000	BKR5EK	23
12 14 011	BKR5EQUPA	
12 14 013	LTR6B-10T	
12 14 014	PZTR5A-15	

OPEL	→ NGK	V-Line
12 14 016	ZFR6V-G	
12 14 030	PFR6T-10G	
12 14 031	ZFR5F-11	
12 14 046	PFR6T-G	
12 14 060	PFR6D10G	
12 14 065	DILFR7B10G	
12 14 066	IFR7X7G	
12 14 149	BKR5EK	23
12 14 527	PLFR6C-10G	
12 14 528	ZFR6BP-G	
44 13 288	PFR6G-9	
47 08 892	IKR6G11	
48 11 581	ILTR5D	
09 195 109	BKR5EK	23
09 195 868	BKR5EQUPA	
09 199 038	LTR6B-10T	
12 563 707	PZTR5A-15	
12 620 540	ILTR5D	
12 787 099	PFR6T-10G	
12 788 884	PLFR6C-10G	
25 324 618	LTR6B-10T	
55 182 623	FR5CP	
55 562 534	PFR6T-G	
55 564 215	BKR7ESC-11	
55 564 748	DILFR7B10G	
55 564 763	ZFR6BP-G	
55 565 219	ZFR6V-G	
55 571 391	PFR6D10G	
55 576 026	IFR7X7G	
90 239 568	BPR6ES	2
90 239 569	BPR6HS	3
90 336 461	BKR6ES	28
90 338 179	BCPR6ET	
90 355 136	BPR6ES	2
90 356 323	BPR5ES	6
90 357 729	BKR6EK	20
90 357 780	BKR6ES	28
90 423 215	BKR6ES	28
90 512 989	BKR5EK	23
93 161 199	PFR6G-9	
93 193 723	IKR6G11	
<b>PEUGEOT =&gt; PSA</b>		
PIAGGIO	→ NGK	V-Line
638 852	CR7EB	
638 853	CR8EB	
639 687	CR8EKB	
641 387	ER9EH-6N	
828 209	CR9EB	
829 981	CR7EKB	



<b>PIAGGIO</b>	<b>→ NGK</b>	<b>V-Line</b>
847 085	B8ES	
861 612	BR8ES	
887 016	LMAR8F-9	
896 472	PMR9B	
AP 0297 542	DR8EA	
AP 0297 547	DR8EB	
AP 0297 830	BR10EG	
AP 0297 942	DCPR9E	
AP 2BEN 000088	BPR7HS	
AP 2BEN 000276	CPR8E	
AP 2BEN 000319	ZMR7AP	
AP 8176 075	BPR4HS	
AP 8206 870	BR7HS	
AP 8206 871	BR8HS	
AP 8206 915	BR9ES	
AP 8520 007	CR7E	
AP 8600 008	BR9ECM	

**PONTIAC => GM**

<b>PORSCHE</b>	<b>→ NGK</b>	<b>V-Line</b>
958 170 222 90	ILZKR8A	
999 170 223 90	BKR7EQUF	

<b>PRESTOLITE</b>	<b>→ NGK</b>	<b>V-Line</b>
10 E 2	C7HSA	
10 E 3	C7HSA	
10 E 4	C6HSA	
12 E 2	D8HA	
12 E 3	D8HA	
12 E 22	D6HA	
12 E 42	D6HA	
12 G 2	D8EA	
12 G 3	D8EA	
14 2 X	B6S	
14 3	B6S	
14 3 X	B6S	
14 4	B6S	
14 5	B6S	
14 5 X	B6S	
14 7	B-4	
14 7 X	B-4	
14 9	B-4	
14 9 X	B-4	
14 11	B-2	
14 11 X	B-2	
14 32	BP6S	
14 42	BP5S	
14 52	BP5S	
14 82	BP-4	
14 E 1	B8HS	

<b>PRESTOLITE</b>	<b>→ NGK</b>	<b>V-Line</b>
14 E 2	B7HS	
14 E 3	B6HS	
14 E 4	B5HS	
14 E 6	B5HS	
14 E 22	BP7HS	
14 E 32	BP6HS	18
14 E 42	BP6HS	18
14 E 52	BP5HS	
14 E 62	BP5HS	
14 E 82	BP-4H	
14 ER 4	BR6HS	
14 ER 6	BR6HS	
14 F 22	BP6FS	
14 F 32	BP6FS	
14 F 42	BP5FS	
14 F 52	BPR4FS	
14 G 1	B8ES	
14 G 2	B7ES	
14 G 3	B6ES	
14 G 4	B6ES	
14 G 5	B5ES	
14 G 7	B5ES	
14 G 12	BP8ES	
14 G 22	BP6ES	4
14 G 32	BP5ES	8
14 G 42	BP5ES	8
14 G 52	BP5ES	8
14 G 82	BP4ES	
14 G 902	BP8ES	
14 GF 22	BP6EFS	5
14 GR 4	BR6ES	
14 GR 7	BR5ES	
14 GR 22	BPR6ES	2
14 GR 32	BPR5ES	6
14 GR 42	BPR5ES	6
14 GR 52	BPR4ES	
14 GR 52 A	BPR4ES-11	
14 GR 53	ZGR5C	
14 GR 526	BPR4ES-11	
14 GRF 22	BPR6EFS	7
14 GRF 32	BPR5EFS	
14 GRF 52	BPR5EFS	
14 L 4	B-6L	
14 L 7	B-6L	
14 L 9	B-4L	
14 R 3	BR6S	
14 R 4	BR6S	
14 R 5	BR6S	
14 R 8	B6S	
14 R 32	BP5S	
14 R 42	BP5S	
14 R 52	BP-4	





PRESTOLITE	→ NGK	V-Line
14 R 53	BP-4	
14 RF 22	BPR6FS	
14 RF 32	BPR5FS	
14 RF 32 A	BPR5FS-15	
14 RF 42	BPR5FS	
14 RF 42 A	BPR5FS-15	
14 RF 52	BPR4FS	
14 RF 52 A	BPR4FS-15	
14 RF 62	BPR4FS	
14 RF 62 A	BPR4FS-15	
14 RF 326	BPR5FS-15	
14 RF 426	BPR5FS-15	
14 RF 526	BPR4FS-15	
14 RF 626	BPR4FS-15	
18 3	AB-6	
18 4	AB-6	
18 8	AB-6	
18 9	AB-6	
18 10	AB-6	
18 F 3	A6FS	
18 F 6	A6FS	
18 F 22	AP6FS	
18 F 32	AP6FS	
18 F 42	AP5FS	
18 F 82	AP5FS	
18 RF 3	AR6FS	
18 RF 32	APR6FS	
18 RF 42	APR6FS	
18 RF 82	APR6FS	
PSA	→ NGK	V-Line
5960.14	LFR5B	
5960.81	PLZKBR7A-11	
5960.92	PLZKBR7A-G	
5960.93	PLZKBR7A-G	
5960.A5	PLZKBR7A-G	
5960.C2	FR5EI	
5960.C3	FR5EI	
5960.E1	PLZKBR7A-G	
5960.E2	PLZKBR7A-G	
5960.G4	PLZKBR7A-G	
5960.H9	PLZKBR7A-G	
5960.L0	PLZKBR7A-G	
5960.L5	ILZKBR7A-8G	
5962.00	BCP6ES	17
5962.05	BP6EFS	5
5962.09	BP6EFS	5
5962.13	BP6ES	4
5962.14	BP6EFS	5
5962.15	BP6EFS	5
5962.16	BP6ES	4

PSA	→ NGK	V-Line
5962.21	BUR6ET	1
5962.22	BPR6EIX	
5962.2A	BPR6ES	2
5962.2T	BKR6EKC	26
5962.2X	BKR6ES	28
5962.5G	BKR6EZ	38
5962.71	BKR6ES	28
5962.72	BP6EFS	5
5962.7S	BKR6EZ	38
5962.7W	LFR6B	
5962.80	BP6HS	18
5962.82	BP6ES	4
5962.87	BP6EFS	5
5962.88	BP8ES	
5962.90	BP6HS	18
5962.94	BP7ES	
5962.98	BP7ES	
5962.A1	BP7ES	
5962.A2	BP6ES	4
5962.A3	BP6HS	18
5962.A5	PLZKBR7A-G	
5962.A0	BP7ES	
5962.C5	BKR6ES	28
5962.C6	BKR6ES	28
5962.C0	BP5EFS	
5962.F7	BCP6ES	17
5962.F8	BCP6ES	17
5962.G8	BP7ES	
5962.H2	BKR6ES	28
5962.H8	BKR5ES	35
5962.H9	BKR5ES	35
5962.IA	BP5ET	
5962.IK	BKR6EK	20
5962.IL	BKR5EK	23
5962.J9	BKR6ES	28
5962.J0	BCP6ES	17
5962.K1	BCPR7ES	
5962.K3	BCP7ET	
5962.K4	BKR6ES	28
5962.K6	BKR6ES	28
5962.K7	BCPR6ET	
5962.K0	BCPR7ES	
5962.OE	BKR6EK	20
5962.R5	BCPR6ET	
5962.R9	BKR6ES	28
5962.S2	BKR6ES	28
5962.S4	BKR5ES	35
5962.S7	BP5ES	8
5962.T8	BKR6ES	28
5962.T0	BKR6ES	28
5962.V6	BKR5ES	35
5962.V7	BKR6ES	28



PSA	→ NGK	V-Line
5962.V8	BCPR7ES	
5962.W1	BKR5ES	35
5962.W4	BCPR6ET	
5962.W6	BCPR7ES	
5962.W7	BCPR7ES	
5962.W9	BKR5EK	23
5962.X5	BCP6ES	17
5962.X8	BCP6ES	17
5962.Y2	BKR5EK	23
5962.Y8	BKR6EK	20
5962.Z1	BKR6EK	20
5962.Z6	BKR5EK	23
5962.Z0	BKR6EK	20
7267.52	BR6HSA	
7343.71	BR8HS	
7355.92	BPR6HS	3
7369.54	BR7HS	
7369.75	BR7ES	
7370.27	BPR5HS	
7381.55	BR8ES	
7423.80	CR7E	
7443.61	CPR8E	
7461.74	CR7EB	
7540.50	BR9ES	
7567.56	DPR7EA-9	
7567.57	B6HS	
7567.58	BP5HS	
7567.59	B7HS	
7567.60	B8HS	
7567.61	BP6HS	18
7567.62	B9ES	
7567.63	B9HS	
7567.66	B8ES	
7567.67	CPR8EB-9	
7567.68	BR9HS	
7567.70	B6ES	
7581.44	CR7HSA	
7598.74	CR7EKB	
7604.64	BPR7ES	19
7616.05	CR9EB	
7664.20	CR7EKA	
7682.28	CR8EKB	
7696.18	CR8EB	
11 737 027 00	BPR5HS	
16 075 776 80	DILFR5A11	
95 496 692	BP6HS	18
95 605 398	B6HS	
95 611 941	BP6EFS	5
95 619 043	BP6ES	4
96 000 090	BCP5ES	16
96 037 952	BCP5ES	16
96 039 962	BCP6ET	

PSA	→ NGK	V-Line
96 064 890	BKR5ES	35
96 097 486	BCP7ET	
96 145 071	BCPR6ET	
96 762 881 80	LZKR6AI-10G	
97 533 994	BP7EFS	
AM 212 207 A	B6HS	
MKP 00073	BP7ES	
V7 534 226 80	PLZKBR7A-G	
V7 534 226 80-03	PLZKBR7A-G	
V7 570 106 80	ILZKBR7A-8G	
ZC 986 209 0U	BP5ES	8
ZCT 000 011	BP6HS	18
ZCT 000 012	BP7ES	
RENAULT	→ NGK	V-Line
22 40 1EA 015	PLZKAR6A-11	
22 40 1JA 01B	DILKAR6A11	
74 39 146 775	BCPR5ET	
77 00 101 401	BKR5ES	35
77 00 103 502	BPR5ES	6
77 00 103 503	BPR5ES	6
77 00 103 533	BKR5EK	23
77 00 107 916	BKR5EK	23
77 00 115 827	BKR6EK	20
77 00 260 637	BCP7ET	
77 00 266 295	BPR6EFS	7
77 00 267 140	BPR6EFS	7
77 00 267 805	TR7IX	
77 00 273 462	BKR6ES	28
77 00 273 698	BKR6EIX	
77 00 500 132	BKR6ETUC	
77 00 500 168	BKR6E	28
77 00 553 622	BP6ES	4
77 00 565 155	BR9EIX	
77 00 587 168	BP6HS	18
77 00 714 540	BPR6EFS	7
77 00 722 095	BP6EFS	5
77 00 724 821	BP6ES	4
77 00 725 302	BPR5ES	6
77 00 726 503	BP7EFS	
77 00 727 383	BPR6ES	2
77 00 731 583	BP7EFS	
77 00 732 626	BP8ES	
77 00 733 422	BP5HS	
77 00 736 149	BP7EFS	
77 00 736 150	BP7EFS	
77 00 737 457	BP7EFS	
77 00 737 458	BP6EFS	5
77 00 737 459	BP7ES	
77 00 737 612	BCP5ES	16
77 00 742 094	BPR7ES	19



RENAULT	→ NGK	V-Line
77 00 743 137	BCP5ES	16
77 00 743 920	BP5ES	8
77 00 749 163	BCP5ES	16
77 00 824 821	BP6ES	4
77 00 852 522	BP6EFS	5
77 00 852 543	TR7IX	
77 00 855 463	BCP6ET	
77 00 855 918	BP5EFS	
77 00 856 342	BCP6ET	
77 00 859 910	BCP5ES	16
77 00 859 967	BP5ES	8
77 00 860 235	BP5ESZ	
77 00 861 471	BP7ES	
77 00 861 472	BP6ESZ	
77 00 862 054	BP5ES	8
77 00 868 864	BPR7ES	19
77 00 869 200	BK5ESZ	
77 00 871 617	BCPR6ET	
77 01 021 767	BP6EFS	5
77 01 041 021 4	BP5ES	8
77 01 041 214	BP5ES	8
77 01 041 215	BP6EFS	5
77 01 042 816	BKR6ES	28
77 01 043 624	BCPR6ET	
77 01 045 018	BP7EFS	
77 01 065 085	PLZKAR6A-11	
77 01 366 057	BP6HS	18
77 01 366 084	BR8EIX	
77 01 366 085	BR7EIX	
77 01 366 086	BP6ES	4
77 01 366 087	BP7ES	
77 01 366 137	BP6EFS	5
77 01 366 267	BP6HS	18
77 01 366 268	BP7ES	
77 01 366 269	BP6ES	4
77 01 366 270	BP6EFS	5
77 01 366 513	BP5HS	
77 01 366 514	BP6EFS	5
77 01 366 515	BP6HS	18
77 01 366 516	BP6ES	4
77 01 366 533	B6HS	
77 01 366 539	BP5ES	8
77 01 366 903	BP5ES	8
77 01 414 022	BP5HS	
77 01 414 025	BP6ES	4
77 01 414 026	BP7EFS	
77 01 414 027	BP7EFS	
77 01 414 031	BPR6ES	2
77 01 414 105	BP5ESZ	
82 00 020 791	BKR6EZ	38
82 00 027 363	BKR5EK	23
82 00 030 765	LZKAR7A	

RENAULT	→ NGK	V-Line
82 00 046 337	PFR6G-9	
82 00 239 321	PFR6E-10	
82 00 314 928	PFR7G-9	
82 00 322 273	LZKAR7A	
82 00 363 364	PFR6G-9	
82 00 363 384	PFR6G-9	
82 00 492 426	PFR7Z-TG	
82 00 587 901	ILKAR7A7	
82 00 592 215	LZKAR7B	
82 00 662 185	LZKAR7B	
82 01 001 947	IFR7X8G	
83 04 504 277	ZFR5F	
88 03 343 3	IGR7E-3D	
89 33 003 862	BKR6ES	28
96 26 575 480	BKR6EK	20
96 32 182 880	PFR6E-10	
ROLLS ROYCE	→ NGK	V-Line
RH12 050	GR4IX	
RH13 439	BKR4EVX	
RH13 998	BKR5EIX	
ROVER	→ NGK	V-Line
NLP 100 260	BPR6E	2
NLP 100 290	PFR6N-11	
SAAB	→ NGK	V-Line
12 14 060	PFR6D10G	
12 14 065	DILFR7B10G	
45 71 808	PFR7H-10	
48 11 581	ILTR5D	
56 92 485	BCP7EVX	
59 58 780	BCP5EVX	
59 58 798	BCP6EVX	
59 62 485	BCP7EVX	
88 19 294	BCP6ES	17
88 19 302	BCP7EVX	
88 19 328	BPR7EIX	
91 12 541	BCPR7ES-11	
91 16 385	BCP5ES	16
91 17 565	BCPR6ES-11	11
91 36 276	BCP5EVX	
91 39 643	BCP6EVX	
91 71 307	BKR7ES-11	
91 85 398	PFR7H-10	
91 88 681	PFR7H-10	
91 95 109	BKR5EK	23
91 95 868	BKR5EQUPA	
93 99 866	PFR6H-10	
12 620 540	ILTR5D	
12 787 099	PFR6T-10G	



SAAB	→ NGK	V-Line
12 788 884	PLFR6C-10G	
15 885 210	BCPR7ES-11	
30 520 467	BCPR6ES-11	11
32 000 330	BCPR7ES-11	
55 564 215	BKR7ESC-11	
55 564 748	DILFR7B10G	
55 564 763	ZFR6BP-G	
55 571 391	PFR6D10G	
83 500 768	BCP7ES	

#### SEAT => VW Group

#### SKODA => VW Group

#### SMART => MERCEDES

SSANGYONG	→ NGK	V-Line
A 172 159 00 03	BCP5ES	16

#### STEYR => MERCEDES

SUBARU	→ NGK	V-Line
22401-AA000	BP5ES-11	
22401-AA010	BP6ES-11	
22401-AA020	BP6ES	4
22401-AA030	BP6ES	4
22401-AA080	BP6EY	
22401-AA090	BP7ES	
22401-AA100	BE527Y-11	
22401-AA110	BE527Y-11	
22401-AA120	BPR6ES-11	13
22401-AA130	BPR6ES-11	13
22401-AA200	BPR6ES	2
22401-AA210	BPR7ES	19
22401-AA220	BPR6ES	2
22401-AA230	BPR7E	19
22401-AA310	BKR6E-11	14
22401-AA320	BKR6E-11	14
22401-AA360	PFR7B	
22401-AA370	PFR6B-11	
22401-AA380	BRE527Y-11	
22401-AA390	BRE527Y-11	
22401-AA400	PFR6B	
22401-AA460	BPR5EY-11	
22401-AA470	BPR6EY-11	10
22401-AA480	BPR5ES-11	
22401-AA500	BKR6EIX-11	
22401-AA510	BKR6EIX	
22401-AA520	PFR6G-11	
22401-AA530	PFR6G	

SUBARU	→ NGK	V-Line
22401-AA531	PFR6G	
22401-AA570	PFR5B-11	
22401-AA580	PLFR6A-11	
22401-AA600	PFR7G	
22401-AA610	ZFR6FIX-11	
22401-AA630	ILFR6B	
22401-AA650	FR5AP-11	
22401-AA65A	FR5AP-11	
22401-AA670	SILFR6A	
22401-AA680	ILFR6B	
22401-AA700	DILFR6D11	
22401-AA720	SILFR6A11	
22401-AA730	SIFR6A11	
22401-AA750	SILFR6C11	
22401-KA000	BUR6EA-11	
22401-KA010	BKR6E-11	14
22401-KA030	BKR6E-11	14
22401-KA050	BUR6EA-11	
22401-KA060	BUR6EA-11	
22401-KA080	BKR6E	28
22401-KA090	BCPR6E	12
22401-KA100	BCPR6E	12
22401-KA130	BPR6ES	2
22401-KA140	ZFR6G	
22401-KA150	BKR6E	28
22401-KA160	ZFR6G	
22401-KA170	ZFR5G	
22401-KA180	ZFR5G	
22401-KA190	BPR5E-11	
22401-KA200	BKR5E-11	33
22401-KA210	BKR5E-11	33
22401-KA240	DCPR7E	
22401-KA260	DCPR7E	
22401-KA290	BKR4E-11	
22401-KA310	DCPR8E	
22401-KA320	DCPR8EIX	
22401-KA340	KR8BI	
22401-KA430	BKR6EKPA	
22401-KA440	BKR5E	35
22401-KA450	LKR7AI	
32054-0800	B6ES	
32054-1110	B7ES	
32054-1120	BR7EIX	
32054-1320	B6EVX	
32054-5700	BR6ES	
38028-0102	BP6EY	
38242-0800	B5ES	
42054-3200	BP5ES	8
42054-5502	BP6ES	4
42054-5602	BP5EY-11	
42054-5702	BP6ES-11	
42054-5800	BE529Y-11	



SUBARU	→ NGK	V-Line
42054-5802	BE529Y-11	
42054-7102	BP5EY	
42054-7302	BP5EY-11	
48028-7100	BP4EY-11	
49001-0003	BPR5EIX	
49001-0013	BPR6EIX	
49001-0023	BPR7EIX	
49001-0033	BPR5ES	6
49001-0043	BP5EY	
49001-0053	BP6EY	
49001-0082	BPR5EY	9
49001-0092	BPR6EY	
82054-1810	B6HS	
82054-1812	B6HS	
82054-6010	B8HS	
82054-7820	BR6HIX	
82054-8020	BR8HIX	
82054-8600	B6ES	
82054-9310	B7HS	
82054-9312	B7HS	
82054-9320	BR7HIX	
88241-7800	B5HS	
89057-3400	B6S	
SAB 330 DE 2640	LFR6AIX-11	
SAB 330 DE 3360	BKR5EIX-11	
SAB 330 DE 3370	BKR6EIX-11	
SAB 330 DE 3430	DCPR7EIX	
SAB 330 DE 5140	LFR6AIX-11	
SAB 330 DE 8640	IFR5E11	
SAB 330 DE 8680	BKR5EIX-11	
SAB 330 DE 8690	BKR6EIX-11	
SAB 330 DE 8720	DCPR7EIX	

SUZUKI	→ NGK	V-Line
09482-00006	B-4	
09482-00011	B-4H	
09482-00036	BP-4H	
09482-00051	B6S	
09482-00053	B7S	
09482-00054	B6ES	
09482-00056	B8ES	
09482-00059	BP6HS	18
09482-00060	BP7HS	
09482-00064	BR6HIX	
09482-00065	BR7HIX	
09482-00066	B9ES	
09482-00074	BP6HS	18
09482-00079	BR6ES	
09482-00082	B7HS	
09482-00083	B7HS	
09482-00084	BP6HS	18
09482-00088	BR6HS	

SUZUKI	→ NGK	V-Line
09482-00089	B7ES	
09482-00091	B8ES	
09482-00095	B6HS	
09482-00096	BR8EIX	
09482-00097	BR9EIX	
09482-00098	BR9ES	
09482-00102	BR8HS	
09482-00105	BP7HS	
09482-00114	BR8EIX	
09482-00115	BR9EIX	
09482-00116	BR7HS	
09482-00117	BR7ES	
09482-00118	BP6ES	4
09482-00120	BP5HS	
09482-00121	BR8ES	
09482-00123	BP5EY	
09482-00124	BP5HS	
09482-00125	BPR-4H	
09482-00127	BR9ES	
09482-00128	B6ES	
09482-00129	BP4EY	
09482-00130	BP4EY	
09482-00131	BP5ES	8
09482-00136	BPR-4H	
09482-00139	BP7ES	
09482-00141	BPR6HS	3
09482-00142	B-4H	
09482-00143	BR5HS	
09482-00144	D8EA	
09482-00145	D8EA	
09482-00147	BPR5HS	
09482-00149	DR8ES-L	
09482-00151	B8HS	
09482-00153	B7HS	
09482-00155	BPR5ES	6
09482-00157	BR8HS	
09482-00159	BPR4EY	
09482-00161	BP4HS	
09482-00163	BP5HA	
09482-00167-000	BPR5EY	9
09482-00167-001	BPR5ES	6
09482-00170	BP4HA	
09482-00171	BP4HS	
09482-00172	BP2HS	
09482-00175	BP8ES	
09482-00177	BP6ES	4
09482-00181	BR10EIX	
09482-00182	D7EA	
09482-00183	D7EA	
09482-00184	D9EA	
09482-00185	D9EA	
09482-00186	BP-4H	





SUZUKI	→ NGK	V-Line
09482-00188	BP6HS	18
09482-00189	BP7HS	
09482-00190	B6HS	
09482-00191	B7HS	
09482-00192	B8HS	
09482-00195	B7ES	
09482-00196	B8ES	
09482-00198	B8HS	
09482-00205	BPR4HS	
09482-00206	BPR4HS	
09482-00208	B8EGV	
09482-00209	B9EGV	
09482-00210	B10EGV	
09482-00216	BP4EY-11	
09482-00217	BP5EY-11	
09482-00218	BP4EY-11	
09482-00219	BP5EY-11	
09482-00220	DR7ES	
09482-00221	DR8ES	
09482-00222	DR7EA	
09482-00223	DR8EA	
09482-00225	B8ES	
09482-00226	BP7ES	
09482-00227	CM-6	
09482-00228	BP5HS	
09482-00229	BPR6HS	3
09482-00230	BR8HS	
09482-00233-111	BR9ES	
09482-00234	DR9EA	
09482-00237	B8HS	
09482-00239	BPR8ES	
09482-00240-111	BPR8ES	
09482-00244-111	BPR7HS	
09482-00247-111	BR8ES	
09482-00255	BPR7HS	
09482-00258	BPMR6A	
09482-00259	BP6HS	18
09482-00260	BPM4A	
09482-00261	BPMR4A	
09482-00262	BP5HS-10	
09482-00263	BP5HS-10	
09482-00264	BP6HS-10	
09482-00265	BP6HS-10	
09482-00268	BP8HS	
09482-00269	B7HS-10	
09482-00277	BR7HS-10	
09482-00278	B8HS-10	
09482-00279	B8HS-10	
09482-00280	BR8HS-10	
09482-00281	BPR6HS	3
09482-00282	B5HS	
09482-00284	BP6EY-11	

SUZUKI	→ NGK	V-Line
09482-00285	BPR6ES-11	13
09482-00286	BPR6EY-11	10
09482-00287	BP5ES-11	
09482-00288	BP4ES	
09482-00289	B-4H	
09482-00290	BP-4H	
09482-00291	BP4HS	
09482-00294	C6HA	
09482-00295	C6HSA	
09482-00299	BPR6ES	2
09482-00302-111	BPR6HS	3
09482-00303	BP6EY-11	
09482-00305	BP5HS	
09482-00306	BPR6HS	3
09482-00308	BR5HS	
09482-00309	B5HS	
09482-00312	BPR5EY-11	
09482-00314	CR7HSA	
09482-00316	BPR5HS	
09482-00317	C8HA	
09482-00320-111	CR8HSA	
09482-00321	C8HSA	
09482-00322	BPR5EIX	
09482-00325	BR8EIX	
09482-00327	BR6HS-10	
09482-00328	DP9EA-9	
09482-00330	DPR9EA-9	
09482-00331-111	DPR7EA-9	
09482-00332	DP8EA-9	
09482-00333-111	DP8EA-9	
09482-00334	DPR8EA-9	
09482-00335-111	DPR7EA-9	
09482-00338	B6HS-10	
09482-00339	B6HS-10	
09482-00340	CR6HS	
09482-00341	BR6HS-10	
09482-00348	BR8ES	
09482-00349	BR9ES	
09482-00351	B9ES	
09482-00352	DP7EA-9	
09482-00354	DPR7EA-9	
09482-00355-111	DPR7EA-9	
09482-00358	BR4HS	
09482-00359	BPR5HS	
09482-00360	BR10ES	
09482-00362	ZGR5A	15
09482-00363	BPR5EY	9
09482-00365	J9A	
09482-00366	JR9B	
09482-00367	BPR4HS	
09482-00368	DCP7E	
09482-00369	DCP7E	



SUZUKI	→ NGK	V-Line
09482-00370	BR8HS-10	
09482-00371	J10A	
09482-00372	JR10B	
09482-00375	B8HS-10	
09482-00376	B8HS	
09482-00378	DCPR8E	
09482-00379	DCPR8E	
09482-00381	PJR7A	
09482-00383	DCPR8EIX	
09482-00384	DCPR8EIX	
09482-00385	BP7ES	
09482-00386	DCPR7EIX	
09482-00387	DCPR7EIX	
09482-00388	JR9B	
09482-00389	JR9B	
09482-00390	JR10B	
09482-00391	JR10B	
09482-00392	BP6ES	4
09482-00393	DCP6E	
09482-00394	DCP6E	
09482-00395	ZG5E	
09482-00397	JR9C	
09482-00398	DR7EA	
09482-00399	DR8EA	
09482-00400	DR9EA	
09482-00401	JR8C	
09482-00404	LR8A	
09482-00406	CR6HSA	
09482-00407	CR6HSA	
09482-00408	CR7HSA	
09482-00409	BPR6ES	2
09482-00410	CR9EK	
09482-00411	CR9EK	
09482-00412	CR8EK	
09482-00413	CR8EK	
09482-00414	CR7EK	
09482-00416-111	BPR5HS	
09482-00419	R2349-11	
09482-00420-111	BPR-4H	
09482-00421	BPR6ES-11	13
09482-00422	R5184-95	
09482-00423	R5184-10	
09482-00424	R5184-105	
09482-00426	BK6E	
09482-00427	BKR6E	28
09482-00429	BKR6E	28
09482-00430	R0373A-10	
09482-00431	R0373A-11	
09482-00432	BPR5E	6
09482-00433	BPR5EY-11	
09482-00434	BP7ES	
09482-00446	DCPR6E	

SUZUKI	→ NGK	V-Line
09482-00447	DCPR6E	
09482-00448	DCPR7E	
09482-00449	DCPR7E	
09482-00450	DCPR8E	
09482-00452	ZGR5A	15
09482-00456	CR8E	
09482-00457	CR8E	
09482-00458	CR9E	
09482-00459	CR9E	
09482-00460	CR10E	
09482-00461	CR10E	
09482-00462	CR10EK	
09482-00463	CR10EK	
09482-00464	BR8HCS-10	
09482-00467	BR9HS-10	
09482-00468	BPR5E	6
09482-00470	BR8ECM	
09482-00472	BR9ECM	
09482-00473	BR9ECM	
09482-00474	BR10ECM	
09482-00476	BKR5E	35
09482-00477	BKR5E	35
09482-00478	B10ES	
09482-00479	DCPR7EIX	
09482-00481	DCPR8EIX	
09482-00482	DCPR7EIX	
09482-00484	DCPR8EIX	
09482-00485	CR8HSA	
09482-00486	BR8HCS-10	
09482-00487	BPR6ES	2
09482-00488	DCPR7E	
09482-00491	JR8B	
09482-00493	BPR5E-11	
09482-00494	BKR6E-11	14
09482-00495	BPR7ES	19
09482-00496	BPR5E-11	
09482-00497	BKR5E-11	33
09482-00498	BPR7ES	19
09482-00499	R4118S-8	
09482-00500	R4118S-9	
09482-00501	BPR6EY	
09482-00502	BP5EY	
09482-00504	BPR5EY	9
09482-00508	BKR6E-11	14
09482-00509	R6918B-8	
09482-00511	R6918B-7	
09482-00513	R0045J-10	
09482-00514	R0045J-11	
09482-00515	CR7E	
09482-00516	CR7E	
09482-00519	BR9EYA	
09482-00521	PGR5A	



SUZUKI	→ NGK	V-Line
09482-00522	BPR7HS-10	
09482-00523	BPR8HS	
09482-00525	IKR7A	
09482-00526	BR10EYA	
09482-00527	KR7AI	
09482-00528	CR6E	
09482-00530	BPR6HS	3
09482-00531	BP6HS	18
09482-00532	B7HS-10	
09482-00533	BR7HS-10	
09482-00534	B6HS-10	
09482-00535	BR6HS-10	
09482-00537	DCPR9EIX	
09482-00540	PFR5G-11	
09482-00546	GR5AI-10	
09482-00547	IFR5E11	
09482-00548	IFR6E11	
09482-00549	IFR5J11	
09482-00550	IFR6J11	
09482-00556	CR8EIA-9	
09482-00557	CR9EIA-9	
09482-00558	CR9EIA-9	
09482-00561	BR8EG	
09482-00562	IFR5E11	
09482-00564	BR9EYA	
09482-00565	KR8AI	
09482-00566	BKR5E-11	33
09482-00570	CR8EB	
09482-00581	CR8EKB	
09482-00582	CR9EKB	
09482-00584	CR8EIB-10	
09482-00597	CR8EIA-10	
09482-00600-000	DIMR8A10	
09482-00602	IKR6G11	
09482-00603	IKR6G11	
09482-00606	SILFR6A11	
09482-00612	MR8AI9	
09482-69001	BPR6HS	3
09482-M0061-1	IKR6G11	
27118-50000	R7433-8	
94820-01197	B9ES	
94820-0550	IFR6J11	
99000-69257-000	R0161-10	
99000-69257-001	R2525-10	
99000-69571	C7HSA	
99000-69835-B6R	BR6HIX	
99000-69835-B7R	BR7HIX	
99000-69835-B8R	BR8HIX	
99000-69835-BP6	BPR6HIX	
99000-69835-BP7	BPR7HIX	
99000-69835-BR1	BR10EIX	
99000-69835-BR8	BR8EIX	

SUZUKI	→ NGK	V-Line
99000-69835-BR9	BR9EIX	
99000-69835-C6R	CR6HIX	
99000-69835-C7R	CR7HIX	
99000-69835-C8R	CR8HIX	
99000-69835-CR7	CR7EIX	
99000-69835-CR8	CR8EIX	
99000-69835-CR9	B8HCS	
99000-69835-DC7	DPR7EIX-9	
99000-69835-DC8	DCR8EIX	
99000-69835-DR8	DR8EIX	
99000-69835-DR9	DR9EIX	
99000-69835-PR8	DPR8EIX-9	
99000-69835-PR9	DPR9EIX-9	
99000-79A37-16E	BPR5EIX	
99000-79A37-20F	BR6HIX	
99000-79A37-22E	BR7EIX	
99000-79A37-24E	BR8EIX	
99000-79A37-24R	BR8EIX	
99000-79A37-27R	BR9EIX	
99000-79A37-29E	BR10EIX	
99000-79A37-31E	BR10EIX	
99000-79A37-K0P	BKR6EIX-11	
99000-79A37-U2F	CR7HIX	
99000-79A37-U4R	CR8HIX	
99000-79A37-U7E	CR9EIX	
99000-79A37-W6X	BPR5EIX	
99000-79A45-B0E	BR10EIX	
99000-79A45-B6H	BR6HIX	
99000-79A45-B7E	BR7EIX	
99000-79A45-B7H	BR7HIX	
99000-79A45-B8E	BR8EIX	
99000-79A45-B8H	BR8HIX	
99000-79A45-B9E	BR9EIX	
99000-79A45-P8E	BPR8EIX	
99000-79B56	BPR4EY-11	
99000-79J80-K16	BKR5EIX-11	
99000-79J80-K20	BKR6EIX-11	
99000-79J80-U22	DCPR7EIX	
99000-79J80-W16	BPR5EIX-11	
99000-79J80-W20	BPR6EIX-11	
99000-79J80-W22	BPR7EIX	
99000-79K24-22B	DPR7EIX-9	
99000-79K24-24B	DPR8EIX-9	
99000-79K24-27B	DPR9EIX-9	
99000-79K24-F22	CR7HIX	
99000-79K24-F24	CR8HIX	
99000-79K24-H24	CR8EHIX-9	
99000-79K24-H27	CR9EHIX-9	
99000-79K24-IW4	BR8EIX	
99000-79K24-IW7	BR9EIX	
99000-79K24-U22	CR7EIX	
99000-79K24-U24	CR8EIX	



SUZUKI	→ NGK	V-Line
99000-79K24-U27	B8HCS	
99000-79K24-W22	BR7HIX	
99000-79K24-W24	BR8HIX	
99000-79K24-W27	BR9HIX	
99000-79K24-W31	BR10EIX	
99000-79K24-X24	DR8EIX	
99000-79K24-X27	DR9EIX	
99000-79K60-BP6	BPR6EIX-11	
99000-79K60-DC7	DCPR7EIX	
99000-79K60-K5R	BKR5EIX	
99000-79K60-K6R	BKR6EIX	
99000-79K60-KR6	BKR6EIX-11	
99000-79K60-P5R	BPR5EIX	
99000-79K60-P6R	BPR6EIX	
99000-79K60-P7R	BPR7EIX	
99000-79K60-PR5	BPR5EIX-11	
TORCH	→ NGK	V-Line
5 580	BUR6ET	1
8 012	BPR6EIX	
C 6 RTC	D6HA	
D 7	D7EA	
D 7 CA	D7EA	
D 7 RC	D7EA	
D 8 C	D8EA	
D 8 RC	DR8EA	
D 8 RTC	DR8EA	
D 8 T	D8EA	
DK 7 RTC	DCPR7E	
E 4 RTC	BPR4HS	
E 4 TC	BP4HS	
E 5 RTC	BPR5HS	
E 5 T	BP-4H	
E 5 TC	BP5HS	
E 6 RC	BR6HS	
E 6 RTC	BPR6HS	3
E 6 T	BP4HS	
E 7 C	B6HS	
E 7 TJC	BUR6ET	1
E 8 RC	BR8HS	
E 8 RTC	BPR8HS	
F 5 C	B4ES	
F 5 RF	BPR5EY	9
F 5 RTC	BPR5ES	6
F 5 T	BP4ES	
F 5 TC	BP5ES	8
F 6 RF	BPR6EY	
F 6 RTC	BPR6ES	2
F 6 T	BP6ES	4
F 7 C	B7ES	
F 7 RC	BR7ES	
F 7 RTC	BPR7ES	19

TORCH	→ NGK	V-Line
F 7 RTJC	BUR6ET	1
F 8 RC	BR8ES	
F 8 RTC	BP8ES	
G 3 F	B-4	
G 3 TC	BP-4	
G 4 C	B-4	
G 4 RC	B-4	
G 5 RC	BR6S	
G 6	B6S	
G 6 C	B6S	
G 6 RC	BR6S	
H 5	B6S	
K 4 RTC 3	ZFR5F	
K 5 RF 11	BKR5E-11	33
K 5 RTC 11	BKR5ES-11	33
K 5 TC	BKR5ES-11	33
K 6 RF	BKR6ES	28
K 6 RF 11	BKR6E-11	14
K 6 RTC	BKR5E-11	33
K 6 RTC 11	BKR6ES-11	14
K 7 RTC	BKR6ES	28
K 7 TC	BCP6ES	17
K 7 TJC	BCP6ET	
P 5 RTC	BPR5FS	
P 5 TC	BP5FS	
P 6 RTC	BPR6FS	
P 6 TC	BP6FS	
P 7 RTC	BP7FS	
P 7 TC	BP7FS	
Q 5 RTC	BPR5EFS	
Q 5 TC	BP5EFS	
Q 6 RTC	BPR6EFS	7
Q 6 TC	BP6EFS	5
Q 7 TC	BP5EFS	
R 4 C	AB-6	
T 5 TC	AP5FS	
T 6 RTC	APR6FS	
T 6 TC	AP6FS	
TOYOTA	→ NGK	V-Line
04195-34140	BP5ES	8
04195-34150	BP6ES	4
04195-34280	BPR5EY	9
04195-34320	BPR5EY-11	
08922-01016-83	BPR5EY	9
08922-01017-83	BPR6EY-11	10
08922-01019-83	BPR5EY-11	
08922-01020-83	BCPR6EY-11	
90048-51054	BPR5EY	9
90048-51059	BPR6EY	
90048-51063	BPR5EY-11	
90048-51093-A	BPR5EY-11	



TOYOTA	→ NGK	V-Line
90048-51108-1	BPR6EKB-L	
90048-51126	BPR5EJ	
90048-51131	BPR5EKB	
90048-51131-1	BPR5EKB	
90048-51134	BCPR6EKD	
90048-51134-1	BCPR6EKD	
90048-51140	BPR6EKB	
90048-51158	BKR5E-11	33
90048-51187	IKR7C	
90080-91116	BKR6EKP-B-11	
90098-00835	BUHX	
90098-00845	BUHW	
90098-00855	BUHW-2	
90098-09026	AB-2	
90098-09036	B-2	
90098-09115	BP-2H	
90098-09125	BP-2E	
90098-09685	BP2HS	
90098-09775	BP-4	
90098-09815	BP-4	
90098-14055	B4ES	
90098-14395	BP4EY	
90098-14425	BPR4EY	
90098-14515	BP-4H	
90098-14545	BPR4ES-13	
90098-14595	BP4EY	
90098-14615	BP4EY-11	
90098-14645	B-4H	
90098-14665	BPR4EY-11	
90098-14685	BP4HS	
90098-14715	B-4	
90098-14775	BP-4	
90098-14785	BPR4FS	
90098-14805	BPR4FS-15	
90098-14815	BP-4	
90098-16145	AP5FS	
90098-16325	BPR5ES	6
90098-16395	BP5EY	
90098-16415	C5HSA	
90098-16425	BPR5EY	9
90098-16455	B5ES	
90098-16505	B5ES	
90098-16515	BP5HS	
90098-16545	BP5ES-13	
90098-16595	BP5EY	
90098-16615	BP5EY-11	
90098-16635	BP5EFS	
90098-16645	B5ES	
90098-16655	BUR5EB-11	
90098-16675	BPR5EY	9
90098-16695	BP5EY	
90098-16705	BP5FS	

TOYOTA	→ NGK	V-Line
90098-16735	APR5FS	
90098-16745	BPR5E	6
90098-16775	BP5S	
90098-16785	BPR5FS	
90098-16795	BPR5FS-11	
90098-16805	BPR5FS-15	
90098-16815	BP5S	
90098-16865	BR5FS	
90098-16875	YR55IX	
90098-16895	BPR6EFS	7
90098-16925	BP5HS-10	
90098-16935	BR5ES	
90098-16955	BE527Y-11	
90098-16975	BUR5EB-11	
90098-16985	BCPR5EY-11	
90098-17015	AB-6	
90098-17025	AB-6	
90098-20145	AP6FS	
90098-20276	B6S	
90098-20325	BPR6ES	2
90098-20355	BM6A	
90098-20395	BP6EY	
90098-20415	C6HSA	
90098-20425	BPR6EY	
90098-20455	B6ES	
90098-20465	D6EA	
90098-20485	D6HA	
90098-20495	DR6HS	
90098-20505	B6ES	
90098-20515	BP6HS	18
90098-20525	BP6HSA	
90098-20545	BPR6EIX-11	
90098-20595	BP6EY	
90098-20615	BP6EY-11	
90098-20625	BPR6EK-A	
90098-20635	BP6EFS	5
90098-20645	B6HS	
90098-20655	BUR6EB-11	
90098-20665	BPR6EY-11	10
90098-20675	BPR6EY	
90098-20695	BP6ES	4
90098-20705	BP6FS	
90098-20735	APR6FS	
90098-20745	BPR6ES	2
90098-20755	BUR6EA-11	
90098-20765	C6HSA	
90098-20775	BP6S	
90098-20785	BPR6FS	
90098-20865	BR6FS	
90098-20885	BP6EFS	5
90098-20895	BPR6EFS	7
90098-20905	BR6ES	





TOYOTA	→ NGK	V-Line
90098-20915	BUR6EB-11	
90098-20925	BP6HS-10	
90098-20935	BR6ES	
90098-20975	BUR6EB-11	
90098-20985	BCPR6EY-11	
90098-21655	BR6EB-L-11	
90098-21915	BR6EB-L-11	
90098-22015	AB-7	
90098-22025	AB-7	
90098-22276	B7S	
90098-22325	BPR7ES	19
90098-22355	BM7A	
90098-22415	C7HSA	
90098-22455	B7ES	
90098-22465	D7EA	
90098-22475	DR7EA	
90098-22505	B7ES	
90098-22515	BP7HS	
90098-22595	BP7EY	
90098-22645	B7HS	
90098-22655	BUR7EB-11	
90098-22745	BPR7ES	19
90098-22755	BUR7EA-11	
90098-22765	C7HSA	
90098-22885	BP7EFS	
90098-22905	BR7ES	
90098-22915	BUR7EB-11	
90098-22935	BR7ES	
90098-22975	BUR7EB-11	
90098-24125	BP8ES	
90098-24276	B8S	
90098-24465	D8EA	
90098-24475	DR8EA	
90098-24485	D8HA	
90098-24495	DR8HS	
90098-24505	B8ES	
90098-24645	B8HS	
90098-24695	BP8ES	
90098-24935	BR8ES	
90098-25305	B8EG	
90098-25375	BR8HIX	
90098-27305	B9EG	
90098-27465	D9EA	
90098-27475	DR9EA	
90098-27505	B9ES	
90098-27645	B9HS	
90098-27935	BR9ES	
90098-31305	B10EG	
90098-31465	D10EA	
90098-31505	B10ES	
90098-33034	BCPR5EY-11	
90098-34305	B11EG	

TOYOTA	→ NGK	V-Line
90098-64017	B4-LM	
90098-64018	B-4L	
90098-64032	GR4IX	
90098-64033	GR4IX	
90098-64050	BPR4ES-13	
90098-64065	ZFR4F-11	
90098-64066	ZFR4F-11	
90098-64112	BUR4EB-11	
90098-66001	BP5EY-11	
90098-66004	BPR5E-11	
90098-66005	BCPR5EY-11	
90098-66006	BUR5EB-11	
90098-66007	BP5EY-11	
90098-66011	DR5HS	
90098-66016	B-6L	
90098-66024	BR5HS	
90098-66031	BPR5EY-11	
90098-66032	BPR5EIX	
90098-66033	BPR5EIX	
90098-66038	BCPR5EIX-11	
90098-66039	BCPR5EIX-11	
90098-66040	BCPR5EY-11	
90098-66045	BCPR5EIX-11	
90098-66047	BKR5E-11	33
90098-66050	BPR5ES-13	
90098-66053	BKR5E	35
90098-66054	BKR5EIX-11	
90098-66056	BKR5EYA-11	39
90098-66058	BPR5E	6
90098-66059	BKR5E-N-11	
90098-66064	PFR5J-11	
90098-66065	ZFR5J-11	
90098-66066	ZFR5F-11	
90098-66069	BPR5EKB	
90098-66070	PFR5B-11	
90098-66071	BKR5EYA	
90098-66075	ZFR5E-11	
90098-66077	BKR5EIX-11	
90098-66080	PZFR5F-11	
90098-66081	PZFR5F	
90098-66082	BCPR5E	32
90098-66108	PGR5A-11	
90098-66109	BPR5EJ	
90098-66113	PTR5C-13	
90098-66114	BKR5EIX-11	
90098-66115	BCPR5EIX-11	
90098-66116	BPR5EIX-11	
90098-70001	BP6ES-11	
90098-70002	BUR6EA-11	
90098-70003	BPR6ES-11	13
90098-70004	BPR6ES-11	13
90098-70005	BKR6E-11	14



TOYOTA	→ NGK	V-Line
90098-70007	BP6ES-11	
90098-70008	BPR6EFS-15	
90098-70023	CR6HSA	
90098-70024	BR6HS	
90098-70025	BR6S	
90098-70026	BP6S	
90098-70027	AR6FS	
90098-70030	BPM6A	
90098-70031	BPR6EY-11	10
90098-70032	BPR6EIX	
90098-70033	BPR6EIX	
90098-70034	BCPR6EY-11	
90098-70036	B6EVX	
90098-70038	BCPR6EIX-11	
90098-70039	BCPR6EIX-11	
90098-70040	BKR6E-11	14
90098-70041	ZFR6A-11	
90098-70043	BP6ES	4
90098-70044	ZFR6A-11	
90098-70046	BCPR6EIX-11	
90098-70047	BKR6E-11	14
90098-70048	BPR6EKN	
90098-70049	BPR6EKB-L	
90098-70050	BPR6EIX-11	
90098-70051	DCPR6E	
90098-70053	BKR6E	28
90098-70054	BKR6EIX-11	
90098-70055	BPR6EFS-15	
90098-70056	BKR6EYA-11	
90098-70058	BPR6ES	2
90098-70059	BKR6E-N-11	
90098-70060	PFR6G-11	
90098-70064	PFR6J-11	
90098-70065	ZFR6J-11	
90098-70066	ZFR6F-11	
90098-70067	BCPR6EKD	
90098-70069	BPR6EKB	
90098-70070	PFR6B-11	
90098-70071	BKR6EYA	
90098-70074	ZFR6G	
90098-70077	BKR6EIX-11	
90098-70080	PZFR6F-11	
90098-70081	PZFR6F	
90098-70082	BCPR6E	12
90098-70085	BUR6ET	1
90098-70086	PFR6J	
90098-70105	BPR6EKN	
90098-70106	BPR6HS-10	
90098-70108	PGR6A-11	
90098-70114	BKR6EIX-11	
90098-70115	BCPR6EIX-11	
90098-70116	BPR6EIX-11	

TOYOTA	→ NGK	V-Line
90098-72019	DPR7Z	
90098-72021	DPR7EA-9	
90098-72023	CR7HSA	
90098-72024	BR7HS	
90098-72030	BPM7A	
90098-72036	BR7EIX	
90098-72042	DCP7E	
90098-72047	BKR7E-11	
90098-72051	DCPR7E	
90098-72052	DCPR7EIX	
90098-72067	BCPR7EKD	
90098-72068	BCPR6ED	
90098-72070	PFR7B-11	
90098-72078	BK7EK-N-11	
90098-72116	BPR7EIX	
90098-74013	B8EG	
90098-74014	B8HS-10	
90098-74019	DP8Z	
90098-74021	DPR7EA-9	
90098-74024	BR8HS	
90098-74036	BR8EIX	
90098-74037	DR8EIX	
90098-74042	DP8EA-9	
90098-74051	DCPR8E	
90098-74052	DCPR8EIX	
90098-77013	B9EG	
90098-77014	B9HS-10	
90098-77019	DPR9Z	
90098-77021	DPR7EA-9	
90098-77024	BR9HS	
90098-77036	BR9EIX	
90098-77037	DR9EIX	
90098-77063	BR9HS-10	
90098-77088	C9E	
90098-77102	JR9B	
90098-77111	CR9EHIX-9	
90098-79036	BR10EIX	
90098-79037	DR9EIX	
90098-81036	BR10EIX	
90098-81089	CR10EK	
90098-99201	BCPR6EP-11	
90098-99202	BCPR5EIX-11	
90098-99203	BPR5EP-11	
90098-99204	BCPR6EP-N-8	
90098-99205	BKR6EP-11	
90098-99206	BKR6EP-N-8	
90098-99207	BKR5EP-11	
90098-99208	BKR6EKP-11	
90919-01051	BPR5ES	6
90919-01055	BP-2E	
90919-01056	BP4EY	
90919-01059	BP5EY	



TOYOTA	→ NGK	V-Line
90919-01061	BP5EY	
90919-01063	BPR6EK-A	
90919-01064	BPR5EY	9
90919-01065	BPR5EY	9
90919-01073	B5ES	
90919-01083	BP6EY	
90919-01084	BPR6EY	
90919-01085	BP4EY-11	
90919-01087	BP5EK-A	
90919-01088	BPR6EK-A	
90919-01089	BPR6EK-A	
90919-01091	BPR5EY	9
90919-01092	BPR6EK-A	
90919-01094	BP5EY-11	
90919-01095	BPR5EIX-11	
90919-01096	BPR5EIX-11	
90919-01097	BPR6EK-A	
90919-01098	BPR6EY	
90919-01099	BP4EY	
90919-01100	BP5EFS	
90919-01101	BP5EY	
90919-01102	BPR5EY	9
90919-01103	BPR4EY	
90919-01104	BPR5EY-11	
90919-01108	BPR4EY-11	
90919-01109	BPR4EY-11	
90919-01113	BRE527Y-11	
90919-01114	BRE527Y-11	
90919-01115	BPR5EP-11	
90919-01116	BPR5EP-11	
90919-01117	BE529Y-11	
90919-01118	BE529Y-11	
90919-01119	BRE529Y	
90919-01120	BRE529Y	
90919-01121	BCPR5EIX-11	
90919-01122	BCPR5EIX-11	
90919-01123	BRE529Y-11	
90919-01125	BPR6EY-11	10
90919-01126	BPR6EY-11	10
90919-01127	BCPR6EP-11	
90919-01128	BCPR6EP-11	
90919-01129	BCPR5EY-11	
90919-01130	BCPR5EY-11	
90919-01131	BCPR6EY-11	
90919-01132	BCPR6EY-11	
90919-01133	BPR5EP-11	
90919-01134	BPR5EP-11	
90919-01135	BCPR6EIX-11	
90919-01136	BCPR6EIX-11	
90919-01138	BP6EY	
90919-01139	BP6EY-11	
90919-01143	BPR5EP-11	

TOYOTA	→ NGK	V-Line
90919-01144	BPR5EP-11	
90919-01145	BCPR6EP-N-8	
90919-01146	BCPR6EP-N-8	
90919-01147	BPR6EP-8	
90919-01148	BPR6EP-8	
90919-01149	BCPR6EY	
90919-01150	BCPR6EY	
90919-01151	BCPR5EP-8	
90919-01152	BCPR5EP-8	
90919-01153	BCPR5EY-11	
90919-01154	BCPR5EY	
90919-01155	BCRE527Y	
90919-01156	BCRE527Y	
90919-01157	BCPR6EIX-11	
90919-01158	BCPR5EIX-11	
90919-01159	BCPR5EY-11	
90919-01162	BCPR6EP-8	
90919-01164	BKR5EYA-11	39
90919-01165	BKR5EYA-11	39
90919-01166	BKR6EYA-11	
90919-01167	BKR6EYA	
90919-01168	BKR5EP-11	
90919-01169	BKR5EP-11	
90919-01170	BCPR4EY-11	
90919-01172	BKR6EP-N-8	
90919-01173	BKR6EP-N-8	
90919-01176	BKR5EYA	
90919-01177	BKR5EYA	
90919-01178	BKR6EP-11	
90919-01179	BKR6EP-11	
90919-01180	BKR6EP-8	
90919-01181	BKR6EP-8	
90919-01182	BCPR6EIX-11	
90919-01184	BKR6EY-11	
90919-01185	BKR6EYA-11	
90919-01187	BKR6EP-13	
90919-01188	BKR6EP-13	
90919-01191	ILFR6T11	
90919-01192	BKR5EKB-11	
90919-01193	BKR5EKB-11	
90919-01194	BKR6EKP-11	
90919-01195	BKR6EKP-11	
90919-01196	BKR5EKP-11	
90919-01197	BKR5EKP-11	
90919-01198	BKR6EKB-11	
90919-01201	BKR5EKP-13	
90919-01202	BKR6EKB-11	
90919-01208	BKR6EPA-8	
90919-01210	IFR6T11	
90919-01211	IFR6T11	
90919-01213	BKR6EPA-8	
90919-01218	IFR5T11	



TOYOTA	→ NGK	V-Line
90919-01220	BKR6EP-11	
90919-01221	HB6AIX-11P	
90919-01226	HB6BIX-11P	
90919-01230	HB6BIX-11P	
90919-01233	ILFR5T11	
90919-01234	ILFR5T11	
90919-01235	LFR6C-11	
90919-01236	LFR6C-11	
90919-01237	IFR6T11	
90919-01238	IFR6T11	
90919-01242	BKR5EYA-11	39
90919-01244	BKR5EYA	
90919-01245	BKR5EYA	
90919-01247	DILFR6D11	
90919-01249	DFH6B-11A	
90919-01253	ILKAR7B11	
90919-YZZAA	BCP5E	16
90919-YZZAB	BCP6E	17
90919-YZZAC	BKR6E-11	14
90919-YZZAD	BKR5EYA	
90919-YZZAE	BKR5EYA-11	39
90919-YZZAF	BKR6EYA	
90919-YZZAG	BKR6EYA-11	
90999-09006	BP5EY	
90999-09007	BP6EY	
99098-22695	BP7ES	

UNIPART, SUREFIRE	→ NGK	V-Line
GSP 30	B6S	
GSP 96 SZ	PFR6N-11	
GSP 130	B5ES	
GSP 131	BP5ES	8
GSP 141	BP5ES	8
GSP 151	BP6ES	4
GSP 160	B6ES	
GSP 163	BP6ES	4
GSP 171	BP6ES	4
GSP 181	BP7ES	
GSP 191	BP8ES	
GSP 244	BPR5ES	6
GSP 263	BPR6ES	2
GSP 264	BPR5ES	6
GSP 281	BPR7ES	19
GSP 331	BP5EFS	
GSP 351	BP5EFS	
GSP 361	BP6EFS	5
GSP 381	BP7EFS	
GSP 461	BPR6EFS	7
GSP 531	BP5HS	
GSP 540	B5HS	
GSP 541	BP6HS	18
GSP 550	B6HS	

UNIPART, SUREFIRE	→ NGK	V-Line
GSP 560	B7HS	
GSP 571	BP7HS	
GSP 634	BKR5ES	35
GSP 664	BKR6ES	28
GSP 665	BCP6ES	17
GSP 684	BCPR7ES	
GSP 685	BCP7ES	
GSP 761	BP6FS	
GSP 881	BPR6FS	
GSP 981	AP6FS	
GSP 2004	ZFR6F-11	
GSP 2007	BKR6ES	28
GSP 4154	AP6FS	
GSP 4266	B5HS	
GSP 4352	BP6ES	4
GSP 4356	BP6HS	18
GSP 4362	BP6ES	4
GSP 4366	BP6HS	18
GSP 4372	BP5ES	8
GSP 4376	BP5HS	
GSP 4382	BP5ES	8
GSP 4452	BPR7ES	19
GSP 4462	BPR6ES	2
GSP 4472	BPR5ES	6
GSP 4552	BCP7ES	
GSP 4562	BCP6ES	17
GSP 4563	BP6EFS	5
GSP 4573	BP5EFS	
GSP 4652	BCPR7ES	
GSP 4662	BKR6ES	28
GSP 4663	BPR6EFS	7
GSP 6356	BP6HS	18
GSP 6382	BP5ES	8
GSP 6452	BPR7ES	19
GSP 6462	BPR6ES	2
GSP 6468	BPR6ES-11	13
GSP 6472	BPR5ES	6
GSP 6651	PTR5A-13	25
GSP 6652	BKR6ES	28
GSP 6658	BCPR7ES-11	
GSP 6662	BKR6ES	28
GSP 6663	BPR6EFS	7
GSP 6668	BKR6ES-11	14
GSP 9652	PFR6J	
GSP 46515	PTR5A-13	25

VAUXHALL	→ NGK	V-Line
12 14 527	PLFR6C-10G	
44 13 288	PFR6G-9	
48 11 581	ILTR5D	
59 58 780	BCP5EVX	



<b>VAUXHALL</b>	<b>→ NGK</b>	<b>V-Line</b>
93 99 866	PFR6H-10	
12 620 540	ILTR5D	
12 787 099	PFR6T-10G	
12 788 884	PLFR6C-10G	
30 520 467	BCPR6ES-11	11
32 000 330	BCPR7ES-11	
55 564 748	DILFR7B10G	
55 564 763	ZFR6BP-G	
91 132 006	BKR5EK	23
93 161 199	PFR6G-9	
93 176 801	ZFR5F	
<b>VOLVO</b>	<b>→ NGK</b>	<b>V-Line</b>
1150 278	IFR6B11	
1367 528	BPR6ES	2
1367 529	BPR6ES	2
22401 AA670	IFR6B11	
2707 46	BPR6ES	2
2712 39	IZFR6B	
2716 03	BKR6E	28
2717 27	BKR6E	28
3063 7308	PFR6B	
3063 7308 791	PFR6B	
3063 7308 887	PFR6B	
3063 7385	LFR6D	
3063 7385 496 A	LFR6D	
3065 0843	LFR6D	
3071 3859	LFR6D	
3073 1383	IFR6B11	
3073 1425	TR5B-13	
3073 1878	TR6AP-13	
3075 1468 889	ILFR6B	
3075 1469	LFR6D	
3075 1805	ILFR6B	
3075 1806	ILFR6B	
3075 8130	ILTR6G8G	
3077 7349	TR6AP-13	
3121 6183	ILFR6B	
3121 6184	ILFR6B	
3121 6297	ITR6F13	
3121 6525	ITR6F13	
3121 6674	ILFR6K8	
3127 2399	ILFR6K8	
3133 0450	ILZTR6A8G	
3517 980	BKR6ES	28
3650 843	LFR6D	
8642 660	BKR6ETUC	
8642 661	BKR6EQUA	
8670 058	BKR6EIX	
8687 990 H 939	IFR6B11	
8692 070	PFR6B	

<b>VOLVO</b>	<b>→ NGK</b>	<b>V-Line</b>
8692 071	PFR6B	
8692 072	PFR6B	
8694 749	ITR6F13	
9146 775	BKR6ETUC	
9146 7759 01	BKR6EQUA	
9146 7759 07	BKR6EQUA	
<b>VW Group</b>	<b>→ NGK</b>	<b>V-Line</b>
03C 905 601 A	PZFR6R8EG	
03C 905 601 B	SIZFR6B8EG	
03F 905 600 A	IZFR6P7	
06H 905 601 A	PFR7S8EG	
101 000 000 AB	BP6ESZ	
101 000 001 AB	BUR6ET	1
101 000 001 AC	BUR6ET	1
101 000 001 AD	BP5ET-10	
101 000 001 AE	BP5ET	
101 000 002 AB	BP6ESZ	
101 000 003 AA	BCP7ET	
101 000 004 AA	BCP7ET	
101 000 005 AA	BUR6ET	1
101 000 005 AB	BUR6ET	1
101 000 005 AC	BP7ET	
101 000 005 AD	BP5ET-10	
101 000 005 AE	BP5ET	
101 000 005 AF	BP5ET	
101 000 006 AB	BP6ESZ	
101 000 006 AC	BP6ESZ	
101 000 007 AA	BUR6ET	1
101 000 007 AB	BUR6ET	1
101 000 007 AC	BP5ET-10	
101 000 007 AD	BUR6ET	1
101 000 016 AA	PFR7B	
101 000 016 AB	PFR6Q	37
101 000 017 AA	BCP7ET	
101 000 026 AA	BUR5ET	22
101 000 026 AB	BUR6ET	1
101 000 027 AA	BUR6ET	1
101 000 027 AB	BP5ET	
101 000 027 AC	BP5ET-10	
101 000 028 AA	BCP7ET	
101 000 029 AA	BU6EFSZ	
101 000 029 AB	BUR6EFSZ	
101 000 033 AA	BKUR6ET-10	24
101 000 033 AB	BKUR7ET	
101 000 033 AC	BKUR5ET	29
101 000 033 AF	BKUR6ET	27
101 000 034 AA	BP6ESZ	
101 000 035 AA	BKR5EKU	
101 000 035 AB	BKR5EKU	
101 000 035 AE	BKR7EKU	
101 000 035 AF	BKR7EKU	





VW Group	→ NGK	V-Line
101 000 035 AH	BKR5EKUP	
101 000 035 HJ	BKR6EKUB	
101 000 036 AA	BUR6ET	1
101 000 036 AB	BUR5ET	22
101 000 036 AC	BUR5ET-10	21
101 000 038 AA	BPR5EKU	
101 000 038 AB	BPR5EKU	
101 000 039 AA	BPR5EKU	
101 000 039 AB	BPR5EKU	
101 000 040 AC	BUR5ET	22
101 000 040 AD	BUR6ET	1
101 000 040 AE	BUR5ET-10	21
101 000 041 AC	BKUR6ET-10	24
101 000 041 AD	BKUR6ET	27
101 000 041 AE	BKUR7ET	
101 000 047 AA	BP5ES-A	
101 000 047 AB	PGR6D	
101 000 048 AA	BP5HS	
101 000 049 AD	BKR6ETA-10	
101 000 050 AA	BUR5ET	22
101 000 050 AB	BUR5ET-10	21
101 000 050 AC	BUR6ET	1
101 000 051 AA	BKUR6ET-10	24
101 000 051 AB	BKUR7ET	
101 000 052 AA	BUR6EFSZ	
101 000 055 AA	BKR6EK	20
101 000 062 AB	PZFR5D-11	34
101 000 063 AA	PFR6Q	37
101 000 063 AC	PFR7Q	
101 000 065 AA	BKR6ETA-10	
101 905 600	PZFR5J-11	
101 905 600 A	PZFR6J-11	
101 905 600 R1	PZFR5J-11	
101 905 601	PZFR5D-11	34
101 905 601 F	ZFR6T-11G	
101 905 602	KR8BI	
101 905 606	IZKR7B	
101 905 606 A	IZKR7B	
101 905 607	BKR6EKUE	
101 905 611	PFR6U-11G	
101 905 611 A	PFR6X-11	
101 905 611 C	PFR7G	
101 905 611 G	PFR8S8EG	
101 905 615 A	BKR6EQUA	
101 905 616	BKR6EQUA	
101 905 617 C	ZFR6T-11G	
101 905 618 A	ZFR6T-11G	
101 905 621	PFR7W-T	
101 905 621 B	PFR6W-TG	
101 905 621 C	PFR7W-TG	
101 905 622	ILZKR7A	
101 905 622 A	ILZKR8A	

VW Group	→ NGK	V-Line
101 905 626	PZFR6R	
101 905 626 A	SIZFR6A6D	
101 905 631 G	PFR8S8EG	
101 905 631 H	PFR7S8EG	
400 905 619	PFR7G	
410 905 619	KR8BI	
N 017 8011	B5HS	
XL	→ NGK	V-Line
C6RTC	DR6HS	
D7RTC	DR7EA	
DK7RTC	DCPR7E	
DK7TC	DCP7E	
E4C	B-4H	
E4C-10	B-4H-10	
E4TC-10	BP4HS-10	
E58C	B5HS	
E5RTC	BPR5HS	
E5TC	BP5HS	
E5TC-10	BP5HS-10	
E6C	B6HS	
E6C-10	B6HS-10	
E6TC-10	BP6HS-10	
E7C	B7HS	
E7C-10	B7HS-10	
E8C-10	B8HS-10	
E8RC-10	BR8HS-10	
E9C-10	B9HS-10	
E9RC	BR9HS	
EL4C	B-4L	
F2TC	BP-2E	
F4TC-13	BPR4ES-13	
F5C	B5ES	
F5C-11	B5ES	
F5TC-13	BP5ES-13	
F5TJC	BP5ET	
F5TKC	BP5EK-A	
F6C-11	BR6ES	
F6RTC	BPR6ES	2
F6RTC-13	BPR6ES-13	
F6TC-13	BP6ES-13	
F6TJC	BP6ET	
F6TKC	BPR6EK-A	
F7C-11	B7ES-11	
F7TC-11	BP7ES-11	
F7TJC	BP7ET	
F8C-11	B8ES	
F8JC	BR8ET	
F8RC	BR8ES	
F8RJC	BR8ET	
G4C	B-4	





<b>ALFA ROMEO =&gt; FIAT Group</b>		
<b>AMG =&gt; MERCEDES</b>		
<b>AUDI =&gt; VW Group</b>		
<b>BENTLEY =&gt; VW Group</b>		
<b>BERU</b>	<b>→ NGK</b>	<b>D-Power</b>
105 MJ	Y-403-1	
105 MN	Y-208T	
106 MJ	Y-403-1	
107 MJ	Y-810	
108 MJ	Y-810	
112 M	Y-302	
137 MJ	Y-403T	
141 MJ	Y-207T	
151 MJ	Y-208T	
155 MJ	Y-404	
161 MJ	Y-208T	
162 MJ	Y-207T	
170 MJ	Y-811	
171 MJ	Y-810	
601 MJ	Y-918J	2
602 MJ	Y-208T	
603 MJ	Y-924J	1
609 MJ	Y-924J	1
613 MJ	Y-924J	1
624 MJ	Y-924J	1
631 MJ	Y-907R	
633 MJ	Y-924J	1
636 MJ	Y-924J	1
642 MJ	Y-924J	1
657 MJ	Y-909R	
661 MJ	Y-910J	3
663 MJ	Y-924J	1
666 MJ	Y-910J	3
673 MJ	Y-115T1	
678 MJ	Y-128T	
685 MJ	Y-117RS	
688 MJ	Y-118T1	
689 MJ	Y-204TS1	
705 MJ	Y-107R	
719 MJ	Y-924J	1
730 MJ	Y-739R	
749 MJ	Y-306R	
783 MJ	Y-729U	34
844 MJ	Y-933J	25
852 MJ	Y-913J	15
853 MJ	Y-712RS	
854 MJ	Y-712RS	
855 MJ	Y-732J	4
857 MJ	Y-918J	2

<b>BERU</b>	<b>→ NGK</b>	<b>D-Power</b>
858 MJ	Y-916J	6
860 MJ	Y-930U	30
880 MJ	Y-157R	
886 MJ	Y-146R	
887 MJ	Y-181T	
888 MJ	Y-204RS	
889 MJ	Y-112M1	
890 MJ	Y-162R1	
892 MJ	Y-112R1	
894 MJ	Y-118R	
895 MJ	Y-197R	
896 MJ	Y-168R	
897 MJ	Y-147T	
898 MJ	Y-115R1	
905 MJ	Y-730U	17
908 MJ	Y-924J	1
909 MJ	Y-924J	1
912 MJ	Y-503J	10
917 MJ	Y-924J	1
920 MJ	Y-705RS	
921 MJ	Y-707RS	
922 MJ	Y-757RS	
925 MJ	Y-926U	
927 MJ	Y-910J	3
944 MJ	Y-604J	
945 MJ	Y-307R	
946 MJ	Y-710J	
947 MJ	Y-711J	28
948 MJ	Y-925J	16
950 MJ	Y-732J	4
954 MJ	Y-924J	1
959 MJ	Y-933J	25
961 MJ	Y-929U	41
963 MJ	Y-506J	7
964 MJ	Y-738U	
968 MJ	Y-715R	
969 MJ	Y-197T	
970 MJ	Y-928U	29
991 MJ	Y-927J	19
999 MJ	Y-740U	22
GE 100	Y-607AS	50
GE 101	YE14	48
GE 102	Y-547AS	47
GE 105	Y8002AS	51
GE 108	Y-609AS	49
GE 110	Y1035AS	77
GE 111	Y1036AS	
GE 112	Y9004AS	
GE 114	Y9003AS	78
GE 115	Y-609AS	49
GE 118	Y1039AS	80
GN 003	Y-745U	11



BERU	→ NGK	D-Power
GN 005	Y-701J	39
GN 007	Y-741U	20
GN 008	Y-501U	31
GN 010	Y-746J	38
GN 012	Y-502R	
GN 013	Y-924J	1
GN 015	Y-543J	46
GN 016	Y-503J	10
GN 017	Y-747U	26
GN 018	Y-732J	4
GN 019	Y-516J	12
GN 022	Y-937J	5
GN 024	Y-507J	32
GN 026	Y-517J	66
GN 027	Y-504J	24
GN 030	Y-939J	43
GN 033	Y-523J	37
GN 035	Y-749J	
GN 037	Y8005J	64
GN 039	Y-530J	
GN 041	Y-534J	36
GN 042	Y-542J	45
GN 043	Y-532J	
GN 044	Y-755RS	
GN 045	YE12	
GN 046	Y-741U	20
GN 047	YE04	40
GN 053	Y8003J	62
GN 054	Y1005J	56
GN 056	YE05	73
GN 057	Y-508J	
GN 058	YE13	
GN 059	YE07	
GN 060	Y-536J	81
GN 062	Y-527J	67
GN 063	YE08	
GN 064	Y-529J	
GN 065	Y-531J	44
GN 072	CZ258	
GN 095	Y1001J1	
GN 103	Y-603J	60
GN 104	Y-541J	42
GN 107	Y-733J	13
GN 108	Y1012J	65
GN 109	Y-519J	61
GN 110	Y1013J	63
GN 853	Y-712RS	
GN 854	Y-712RS	
GN 855	Y-732J	4
GN 857	Y-918J	2
GN 858	Y-916J	6
GN 860	Y-930U	30

BERU	→ NGK	D-Power
GN 905	Y-730U	17
GN 908	Y-924J	1
GN 909	Y-924J	1
GN 912	Y-503J	10
GN 917	Y-924J	1
GN 925	Y-926U	
GN 927	Y-910J	3
GN 939	Y-548J	75
GN 944	Y-604J	
GN 948	Y-925J	16
GN 954	Y-924J	1
GN 959	Y-933J	25
GN 961	Y-929U	41
GN 963	Y-506J	7
GN 964	Y-738U	
GN 970	Y-928U	29
GN 985	Y-605J	
GN 991	Y-927J	19
GN 992	Y-748U	14
GN 993	Y-524J	27
GN 997	Y1038J	
GN 999	Y-740U	22
GV 105	Y-208T	
GV 106	Y-403-1	
GV 107	Y-810	
GV 108	Y-810	
GV 112	Y-302	
GV 137	Y-403T	
GV 155	Y-404	
GV 170	Y-811	
GV 602	Y-208T	
GV 603	Y-924J	1
GV 631	Y-907R	
GV 636	Y-924J	1
GV 642	Y-924J	1
GV 657	Y-909R	
GV 661	Y-910J	3
GV 663	Y-924J	1
GV 666	Y-910J	3
GV 673	Y-115T1	
GV 678	Y-128T	
GV 685	Y-117RS	
GV 688	Y-118T1	
GV 689	Y-204TS1	
GV 705	Y-107R	
GV 719	Y-924J	1
GV 730	Y-739R	
GV 749	Y-306R	
GV 783	Y-729U	34
GV 844	Y-933J	25
GV 852	Y-913J	15
GV 880	Y-157R	



BERU	→ NGK	D-Power
GV 886	Y-146R	
GV 887	Y-181T	
GV 888	Y-204RS	
GV 889	Y-112M1	
GV 890	Y-162R1	
GV 892	Y-112R1	
GV 894	Y-118R	
GV 895	Y-197R	
GV 896	Y-168R	
GV 897	Y-147T	
GV 898	Y-115R1	
GV 920	Y-705RS	
GV 921	Y-707RS	
GV 922	Y-757RS	
GV 945	Y-307R	
GV 946	Y-710J	
GV 947	Y-711J	28
GV 968	Y-715R	
GV 969	Y-197T	
0 100 220 103	Y-207T	
0 100 220 113	Y-204RS	
0 100 220 114	Y-112M1	
0 100 220 115	Y-112R1	
0 100 220 118	Y-705RS	
0 100 220 206	Y-403T	
0 100 221 101	Y-302	
0 100 221 102	Y-208T	
0 100 221 103	Y-208T	
0 100 221 105	Y-918J	2
0 100 221 106	Y-208T	
0 100 221 107	Y-924J	1
0 100 221 132	Y-907R	
0 100 221 133	Y-924J	1
0 100 221 135	Y-924J	1
0 100 221 141	Y-909R	
0 100 221 144	Y-910J	3
0 100 221 145	Y-924J	1
0 100 221 146	Y-910J	3
0 100 221 147	Y-115T1	
0 100 221 148	Y-128T	
0 100 221 149	Y-117RS	
0 100 221 151	Y-118T1	
0 100 221 152	Y-204TS1	
0 100 221 154	Y-107R	
0 100 221 163	Y-924J	1
0 100 221 170	Y-739R	
0 100 221 186	Y-306R	
0 100 221 206	Y-404	
0 100 221 209	Y-403-1	
0 100 221 301	Y-811	
0 100 222 101	Y-118R	
0 100 222 102	Y-168R	

BERU	→ NGK	D-Power
0 100 222 106	Y-508J	
0 100 222 301	Y-810	
0 100 222 302	Y-810	
0 100 226 129	Y-729U	34
0 100 226 163	Y-913J	15
0 100 226 164	Y-933J	25
0 100 226 170	Y-712RS	
0 100 226 171	Y-712RS	
0 100 226 173	Y-918J	2
0 100 226 180	Y-146R	
0 100 226 182	Y-147T	
0 100 226 183	Y-115R1	
0 100 226 184	Y-730U	17
0 100 226 185	Y-924J	1
0 100 226 186	Y-924J	1
0 100 226 188	Y-503J	10
0 100 226 189	Y-924J	1
0 100 226 194	Y-707RS	
0 100 226 198	Y-910J	3
0 100 226 206	Y-604J	
0 100 226 207	Y-710J	
0 100 226 208	Y-711J	28
0 100 226 209	Y-307R	
0 100 226 227	Y-732J	4
0 100 226 229	Y-924J	1
0 100 226 234	Y-916J	6
0 100 226 235	Y-925J	16
0 100 226 237	Y-933J	25
0 100 226 238	Y-740U	22
0 100 226 243	Y-715R	
0 100 226 245	Y-506J	7
0 100 226 246	Y-738U	
0 100 226 249	Y-928U	29
0 100 226 250	Y-929U	41
0 100 226 255	Y-605J	
0 100 226 258	Y-930U	30
0 100 226 299	Y-927J	19
0 100 226 300	Y-748U	14
0 100 226 312	Y1038J	
0 100 226 336	Y-701J	39
0 100 226 338	Y-501U	31
0 100 226 343	Y-741U	20
0 100 226 344	Y-504J	24
0 100 226 351	Y-517J	66
0 100 226 352	Y-530J	
0 100 226 354	Y-502R	
0 100 226 362	Y-507J	32
0 100 226 365	Y-746J	38
0 100 226 366	Y-924J	1
0 100 226 371	Y-503J	10
0 100 226 372	Y-747U	26
0 100 226 373	Y-732J	4





<b>BERU</b>	<b>→ NGK</b>	<b>D-Power</b>
0 100 226 375	Y-516J	12
0 100 226 379	Y-745U	11
0 100 226 381	Y-937J	5
0 100 226 384	Y-524J	27
0 100 226 385	Y-548J	75
0 100 226 391	Y-939J	43
0 100 226 392	Y-543J	46
0 100 226 417	Y-523J	37
0 100 226 422	Y-749J	
0 100 226 432	Y-926U	
0 100 226 436	Y-534J	36
0 100 226 475	Y-532J	
0 100 226 480	Y-542J	45
0 100 226 482	Y-741U	20
0 100 226 492	Y1005J	56
0 100 226 495	Y-603J	60
0 100 226 497	Y-541J	42
0 100 226 504	Y-732J	4
0 100 226 511	Y-733J	13
0 100 226 517	Y-536J	81
0 100 226 522	Y-527J	67
0 100 226 526	Y-529J	
0 100 226 527	Y-531J	44
0 100 226 538	Y1012J	65
0 100 226 568	Y1013J	63
0 100 226 577	Y1001J1	
0 100 230 101	Y-181T	
0 100 230 102	Y-162R1	
0 100 230 107	Y-755RS	
0 100 231 104	Y-157R	
0 100 231 107	Y-197R	
0 100 231 109	Y-757RS	
0 100 231 114	Y-197T	
0 100 266 002	Y-547AS	47
0 100 266 008	Y-607AS	50
0 100 266 009	YE14	48
0 100 266 011	Y8002AS	51
0 100 266 016	Y-609AS	49
0 100 266 031	Y9004AS	
0 100 266 032	Y1035AS	77
0 100 266 033	Y1036AS	
0 100 266 034	Y9003AS	78
0 100 266 037	Y1039AS	80
0 100 266 040	Y-609AS	49
0 100 276 003	Y8005J	64
0 100 276 004	YE04	40
0 100 276 005	YE12	
0 100 276 008	Y8003J	62
0 100 276 012	YE05	73
0 100 276 014	YE13	
0 100 276 015	YE07	
0 100 276 024	YE08	

<b>BERU</b>	<b>→ NGK</b>	<b>D-Power</b>
0 100 800 031	Y-519J	61
0 100 800 035	CZ258	
<b>BM3 (BULGARIA+VMZ) =&gt; BRISK</b>		
<b>BMW</b>		
12 23 1 288 245	Y-924J	1
12 23 2 241 389	Y-924J	1
12 23 2 248 059	Y-507J	32
12 23 7 786 869	Y-547AS	47
12 23 7 798 001	Y1039AS	80
<b>BOSCH</b>		
<b>→ NGK</b>		
<b>D-Power</b>		
GA 135	DG-237	
GA 1351	DG-237	
GLP 001	Y-924J	1
GLP 002	Y-918J	2
GLP 003	Y-732J	4
GLP 004	Y-503J	10
GLP 005	Y-924J	1
GLP 006	Y-916J	6
GLP 007	Y-534J	36
GLP 008	Y-745U	11
GLP 009	Y-506J	7
GLP 010	Y-910J	3
GLP 011	Y-516J	12
GLP 012	Y-937J	5
GLP 013	Y-504J	24
GLP 014	Y-730U	17
GLP 015	Y-924J	1
GLP 016	Y8003J	62
GLP 017	Y-925J	16
GLP 019	Y-748U	14
GLP 020	Y-927J	19
GLP 021	Y-929U	41
GLP 022	Y-745U	11
GLP 023	Y-741U	20
GLP 024	Y-524J	27
GLP 025	Y-930U	30
GLP 026	Y-928U	29
GLP 030	Y-523J	37
GLP 031	Y-501U	31
GLP 032	Y-747U	26
GLP 034	Y-115T1	
GLP 035	Y-603J	60
GLP 036	Y-933J	25
GLP 037	Y-913J	15
GLP 038	Y-701J	39
GLP 039	CY57	21
GLP 040	Y-507J	32
GLP 041	Y-739R	



<b>BOSCH</b>	<b>→ NGK</b>	<b>D-Power</b>
GLP 042	Y-118T1	
GLP 043	YE07	
GLP 045	Y-939J	43
GLP 046	Y-711J	28
GLP 047	Y-909R	
GLP 048	Y-729U	34
GLP 049	Y-712RS	
GLP 050	Y-607AS	50
GLP 051	Y-548J	75
GLP 054	Y-733J	13
GLP 057	Y-517J	66
GLP 059	YE04	40
GLP 063	Y-810	
GLP 066	Y1030J	70
GLP 070	Y-547AS	47
GLP 072	Y-710J	
GLP 074	Y-532J	
GLP 093	YE14	48
GLP 094	YE05	73
GLP 096	Y-306R	
GLP 098	Y-755RS	
GLP 101	Y-531J	44
GLP 102	Y-746J	38
GLP 103	Y-904M1	
GLP 105	CY52	
GLP 108	CY51	
GLP 109	Y1031J	71
GLP 111	Y1005J	56
GLP 115	YE12	
GLP 116	Y-118R	
GLP 117	Y-107R	
GLP 120	Y-307R	
GLP 121	Y-910J	3
GLP 124	Y-146R	
GLP 125	Y-103	
GLP 127	Y-705RS	
GLP 128	Y-403T	
GLP 130	Y-302	
GLP 132	Y-197T	
GLP 136	Y-197R	
GLP 137	Y1007J	59
GLP 138	Y-162R1	
GLP 142	Y-147T	
GLP 144	Y8008AS	74
GLP 152	Y-178T	
GLP 155	Y-112T	
GLP 156	Y1006J	
GLP 159	Y-128T	
GLP 167	Y-117RS	
GLP 169	Y-157R	
GLP 171	Y-404	
GLP 172	Y-403-1	

<b>BOSCH</b>	<b>→ NGK</b>	<b>D-Power</b>
GLP 179	Y8009AS	
GLP 185	Y-181T	
GLP 186	Y-907R	
GLP 196	Y9003AS	78
GLP 202	Y8002AS	51
GLP 210	YE08	
GSA 91	Y-810	
GSA 101	Y-810	
KEGA 121	DG-237	
KEGA 1211	DG-237	
KEGSA 1010	Y-811	
0 250 001 008	DG-237	
0 250 001 012	DG-237	
0 250 001 016	DG-237	
0 250 001 416	DG-237	
0 250 200 013	Y-811	
0 250 200 014	Y-810	
0 250 200 020	Y-810	
0 250 200 035	Y-302	
0 250 200 037	Y-404	
0 250 200 046	Y-403-1	
0 250 200 049	Y-207T	
0 250 200 051	Y-403T	
0 250 200 052	Y-207T	
0 250 200 053	Y-909R	
0 250 200 054	Y-208T	
0 250 200 055	Y-810	
0 250 200 056	Y-208T	
0 250 200 058	Y-208T	
0 250 200 059	Y-208T	
0 250 200 060	Y-208T	
0 250 200 063	Y-207T	
0 250 200 065	Y-208T	
0 250 200 068	Y-208T	
0 250 200 069	Y-924J	1
0 250 200 420	Y-810	
0 250 200 451	Y-403T	
0 250 200 454	Y-208T	
0 250 200 456	Y-208T	
0 250 200 465	Y-208T	
0 250 200 468	Y-208T	
0 250 201 001	Y-924J	1
0 250 201 004	Y-918J	2
0 250 201 005	Y-924J	1
0 250 201 006	Y-924J	1
0 250 201 008	Y-924J	1
0 250 201 009	Y-924J	1
0 250 201 011	Y-918J	2
0 250 201 012	Y-909R	
0 250 201 013	Y-924J	1
0 250 201 015	Y-918J	2
0 250 201 017	Y-907R	



<b>BOSCH</b>	<b>→ NGK</b>	<b>D-Power</b>
0 250 201 019	Y-924J	1
0 250 201 021	Y-918J	2
0 250 201 026	Y-916J	6
0 250 201 027	Y-924J	1
0 250 201 029	Y-913J	15
0 250 201 032	Y-918J	2
0 250 201 033	Y-924J	1
0 250 201 034	Y-909R	
0 250 201 035	Y-930U	30
0 250 201 038	Y-925J	16
0 250 201 039	Y-924J	1
0 250 201 041	Y-916J	6
0 250 201 042	Y-924J	1
0 250 201 043	Y-913J	15
0 250 201 049	Y-937J	5
0 250 201 050	Y-933J	25
0 250 201 053	Y-939J	43
0 250 201 405	Y-924J	1
0 250 201 415	Y-918J	2
0 250 202 001	Y-910J	3
0 250 202 002	Y-739R	
0 250 202 003	Y-115T1	
0 250 202 004	Y-128T	
0 250 202 005	Y-117RS	
0 250 202 006	Y-118T1	
0 250 202 007	Y-107R	
0 250 202 008	Y-306R	
0 250 202 009	Y-732J	4
0 250 202 013	Y-204RS	
0 250 202 015	Y-103	
0 250 202 017	Y-112R1	
0 250 202 018	Y-910J	3
0 250 202 020	Y-503J	10
0 250 202 022	Y-732J	4
0 250 202 023	Y-741U	20
0 250 202 024	Y-927J	19
0 250 202 025	Y-730U	17
0 250 202 026	Y-929U	41
0 250 202 028	Y-747U	26
0 250 202 029	Y-745U	11
0 250 202 032	Y-504J	24
0 250 202 033	Y-910J	3
0 250 202 034	Y-928U	29
0 250 202 035	Y-506J	7
0 250 202 036	Y-534J	36
0 250 202 038	Y1031J	71
0 250 202 040	Y-729U	34
0 250 202 041	Y-746J	38
0 250 202 042	Y-748U	14
0 250 202 043	Y-523J	37
0 250 202 051	Y-146R	
0 250 202 054	Y-118R	

<b>BOSCH</b>	<b>→ NGK</b>	<b>D-Power</b>
0 250 202 058	Y-147T	
0 250 202 064	Y-755RS	
0 250 202 065	Y-904M1	
0 250 202 069	Y-162R1	
0 250 202 071	Y-181T	
0 250 202 076	Y-197R	
0 250 202 077	Y-705RS	
0 250 202 085	Y-710J	
0 250 202 086	Y-307R	
0 250 202 087	Y-711J	28
0 250 202 089	Y-701J	39
0 250 202 090	Y1006J	
0 250 202 092	Y-733J	13
0 250 202 093	Y-712RS	
0 250 202 094	Y-115T1	
0 250 202 095	Y-532J	
0 250 202 096	Y-118T1	
0 250 202 097	Y-197T	
0 250 202 102	Y-501U	31
0 250 202 103	Y-507J	32
0 250 202 107	Y-157R	
0 250 202 110	Y-112T	
0 250 202 119	Y-178T	
0 250 202 124	Y1007J	59
0 250 202 125	Y-531J	44
0 250 202 128	Y-517J	66
0 250 202 129	Y-516J	12
0 250 202 130	Y-548J	75
0 250 202 131	Y-524J	27
0 250 202 132	Y1030J	70
0 250 202 135	Y1005J	56
0 250 202 141	Y-745U	11
0 250 202 142	Y-745U	11
0 250 203 001	YE07	
0 250 203 002	Y8003J	62
0 250 203 004	YE12	
0 250 203 012	YE08	
0 250 204 001	YE04	40
0 250 204 002	YE05	73
0 250 312 001	CY51	
0 250 312 002	CY52	
0 250 312 003	Y-603J	60
0 250 312 007	CY57	21
0 250 402 002	Y-547AS	47
0 250 402 005	Y-607AS	50
0 250 403 001	Y8008AS	74
0 250 403 002	YE14	48
0 250 403 008	Y8002AS	51
0 250 403 010	Y8009AS	
0 250 403 011	Y9003AS	78



<b>BRISK</b>	<b>→ NGK</b>	<b>D-Power</b>
21 N 21	Y-208T	
21 N 22	Y-208T	
21 N 51	Y-909R	
21 R 01	Y-918J	2
21 R 02	Y-907R	
21 R 06	Y-918J	2
21 R 21	Y-924J	1
21 R 22	Y-924J	1
21 R 23	Y-924J	1
21 R 26	Y-913J	15
21 R 51	Y-909R	
21 R 71	Y-910J	3
41 N 71	Y-403T	
<b>BUICK =&gt; GM</b>		
<b>CADILLAC =&gt; GM</b>		
<b>CHAMPION</b>	<b>→ NGK</b>	<b>D-Power</b>
AG 32	Y-302	
AG 44	Y-811	
CH 32	Y-302	
CH 44	Y-811	
CH 60	Y-207T	
CH 61	DG-237	
CH 63	Y-208T	
CH 64	Y-404	
CH 65	Y-810	
CH 66	Y-403T	
CH 68	Y-523J	37
CH 69	Y-918J	2
CH 70	Y-909R	
CH 78	Y-208T	
CH 79	Y-907R	
CH 88	Y-924J	1
CH 90	Y-739R	
CH 94	Y-115T1	
CH 95	Y-146R	
CH 96	Y-204RS	
CH 97	Y-107R	
CH 98	Y-117RS	
CH 99	Y-117SS	
CH 101	Y-115R1	
CH 102	Y-112M1	
CH 103	Y-118T1	
CH 104	Y-197R	
CH 105	Y-204SS	
CH 121	Y-118T1	
CH 137	Y-924J	1
CH 147	Y-910J	3
CH 154	Y-715R	

<b>CHAMPION</b>	<b>→ NGK</b>	<b>D-Power</b>
CH 158	Y-711J	28
CH 159	Y-924J	1
CH 160	Y-918J	2
CH 161	Y-755RS	
CH 162	Y-707RS	
CH 163	Y-924J	1
CH 166	Y-747U	26
CH 167	Y-928U	29
CH 169	Y-730U	17
CH 170	Y-504J	24
CH 171	Y-732J	4
CH 172	Y-740U	22
CH 173	Y-913J	15
CH 174	Y-924J	1
CH 175	Y-930U	30
CH 176	Y-916J	6
CH 177	Y-925J	16
CH 178	Y-729U	34
CH 179	Y-933J	25
CH 181	Y-741U	20
CH 184	Y-732J	4
CH 185	Y-503J	10
CH 189	Y-924J	1
CH 196	Y-524J	27
CH 203	Y-507J	32
CH 204	Y-929U	41
CH 205	Y-937J	5
CH 206	Y-927J	19
CH 207	Y-748U	14
CH 208	Y-738U	
CH 215	Y-501U	31
CH 216	Y-502R	
CH 217	Y-506J	7
CH 218	Y-745U	11
CH 219	Y-746J	38
CH 221	Y-115T1	
CH 223	Y8003J	62
CH 224	YE07	
CH 263	Y1007J	59
CH 268	Y1005J	56
CH 600	CY52	
CH 601	Y-603J	60
CH 602	CY57	21
<b>CHEVROLET =&gt; GM</b>		
<b>CHRYSLER</b>	<b>→ NGK</b>	<b>D-Power</b>
05066 840 AA	Y1031J	71
5175 756 AA	Y8002AS	51



<b>CITROËN =&gt; PSA</b>		
<b>DACIA =&gt; RENAULT</b>		
<b>DAEWOO =&gt; GM</b>		
<b>DAIHATSU</b>	<b>→ NGK</b>	<b>D-Power</b>
19850-54050-000	Y-118R	
19850-54071-000	Y-146R	
19850-54090-000	Y-715R	
19850-56010-000	Y-178	
19850-56012-000	Y-178T	
19850-58030-000	Y-128T	
19850-58040-000	Y-178T	
19850-64010-000	Y-146R	
19850-64020-000	Y-703R	
19850-68010-000	Y-147T	
19850-68040-000	Y-178T	
19850-68060-000	Y-197R	
19850-87303-000	Y-108	
19850-87309-000	Y-128T	
19850-87701-000	Y-146R	
19850-87702-000	Y-703R	
19850-87801	Y-706R	
<b>DENSO</b>	<b>→ NGK</b>	<b>D-Power</b>
DG-001	Y-924J	1
DG-002	Y-204TS1	
DG-003	Y-503J	10
DG-004	Y-910J	3
DG-005	Y-732J	4
DG-006	Y-913J	15
DG-007	Y-937J	5
DG-008	Y-506J	7
DG-009	Y-927J	19
DG-010	Y-916J	6
DG-101	Y-740U	22
DG-102	Y-928U	29
DG-103	Y-933J	25
DG-105	Y-115T1	
DG-106	Y-925J	16
DG-110	Y-929U	41
DG-111	Y-502R	
DG-113	YE04	40
DG-115	Y-729U	34
DG-116	Y-504J	24
DG-117	Y-925J	16
DG-118	Y-748U	14
DG-119	Y-930U	30
DG-120	Y-707RS	
DG-123	Y-907R	
DG-124	Y-710J	

<b>DENSO</b>	<b>→ NGK</b>	<b>D-Power</b>
DG-126	Y-517J	66
DG-127	Y-747U	26
DG-137	Y-712RS	
DG-144	Y-732J	4
DG-145	Y-507J	32
DG-146	Y-701J	39
DG-155	Y-746J	38
DG-159	Y-307R	
DG-161	Y-924J	1
DG-170	YE07	
DG-171	Y8003J	62
DG-202	Y-909R	
DG-211	Y-715R	
DG-214	Y-532J	
DG-215	Y-118R	
DG-216	Y-703R	
DG-221	Y-118T1	
DG-222	Y-197R	
DG-223	Y-146R	
DG-226	Y-178	
DG-227	Y-128	
DG-232	Y-147T	
DG-233	Y-197T	
DG-234	Y-128T	
DG-235	Y-178T	
DG-239	Y-168R	
DG-240	Y-542J	45
DG-245	Y-531J	44
DG-300	Y-603J	60
DG-301	CY57	21
DG-304	CY52	
067100-0160	DG-211	
067100-1042	Y-402-2	
067100-1043	Y-452-1	
067100-1070	Y-176	
067100-1071	Y-176	
067100-1090	Y-108	
067100-1120	Y-178	
067100-1130	Y-128	
067100-1161	Y-178T	
067100-1170	Y-128T	
067100-1171	Y-128T	
067100-1270	Y-118T1	
067100-1330	Y-147T	
067100-1340	Y-197T	
067100-1350	Y-128T	
067100-1360	Y-178T	
067100-1370	Y-118R	
067100-1380	Y-168R	
067100-1430	Y-146R	
067100-1460	Y-197R	
067100-1530	Y-146R	





DENSO	→ NGK	D-Power
067100-1630	Y-118T1	
067100-1690	Y-703R	
067100-1710	Y-715R	
067100-1860	Y-532J	

#### DODGE => CHRYSLER

#### FERRARI => FIAT Group

FIAT Group	→ NGK	D-Power
46 44 76 10	Y-928U	29
46 45 19 51	Y-747U	26
46 75 17 64	Y-939J	43
46 75 41 54	Y-534J	36
46 79 23 55	YE07	
46 79 23 59	YE07	
46 79 60 50	Y8003J	62
50 03 16 493	Y-502R	
50 03 51 992	Y8005J	64
55 18 78 63	YE07	
55 20 07 55	Y9003AS	78
55 20 08 17	Y1030J	70
55 21 00 51	Y9001AS	72
60 50 71 23	Y-909R	
60 81 22 92	Y-924J	1
60 81 46 13	Y-747U	26
71 71 90 15	Y-924J	1
76 32 58 7	Y-739R	
77 35 92 0	Y-924J	1
96 33 21 43 80	Y-924J	1
96 38 98 59 80	Y-504J	24
96 51 02 97 80	Y-504J	24
96 51 58 36	Y1005J	56
96 52 54 82 80	YE08	
96 59 27 92 80	Y-548J	75
98 46 24 92	Y-926U	

FORD	→ NGK	D-Power
11 48 105	YE04	40
13 13 809	Y1005J	56
14 27 905	YE08	
14 47 128	YE05	73
14 59 460	Y-548J	75
14 73 356	Y1005J	56
15 42 845	Y8003J	62
16 82 276	Y8001AS	58
40 25 139	Y-701J	39
2S6Q-6M090-AA	YE04	40
2S6Q-6M090-BA	YE05	73
2S6Q-6M090-BB	YE05	73
3M5Q-6M090-AB	Y1005J	56
3M5Q-6M090-AC	Y1005J	56

FORD	→ NGK	D-Power
6G9Q-6M090-AA	YE08	
7C16-6M090-AA	Y-548J	75
9S51-6M090-AA	Y8003J	62
AV6Q-6M090-BA	Y8001AS	58
BS51-6M090-AA	Y9001AS	72
XM341-2A342-BA	Y-701J	39

GM	→ NGK	D-Power
1 214 034	YE07	
4 805 511	Y8009AS	
93 178 411	YE07	
94 133 759	Y-904M1	
94 439 218	Y-306R	
96 440 144	Y8009AS	
97 080 554	Y-603J	60

HINO	→ NGK	D-Power
19110-1040	Y-176	
1985A-56010	Y-178	
1985A-56012	Y-178T	
1985A-56022	Y-128T	
1985A-68060	Y-197R	
63013-30010	Y-176	

HKT	→ NGK	D-Power
CP 01	CY51	
CP 02	CY52	
PD 99	Y-108	
PD 190	Y-146R	
PD 191	Y-703R	
PH 21	Y-176	
PI 40	Y-874-1	
PI 42	Y-104	
PI 44	Y-271-2	
PI 49	Y-904M1	
PI 50	Y-954M1	
PI 58	Y-710J	
PM 60	Y-172	
PM 61	Y-175-2	
PM 62	Y-102	
PM 63	Y-201	
PM 66	Y-180	
PM 71	Y-172	
PM 73	Y-274	
PM 75	Y-115T1	
PM 78	Y-971M	
PM 79	Y-114T	
PM 160	Y-274R	
PM 161	Y-115R1	
PN 81	Y-103	
PN 82	Y-252	



HKT	→ NGK	D-Power
PN 84	Y-202	
PN 85	Y-103-1	
PN 86	Y-103-2	
PN 87	Y-112T	
PN 88	Y-177-1	
PN 89	Y-204TS1	
PN 120	Y-181T	
PN 121	Y-204RS	
PN 122	Y-202-2	
PN 123	Y-112M1	
PN 124	Y-162R1	
PN 125	Y-272R1	
PN 126	Y-117RS	
PN 127	Y-117SS	
PN 128	Y-112R1	
PN 129	Y-204SS	
PN 131	Y-755RS	
PN 132	Y-705RS	
PN 134	Y-144RS	
PN 135	Y-707RS	
PN 136	Y-757RS	
PN 137	Y-955RS	
PN 138	Y-712RS	
PS 201	Y-103V	
PS 202	Y-106V	
PS 204	Y-106-1	
PS 206	YE01	
PS 207	Y-709R	
PS 208	Y-716RS	
PS 209	Y-119V	
PS 210	Y-702U	
PT 90	Y-402-2	
PT 93	Y-128	
PT 94	Y-178	
PT 100	Y-128T	
PT 101	Y-178T	
PT 103	Y-118T1	
PT 104	Y-128T	
PT 107	Y-146R	
PT 108	Y-197T	
PT 109	Y-178T	
PT 140	Y-118R	
PT 141	Y-197R	
PT 142	Y-168R	
PT 144	Y-118T1	
PT 145	Y-147T	
PT 147	Y-146R	
PT 150	Y-703R	
PT 151	Y-715R	
PZ 30	Y-107T	
PZ 31	Y-157R	
PZ 33	Y-107R	

HKT	→ NGK	D-Power
PZ 34	Y-122	
HONDA	→ NGK	D-Power
31800-706-000	YS-101	
HYUNDAI/KIA	→ NGK	D-Power
OK04S-18140-A	Y-721J	
OK054-18140	Y-701J	39
36710-27000	Y-749J	
36710-27010	Y-749J	
36710-2A100	Y-527J	67
36710-2A200	Y-527J	67
36710-2A700	CZ203	68
36710-2F000	CZ105	
36710-2F100	Y1003AS	
36710-42000	Y-722JS	
36710-42020	Y-722JS	
36710-42500	CY57	21
36710-42510	CY57	21
36710-4A000	Y-508J	
36710-4A100	Y-508J	
36710-4X900	Y-535J	
INFINITI => NISSAN		
ISUZU	→ NGK	D-Power
9417-5158	Y-904M1	
5-8610-1642-0	CZ261	
5-8610-1643-0	Y-712RS	
5-8610-1644-0	Y-707RS	
5-8611-5977-0	Y-757RS	
8-8440-2303-1	Y-711J	28
8-9413-5377-3	Y-954M1	
8-9417-5158-0	Y-904M1	
8-9417-5158-1	Y-904M1	
8-9417-5158-2	Y-904M1	
8-9422-1719-3	Y-954M1	
8-9431-9700-1	Y-710J	
8-9431-9700-2	Y-710J	
8-9431-9700-4	Y-710J	
8-9703-3761-0	Y-954M1	
8-9703-3761-1	Y-954M1	
8-9703-3761-2	Y-954M1	
8-9708-0554-0	Y-603J	60
8-9708-0554-1	Y-603J	60
8-9710-6549-1	Y-720U1	
8-9710-6549-4	Y-720U1	
8-9714-3674-1	Y1038J	
8-9801-3392-0	Y1001J1	
8-9817-4898-0	Y1001J1	



<b>ISUZU</b>	<b>→ NGK</b>	<b>D-Power</b>
9-8251-1945-0	Y-874-1	
9-8251-1978-0	Y-104	
9-8251-1978-1	Y-104	
9-8251-1994-0	Y-874-1	
9-8251-3928-2	Y-271-2	
<b>IVECO</b>	<b>→ NGK</b>	<b>D-Power</b>
500 351 992	Y8005J	64
<b>JEEP</b>	<b>→ NGK</b>	<b>D-Power</b>
050 66 840 AA	Y1031J	71
517 57 56 AA	Y8002AS	51
<b>KIA =&gt; HYUNDAI/KIA</b>		
<b>LAMBORGHINI =&gt; VW Group</b>		
<b>LANCIA =&gt; FIAT Group</b>		
<b>LAND ROVER</b>	<b>→ NGK</b>	<b>D-Power</b>
ERR 6066	Y-605J	
LR 001 302	YE08	
<b>LEXUS =&gt; TOYOTA</b>		
<b>LUCAS</b>	<b>→ NGK</b>	<b>D-Power</b>
DS 001	Y-924J	1
DS 002	Y-918J	2
DS 003	Y-924J	1
DS 006	Y-208T	
DS 101	DG-237	
HDS 217	Y-918J	2
HDS 220	Y-403T	
HDS 221	Y-208T	
HDS 227	Y-302	
HDS 230	Y-117RS	
HDS 231	Y-204RS	
HDS 232	Y-115T1	
HDS 233	Y-146R	
HDS 235	Y-118R	
HDS 236	Y-178	
HDS 237	Y-197T	
HDS 238	Y-178T	
HDS 239	Y-112M1	
HDS 240	Y-162R1	
HDS 241	Y-107R	
HDS 242	Y-197R	
HDS 243	Y-112T	
HDS 244	Y-157R	
HDS 245	Y-128T	

<b>LUCAS</b>	<b>→ NGK</b>	<b>D-Power</b>
HDS 246	Y-181T	
HDS 249	Y-104	
HDS 251	Y-203	
HDS 252	Y-128	
HDS 253	Y-117SS	
HDS 254	Y-204SS	
HDS 256	Y-103-1	
HDS 257	Y-103-2	
HDS 258	Y-204TS1	
HDS 259	Y-144RS	
HDS 267	Y-909R	
HDS 268	Y-147T	
HDS 269	Y-274	
HDS 270	Y-115R1	
HDS 272	Y-107T	
HDS 273	Y-910J	3
HDS 275	Y-703R	
HDS 276	Y-707RS	
HDS 280	Y-112R1	
HDS 282	Y-108	
HDS 283	Y-705RS	
HDS 284	Y-168R	
HDS 291	Y-177-1	
HDS 294	Y-757RS	
HDS 295	Y-924J	1
HDS 316	DG-237	
HDS 337	Y-907R	
HDS 338	Y-711J	28
HDS 339	Y-910J	3
HDS 340	Y-755RS	
HDS 343	Y-207T	
HDS 345	Y-710J	
HDS 347	Y-913J	15
<b>MARELLI</b>	<b>→ NGK</b>	<b>D-Power</b>
061 830 024 304	Y-918J	2
061 830 025 304	Y-924J	1
061 830 078 304	Y-924J	1
TIX 1 A	Y-207T	
TIX 2 A	Y-208T	
TIX 4 A	Y-208T	
TIX 6 A	Y-208T	
UX 1 A	Y-918J	2
UX 2 A	Y-924J	1
UX 4 A	Y-924J	1
<b>MASERATI =&gt; FIAT Group</b>		
<b>MAYBACH =&gt; MERCEDES</b>		



<b>MAZDA</b>	<b>→ NGK</b>	<b>D-Power</b>
1304-18-140	Y-172	
1353-18-140	Y-107T	
1353-18-140A	Y-107T	
1N01-18-601A	CY51	
1N02-18-601	CY52	
4869-18-140	Y-122	
4869-18-140A	Y-122	
R2L2-18-601	Y-721RS	
RF2A-18-601	Y-529J	
RFG1-18-601	Y-701J	39
RFJ5-18-601	Y-701J	39
RFS5-18-601	Y1006J	
RFS5-18-601A	Y1006J	
S201-18-140	Y-107R	
S210-18-140	Y-701J	39
S501-18-140A	Y-107R	
SE01-18-140A	Y-157R	
SEM1-18-601	Y-771R	
VS01-18-601	Y-721RS	
WE01-18-601	Y-526J1	69
WL03-18-601	Y-701J	39
WL81-18-601	Y-701J	39
Y701-18-601	Y-603J	60
<b>MERCEDES</b>	<b>→ NGK</b>	<b>D-Power</b>
A 000 159 61 01	DG-237	
A 000 159 81 01	Y-924J	1
A 001 159 15 01	Y-930U	30
A 001 159 20 01	Y-925J	16
A 001 159 21 01	Y-925J	16
A 001 159 26 01	Y-929U	41
A 001 159 27 01	Y-746J	38
A 001 159 28 01	Y-745U	11
A 001 159 35 01	Y-924J	1
A 001 159 36 01	Y-916J	6
A 001 159 37 01	Y-745U	11
A 001 159 38 01	Y-745U	11
A 001 159 42 01	Y-745U	11
A 001 159 46 10	YE13	
A 001 159 48 01	Y-745U	11
A 001 159 49 01	Y-745U	11
A 001 159 50 01	Y8002AS	51
A 001 159 56 01	CZ106	53
A 001 159 57 01	CZ303	54
A 001 159 58 01	CZ303	54
A 001 159 66 01	CZ303	54
A 001 159 68 01	CZ106	53
A 665 159 02 01	Y-536J	81
A 667 159 00 01	Y-537AS	
Q0 004 562 V003 00 0000	Y-543J	46

<b>MG =&gt; ROVER</b>		
<b>MINI =&gt; BMW</b>		
<b>MITSUBISHI</b>	<b>→ NGK</b>	<b>D-Power</b>
1820 A009	CZ251	76
30666-57301	Y-114T	
30666-57302	Y-114T	
30666-57303	Y-114T	
30L66-00300	Y-723R	
30L66-00301	Y-723R	
30L66-00302	Y-723R	
30L66-00400	Y-723U	
30L66-00400-9V	Y-723U	
30L66-00401	Y-723U	
30L66-00402	Y-723U	
31366-14300	Y-201	
31366-14301	Y-201	
31366-14302	Y-201	
31A66-03100	Y-701U	
31A66-03101	Y-701U	
31A66-03102	Y-701U	
32A66-07010	Y-904M1	
32A66-07020	Y-954M1	
32A66-07021	Y-954M1	
32A66-07100	Y-904M1	
32A66-07200	Y-954M1	
32C98-55808	Y-722JS	
34466-21300	Y-182T	
34466-21301	Y-182T	
34466-31301	Y-182T1	
36710-42500	CY57	21
91304-04300	Y-701J	39
EE 960 02	Y-104	
K9 670 240	Y-201	
M 816 732	Y-933J	25
MD 014 997	Y-115R1	
MD 050 212	Y-115T1	
MD 077 167	Y-707RS	
MD 197 511	CY57	21
MD 301 950	Y-733J	13
MD 344 469	Y-733J	13
ME 017 009	Y-274R	
ME 017 010	Y-274	
ME 017 013	Y-274	
ME 017 057	Y-971M	
ME 200 970	CZ256	
ME 201 638	CZ256	
ME 203 539	Y1007J	59
ME 203 754	CZ256	
MM 401 621	Y-110	
MM 401 621 01	Y-110	



<b>MITSUBISHI</b>	<b>→ NGK</b>	<b>D-Power</b>
MM 401 621 02	Y-110	
MM 431 439 01	Y-142T	
MM 432 148	Y-145T	
MN 960 270	YE13	
MN 960 296	YE13	
MN 980 234	YE14	48
MN 980 406	CZ304	55
MR 577 131	Y-733J	13

<b>MOTORCRAFT</b>	<b>→ NGK</b>	<b>D-Power</b>
10 56 857	Y-937J	5
10 79 401	Y-524J	27
10 96 527	Y-548J	75
16 90 048	Y-741U	20
32 52 725	Y-107R	
50 23 372	Y-208T	
50 31 006	Y-924J	1
61 32 246	Y-907R	
61 54 593	Y-924J	1
70 88 988	Y-910J	3
84BB6-M090-AA	Y-924J	1
84FF6-M090-B2A	Y-907R	
93FF6-M090-AA	Y-910J	3
96FF6-M090-CA	Y-937J	5
EZD 1	Y-810	
EZD 5	Y-924J	1
EZD 10	Y-918J	2
EZD 18	Y-115T1	
EZD 19	Y-128T	
EZD 20	Y-117RS	
EZD 21	Y-118T1	
EZD 22	Y-107T	
EZD 30	Y-924J	1
EZD 40	YE04	40
EZD 41	Y-504J	24
V94DX-6M090-AA	Y-924J	1
V95DD-6M090-AA	Y-741U	20
XS4U-6M090-AB	Y-524J	27
XS7U-6M090-BA	Y-548J	75

<b>NISSAN</b>	<b>→ NGK</b>	<b>D-Power</b>
11065-00Q0A	Y-517J	66
11065-00Q0E	Y1035AS	77
11065-02T00	Y-955RS	
11065-0W801	CZ261	
11065-10G00	Y-705RS	
11065-10T01	Y-757RS	
11065-16A00	Y-117SS	
11065-16A05	Y-117RS	
11065-16A06	Y-144RS	
11065-16A10	Y-117SS	

<b>NISSAN</b>	<b>→ NGK</b>	<b>D-Power</b>
11065-16A15	Y-117RS	
11065-16A16	Y-144RS	
11065-2TB0A	Y-519J	61
11065-2W202	CZ258	
11065-31N00	Y-712RS	
11065-31W00	Y-112T	
11065-31W01	Y-112T	
11065-31W02	Y-112TS	
11065-34W00	Y-112M1	
11065-37506	Y-103	
11065-37507	Y-103	
11065-43G01	Y-707RS	
11065-57J00	CY52	
11065-5C900	CY52	
11065-63G00-GW	Y-707RS	
11065-65N01	CZ261	
11065-7C000	Y-530J	
11065-89TA1	Y-954M1	
11065-9C600	Y-712RS	
11065-AD200	Y-519J	61
11065-AD201	Y-519J	61
11065-AD220	Y-519J	61
11065-C8600	Y-755RS	
11065-D2800	Y-120RS	
11065-DB000	Y-522J	
11065-G2400	Y-712RS	
11065-G2460	Y-712RS	
11065-G5501	CY51	
11065-HC200	Y-701J	39
11065-HC251	Y-721RS	
11065-J2000	Y-202	
11065-J5501	Y-202-2	
11065-J5502	Y-202-2	
11065-J5570	Y-222T	
11065-0W801	CZ261	
11065-Q4000	Y-103-2A	
11065-Q4001	Y-112T1	
11065-T3400	Y-177-1	
11065-T3401	Y-177-1	
11065-T3470	Y-181T	
11065-T8200	Y-112R1	
11065-T8201	Y-162R1	
11065-T8202	Y-112R1	
11065-T8203	Y-162R1	
11065-T9000	Y-272R1	
11065-T9001	Y-272R1	
11065-V0700	Y-204TS1	
11065-V0710	Y-204TS1	
11065-V7202	CX51	
11065-V7203	CZ51	
11065-W2500	Y-204RS	
11065-W2510	Y-204RS	





<b>NISSAN</b>	<b>→ NGK</b>	<b>D-Power</b>
11065-W3400	Y-204SS	
11065-W3410	Y-204SS	
11065-Y1400	Y-103-1	
11065-Y1401	Y-103-1	
11065-Y1402	Y-103-2	
11065-Y1403	Y-103-2	
11065-Y1404	Y-103-2	
11065-Z5000	Y-252	
RFJ5-18601	Y-701J	39

<b>OPEL</b>	<b>→ NGK</b>	<b>D-Power</b>
12 14 334	Y9003AS	78
12 14 459	Y1038J	
12 14 032	Y8003J	62
12 14 034	YE07	
12 14 040	Y-534J	36
12 14 063	Y-541J	42
12 14 300	Y-810	
12 14 301	Y-541J	42
12 14 302	Y-403-1	
12 14 303	Y-403T	
12 14 304	Y-208T	
12 14 305	Y-523J	37
12 14 308	Y-306R	
12 14 309	Y-307R	
12 14 310	Y-719RS1	
12 14 311	Y-710J	
12 14 315	Y-719RS1	
12 14 316	Y-603J	60
12 14 319	Y-924J	1
12 14 321	Y-904M1	
12 14 323	Y-904M1	
12 14 324	Y-924J	1
12 14 427	Y-741U	20
12 14 457	Y-748U	14
18 26 357	Y9004AS	
44 03 145	Y-910J	3
09 111 145	Y-910J	3
09 118 201	Y-748U	14
09 196 669	Y-523J	37
55 564 162	Y9003AS	78
55 564 219	Y9004AS	
90 093 867	Y-208T	
90 093 897	Y-208T	
90 510 924	Y-924J	1
90 540 864	Y-924J	1
91 153 919	Y-741U	20
93 178 047	Y8003J	62
93 178 411	YE07	
93 190 433	Y1030J	70
94 133 759	Y-904M1	

<b>OPEL</b>	<b>→ NGK</b>	<b>D-Power</b>
94 175 158	Y-904M1	
94 319 700	Y-710J	
94 402 303	Y-307R	
94 439 218	Y-306R	
94 481 972	Y-719RS1	
97 044 037	Y-719RS1	
97 210 818	Y-541J	42
97 725 357	Y-810	

**PEUGEOT => PSA**

**PONTIAC => GM**

<b>PROTON</b>	<b>→ NGK</b>	<b>D-Power</b>
MD 197 511	CY57	21

<b>PSA</b>	<b>→ NGK</b>	<b>D-Power</b>
5960.12	YE04	40
5960.19	YE04	40
5960.64	Y1005J	56
5960.65	Y1005J	56
5960.66	Y-504J	24
5960.67	Y-504J	24
5960.76	YE12	
5960.77	YE12	
5960.78	YE05	73
5960.79	YE05	73
5960.88	Y-548J	75
5960.89	Y-548J	75
5960.99	YE08	
5960.A0	YE08	
5960.A3	Y8005J	64
5960.A4	Y8005J	64
5960.E6	Y8001AS	58
5960.F4	Y-504J	24
5960.F5	Y-504J	24
5960.F8	YE12	
5960.F9	YE05	73
5960.G6	YE08	
5960.K4	Y8005J	64
5960.L4	Y9001AS	72
5961.16	Y-404	
5961.22	Y-810	
5961.35	Y-810	
5961.39	Y-924J	1
5961.53	Y-208T	
5961.54	Y-208T	
5961.58	Y-208T	
5961.A3	Y8005J	64
5961.A4	Y8005J	64
5961.K4	Y8005J	64



<b>PSA</b>	<b>→ NGK</b>	<b>D-Power</b>
5962.03	Y-503J	10
5962.1Q	Y-738U	
5962.2Y	Y-503J	10
5962.2Z	Y-503J	10
5962.3C	Y-504J	24
5962.3E	Y-504J	24
5962.3H	Y-924J	1
5962.7F	Y-504J	24
5962.7G	Y-504J	24
5962.J3	Y-910J	3
5962.T1	Y-910J	3
5962.T2	Y-933J	25
79 325 658 82	Y-810	
79 325 677 18	Y-208T	
91 508 602 80	Y-924J	1
91 908 610 80	Y-924J	1
95 493 206	Y-208T	
95 534 788	Y-208T	
96 236 383	Y-504J	24
96 374 699 80	YE04	40
96 389 858	Y-504J	24
96 501 000 80	YE05	73
96 525 482 80 00	YE08	
96 831 952 80	Y8001AS	58
HG 2621	Y-810	
<b>RENAULT</b>	<b>→ NGK</b>	<b>D-Power</b>
11 06 556 87R	Y1035AS	77
50 01 001 587	Y-208T	
77 00 100 558	Y-506J	7
77 00 100 586	Y-740U	22
77 00 100 635	Y-516J	12
77 00 105 290	Y-927J	19
77 00 111 323	Y-732J	4
77 00 662 199	Y-208T	
77 00 733 076	Y-924J	1
77 00 741 144	Y-924J	1
77 00 854 538	Y-933J	25
77 00 855 865	Y-913J	15
77 00 856 238	Y-913J	15
77 00 856 292	Y-933J	25
77 00 861 906	Y-730U	17
77 01 039 387	Y-924J	1
77 01 058 142	Y-522J	
77 01 349 475	Y-924J	1
82 00 090 817	Y-913J	15
82 00 426 227	Y-516J	12
82 00 490 950	Y-732J	4
82 00 682 592	Y1035AS	77
82 00 787 721	Y-516J	12
82 00 794 920	Y1036AS	

<b>RENAULT</b>	<b>→ NGK</b>	<b>D-Power</b>
85 49 971 00	Y-810	
<b>ROVER</b>	<b>→ NGK</b>	<b>D-Power</b>
ETC 8847	Y-729U	34
<b>SAAB</b>	<b>→ NGK</b>	<b>D-Power</b>
93 178 411	YE07	
93 191 771	Y9003AS	78
<b>SEAT =&gt; VW Group</b>		
<b>SKODA =&gt; VW Group</b>		
<b>SMART =&gt; MERCEDES</b>		
<b>SSANGYONG</b>	<b>→ NGK</b>	<b>D-Power</b>
A 665 159 02 01	Y-536J	81
A 667 159 00 01	Y-537AS	
<b>STEYR =&gt; MERCEDES</b>		
<b>SUZUKI</b>	<b>→ NGK</b>	<b>D-Power</b>
09900-F8Q01	Y-516J	12
09900-RF001	Y-701J	39
18550-79J50	Y1030J	70
18550-79J80	Y9003AS	78
18550-79J81	Y9003AS	78
18550-80KA0	Y1036AS	
<b>TOYOTA</b>	<b>→ NGK</b>	<b>D-Power</b>
19850-0R010	Y1012J	65
19850-0R020	Y1012J	65
19850-0R022	Y1012J	65
19850-0W010	Y-542J	45
19850-26010	Y1012J	65
19850-26020	Y1012J	65
19850-26021	Y1012J	65
19850-26022	Y1012J	65
19850-27010	Y-531J	44
19850-30010	Y-531J	44
19850-54030	Y-118T1	
19850-54031	Y-118T1	
19850-54050	Y-118R	
19850-54060	Y-168R	
19850-54090	Y-715R	
19850-56012	Y-178T	
19850-56021	Y-128T	
19850-56022	Y-128T	
19850-64010	Y-146R	
19850-64020	Y-703R	





A-6	AB-6
A-7	AB-7
A-8	AB-8
A-8F	A8FS
A-8V	AB-8
A-9F	A9FS
A-9V	AB-8
AP6F	AP6FS
APR5FS-11	APR5FS
APR5FS-15	APR5FS
APR6F	AP6FS
B10EV	BR10EIX
B10EVX	BR10EIX
B10FS	R5673-10
B10H	B10HS
B10HN	R5525-10
B10HP	R5530-10
B10HV	BR10HIX
B10HVX	BR10HIX
B11EN	B11EGV
B11HN	R5525-11
B11HP	R5525-11
B5EB	BR5ES
B5EB-11	BUR5EB-11
B5ES-11	B5ES
B6EB-L-11	BR6ES
B6EFS	BR6EF
B6FS	BR6FS
B6HV	BR6HIX
B6HVX	BR6HIX
B-77-HC	B8HCS
B7EB	BR7ES
B7EB-11	BUR7EB-11
B7ET	BR7ET
B7EV	BR7EIX
B7EVX	BR7EIX
B7HV	BR7HIX
B7HVX	BR7HIX
B8EM	BR8EM
B8EMV	BR8ET
B8EN	B8EGV
B8ES-11	B8ES
B8ET	BR8ET
B8EV	BR8EIX
B8EVX	BR8EIX
B8HN	R5525-8
B8HV	BR8HIX
B8HVX	BR8HIX
B9EGP	BR9EIX
B9EN	B9EGV
B9EV	BR9EIX
B9EVX	BR9EIX
B9HCV	BR9HIX

B9HN	R5525-9
B9HP	R5530-9
B9HV	BR9HIX
B9HVX	BR9HIX
BCP4ES	BCPR4ES-11
BCP4ES-11	BCPR4ES-11
BCP5E-11	BCPR5E-11
BCP5ET	BCPR5ET
BCP5EV-11	BCPR5EIX-11
BCP5EVX-11	BCPR5EIX-11
BCP5EY-11	BCPR5EY-11
BCP6E-11	BKR6E-11
BCP6EV-11	BCPR6EIX-11
BCP6EVX-11	BCPR6EIX-11
BCP7E	BCPR7E
BCP7E-11	BCPR7E-11
BCP7ES-11	BKR7E-11
BCPR4E-11	BCPR4ES-11
BCPR4ES	BCPR4ES-11
BCPR5EP-11	BCPR5EIX-11
BCPR5EP-13	BCPR5EIX-11
BCPR5EVX-11	BCPR5EIX-11
BCPR6EP-13	BCPR6EIX-11
BCPR6EP-N-11	BCPR6EIX-11
BCPR6ER	BKR6EK
BCPR6EVX-11	BCPR6EIX-11
BCPR7ER	BKR6EK
BCPR7EVX-11	BKR7EIX-11
BCPR7EY	BCPR7E
BK5EKU	BKR5EKU
BK7EKU	BKR7EKU
BKR5EVX	BKR5EIX
BKR5EVX-11	BKR5EIX-11
BKR6EIX-LPG	LPG1
BKR6EVX	BKR6EIX
BKR6EVX-11	BKR6EIX-11
BKR6EVXA-11	BKR6EIX-11
BKR7EVX	BKR7EIX
BKR7EVX-11	BKR7EIX-11
BKUR6EQU	BKR6EQUA
BMR7F	BM7F
BP10EV	BPR10EVX
BP2HA	BP2HS
BP4EFS	TR4
BP4ES-13	BPR4ES-13
BP5EA	BP4EY
BP5EA-11	BP4EY-11
BP5EA-L	BP5EY
BP5EA-L-11	BP5EY-11
BP5EJ	BPR5EY-11
BP5EKN	BPR5EY
BP5ES-L	BP5EY
BP5EV	BPR5EIX



BP5EVX	BPR5EIX
BP5EVX-11	BPR5EIX-11
BP6EA	BP6EY
BP6EA-11	BP6EY-11
BP6EK	BPR6EK-A
BP6EK-A	BPR6EK-A
BP6EKA-V	BPR6EK-A
BP6EKN	BPR6EKN
BP6EV	BPR6EIX
BP6EVX	BPR6EIX
BP6EVX-11	BPR6EIX-11
BP6HV	BPR6HIX
BP6HVX	BPR6HIX
BP7E	BPR7E
BP7EFS-13	BP7EFS
BP7EFVX	TR7IX
BP7EKN	BPR7EKN
BP7EV	BPR7EIX
BP7EVX	BPR7EIX
BP7EY-11	BPR7EY-11
BP7HV	BPR7HIX
BP7HVX	BPR7HIX
BP8ES-11	BP8ES
BP8EV	BPR8EIX
BP8EVX	BPR8EIX
BP8FS	R5674-8
BP8HSA	BPR8HSA
BP8HVX	BPR8HIX
BP9EV	BPR9EIX
BPR-2E	BPR2ES
BPR4ES-L-11	BPR5ES-11
BPR4EVX	GR4IX
BPR4FS-20	BPR4FS-15
BPR4S	BP-4
BPR4S-15	BP-4
BPR5EA	BPR5EY
BPR5EA-11	BPR5EY-11
BPR5EA-L	BPR5EY
BPR5EA-L-11	BPR5EY-11
BPR5EF	BPR5EFS
BPR5EF-13	BPR5EFS-13
BPR5EFVX	TR5IX
BPR5EK-A	BPR5EIX-11
BPR5EP-13	BPR5EP-11
BPR5ES-15	BPR5ES-13
BPR5EV	BPR5EIX
BPR5EVX	BPR5EIX
BPR5EVX-11	BPR5EIX-11
BPR5S	BP5S
BPR5S-15	BP5S
BPR6EA	BPR5EY
BPR6EIX-LPG	LPG2
BPR6ES-N-11	BPR6ES-11

BPR6EV	BPR6EIX
BPR6EVX	BPR6EIX
BPR6EVX-11	BPR6EIX-11
BPR6FS-10	BPR6FS
BPR6FS-15	BPR6FS
BPR6HVX	BPR6HIX
BPR6S	BP6S
BPR7EVX	BPR7EIX
BPR7EY	BPR7EIX
BPR7HVX	BPR7HIX
BPR8EVX	BPR8EIX
BPR9EVX	BPR9EIX
BR10ECMVX	BR10ECMIX
BR10EV	BR10EIX
BR10EVX	BR10EIX
BR4ES-11	BR4ES
BR5EB	BR5ES
BR5EB-11	BUR5EB-11
BR5ES-11	BR5ES
BR5FS-15	BR5FS
BR6EB	BR6ES
BR6EB-11	BUR6EB-11
BR6EB-L	BR7ES
BR6FS-15	BR6FS
BR7EB	BR7ES
BR7EB-11	BUR7EB-11
BR7ES-11	BR7ES
BR7EVX	BR7EIX
BR8ECMVX	BR8ECMIX
BR8EV	BR8EIX
BR8EVX	BR8EIX
BR8HV	BR8HIX
BR8HVX	BR8HIX
BR9ECMVX	BR9ECMIX
BR9EV	BR9EIX
BR9EVX	BR9EIX
BRE813L	BR8ET
BU5EB-11	BUR5EB-11
BU6EA-11	BUR6EA-11
BU6EB-11	BUR6EB-11
BU7EA-11	BUR7EA-11
BU7EB-11	BUR7EB-11
BUEW	BUE
BUR5EBVX-11	BUR5EB-11
BZ8ES	BR8ES
C10H	R0161-10
C6H	C6HSA
C6M	C6HSA
C7EH-9	CR7EH-9
C7HV	CR7HIX
C7HVX	CR7HIX
C8EHVX-9	CR8EHIX-9
C8EVX	CR8EIX





C8HV	CR8HIX
C8HVX	CR8HIX
C9EHVX-9	CR9EHIX-9
C9EVX	CR9EIX
C9H	C8HSA
CR8EHVX-9	CR8EHIX-9
CR8EVX	CR8EIX
CR8HVX	CR8HIX
CR9EHVX-9	CR9EHIX-9
CR9EVX	CR9EIX
D12E	R2349-11
D-4H	DR4HS
D6ES	D6EA
D-6H	D5HS
D6HS	D6HA
D6HV	D6HA
D7EV	DR7EIX
D7EVX	DR7EIX
D8EV	DR8EIX
D8EVX	DR8EIX
D8HS	D8HA
D8HV	D8HA
D9EV	DR9EIX
D9EVX	DR9EIX
DCP7EVX	DCPR7EIX
DCP8E	DCPR8E
DCP8EVX	DCPR8EIX
DCPR7EVX	DCPR7EIX
DCPR8EVX	DCPR8EIX
DCPR9EVX	DCPR9EIX
DIMR8B10	DIMR8A10
DP5EA-9	DPR5EA-9
DP7EV-9	DPR7EIX-9
DP7Z	DPR7Z
DP8EV-9	DPR8EIX-9
DP8EVX-9	DPR8EIX-9
DP9EV-9	DPR9EIX-9
DP9EVX-9	DPR9EIX-9
DPR7EV-9	DPR7EIX-9
DPR7EVX-9	DPR7EIX-9
DPR8EV-9	DPR8EIX-9
DPR8EVX-9	DPR8EIX-9
DPR9EV-9	DPR9EIX-9
DPR9EVX-9	DPR9EIX-9
DR8EVX	DR8EIX
DR9EVX	DR9EIX
GR4VX	GR4
IFR7G-11K	IFR7G-11KS
IKR9F8	IKR9J8
ILKAR6C10	ILKAR7C10
ITR5F13	TR5AI-13
J10B	JR10B
J9B	JR9B

JR10A	JR10B
JR9A	JR9B
LKR9CI-8	ILKR9G8
PFR5B	PFR5B-9
PGR6B	PGR6A-11
PZFR6B	IZFR6B
PZFR6R8EG	SIZFR6B8EG
R0045A-10	R0045J-10
R0045A-11	R0045J-11
R015-10	R0373A-10
R015-8	CR8EIX
R015-9	R0373A-10
R015-95	R0373A-10
R016-10	R0373A-10
R016-105	R0373A-9
R016-11	R0373A-11
R016-8	CR8EIX
R016-9	R0373A-10
R016E-11P	R0373A-11
R017-10	R0373A-10
R017-11	R0373A-11
R017-8	CR8EIX
R017-9	R0373A-9
R017-S11	R0373A-11
R0256K-11	R0373A-11
R0256R-10	R0373A-10
R2097-11P	R2525-10
R216-10	R2525-10
R216-11	R2525-10
R216-12	R2349-11
R216-9	R2525-9
R217-10	R2525-10
R217-11	R2525-10
R217-12	R2349-11
R217-9	R2525-9
R2198-12P	R2349-11
R2270-10	R2349-10
R2270-11	R2349-11
R2270-9	R2349-9
R2430-10	R2349-10
R2430-9	R2349-9
R2525-11	R2349-11
R4118M-10	R4118S-10
R4118M-105	R4118S-105
R4118M-11	R4118S-11
R4118M-7	R4118S-7
R4118-M75	R4118S-75
R4118-M8	R4118S-8
R4118M-85	R4118S-85
R4118-M9	R4118S-9
R4339-10	B10EG
R4339-8	B8EG
R4339-9	B9EG



R4452D-10	B10EGP
R4452D-105	B105EGP
R4452D-11	B11EGP
R4452D-8	B8EGP
R4452D-85	B85EGP
R4452D-9	BR9EIX
R4452D-95	B95EGP
R4468-10	R6725-10
R4468-105	R6725-105
R4468-11	R6725-11
R4468-115	R6725-115
R4468-9	R6725-9
R4468A-10	R6725-10
R4468A-105	R6725-105
R4468A-11	R6725-11
R4468A-115	R6725-115
R4468A-9	R6725-9
R4630A-10	R7376-10
R4630A-105	R7376-10
R4630A-11	R7376-10
R4630A-8	R7376-8
R4630A-9	R7376-9
R5184-11	R7282-11
R5300A-105	R7282-105
R5300A-11	R7282-11
R5300A-9	R7282-9
R5300N-105	R7282-105
R5400-10	R7437-10
R5400-7	BCPR7EIX
R5400-8	R7435-8
R5400-9	R7435-9
R5530-11	R5525-11
R5540-10	R5540F-10
R5540-105	R5540F-105
R5540-95	R5540F-10
R5540B-105	R5540F-105
R5540F-11	R7282-11
R5649-10	R6712-10
R5649-9	R6712-9
R5671-8	R5671A-8
R5671-9	R5671A-9
R5672-8	R5672A-8
R5672-9	R5672A-9
R5686-10	R7436-10
R5686-11	R7436-10
R5686-8	R7436-8
R5686-9	R7436-9
R5687-10	R7436-10
R5687-8	R7436-8
R5687-9	R7436-9
R5796-8	R7436-8
R5830-10	R7436-10
R5830-9	R7436-9

R5883-11	R6601-11
R5883-9	R6601-9
R6120-10	R7282-10
R6120-105	R7282-105
R6120-11	R7282-11
R6120A-105	R7282A-105
R6120A-11	R7282A-11
R6120C-105	R7282-105
R6120C-11	R7282-11
R6120M-105	R7282-105
R6120M-11	R7282M-11
R6179A-105P	R7282-105
R6205-8	R7433-8
R6205-9	R7433-9
R6242-10	R7434-10
R6252E-8	R7376-8
R6254E-8	R6254E-9
R6255-9	R7433-9
R6326-9	R7433-9
R6385-105P	R7376-10
R6385-10P	R7376-10
R6385-11P	R7376-10
R6385-8P	R7376-8
R6385-9P	R7376-9
R7112-9	R7433-9
R7113-8	R7433-8
R7113-9	R7433-9
R7114-9	R7433-9
R7115-10	R7433-10
R7115-8	R7433-8
R7115-9	R7433-9
R7116-10	R7434-10
R7116-8	R7434-8
R7116-9	R7434-9
R7117-10	R7434-10
R7117-8	R7434-8
R7117-9	R7434-9
R7118-10	R7434-10
R7118-8	R7434-8
R7118-9	R7434-9
R7119-10	R7434-10
R7119-8	R7434-8
R7119-9	R7434-9
R7232-10	R7437-10
R7232-7	BCPR7EIX
R7232-8	R7435-8
R7232-9	R7435-9
R7233-10	R7435-10
R7233-7	BCPR7EIX
R7234-10	R7436-10
R7234-8	R7436-8
R7234-9	R7436-9
R7236-10	R7436-10





## PS/HP ↔ kW

PS/HP	kW	kW	PS/HP	PS/HP	kW	kW	PS/HP
1	1,36	1	0,736	1	1,36	1	0,736
50	37	40	54	325	239	315	428
55	40	45	61	330	243	320	435
60	44	50	68	335	246	325	442
65	48	55	75	340	250	330	448
70	51	60	82	345	254	335	455
75	55	65	88	350	257	340	462
80	59	70	95	355	261	345	469
85	63	75	102	360	265	350	476
90	66	80	109	365	268	355	482
95	70	85	115	370	272	360	489
100	74	90	122	375	276	365	496
105	77	95	129	380	279	370	503
110	81	100	136	385	283	375	510
115	85	105	143	390	287	380	516
120	88	110	149	395	290	385	523
125	92	115	156	400	294	390	530
130	96	120	163	405	298	395	537
135	99	125	170	410	301	400	543
140	103	130	177	415	305	405	550
145	107	135	183	420	309	410	557
150	110	140	190	425	313	415	564
155	114	145	197	430	316	420	571
160	118	150	204	435	320	425	577
165	121	155	211	440	324	430	584
170	125	160	217	445	327	435	591
175	129	165	224	450	331	440	598
180	132	170	231	455	335	445	605
185	136	175	238	460	338	450	611
190	140	180	245	465	342	455	618
195	143	185	251	470	346	460	625
200	147	190	258	475	349	465	632
205	151	195	265	480	353	470	639
210	154	200	272	485	357	475	645
215	158	205	279	490	360	480	652
220	162	210	285	495	364	485	659
225	165	215	292	500	368	490	666
230	169	220	299	505	371	495	673
235	173	225	306	510	375	500	679
240	176	230	313	515	379	505	686
245	180	235	319	520	382	510	693
250	184	240	326	525	386	515	700
255	188	245	333	530	390	520	707
260	191	250	340	535	393	525	713
265	195	255	346	540	397	530	720
270	199	260	353	545	401	535	727
275	202	265	360	550	404	540	734
280	206	270	367			545	740
285	210	275	374			550	747
290	213	280	380				
295	217	285	387				
300	221	290	394				
305	224	295	401				
310	228	300	408				
315	232	305	414				
320	235	310	421				



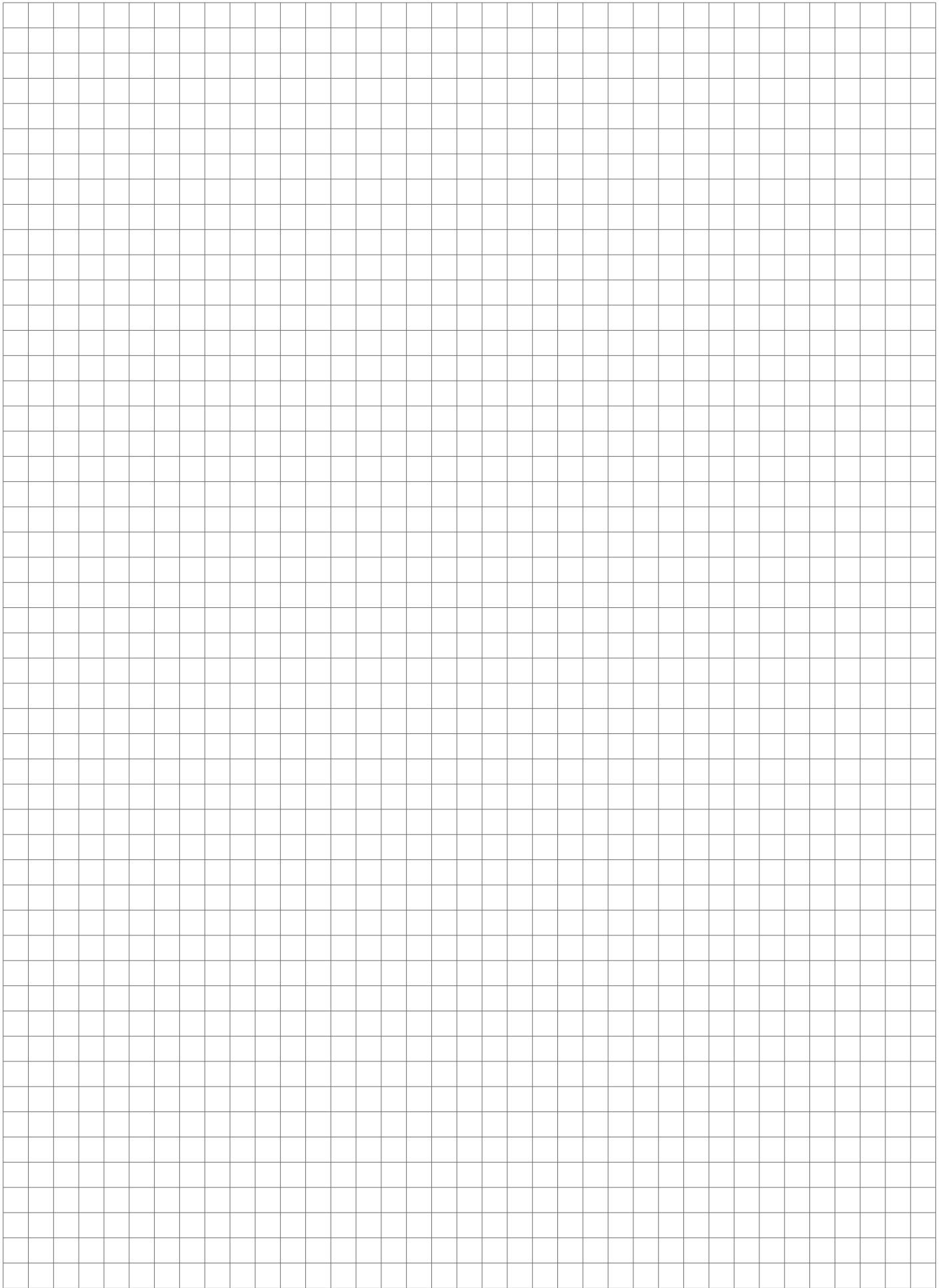

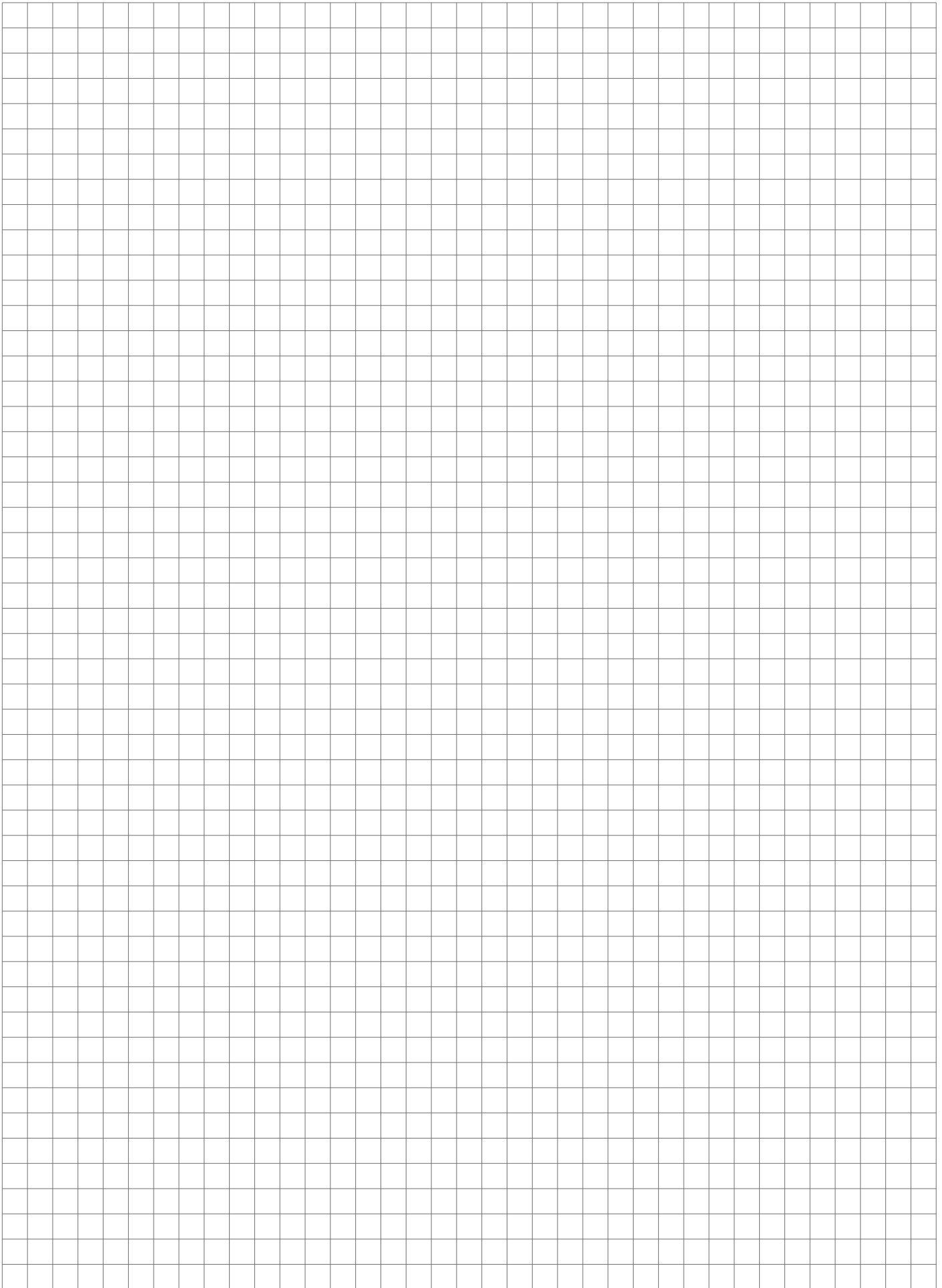

The screenshot displays the NGK E-Learning interface for 'Spark plugs'. The main content area features a graph titled 'Spark plug temperature (firing end)' showing temperature in degrees Celsius on the y-axis (450, 850, 1000) and engine load on the x-axis (0% to 100%). The graph is divided into three regions: 'Overheating region' (top, red), 'Safety margin' (middle, yellow), and 'Fouling region' (bottom, blue). A 3D character in blue overalls stands next to a red fire extinguisher. Below the graph, there are three buttons labeled 'A hot', 'B optim', and 'C cold', and an 'Engine load' slider.

**The meaning of the heat rating**

The generation of heat varies greatly from engine to engine. For example, a lawn mower will generate less heat than a racing car or a turbocharged engine can run significantly hotter than a naturally aspirated engine.

Therefore a spark plug must be selected that can conduct a precisely defined amount of heat energy to the cylinder head and ensure that the optimal operating temperature range is maintained.

The heat rating of a spark plug provides information about its thermal performance. The following applies for NGK spark plugs: The higher the heat rating number, the higher the thermal performance.

The heat rating number is to be found within the technical part number designation which is marked on the body of NGK's spark plugs (e.g. BK9RES).

The screenshot displays the NGK E-Learning interface for 'Ignition sequence'. The main content area features a diagram of an engine with a distributor and spark plugs. A 3D character in blue overalls stands next to the engine. Below the diagram, there are two buttons labeled 'fast' and 'slow', and a 'Speed' slider.

**Ignition sequence**

In older systems a central ignition coil generates the high voltage necessary for the ignition of the air-fuel mixture.

A mechanical ignition distributor ensures that this voltage is sent to the correct cylinder's spark plug at the right time.

The ignition high voltage is fed through a distributor cap and the ignition HT lead which is connected to the spark plug terminal. From here it reaches the tip of the centre electrode and when sufficient voltage is available to overcome the resistance of the air gap between the centre and ground electrode electrical energy discharges to earth in the form of a spark.

In more modern systems an individual 'cylinder coil' is often fitted directly to each spark plug. With these fully-electronic ignition systems neither mechanical ignition distributors or high-voltage





**NGK SPARK PLUG EUROPE GMBH**

Harkortstraße 41 · 40880 Ratingen · Germany  
Fon + 49 21 02-974-100 · Fax + 49 21 02-974-149  
[www.ngk-europe.com](http://www.ngk-europe.com)

