



**RUS** 2008-2009









[www.ngk-elearning.com](http://www.ngk-elearning.com)



[www.ngk-elearning.de](http://www.ngk-elearning.de)



# Содержание

Гоночные свечи зажигания . . . . .	3 – 8
  LPG . . . . .	9 – 11
 V-Line . . . . .	12 – 17
 Схема условных обозначений/ Таблица пересчета момента затяжки . .	18 – 22
 Определение типа двигателя . .	23

Серии свечей зажигания . . . . .	1 – 11
Серии свечей накаливания . . . . .	12 – 32

Свечи зажигания для легковых  
автомобилей/Свечи накаливания

для легковых/грузовых автомобилей

 1988 – 2007 . . . . .	33 – 215
Свечи зажигания для мотоциклов . . .	216 – 313
Свечи зажигания для мотороллеров . .	314 – 340
 . . . . .	341 – 353
Свечные штекеры для мотоциклов/ мотороллеров/  . . . . .	354 – 392
Свечи зажигания для катеров со стационарным двигателем . . . . .	393 – 427
Свечи зажигания для катеров с подвесным двигателем . . . . .	428 – 486
Свечи зажигания для катеров с воздушно-реактивным двигателем . . .	487 – 495
Свечи зажигания для бензопил . . . . .	496 – 514
Свечи зажигания для газонокосилок . .	515 – 548
Свечи зажигания для ручных косилок . . . . .	549 – 565
Свечи зажигания для генераторов . . . .	566 – 580
Свечи зажигания для различных двигателей и орудий труда . . . . .	581 – 627
Свечи зажигания для снегоходов . . . .	628 – 652
Свечные штекеры . . . . .	653 – 661

Таблица сопоставлений с другими  
производителями

V-Line – Beru – Bosch – Champion . . . .	662
V-Line No. –  . . . . .	663
Таблица сопоставлений с другими производителями . . . . .	664 – 773
ЛС ↔ кВт . . . . .	774
Info . . . . .	775
Последняя информация . . . . .	776

Redaktionsschluss: 19.09.2007

Redaktion:

Hermann Fink  
Tel.: 0 21 02/97 41 27  
E-Mail: H.Fink@NGKNTK.de  
Uwe Milbrandt  
E-Mail: U\_Milbrandt@NGKNTK.de

Änderungen vorbehalten

 = 2008–2009

## Примечания:

Данный перечень спецификаций предназначен только для выбора типа свечей.

С опубликованием данного издания все предшествующие перечни спецификаций теряют силу. Содержание списка не может послужить основой для возникновения правоприязания.

Рекомендации для авиационных двигателей согласно директивам FAA в данное издание не включены.

Свечи зажигания, свечи накаливания и наконечники, приведенные в каталоге, могут быть установлены на конкретные двигатели в соответствии с рекомендациями в каталоге. Видимые ошибки и очевидные описки подлежат проверки со стороны пользователей.

Отсутствие брака и правильность параметров продукции компания NGK гарантирует в соответствии с развитием техники. Гарантия действует только при надлежащей эксплуатации продукции компании NGK. Гарантия на отсутствие заводского брака и на качество используемых материалов действует 24 месяца с момента покупки товара, если иное не предписано производителем автомобиля.

Исключение составляет нормальный износ а также использования продукции в гоночных двигателях.

Автомобили производителей АвтоВАЗ обозначены VAZ, ГАЗ обозначены GAZ, УАЗ UAZ и Москвич MOSKWICZ. Не используйте для подбора свечей зажигания/накаливания обозначения LADA, VOLGA. Эти обозначения действуют для немецкого рынка.

# NGK Spark Plugs — OEM worldwide



## **JAPAN**

Daihatsu  
Fuji Heavy Industries  
Fuji-Robin  
Honda  
Ishikawajima-Shibaura  
Isuzu  
Kawasaki  
Kioritz  
Kubota  
Mazda  
Mitsubishi  
Nissan  
Shindaiwa  
Subaru  
Suzuki  
Tanaka  
Tohatsu  
Xenoa  
Yamaha  
Yanmar



## **ENGLAND**

Aston-Martin  
Jaguar  
Lotus  
Rolls Royce



## **AUSTRIA**

KTM  
Rotax  
Victa



## **SWEDEN**

Husqvarna  
Emab  
Saab



## **CZECH REPUBLIC**

Skoda



## **THAILAND**

BMW  
Citröen  
Peugeot  
Siam-Inter  
Volvo



## **CANADA**

Bombardier  
Emab  
Honda  
Kawasaki  
Mercury Marine  
Tohatsu



## **GERMANY**

AMG  
Audi  
BMW  
Daimler  
Dolmar  
Maico  
Stihl  
VW



## **SPAIN**

Derby



## **UNITED STATES**

Arctco  
Echo  
Force (US Marine)  
Honda  
Kawasaki  
Mercury Marine  
Nissan  
Onan  
Polaris  
Scorpion  
Sno Jet  
Toro  
Toyota



## **ITALY**

Alfa Romeo  
Alpina  
Cagiva  
Fiat  
Ferrari  
Lancia  
Maserati  
Piaggio (Vespa)  
Sabart



## **BELGIUM**

Mercury Marine



## **FRANCE**

Honda  
MBK  
Peugoet MTC  
Renault



## **TAIWAN**

Vespa



## **BRAZIL**

Agrale  
Coloi  
DaimlerChrysler  
Fiat  
Ford  
GM  
Honda





**Delivering Innovations  
since 1936**

**NGK  
Racing  
spark plugs  
Series**

# Series of **NGK** racing spark plugs

Blue colour indicates resistor plugs.

Thread size (Hexagon size)	Spark plug type	Spark plug number	Heat rating	Firing end appearance	Electrode material		
					Center	Ground	
φ14×19mm(20.8mm)	BP-E	R4304A-⊙	<b>7,8,9,10</b>	Ⓐ ①	Gold Palladium	Nickel Alloy	
		R6918B-⊙	<b>7,8,9</b>	Ⓑ ①	Platinum	Nickel Alloy	
		R6918C-⊙	<b>9</b>	Ⓑ ①	Platinum	Nickel Alloy	
		R6021E-⊙	<b>8,9,10</b>	Ⓑ ①	Nickel Alloy	Nickel Alloy	
		R6061-⊙	<b>7,8,9,10,11</b>	Ⓒ ①	Nickel Alloy	Nickel Alloy	
		R6252E-⊙	<b>9,105</b> Gap0.6	Ⓒ ①	Nickel Alloy	Nickel Alloy	
	B-E	R6252K-⊙	<b>105</b> Gap0.8	Ⓒ ①	Nickel Alloy	Nickel Alloy	
		R6254E-⊙	<b>9,105</b> Gap0.6	Ⓒ ①	Nickel Alloy	Nickel Alloy	
		R6254K-⊙	<b>105</b> Gap0.8	Ⓒ ①	Nickel Alloy	Nickel Alloy	
		R7376-⊙	<b>7,8,9,10</b>	Ⓒ ①	<b>Iridium</b>	Platinum	
		Semi surface discharge	R5649-⊙	<b>9,10,11</b>	Ⓔ ①	Nickel Alloy	—
		Semi surface discharge	R6712-⊙	<b>9,10</b>	Ⓔ ①	Nickel Alloy	—
φ14×22mm(20.8mm)	Short	R6179A-⊙P	<b>105,11</b>	Ⓒ ②	Platinum	Platinum	
		R6179C-⊙PA	<b>105</b>	Ⓒ ②	Platinum	Platinum	
		R7376B-⊙	<b>9,10</b>	Ⓒ ①	<b>Iridium</b>	Platinum	
φ14×22mm(16.0mm)	Short	R7282A-⊙	<b>10,105,11</b>	Ⓒ ③	<b>Iridium</b>	Platinum	
		R7282-⊙	<b>7,8,9,10,105,11</b>	Ⓒ ③	<b>Iridium</b>	Platinum	
		R7282M-⊙	<b>11,115</b>	Ⓒ ③	<b>Iridium</b>	Platinum	
φ14×19mm(16.0mm)	BK-E(ISO)※1	R6888A-⊙	<b>8,9,10</b>	Ⓕ ⑫	Nickel Alloy	Nickel Alloy	
		R7433-⊙	<b>8,9,10</b>	Ⓐ ⑤	<b>Iridium</b>	Nickel Alloy	
		R7434-⊙	<b>8,9,10</b>	Ⓒ ⑤	<b>Iridium</b>	Platinum	
	BC-E(ISO)※1	R7279-⊙	<b>10</b>	Ⓓ ⑤	<b>Iridium</b>	Platinum	
		Semi surface discharge	R6601-⊙	<b>8,9,10,11</b>	Ⓔ ⑤	Nickel Alloy	—
		Semi surface discharge	R6711-⊙	<b>9,10</b>	Ⓔ ⑤	Nickel Alloy	—
	BCP-E(JIS)	R7435-⊙	<b>8,9,10</b>	Ⓐ ④	<b>Iridium</b>	Nickel Alloy	
		R7436-⊙	<b>8,9,10</b>	Ⓒ ④	<b>Iridium</b>	Platinum	
	BC-E(JIS)	Semi surface discharge	R5883-⊙	<b>9,10,11</b>	Ⓔ ④	Nickel Alloy	—
		Semi surface discharge	R6690-⊙	<b>9,10,11</b>	Ⓔ ④	Nickel Alloy	—
φ14×26.5mm(16.0mm)	LFR	Extra long reach	R7437-⊙	<b>8,9,10</b>	Ⓐ ⑭	<b>Iridium</b>	Nickel Alloy
		Extra long reach	R7438-⊙	<b>8,9,10</b>	Ⓒ ⑭	<b>Iridium</b>	Platinum
φ14×12.7mm(20.8mm)	B-H	R5525-⊙	<b>7,8,9,10,11</b>	Ⓑ ⑦	Gold Palladium	Nickel Alloy	
		R5530-⊙	<b>8,9,10,11</b>	Ⓓ ⑦	Gold Palladium	Platinum	
φ14×21.5mm(20.8mm)	Rotary Engine RX-7	R6725-⊙	<b>9,10,105,11,115</b>	Ⓓ ⑥	Platinum	Platinum	
		R7420-⊙	<b>9,10,105,11</b>	Ⓓ ⑥	<b>Iridium</b>	Platinum	
φ14×21mm(20.8mm)	Rotary Engine RX-8 L	R7440A-⊙L	<b>9,10</b>	Ⓒ ⑮	<b>Iridium</b>	Platinum	
φ14×19mm(20.8mm)	Rotary Engine RX-8 T	R7440B-⊙T	<b>10,11</b>	Ⓒ ⑮	<b>Iridium</b>	Platinum	
φ12×19mm(16.0mm)	DC-E	Semi surface discharge	R2349-⊙	<b>9,10,11</b>	Ⓔ ⑧	Nickel Alloy	—
			R2525-⊙	<b>9,10,11</b>	Ⓒ ⑧	Platinum	Nickel Alloy
			R0373A-⊙	<b>8,9,10</b>	Ⓒ ⑨	<b>Iridium</b>	Platinum
φ10×19mm(16.0mm)	C-E	Semi surface discharge	R0045G-⊙	<b>10,11</b> GAP1.4	Ⓔ ⑨	Nickel Alloy	—
		Semi surface discharge	R0045J-⊙	<b>9,10,11,12</b> GAP1.1	Ⓔ ⑨	Nickel Alloy	—
		Semi surface discharge	R0045Q-⊙	<b>10,11</b> GAP1.1	Ⓔ ⑨	Nickel Alloy	—
φ10×19mm Half thread (16.0mm)	C-EH	R0409B-⊙	<b>8,9,10</b>	Ⓒ ⑮	<b>Iridium</b>	Nickel Alloy	
φ10×12.7mm(16.0mm)	C-H	R0161-⊙	<b>9,10,11</b>	Ⓑ ⑩	Nickel Alloy	Nickel Alloy	
φ8×19mm Half thread (13.0mm)	E-EH	Semi surface discharge	R847-⊙	<b>10,11</b>	Ⓔ ⑪	Nickel Alloy	—

1) ISO: The length from gasket to terminal of ISO type spark plugs is 50.5mm which is 2.5mm shorter than BCP-E or BC-E type spark plugs.  
 2) Resistor spark plugs are recommended for cars originally equipped with resistor spark plugs. When nonresistor spark plugs are installed in such cars, there is some possibility that the electric devices in the car, such as the audio system or the engine management system, would be affected by noise.  
 3) Marked \* part number will be discontinued when the current stock is over.

## Appearance

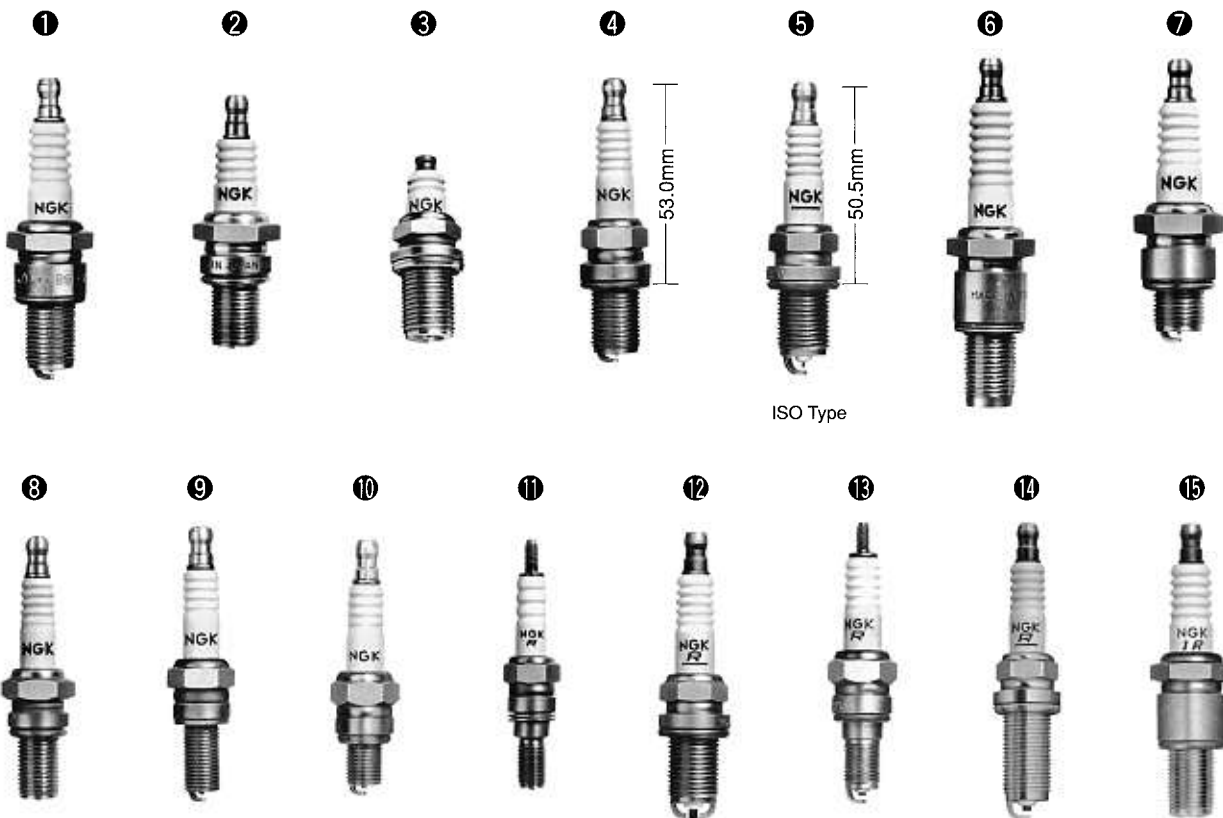

ISO Type

## Firing end



## Discontinued plug types

Blue colour indicates resistor plugs.

Old part number		New part number
R016 - ○, R017 - ○	→	R0373A - ○
R216 - ○, R217 - ○	→	R2525 - ○
R2270 - ○, R2430 - ○	→	R2349 - ○
R4630A - ○, R6385 - ○	→	R7376 - ○
R6120 - ○	→	R7282 - ○
R6120A - ○	→	R7282A - ○
R6120C - ○	→	R7282C - ○
R6120M - ○	→	R7282M - ○
R6255 - ○, R6255F - ○, R6326 - ○	→	R7433 - ○
R6205 - ○, R6241 - ○	→	R7433 - ○
R6206 - ○, R6242 - ○	→	R7434 - ○

Old part number		New part number
R5400 - ○, R5400F - ○, R6337 - ○	→	R7435 - ○
R5686 - ○	→	R7435 - ○
R5830 - ○, R5687 - ○	→	R7436 - ○
R7112 - ○, R7113 - ○	→	R7433 - ○
R7114 - ○, R7115 - ○	→	R7433 - ○
R7116 - ○, R7117 - ○	→	R7434 - ○
R7118 - ○, R7119 - ○	→	R7434 - ○
R7232 - ○, R7233 - ○	→	R7435 - ○
R7234 - ○, R7235 - ○	→	R7435 - ○
R7236 - ○, R7237 - ○	→	R7436 - ○
R7238 - ○, R7239 - ○	→	R7436 - ○

# Recommendation chart of NGK racing spark plugs for motorcycles

MotoGP: Repsol Honda Team



Manufacturer	Model	Spark plug Number	Racing spark plug IX, VX spark plug
--------------	-------	-------------------	-------------------------------------

## ● HONDA

Road race	CB1000SF/CB1300SF	DPR8EA-9	R2525-⊙		
	CB400 SuperFour	CR8EH-9	CR8EHIX-9, R0409B-⊙		
	CB400SS	DPR8EA	R2525-⊙		
	CBR1000RR	IMR9C-9HES	R0409B-⊙, R0045Q-⊙		
	CBR1100XX	IMR9C-9H	R0409B-⊙, R0045Q-⊙		
	CBR400RR	CR8EH-9	CR8EHIX-9, R0409B-⊙		
	CBR600F/FS/F4i/RR	IMR9C-9HES	R0409B-⊙, R0045Q-⊙		
	CBR900RR/CBR954RR	IMR9C-9H	R0409B-⊙, R0045Q-⊙		
	NS-1/NSR50	BR8ES	BR8EIX, R7376-⊙		
	NSR250R/SE/RSP	BR9ECM	BR10ECMIX		
	RVF/RC45	CR9EHIX-9	R0409B-⊙, R0045Q-⊙		
	VTR1000F	DPR8EVX-9	R2525-⊙		
	VTR1000SP/II	IFR9H11	R7279-10		
	RS125R	-	R7376-⊙, R7282A-⊙※1		
	RS250R	-	R7282-⊙, R7282A-⊙※1		
	Off road	XR250/Motard	CR8EH-9	CR8EHIX-9, R0409B-⊙	
		XR400/Motard	DPR8Z	DPR8ZIX	
		Motocross	CR125R	BR9EG	BR9EIX, R7376-9
			CR250R	BR8EG	BR8EIX, R7376-8
			CR80R/ II	B10EG	BR10EIX, R7376-⊙
CR85R/ II			BR10EG	BR10EIX, R7376-⊙	
CRF100F			CR7HSA	CR7HIX	
CRF150R/II			R0409B-9	R0409B-9	
CRF250R			R0409B-8	R0409B-8	
CRF450R			IFR8H11	R7433-8	
CRF50F/CRF70F	CR6HSA		CR6HIX		
QR50	BPR4HS		-		
Trial	XR250R	CR9EH-9	CR9EHIX-9, R0409B-9		
	XR50R/XR70R	CR6HSA	CR6HIX-⊙		
	RTL250R	BR6ES	R7376-⊙		
	RTL250F	CR6EH-9	-		
	TLM200R	B8ES	BR8EIX		
	TLM220R	BR8ES	BR8EIX		
	TLM260R	B6ES	B6EVX		
	TLR250R	D8EA	DR8EIX		
	TLR260	BR6ES	-		

## ● YAMAHA

Road race	FZ400	D8EA	R2525-⊙
	FZ50 5FC	BR8ES	BR8EIX, R7376-⊙
	SR400/SR500	BPR6ES	BPR6EIX, R7376-⊙
	SRV250	CR7HSA	CR7HIX
	TDM850/TRX850	DPR8EA-9	R2525-⊙
	TZM50R/TZR50R/TZR250SP	BR9ES	BR9EIX, R7376-⊙
	TZR250SPR/RS/R	BR9ECM	BR10ECMVX
	XJR1200R/XJR1300	DPR8EA-9	R2525-⊙
	XJR400R/RII	CR9E	R0373A-⊙, R0045Q-⊙
	YZF1000R/R1	DR8EA	R2525-⊙
	YZF750SP	CR9E	R0373A-⊙, R0045Q-⊙
	YZF-R1	CR9EK	R0373A-⊙, R0045Q-⊙
	YZF-R6	CR10EK	R0373A-⊙, R0045Q-⊙
	YZF-R7	-	R0373A-⊙, R0045Q-⊙
	TZ125	R6385-105P	R7376-10, R7376B-10※1
	TZ250	R6179A-105P	R6179A-105P, R6179C-105PA※1
	Off road	TT250R	CR9E
TY250Z/ZS		BP6EV	BPR6EIX
XT225W/WE		DR8EA	DR8EIX
Motocross	PW50	BPR4HS	-
	WR250Z/F/WR400F/WR450F	CR8E	CR8EIX
	YZ125	BR9EVX	BR9EIX, R7376-9
	YZ250	BR8EG	BR8EIX, R7376-8
	YZ250F/YZ426F/YZ450F	CR8E	CR8EIX
	YZ80/LW/YZ85/LW	BR10EG	BR10EIX, R7376-⊙
Trial	TY250Z	BP6EV	BPR6EIX

※1: The thread length is longer than the normal type due to setting the detonation counter.

※2: You need terminal nut.

Manufacturer	Model	Spark plug Number	Racing spark plug IX, VX spark plug
--------------	-------	-------------------	-------------------------------------

## ● KAWASAKI

Road race	D-TRACKER	CR8E	R0373A-⊙, R0045Q-⊙	
	GPZ1100/ABS	CR9EK	R0373A-⊙, R0045Q-⊙	
	GPZ900R	DR9EA	R2525-⊙	
	Z-1	B8ES	BR9EIX, R7376-⊙	
	ZEPHYR1100/RS	CR9E	R0373A-⊙, R0045Q-⊙	
	ZRX1100/II/ZRX1200R/S	CR9EK	R0373A-⊙, R0045Q-⊙	
	ZX-10R	CR9EIA-9	R0373A-⊙, R0045Q-⊙	
	ZX-12R	CR9EKPA	R0373A-⊙, R0045Q-⊙	
	ZX-6R/RR/ZX-7RR	CR9E	R0373A-⊙, R0045Q-⊙	
	ZX-9R/ZXR400/R	CR9EK	R0373A-⊙, R0045Q-⊙	
	ZZ-R1100	CR9E	R0373A-⊙, R0045Q-⊙	
	Off road	KLX250(1998.2~)	CR8E	CR8EIX, R0373A-⊙
		KX125(~2003)	BR9EIX	R7376-9
	Motocross	KX125(2004~2005)	R6918B-9	R6918B-9, R7376-9
		KX125(2006~)	BR9ECMVX	BR9ECMIX
		KX250(~2004)	BR8EIX	R7376-8
		KX250(2005~)	BR8ECMVX	BR8ECMIX
KX250F(2004~2005)		CR8EB	CR8EIX※2	
KX250F(2006~)		CR8E	CR8EIX	
KX450F		CPR8EB-9	-	
KX65		B10EG	BR10EIX, R7376-⊙	
KX85/II		-	BR9EIX, R7376-9	

## ● SUZUKI

Road race	GS1200SS/GSF1200	JR8B	R2525-⊙	
	GSX1300R	CR9E	R0373A-⊙, R0045Q-⊙	
	GSX-R1100W/GSX-R1000	CR9E	R0373A-⊙, R0045Q-⊙	
	GSX-R600/GSX-R750/RF600	CR9E	R0373A-⊙, R0045Q-⊙	
	RG125F(1991.11~)	BR9ECM	BR10ECMVX	
	RGV-R250SP(1990.2~)	BR9ECM	BR10ECMVX	
	SGX1100J	DR8EA	R2525-⊙	
	TL1000R	CR8EK	R0373A-⊙, R0045Q-⊙	
	TL1000S	CR8E	R0373A-⊙, R0045Q-⊙	
	Motocross	RM125	R6918B-8	-
		RM250	R6918B-7	-
		RM80/RM85	BR10ES	BR10EIX, R7376-⊙
		RM-Z250(2005~2006)	CR8EB	CR8EIX※2
RM-Z250(2007)		CR8EIA-10	CR8EIA-10, R0373A-⊙	
RM-Z450(2005~2006)		CR8EIB-10	-	
RM-Z450(2007)		DIMR8A10	-	

## ● BIMOTA

Road race	SB6R	CR9E	R0373A-⊙, R0045Q-⊙
-----------	------	------	--------------------

## ● BMW

Road race	R1100S	BKR7EKC	R7434-⊙
-----------	--------	---------	---------

## ● DUCATI

Road race	748R/S	DCR9EIX	R2525-⊙
	749S	CR9EVX	R0373A-⊙, R0045Q-⊙
	916SP/SPS/996SPS	R2349-10	-

## ● GAS-GAS

Trial	TXT250	BPR5ES	BPR5EIX
	TXT280	BPR5ES	BPR5EIX

## ● KTM

Motocross	125SX/200SX	BR9EVX	BR9EIX, R7376-9
	250SX	BR8ECM	BR8ECMVX
	450SX-R	DCPR8E	R2525-⊙
	50SX	BR8ECM	BR8ECMVX
	525SX	DCPR8E	R2525-⊙
	65SX/85SX	-	R7435-10

## ● LAVERDA

Road race	750s Formula	DCR8EIX	R2525-⊙
-----------	--------------	---------	---------

## ● MONTESA

Trial	COTA315	BR6ES	-
-------	---------	-------	---



# Choosing a racing plug

## ■ Choose the right spark plug for your engine based on heat range and electrode design, engine tuning, and racing conditions.

### ■ Heat range

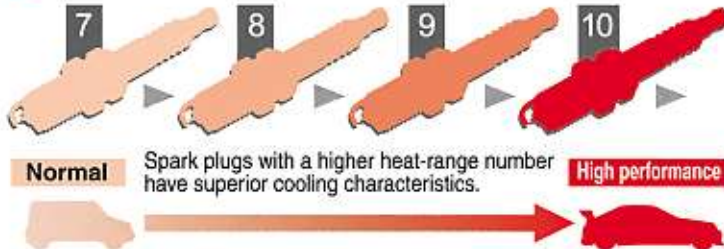

### ■ Electrode design

- Engine tuning
- Torturous racing conditions
- Avoid problems due to extremes of temperature

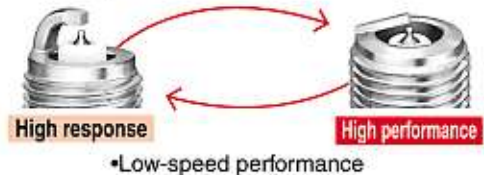

Racing plugs for both two- and four-wheel vehicles have been developed and designed for use in engines that have been fine-tuned to achieve maximum power under specific racing conditions. Racing plugs differ from standard plugs, both in appearance and performance, and often sacrifice plug life, and efficiency at low-speeds for optimum performance and durability under torturous racing conditions.

## ■ What to look for when choosing a racing plug

### Point 1

Shell design – To determine what kind of shell design fits in your engine, check the serial number of regulation plugs or the plugs you are currently using to verify the thread diameter, pitch, thread length and shell seat.

### Point 2

Firing End design – Refer to the section below on electrode design to determine which type is best for your needs.

### Point 3

Heat range – It's important to choose a racing plug with a heat range that keeps the electrode at an optimum temperature under even the most torturous racing conditions. And remember: A higher heat-range number does not improve engine performance, it increases the plug's ability to dissipate heat.

### Point 4

Resistors – Due to advances in ignition-system technology, there is little if any difference in performance between plugs with resistors and those without. However there are still some variations of some models that require plugs with resistors to avoid engine trouble.

## ■ Choosing a firing end design

Although a good rule of thumb is that the more an electrode projects into the cylinder, the better ignition it provides, it's also true that longer projections are more susceptible to the wear and tear of extreme temperatures. High-power, high-performance engines, of course, not only run hotter, they also vibrate more, which is why we recommend choosing a firing end design that reduces exposure of the electrode and insulator as much as possible.

### Projected type



Quite similar to a standard spark plug electrode, these plugs give good overall performance in lightly tuned and naturally aspirated engines, as well as good performance in the low to medium torque range in turbo engines.

### Angled ground strap type



These provide superior performance in turbocharged engines with power boosts of 50% or more. The short ground electrode is also highly durable against mechanical shock.

### Semi-surface discharge



In a sense, this is the ultimate plug configuration. Nearly all insulator cracking and electrode melting can be prevented with this type. Nevertheless, service life and low-speed performance may suffer slightly.

Once you've found a plug that matches your needs, give it a try and feel the exhilaration of getting 120% performance from your engine.

## INSTALLATION

To install spark plugs in the engine, first tighten them by fingers, then retighten with the right tightening torques as shown below, using a plug wrench.

Either excessive tightness or looseness will cause troubles. Looseness sometimes causes pre-ignition because heat cannot disperse. On the other hand, excessive tightness can damage the threads of both the cylinder head and the spark plug.

### ■ Tightening angles

Thread size	New gasket	Used gasket
φ14mm (except※)	$\frac{2}{3}$ of a turn(240°)	$\frac{1}{12}$ of a turn(30°)
φ12mm φ10mm	$\frac{1}{2}$ of a turn(180°)	$\frac{1}{12}$ of a turn(30°)
φ8mm	$\frac{1}{3}$ of a turn(120°)	$\frac{1}{12}$ of a turn(30°)
※ R6469-9 R6918C-9	$\frac{1}{3}$ of a turn(120°)	$\frac{1}{12}$ of a turn(30°)

### ■ Tightening torques

Spark plug type (thread diameter)	Aluminium cylinder head
Flat seat type (with gasket)	φ14mm 25~30N·m (2.5~3.0kg·m 18.0~21.6 lb·ft)
	φ12mm 15~20N·m (1.5~2.0kg·m 10.8~14.5 lb·ft)
	φ10mm 10~12N·m (1.0~1.2kg·m 7.2~8.7 lb·ft)
	φ 8mm 8~10N·m (0.8~1.0kg·m 5.8~7.2 lb·ft)

### ■ NGK Spark plug covers for racing spark plugs

Plug cover number (Colour)	Applicable plug type and cable
TRS1225 (Blue) *For Honda Racer only	R7282-  R7282A-  R7282C-  R7282M-  φ8mm cable
TRS1233A (Red) TRS1233B (Yellow) TRS1233C (Green)	R7282-  R7282A-  R7282C-  R7282M-  φ7mm cable
TRS1408F (Blue)	R5300A-  R5300N-  φ8mm cable
TRS1409 (Red)	R5540F-  φ7mm cable

# Как должны работать свечи зажигания при сгорании газа

## Зажигающая искра.

Основное правило: принцип действия свечей зажигания остаётся неизменным. Это касается так же и автомобилей, эксплуатируемых на двух видах топлива - бензине и газе - задача свечи зажигания состоит в воспламенении топливной смеси путём искрового пробоя.

Как известно, сжиженный газ труднее воспламенить, чем бензин. К этому надо добавить, что сжиженный газ агрессивней, чем бензин, что требует применения материалов, выносящих особую нагрузку. Поэтому рекомендуется установка свечей зажигания, удовлетворяющих специальным требованиям эксплуатации на двух видах топлива.

## Преимущества иридия.

Как ведущий поставщик и разработчик новаторских свечей зажигания и кислородных датчиков компания NGK предлагает свечи зажигания, гарантирующие надёжное зажигание в переоборудованных двигателях. В программе NGK найдётся подходящая свеча зажигания для многих двигателей. Эти свечи зажигания снабжены центральными электродами из благородных металлов иридия или платины, приваренными методом лазерной сварки.

## Свечи зажигания, подходящие к эксплуатации на двух видах топлива

- Иридий и платина чрезвычайно устойчивы к эрозии материалов.
- При эксплуатации на газе они также обеспечивают оптимальную воспламеняемость в течение длительного срока службы.
- Благодаря применению благородных металлов диаметр центрального электрода составляет всего 0,6 мм.
- Снижается напряжение зажигания.
- Особо тонкий центральный электрод способствует оптимальному распространению фронта пламени во все стороны.



Центральный электрод из иридия диаметром всего 0,6 мм

Вывод: свечи зажигания из иридия и платины обеспечивают надёжное и экологически безопасное зажигание - как при эксплуатации на бензине, так и на газе.

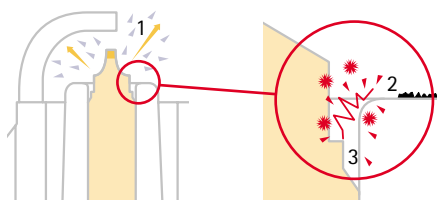

## Отсутствие отложений в кольцевом зазоре

- 1 Искра зажигания
- 2 Накопившиеся отложения
- 3 Отложение сгорают в кольцевом зазоре

## Принцип действия двигателя, эксплуатируемого на газе

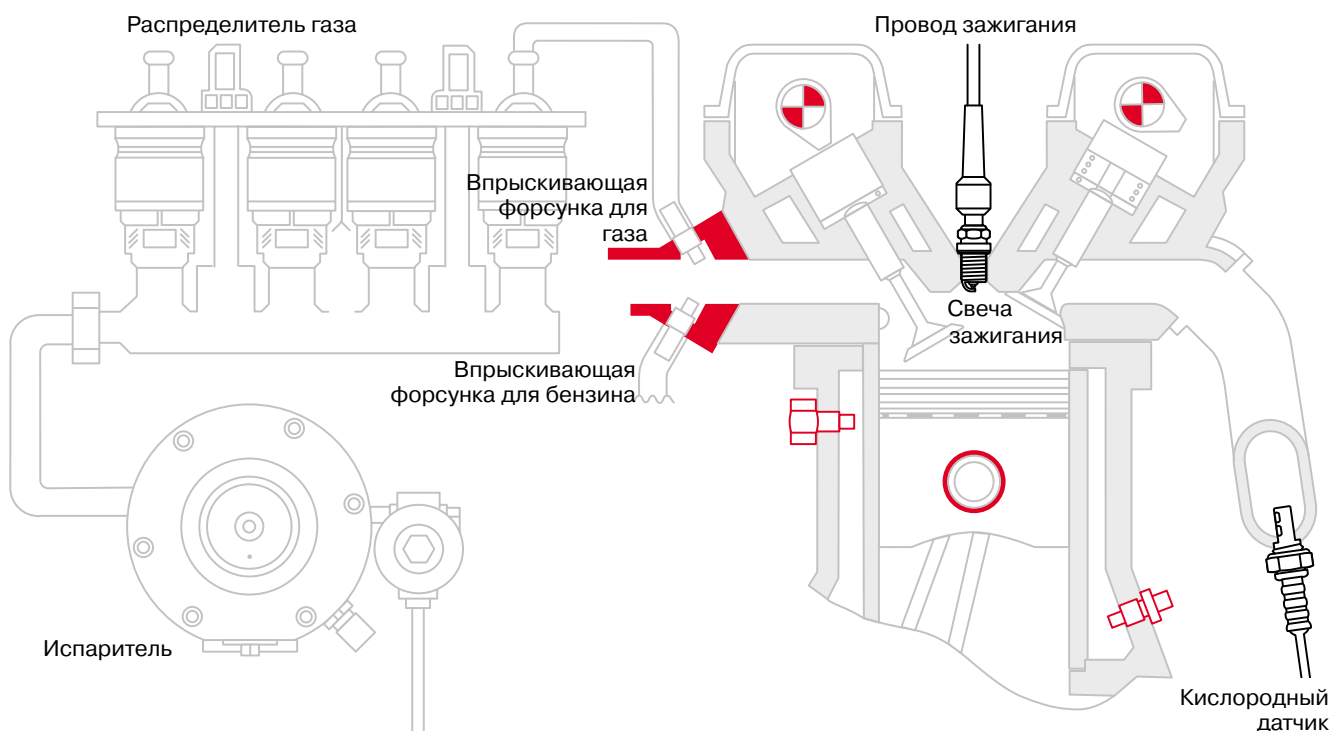

# Специальные свечи зажигания от фирмы NGK: Разработаны специально для двигателей, эксплуатирующихся на газе

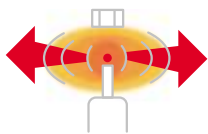

Равномерное распространение фронта пламени

Наряду с уже успешно применяемыми иридиевыми типами, компания NGK теперь также предлагает специальные свечи зажигания для автомобилей, эксплуатируемых на газе. Они наилучшим образом подготовлены для применения в переоборудованных автомобилях и уже на протяжении многих лет успешно используются в Японии - например, в такси, которые там почти все без исключения работают на газе.

## Эффективное покрытие

Свечи зажигания для применения на газовом двигателе покрыты хромовым сплавом, разработанным NGK специально для этой цели. Он дольше сохраняется в агрессивных условиях при эксплуатации на газе, чем обычные покрытия. В настоящее время нет других автомобильных свечей зажигания, имеющих подобное покрытие.

## Платина и иридий: Оптимальный дуэт

Также как свечи зажигания из иридия и платины, специальные свечи зажигания для автомобилей, эксплуатируемых на газе, имеют центральный электрод, приваренный методом лазерной сварки, диаметром всего 0,6 мм. Он изготовлен из иридия. К тому же боковой электрод имеет платиновое покрытие, что ещё больше улучшает износостойкость и, таким образом, продлевает срок службы свечи зажигания.

## Характеристики специальных свечей зажигания:

- Особенно долгий срок службы благодаря специальному покрытию корпуса, а также электродам из платины и иридия.
- Надёжное воспламенение и равномерное распространение фронта пламени.
- Хорошая воспламеняемость также и при эксплуатации на газе.
- Низкое требуемое напряжение зажигания.
- Улучшенные эмиссионные показатели по сравнению со стандартными свечами зажигания, также при эксплуатации на газе.

## Монтаж.

Монтаж свечи зажигания в двигателе, эксплуатируемом на двух видах топлива, не отличается от монтажа свечи зажигания в обычном двигателе. Перед демонтажем старой свечи зажигания следует очистить головку цилиндра. Новая свеча зажигания сначала вкручивается вручную, потом затягивается с помощью динамометрического ключа, при соответствующем моменте затяжки.

В некоторых случаях при установке газового оборудования оправдало себя минимальное сокращение межэлектродного зазора с целью облегчения искрового пробоя, не более чем на 0,3 мм по сравнению с обычно рекомендованным зазором для эксплуатации на бензине.

Моменты затяжки

	Свеча зажигания с плоской посадкой (с уплотнением)					Свеча зажигания с конической посадкой	
	18 mm	14 mm	12 mm	10 mm	8 mm	18 mm	14 mm
Чугунная головка	34-45 Nm	25-35 Nm	15-20 Nm	10-15 Nm	-	20-30 Nm	15-25 Nm
Алюминиевая головка	34-45 Nm	25-30 Nm	15-20 Nm	10-12 Nm	8-10 Nm	20-30 Nm	10-20 Nm



Свеча зажигания Иридий BPR6EIX-LPG

# Свечи зажигания NGK: Подходящее решение для двигателя, эксплуатируемого на газе



**Таблица подбора:**  
**Какую стандартную свечу зажигания можно заменить на иридиевый тип?**

Оригинальная свеча зажигания				Тип IX
BSP5ES	BCPR5ES	BCPR5ES-11	BCPR5EY	BCPR5EIX-11
BCPR5EY-11				
BCPR6E-11	BCPR6E	BCPR6ES	BCP6ES	BCPR6EIX-11
BCP6ET BCPR6E-11				
BCPR7ES	BCP7ET	BCP7ES	BCPR7ET	BCPR7EIX
BCPR7ES-11				
BKR5EK	BKR5EZ	BKR5E	BKR5ES	BKR5EIX
BKR5EY BKR5E-11 BKR5ES-11 BKR5EY-11				
BKR6EKC	BKR6E	BKR6ES	BKR6EZ	BKR6EIX-LPG
BKR6EY BKR6E-11 BKR6ES-11				
BKR7E				BKR7EIX
BP5ESZ	BPR5ES	BP5ES	BPR5EY	BPR5EIX
BP5EY BPR5EY-11 BPR5ES-11				
BP6ES	BP6E	BPR6ES	BPR6EY	BPR6EIX-LPG
BPR6ES-11 BPR6EY-11				
BP6HS BPR6HS				BPR6HIX
BP7ES BPR7ES				BPR7EIX
DCPR7E-N DCPR7E				DCPR7EIX
ZFR5F				ZFR5FIX-11
ZFR6F-11				ZFR6FIX-11

Три шага перед выполнением монтажа:

1. Определить тип предыдущей свечи зажигания
2. Найти в таблице альтернативную свечу зажигания\*
3. При необходимости, сократить зазор между электродами не более чем на 0,3 мм.

**\* Примечание:**

В установках LPG по системе Venturi следует применять свечи зажигания следующего по возрастанию калильного числа (напр., BKR5E => BKR6EIX-LPG).

В автомобилях, оснащённых уже на заводе-изготовителе высококачественными платиновыми или иридиевыми свечами зажигания NGK, не следует применять другие типы. При необходимости следует юстировать межэлектродный зазор.

# ... сбытовая концепция со множеством преимуществ

- 1. Система числовой кодировки:**  
Числа от 1 до 35 позволяют быстро найти нужную свечу зажигания.
- 2. Компактность:**  
Небольшая занимаемая площадь благодаря компактным размерам. Тем самым остается больше места для размещения других товаров.
- 3. Привлекательная упаковка:**  
Яркая упаковка привлекает покупателей и способствует более быстрой продаже.
- 4. Большая скорость оборота товаров:**  
35 типов свечей подходят для 97 % всех легковых автомобилей. Это повысит Вашу рентабельность.
- 5. Сбыт через специализированные магазины:**  
Отсутствие конкуренции с универсальными магазинами и супермаркетами.
- 6. Снижение расходов:**  
Низкие складские расходы увеличивают Вашу прибыль.
- 7. Экологический фактор:**  
Большая надежность зажигания. Тем самым уменьшение расхода топлива, выделения выхлопных газов и более длительный период эксплуатации катализатора, в результате лучшее отношение покупателей. Экологически чистая картонная упаковка без блистера.
- 8. Реклама для конечных потребителей:**  
Фирма NGK заботится о росте спроса у Ваших покупателей.



Весь ассортимент из 35 наименований Вы можете представительно и обзорно разместить в напольном контейнере. Благодаря интегрированному классификационному списку поиск нужной свечи зажигания становится просто детской забавой!



Вы можете разместить свечи, упакованные по четыре, на имеющемся стенде с перфорацией вместе с откидным классификационным списком. Простая номерная система (номера от 1 до 35) позволяет безошибочно и быстро найти нужную свечу зажигания.



Ассортимент состоит из 35 различных типов свечей зажигания – всего 700 свечей, отсортированных по их спросу.

<b>V-Line No.</b>	<b>Car-Manufacturer</b>
1	BUR6ET Audi, Fiat, Lancia, Seat, Skoda, VW
2	BPR6E Alfa Romeo, Austin, Autobianchi, BMW, Chrysler, Daewoo, Daihatsu, Fiat, Ford, FSO, Honda, Hyundai, Innocenti, Isuzu, Lada, Lancia, Lotus, Mazda, MG, Mitsubishi, Nissan, Opel, Porsche, Renault, Rover, Seat, Subaru, Suzuki, TVR, Vauxhall, Volvo, Zastava
3	BPR6H Daewoo, Opel, Vauxhall
4	BP6E Alfa Romeo, Aston Martin, Audi, Austin, BMW, Citroen, Fiat, FSO, Innocenti, Lada, Lotus, Maserati, Mercedes, Mitsubishi, Morgan, Moskwicz, Nissan, Peugeot, Renault, Rover, Saab, Seat, Subaru, Talbot, Tofas, Volvo, VW, Wartburg, Yugo, Zastava
5	BP6EF Citroen, Mercedes, Peugeot, Renault, Rover, Talbot
6	BPR5E Asia, Daihatsu, Fiat, Honda, Innocenti, Mazda, Mitsubishi, Nissan, Opel, Renault, Rolls Royce, Rover, Seat, Suzuki, Toyota, TVR, Vauxhall
7	BPR6EF Chevrolet, Ford, Lancia, Renault, TVR, Volvo
8	BP5E BMW, Citroen, Daimler, Isuzu, Jaguar, Mitsubishi, Nissan, Renault, Rover, VW
9	BPR5EY Daihatsu, Innocenti, Suzuki, Toyota
10	BPR6EY-11 Daihatsu, Honda, Toyota
11	BCPR6E-11 Ford, Honda, Mazda, Nissan, Renault, Rover, Saab, Subaru
12	BCPR6E Aston Martin, Autobianchi, Chrysler, Citroen, Daimler, Fiat, Ford, FSO, Jaguar, Lada, Lancia, Mazda, Morgan, Nissan, Opel, Peugeot, Porsche, Rover, Skoda, TVR, Volvo
13	BPR6ES-11 Honda, Hyundai, Isuzu, Kia, Mazda, Mitsubishi, Nissan, Opel, Rover, Subaru, Suzuki, Vauxhall
14	BKR6E-11 Daewoo, Daihatsu, Honda, Hyundai, Isuzu, Kia, Lotus, Mazda, Mitsubishi, Nissan, Proton, Rover, Subaru, Suzuki
15	ZGR5A BMW, Daihatsu
16	BCP5E Citroen, Mercedes, Nissan, Peugeot, Renault, Ssangyong
17	BCP6E Alfa Romeo, Citroen, Lada, Mercedes, Nissan, Peugeot, Renault, Rover, Skoda, Ssangyong, Tatra
18	BP6H Citroen, Dacia, Renault, Seat, Skoda, Z.A.Z., Zastava
19	BPR7E Alfa Romeo, Austin, Autobianchi, Caterham, Fiat, Ford, Lancia, Lotus, Mitsubishi, Porsche, Renault, Rover, Subaru, Volvo
20	BKR6EK BMW, Citroen, Fiat, Lancia, Mercedes, Opel, Peugeot, Porsche, Renault, Vauxhall, VW, Wiesmann
21	BUR5ET-10 Audi, Seat, VW
22	BUR5ET Audi, Seat, VW
23	BKR5EK Citroen, Daewoo, Fiat, Lancia, Opel, Peugeot, Saab, Vauxhall
24	BKUR6ET-10 Audi, Mercedes, Seat, Skoda, VW
25	PTR5A-13 Ford, Mazda, Morgan
26	BKR6EKC Fiat, Lancia, Lotus
27	BKUR6ET Audi, Fiat, Lancia, Seat, Skoda, VW
28	BKR6E Caterham, Chrysler, Daihatsu, Kia, Lotus, Mazda, Nissan, Opel, Rover, Suzuki
29	BKUR5ET Mercedes, Seat, VW
30	BKR6EQUUP Alpina, Audi, BMW, Bentley, Land Rover, Mini, Morgan, Porsche, Rolls Royce
31	PTR5D-10 Aston Martin, Ford, Mazda
32	BCPR5ES Citroen, Nissan, Peugeot, Reliant, Renault, Skoda
33	BKR5E-11 Chevrolet, Chrysler, Daewoo, Daihatsu, Hyundai, Kia, Mazda, Mitsubishi, Nissan, Subaru
34	PZFR5D-11 Ford, Seat, Skoda, VW
35	BKR5E Kia, Mazda, Nissan, Ssangyong, VW

# Полный Ассортимент V-Line – ОДНИМ ВЗГЛЯДОМ

Номер V-Line Для заказа	Наименование свечи зажигания	Тип с аналогичным калильным числом:
V-Line № 01	BUR6ET	
V-Line № 02	BPR6E	BPR6ES
V-Line № 04	BP6E	BP6ES
V-Line № 05	BP6EF	BP6EFS
V-Line № 06	BPR5E	BPR5ES
V-Line № 07	BPR6EF	BPR6EFS
V-Line № 11	BCPR6E-11	BCPR6ES-11
V-Line № 12	BCPR6E	BCPR6ES
V-Line № 13	BPR6ES-11	
V-Line № 14	BKR6E-11	
V-Line № 15	ZGR5A	
V-Line № 16	BCP5E	BCP5ES
V-Line № 17	BCP6E	BCP6ES
V-Line № 19	BPR7E	BPR7ES
V-Line № 20	BKR6EK	
V-Line № 21	BUR5ET-10	
V-Line № 22	BUR5ET	
V-Line № 23	BKR5EK	
V-Line № 24	BKUR6ET-10	
V-Line № 25	PTR5A-13	
V-Line № 26	BKR6EKC	
V-Line № 27	BKUR6ET	
V-Line № 28	BKR6E	BKR6ES
V-Line № 29	BKUR5ET	
V-Line № 30	BKR6EQUP	
V-Line № 31	PTR5D-10	
V-Line № 32	PCPR5E	PCPR5ES
V-Line № 33	BKR5E-11	
V-Line № 34	PZFR5D-11	
V-Line № 35	BKR5E	



# СВЕЧИ ЗАЖИГАНИЯ V-LINE – преимущества на протяжении всей линии

## 1. Надежное зажигание:

### больше защиты для окружающей среды

Благодаря конструкции V-Line сокращается до минимума опасность возникновения перебоев в процессе искрообразования. За счет этого предупреждаются отрицательные последствия перебоев искрообразования, например, повышенный расход топлива и повышенные выбросы вредных веществ, оказывающих нагрузку на окружающую среду.

## 2. Надежное зажигание: больше защиты для каталитического нейтрализатора ОГ

Насколько важна надежная работа свечи зажигания, особенно наглядно проявляется на примере каталитического нейтрализатора ОГ: его срок службы и эффективность зачастую ограничиваются в результате незаметных перебоев искрообразования, которых вполне можно избежать. Свечи зажигания V-Line обеспечивают эффективную защиту для каталитического нейтрализатора ОГ.

## 3. Надежность для водителя:

### качество на уровне предприятия-изготовителя

Свечи зажигания фирмы NGK являются высококачественными изделиями. Доказательство: они применяются во всем мире крупными изготовителями двигателей и автомобилей в рамках серийного производства: Alfa Romeo, Audi, BMW, Fiat, Honda, Mazda, Mitsubishi, Renault, Rover, Saab, Seat, Toyota, VW и т. д.

### V-Line № 1, 21, 22, 24, 27, 29

свеча зажигания с 3 боковыми электродами

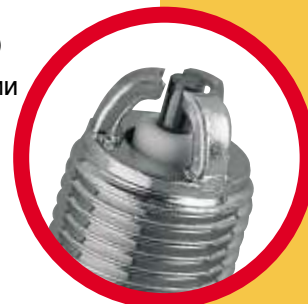

### V-Line № 2-12, 14-19, 28, 32, 33, 35

свечи зажигания с V-образной насечкой на центральном электроде; патент № DE 2922 305 C2



### V-Line № 20, 23

свеча зажигания с 2 боковыми электродами



### V-Line № 30

свеча зажигания с 4 боковыми электродами



### V-Line № 31, 34

свеча зажигания с 1 боковыми электродами



# СВЕЧИ ЗАЖИГАНИЯ V-LINE – преимущества на протяжении всей ЛИНИИ



**V-Line № 1, 21,  
22, 24, 27, 29**  
свеча зажигания  
с 3 боковыми  
электродами



**V-Line № 2-12, 14-  
19, 28, 32, 33, 35**  
свечи зажигания  
с V-образной  
засечкой на  
центральной  
электроде;  
патент № DE  
2922 305 C2



**V-Line № 20, 23**  
свеча зажигания  
с 2 боковыми  
электродами



**V-Line № 30**  
свеча зажигания  
с 4 боковыми  
электродами

## **V-Line № 1, 21, 22, 24, 27, 29**

### **Свеча зажигания с 3-мя боковыми электродами для концерна VW**

Фирма NGK выпускает этот тип свечей зажигания специально для автомобилей производства концерна VW. Ими могут оснащаться почти все новые модели (смотри перечень соответствия). Интервалы замены свечей согласованы с интервалами техосмотров предписанными изготовителем автомобилей.

#### **Технические преимущества:**

использование специального материала изоляторов дает возможность удлинить вершину теплового конуса изолятора. Кроме того, был оптимизирован медный сердечник внутри центрального электрода. Обе меры способствуют еще лучшему отводу тепла. Увеличенный таким образом температурный диапазон нормальной работы обеспечивает надежный пуск и еще более стабильную характеристику зажигания даже в экстремальных условиях эксплуатации двигателя и автомашины.

## **V-Line № 2 – 12, 14 – 19, 28, 32, 33, 35**

С точки зрения технологии принцип действия отличается гениальной простотой, но еще и хорошей эффективностью: в центральном электроде свечи зажигания V-Line находится V-образная засечка. Вследствие этого воспламеняющая искра перескакивает на наружную сторону центрального электрода. В этом месте скапливается способная воспламениться топливовоздушная смесь в большем количестве, чем непосредственно между электродами. Дополнительный плюс: требуется меньше вторичного напряжения системы зажигания. Тем самым повышается надежность зажигания! **ОСОБЕННО В СОВРЕМЕННЫХ ДВИГАТЕЛЯХ, ТОПЛИВОВОЗДУШНАЯ СМЕСЬ КОТОРЫХ ДОВОДИТСЯ ДО ОЧЕНЬ БЕДНОЙ СТЕПЕНИ НАСЫЩЕНИЯ В ИНТЕРЕСАХ СОКРАЩЕНИЯ ВЫБРОСОВ ВРЕДНЫХ ВЕЩЕСТВ, КОНСТРУКЦИЯ NGK В ЛЮБЫХ УСЛОВИЯХ ОБЕСПЕЧИВАЕТ АБСОЛЮТНО НАДЕЖНОЕ ВОСПЛАМЕНЕНИЕ СМЕСИ, В ТОМ ЧИСЛЕ И В ЭКСТРЕМАЛЬНЫХ УСЛОВИЯХ ЭКСПЛУАТАЦИИ!**

## **V-Line № 20, 23**

Принцип действия свечи зажигания для BMW: если на вершине теплового конуса изолятора имеются токопроводящие отложения, то утекающее вторичное напряжение системы зажигания "перехватывается", а между изолятором и боковым электродом возникает воспламеняющая искра. При этом отложения сажи удаляются и топливовоздушная смесь надежно воспламеняется.

## **V-Line № 30**

Результатом тесного сотрудничества между BMW и NGK явилась разработка свечи зажигания BKR6EQUP с большим сроком службы, оснащенной центральным электродом из платины и 4-мя боковыми электродами с современной технологии полуповерхностного разряда. Применение техники полуповерхностного разряда возможно только благодаря специальному дизайну внутреннего окончания изолятора. С помощью этой техники обеспечивается образование искры только между теми электродами, которые в данный момент времени обеспечивает надежное зажигания воздушно-топливной смеси. Так как каждая искра перед тем, как перескочит от изолятора на боковой электрод, сначала «скользит» через окончание внутренней части изолятора, возможно возникший нагар мгновенно удаляется, и таким образом предотвращаются пропуски в зажигании. Оптимальные параметры холодного запуска при очень низких температурах и высочайшая надежность зажигания даже при экстремальных условиях эксплуатации таким образом гарантируются.

Этот новый тип свечей NGK применяется серийно на автомобилях BMW, начиная с 1997 года выпуска. Допуск к установке этого типа свечи на определенные более поздние автомобили BMW, начиная с 1987 года выпуска, был одобрен задним числом.

### V-LINE № 25

Для моделей FORD, оборудованных двигателями ZETEC, фирма NGK разработала двойную платиновую свечу зажигания PTR5A-13. Преимущества платиновых электродов заключаются в том, что требуется меньше вторичного напряжения системы зажигания. Таким образом появилась возможность увеличить зазор между электродами с тем, чтобы добиться стабильного сгорания и плавного холостого хода. Благодаря улучшенным характеристикам воспламенения удалось оптимизировать как эмиссию неочищенных выбросов, так и крутящий момент.



V-Line № 25

### V-LINE № 26

В сотрудничестве с FIAT фирма NGK разработала свечу зажигания VKR6EKC. Буква "С" обозначает специальную свечу зажигания для двигателей производства концерна FIAT. Свеча VKR6EKC безупречно работает даже в труднейших условиях эксплуатации — от движения по принципу "тронулся-остановился" при низкой температуре сгорания до максимальной температурной нагрузки двигателя при его полной нагрузке. Результаты испытаний показывают, что особая конструкция двух боковых электродов гарантирует высочайшую воспламеняемость, а также требуемый срок службы свечей зажигания в пределах рекомендованного фирмой Fiat интервала замены свечей зажигания.



V-Line № 26

### V-LINE № 31, 34

Для моделей FORD, оборудованных двигателями ENDURA, фирма NGK разработала двойную платиновую свечу зажигания PTR5D-10 (V-Line № 31). Преимущества платиновых электродов заключаются в том, что требуется меньше вторичного напряжения системы зажигания. Таким образом появилась возможность увеличить зазор между электродами с тем, чтобы добиться стабильного сгорания и плавного холостого хода. Благодаря улучшенным характеристикам воспламенения удалось оптимизировать как эмиссию неочищенных выбросов, так и крутящий момент.



V-Line № 31, 34

V-Line № 2-12, 14-19, 28, 32, 33, 35

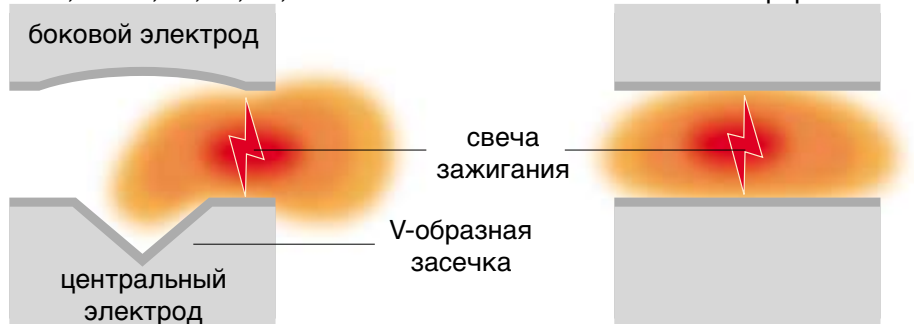

# МАРКИРОВАЧНЫЕ МЕТКИ НА СВЕЧАХ ЗАЖИГАНИЯ ФИРМЫ NGK

\* Здесь указаны стандартные обозначения. Также имеются несколько нестандартных обозначений.

	диаметр резьбы	Размер 6-гранного ключа	Особенности конструкции	Калильное число	Длина резьбы	
<b>A</b>	18 мм	25,4 мм	<b>L</b> Компактный тип (Shorty)	2		<b>E</b> 19,0 мм
<b>B</b>	14 мм	20,8 мм	<b>M</b> Компактный тип (Bantam)	4		<b>H</b> 12,7 мм
<b>C</b>	10 мм	16,0 мм	<b>P</b> Смещенный вперед наконечник изолятора	5		<b>L</b> 11,2 мм
<b>D</b>	12 мм	18,0 мм	<b>R</b> Тип с резистором	6		<b>EH</b> резьба до середины
<b>E</b>	8 мм	13,0 мм	<b>U</b> Тип поверхностного или полуповерхностного разряда	7		Общая длина: 19,0 мм
<b>G</b>	PF 1/2	23,8 мм	<b>Z</b> Тип индукционного резистора	8		Длина резьбы: 12,7 мм
<b>J</b>	12 мм	18,0 мм		(85)		<b>F</b> Конусное седло
<b>AB</b>	18 мм	20,8 мм		9		
<b>BC</b>	14 мм	16,0 мм		(95)		B-F тип 11,2 мм
<b>BK</b>	14 мм	16,0 мм		10		B-EF тип 17,5 мм
<b>DC</b>	12 мм	16,0 мм		(105)		
				11		
				12		
				13		

**BC P R 6 E S - 11**

Зазор свечи (мм)  
Нет: Стандартный зазор

Зазор свечи (мм)  
Нет: Стандартный зазор

**P F R 6 A - 11 A**

## Конструкция искрообразующего наконечника и т. п.

<b>C</b>	Заземленный электрод с низким углом
<b>F</b>	Конусное седло
<b>G</b>	Средний электрод из тонкого никелевого сплава
<b>GV</b>	Средний электрод особой конструкции из золота - палладия
<b>J</b>	Удлиненные 2-заземленные электроды
<b>K</b>	2-заземленные электроды
<b>M</b>	2-заземленные электроды для роторного двигателя Mazda или длины изолятора: 18,5 мм
<b>T</b>	3-заземленные электроды
<b>Q</b>	4-заземленные электроды
<b>P</b>	Платиновый электрод
<b>S</b>	Стандарт электрод из меди
<b>U</b>	Тип полуповерхностного разряда
<b>V</b>	Средний электрод из золота - палладия
<b>VX</b>	Средний электрод из платины и особый заземленный электрод
<b>W</b>	Вольфрамовый электрод
<b>X</b>	Зазор для увеличения производительности
<b>Y</b>	Средний электрод с V-образной выемкой
<b>A, B, D, E, Z</b>	Особый дизайн
<b>-L</b>	Половина калильного числа, напр.: DR8ESL=DR7,5ES диапазон
<b>-LM</b>	Компактный тип (длина изолятора: 14,5 мм)
<b>-N</b>	Особый заземленный электрод
<b>IX</b>	Иридий

## Типы свечей зажигания

<b>I</b>	С иридиевым электродом
<b>P</b>	С платиновым электродом
<b>Z</b>	С увеличенным зазором
<b>PZ</b>	С платиновым электродом и увеличенным зазором
<b>IZ</b>	С иридиевым электродом и увеличенным зазором

## Конструкция

<b>R</b>	Резистор
----------	----------

## Особенность

<b>A</b>	Беспрокладочный тип
<b>B</b>	Особая
<b>C</b>	Особая
<b>D</b>	Особая

## Конструкция

<b>A</b>	Особая конструкция
<b>B</b>	Особая конструкция
<b>C</b>	Особая конструкция
<b>D</b>	Особая конструкция

## Размеры металлического корпуса

<b>F</b>	14 Ш X 19 мм 16,0 мм., 6-гранник
<b>G</b>	14 Ш X 19 мм 20,8 мм., 6-гранник
<b>J</b>	12 Ш X 19 мм 18,0 мм., 6-гранник
<b>K</b>	12 Ш X 19 мм 16,0 мм., 6-гранник
<b>M</b>	10 Ш X 19 мм 16,0 мм., 6-гранник
<b>T</b>	Тип конусного седла 14 Ш X 17,5 мм 16,0 мм., 6-гранник (PTRSA: 14 Ш X 25 мм 16,0 мм., 6-гранник)

# TIGHTENING TORQUES FOR SPARK PLUGS

## ANZIEHDREHMOMENTE DER ZÜNDKERZEN

### COUPLES DE SERRAGE DES BOUGIES

#### PAR DE APRIETE PARA LAS BUJÍAS DE ENCENDIDO

##### ÅTDRAGNINGSMOMENT VID TÄNDSTIFTSMONTERING



	Flat seat type (with gasket) Zündkerze mit flachem Sitz (mit Dichtung) Modèle á siége plat (avec joint) Tipo de asiento plano (con emPaquetadura) Tändstift med packning					Conical seat type Zündkerze mit konischem Sitz. Modèle á siége conique Tipo de asiento cónico För koniskt säte	
	18 mm	14 mm	12 mm	10 mm	8 mm	18 mm	14 mm
Cast iron head Gußeisenkopf Culasse en fonte Culata de hierro fundido Cylinderlock av gjutjärn	35-45 N·m (3,5-4,5 m·kg) (25,3-32,5 lbs·ft.)	25-35 N·m (2,5-3,5 m·kg) (18,0-25,3 lbs·ft.)	15-25 N·m (1,5-2,5 m·kg) (10,8-18,0 lbs·ft.)	10-15 N·m (1,0-1,5 m·kg) (7,2-10,8 lbs·ft.)	—	20-30 N·m (2,0-3,0 m·kg) (14,5-21,6 lbs·ft.)	15-25 N·m (1,5-2,5 m·kg) (10,8-18,0 lbs·ft.)
Aluminium head Aluminiumkopf Culasse en aluminium Culata de aluminio Cylinderlock av lättmetall	35-40 N·m (3,5-4,0 m·kg) (25,3-28,9 lbs·ft.)	25-30 N·m (2,5-3,0 m·kg) (18,0-21,6 lbs·ft.)	15-20 N·m (1,5-2,0 m·kg) (10,8-14,5 lbs·ft.)	10-12 N·m (1,0-1,2 m·kg) (7,2-8,7 lbs·ft.)	8-10 N·m (0,8-1,0 m·kg) (5,8-7,2 lbs·ft.)	20-30 N·m (2,0-3,0 m·kg) (14,5-21,6 lbs·ft.)	10-20 N·m (1,0-2,0 m·kg) (7,2-14,5 lbs·ft.)

To install new spark plugs in the engine, first tighten them by fingers, then retighten the plug using a plug wrench. (See below)

Spark plug thread size	Plug wrench	
Gasket type	New gasket	Used gasket
18mm, 14mm	1/2 to 2/3 turn (180 to 240 degrees)	1/12 turn (30 degrees)
12mm, 10mm	1/2 turn (180 degrees)	1/12 turn (30 degrees)
8mm	1/3 turn (120 degrees)	1/12 turn (30 degrees)
Conical seat type	No gasket	
18mm, 14mm	1/12 turn (30 degrees)	

Para instalar bujías nuevas en el motor, primero apriételas a mano, y luego vuelva a apretarlas con una llave de bujías. (Véase la siguiente tabla.)

Tamaño de rosca de bujías	Llave de bujías	
Tipo junta	Junta nueva	Junta reutilizada
18mm, 14 mm	1/2 a 2/3 vuelta (180 a 240 grados)	1/12 vuelta (30 grados)
12mm, 10 mm	1/2 vuelta (180 grados)	1/12 vuelta (30 grados)
8mm	1/3 vuelta (120 grados)	1/12 vuelta (30 grados)
Tipo asiento cónico	Sin junta	
18mm, 14mm	1/12 vuelta (30 grados)	

Zum Installieren der neuen Zündkerzen in den Motor, diese zuerst mit der Hand festziehen und dann mit einem Zündkerzenschlüssel festziehen. (Siehe unten.)

Zündkerzen-Gewindedurchmesser	Drehmomentschlüssel	
Dichtungstyp	Neue Dichtung	Alte Dichtung
18mm, 14mm	1/2 bis 2/3 Umdrehung (180 to 240 Grad)	1/12 Umdrehung (30 Grad)
12mm, 10mm	1/2 Umdrehung (180 Grad)	1/12 Umdrehung (30 Grad)
8mm	1/3 Umdrehung (120 Grad)	1/12 Umdrehung (30 Grad)
Kegeldichtstyp	Keine Dichtung	
18mm, 14mm	1/12 Umdrehung (30 Grad)	

Montera nya tändstift i motorn genom att först skruva i dem för hand och sedan dra åt dem med hjälp av en tändstiftsnyckel (se nedan).

Gångstorlek på tändstift	Tändstiftsnyckel	
Tändstift med packning	Ny packning	Använd packning
18mm, 14mm	1/2 till 2/3 varv (180-240°)	1/12 varv (30°)
12mm, 10mm	1/2 varv (180°)	1/12 varv (30°)
8mm	1/3 varv (120°)	1/12 varv (30°)
Tändstift med koniskt säte	Ingen packning	
18mm, 14mm	1/12 varv (30°)	

Pour mettre en place des bougies sur le moteur, visser d'abord chacune à la main, puis serrer la bougie en utilisant uné clé à bougie (voir le tableau ci-dessous).

Diamètre de filetage	Cle à bougie	
Type avec joint	Joint nouvel	Joint existant
18mm, 14mm	1/2 à 2/3 tour (180 a 240 degres)	1/12 tour (30 degres)
12mm, 10mm	1/2 tour (180 degres)	1/12 tour (30 degres)
8mm	1/3 tour (120 degres)	1/12 tour (30 degres)
Bougie à siége conique	Sans joint	
18mm, 14mm	1/12 tour (30 degres)	

## CONVERSION TABLE, MM ↔ Inch

### UMWANDLUNGSTABELLE, mm ↔ Zoll

#### TABLE DE CONVERSION, mm ↔ pouce

##### TABLA DE CONVERSION, mm ↔ PULGADAS

###### OMVÄNDLINGSTABELL, mm ↔ TUM

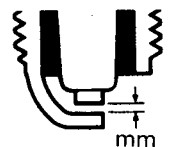

Inch	0.016	0.024	0.032	0.040	0.048	0.056	0.080
Zoll							
pouce							
PULGADAS	0.016	0.024	0.032	0.040	0.048	0.056	0.080
TUM	0.020	0.028	0.036	0.044	0.052	0.060	
MM	0.40	0.50	0.60	0.70	0.80	0.90	1.00 1.10 1.20 1.30 1.40 1.50 2.00

# Design Symbols Spark Plugs

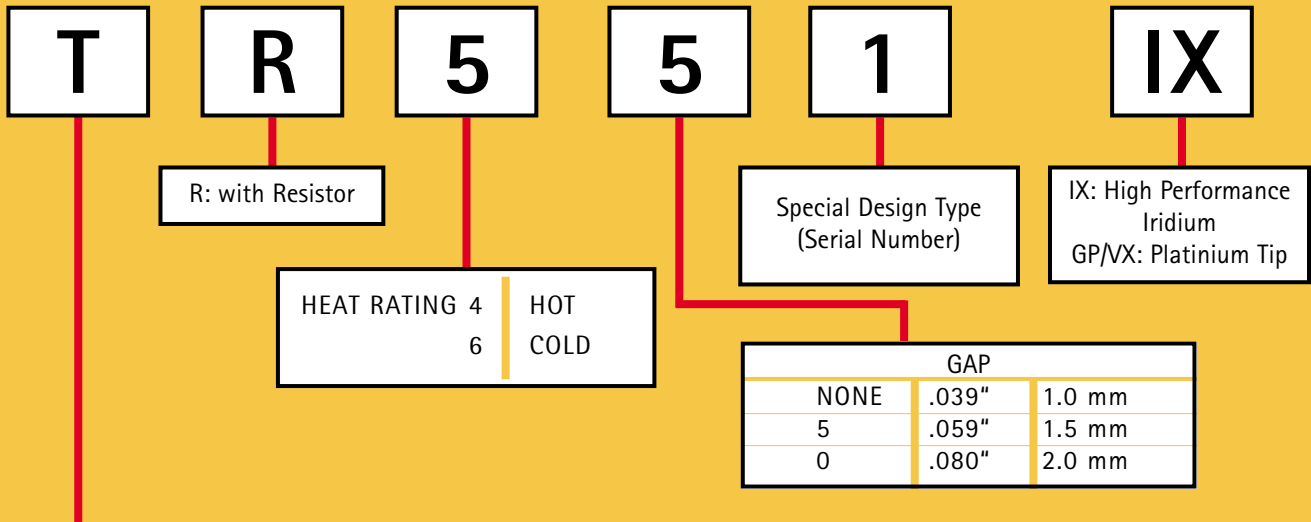

Letter	Thread Diameter	Reach	Insulator Type	Seat Type
F	14 mm Hex. 5/8"	3/4" (19 mm)	Projected	Gasket Seat
F-1	14 mm Hex. 5/8"	(22 mm)	Projected	Gasket Seat
G	14 mm	3/4" (19 mm)	Projected	Gasket Seat
T	14 mm Hex. 5/8"	.708"	Projected	Taper Seat
T-1	14 mm Hex. 5/8"	.807"	Projected	Taper Seat
U	14 mm	.460"	Projected	Taper Seat
W	18 mm	.460"	Projected	Taper Seat
X	14 mm	.3/8"	Projected	Gasket Seat
Y	14 mm	.460"	Non-Projected	Taper Seat

HEAT RATING		
Hot	=	4
Cold	=	7

SPARK PLUG GAP		
NONE	=	.032" (0.8 mm)
-11	=	.044" (1,1 mm)

Prefix	Shell Construction	Thread Diameter	Insulator Type	Plug Type	Reach	Suffix	Seat Construction
BCPR	5/8" Hex	14 mm	Projected	Resistor	3/4"	E, EY, EYA	Gasket Seat
BKR	5/8" Hex (ISO)	14 mm	Projected	Resistor	3/4"	E, EY, EYA	Gasket Seat
BR	5/8" Hex (ISO)	14 mm	Non-Projected	Resistor	3/4"	EF	Tapered Seat
BR	13/16" Hex	14 mm	Non-Projected	Resistor	3/4"	EYA	Gasket Seat
BPM (Compact Type)	3/4" Hex	14 mm	Projected	Non-Resistor	3/8"	Y	Gasket Seat
BPMR (Compact Type)	3/4" Hex	14 mm	Projected	Resistor	3/8"	Y	Gasket Seat
BP	13/16" Hex	14 mm	Projected	Non-Resistor	3/4"	EY	Gasket Seat
BPR	13/16" Hex	14 mm	Projected	Resistor	3/4"	EY	Gasket Seat
BP	13/16" Hex	14 mm	Projected	Non-Resistor	1/2"	HN	Gasket Seat
B	13/16" Hex	14 mm	Non-Projected	Non-Resistor	3/8"	Y	Gasket Seat
BMR (Compact Type)	3/4" Hex	14 mm	Non-Projected	Resistor	3/8"	Y	Gasket Seat
BM (Compact Type)	3/4" Hex	14 mm	Non-Projected	Non-Resistor	3/8"	Y	Gasket Seat

## EXTENDED GAP TYPE

Prefix	Shell Construction	Thread Diameter	Insulator Type	Plug Type	Reach	Suffix	Seat Construction
ZGR	13/16" Hex	14 mm	Projected	Resistor	3/4"	A	Gasket Seat
ZGR	13/16 Hex	14 mm	Projected	Resistor	22.0 mm	C	Gasket Seat
ZFR	5/8" Hex (ISO)	14 mm	Projected	Resistor	22.5 mm	E	Gasket Seat
ZFR	5/8" Hex (ISO)	14 mm	Projected	Resistor	3/4"	F,J	Gasket Seat

# МАРКИРОВОЧНЫЕ МЕТКИ НА СВЕЧАХ НАКАЛИВАНИЯ ФИРМЫ NGK

## СТЕРЖНЕВЫЕ СВЕЧИ НАКАЛИВАНИЯ

**Y-204T S1**

**Y:**  
однополюсная  
**YD:**  
двухполюсная с  
изолированным  
массивом  
проводом

диаметр резьбы и  
число  
нагревательных  
спиралей  
1.3: Ø 10 мм  
одиночная  
2: Ø 12 мм  
одиночная  
4: Ø 14 мм  
одиночная  
7: Ø 10 мм  
двойная  
8: Ø 18 мм  
одиночная  
9: Ø 12 мм  
двойная

рабочее  
напряжение  
0---4: 12 В  
5---9: 24 В

Тип

исполнение:  
стержневая свеча  
-: накаливания  
T: свеча  
накаливания  
быстрого пуска  
R: свеча  
накаливания  
„Ультра“  
Быстрого пуска

материал в  
корпусе  
без: нормальный  
S: специальный  
материал,  
предотвращающий  
перегрев

номер  
модификаций

**Y E O 1**

**Y:**  
однополюсная

Тип

Body:

Thread diameter	Tightening torque
8 mm	8-15 Nm
10 mm	15-20 Nm
12 mm	20-25 Nm
14 mm	20-25 Nm
18 mm	20-30 Nm

Terminal:

Thread diameter	Tightening torque
4 mm (M4)	0.8-1.5 Nm
5 mm (M5)	3.0-4.0 Nm

**C Y O 1**

керамика

Тип

### Примечания к таблице

- △ = Только для автомобилей с противоугонным устройством!
- ◆ = Только для автомобилей без противоугонного устройства!
- \* = Поставка только через договорные торговые организации!

i.V.: на подготовительной стадии

Difference in terminal design for Y-925R  
& Y-930U (Mercedes Benz applications)

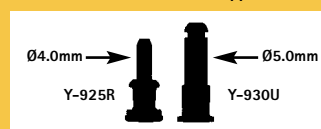

Unterschied zwischen Y-925R & Y-930U

△ ◆

Abbildungen siehe ab Seite 12

Pictures look at page 12





# Tightening torque of Glow plug

Body:

Thread diameter	Tightening torque
8 mm	8-15 Nm
10 mm	15-20 Nm
12 mm	20-25 Nm
14 mm	20-25 Nm
18 mm	20-30 Nm

Terminal:

Thread diameter	Tightening torque
4 mm (M4)	0.8-1.5 Nm
5 mm (M5)	3.0-4.0 Nm



# Определение типа двигателя:

<b>Alfa:</b>	типовая табличка, блок двигателя
<b>Audi:</b>	в сервисном паспорте, блок двигателя, а также: <b>A2, A3, A4, A6, A8:</b> SPARE WHEEL PAN RIGHT <b>100/200:</b> замыкающая пластина сзади, на внутренней стороне слева <b>Avant:</b> днище сзади в центре <b>80/90, Audi V8:</b> внутренняя сторона полки багажника <b>Audi Coupé:</b> багажник справа, под вкладышем углубления для груза
<b>BMW:</b>	блок двигателя
<b>Citroën:</b>	на блоке двигателя
<b>Daihatsu:</b>	инструкция по эксплуатации, блок двигателя
<b>Fiat:</b>	типовая табличка, блок двигателя
<b>Ford:</b>	блок двигателя, типовая табличка
<b>Honda:</b>	блок двигателя в месте перехода к коробке передач
<b>Hyundai:</b>	блок двигателя в месте перехода к коробке передач
<b>Jaguar:</b>	блок двигателя, типовая табличка
<b>Kia:</b>	блок двигателя со стороны коробки передач
<b>Lada:</b>	блок двигателя слева
<b>Lancia:</b>	блок двигателя, типовая табличка
<b>Mazda:</b>	блок двигателя (положение см. инструкцию по эксплуатации)
<b>Mercedes:</b>	блок двигателя
<b>Mitsubishi:</b>	блок двигателя, типовая табличка на капоте двигателя сервисный паспорт
<b>Nissan:</b>	блок двигателя
<b>Opel:</b>	блок двигателя на уровне коробки передач
<b>Peugeot:</b>	блок двигателя (алюминиевая табличка)
<b>Renault:</b>	блок двигателя (в центре) или алюминиевая табличка
<b>Rover:</b>	блок двигателя впереди справа, на уровне головки блока цилиндра
<b>Saab:</b>	блок двигателя внизу
<b>Seat:</b>	блок двигателя, начиная с моделей 1993 г. - как у VW
<b>Skoda:</b>	блок двигателя рядом с распределителем
<b>Subaru:</b>	блок двигателя рядом с кожухом зубчатого ремня
<b>Suzuki:</b>	блок двигателя в месте перехода к коробке передач F = литейный блок; G = алюминиевый блок
<b>Toyota:</b>	наклейка на кожухе зубчатого ремня или на крышке клапана
<b>VW:</b>	в сервисном паспорте, блок двигателя, а также <b>Käfer:</b> замыкающая пластина впереди слева <b>Lupo, Polo, Derby, Golf, Scirocco, Jetta, Passat Limousine, Corrado, Vento, Bora:</b> замыкающая пластина сзади, на внутренней стороне слева <b>Golf Cabrio:</b> поперечина под скамьей заднего сиденья, слева <b>Passat Variant:</b> ниша для запасного колеса, сзади слева <b>Transporter:</b> поперечина блока управления слева <b>LT:</b> колонка, слева внизу <b>Ittis:</b> днище слева, рядом с „аптечкой“ <b>Taro:</b> задняя стенка кабины, с внутренней стороны слева
<b>Volvo:</b>	<b>серии 300, 700, 900, C, S и V:</b> наклейка на лобовой крышке <b>все прочие модели:</b> наклейка на крышке клапана

Эти сведения касаются исключительно первичного оснащения со стороны производителей автомобилей

# SERIES OF NGK SPARK PLUGS

NGK ZÜNDKERZENSERIEN

SÉRIES DES BOUGIES NGK

SERIES DE BUJÍAS DE ENCENDIDO NGK TYPBETECKNINGAR FÖR NGK TÄNDSTIFT

## STANDARD TYPES

STANDARD AUSFÜHRUNGEN  
TIPOS ESTANDARES

TYPES STANDARDS  
STANDARDTYPER

	NON-RESISTOR NON-RÉSISTANCE ICKERESISTOR	OHNE WIDERSTAND NO-RESISTOR	RESISTOR RÉSISTANCE RESISTOR	MIT WIDERSTAND RESISTOR
14mm $\phi$ $\times$ 9.5mm 20.8 Hex Fig. ①Ⓐ	<b>B-2</b> <b>B-4</b> <b>B6S</b> <b>B7S</b> <b>B8S</b>		<b>BR6S</b>	
Fig. ①Ⓒ	<b>BP-4</b> <b>BP5S</b> <b>BP6S</b>			
14mm $\phi$ $\times$ 19.0mm 20.8 Hex Fig. ②Ⓐ	<b>B4ES</b> <b>B5ES</b> <b>B6ES,-11</b> <b>B7ES,-11</b> <b>B8ES</b> <b>B9ES</b> <b>B10ES</b>		<b>BR4ES</b> <b>BR5ES</b> <b>BR6ES,-11</b> <b>BR7ES</b> <b>BR8ES,-11</b> <b>BR9ES</b> <b>BR10ES</b>	
Fig. ②Ⓑ			<b>BR6EB-L-11</b>	
Fig. ②Ⓕ			<b>BR8EYA</b> <b>BR9EYA</b> <b>BR10EYA</b>	
Fig. ②Ⓒ	<b>BP2ES, BP-2E</b> <b>BP4ES,-11</b> <b>BP4ES-L-11</b> <b>BP5ES,-11,-13</b> <b>BP6ES,-11</b> <b>BP7ES,-11</b> <b>BP8ES</b> <b>BP9ES</b>	<b>BP5ESZ</b> <b>BP6ESZ</b>	<b>BPR2ES, BPR-2E</b> <b>BPR4ES,-11,-13</b> <b>BPR5ES,-11,-13</b> <b>BPR6ES,-11,-13</b> <b>BPR7ES,-11</b> <b>BPR8ES</b> <b>BPR9ES</b>	
Fig. ②Ⓓ	<b>BP5EA,-11</b> <b>BP5EA-L</b>		<b>BPR5EA</b> <b>BPR5EA-L,-11</b>	
Fig. ③Ⓔ			<b>BPR6EKN</b> <b>BPR7EKN</b>	
Fig. ②Ⓕ	<b>BP4EY,-11</b> <b>BP5EY,-11</b> <b>BP6EY,-11</b> <b>BP7EY</b>		<b>BPR4EY,-11</b> <b>BPR5EY,-11</b> <b>BPR6EY,-11</b> <b>BPR7EY,-11</b>	
Fig. ②Ⓖ	<b>BP5E</b> <b>BP6E</b>		<b>BPR4E,-11</b> <b>BPR5E,-11</b> <b>BPR6E,-11</b> <b>BPR7E</b>	
Fig. ④Ⓖ	<b>BP5ET,-10</b> <b>BP6ET</b> <b>BP7ET</b>			
Fig. ⑤Ⓘ			<b>BPR5EJ</b>	
14mm $\phi$ $\times$ 19.0mm 16.0 Hex Fig. ⑥Ⓒ	<b>BCP4ES,-11</b> <b>BCP5ES,-11</b> <b>BCP6ES,-11</b> <b>BCP7ES,-11</b>		<b>BCPR4ES-11</b> <b>BCPR5ES,-11</b> <b>BCPR6ES,-11</b> <b>BCPR7ES,-11</b> <b>BCPR9ES-11</b>	
Fig. ⑧Ⓖ	<b>BCP5ET</b> <b>BCP6ET</b> <b>BCP7ET</b>		<b>BCPR5ET</b> <b>BCPR6ET</b> <b>BCPR7ET</b>	
Fig. ⑥Ⓐ	<b>BC6ES</b>			
Fig. ⑦Ⓒ	<b>BK5ES</b>	<b>BK5ESZ</b>	<b>BKR4ES-11</b> <b>BKR5ES,-11</b> <b>BKR6ES,-11</b> <b>BKR7ES-11</b>	

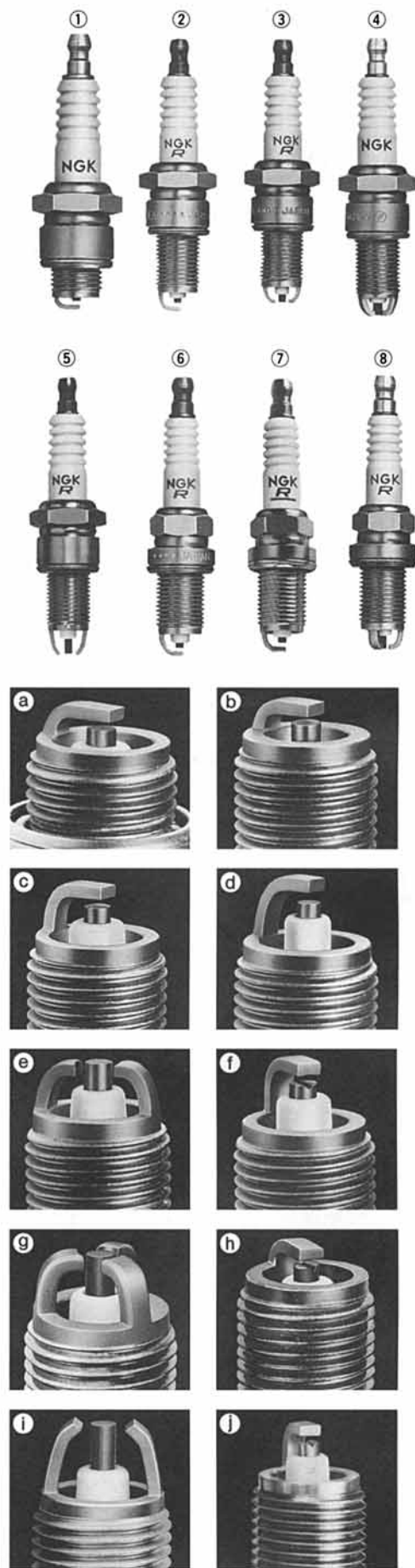

	NON-RESISTOR OHNE WIDERSTAND NON-RÉSISTANCE NO-RESISTOR ICKERESISTOR	RESISTOR MIT WIDERSTAND RÉSISTANCE RESISTOR RESISTOR
14mm $\phi$ $\times$ 19.0mm 16.0 Hex Fig. ①③	<b>BCP5EY-11</b>	<b>BCPR4EY-11</b> <b>BCPR5EY,-11,-N-11</b> <b>BCPR6EY,-11,-N-11</b> <b>BCPR7EY,-11,-N-11</b>
	Fig. ②③ ISO	<b>BKR4EY,-11</b> <b>BKR5EY,-11 BKR5EYA,-11</b> <b>BKR6EY,-11 BKR6EYA,-11</b> <b>BKR7EY</b>
	Fig. ①④	<b>BCPR5E,-11</b> <b>BCPR6E,-11</b> <b>BCPR7E,-11</b>
	Fig. ②④ ISO	<b>BKR4E,-11</b> <b>BKR5E,-11,-N,-N-11 BKR5EZ</b> <b>BKR6E,-11,-N,-N-11 BKR6EZ</b> <b>BKR7E,-11,-N-11</b> <b>BKR8E-11</b>
	Fig. ⑥⑦ ISO	<b>BKR5EK</b> <b>BKR6EK</b>
	Fig. ⑥⑧ ISO	<b>BKR5EKB-11</b> <b>BKR6EKB-11</b> <b>BKR5EKC</b> <b>BKR6EKC,-N-11 BKR6EKE</b> <b>BKR7EKC,-N,-N-11</b>
14mm $\phi$ $\times$ 26.5mm 16.0 Hex Fig. ⑧④		<b>LFR4A,-11</b> <b>LFR5A,-11</b> <b>LFR6A,-11</b>
14mm $\phi$ $\times$ 11.2mm Conical seat 16.0 Hex Fig. ③①	<b>B6FS</b> <b>B7FS</b>	<b>BR5FS</b> <b>BR6FS,-15</b>
	Fig. ③②	<b>BPR4FS,-11,-15</b> <b>BPR5FS,-11,-15</b> <b>BPR6FS</b>
	Fig. ③④	<b>BP5F</b> <b>BP6F</b>
14mm $\phi$ $\times$ 17.5mm Conical seat 16.0 Hex Fig. ④①	<b>B6EFS</b> <b>B8EFS</b> <b>B9EFS</b>	<b>BR7EFS</b>
	Fig. ④⑤	<b>BR6EF</b> <b>BR7EF</b>
	Fig. ④②	<b>BPR5EFS,-13</b> <b>BPR6EFS,-13,-15</b> <b>BPR7EFS-15</b>
	Fig. ④④	<b>BPR6EF,-11,-13</b>
14mm $\phi$ $\times$ 25.0mm Conical seat 16.0 Hex Fig. ⑦②		<b>TR5A-13</b> <b>TR5B-13</b> <b>TR6B-10,-13</b>
14mm $\phi$ $\times$ 11.2mm 20.8 Hex Fig. ⑤①	<b>B-4L</b> <b>B-6L B6LY(Fig. ⑤⑤)</b>	

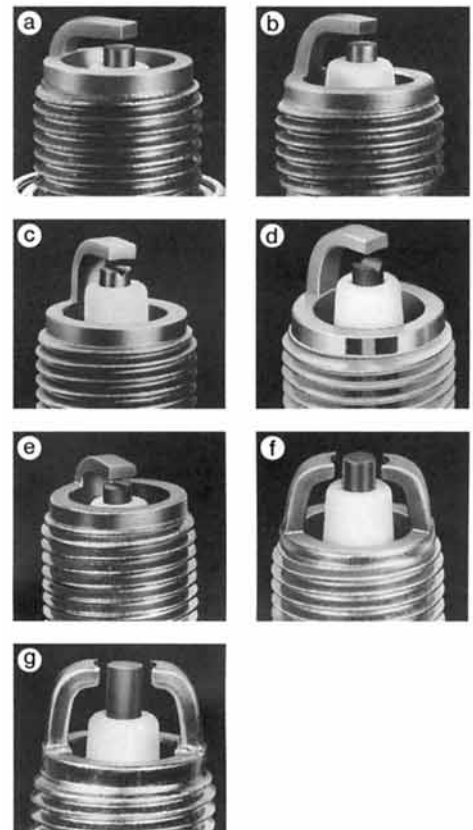

	NON-RESISTOR NON-RÉSISTANCE ICKERESISTOR	OHNE WIDERSTAND NO-RESISTOR	RESISTOR RÉSISTANCE RESISTOR	MIT WIDERSTAND RESISTOR
14mm $\phi$ × 12.7mm 20.8 Hex Fig. ①a	<b>B-2H</b> <b>B-4H,-10</b> <b>B5HS</b> <b>B6HS,-10</b> <b>B7HS,-10</b> <b>B8HS,-10</b> <b>B9HS,-10</b> <b>B10HS</b>		<b>BR4HS</b> <b>BR5HS</b> <b>BR6HS,-10</b> <b>BR7HS,-10</b> <b>BZ7HS-10</b> <b>BR8HS,-10</b> <b>BR9HS,-10</b>	
	Fig. ①b	<b>BP2HS,-10</b> <b>BP4HS,-10</b> <b>BP4HSA</b> <b>BP5HS,-10</b> <b>BP6HS,-10</b> <b>BP6HSA</b> <b>BP7HS,-10</b> <b>BP8HS,-10,-15</b> <b>BP8HSA</b>	<b>BP-2H</b> <b>BP-4H</b>	<b>BPR2HS</b> <b>BPR4HS,-10</b> <b>BPR4HSA</b> <b>BPR-4H</b> <b>BPR5HS</b> <b>BPR6HS,-10</b> <b>BPR6HSA</b> <b>BPR7HS,-10</b> <b>BPR8HS,-10</b> <b>BPR8HSA</b> <b>BPZ8HS-10,-15</b>
	Fig. ①c	<b>BP4HA</b> <b>BP5HA</b>		
	Fig. ①e	<b>B6HSA</b> <b>B8HSA</b>		<b>BR4HSA,-9</b> <b>BR6HSA,-9</b> <b>BR8HSA,-9</b>
18mm $\phi$ × 12.0mm 25.4 Hex Fig. ③f	<b>A-6</b> <b>A-7</b> <b>A-8</b>			
18mm $\phi$ × 10.9mm Conical seat 20.8 Hex Fig. ④f	<b>A6FS</b> <b>A7FS</b> <b>A8FS</b> <b>A9FS</b>		<b>AR6FS</b>	
	Fig. ④g	<b>AP4FS</b> <b>AP5FS</b> <b>AP6FS</b> <b>AP7FS</b> <b>AP8FS</b> <b>AP9FS</b>	<b>APR5FS</b> <b>APR6FS</b>	
	Fig. ④l	<b>AP6F</b>		<b>APR6F</b>
18mm $\phi$ × 12.0mm 20.8 Hex Fig. ⑤f	<b>AB-2</b> <b>AB-6</b> <b>AB-7</b>			
12mm $\phi$ × 19.0mm 18.0 Hex Fig. ⑥h	<b>D6EA</b> <b>D7EA</b> <b>D8EA</b> <b>D9EA</b> <b>D10EA</b>		<b>DR7ES</b> <b>DR7EA</b> <b>DR8ES-L</b> <b>DR8EA</b> <b>DR8EB</b> <b>DR8ES</b> <b>DR9EA</b>	
	Fig. ⑥i	<b>DP6EA-9</b> <b>DP7EA-9</b> <b>DP8EA-9</b> <b>DP9EA-9</b>	<b>DPR5EA-9</b> <b>DPR6EA-9</b> <b>DPR7EA-9</b> <b>DPR8EA-9</b> <b>DPR9EA-9</b>	
	Fig. ⑥h	<b>J9A</b>		<b>JR8B</b> <b>JR9B</b> <b>JR10B</b>
	Fig. ⑥k			<b>JR8C</b> <b>JR9C</b>
12mm $\phi$ × 21.0mm 18.0 Hex Fig. ⑦l	<b>DP8Z</b>		<b>DPR7Z</b> <b>DPR8Z</b> <b>DPR9Z</b>	
12mm $\phi$ × 19.0mm 16.0 Hex Fig. ⑧i	<b>DCP6E</b> <b>DCP7E</b>		<b>DCPR6E</b> <b>DCPR7E</b> <b>DCPR7E-N</b> <b>DCPR8E</b> <b>DCPR8E-N</b> <b>DCPR9E</b>	
	Fig. ⑧m			<b>DCPR8EKC</b>

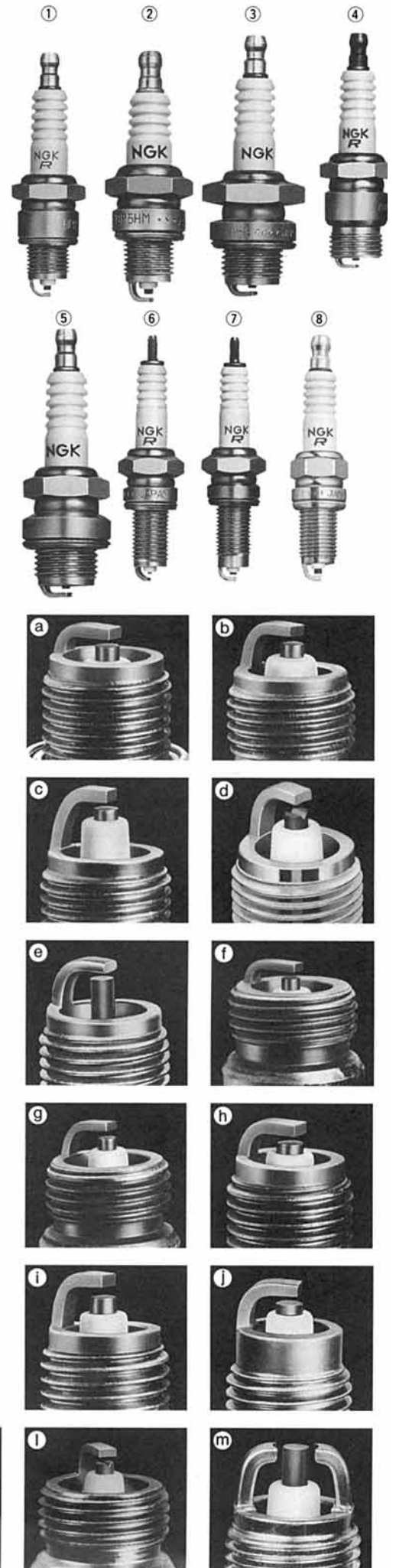

	NON-RESISTOR NON-RÉSISTANCE ICKERESISTOR	OHNE WIDERSTAND NO-RESISTOR	RESISTOR RÉSISTANCE RESISTOR	MIT WIDERSTAND RESISTOR	
12mm $\phi$ × 12.7mm 18.0 Hex Fig. ①①	<b>D-4H</b> <b>D5HS</b> <b>D6HS,D6HA</b> <b>D8HS,D8HA</b>		<b>DR2HS</b> <b>DR4HS</b> <b>DR5HS</b> <b>DR6HS</b> <b>DR8HS</b>		
10mm $\phi$ × 12.7mm 16.0 Hex Fig. ②①	<b>C2H</b>	<b>C4HA</b> <b>C5HA</b> <b>C6HA</b> <b>C7HA</b> <b>C8HA</b>	<b>C4HSB</b> <b>C5HSB</b>	<b>CR4HSA</b> <b>CR5HSA</b> <b>CR6HSA</b> <b>CR7HSA</b> <b>CR8HSA</b>	<b>CR4HSB</b> <b>CR5HSB</b>   <b>LR8A</b>
10mm $\phi$ × 19.0mm 16.0 Hex Fig. ③①	<b>C7E</b> <b>C8E</b> <b>C9E</b>		<b>CR6E</b> <b>CR7E</b> <b>CR8E</b> <b>CR9E</b> <b>CR10E</b>	<b>CR7EB</b> <b>CR8EB</b> <b>CR9EB</b>	
	Fig. ③①		<b>CPR8E</b>		
10mm $\phi$ × 19.0mm 16.0 Hex Fig. ④①	<b>C7EH-9</b> <b>C8EH-9</b> <b>C9EH-9</b>		<b>CR7EH-9</b> <b>CR8EH-9</b> <b>CR9EH-9</b> <b>CR10EH-9</b>		
10mm $\phi$ × 19.0mm 16.0 Hex Fig. ③②			<b>CR7EK</b> <b>CR8EK</b> <b>CR9EK</b> <b>CR10EK</b>	<b>CR9EKB</b>	
	Fig. ③①		<b>CR7EKC</b>		
8mm $\phi$ × 19.0mm 13.0 Hex Fig. ⑤①			<b>ER8EH</b> <b>ER9EH</b> <b>ER10EH</b>		

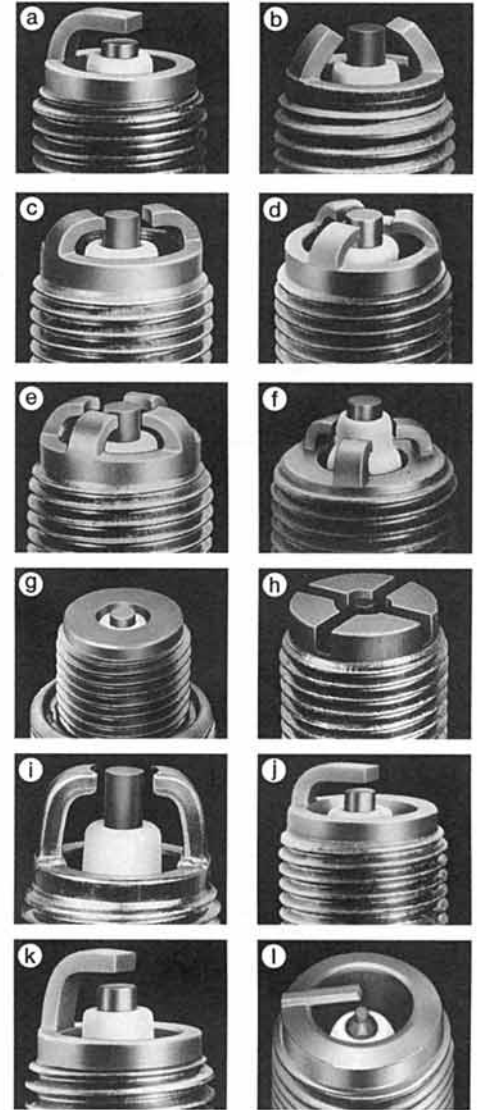

**FOR ROTARY ENGINE**  
**FÜR WANKELMOTOR**    **POUR MOTEUR ROTATIF**  
**PARA MOTOR ROTATIVO**    **TÄNDSTIFT FÜR WANKELMOTOREN**

	NON-RESISTOR NON-RÉSISTANCE ICKERESISTOR	OHNE WIDERSTAND NO-RESISTOR	RESISTOR RÉSISTANCE RESISTOR	MIT WIDERSTAND RESISTOR
14mm $\phi$ × 19.5mm 20.8 Hex Fig. ⑥③	<b>B7EM</b>		<b>BR8EM</b>	
	Fig. ⑥④		<b>BR7ET</b> <b>BR8ET</b> <b>BR9ET</b> <b>BR10ET</b>	
	Fig. ⑥⑤		<b>BR7EQ-14</b> <b>BR8EQ-14</b> <b>BR9EQ-14</b>	
14mm $\phi$ × 18.5mm 20.8 Hex Fig. ⑦①			<b>BRE813L</b>	
14mm $\phi$ × 21.5mm 20.8 Hex Fig. ⑧⑨			<b>SD10A</b> <b>SD11A</b>	
	Fig. ⑧①		<b>BUR6EQ</b> <b>BUR7EQ</b> <b>BUR8EQ</b> <b>BUR9EQ</b>	<b>BUR7EQP</b> <b>BUR9EQP</b>
14mm $\phi$ × 21.0mm 20.8 Hex Fig. ⑨			<b>RE6C-L</b> <b>RE7C-L</b> <b>RE8C-L</b>	
14mm $\phi$ × 19.0mm 20.8 Hex Fig. ⑩①			<b>RE9B-T</b>	

**SEMI SURFACE DISCHARGE TYPES**  
**HALBGLEITFUNKENTYP TYPE À DÉCHARGE**  
**TIPO DE DESCARGA DE MEDIA SUPERFICIE**  
**STIFT MED YTGNIISTGAP**

	NON-RESISTOR NON-RÉSISTANCE ICKERESISTOR	OHNE WIDERSTAND NO-RESISTOR	RESISTOR RÉSISTANCE RESISTOR	MIT WIDERSTAND RESISTOR
14mm $\phi$ × 12.7mm 20.8 Hex Fig. ①(a)	<b>BU8H</b>		<b>BUZ8H</b>	
14mm $\phi$ × 19.0mm 20.8 Hex Fig. ②(b)	<b>BU6EA-11</b>		<b>BUR5EA-11 BUR6EA-11 BUR7EA-11</b>	
14mm $\phi$ × 19.0mm 20.8 Hex Fig. ②(c)			<b>BUR4EB-11 BUR5EB-11 BUR6EB-11 BUR7EB-11</b>	
	Fig. ②(d)		<b>BUR5ET,-10 BUR6ET</b>	
14mm $\phi$ × 19.0mm 20.8 Hex Fig. ③(e)	<b>BP5EK-A BP6EK-A</b>		<b>BPR5EK-A BPR6EK-A</b>	
	Fig. ③(f)		<b>BPR5EKU</b>	
14mm $\phi$ × 17.5mm Conical seat 16.0 Hex Fig. ④(g)	<b>BU6EFSZ</b>		<b>BUR6EFSZ</b>	
14mm $\phi$ × 19.0mm 16.0 Hex Fig. ⑥(e) ISO			<b>BKUR6EK,-9 BKUR7EK</b>	
	Fig. ⑤(d) ISO		<b>BKUR5ET,-10 BKUR5ETZ-10 BKUR6ET,-10 BKUR6ETB BKUR7ET</b>	
	Fig. ⑥(f) ISO		<b>BKR5EKU BKR6EKU</b>	
			<b>BKR6EKUE</b>	
	Fig. ⑥(h) ISO		<b>BKR6EKUB</b>	
14mm $\phi$ × 22.0mm 16.0 Hex Fig. ⑦(i)			<b>BKR5EKUC BKR6EKUC</b>	
14mm $\phi$ × 19.0mm 16.0 Hex Fig. ⑥(j)			<b>BKR6EQUA</b>	

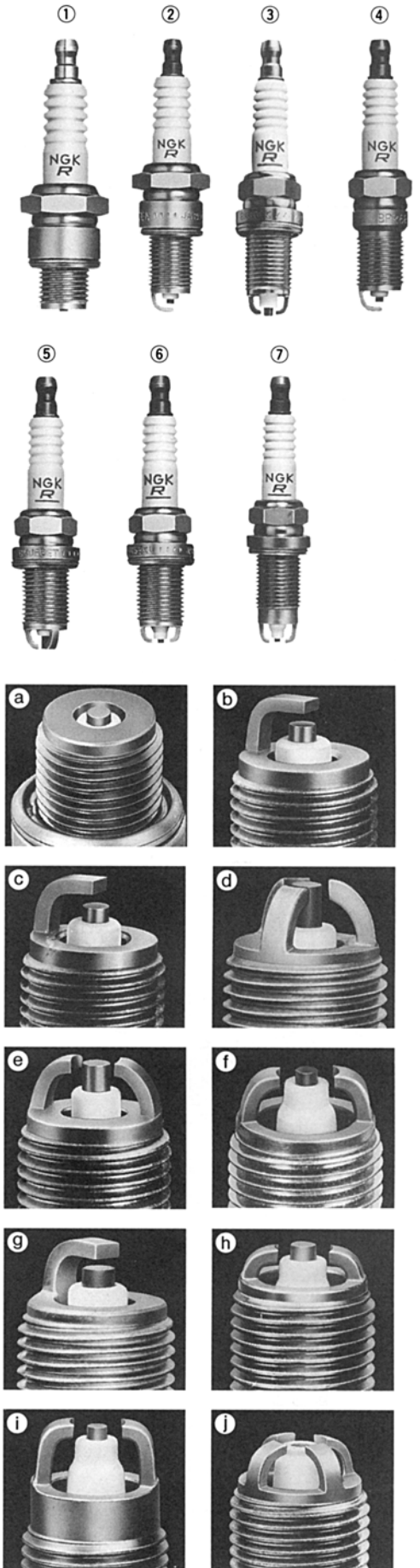

**PROJECTED GAP TYPES**  
**ZUNDKERZEN MIT VORSRINGENDER FUNKENSTRECK**  
**TYPE À ÉCARTEMENT EN SAILLIE**  
**TIPOS DE ABERTURA DE CHISPA PROYECTADA**  
**STIFT MED FÖRLÅNGDA ELEKTRODER**

	NON-RESISTOR NON-RÉSISTANCE ICKERESISTOR	OHNE WIDERSTAND NO-RESISTOR	RESISTOR RÉSISTANCE RESISTOR	MIT WIDERSTAND RESISTOR
14mm $\phi$ × 19.0mm 20.8 Hex Fig. ①(a)	<b>BE527Y-11</b> <b>BE529Y-11</b>		<b>BRE527Y-11</b> <b>BRE529Y,-11</b>	
Fig. ②(b)			<b>ZGR4A</b> <b>ZGR5A</b>	
14mm $\phi$ × 26.0mm 20.8 Hex Fig. ②(d)	<b>ZG5D-11</b>			
14mm $\phi$ × 20.5mm 20.8 Hex Fig. ②(b)			<b>ZGR5B,-11</b> <b>ZGR6B-11</b>	
14mm $\phi$ × 22.0mm 20.8 Hex Fig. ②(c)			<b>ZGR5C</b>	
14mm $\phi$ × 19.0mm 16.0 Hex Fig. ③(b)	<b>ZF6A-11</b>		<b>ZFR5A-11</b> <b>ZFR6A-11</b>	
Fig. ④(b) ISO			<b>ZFR4F-11</b> <b>ZFR5F,-11</b> <b>ZFR6F-11</b> <b>ZFR7F,-11</b>	
Fig. ④(b) ISO			<b>ZFR5J-11</b> <b>ZFR6J-11</b> <b>ZFR7J-11</b>	
Fig. ③(a)			<b>BCRE527Y</b>	
14mm $\phi$ × 20.5mm 16.0 Hex Fig. ③(e)			<b>ZFR5G</b> <b>ZFR6G</b>	
14mm $\phi$ × 22.5mm 16.0 Hex Fig. ③(c)			<b>ZFR4E-11</b> <b>ZFR5E-11</b> <b>ZFR6E-11</b>	
Fig. ③(d)			<b>ZFR5D-11</b> <b>ZFR6D-11</b>	
14mm $\phi$ × 25.0mm Conical seat 16.0 Hex Fig. ⑤(b)			<b>LZTR4A-11</b> <b>LZTR5A-13</b>	

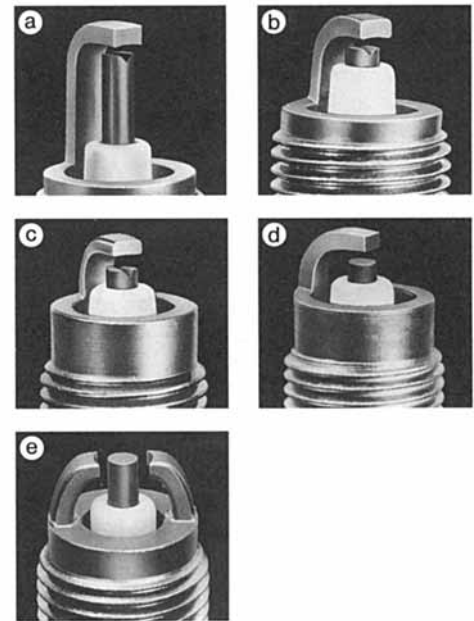

**PLATINUM, IRIIDIUM TIPPED TYPES**  
**TYPEN MIT PLATINELEKTRODENSPITZE, IRIIDIUMSPITZE**  
**TYPE[S] À EXTREMITÉ EN PLATINE, IRIIDIUM**  
**TIPOS CON PUNTA DE PLATINO, IRIIDIO**  
**STIFT MED MITTELEKTRODÄNDA AV PLATINA OCH IRIIDIUM**

	RESISTOR RÉSISTANCE RESISTOR	MIT WIDERSTAND RESISTOR
14mm $\phi$ $\times$ 19.0mm 20.8 Hex Fig. ①①	<b>PGR5A,-11 PGR5C-11 BPR5EP-11,-13</b> <b>PGR6A,-11 PGR6C-11 BPR6EP-8</b> <b>PGR7A,-11</b>	
	<b>IGR7A</b>	
14mm $\phi$ $\times$ 19.0mm 20.8 Hex Fig. ①②	<b>IGR5C13</b>	
14mm $\phi$ $\times$ 19.0mm 16.0 Hex Fig. ②③	<b>PFR5A-11 PFR5K-11 BCPR5EP-8,-11,-13</b> <b>PFR6A-11 PFR6H-10 PFR6K-11 BCPR6EP-8,N-8,-11,-N-11,-13</b> <b>PFR7A-11 PFR7H-10</b>	
Fig. ③④ ISO	<b>FR4AP-10,-11 FR4BP-11</b> <b>FR5AP-10,-11 FR5BP-11 FR5AP-11E</b> <b>FR6AP-10,-11 FR6BP-11</b> <b>FR7AP-11</b>	
	<b>FR5EI-13</b>	
	<b>PFR4B-11 PFR4C-11</b> <b>PFR5B,-9,-11,-11B PFR5C-11</b> <b>PFR6B,-9,-11,-11B,-11C PFR6C-11 PFR6E-10</b> <b>PFR7B,-9,-11,-11C</b> <b>PFR8B,-9</b>	
	<b>PFR4G-11 PFR5J-11</b> <b>PFR5G-11,-13E PFR6H-10 PFR6J,-11</b> <b>PFR6G,-9,-11,-13,-13E PFR7G,-9,-11</b>	
	<b>PFR5L-11 PFR5N-11 PFR4P</b> <b>PFR6L-11,-13 PFR6N-11 PFR6P,-11 PFR5P,-11</b> <b>PFR7N-D PFR6Q</b> <b>PFR7Q</b>	
	<b>PFR5R-11</b>	
	<b>BKR5EP-8,-11</b> <b>BKR6EP-8,-11,-13,-N-8</b>	
Fig. ④⑤ ISO	<b>BKR6EKPA</b>	
Fig. ④⑥ ISO	<b>BKR5EKUP</b>	
Fig. ④⑦ ISO	<b>BKR5EKPB-11,-13</b> <b>BKR6EKPB-11</b>	
Fig. ④⑧ ISO	<b>BKR5EQUPA</b> <b>BKR6EQUP BKR6EQUPA</b>	
Fig. ③⑨ ISO	<b>PFR6M</b> <b>PFR7M</b>	
Fig. ③⑩ ISO	<b>PZFR5B PZFR5F,-11,-13</b> <b>PZFR6B PZFR6F,-11</b> <b>PZFR7F</b>	
Fig. ③⑪ ISO	<b>IFR5A11,-8N IFR5D10 IFR5E11</b> <b>IFR6A11 IFR6C IFR6D10 IFR6E11</b> <b>IFR7F-D</b>	
	<b>IFR5G11 IFR5J11 IFR5T-8N,11</b> <b>IFR6J11 IFR6S IFR6T11</b>	
Fig. ②⑨	<b>IZFR5B IZFR5F11</b> <b>IZFR6B IZFR6F11</b>	
	<b>ZFR5LP-13G</b>	
14mm $\phi$ $\times$ 22.0mm 16.0 Hex Fig. ⑩⑫ ISO	<b>PZFR5C PZFR5D-11</b>	
Fig. ⑩⑫ ISO	<b>IZFR5C</b> <b>IZFR7E-D</b>	
14mm $\phi$ $\times$ 25.0mm conical seat 16.0 Hex Fig. ⑥②	<b>PTR5A-13</b>	





	RESISTOR MIT WIDERSTAND RÉSISTANCE RESISTOR RESISTOR
14mm $\phi$ $\times$ 17.5mm conical seat 16.0 Hex Fig. ⑨①	<b>PTR4B-15 PTR5C-13,-15</b> <b>ITR4A15 ITR5F13</b> <b>ITR6F13</b>
14mm $\phi$ $\times$ 17.5mm conical seat 16.0 Hex Fig. ③⑧ Fig. ⑨⑨	<b>PTR5D-10,-13</b> <b>PTR6D-13,-13G</b> <b>PZTR5A-15</b>
14mm $\phi$ $\times$ 20.5mm 16.0 Hex Fig. ③②	<b>IZFR6K11,13</b>
14mm $\phi$ $\times$ 21.5mm 16.0 Hex Fig. ①③	<b>PZFR5N-11T</b>
14mm $\phi$ $\times$ 22.0mm 16.0 Hex Fig.	<b>PZFR6J-11</b>
14mm $\phi$ $\times$ 26.5mm 16.0 Hex Fig. ①②④ Fig. ①①⑨	<b>PLFR4A-11</b> <b>PLFR5A-9,-11</b> <b>PLFR6A-9,-11</b> <b>PLFR7A-9</b> <b>ILZFR6A11</b>
14mm $\phi$ $\times$ 29.5mm 16.0 Hex Fig. ①①①	<b>LZFR5AQP</b>
12mm $\phi$ $\times$ 19.0mm 18.0 Hex Fig. ⑤⑧	<b>PJR6A</b> <b>PJR7A</b> <b>PJR8A</b> <b>IJR7A9</b>
12mm $\phi$ $\times$ 19.0mm 16.0 Hex Fig. ⑦①①	<b>PKR7A</b> <b>PKR9B</b>
12mm $\phi$ $\times$ 19.0mm 16.0 Hex Fig. ⑦③	<b>DCPR8EKP</b>
12mm $\phi$ $\times$ 22.0mm 16.0 Hex Fig.	<b>IZKR7A</b>
10mm $\phi$ $\times$ 19.0mm 16.0 Hex Fig. ⑧①	<b>PMR7A</b> <b>PMR8A</b> <b>PMR8B</b>
10mm $\phi$ $\times$ 19.0mm 16.0 Hex Fig. ①②	<b>IMR9C-9H</b>

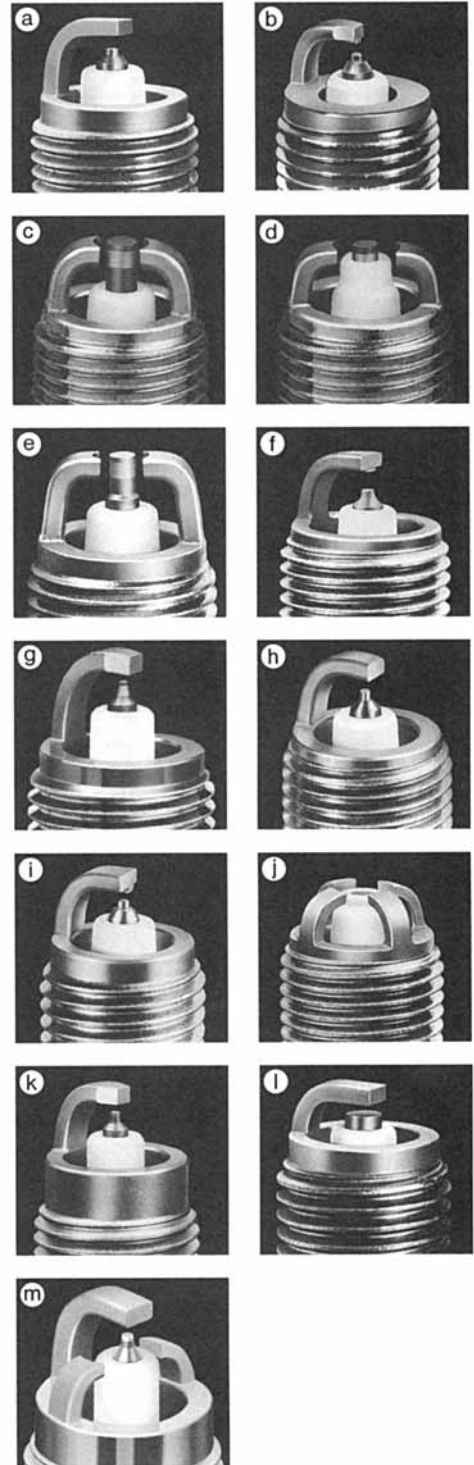

## COMPACT TYPES

KOMPAKT STIFT  
TIPOS COMPACTOS

TYPES COMPACTES  
KOMPACTE TYPEN

	NON-RESISTOR NON-RÉSISTANCE ICKERESISTOR	OHNE WIDERSTAND NO-RESISTOR	RESISTOR RÉSISTANCE RESISTOR	MIT WIDERSTAND RESISTOR
14mm $\phi$ $\times$ 9.5mm 19.0 Hex Fig. ①(a)	<b>BM4A</b> <b>BM6A</b> <b>BM7A</b>	<b>B2-LM *</b> <b>B4-LM *</b> <b>BM6 *</b> <b>BM7 *</b> * Hex.20.8mm	<b>BMR2A,-10</b> <b>BMR4A</b> <b>BMR6A</b> <b>BMR7A</b>	<b>BR2-LM *</b> <b>BR4-LM *</b>  * Hex.20.8mm
	Fig. ①(b)	<b>BPM4A,-10</b> <b>BPM6A,-10</b> <b>BPM7A</b>	<b>BPMR4A,-10</b> <b>BPMR6A,-10</b> <b>BPMR7A,-9</b>	
14mm $\phi$ $\times$ 12.7mm 20.8 Hex Fig. ②(a)	<b>BL-6H</b>			
14mm $\phi$ $\times$ 7.8mm Conical seat 16.0 Hex Fig. ③(a)	<b>BM6F</b> <b>BM7F</b>	<b>BM6FY</b>	<b>BMR6F</b>	
	Fig. ③(b)	<b>BPM6F</b> <b>BPM7F</b>	<b>BPMR6F</b>	
10mm $\phi$ $\times$ 8.6mm 14.0 Hex Fig. ④(a)	<b>CM-6</b>			
10mm $\phi$ $\times$ 9.5mm 16.0 Hex Fig. ⑧(a)			<b>CMR6A</b> <b>CMR7A</b>	
10mm $\phi$ $\times$ 12.7mm 16.0 Hex Fig. ⑧(e)			<b>CMR6H</b> <b>CMR7H</b>	
14mm $\phi$ $\times$ 9.5mm 19.0 Hex Fig. ①(c)	<b>BPM6Y</b> <b>BPM7Y</b> <b>BPM8Y</b>		<b>BPMR6Y</b>  <b>BPMR8Y</b>	



## FARM EQUIPMENT TYPES

LANDMASCHINEN TYPEN  
TIPOS MÁQUINAS AGRICOLAS

TYPES MACHINES AGRICOLES  
FØR JORDBRUKS-MASKINER

PF1/2" $\times$ 22.5mm 23.8 Hex Fig. ⑤(d)	<b>G-27</b> <b>G-2Z</b>
---	----------------------------

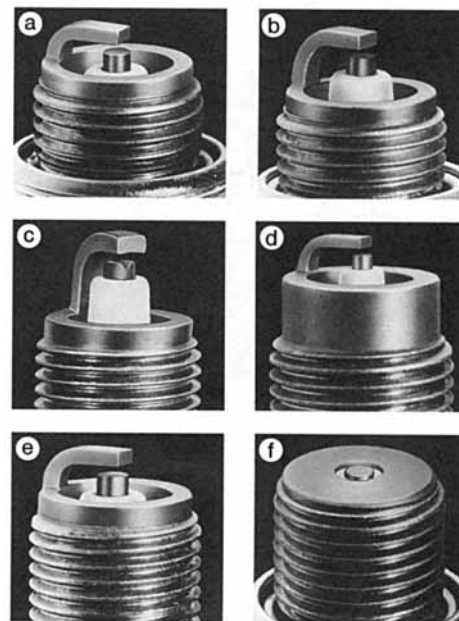

## SURFACE DISCHARGE TYPES

GLEITFUNKENTYPEN

TYPE À DÉCHARGE SUPERFICIELLE

TIPO DESCARGA EN SUPERFICIE TÅNDSTIFT MED YTGNIISTGAP

14mm $\phi$ $\times$ 12.7mm 20.8 Hex Fig. ⑥(f)	<b>BUHX(Series gap)</b> <b>BUHXW-1(Series gap)</b>	
	<b>BUH</b>	
	<b>BUHW</b> <b>BUHW-2</b>	<b>BUZHW</b> <b>BUZHW-2</b>
14mm $\phi$ $\times$ 19.0mm 20.8 Hex Fig. ⑦(f)	<b>BUE</b>	

# VX TYPES

VX TYPEN    TYPES VX  
TIPOS VX    VX-STIFT

	NON-RESISTOR NON-RÉSISTANCE ICKERESISTOR	OHNE WIDERSTAND NO-RESISTOR	RESISTOR RÉSISTANCE RESISTOR	MIT WIDERSTAND RESISTOR
14mm $\phi$ $\times$ 19.0mm 20.8 Hex Fig. ①(a)	<b>B6EVX B7EVX B8EVX B9EVX B10EVX</b>		<b>BR7EVX BR8EVX BR9EVX BR10EVX</b>	
	Fig. ①(b)	<b>BP5EVX BP6EVX BP7EVX BP8EVX</b>		<b>BPR4EVX BPR5EVX,-11 BPR6EVX,-11 BPR7EVX BPR8EVX BPR9EVX BPR10EVX</b>
	Fig. ②(c)			<b>BR9ECMVX BR10ECMVX</b>
	Fig. ①(d)			<b>BUR5EBVX-11 BUR6EBVX-11</b>
14mm $\phi$ $\times$ 19.0mm 16.0 Hex Fig. ③(b)	<b>BCP5EVX BCP6EVX BCP7EVX</b>		<b>BCPR5EVX-11 BCPR6EVX-11 BCPR7EVX-11 BCPR8EVX-11</b>	
	Fig. ④(b) ISO			<b>BKR4EVX BKR5EVX,-11 BKR6EVX,-11 BKR7EVX,-11</b>
	Fig. ④(b) ISO			<b>BKR5EVXA-11,-13 BKR6EVXA-11,-13</b>
	Fig. ④(b) ISO			<b>ZFR5FVX-11 ZFR6FVX-11</b>
14mm $\phi$ $\times$ 11.2mm Conical seat 16.0 Hex Fig. ⑩(a)			<b>BR6FVX</b>	
14mm $\phi$ $\times$ 17.5mm Conical seat 16.0 Hex Fig. ⑪(b)	<b>BP7EFVX</b>		<b>BPR5EFVX</b>	
14mm $\phi$ $\times$ 12.7mm 20.8 Hex Fig. ⑤(a)	<b>B6HVX B7HVX B8HVX B9HVX B10HVX</b>		<b>BR8HVX</b>	
	Fig. ⑤(b)	<b>BP6HVX BP7HVX BP8HVX BP9HVX</b>		<b>BPR6HVX BPR7HVX</b>
12mm $\phi$ $\times$ 19.0mm 18.0 Hex Fig. ⑫(b)	<b>D7EVX D8EVX D9EVX</b>		<b>DR8EVX DR9EVX</b>	
	Fig. ⑫(b)			<b>CPR7EVX-9 CPR8EVX-9 CPR9EVX-9</b>
12mm $\phi$ $\times$ 19.0mm 16.0 Hex Fig. ⑥(b)	<b>DCP7EVX DCP8EVX</b>		<b>DCPR7EVX DCPR8EVX DCPR9EVX</b>	
10mm $\phi$ $\times$ 19.0mm 16.0 Hex Fig. ⑦(e)			<b>CR8EVX CR9EVX</b>	
10mm $\phi$ $\times$ 19.0mm 16.0 Hex Fig. ⑧(e)			<b>CR8EHVX-9 CR9EHVX-9</b>	
10mm $\phi$ $\times$ 12.7mm 16.0 Hex Fig. ⑨(e)	<b>C7HVX</b>		<b>CR8HVX</b>	

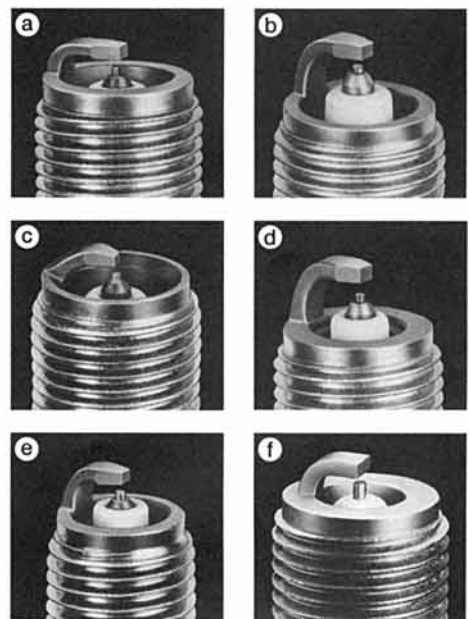
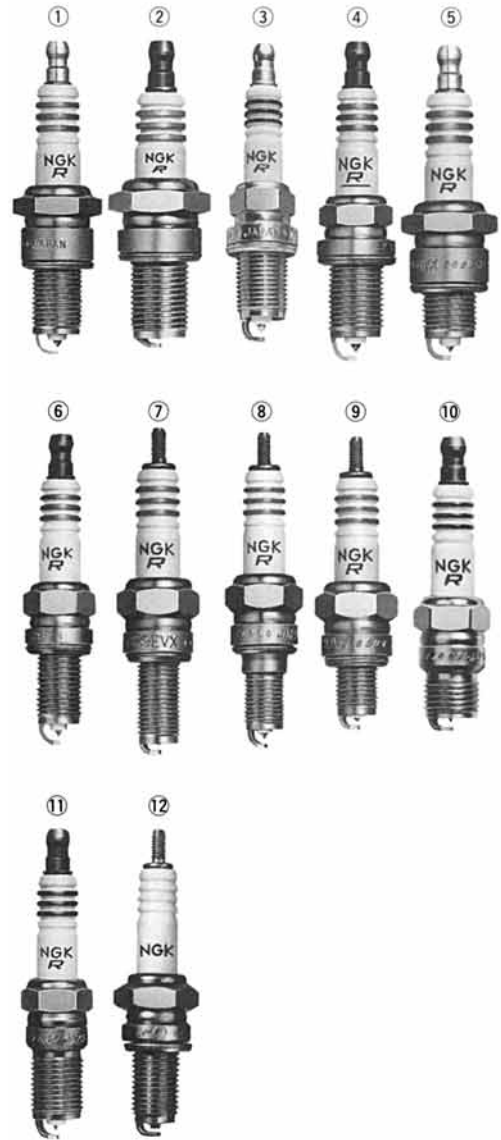

## COMPETITION TYPES

WETTBEWERBS-TYPEN TYPES COMPÉTITION  
TIPOS DE COMPETICIÓN RACERSTIFT

14mm $\phi$ $\times$ 12.7mm 20.8 Hex Fig. ⑤⑥	<b>B7HCS</b> <b>B8HCS</b> <b>B9HCS</b>	<b>BR8HCS-10</b>
14mm $\phi$ $\times$ 19.0mm 20.8 Hex Fig. ⑥⑦	<b>B7ECS</b> <b>B8ECS</b> <b>B9ECS</b>	<b>BR8ECS</b> <b>BR9ECS</b> <b>BR10ECS</b>
Fig. ⑦⑧		<b>BR8ECM</b> <b>BR9ECM</b> <b>BR10ECM</b>

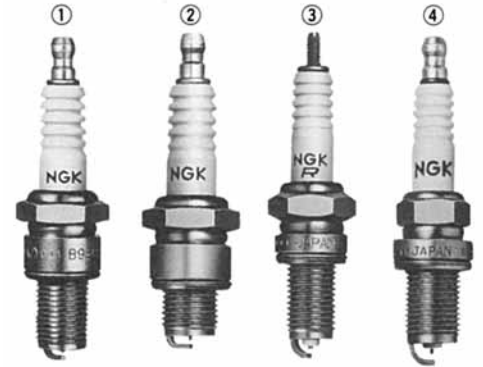

## RACING TYPES

RENN-TYPEN TYPES COURS  
TIPOS DE CARRERAS RACERSTIFT

	Nickel electrode Nickel Elektrode Electrodo de niquel Electrodo de niquel Nickel elektrod	Precious metal electrode Elektrode mit sonde-redel metall Electrodo en metal precieus Electrodo de metal precioso Ädelmetall elektrod	Platinum electrode Platinel Elektrode Electrodo de platine Electrodo de platino Platina elektrod
14mm $\phi$ $\times$ 19.0mm 20.8 Hex	<b>B8EG</b> Fig. ①② <b>BR8EG*</b>	<b>B8EGV</b> Fig. ①③ <b>B85EGV</b> <b>B9EGV</b> <b>B95EGV</b>	<b>B8EGP</b> Fig. ①④ <b>B85EGP</b> <b>B9EGP</b> <b>B95EGP</b> <b>B10EGP</b>
	<b>B9EG</b> <b>BR9EG*</b>	<b>B10EGV</b> <b>B105EGV</b> <b>B11EGV</b>	
*Resistor Type	<b>B10EG</b> <b>BR10EG*</b>		
	<b>B11EG</b>		

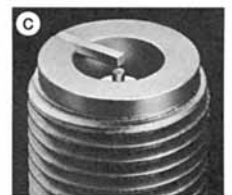
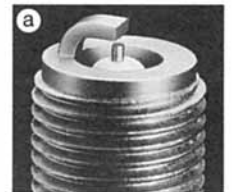

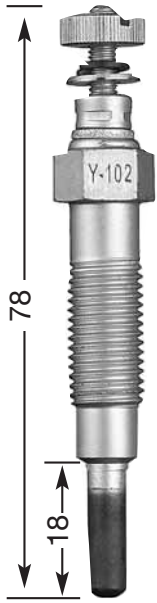

**Y-102**  
M 10 x 1.25  
12 Hex  
10,5 V

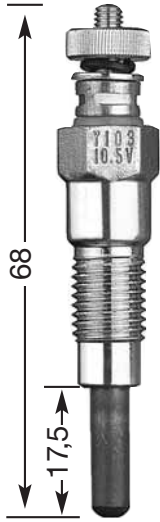

**Y-103**  
M 10 x 1.25  
12 Hex  
10,5 V

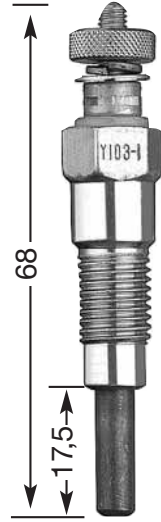

**Y-103-1**  
M 10 x 1.25  
12 Hex

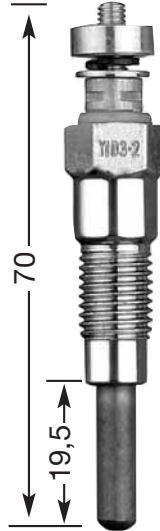

**Y-103-2**  
M 10 x 1.25  
12 Hex

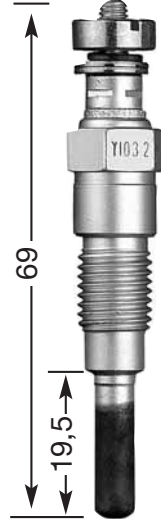

**Y-103-2A**  
M 10 x 1.25  
12 Hex

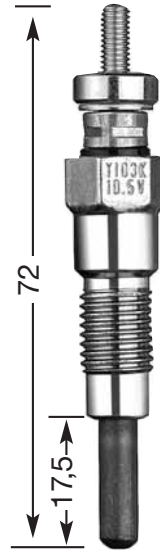

**Y-103 K**  
M 10 x 1.25  
12 Hex  
10,5 V

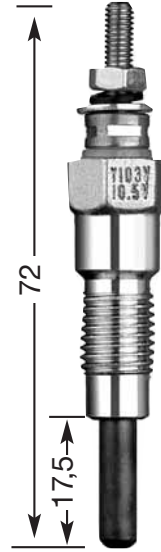

**Y-103 V**  
M 10 x 1.25  
12 Hex  
10,5 V

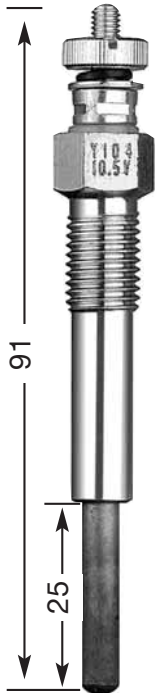

**Y-104**  
M 10 x 1.25  
12 Hex  
10,5 V



**Y-106-1**  
M 10 x 1.25  
12 Hex  
10,5 V

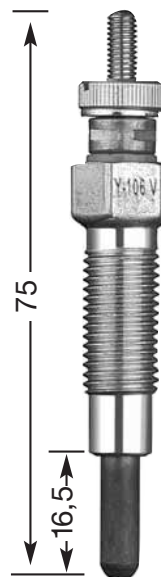

**Y-106 V**  
M 10 x 1.25  
12 Hex  
10,5 V

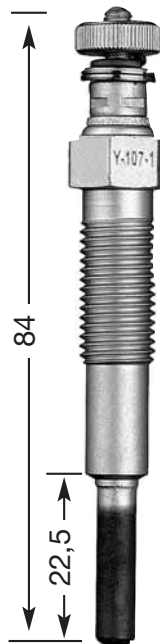

**Y-107-1**  
M 10 x 1.25  
12 Hex  
10,5 V

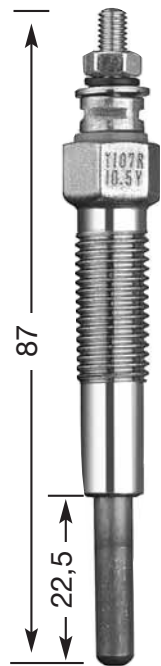

**Y-107 R**  
M 10 x 1.25  
12 Hex  
10,5 V

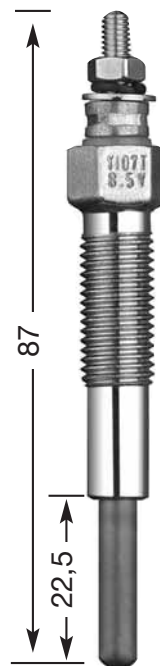

**Y-107 T**  
M 10 x 1.25  
12 Hex  
8,5 V

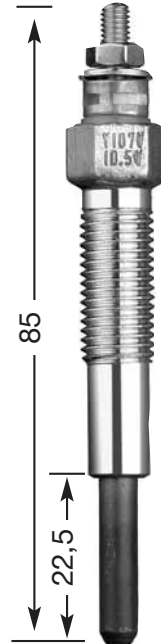

**Y-107 V**  
M 10 x 1.25  
12 Hex  
10,5 V

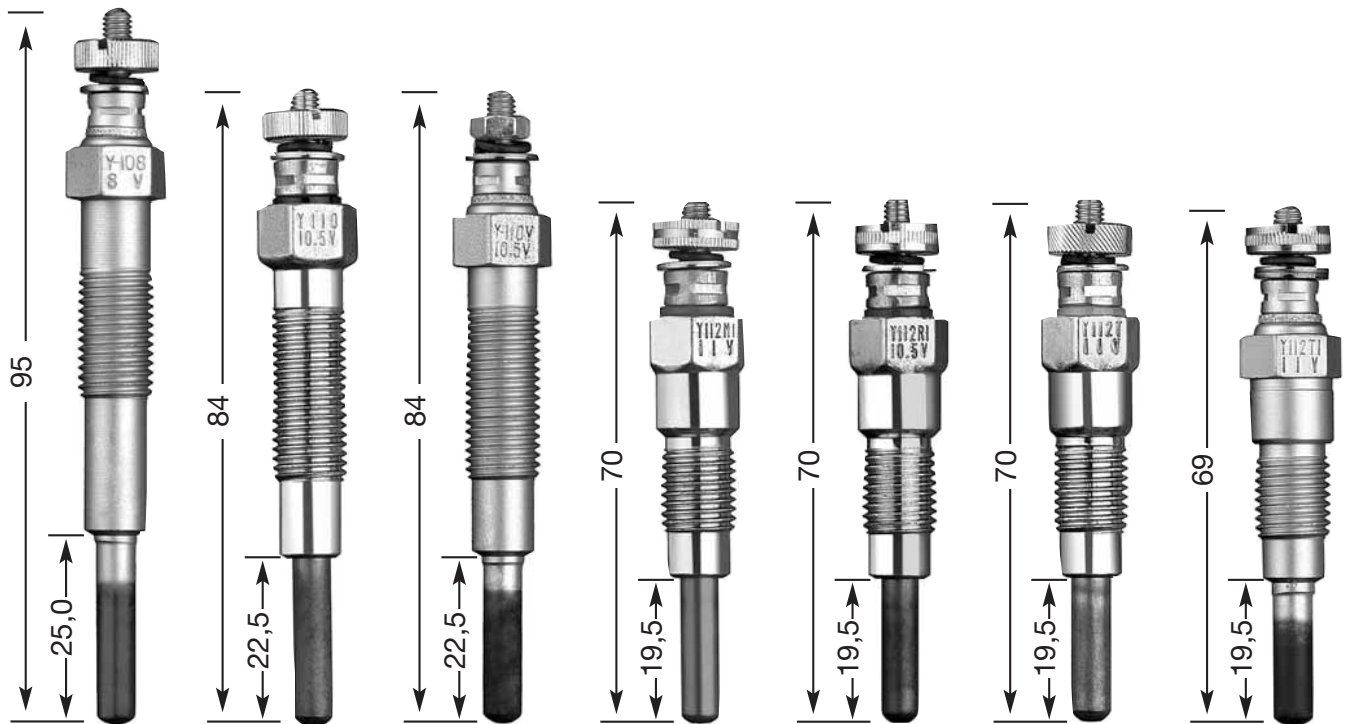

<b>Y-108</b> M 10 x 1.25 12 Hex 8 V	<b>Y-110</b> M 10 x 1.25 12 Hex 10,5 V	<b>Y-110 V</b> M 10 x 1.25 12 Hex 10,5 V	<b>Y-112 M1</b> M 10 x 1.25 12 Hex 11 V	<b>Y-112 R1</b> M 10 x 1.25 12 Hex 10,5 V	<b>Y-112 T</b> M 10 x 1.25 12 Hex 11 V	<b>Y-112 T1</b> M 10 x 1.25 12 Hex 11 V
--	---	---	--	--	---	--

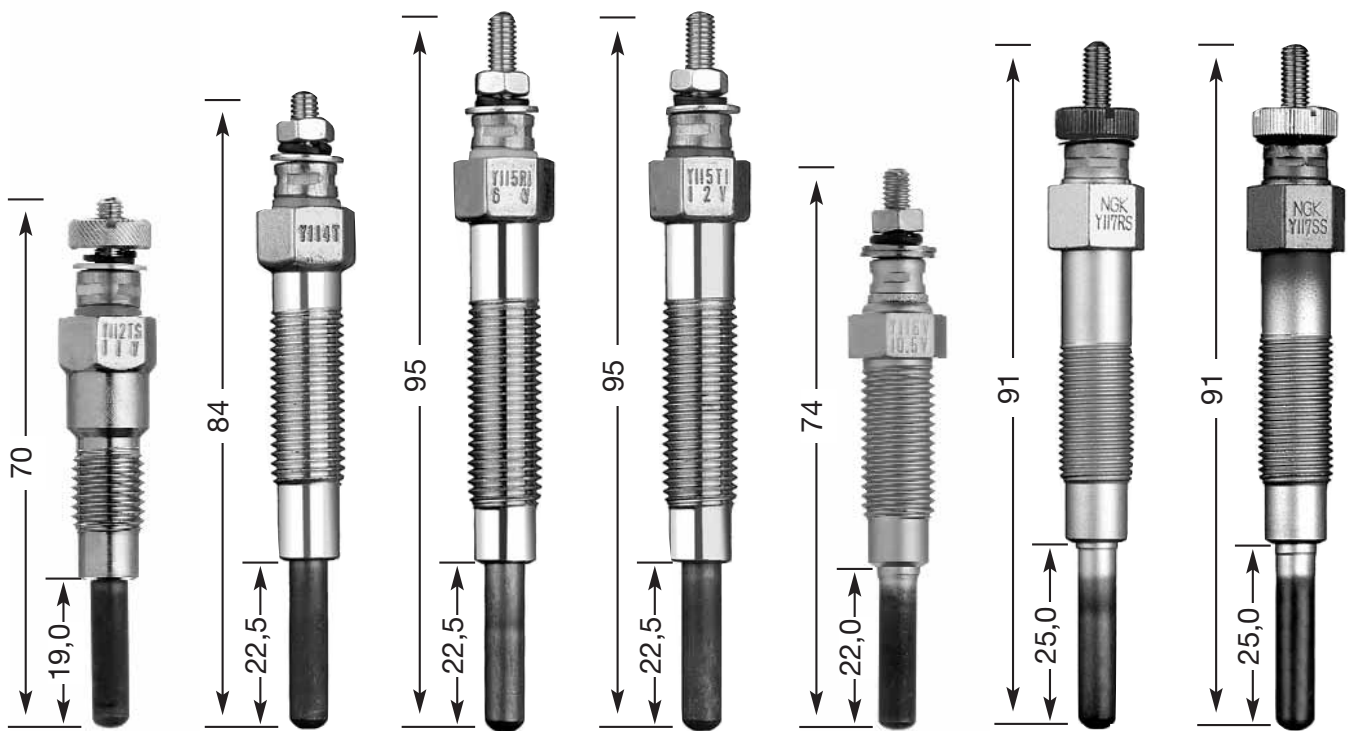

<b>Y-112 TS</b> M 10 x 1.25 12 Hex 11 V	<b>Y-114 T</b> M 10 x 1.25 12 Hex 10,5 V	<b>Y-115 R1</b> M 10 x 1.25 12 Hex 6 V	<b>Y-115 T1</b> M 10 x 1.25 12 Hex 12 V	<b>Y-116 V</b> M 10 x 1.25 12 Hex 10,5 V	<b>Y-117 RS</b> M 10 x 1 12 Hex 6,5 V	<b>Y-117 SS</b> M 10 x 1 12 Hex 8,5 V
--	---	---	--	---	--	--

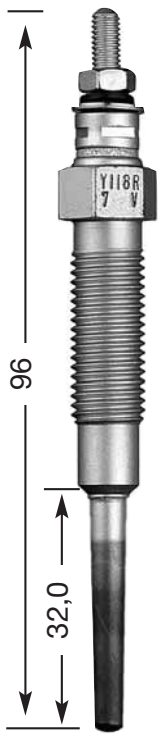

**Y-118 R**  
M 10 x 1.25  
12 Hex  
7 V



**Y-118 T1**  
M 10 x 1.25  
12 Hex  
11 V

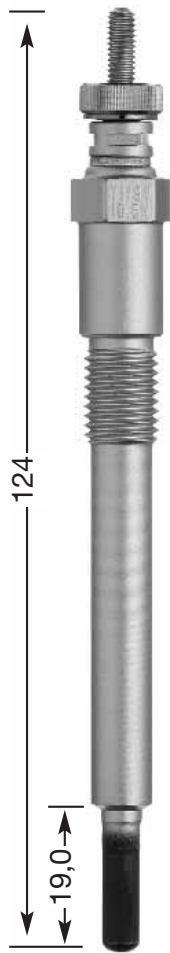

**Y-119 V**  
M 10 x 1.25  
12 Hex  
10,5 V

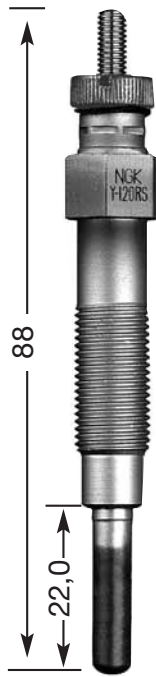

**Y-120 RS**  
M 10 x 1.0  
12 Hex  
6,5 V

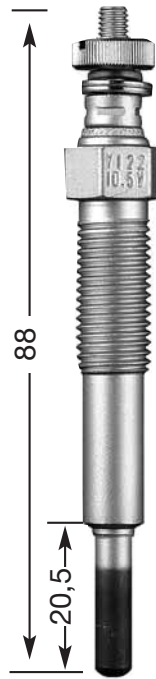

**Y-122**  
M 10 x 1.25  
12 Hex  
10,5 V

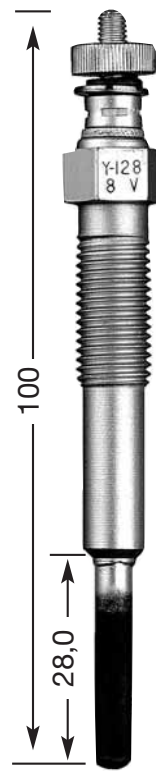

**Y-128**  
M 10 x 1.25  
12 Hex  
8 V

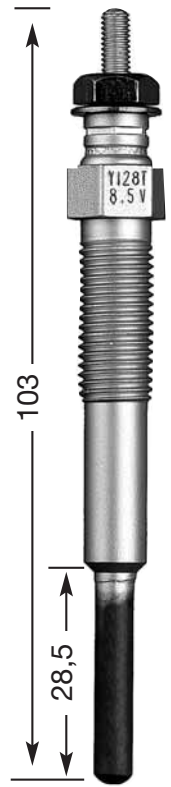

**Y-128 T**  
M 10 x 1.25  
12 Hex  
8,5 V

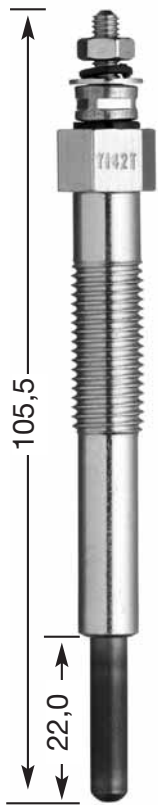

**Y-142 T**  
M 10 x 1.25  
12 Hex



**Y-145 T**  
M 10 x 1.25  
12 Hex  
10,5 V

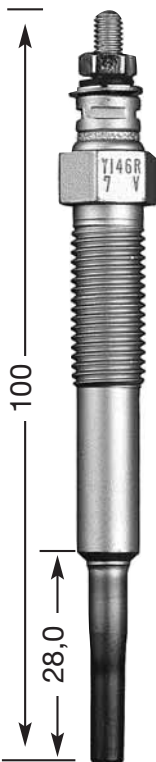

**Y-146 R**  
M 10 x 1.25  
12 Hex  
7 V

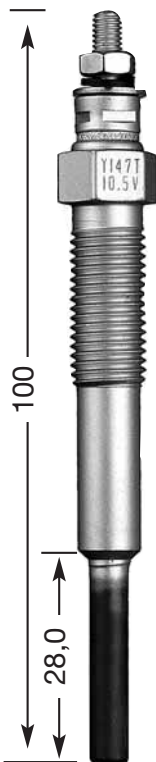

**Y-147 T**  
M 10 x 1.25  
12 Hex  
10,5 V

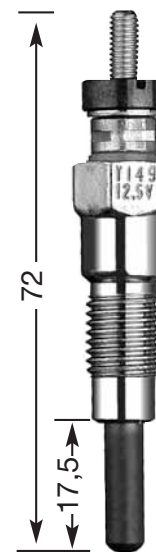

**Y-149**  
M 10 x 1.25  
12 Hex  
12,5 V

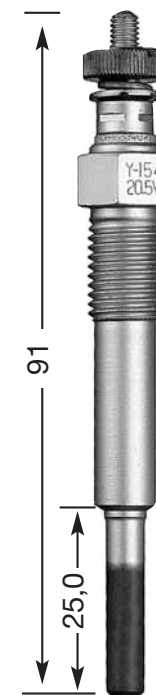

**Y-154**  
M 10 x 1.25  
12 Hex  
20,5 V



**Y-157 R**  
M 10 x 1.25  
12 Hex  
23 V

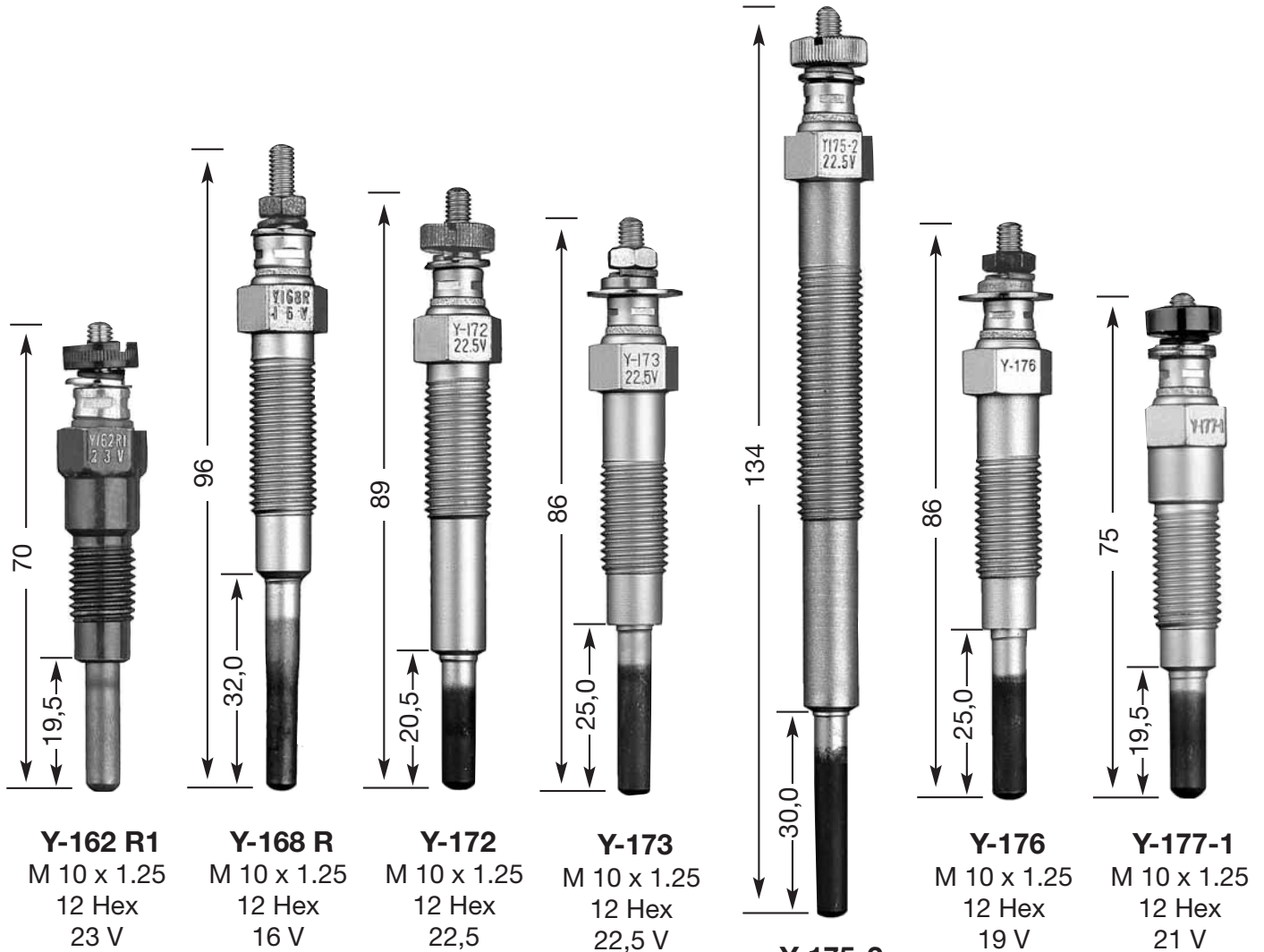

**Y-162 R1**  
M 10 x 1.25  
12 Hex  
23 V

**Y-168 R**  
M 10 x 1.25  
12 Hex  
16 V

**Y-172**  
M 10 x 1.25  
12 Hex  
22,5

**Y-173**  
M 10 x 1.25  
12 Hex  
22,5 V

**Y-175-2**  
M 10 x 1.25  
12 Hex  
22,5 V

**Y-176**  
M 10 x 1.25  
12 Hex  
19 V

**Y-177-1**  
M 10 x 1.25  
12 Hex  
21 V

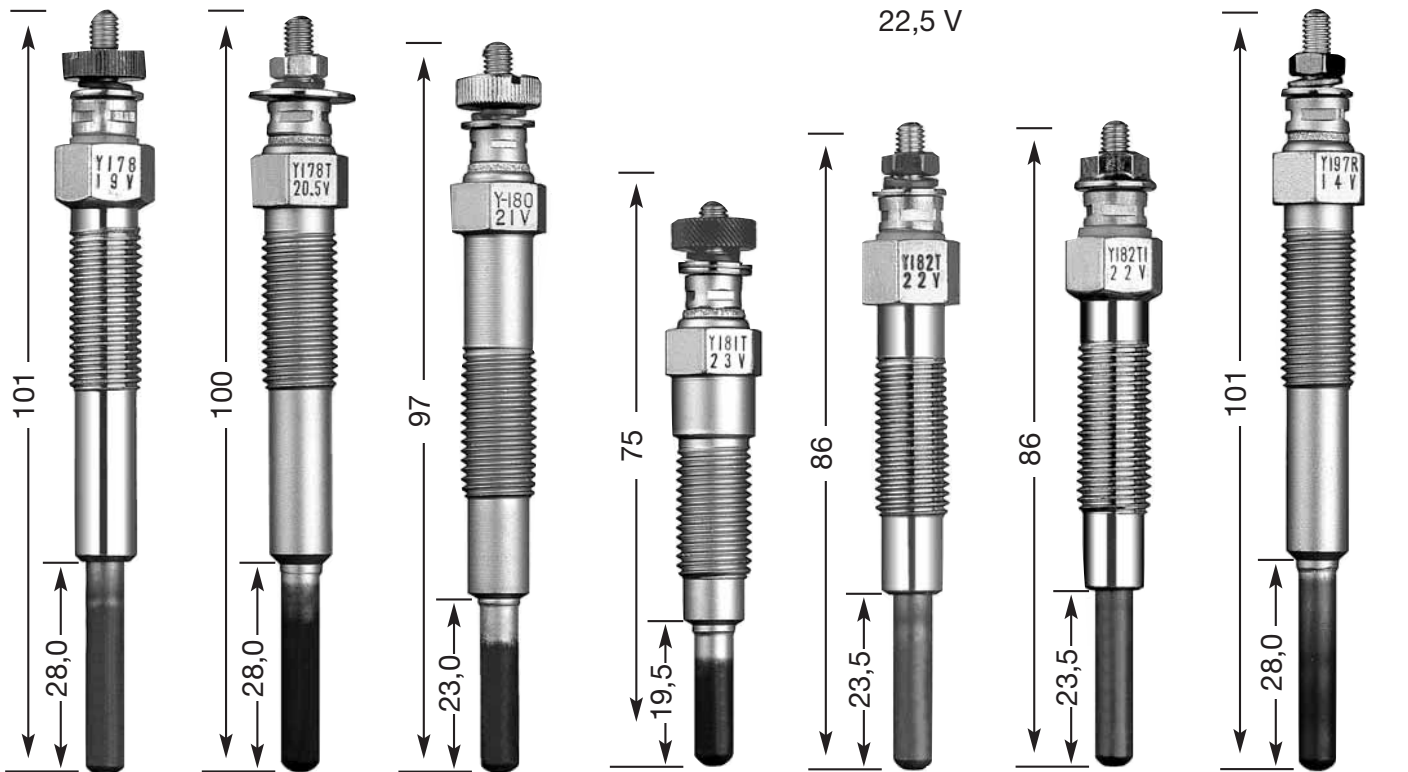

**Y-178**  
M 10 x 1.25  
12 Hex  
19 V

**Y-178 T**  
M 10 x 1.25  
12 Hex  
20,5 V

**Y-180**  
M 10 x 1.25  
12 Hex  
21 V

**Y-181 T**  
M 10 x 1.25  
12 Hex  
23 V

**Y-182 T**  
M 10 x 1.25  
12 Hex  
22 V

**Y-182 T1**  
M 10 x 1.25  
12 Hex  
22 V

**Y-197 R**  
M 10 x 1.25  
12 Hex  
14 V



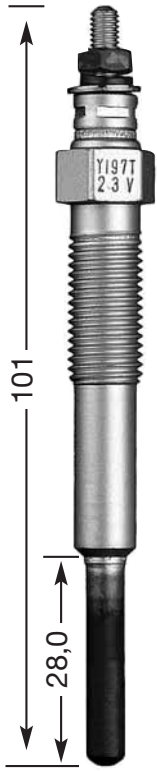

**Y-197 T**  
M 10 x 1.25  
12 Hex  
23 V

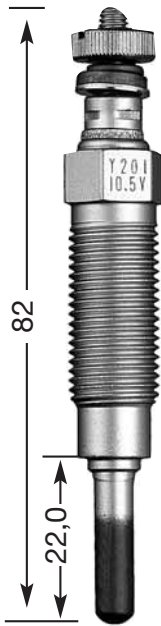

**Y-201**  
M 12 x 1.25  
12 Hex  
10,5 V

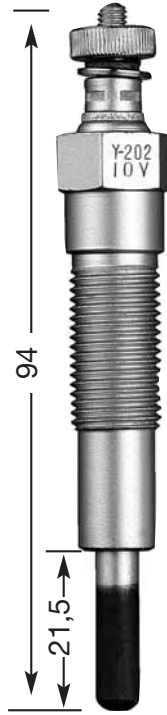

**Y-202**  
M 12 x 1.25  
14 Hex  
10 V

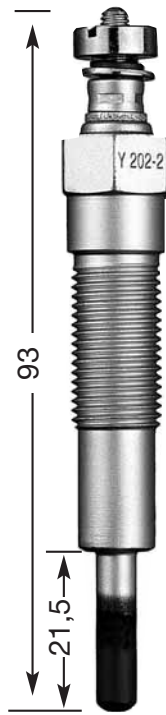

**Y-202-2**  
M 12 x 1.25  
14 Hex

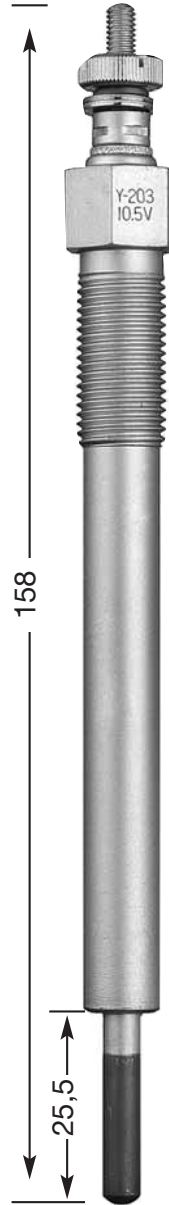

**Y-203**  
M 12 x 1.25  
14 Hex  
10,5 V

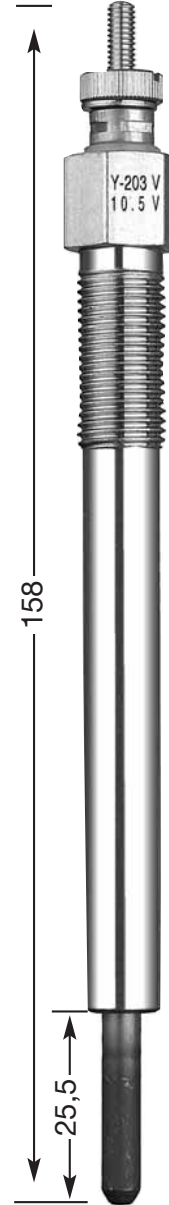

**Y-203 V**  
M 12 x 1.25  
14 Hex  
10,5 V

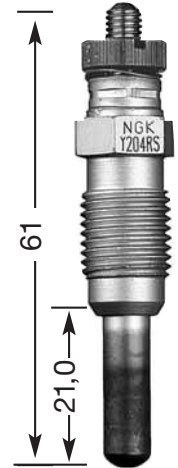

**Y-204 RS**  
M 12 x 1.25  
12 Hex  
6,5 V

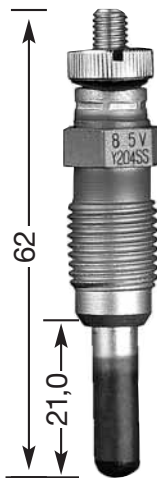

**Y-204 SS**  
M 12 x 1.25  
12 Hex  
8,5 V

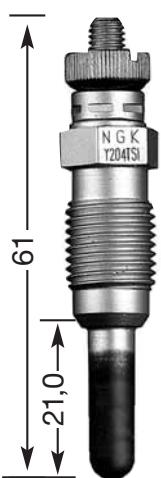

**Y-204 TS1**  
M 12 x 1.25  
12 Hex  
11 V

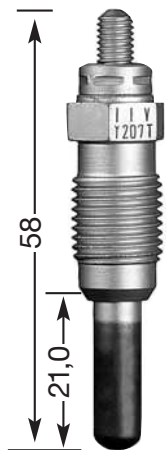

**Y-207 T**  
M 12 x 1.25  
12 Hex  
11 V

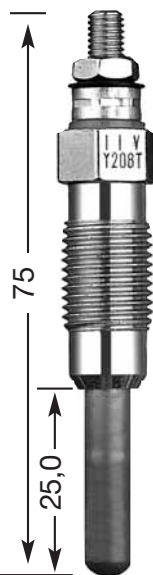

**Y-208 T**  
M 12 x 1.25  
12 Hex  
11 V

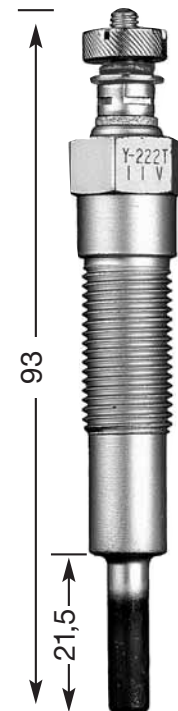

**Y-222 T**  
M 12 x 1.25  
14 Hex  
11 V

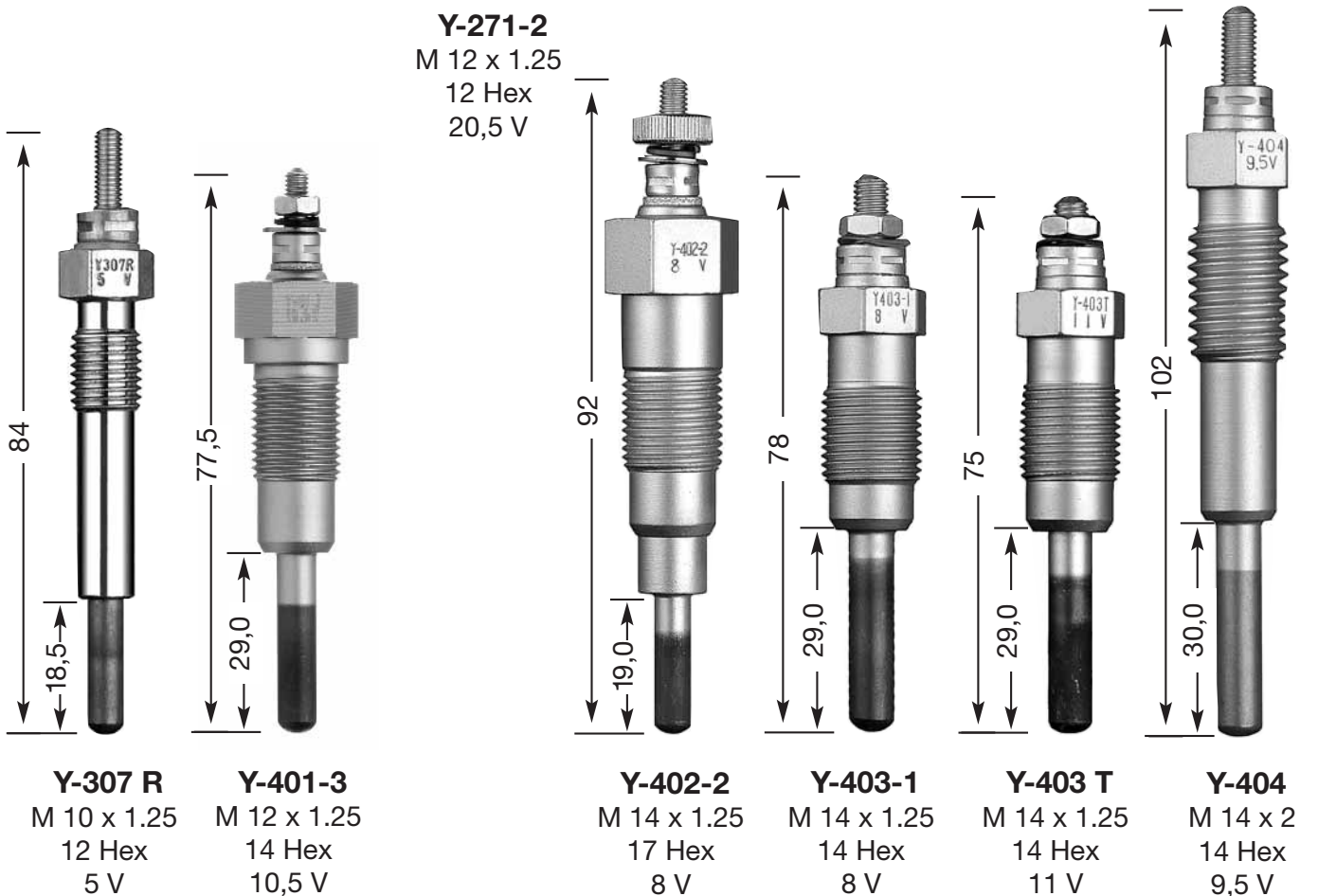
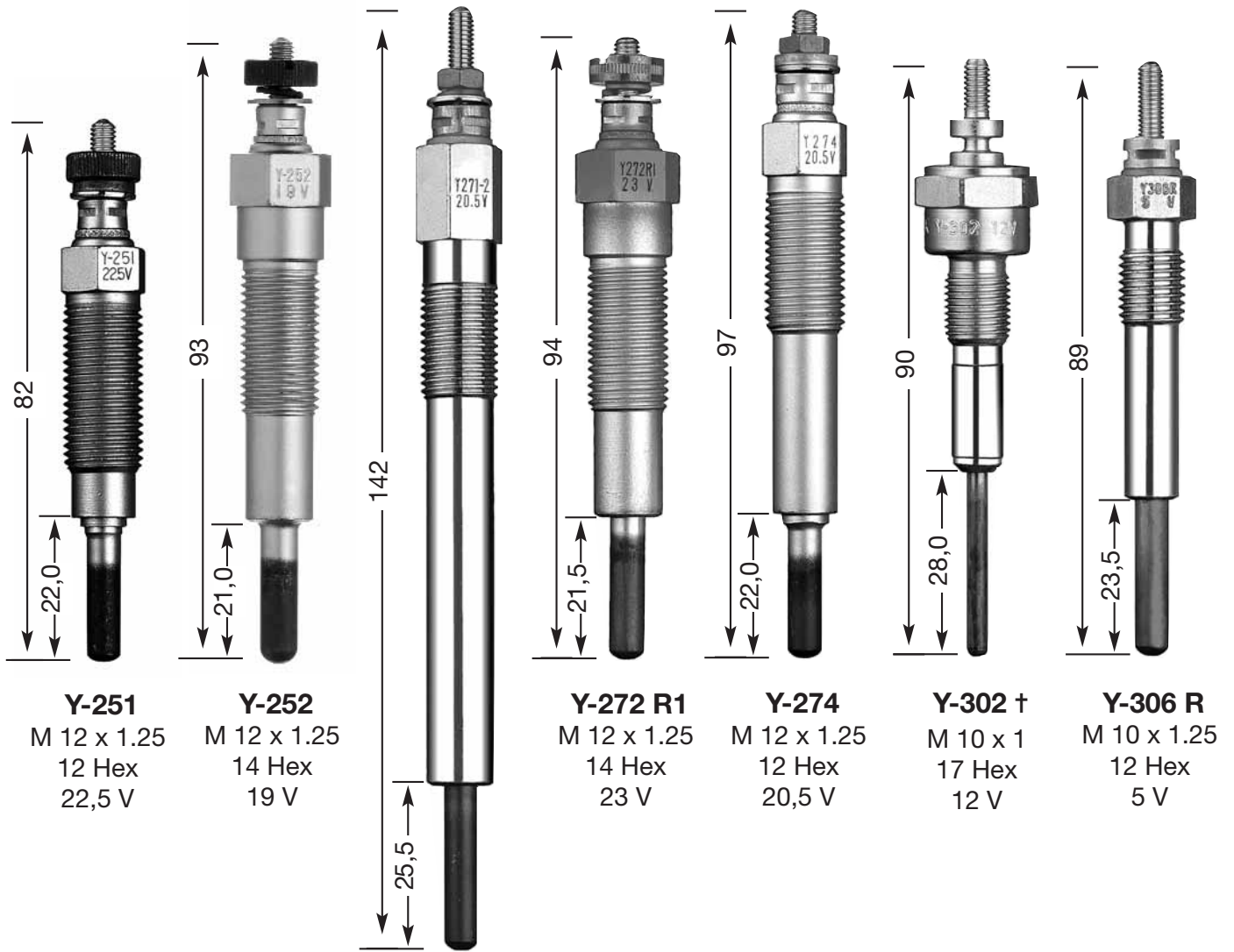



**Y-405**  
M 14 x 1.25  
17 Hex  
9,5 V

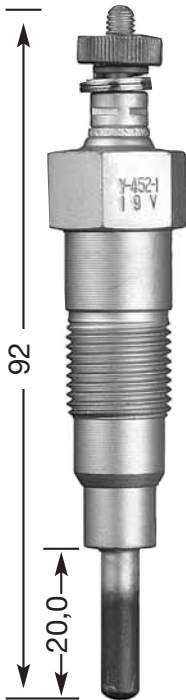

**Y-452-1**  
M 14 x 1.25  
17 Hex  
19 V

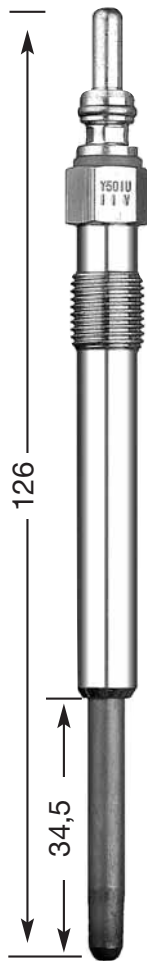

**Y-501-U**  
M 10 x 1.0  
10 Hex  
11 V  
**DP 31**



**Y-502 R**  
M 10 x 1.0  
10 Hex  
11 V

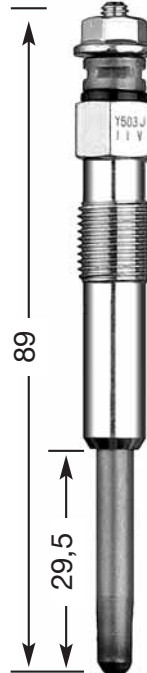

**Y-503 J**  
M 10 x 1.0  
10 Hex  
11 V

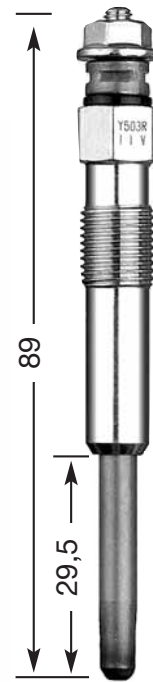

**Y-503 R**  
M 10 x 1.0  
10 Hex  
11 V

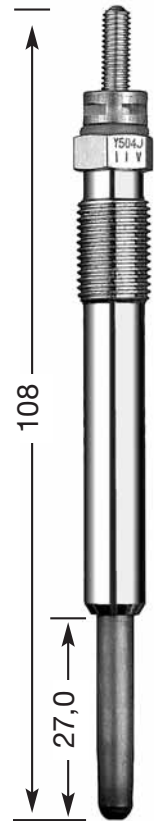

**Y-504 J**  
M 10 x 1.0  
10 Hex  
11 V

**DP 24**

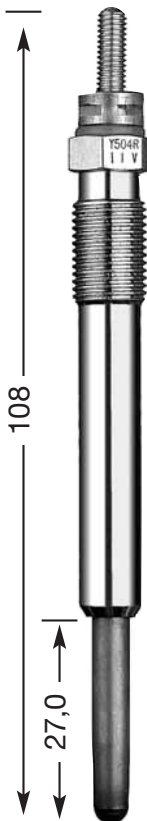

**Y-504 R**  
M 10 x 1.0  
10 Hex  
11 V

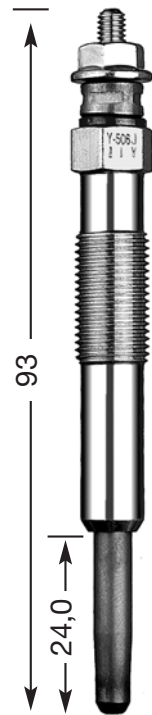

**Y-506 J**  
M 10 x 1.0  
10 Hex  
11 V

**DP 7**

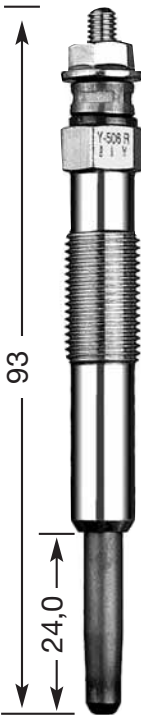

**Y-506 R**  
M 10 x 1.0  
10 Hex  
11 V



**Y-507 J**  
M 10 x 1.0  
10 Hex  
11 V

**DP 32**



**Y-507 R**  
M 10 x 1.0  
10 Hex  
11 V

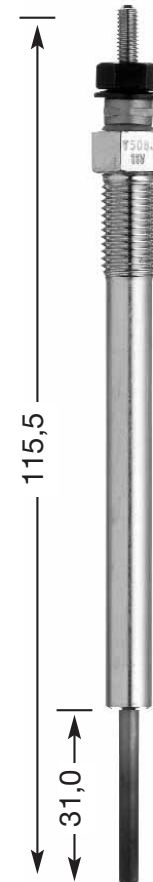

**Y-508 J**  
M 10 x 1.25  
12 Hex  
11 V



**Y-515 J**  
M 10 x 1.0  
10 Hex  
11 V

**DP 18**



**Y-516 J**  
M 10 x 1.0  
10 Hex  
11 V  
**DP 12**



**Y-517 J**  
M 10 x 1.0  
10 Hex  
11 V

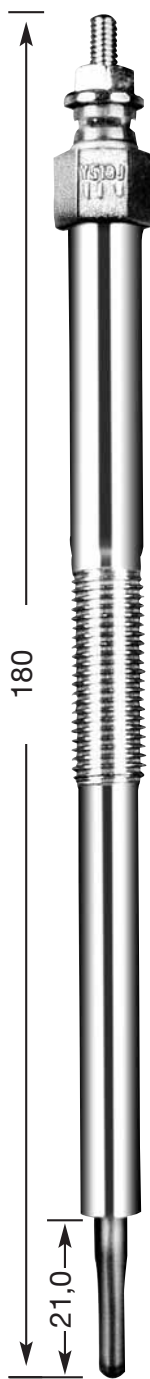

**Y-519 J**  
M 12 x 1.0  
10 Hex  
11 V

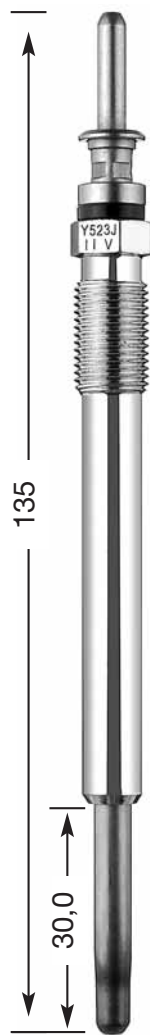

**Y-523 J**  
M 10 x 1.25  
10 Hex  
11 V  
**DP 37**

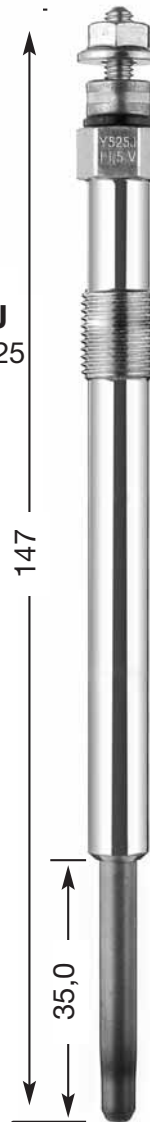

**Y-525 J**  
M 10 x 1,25  
10 Hex  
11,5 V  
**DP 35**

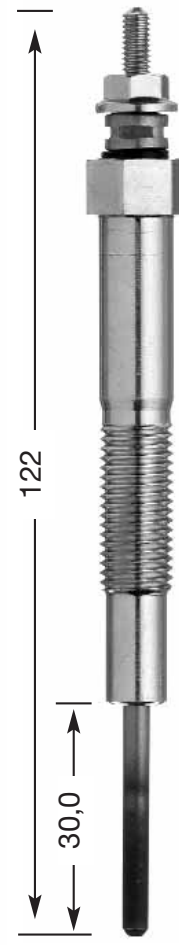

**Y-529 J**  
M 10 x 1.25  
12 Hex  
11 V



**Y-524 J**  
M 10 x 1.25  
10 Hex  
10 V  
**DP 27**

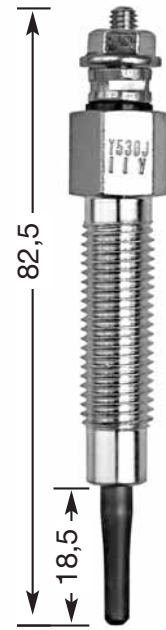

**Y-530 J**  
M 10 x 1.25  
12 Hex  
11 V

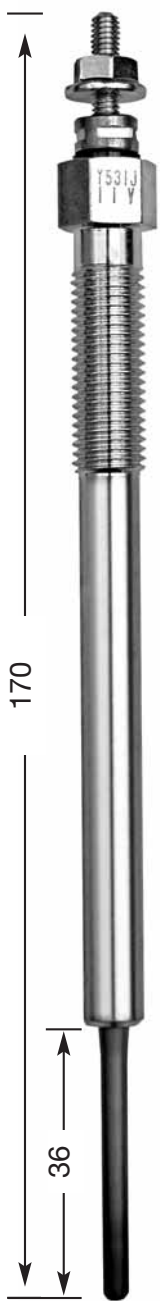

**Y-531 J**  
M 10 x 1.25  
12 Hex  
11 V  
**DP 44**



**Y-532 J**  
M 10 x 1.25  
12 Hex  
11 V

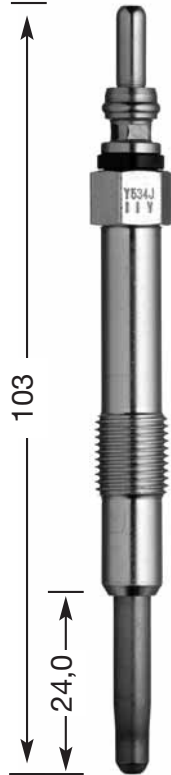

**Y-534 J**  
M 10 x 1.25  
10 Hex  
11 V  
**DP 36**



**Y-541 J**  
M 10 x 1.25  
12 Hex  
**DP 42**



**Y-542 J**  
M 10 x 1.25  
10 Hex  
11 V  
**DP 45**



**Y-543 J**  
M 10 x 1.25  
10 Hex  
11 V  
**DP 46**



**Y-547 AS**  
M 10 x 1.25  
10 Hex  
5 V  
**DP 47**

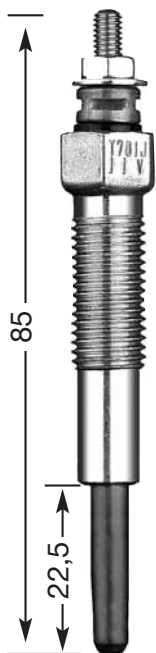

**Y-701 J**  
M 10 x 1.25  
12 Hex  
11 V  
**DP 39**



**Y-701 R**  
M 10 x 1.25  
12 Hex  
11 V

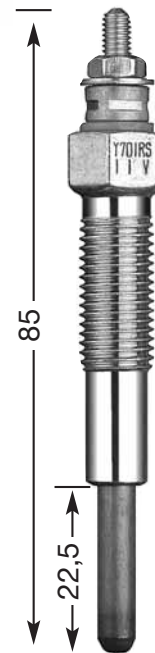

**Y-701 RS**  
M 10 x 1.25  
12 Hex  
11 V



**Y-701 U**  
M 10 x 1.25  
12 Hex  
10 V

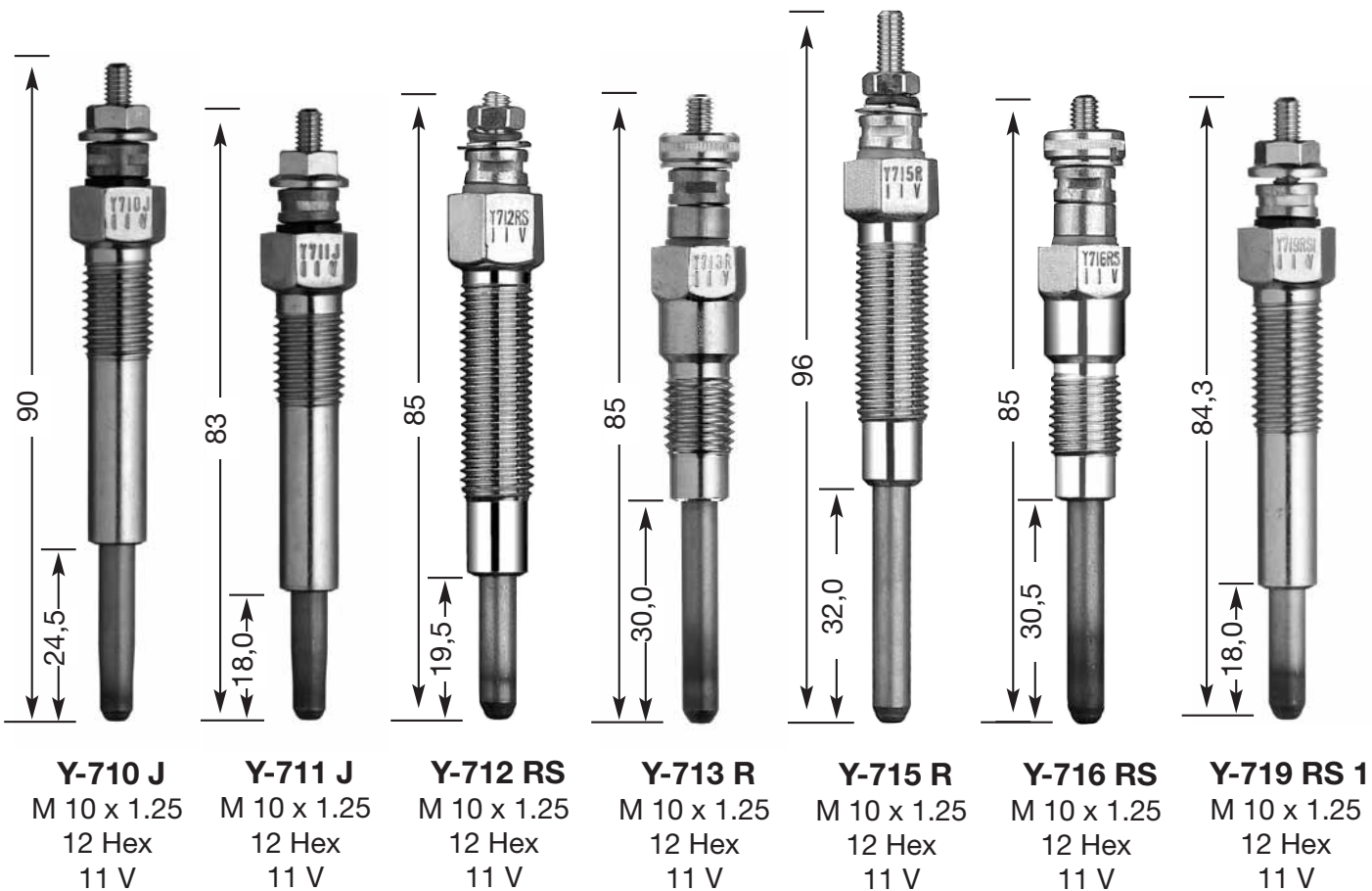
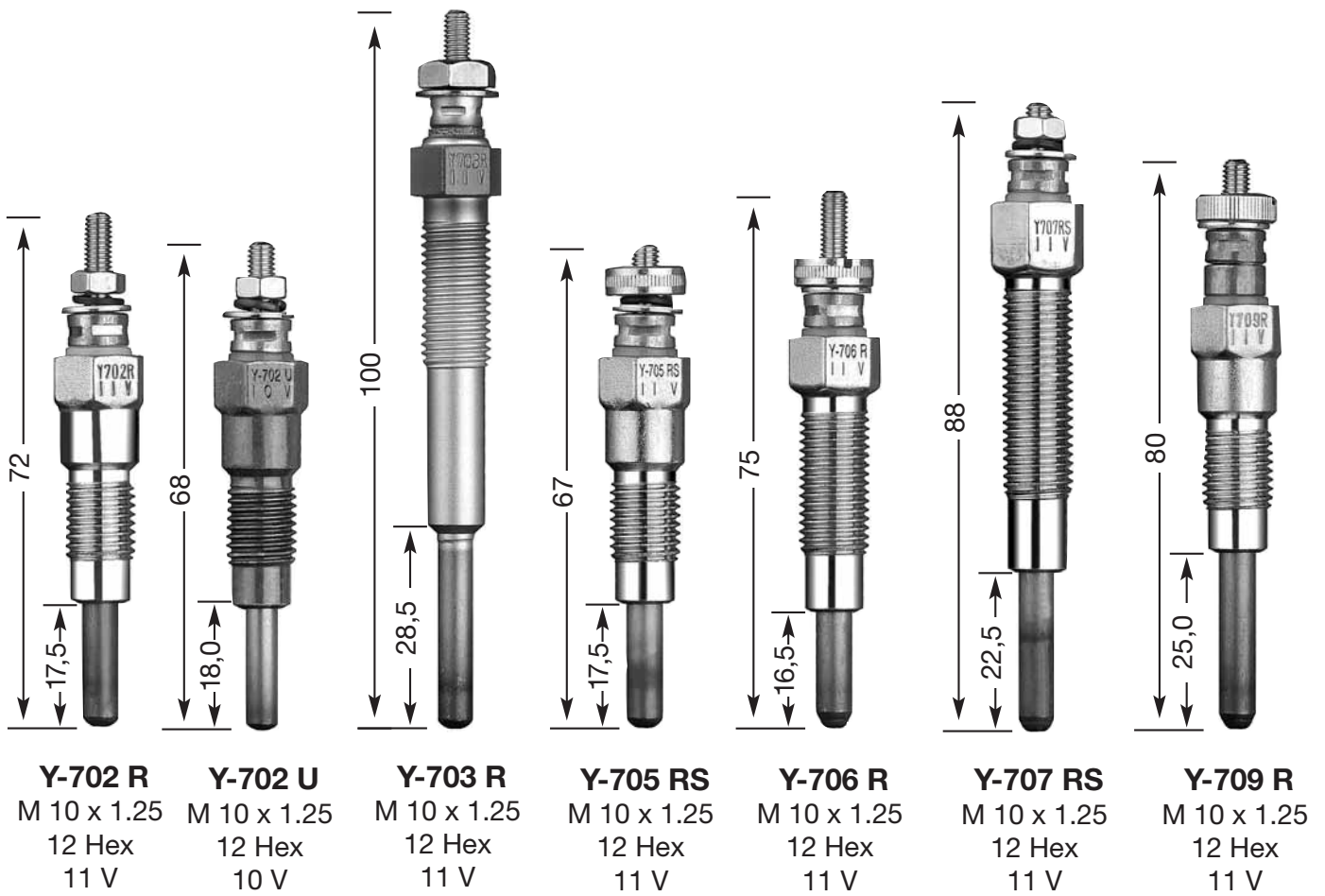

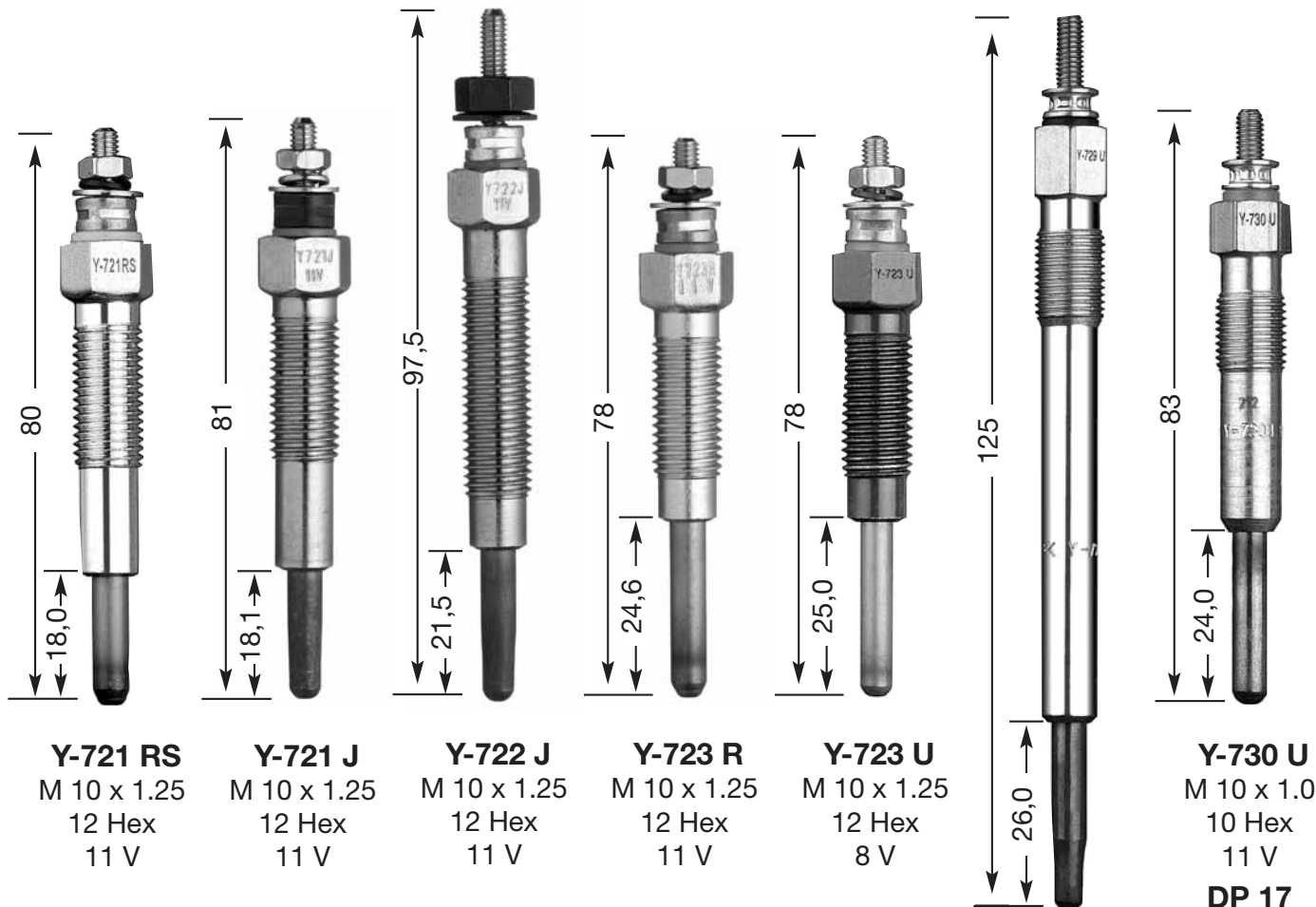

**Y-721 RS**  
M 10 x 1.25  
12 Hex  
11 V

**Y-721 J**  
M 10 x 1.25  
12 Hex  
11 V

**Y-722 J**  
M 10 x 1.25  
12 Hex  
11 V

**Y-723 R**  
M 10 x 1.25  
12 Hex  
11 V

**Y-723 U**  
M 10 x 1.25  
12 Hex  
8 V

**Y-729 U**  
M 10 x 1.0  
10 Hex  
11,5 V  
**DP 34**

**Y-730 U**  
M 10 x 1.0  
10 Hex  
11 V  
**DP 17**

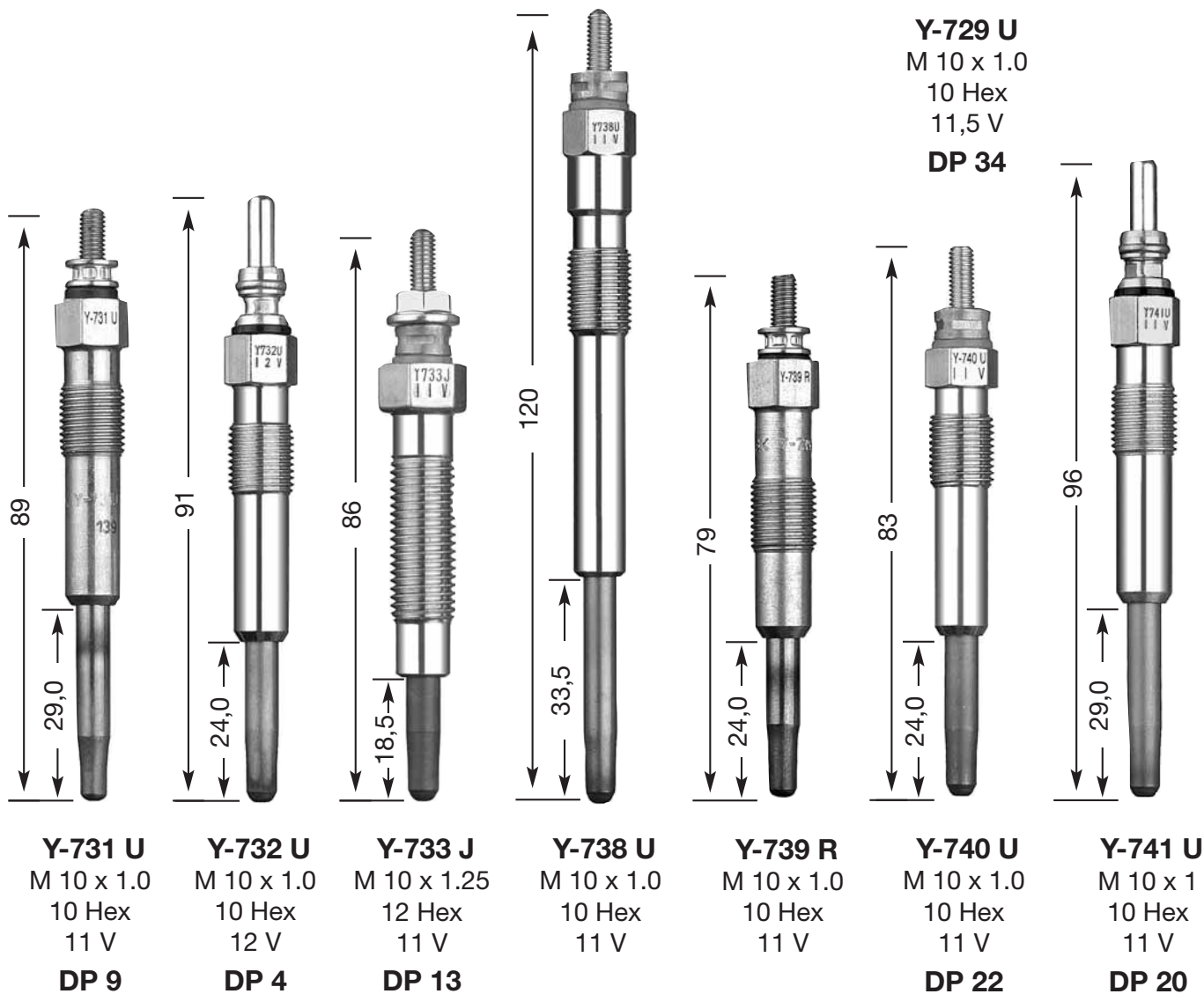

**Y-731 U**  
M 10 x 1.0  
10 Hex  
11 V  
**DP 9**

**Y-732 U**  
M 10 x 1.0  
10 Hex  
12 V  
**DP 4**

**Y-733 J**  
M 10 x 1.25  
12 Hex  
11 V  
**DP 13**

**Y-738 U**  
M 10 x 1.0  
10 Hex  
11 V

**Y-739 R**  
M 10 x 1.0  
10 Hex  
11 V

**Y-740 U**  
M 10 x 1.0  
10 Hex  
11 V  
**DP 22**

**Y-741 U**  
M 10 x 1  
10 Hex  
11 V  
**DP 20**

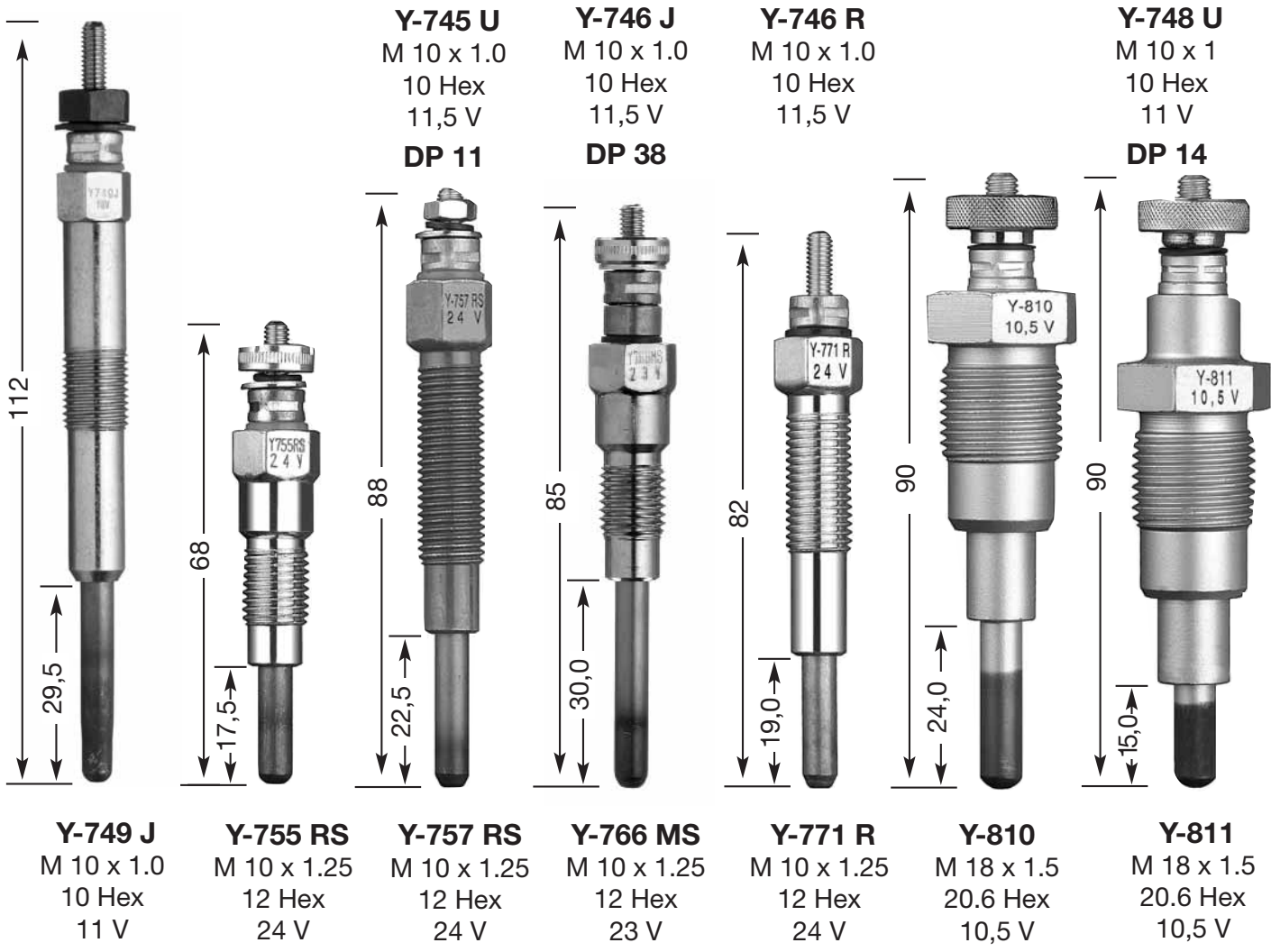
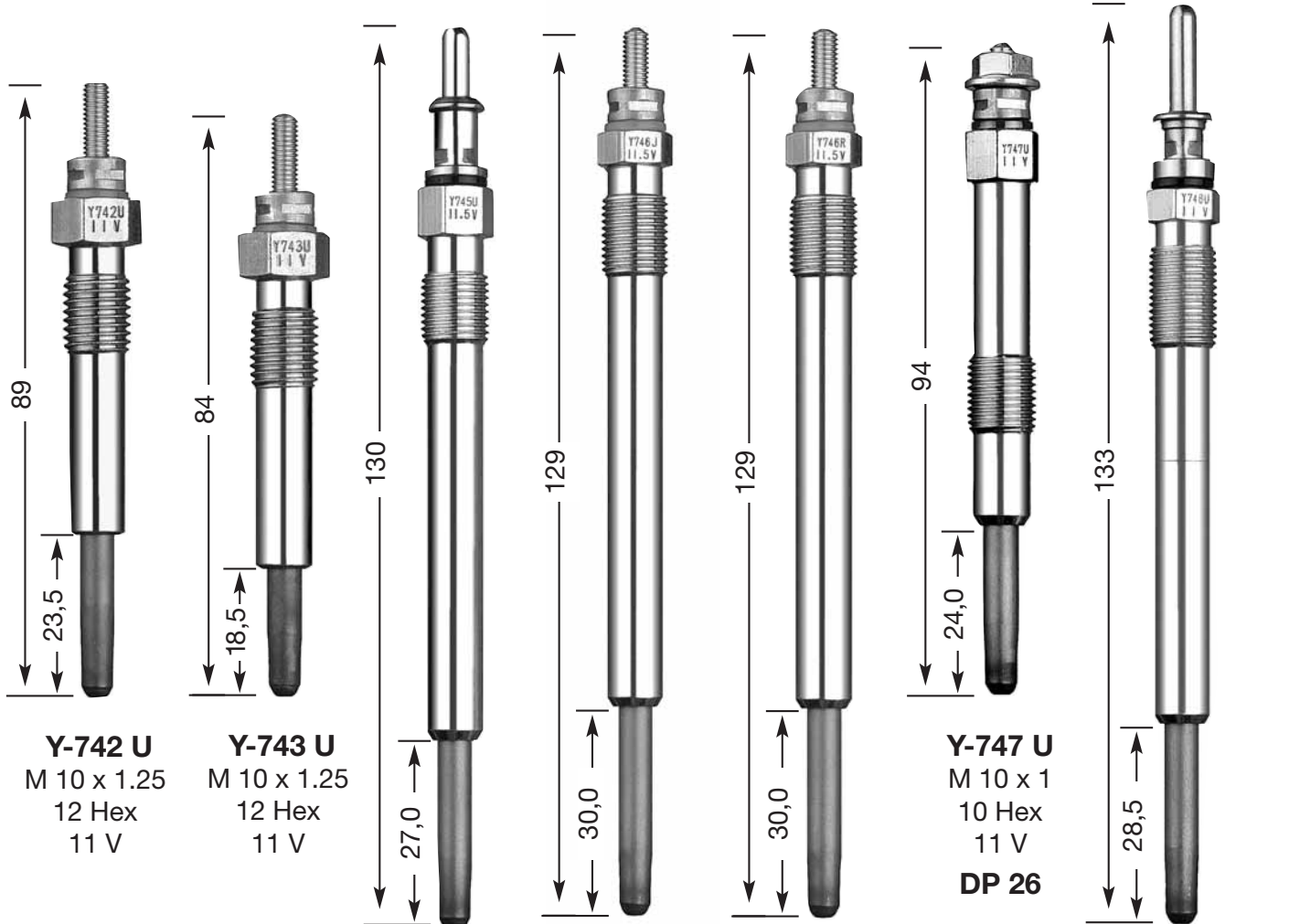



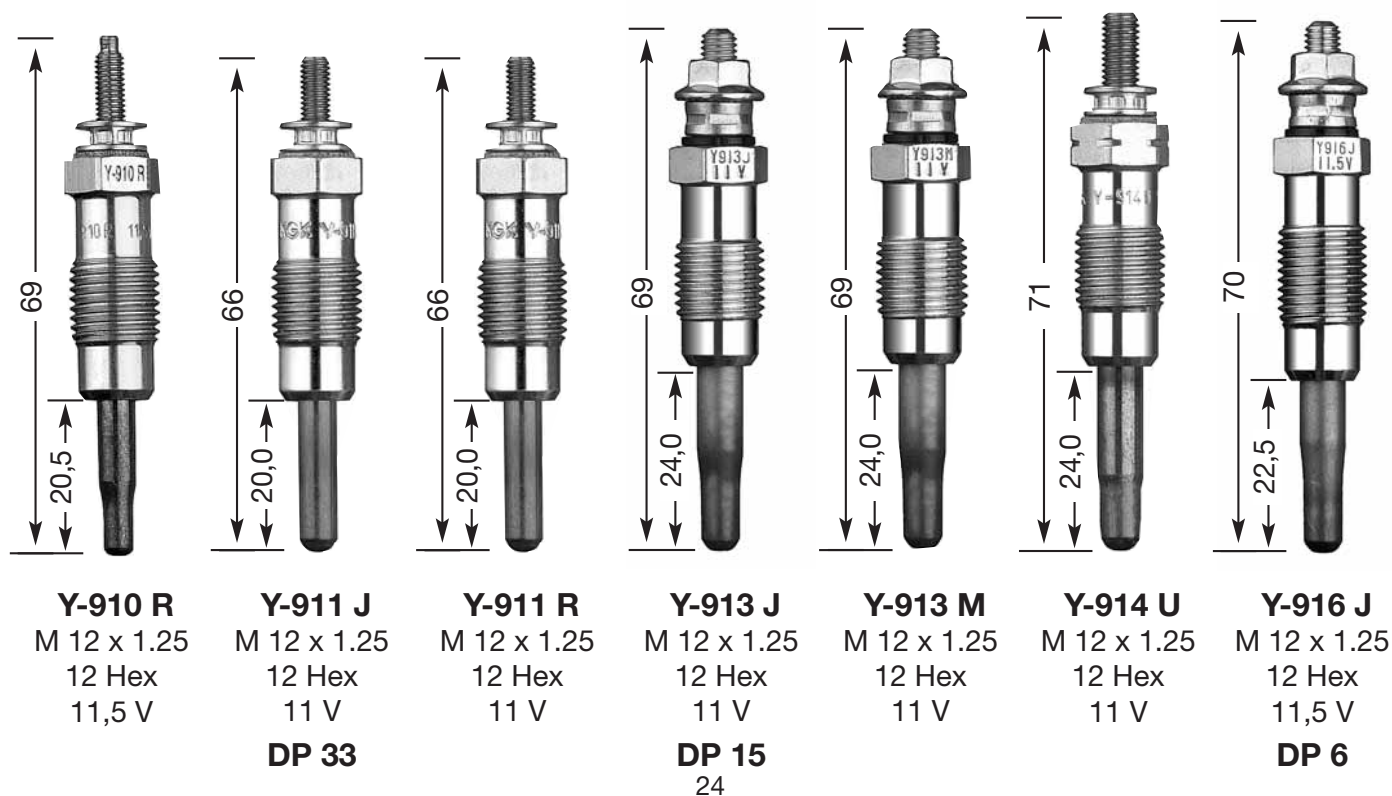
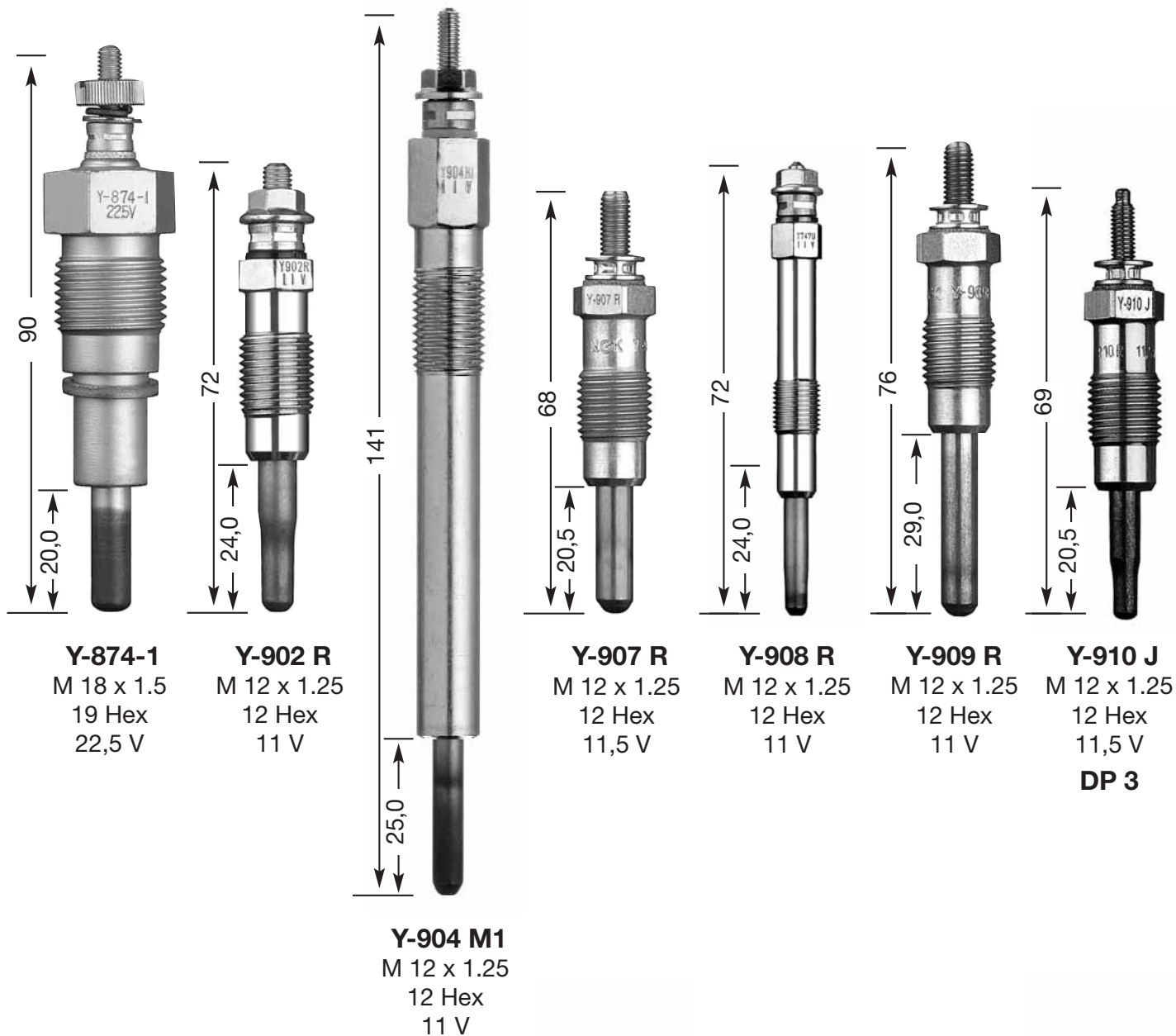

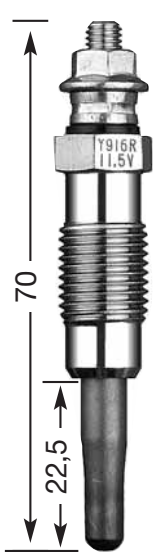

**Y-916 R**  
M 12 x 1.25  
12 Hex  
11,5 V

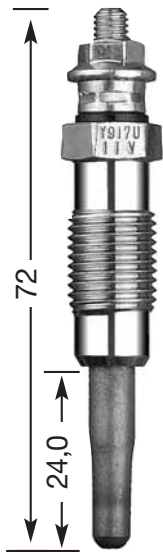

**Y-917 U**  
M 12 x 1.25  
12 Hex  
11 V

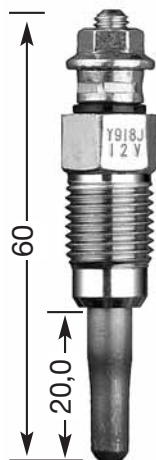

**Y-918 J**  
M 12 x 1.25  
12 Hex  
12 V



**Y-918 R**  
M 12 x 1.25  
12 Hex  
12 V

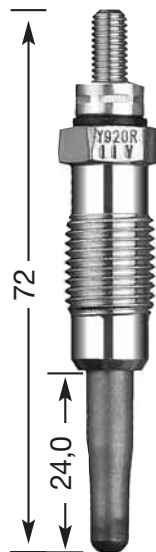

**Y-920 R**  
M 12 x 1.25  
12 Hex  
11 V



**Y-922 R**  
M 12 x 1.25  
12 Hex  
11 V

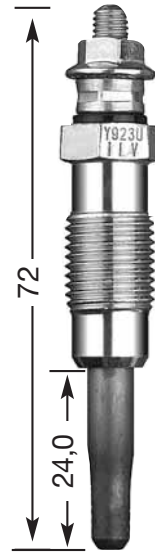

**Y-923 U**  
M 12 x 1.25  
12 Hex  
11 V

**DP 2**

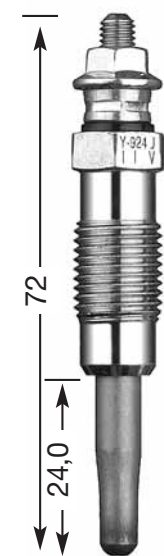

**Y-924 J**  
M 12 x 1.25  
12 Hex  
11 V

**DP 1**

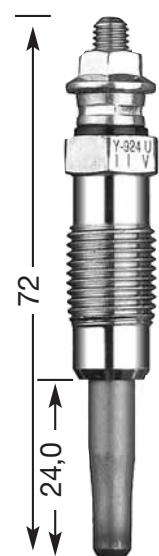

**Y-924 U**  
M 12 x 1.25  
12 Hex  
11 V

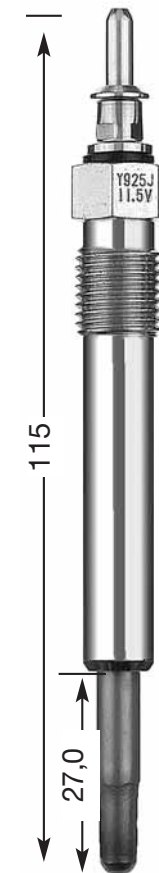

**Y-925 J**  
M 12 x 1.25  
12 Hex  
11,5 V

**DP 16**

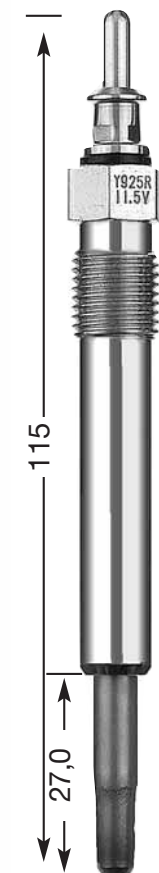

**Y-925 R**  
M 12 x 1.25  
12 Hex  
11,5 V



**Y-926 U**  
M 12 x 1.25  
12 Hex  
11 V

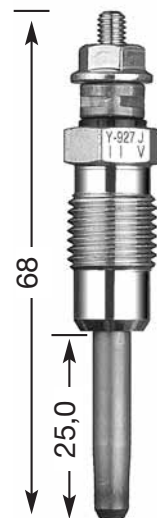

**Y-927 J**  
M 12 x 1.25  
12 Hex  
11 V

**DP 19**

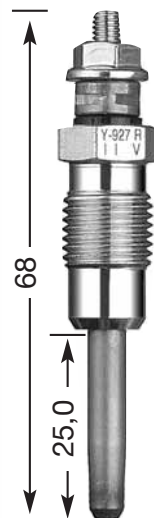

**Y-927 R**  
M 12 x 1.25  
12 Hex  
11 V

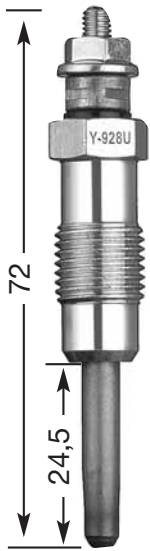

**Y-928 U**  
M 12 x 1.25  
12 Hex  
11 V  
**DP 29**



**Y-929 U**  
M 12 x 1.25  
12 Hex  
11,5 V  
**DP 41**

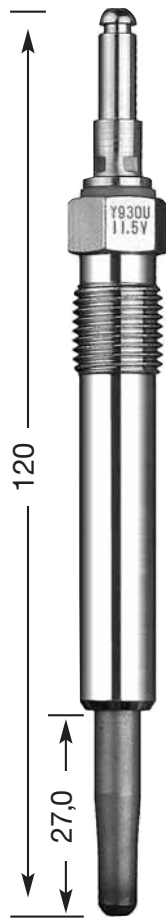

**Y-930 U**  
M 12 x 1.25  
12 Hex  
11,5 V  
**DP 30**

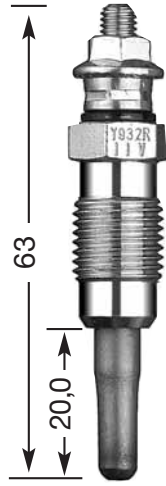

**Y-932 R**  
M 12 x 1.25  
12 Hex  
11 V

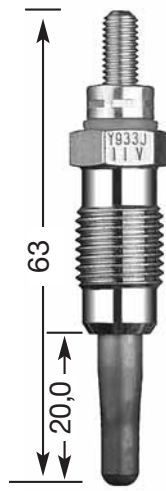

**Y-933 J**  
M 12 x 1.25  
12 Hex  
11 V  
**DP 25**

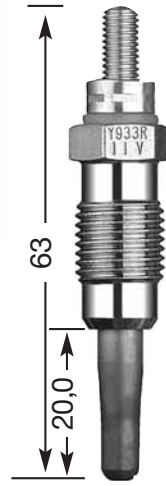

**Y-933 R**  
M 12 x 1.25  
12 Hex  
11 V

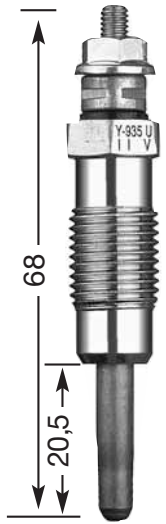

**Y-935 U**  
M 12 x 1.25  
12 Hex  
11 V  
**DP 23**

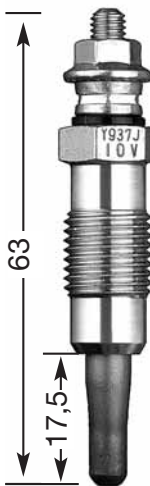

**Y-937 J**  
M 12 x 1.25  
12 Hex  
10 V  
**DP 5**

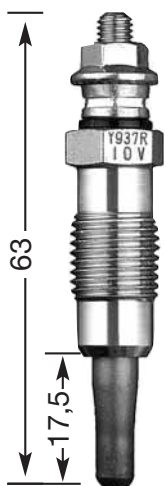

**Y-937 R**  
M 12 x 1.25  
12 Hex  
10 V

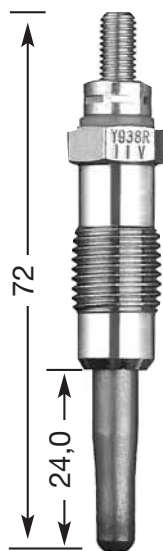

**Y-938 R**  
M 12 x 1.25  
12 Hex  
11 V



**Y-939 J**  
M 12 x 1.25  
12 Hex  
11 V  
**DP 43**

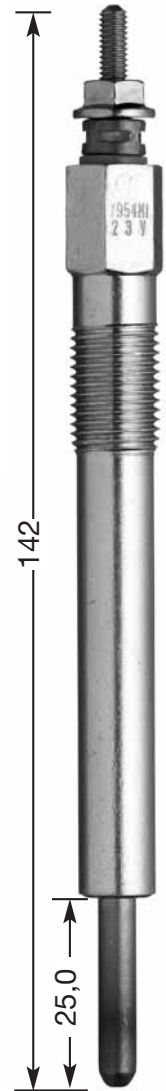

**Y-954 M1**  
M 12 x 1.25  
12 Hex  
23 V

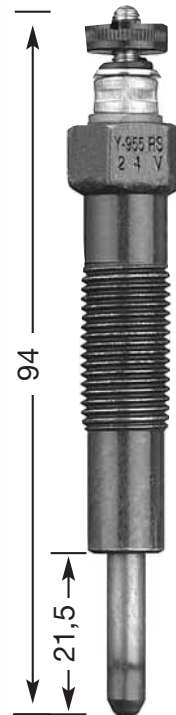

**Y-955 RS**  
M 12 x 1.25  
14 Hex  
24 V

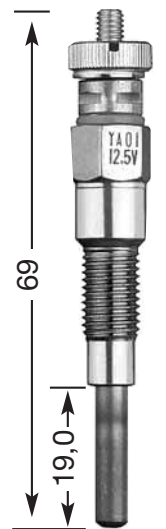

**YA 01**  
M 8 x 1.0  
10 Hex  
12,5 V

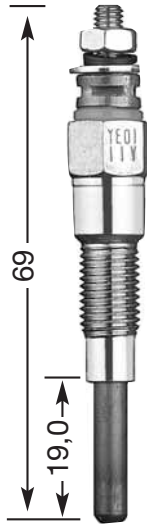

**YE 01**  
M 8 x 1.0  
10 Hex  
11 V

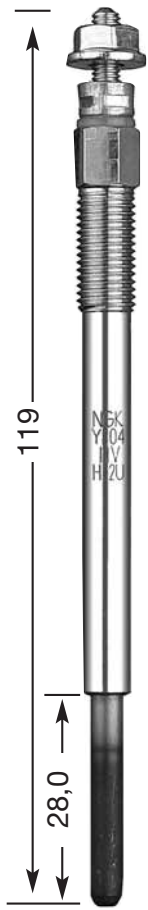

**YE 04**  
M 8 x 1.0  
8 Hex  
11 V  
**DP 40**

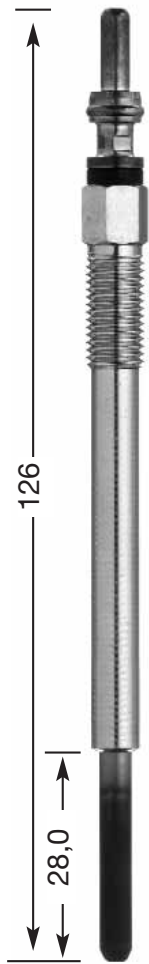

**YE 05**  
M 8 x 1.0  
8 Hex  
11 V

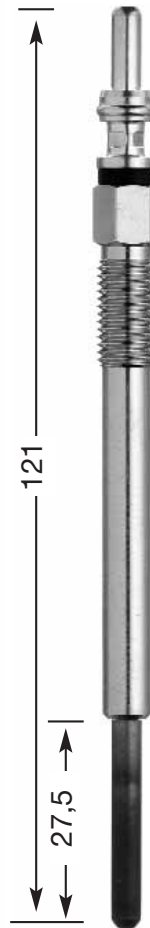

**YE 06**  
M 8 x 1.0  
8 Hex  
11 V

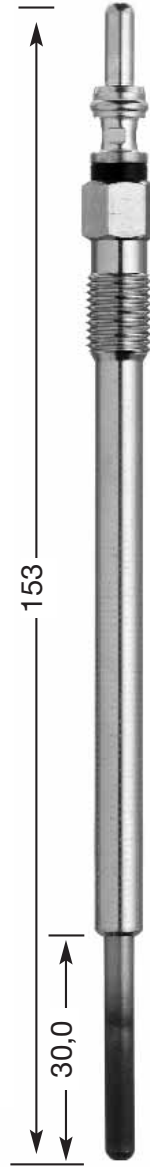

**YE 07**  
M 9 x 1.0  
9 Hex  
11 V

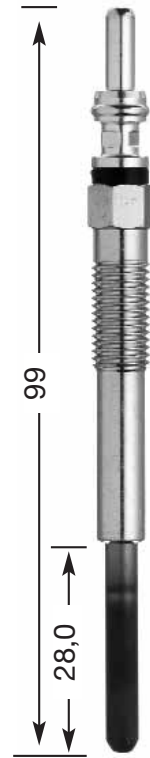

**YE 08**  
M 8 x 1.0  
8 Hex  
11 V

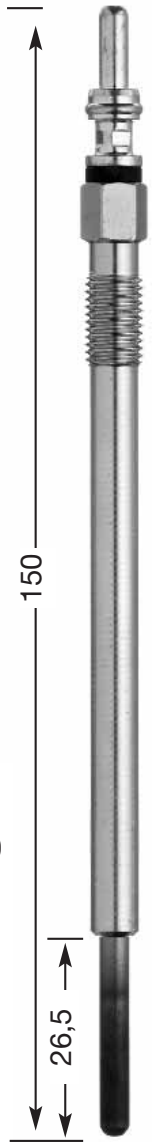

**YE 13**  
M 8 x 1.0  
8 Hex  
11,5 V

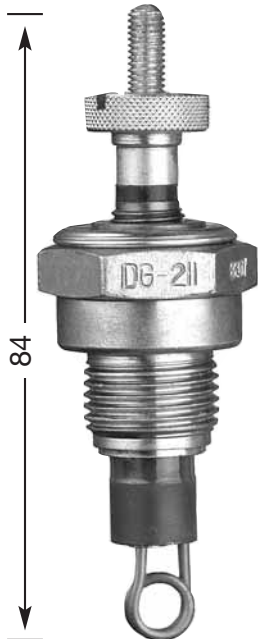

**DG-211**  
M 18 x 1.5  
25 Hex

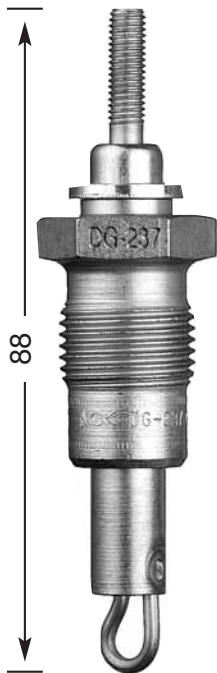

**DG-237 †**  
M 18 x 1.5  
21 Hex  
0,9 V

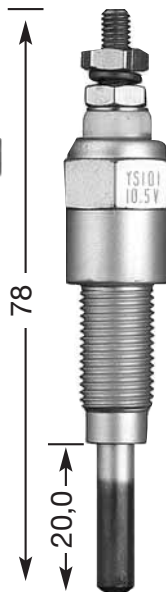

**YS 101**  
M 10 x 1.0  
14 Hex  
10,5 V



**CX 51**  
M 10 x 1.25  
10 Hex  
6,5 V

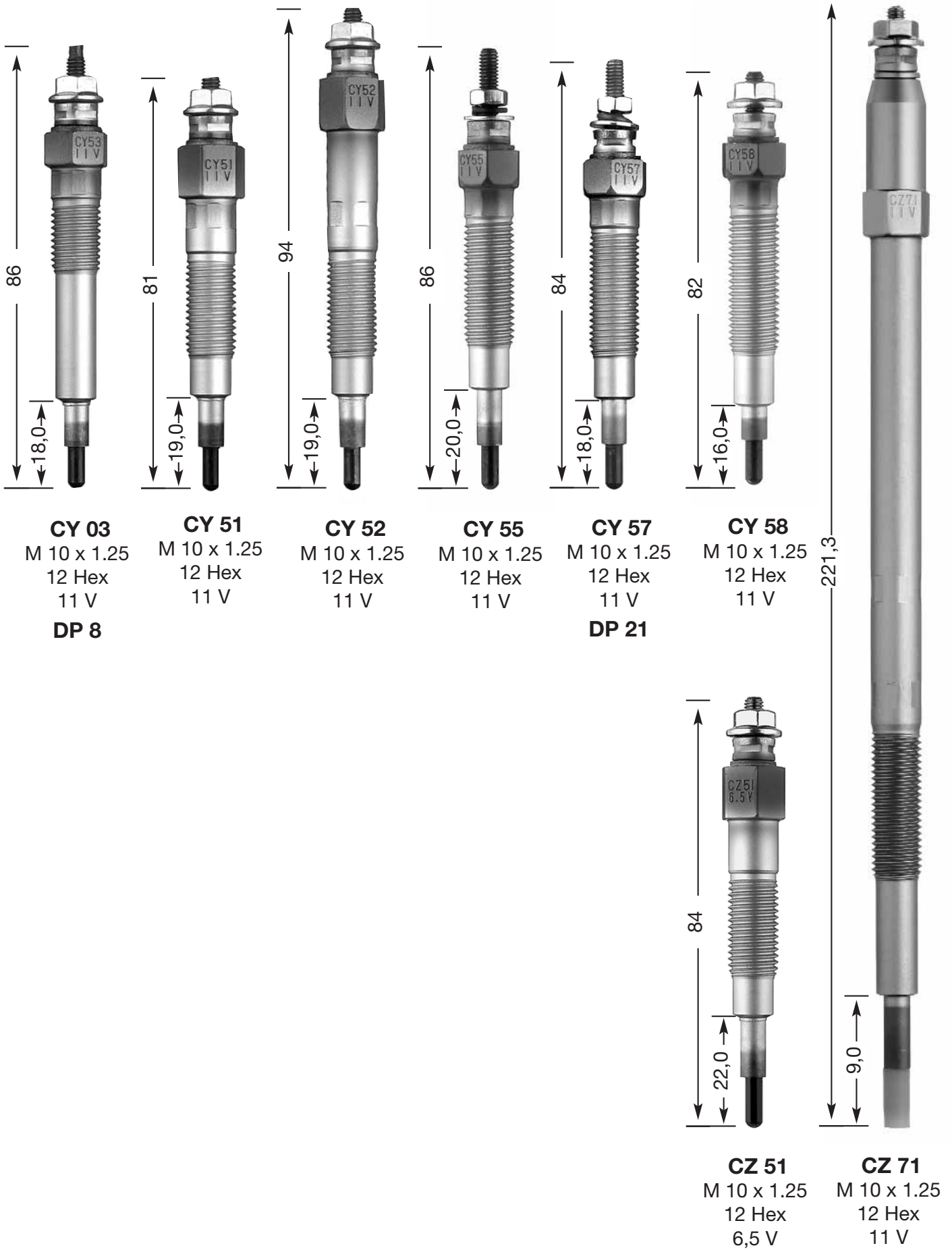

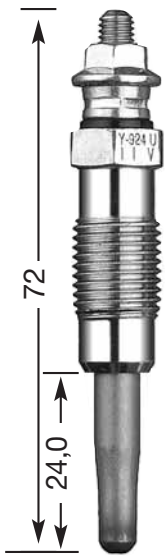

**Y-924 U**  
M 12 x 1.25  
12 Hex  
11 V  
**DP 1**

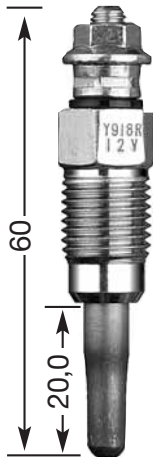

**Y-918 R**  
M 12 x 1.25  
12 Hex  
12 V  
**DP 2**

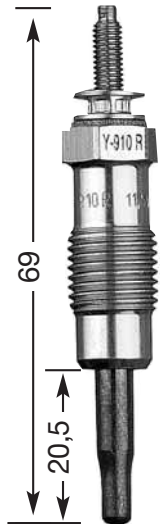

**Y-910 R**  
M 12 x 1.25  
12 Hex  
11,5 V  
**DP 3**

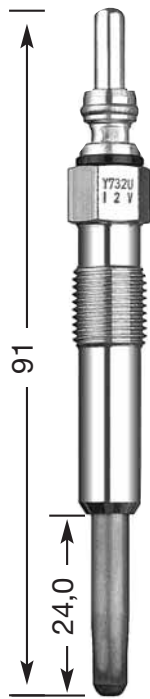

**Y-732 U**  
M 10 x 1.0  
10 Hex  
12 V  
**DP 4**

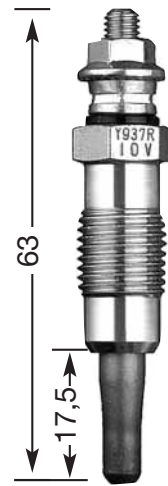

**Y-937 R**  
M 12 x 1.25  
12 Hex  
10 V  
**DP 5**

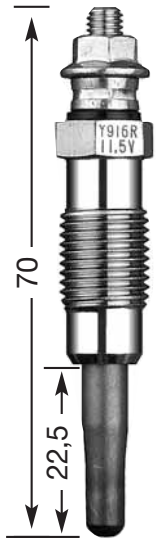

**Y-916 R**  
M 12 x 1.25  
12 Hex  
11,5 V  
**DP 6**

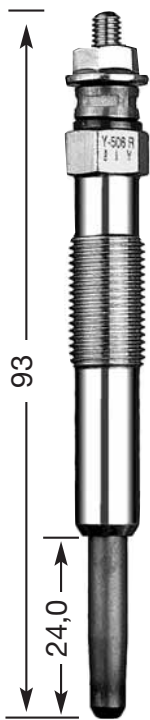

**Y-506 R**  
M 10 x 1.0  
10 Hex  
11 V  
**DP 7**

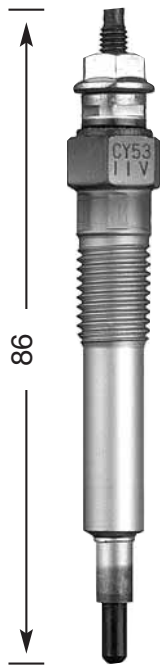

**CY 53**  
M 10 x 1.25  
12 Hex  
11 V  
**DP 8**

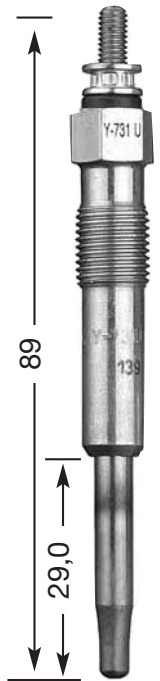

**Y-731 U**  
M 10 x 1.0  
10 Hex  
11 V  
**DP 9**

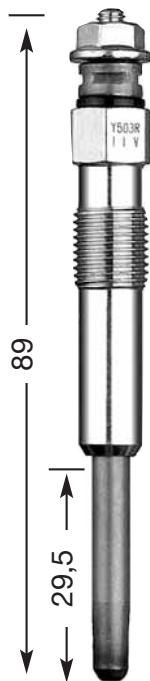

**Y-503 R**  
M 10 x 1.0  
10 Hex  
11 V  
**DP 10**

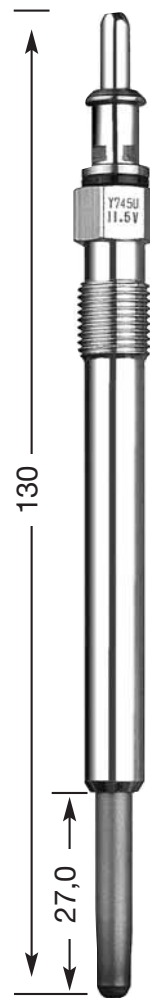

**Y-745 U**  
M 10 x 1.0  
10 Hex  
11,5 V  
**DP 11**



**Y-516 J**  
M 10 x 1.0  
10 Hex  
11 V  
**DP 12**

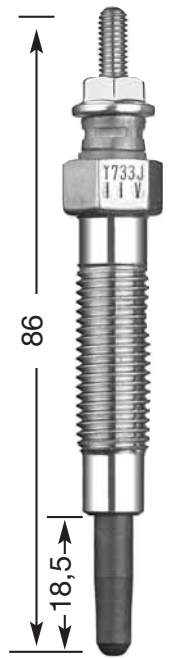

**Y-733 J**  
M 10 x 1.25  
12 Hex  
11 V  
**DP 13**

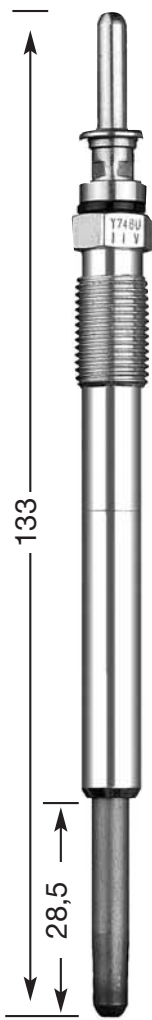

**Y-748 U**  
M 10 x 1.0  
10 Hex  
11 V  
**DP 14**

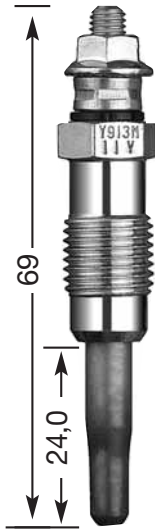

**Y-913 M**  
M 12 x 1.25  
12 Hex  
11 V  
**DP 15**

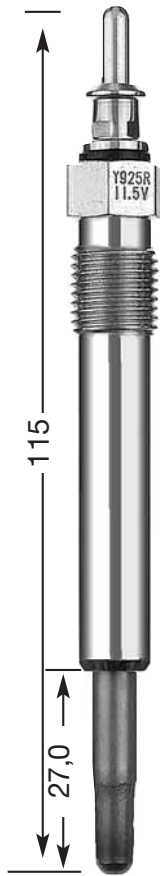

**Y-925 R**  
M 12 x 1.25  
12 Hex  
11,5 V  
**DP 16**

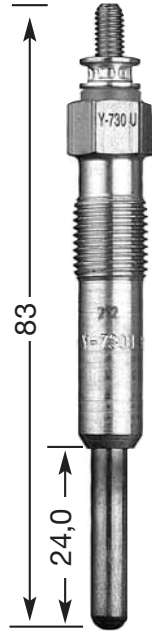

**Y-730 U**  
M 10 x 1.0  
10 Hex  
11 V  
**DP 17**



**Y-515 J**  
M 10 x 1.0  
10 Hex  
11 V  
**DP 18**

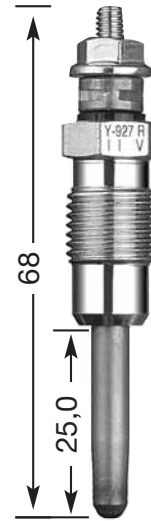

**Y-927 R**  
M 12 x 1.25  
12 Hex  
11 V  
**DP 19**

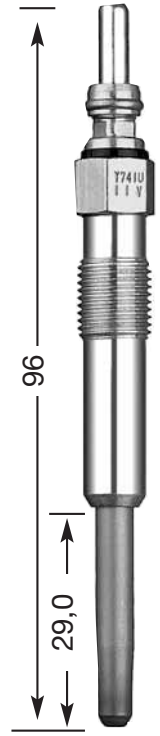

**Y-741 U**  
M 10 x 1.0  
10 Hex  
11 V  
**DP 20**

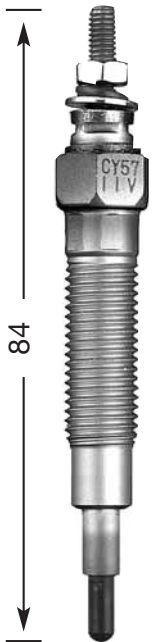

**CY 57**  
M 10 x 1.25  
12 Hex  
11 V  
**DP 21**

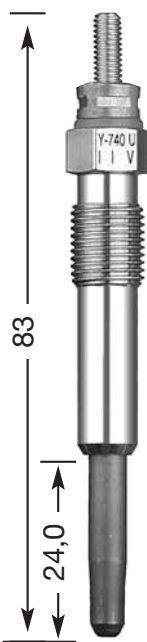

**Y-740 U**  
M 10 x 1.0  
10 Hex  
11 V  
**DP 22**

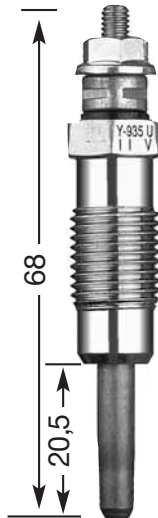

**Y-935 U**  
M 12 x 1.25  
12 Hex  
11 V  
**DP 23**

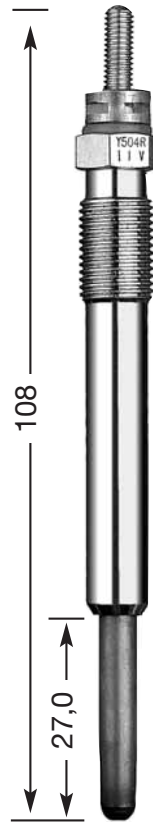

**Y-504 R**  
M 10 x 1.0  
10 Hex  
11 V  
**DP 24**

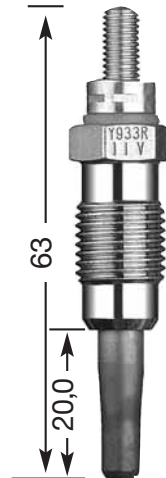

**Y-933 R**  
M 12 x 1.25  
12 Hex  
11 V  
**DP 25**

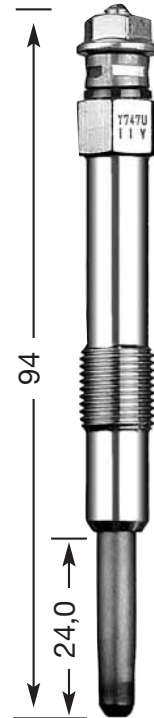

**Y-747 U**  
M 10 x 1.0  
10 Hex  
11 V  
**DP 26**



**Y-524 J**  
M 10 x 1.25  
10 Hex  
10 V  
**DP 27**



**Y-711 J**  
M 10 x 1.25  
12 Hex  
11 V  
**DP 28**

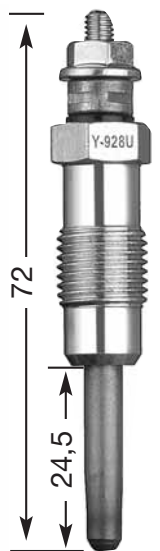

**Y-928 U**  
M 12 x 1.25  
12 Hex  
11 V  
**DP 29**

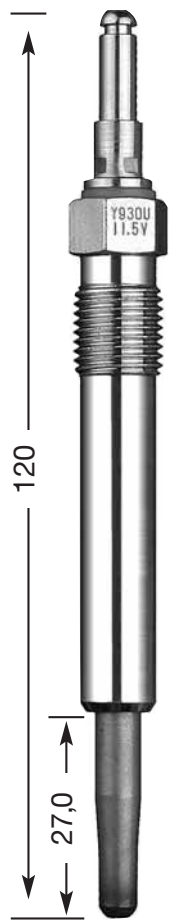

**Y-930 U**  
M 12 x 1.25  
12 Hex  
11,5 V

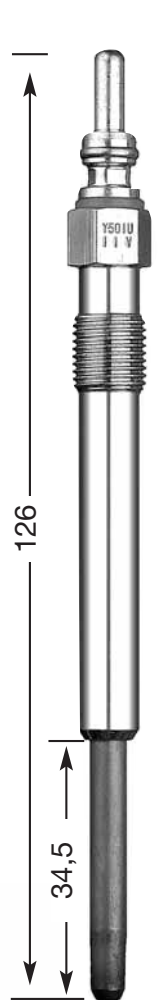

**Y-501-U**  
M 10 x 1.0  
10 Hex  
11 V  
**DP 31**

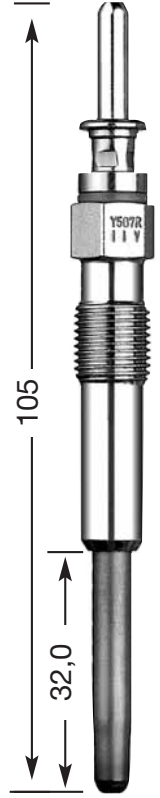

**Y-507 R**  
M 10 x 1.0  
10 Hex  
11 V  
**DP 32**



**Y-911 R**  
M 12 x 1.25  
12 Hex  
11 V  
**DP 33**

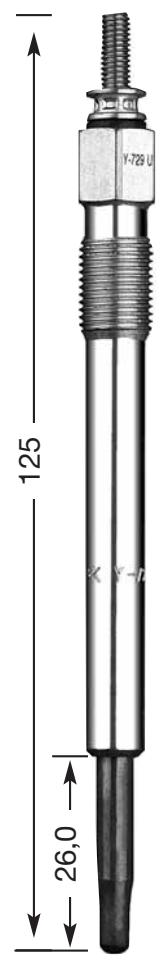

**Y-729 U**  
M 10 x 1.0  
10 Hex  
11,5 V  
**DP 34**

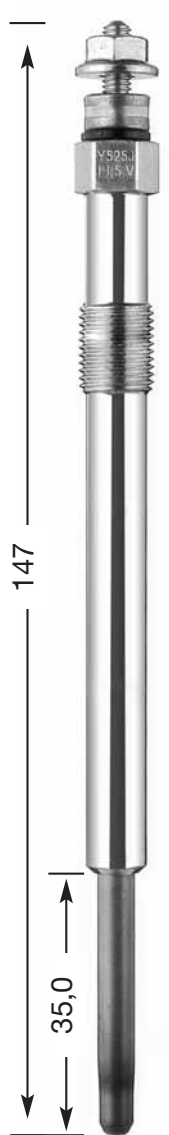

**Y-525 J**  
M 10 x 1.25  
10 Hex  
11,5 V  
**DP 35**

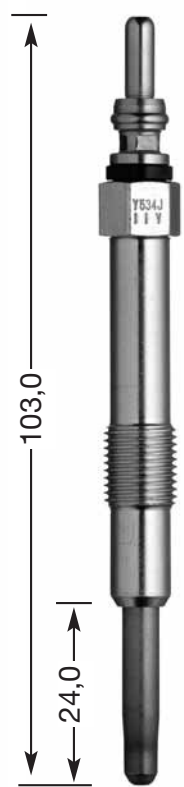

**Y-534 J**  
M 10 x 1.25  
10 Hex  
11 V  
**DP 36**

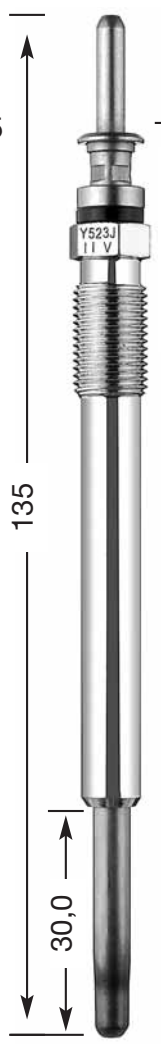

**Y-523 J**  
M 10 x 1.25  
10 Hex  
11 V  
**DP 37**

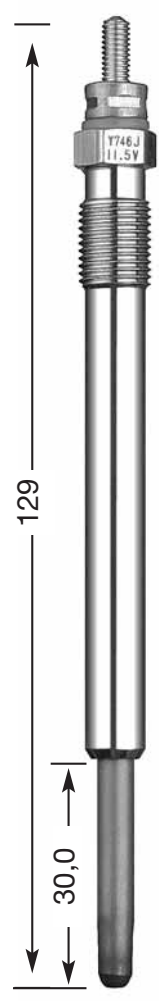

**Y-746 J**  
M 10 x 1.0  
10 Hex  
11,5 V  
**DP 38**

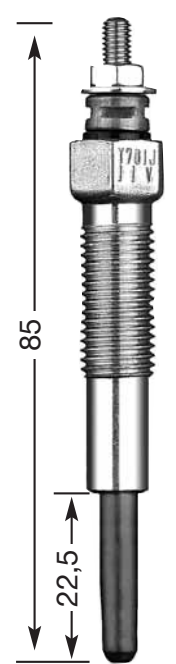

**Y-701 J**  
M 10 x 1.25  
12 Hex  
11 V



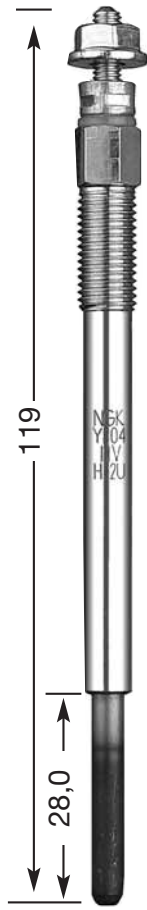

**YE 04**  
M 8 x 1.0  
8 Hex  
11 V  
**DP 40**



**Y-547 AS**  
M 10 x 1.25  
10 Hex  
5 V  
**DP 47**

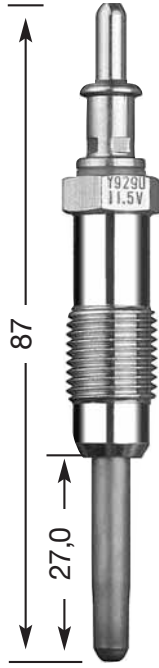

**Y-929 U**  
M 12 x 1.25  
12 Hex  
11,5 V

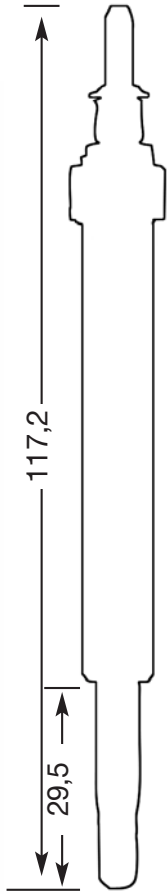

**YE-14**  
M 8 x 1.0  
7,5 V  
**DP 48**



**Y-541 J**  
M 10 x 1.25  
12 Hex  
**DP 42**

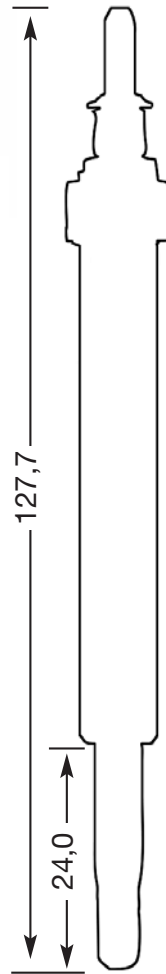

**Y-609 AS**  
M 10 x 1.0  
7,5 V  
**DP 49**

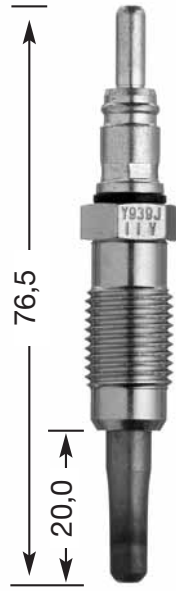

**Y-939 J**  
M 12 x 1.25  
12 Hex  
11 V  
**DP 43**

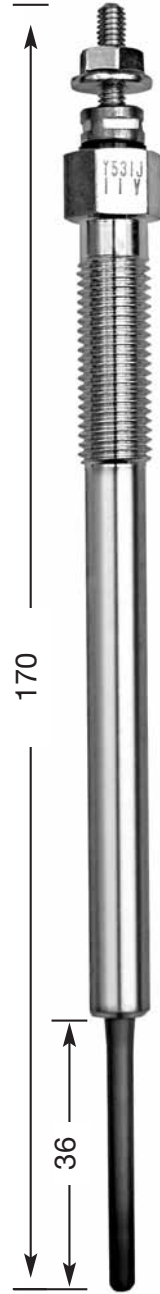

**Y-531 J**  
M 10 x 1.25  
12 Hex  
11 V



**Y-542 J**  
M 10 x 1.25  
10 Hex  
11 V  
**DP 45**



**Y-543 J**  
M 10 x 1.25  
10 Hex  
11 V  
**DP 46**

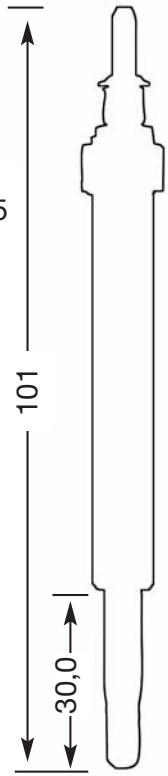

**Y-607 AS**  
M 10 x 1.0  
10 V



l kW

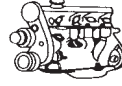

Cyl.

Order-  
No. No.Bic<sup>1)</sup> Order-  
D-Power No.**ACURA**

RSX	2.0		02- 02	K20A3	4	1,1	IZFR6K-11	6994			
RSX	2.0	147	02- 03	K20A2	4	1,1	IFR7G-11KS	7746			
SLX	3.2		96- 97	6VD1	6	1,1	PFR5G-11	2647			
SLX	3.5		98-	6VE1	6	1,1	PFR5G-11	2647			

**ALFA ROMEO**

30 AR 8, 35 AR 8, 40 AR 8 D	2.5	53	10.83-12.89	Sofim 8140.61.200	4	█	Y-908R	4585		D-POWER 1	7906
33 - 1.3 L	1.3		87-01.94	AR305.02-86-87	4	0,7	BP6ES	7811	4	BPR6EIX	6637
33 i.e Sport Wagon	1.3	65	02.94-10.94	AR307.32-301.68	4	0,7	BP6ES	7811	4	BPR6EIX	6637
33 i.e	1.3	65	02.94-10.94	AR307.32	4	0,7	BP6ES	7811	4	BPR6EIX	6637
33 i.e.	1.4	66	01.92-12.93	AR307.53	4	0,7	BP6ES	7811	4	BPR6EIX	6637
33 i.e.; Cat.	1.5	74	12.90- 93	AR307.51	4	0,7	BP6ES	7811	4	BPR6EIX	6637
33 - 1.5 L	1.5	77	84- 93	AR307.34-305.88	4	0,7	BP6ES	7811	4	BPR6EIX	6637
33 i.e. all 1.7 Ltr.cat.	1.7	77	90- 93	AR307.46-47	4	0,7	PFR6B	3500			
33 i.e. - 1.7 L	1.7	85	88- 93	AR305.50	4	0,7	BP6ES	7811	4	BPR6EIX	6637
33 i.e.- 1.7 Ltr.16V	1.7	95	01.88-12.93	AR307.36-37	4	0,7	PFR6B	3500			
33 TD	1.8	55	09.86-03.94		4	█	Y-909R	4602			
33 TD Sport Wagon	1.8	62	01.90-03.94	VM 96 A	4	█	Y-909R	4602			
33 TD	1.8	62	02.90-03.94	VM 82 A	4	█	Y-909R	4602			
33 TD	1.8	62	09.86-03.94	VM HR-392	3	█	Y-909R	4602			
75	1.6	81	05.85-09.89	AR061.00	4	0,7	BP6ES	7811	4	BPR6EIX	6637
75	1.8	89	05.85-09.89	AR062.02	4	0,7	BP6ES	7811	4	BPR6EIX	6637
75 TD	2.0	70	05.85-02.92	VM 80 A	4	█	Y-909R	4602			
75	2.0	94	05.85-10.88	AR062.12	4	0,7	BP6ES	7811	4	BPR6EIX	6637
75 i.Twin Spark	2.0	106	01.87-02.92	AR061.66 Cat.-062.24	4	0,7	BCP6ES	4930	17		
75 TD	2.4	81	10.88-02.92	VM 81 A	4	█	Y-909R	4602			
75 i. V6	2.5	110	09.85-02.92	AR016.46-019.11 Cat.	6	0,7	BP7ES	2412		BPR7EIX	4055
75 i. V6	3.0	133	01.87-02.92	AR061.20-061.24 Cat.	6	0,7	BP6ES	7811	4	BPR6EIX	6637
75 i. V6	3.0	139	02.90-02.92	AR061.503	6	0,7	PGR6A	4984			
145 i.e L	1.4	66	08.94-11.96	AR33.501	4	0,7	BP6ES	7811	4	BPR6EIX	6637
145 i. 16V Twin Spark;L; Junior	1.4	76	04.97-12.01	AR33.503	4	0,9	BKR6EKPA+	2513+			
						+0,7	PMR7A	4259			
145 i.e L	1.6	76	08.94-11.96	AR33.201	4	0,7	BP6ES	7811	4	BPR6EIX	6637
145 i. 16V Twin Spark L	1.6	88	04.96-12.01	AR67.601	4	0,9	BKR6EKPA+	2513+			
						+0,7	PMR7A	4259			
145 i.e 16V	1.7	95	08.94-11.96	AR33.401	4	0,7	PFR6B	3500			
145 i. Twin Spark 16V- L	1.8	103	12.96-03.98	AR67.106	4	0,9	BKR6EKPA+	2513+			
						+0,7	PMR7A	4259			
145 i. 16V Twin Spark	1.8	106	03.98-12.01	AR32.201	4	0,9	BKR6EKPA+	2513+			
						+0,7	PMR7A	4259			
145 TD	1.9	66	04.94-09.96	AR67.501	4	█	Y-922R	4356		D-POWER 1	7906
145 TD	1.9	66	10.96-09.97	AR33.601	4	█	Y-922R	4356		D-POWER 1	7906
145 JTD	1.9	77	05.98-11.99	AR32.302	4	█	Y-747U	4951		D-POWER 26	4694
145 i. 16V T.S. Quadrifoglio	2.0	110	10.95-04.01	AR67.204	4	0,9	BKR6EKPA+	2513+			
						+0,7	PMR7A	4259			
145 16V T.S. (Brazil)	2.0	110	12.96-04.01		4	0,9	BKR6EKPA+	2513+			
						+0,7	PMR7A	4259			
145 i 2.0 16V T.S.	2.0	114	03.98-04.01	AR32.301	4	0,9	BKR6EKPA+	2513+			
						+0,7	PMR7A	4259			
146 i.e.	1.3	66	07.95-11.97	AR33.201	4	0,7	BP6ES	7811	4	BPR6EIX	6637
146 i.e- L	1.4	66	08.94-02.97	AR33.501	4	0,7	BP6ES	7811	4	BPR6EIX	6637

<sup>1)</sup> Bic = Best in class



ℓ kW

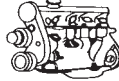

Cyl.

Order-  
No. No.Bic<sup>1)</sup> Order-  
D-Power No.**ALFA ROMEO**

146 i Twin Spark 16V; L	1.4	76	02.97 - 03.98	AR33.503	4	0,9+ 0,7	BKR6EKPA+ PMR7A	2513+ 4259			
146 1.4i 16V Twin Spark; L; Junior	1.4	76	04.98 - 12.01	AR33.503	4	0,9+ 0,7	BKR6EKPA+ PMR7A	2513+ 4259			
146 T.S.	1.4	76	11.96 - 12.01	AR33.503	4	0,9+ 0,7	BKR6EKPA+ PMR7A	2513+ 4259			
146 i.e L	1.6	76	07.94 - 12.97	AR33.201	4	0,7	BP6ES	7811	4	BPR6EIX	6637
146 i 16V Twin Spark L	1.6	88	04.96 - 12.01	AR67.601	4	0,9+ 0,7	BKR6EKPA+ PMR7A	2513+ 4259			
146	1.7	78	08.98 - 04.99	AR32.201	4	0,9+ 0,7	BKR6EKPA+ PMR7A	2513+ 4259			
146 i.e 16V	1.7	95	08.94 - 02.97	AR33.401	4	0,7	PFR6B	3500			
146 i 16V Twin Spark L	1.8	103	02.97 - 12.01	AR67.106	4	0,9+ 0,7	BKR6EKPA+ PMR7A	2513+ 4259			
146 i. 16V Twin Spark	1.8	106	12.96 - 04.01	AR32.201	4	0,9+ 0,7	BKR6EKPA+ PMR7A	2513+ 4259			
146 TD	1.9	66	02.95 - 09.96	AR67.501	4	█	Y-922R	4356		D-POWER 1	7906
146 TD	1.9	66	10.96 - 09.97	AR33.601	4	█	Y-922R	4356		D-POWER 1	7906
146 JTD	1.9	77	05.98 - 11.99	AR32.302	4	█	Y-747U	4951		D-POWER 26	4694
146 i. Twin Spark 16V- ti	2.0	110	02.96 - 04.01	AR67.204	4	0,9+ 0,7	BKR6EKPA+ PMR7A	2513+ 4259			
146 i 2.0 16V T.S.	2.0	114	03.98 - 12.01	AR32.301	4	0,9+ 0,7	BKR6EKPA+ PMR7A	2513+ 4259			
147 1.6 T.S. 16 V	1.6	77	10.00 -	AR37.203	4	0,8+ 0,7	BKUR6ETB+ CR7EKC	6992+ 7004			
147 1.6 T.S. 16V	1.6	88	10.00 -	AR32.104	4	0,9+ 0,7	BKR6EKPA+ PMR7A	2513+ 4259			
147 JTD	1.9	74	11.00 -	182B9000	4	█	Y-534J	5540		D-POWER 36	3413
147 JTD	1.9	85	11.00 -	937A2000	4	█	Y-534J	5540		D-POWER 36	3413
147 2.0 T.S. 16V	2.0	110	10.00 -	AR 32310	4	0,9+ 0,7	BKR6EKPA+ PMR7A	2513+ 4259			
147 GTA	3.2	184	11.02 - 05.06	932A.000	6	0,7	PFR6B	3500			
155 i.16 V T.S.	1.6	88	07.96 - 01.98	AR67.601	4	0,9+ 0,7	BKR6EKPA+ PMR7A	2513+ 4259			
155 i T.S.	1.7	86	02.92 - 04.93	AR67.103	4	0,7	BCP6ES	4930	17	BCPR6EIX	5689
155 i.T.S.	1.7	95	05.93 - 07.96	AR67.105	4	0,7	BCP6ES	4930	17	BCPR6EIX	5689
155 i.Twin Spark	1.8	93	02.92 - 07.96	AR67.102	4	0,7	BCP6ES	4930	17	BCPR6EIX	5689
155 i.T.S.	1.8	93	04.94 - 07.96	AR67.101-67.102	4	0,7	BCP6ES	4930	17	BCPR6EIX	5689
155 i.16 V T.S.	1.8	103	05.96 - 01.98	AR67.106	4	0,9+ 0,7	BKR6EKPA+ PMR7A	2513+ 4259			
155 TD	1.9	68	04.93 - 04.96	AR67.501	4	█	Y-902R	2237		D-POWER 1	7906
155 TD	2.0	66	08.93 - 04.96	AR67.502	4	█	Y-922R	4356		D-POWER 1	7906
155 i.T.S.L	2.0	104	06.94 -		4	0,7	BCP6ES	4930	17	BCPR6EIX	5689
155 i.T.S.L	2.0	104	02.92 - 02.95	AR67.201-67.202	4	0,7	BCP6ES	4930	17	BCPR6EIX	5689
155 i.Twin Spark	2.0	106	02.92 - 02.95	AR67.202	4	0,7	BCP6ES	4930	17	BCPR6EIX	5689
155 i.16V T.S.	2.0	110	06.94 - 01.98	AR67.204	4	0,9+ 0,7	BKR6EKPA+ PMR7A	2513+ 4259			
155 i - Turbo- Turbo 4x4	2.0	137	08.92 - 04.98	AR67.203	4	0,8	BP6ET	1263			
155 TD	2.5	92	05.95 - 10.97	VM 425 CLIEA	4	█	Y-741U	5065		D-POWER 20	6943
155 TD	2.5	92	04.93 - 04.95	VM 425 CLIEA	4	█	Y-922R	4356		D-POWER 1	7906
155 i. V6	2.5	120	05.95 - 02.97	AR67.301	6	0,7	BP6ES	7811	4	BPR6EIX	6637
155 i.	2.5	120	02.92 -	AR67.301	6	0,8	BPR7ES	2023	19	BPR7EIX	4055

<sup>1)</sup> Bic = Best in class



l kW

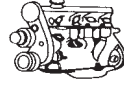

Cyl.

Order-  
No. No.Bic<sup>1)</sup> Order-  
D-Power No.**ALFA ROMEO**

155 i. V6	2.5	120	02.92 - 04.95	AR67.301	6	0,8	BPR7ES	2023	19	BPR7EIX	4055
156 16V T.S.	1.6	88	12.97 - 05.06	AR32.101	4	0,9+	BKR6EKPA+	2513+			
						0,7	PMR7A	4259			
156 16V T.S.	1.8	106	12.97 - 05.06	AR32.201	4	0,9+	BKR6EKPA+	2513+			
						0,7	PMR7A	4259			
156 JTD	1.9	81	01.98 - 09.00	AR32.302	4	█	Y-747U	4951		D-POWER 26	4694
156 JTD	1.9	85	10.97 - 09.00	AR32.302	4	█	Y-747U	4951		D-POWER 26	4694
156 JTD	1.9	85	10.00 - 05.06	AR32.302	4	█	Y-534J	5540		D-POWER 36	3413
156 16V T.S	2.0	114	12.97 - 12.02	AR32.301	4	0,9+	BKR6EKPA+	2513+			
						0,7	PMR7A	4259			
156 16V T.S. Selespeed	2.0	114	05.99 - 12.02	AR32.301	4	0,9+	BKR6EKPA+	2513+			
						0,7	PMR7A	4259			
156 JTS	2.0	121	11.01 - 05.06	937A.1000	4	0,9	BKR6EKPA	2513			
156 JTD	2.4	100	10.97 - 09.00	AR32.501	5	█	Y-747U	4951		D-POWER 26	4694
156 JTD 10V	2.4	110	11.99 - 01.04	841C000	5	█	Y-534J	5540		D-POWER 36	3413
156 24V	2.5	140	10.97 - 05.06	AR32.401	6	0,7	PFR6B	3500			
156 GTA	3.2	184	11.02 - 05.06	932A.000	6	0,7	PFR6B	3500			
159 1.9 JTDM 8V	1.9	88	12.05 -	939A1000	4	█	Y-534J	5540		D-POWER 36	3413
159 1.9 JTS 16V	1.9	118	07.05 -	939A6000	4		FR5CP				
159 1.9 JTS 16V SW	1.9	118	07.05 -	939A6000	4		FR5CP				
159 2.2 JTS 16V SW	2.2	136	07.05 -	939A5000	4		FR5CP				
159 2.2 JTS 16V	2.2	136	07.05 -	939A5000	4		FR5CP				
164 i.	2.0		03.91 -		4	0,7	BP7ES	2412		BPR7EIX	4055
164 i.T.S.	2.0	102	06.87 - 09.92	AR064.16Cat-064.20	4	0,7	BGP6ES	4930	17	BCPR6EIX	5689
164 i.T.S Super / Super L	2.0	106	07.94 - 10.98	AR67.201-67202	4	0,7	BGP6ES	4930	17	BCPR6EIX	5689
164 i.e. Turbo	2.0	126	01.88 - 09.92	AR064.76	4	0,8	BPR7ES	2023	19	BPR7EIX	4055
164 i. V6 turbo Super	2.0	148	03.91 - 10.98	AR64.102	6	0,7	BP7ES	2412		BPR7EIX	4055
164 TD	2.5	85	06.87 - 08.92	VM 84 A	4	█	Y-909R	4602			
164 TD Super	2.5	92	09.92 - 04.95	VM 425-SLIRA	4	█	Y-922R	4356		D-POWER 1	7906
164 TD	2.5	92	05.95 - 10.98	VM 425 SLIRA	4	█	Y-741U	5065		D-POWER 20	6943
164 12V	3.0		06.87 - 09.93	06410, 06412	6	0,8	B7ES	1111			
164 i. V6 Super	3.0	132	01.96 -		6	0,7	PGR6A	4984			
164 i. V6 12V	3.0	138	01.90 - 10.98	AR64.305	6	0,7	BP6ES	7811	4	BPR6EIX	6637
164 i. V6 12V	3.0	155	92 - 10.98	AR66.301	6	0,7	PFR6B	3500			
164 i. V6 24V CF2	3.0	155	01.87 - 92	AR64.301	6	0,7	PGR6A	4984	6		
164 i. V6 24V Super	3.0	155	07.94 - 10.98	AR64.304-64.308	6	0,7	PFR6B	3500			
164 i. V6 QV	3.0	169	- 10.98	AR16.102	6	0,7	PGR6A	4984			
164 i. Q.4	3.0	171	01.90 - 10.98	AR64.304	6	0,7	PFR6B	3500			
166 2.0 T.S. 16V	2.0	114	11.98 - 06.06	AR34.103	4	0,9+	BKR6EKPA+	2513+			
						0,7	PMR7A	4259			
166 2.0 TS	2.0	125	11.03 - 06.06	AR36301	4	0,9+	BKR6EKPA+	2513+			
						0,7	PMR7A	4259			
166 2.0 V6 Turbo Super;Prog.Distint.	2.0	151	11.98 - 06.06	AR34.102	6	0,8	BP6E	5637	4	BPR6EIX	6637
166 24V V6 (Brazil)	2.0	151	10.98 - 06.06		6	0,7	PFR6B	3500			
166 JTD	2.4	103	10.98 - 11.99	AR34.202	5	█	Y-747U	4951		D-POWER 26	4694
166 JTD 10V	2.4	110	12.99 - 03	841C000	5	█	Y-534J	5540		D-POWER 36	3413
166 2.5 I V6 24V	2.5	140	11.98 - 06.06	AR34.201	6	0,7	PFR6B	3500			
166 3.0 I V6 24V	3.0	162	11.98 - 06.06	AR34.301	6	0,7	PFR6B	3500			
166 3.2 V6 24V	3.2	176	11.03 - 06.06	936A6000	6	0,7	PFR6B	3500			
Alfa 90 i. Super	2.5	110	10.84 - 12.90	AR016.46-019.11 cat	6	0,7	B7ES	1111			
Brera 2.2 JTS	2.2	136	09.05 -	939A5000	4		FR5CP				

<sup>1)</sup> Bic = Best in class



ℓ kW

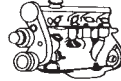

Cyl.

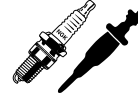
Order-  
No. No.Bic<sup>1)</sup> Order-  
D-Power No.**ALFA ROMEO**

GT 1.8 16V TS	1.8	103	12.03 -	AR32205	4	0,9+ 0,7	BKR6EKPA+ PMR7A	2513+ 4259			
GT 2.0 JTS	2.0	121	12.03 -	937A1000	4	0,9	BKR6EKPA	2513			
GT	3.2	176	12.03 - 12.04	936A.6000	6	0,7	PFR6B	3500			
GTV i 16V Twin Spark	1.8	106	06.98 - 06.02	AR32.201	4	0,9+ 0,7	BKR6EKPA+ PMR7A	2513+ 4259			
GTV 2.0 L Twin Spark -16V	2.0	110	06.98 -	AR32.301	4	0,9+ 0,7	BKR6EKPA+ PMR7A	2513+ 4259			
GTV T.S. 16V	2.0	110	04.95 - 05.98	AR16.201	4	0,9+ 0,7	BKR6EKPA+ PMR7A	2513+ 4259			
GTV 2.0 JTS 16V	2.0	121	06.03 -	937A.1000	4	0,9	BKR6EKPA	2513			
GTV V6 Turbo	2.0	147	04.95 - 05.98	AR16.202	6	0,7	BP7ES	2412		BPR7EIX	4055
GTV 2.0 L V6 turbo L	2.0	148	06.98 - 12.99	AR16.202	6	0,9	BPR6E	6464	2		
GTV V6 12V	2.0	151	09.97 - 12.00		6	0,8	BPR7ES	2023	19	BPR7EIX	4055
GTV V6 24V- L	3.0	160	11.96 - 12.00	AR16.102	6	0,7	PFR6B	3500			
GTV V6 24V	3.0	162	02.97 - 05.98	AR67.601	6	0,7	PFR6B	3500			
GTV V6 24V	3.2	176	06.03 -	936A.6000	6	0,7	PFR6B	3500			
Spider	1.6	76	12.79 - 12.94	AR005.26-015.63	4	0,7	BP6ES	7811	4	BPR6EIX	6637
Spider 16V T.S.	1.8	103	06.98 - 03.01	AR32.201	4	0,9+ 0,7	BKR6EKPA+ PMR7A	2513+ 4259			
Spider 16V T.S.	1.8	106	05.98 - 03.01	AR32.201	4	0,9+ 0,7	BKR6EKPA+ PMR7A	2513+ 4259			
Spider i.	2.0	86	01.90 - 12.94	AR015.44-88-90 Cat.	4	0,7	BP6ES	7811	4	BPR6EIX	6637
Spider 16V T.S.	2.0	110	04.95 - 05.98	AR16.201	4	0,9+ 0,7	BKR6EKPA+ PMR7A	2513+ 4259			
Spider 16V T.S.	2.0	114	06.98 -	AR32.301	4	0,9+ 0,7	BKR6EKPA+ PMR7A	2513+ 4259			
Spider 2.0 JTS 16V	2.0	121	06.03 -	937A.1000	4	0,9	BKR6EKPA	2513			
Spider i V6 turbo	2.0	147	06.98 - 12.99	AR16.202	6	0,9	BPR6E	6464	2		
Spider i V6 12V	3.0	140	04.95 - 05.98	AR16.101-16.199	6	0,8	BPR6ES	7822	2	BPR6EIX	6637
Spider 3.0 V6 24V	3.0	165	06.98 - 04	AR16.102	6	0,7	PFR6B	3500			
Spider 3.2 V6 24V	3.2	176	06.03 -	936A6000	6	0,7	PFR6B	3500			
Spider	2.2	136	01.06 -	939A5000	4		FR5CP				
Sprint	1.3	64	07.79 - 12.89	AR301.68	4	0,7	BP6ES	7811	4	BPR6EIX	6637
Sprint Veloce	1.3	64	01.90 -	AR301.68	4	0,7	BP6ES	7811	4	BPR6EIX	6637
Sprint Q.V.	1.5	70	01.83 - 12.89	AR301.28-46-98	4	0,7	BP6ES	7811	4	BPR6EIX	6637
Sprint Q.V.	1.7	87	10.87 - 12.89	AR305.50	4	0,7	BP6ES	7811	4	BPR6EIX	6637
SZ V6 / RZ V6	3.0	152	03.90 - 05.96	AR64.304	6	0,7	PGR6A	4984			

**ALPINA**

B 3 E36	3.2	195		S52B32	6	0,8	BKR6EK	2288	20	BKR6EQUIP	3199
B 3 3.2 E36 Cabrio	3.2	195	04.96 - 03.99	S52B32	6	0,8	BKR6EK	2288	20	BKR6EQUIP	3199
B 3 3.3 E46	3.3	206	03.99 -	S52B33	6		BKR6EQUIP	3199	30		
B 3 S E46	3.3	224	01.03 -	S52B33	6		BKR6EQUIP	3199	30		
B 5 E60	4.4	368	03.05 -	S62B44 H1/2	8	0,6	PFR7B	4853			
B 6 E64 Cabrio	4.4	368	10.05 -	S62B44 H1/2	8	0,6	PFR7B	4853			
B 7 E65	4.4	368	03.05 -	S62B44 H1	8	0,6	PFR7B	4853			
B 8 E36	4.6	245	01.95 - 11.98	M62B46	8	0,8	BKR6EK	2288	20	BKR6EQUIP	3199
B 10 3.2 E39	3.2	191	08.97 - 12.98	S52B32	6	0,8	BKR6EK	2288	20	BKR6EQUIP	3199
B 10 3.3 E39	3.3	206	02.99 -	S52B33	6		BKR6EQUIP	3199	30		
B 10 3.5 E34	3.5	187	04.88 - 12.92		6	0,8	BPR6ES	7822	2	BPR6EIX	6637
B 10 3.5 E34 Biturbo	3.5	265	08.89 - 03.94		6	0,8	BPR6ES	7822	2	BPR6EIX	6637

<sup>1)</sup> Bic = Best in class



ℓ kW

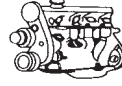

Cyl.

Order-  
No. No.Bic<sup>1)</sup> Order-  
D-Power No.**ALPINA**

B 10 4.0	E34	4.0	232	04.93-08.95		8		BKR6EQU	3199	30		
B 10 4.6	E34	4.6	250	03.94-04.96		8		BKR6EQU	3199	30		
B 10 V8	E39	4.6	250	12.96-09.98	M62B46	8	0,8	BKR6EK	2288	20	BKR6EQU	3199
B 10 V8	E39	4.6	255	10.98-	M62B46	8		BKR6EQU	3199	30		
B 10 V8S	E39	4.8	276	01.02-12.03	M62B48	8		BKR6EQU	3199	30		
B 12	E38 5.7 E-Kat	5.7	285	12.95-09.98	M73B57	12	0,8	BKR6EK	2288	20	BKR6EQU	3199
B 12	E38 6.0 E-Kat	6.0	316	06.99-	M73B60	12		BKR6EQU	3199	30		
D 3	E90	2.0	147	02.07-	L1	4	☑	Y-547AS	6670		D-POWER 47	5968
Roadster S	E85	3.4	221	05.04-		6		BKR6EQU	3199	30		
Roadster V8	E52	4.8	280	06.02-10.03	S62 B48	8		BKR6EQU	3199	30		

**AM GENERAL**

Hummer H 3		3.4	162	05-		5	1,3	PTR5A-13	2467	25		
Hummer		5.7		94- 96	D EFI V8	8	1,3	UR5	2139		UR5IX	7177
Hummer H 2		6.0		03- 04	N EFI V8	8	1,5	PZTR5A-15	7862			
Hummer		8.1		03-	G EFI V8	8	1,5	PZTR5A-15	7862			

**ARO**

10						4	0,6	BP6HS	4511	18	BPR6HIX	4085
10.1, 10.2, 10.3, 10.4 D		1.9	47		Renault F8Q248	4	☑	Y-908R	4585		D-POWER 1	7906
240, 241, 242, 243, 244, 246 D		2.5	55		Peugeot XD 3P	6	☑	Y-902R	2237		D-POWER 1	7906
240, 241, 242, 243, 244, 246 D		2.5	70		Peugeot XD 3TP	6	☑	Y-902R	2237		D-POWER 1	7906
Spartana		1.2	40	97-	C3GD7	4	0,9	BP5ESZ	4691		BPR5EIX	6597
Turbo 10		1.9	68		F8Q Turbo	4	☑	Y-932R	4956		D-POWER 25	7947

**ASIA MOTORS**

Rocsta		1.8	57	02.94-12.97	F8	4	0,9	BPR5ES	7422	6	BPR5EIX	6597
Rocsta		2.2		03.94-12.97	R2	4	☑	Y-107R	1229			

**ASTON MARTIN**

DB7		3.2	250	09.94-06.99	DOHC	6	0,8	BCPR7ES	3330		BCPR7EIX	5690
DB7		5.9		07.99-11.00	DOHC	12	1,3	PTR6D-13	5598			
DB7		5.9		11.00-	DOHC	12	1,3	PTR5D-13	6644			
Turbo 24V Coupé, Cabriolet		3.2	246	95-		6	0,7	BCPR7ES	3330		BCPR7EIX	5690
48V V12		6.0	420	04.00-		12	1,0	PTR5D-10	3784	31		
DBS / VOLANTE		4.0				6	0,7	BP6ES	7811	4	BPR6EIX	6637
Lagonda		5.3		01.86-06.90		8	0,9	BPR6EY	6427		BPR6EIX	6637
V8 / Vantage		5.3		01.87-12.89	V5805743X 9,25	8	0,9	BPR8ES	3923			
V8 / Volante		5.3		01.87-12.89	V5805743x 9,25	8	0,9	BPR8ES	3923			
Vanquish		5.9		06.01-	AM 702	12	1,3	PTR6D-13	5598			
Vantage		5.3		03.86-12.89	9.3:1 Comp	8	0,9	BPR7EY	1144			
Vantage		5.3	410	08.93-	10.2:1Comp(Zagato)	8	0,8	BCR8ES	5430			
Virage / Volante		5.3		02.90-01.98	V8 32V	8	0,8	BCPR6E	1269	12	BCPR6EIX	5689

**AUDI**

A 2 TDI		1.2	45	03.01-08.05	ANY	3	☑	Y-741U	5065		D-POWER 20	6943
A 2		1.4	55	05.02-08.05	BBY	4	1,0	BKUR6ET-10	2397	24	PFR6Q	6458
A 2 TDI		1.4	55	05.03-	BAY	4	☑	Y-732U	2408		D-POWER 4	6001
A 2		1.4	55	06.00-04.02	AUA	4	1,0	BKUR6ET-10	2397	24	PFR6Q	6458
A 2		1.4	55	06.00-08.03	AMF	3	☑	Y-741U	5065		D-POWER 20	6943
A 2		1.4	55	09.03-08.05	BHC	3	☑	Y-741U	5065		D-POWER 20	6943
A 2 TDI		1.4	66	11.03-08.05	ATL	3	☑	Y-607AS	9776		D-POWER 50	

<sup>1)</sup> Bic = Best in class



ℓ kW

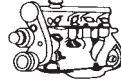

Cyl.

Order-  
No. No.Bic<sup>1)</sup> Order-  
D-Power No.**AUDI**

A 2 FSI	1.6	81	05.02 - 08.05	BAD	4		ZFR6S-Q	6449			
A 3	1.4	92	09.07 -	CAXC	4	0,9	PZFR6R				
A 3	1.6	74	05.00 - 04.02	AVU	4	1,0	BKUR6ET-10	2397	24	PFR6Q	6458
A 3	1.6	74	06.99 - 08.00	APF	4	1,0	BKUR6ET-10	2397	24	PFR6Q	6458
A 3	1.6	74	08.97 - 06.03	AKL	4	1,0	BKUR6ET-10	2397	24	PFR6Q	6458
A 3	1.6	74	09.96 - 06.01	AEH	4	1,0	BKUR6ET-10	2397	24	PFR6Q	6458
A 3	1.6	75	06.05 -	BSF	4	1,0	BKUR6ET-10	2397	24	PFR6Q	6458
A 3	1.6	75	06.05 -	BSE	4	1,0	BKUR6ET-10	2397	24	PFR6Q	6458
A 3	1.6	75	05.03 - 05.05	BGU	4	1,0	BKUR6ET-10	2397	24	PFR6Q	6458
A 3	1.6	75	05.02 - 06.03	BFQ	4	1,0	BKUR6ET-10	2397	24	PFR6Q	6458
A 3 FSI	1.6	85	01.05 - 05.07	BLF	4		ZFR6S-Q	6449			
A 3 FSI	1.6	85	06.04 - 12.04	BLP	4		ZFR6S-Q	6449			
A 3 FSI	1.6	85	08.03 - 05.04	BAG	4		ZFR6S-Q	6449			
A 3	1.8	92	11.99 - 06.03	APG	4	1,0	BKUR6ET-10	2397	24	PFR6Q	6458
A 3	1.8	92	09.96 - 08.00	AGN	4	1,0	BKUR6ET-10	2397	24	PFR6Q	6458
A 3	1.8	110	07.99 - 04.00	ARZ	4	0,8	PFR6Q	6458			
A 3	1.8	110	08.98 - 04.01	AQA	4	0,8	PFR6Q	6458			
A 3	1.8	110	05.00 - 06.03	AUM	4	0,8	PFR6Q	6458			
A 3	1.8	110	09.00 - 06.03	ARX	4	0,8	PFR6Q	6458			
A 3	1.8	110	12.96 - 06.03	AGU	4	0,8	PFR6Q	6458			
A 3 TFSI	1.8	118	06.07 - 05.08	BZB	4	0,8	PFR6S-8E				
A 3	1.8	118	01.07 - 05.07	BYT	4	0,8	PFR6S-8E				
A 3	1.8	132	09.00 - 06.03	ARY	4	0,8	PFR6Q	6458			
A 3	1.8	132	05.00 - 06.03	AUQ	4	0,8	PFR6Q	6458			
A 3	1.8	132	07.99 - 05.00	APP	4	0,8	PFR6Q	6458			
A 3	1.8	132	11.98 - 08.00	AJQ	4	0,8	PFR6Q	6458			
A 3 S 3	1.8	154	09.99 - 04.01	AUL	4	0,8	PFR6Q	6458			
A 3 S 3	1.8	154	11.98 - 08.00	APY	4	0,8	PFR6Q	6458			
A 3 S 3	1.8	154	09.00 - 04.02	AMK	4	0,8	PFR6Q	6458			
A 3 S 3	1.8	165	08.01 - 06.03	BAM	4	0,8	PFR6Q	6458			
A 3	1.9	66	08.97 - 06.01	ALH	4	█	Y-732U	2408		D-POWER 4	6001
A 3	1.9	66	09.96 - 08.00	AGR	4	█	Y-732U	2408		D-POWER 4	6001
A 3 TDI Fgst --> 8L-2-037-877	1.9	74	11.01 - 06.03	AXR	4	█	Y-732U	2408		D-POWER 4	6001
A 3 TDI Fgst 8L-2-037-878 -->	1.9	74	11.01 - 06.03	AXR	4	█	Y-741U	5065		D-POWER 20	6943
A 3 TDI Fgst --> 8L-2-037-877	1.9	74	01.01 - 06.03	ATD	4	█	Y-732U	2408		D-POWER 4	6001
A 3 TDI Fgst 8L-2-037-878 -->	1.9	74	01.01 - 06.03	ATD	4	█	Y-741U	5065		D-POWER 20	6943
A 3 TDI	1.9	77	10.05 - 05.07	BLS	4	█	CZ101				
A 3 TDI	1.9	77	06.03 - 05.06	BKC	4	█	Y-607AS	9776		D-POWER 50	
A 3 TDI	1.9	77	06.06 -	BXE	4	█	Y-607AS	9776		D-POWER 50	
A 3 TDI	1.9	81	09.99 - 06.01	ASV	4	█	Y-732U	2408		D-POWER 4	6001
A 3 TDI	1.9	81	01.97 - 04.02	AHF	4	█	Y-732U	2408		D-POWER 4	6001
A 3 TDI Fgst 8L-2-037-878 -->	1.9	96	05.00 - 06.03	ASZ	4	█	Y-741U	5065		D-POWER 20	6943
A 3 TDI Fgst --> 8L-2-037-877	1.9	96	05.00 - 06.03	ASZ	4	█	Y-732U	2408		D-POWER 4	6001
A 3	2.0	100	05.03 - 05.07	AZV	4	█	YE14	7768		D-POWER 48	7768
A 3 TDI	2.0	103	06.05 - 05.07	BMM	4	█	CZ101				
A 3 TDI	2.0	103	05.03 - 05.07	BKD	4	█	YE14	7768		D-POWER 48	7768
A 3 FSI	2.0	110	06.04 - 11.05	BLY	4	0,9	BKR6E	6962	28	BKR6EIX	6418
A 3 FSI	2.0	110	06.04 - 01.05	BLX	4	1,1	PZFR5N-11T	7742			
A 3 FSI	2.0	110	11.05 -	BVZ	4	0,9	BKR6E	6962	28	BKR6EIX	6418
A 3 FSI	2.0	110	01.04 - 01.05	BMB	4	0,9	BKR6E	6962	28	BKR6EIX	6418
A 3 FSI	2.0	110	01.05 - 11.05	BLR	4	1,1	PZFR5N-11T	7742			
A 3 FSI	2.0	110	05.03 - 05.04	AXW	4	1,1	PZFR5N-11T	7742			

<sup>1)</sup> Bic = Best in class

Fgst = Chassis No.



ℓ kW

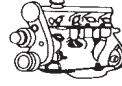

Cyl.

Order-  
No. No.Bic<sup>1)</sup> Order-  
D-Power No.**AUDI**

A 3 FSI	2.0	110	11.05-01.07	BVY	4	1,1	PZFR5N-11T	7742				
A 3 TDI	2.0	120	06.06-05.07	BUY	4	█	CZ301					
A 3 TDI	2.0	125	03.06-05.07	BMN	4	█	CZ301					
A 3 TFSI	2.0	147	09.04-10.05	AXX	4	0,8	PFR6Q	6458				
A 3 FSI	2.0	147	10.07-	CAWB	4	0,8	PFR6S-8E					
A 3 TFSI	2.0	147	09.05-	BWA	4	0,8	PFR6Q	6458				
A 3 S 3	2.0	188	02.07-	BZC	4	0,8	PFR6S-8E					
A 3 S 3	2.0	195	11.06-05.07	BHZ	4	0,8	PFR6S-8E					
A 3	3.2	184	09.04-10.05	BMJ	6	0,9	IZKR7B	7563				
A 3	3.2	184	11.05-	BUB	6	0,9	IZKR7B	7563				
A 3	3.2	184	07.03-08.04	BDB	6	0,9	IZKR7B	7563				
A 4	1.6	74	08.98-06.00	ANA	4	1,0	BKUR6ET-10	2397	24	PFR6Q	6458	
A 4	1.6	74	10.96-07.99	AHL	4	1,0	BKUR6ET-10	2397	24	PFR6Q	6458	
A 4	1.6	74	11.94-10.96	ADP	4	1,0	BKUR6ET-10	2397	24	PFR6Q	6458	
A 4	1.6	74	08.98-09.01	ARM	4	1,0	BKUR6ET-10	2397	24	PFR6Q	6458	
A 4	1.6	75	06.00-	ALZ	4	1,0	BKUR6ET-10	2397	24	PFR6Q	6458	
A 4	1.8	85	07.95-12.98	AFY	4	1,0	BKUR6ET-10	2397	24	PFR6Q	6458	
A 4	1.8	92	02.99-09.01	APT	4	1,0	BKUR6ET-10	2397	24	PFR6Q	6458	
A 4	1.8	92	07.98-09.01	ARG	4	1,0	BKUR6ET-10	2397	24	PFR6Q	6458	
A 4	1.8	92	11.94-04.99	ADR	4	1,0	BKUR6ET-10	2397	24	PFR6Q	6458	
A 4	1.8	92	06.00-09.01	AVV	4	1,0	BKUR6ET-10	2397	24	PFR6Q	6458	
A 4	1.8	110	12.00-06.02	AVJ	4	0,8	PFR6Q	6458				
A 4 (B6) (USA)	1.8	110	08.99-05.00	ATW	4	0,8	PFR6Q	6458				
A 4	1.8	110	05.99-06.00	ANB	4	0,8	PFR6Q	6458				
A 4	1.8	110	01.96-12.98	AEB	4	0,8	PFR6Q	6458				
A 4	1.8	110	07.98-07.99	ARK	4	0,8	PFR6Q	6458				
A 4	1.8	110	06.00-09.01	AWT	4	0,8	PFR6Q	6458				
A 4	1.8	110	08.98-09.01	APU	4	0,8	PFR6Q	6458				
A 4	1.8	120	07.02-	BFB	4	0,8	PFR6Q	6458				
A 4	1.8	132	08.97-09.01	AJL	4	0,8	PFR6Q	6458				
A 4	1.8	140	11.02-12.04	BEX	4	0,8	PFR6Q	6458				
A 4	1.9	55	03.96-06.00	AFF	4	█	Y-732U	2408		D-POWER 4	6001	
A 4 TDI	1.9	66	04.97-09.01	AHH	4	█	Y-732U	2408		D-POWER 4	6001	
A 4	1.9	66	11.94-07.96	IZ	4	█	Y-732U	2408		D-POWER 4	6001	
A 4 TDI	1.9	66	08.96-06.00	AHU	4	█	Y-732U	2408		D-POWER 4	6001	
A 4 TDI Fgst 8E-2-148-698 -->	1.9	74	04.01-05.04	AVB	4	█	Y-741U	5065		D-POWER 20	6943	
A 4 TDI Fgst --> 8E-2-148-697	1.9	74	04.01-05.04	AVB	4	█	Y-732U	2408		D-POWER 4	6001	
A 4	1.9	81	02.96-07.99	AFN	4	█	Y-732U	2408		D-POWER 4	6001	
A 4 TDI	1.9	81	08.99-06.00	AVG	4	█	Y-732U	2408		D-POWER 4	6001	
A 4	1.9	85	11.05-	BRB	4	█	CZ101					
A 4 TDI	1.9	85	01.00-09.01	ATJ	4	█	Y-732U	2408		D-POWER 4	6001	
A 4	1.9	85	08.98-09.01	AJM	4	█	Y-732U	2408		D-POWER 4	6001	
A 4 TDI Fgst 8E-5-070251 -->	1.9	85	06.04-12.05	BKE	4	█	Y-607AS	9776		D-POWER 50		
A 4 TDI Fgst --> 8E-2-148-697	1.9	96	11.00-12.04	AVF	4	█	Y-732U	2408		D-POWER 4	6001	
A 4 TDI Fgst 8E-2-148-698 -->	1.9	96	11.00-12.04	AVF	4	█	Y-741U	5065		D-POWER 20	6943	
A 4 TDI Fgst --> 8E-2-148-697	1.9	96	12.00-06.03	AWX	4	█	Y-732U	2408		D-POWER 4	6001	
A 4 TDI Fgst 8E-2-148-698 -->	1.9	96	12.00-06.03	AWX	4	█	Y-741U	5065		D-POWER 20	6943	
A 4 TDI	2.0	89	01.06-09.06	BVG	4	█	CZ301					
A 4 TDI	2.0	93	11.05-11.06	BVF	4	█	CZ301					
A 4	2.0	96	12.00-	ALT	4	1,0	BKUR5ET-10	7553				
A 4 TDI	2.0	100	11.04-10.05	BNA	4	█	YE14	7768		D-POWER 48	7768	
A 4 TDI	2.0	100	11.05-	BRF	4	█	CZ301					

<sup>1)</sup> Bic = Best in class

Fgst = Chassis No.





ℓ kW

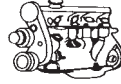

Cyl.

Order-  
No. No.Bic<sup>1)</sup> Order-  
D-Power No.**AUDI**

A 4 TDI	2.0	103	11.04 - 11.05	BLB	4	■	YE14	7768			D-POWER 48	7768
A 4 TDI	2.0	103	11.04 -	BPW	4	■	CZ101					
A 4 TDI	2.0	103	10.05 -	BRE	4	■	CZ301					
A 4 FSI	2.0	110	07.02 - 12.04	AWA	4	1,1	PZFR5N-11T	7742				
A 4 TDI	2.0	120	06.06 -	BVA	4	■	CZ301					
A 4 TDI	2.0	125	06.06 -	BRD	4	■	CZ301					
A 4 TFSI	2.0	147	11.04 - 08.05	BGB	4	0,8	PFR6Q	6458				
A 4	2.0	147	09.05 -	BWE	4	0,8	PFR6Q	6458				
A 4	2.0	162	06.05 -	BUL	4	0,8	PFR6Q	6458				
A 4 S 4	2.2	169	08.91 - 07.94	AAN	5	0,6	PFR7B	4853				
A 4	2.4	110	07.95 - 07.97	AFM	6	1,0	BKUR6ET-10	2397	24	PFR6Q		6458
A 4	2.4	120	08.98 - 06.00	APZ	6	0,8	BKR6EKUB	3584				
A 4	2.4	120	06.00 - 09.01	AMM	6	0,8	BKR6EKUB	3584				
A 4	2.4	120	08.97 - 07.98	AJG	6	0,8	BKR6EKUB	3584				
A 4	2.4	121	08.97 - 07.98	AGA	6	0,8	BKR6EKUB	3584				
A 4	2.4	121	08.98 - 09.01	APS	6	0,8	BKR6EKUB	3584				
A 4	2.4	121	08.98 - 09.01	AML	6	0,8	BKR6EKUB	3584				
A 4	2.4	121	08.97 - 07.98	ALF	6	0,8	BKR6EKUB	3584				
A 4	2.4	121	08.98 - 06.00	ARJ	6	0,8	BKR6EKUB	3584				
A 4	2.4	125	09.01 - 12.05	BDV	6	0,8	BKR6EKUB	3584				
A 4	2.5	110	07.98 - 09.01	AKN	6	■	Y-501U	3786			D-POWER 31	4187
A 4 TDI	2.5	110	11.97 - 06.00	AFB	6	■	Y-501U	3786			D-POWER 31	4187
A 4 TDI	2.5	114	04.01 - 06.02	AYM	6	■	Y-501U	3786			D-POWER 31	4187
A 4 TDI	2.5	120	06.03 - 12.05	BCZ	6	■	Y-501U	3786			D-POWER 31	4187
A 4 TDI	2.5	120	06.03 - 05.06	BDG	6	■	Y-501U	3786			D-POWER 31	4187
A 4	2.5	120	07.02 - 05.03	BFC	6	■	Y-501U	3786			D-POWER 31	4187
A 4 TDI	2.5	132	06.03 - 12.04	BDH	6	■	Y-501U	3786			D-POWER 31	4187
A 4 TDI	2.5	132	12.00 - 05.03	AKE	6	■	Y-501U	3786			D-POWER 31	4187
A 4	2.5	132	06.03 - 12.04	BAU	6	■	Y-501U	3786			D-POWER 31	4187
A 4 (China / GUS)	2.6	102	06.94 - 10.97	ACZ	6	1,0	BKUR6ET-10	2397	24	PFR6Q		6458
A 4	2.6	110	11.94 - 07.97	ABC	6	1,0	BKUR6ET-10	2397	24	PFR6Q		6458
A 4 S 4 biturbo	2.7	169	07.98 - 08.00	AJK	6	0,8	PFR6Q	6458				
A 4 S 4 biturbo	2.7	184	07.98 - 12.98	APB	6	0,8	PFR6Q	6458				
A 4 S 4	2.7	195	11.00 - 09.01	AZB	6	0,8	PFR6Q	6458				
A 4 S 4 biturbo	2.7	195	10.97 - 09.01	AGB	6	0,8	PFR6Q	6458				
A 4 RS 4 biturbo	2.7	280	06.00 - 10.00	ASJ	6		PFR7Q	7963				
A 4 (USA)	2.8	128	08.94 - 07.98	AFC	6	1,0	BKUR6ET-10	2397	24	PFR6Q		6458
A 4	2.8	128	11.94 - 07.97	AAH	6	1,0	BKUR6ET-10	2397	24	PFR6Q		6458
A 4 (China, SA )	2.8	140	03.99 - 09.01	ATX	6	0,8	BKR6EKUB	3584				
A 4	2.8	142	08.98 - 06.00	APR	6	0,8	BKR6EKUB	3584				
A 4 30V	2.8	142	03.96 - 07.98	ACK	6	0,8	BKR6EKUB	3584				
A 4	2.8	142	07.98 - 09.01	AMX	6	0,8	BKR6EKUB	3584				
A 4	2.8	142	08.98 - 06.00	AQD	6	0,8	BKR6EKUB	3584				
A 4	2.8	142	05.97 - 07.98	ALG	6	0,8	BKR6EKUB	3584				
A 4 RS4	2.8	280	11.00 - 09.01	AZR	6		PFR7Q	7963				
A 4	3.0	160	04.01 - 05.06	BBJ	6	0,8	BKR6EKUB	3584				
A 4	3.0	162	12.00 - 12.05	ASN	6	0,8	BKR6EKUB	3584				
A 4	3.0	162	09.01 - 06.02	AVK	6	1,1	PFR6U-11G	5874				
A 4 FSI	3.2	188	01.05 -	AUK	6	0,9	PFR7W-T					
A 4 S 4	4.2	206	10.92 - 07.94	ABH	8	0,8	BUR6EFSZ	6837				
A 4 S 4	4.2	253	03.03 -	BBK	8		BKR6EQUA	6872				
A 4 S 4	4.2	253	03.06 -	BHF	8		BKR6EQUA	6872				

<sup>1)</sup> Bic = Best in class



ℓ kW

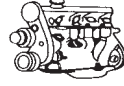

Cyl.

Order-  
No. No.Bic<sup>1)</sup> Order-  
D-Power No.**AUDI**

A 4 RS 4 V8 FSI Fgst 8E-8-900 601 -->	4.2	309	11.05 -	BNS	8		PFR7W-TG				
A 4 RS 4 V8 FSI Fgst --> 8E-8-900 600	4.2	309	11.05 -	BNS	8	0,9	PFR7W-T				
A 5 TDI	2.7	140	06.07 -	CAMA	6	█	Y-609AS	5849		D-POWER 49	5849
A 5 TDI	3.0	177	06.07 -	CAPA	6	█	Y-609AS	5849		D-POWER 49	5849
A 5 S5	4.2	258	06.07 -	CAUA	8	0,9	PFR6W-T				
A 6 (GUS)	1.8	85	05.97 -05.00	AFY	4	1,0	BKUR6ET-10	2397	24	PFR6Q	6458
A 6 China	1.8	92		ANQ	4	1,0	BKUR6ET-10	2397	24	PFR6Q	6458
A 6	1.8	92	12.97 -07.99	AJP	4	1,0	BKUR6ET-10	2397	24	PFR6Q	6458
A 6	1.8	92	10.95 -10.97	ADR	4	1,0	BKUR6ET-10	2397	24	PFR6Q	6458
A 6	1.8	92	01.99 -04.01	ARH	4	1,0	BKUR6ET-10	2397	24	PFR6Q	6458
A 6	1.8	92	01.99 -04.01	AQE	4	1,0	BKUR6ET-10	2397	24	PFR6Q	6458
A 6	1.8	110	01.99 -05.99	ARK	4	0,8	PFR6Q	6458			
A 6	1.8	110	05.00 -01.05	AWT	4	0,8	PFR6Q	6458			
A 6	1.8	110	11.98 -05.01	APU	4	0,8	PFR6Q	6458			
A 6	1.8	110	04.97 -01.99	AEB	4	0,8	PFR6Q	6458			
A 6	1.8	110	01.99 -05.01	ANB	4	0,8	PFR6Q	6458			
A 6	1.8	132	11.97 -10.00	AJL	4	0,8	PFR6Q	6458			
A 6 TDI	1.9	66	07.96 -10.97	AHU	4	█	Y-732U	2408		D-POWER 4	6001
A 6	1.9	66	07.94 -06.96	1Z	4	█	Y-732U	2408		D-POWER 4	6001
A 6 TDI	1.9	81	08.99 -10.00	AVG	4	█	Y-732U	2408		D-POWER 4	6001
A 6	1.9	81	04.97 -04.01	AFN	4	█	Y-732U	2408		D-POWER 4	6001
A 6	1.9	85	11.00 -04.01	AJM	4	█	Y-741U	5065		D-POWER 20	6943
A 6 TDI	1.9	96	06.01 -01.05	AWX	4	█	Y-741U	5065		D-POWER 20	6943
A 6 TDI	1.9	96	06.01 -01.05	AVF	4	█	Y-732U	2408		D-POWER 4	6001
A 6	2.0	74	06.94 -06.96	AAE	4	0,8	BUR6ET	3172	1	PGR6D	6248
A 6	2.0	79	06.96 -10.97	ADW	4	0,8	BUR6ET	3172	1	PGR6D	6248
A 6	2.0	85	06.94 -06.96	ABK	4	0,8	BUR6ET	3172	1	PGR6D	6248
A 6 TDI	2.0	89	09.05 -06.06	BVG	4	█	CZ301				
A 6	2.0	96	06.01 -01.05	ALT	4	1,0	BKUR5ET-10	7553			
A 6	2.0	100	07.04 -11.05	BNA	4	█	YE14	7768		D-POWER 48	7768
A 6 TDI	2.0	100	09.05 -	BRF	4	█	CZ301				
A 6 TDI	2.0	103	07.04 -11.05	BLB	4	█	YE14	7768		D-POWER 48	7768
A 6 TDI	2.0	103	09.05 -	BRE	4	█	CZ301				
A 6	2.0	103	06.94 -10.97	ACE	4	0,8	BKUR7ET	7873		PFR7Q	7963
A 6	2.2	169	07.96 -07.97	AAN	5	0,6	PFR7B	4853			
A 6 S 6	2.2	169	06.94 -07.97	AAN	5	0,6	PFR7B	4853			
A 6	2.3	98	06.94 -06.96	AAR	5	0,8	BPR5EKU	5685		PGR6D	6248
A 6	2.4	99	08.97 -01.99	ALW	6	0,8	BKR6EKUB	3584			
A 6	2.4	100	02.99 -05.00	ARN	6	0,8	BKR6EKUB	3584			
A 6	2.4	100	06.00 -01.05	ASM	6	0,8	BKR6EKUB	3584			
A 6	2.4	110	07.95 -10.97	AFM	6	1,0	BKUR6ET-10	2397	24	PFR6Q	6458
A 6	2.4	120	04.97 -01.99	AJG	6	0,8	BKR6EKUB	3584			
A 6	2.4	120	06.00 -04.01	AMM	6	0,8	BKR6EKUB	3584			
A 6	2.4	120	11.98 -05.01	APZ	6	0,8	BKR6EKUB	3584			
A 6	2.4	121	06.97 -01.99	ALF	6	0,8	BKR6EKUB	3584			
A 6	2.4	121	06.00 -05.01	AML	6	0,8	BKR6EKUB	3584			
A 6	2.4	121	04.98 -05.01	APC	6	0,8	BKR6EKUB	3584			
A 6	2.4	121	04.97 -01.99	AGA	6	0,8	BKR6EKUB	3584			
A 6	2.4	121	11.98 -05.01	ARJ	6	0,8	BKR6EKUB	3584			
A 6	2.4	121	11.98 -05.01	APS	6	0,8	BKR6EKUB	3584			
A 6	2.4	125	06.01 -01.05	BDV	6	0,8	BKR6EKUB	3584			
A 6	2.4	130	04.04 -	BDW	6	1,1	PFR6X-11				

<sup>1)</sup> Bic = Best in class

Fgst = Chassis No.



ℓ kW

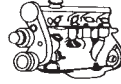

Cyl.

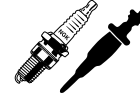
Order-  
No. No.Bic<sup>1)</sup> Order-  
D-Power No.**AUDI**

A 6	2.5	85	06.94 - 10.97	AAT	5	■	Y-732U	2408		D-POWER 4	6001
A 6 TDI	2.5	103	10.94 - 10.97	AEL	5	■	Y-732U	2408		D-POWER 4	6001
A 6	2.5	110	10.98 - 05.01	AKN	6	■	Y-501U	3786		D-POWER 31	4187
A 6 TDI	2.5	110	04.97 - 05.00	AFB	6	■	Y-501U	3786		D-POWER 31	4187
A 6 TDI	2.5	114	06.01 - 06.02	AYM	6	■	Y-501U	3786		D-POWER 31	4187
A 6	2.5	120	07.02 - 08.03	BFC	6	■	Y-501U	3786		D-POWER 31	4187
A 6 TDI	2.5	120	02.03 - 08.05	BCZ	6	■	Y-501U	3786		D-POWER 31	4187
A 6	2.5	120	02.03 - 01.05	BDG	6	■	Y-501U	3786		D-POWER 31	4187
A 6 TDI	2.5	132	11.99 - 08.03	AKE	6	■	Y-501U	3786		D-POWER 31	4187
A 6	2.5	132	02.03 - 08.05	BAU	6	■	Y-501U	3786		D-POWER 31	4187
A 6 TDI	2.5	132	02.03 - 01.05	BDH	6	■	Y-501U	3786		D-POWER 31	4187
A 6 (China / GUS)	2.6	102	06.94 - 10.97	ACZ	6	1,0	BKUR6ET-10	2397	24	PFR6Q	6458
A 6	2.6	110	06.94 - 10.97	ABC	6	1,0	BKUR6ET-10	2397	24	PFR6Q	6458
A 6 biturbo	2.7	169	02.99 - 08.00	AJK	6	0,8	PFR6Q	6458			
A 6	2.7	169	09.00 - 05.01	AZA	6	0,8	PFR6Q	6458			
A 6	2.7	184	07.02 - 08.05	BES	6	0,8	PFR6Q	6458			
A 6 biturbo	2.7	184	05.00 - 06.02	ARE	6	0,8	PFR6Q	6458			
A 6 biturbo (USA)	2.7	187	05.99 - 06.02	APB	6	0,8	PFR6Q	6458			
A 6 (GUS)	2.8	120	07.96 - 10.97	AEJ	6	0,8	PFR5B	5341			
A 6	2.8	128	06.94 - 10.97	AAH	6	1,0	BKUR6ET-10	2397	24	PFR6Q	6458
A 6	2.8	128	08.94 - 06.95	AFC	6	1,0	BKUR6ET-10	2397	24	PFR6Q	6458
A 6	2.8	132	02.98 - 05.01	AGE	6	0,8	BKR6EKUB	3584			
A 6	2.8	140	07.99 - 05.01	ATX	6	0,8	BKR6EKUB	3584			
A 6	2.8	142	11.98 - 05.01	AQD	6	0,8	BKR6EKUB	3584			
A 6	2.8	142	06.97 - 01.99	ALG	6	0,8	BKR6EKUB	3584			
A 6	2.8	142	06.00 - 05.01	AMX	6	0,8	BKR6EKUB	3584			
A 6	2.8	142	10.95 - 07.98	ACK	6	0,8	BKR6EKUB	3584			
A 6 (USA)	2.8	142	08.97 - 07.99	AHA	6	0,8	BKR6EKUB	3584			
A 6	2.8	142	11.98 - 05.01	APR	6	0,8	BKR6EKUB	3584			
A 6 FSI	2.8	154	11.06 -	BDX	6	1,1	PFR6X-11				
A 6	3.0	160	06.01 - 05.06	BBJ	6	0,8	BKR6EKUB	3584			
A 6	3.0	162	06.01 - 01.05	ASN	6	0,8	BKR6EKUB	3584			
A 6 FSI	3.2	188	04.04 -	AUK	6	0,9	PFR7W-T				
A 6	3.7	191	10.98 - 02.01	AQG	8		BKR6EQUP	3199	30		
A 6 S 6 4.2	4.2	213	09.94 - 10.97	AEC	8	0,8	BUR6EFSZ	6837			
A 6	4.2	220	06.00 - 01.05	ASG	8		BKR6EQUP	3199	30		
A 6	4.2	220	04.03 - 08.05	BAS	8		BKR6EQUA	6872			
A 6 (USA)	4.2	220	04.99 - 05.00	ART	8		BKR6EQUP	3199	30		
A 6 4.2	4.2	221	04.99 - 05.01	ARS	8		BKR6EQUP	3199	30		
A 6 S 6 Plus	4.2	235	06.96 - 10.97	AHK	8	0,8	BUR6EFSZ	6837			
A 6	4.2	246	04.04 - 05.06	BAT	8		BKR6EQUA	6872			
A 6 S 6	4.2	250	09.00 - 01.05	ANK	8		BKR6EQUP	3199	30		
A 6 S 6	4.2	250	09.99 - 05.01	AQJ	8		BKR6EQUP	3199	30		
A 6	4.2	257	05.06 -	BVJ	8	0,9	PFR6W-T				
A 6 RS 6	4.2	331	07.02 - 09.04	BCY	8		PFR7Q	7963			
A 6 RS 6	4.2	353	04.04 - 09.04	BRV	8		PFR7Q	7963			
A 6 S 6	5.2	320	06.06 -	BXA	10	0,9	PFR6W-T				
A 8 TDI	2.5	110	06.97 - 04.00	AFB	6	■	Y-501U	3786		D-POWER 31	4187
A 8	2.5	110	11.97 - 09.02	AKN	6	■	Y-501U	3786		D-POWER 31	4187
A 8 TDI	2.5	132	11.99 - 09.02	AKE	6	■	Y-501U	3786		D-POWER 31	4187
A 8	2.8	120	07.95 - 03.96	AEJ	6	0,8	PFR5B	5341			
A 8	2.8	128	06.94 - 03.96	AAH	6	1,0	BKUR6ET-10	2397	24	PFR6Q	6458

<sup>1)</sup> Bic = Best in class



ℓ kW

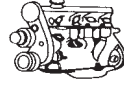

Cyl.

Order-  
No. No.Bic<sup>1)</sup> Order-  
D-Power No.**AUDI**

A 8	2.8	142	01.99-02.01	AQD	6	0,8	BKR6EKUB	3584				
A 8	2.8	142	04.96-09.98	ACK	6	0,8	BKR6EKUB	3584				
A 8	2.8	142	01.99-02.01	APR	6	0,8	BKR6EKUB	3584				
A 8 V6	2.8	142	10.97-12.98	ALG	6	0,8	BKR6EKUB	3584				
A 8	2.8	142	05.00-09.02	AMX	6	0,8	BKR6EKUB	3584				
A 8	3.0	160	07.03-05.06	BBJ	6	0,8	BKR6EKUB	3584				
A 8	3.0	162	07.03-05.05	ASN	6	0,8	BKR6EKUB	3584				
A 8	3.2	191	06.05-	BPK	6	0,9	PFR7W-T					
A 8 TDI	3.3	165	12.99-09.02	AKF	8	█	Y-501U	3786			D-POWER 31	4187
A 8	3.7	169	05.97-12.98	AKJ	8	0,8	BUR6EFSZ	6837				
A 8	3.7	169	07.95-12.98	AEW	8	0,8	BUR6EFSZ	6837				
A 8	3.7	191	05.00-09.02	AKC	8	0,8	BKR6EKUB	3584				
A 8	3.7	191	10.98-02.01	AQG	8		BKR6EQUP	3199	30			
A 8	3.7	206	11.02-05.06	BFL	8		BKR6EQUA	6872				
A 8	4.0	202	05.03-07.05	ASE	8	█	Y-501U	3786			D-POWER 31	4187
A 8	4.2	175	02.99-04.00	ARU	8		BKR6EQUP	3199	30			
A 8 4.2	4.2	180	06.94-07.96	AEM	8	0,8	BUR6EFSZ	6837				
A 8	4.2	210	06.94-12.98	AGH	8	0,8	BUR6EFSZ	6837				
A 8	4.2	220	06.97-12.98	AKG	8	0,8	BUR6EFSZ	6837				
A 8 4.2	4.2	220	06.94-05.99	ABZ	8	0,8	BUR6EFSZ	6837				
A 8	4.2	228	05.00-09.02	AUW	8		BKR6EQUP	3199	30			
A 8 (USA)	4.2	228	05.99-05.00	AKB	8		BKR6EQUP	3199	30			
A 8	4.2	228	10.98-02.01	AQF	8		BKR6EQUP	3199	30			
A 8	4.2	246	11.02-05.06	BFM	8		BKR6EQUA	6872				
A 8 S 8	4.2	250	08.97-12.98	AKH	8	0,8	BUR6EFSZ	6837				
A 8 S 8	4.2	250	09.96-12.98	AHC	8	0,8	BUR6EFSZ	6837				
A 8	4.2	257	06.06-	BVJ	8	0,9	PFR6W-T					
A 8	4.2	257	08.98-	AKD	8		BKR6EQUP	3199	30			
A 8 S 8	4.2	265	09.00-09.02	AVP	8		BKR6EQUP	3199	30			
A 8 S 8	4.2	265	05.99-02.01	AQH	8		BKR6EQUP	3199	30			
A 8 S 8	4.2	265	09.00-02.01	BCS	8		BKR6EQUP	3199	30			
A 8 S 8	4.2	265	02.01-09.02	AYS	8		BKR6EQUP	3199	30			
A 8 S 8	5.2	331	06.06-	BSM	10	0,9	PFR6W-T					
A 8	6.0	309	03.01-09.02	AZC	12	1,1	PZFR6J-11	3586				
A 8 (CH)	6.0	331	02.05-	BTE	12	1,1	PZFR6J-11	3586				
A 8	6.0	331	02.04-	BHT	12	1,1	PZFR6J-11	3586				
80 D,TD	1.6	37	08.81-08.91		4	█	Y-918R	4182			D-POWER 2	6285
80	1.6	40	08.82-07.89	JK	4	█	Y-918R	4182			D-POWER 2	6285
80	1.6	51	08.89-12.91	PP	4	1,0	BUR5ET-10	7264	21		PGR6D	6248
80	1.6	52	01.92-06.94	ABM	4	0,8	BUR5ET	3377	22		PGR6D	6248
80	1.6	55	08.83-12.91	RN	4	1,0	BUR5ET-10	7264	21		PGR6D	6248
80 TD	1.6	59	04.89-12.91	SB	4	█	Y-918R	4182			D-POWER 2	6285
80	1.6	74	06.93-07.95	ADA	4	0,8	BUR6ET	3172	1		PGR6D	6248
80	1.6	75	08.90-05.93	ABB	4	0,8	BUR6ET	3172	1		PGR6D	6248
80	1.8	55	10.86-10.91	RU	4	1,0	BUR5ET-10	7264	21		PGR6D	6248
80	1.8	64	02.86-07.90	SF	4	0,8	BUR6ET	3172	1		PGR6D	6248
80	1.8	66	08.83-07.88	JV	4	0,8	BUR6ET	3172	1		PGR6D	6248
80	1.8	66	08.84-12.91	NE	4	0,8	BUR6ET	3172	1		PGR6D	6248
80	1.8	66	08.83-12.91	JN	4	0,8	BUR6ET	3172	1		PGR6D	6248
80	1.8	66	03.88-12.91	PM	4	0,8	BUR6ET	3172	1		PGR6D	6248
80	1.8	82	01.83-12.91	DZ	4	0,8	BUR6ET	3172	1		PGR6D	6248
80	1.9	47	08.89-12.91	1Y	4	█	Y-918R	4182			D-POWER 2	6285

<sup>1)</sup> Bic = Best in class



ℓ kW

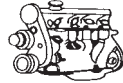

Cyl.

Order-  
No. No.Bic<sup>1)</sup> Order-  
D-Power No.**AUDI**

80 TD	1.9	55	09.91 - 07.95	AAZ	4	■	Y-918R	4182		D-POWER 2	6285
80 TDi	1.9	66	09.91 - 07.95	1Z	4	■	Y-732U	2408		D-POWER 4	6001
80	1.9	83	09.86 - 07.88	SD	4	0,8	BUR6ET	3172	1	PGR6D	6248
80	2.0	66	09.91 - 06.95	ABT	4	0,8	BUR6ET	3172	1	PGR6D	6248
80	2.0	74	12.90 - 10.94	AAE	4	0,8	BUR6ET	3172	1	PGR6D	6248
80	2.0	79	11.93 - 07.95	ADW	4	0,8	BUR6ET	3172	1	PGR6D	6248
80	2.0	83	08.88 - 10.90	3A	4	0,8	BUR6ET	3172	1	PGR6D	6248
80	2.0	85	09.91 - 07.95	ABK	4	0,8	BUR6ET	3172	1	PGR6D	6248
80	2.0	85	08.90 - 12.91	AAD	4	0,8	BUR6ET	3172	1	PGR6D	6248
80	2.0	101	03.90 - 07.92	6A	4	0,8	BKUR7ET	7873		PFR7Q	7963
80	2.0	103	08.92 - 07.95	ACE	4	0,8	BKUR7ET	7873		PFR7Q	7963
80 S2	2.2	169	02.93 - 07.95	ABY	5	0,6	PFR7B	4853			
80 Avant RS2	2.2	232	03.94 - 07.95	ADU	5	0,6	PFR7B	4853			
80	2.3	98	09.91 - 11.94	NG	5	0,8	BPR5EKU	5685		PGR6D	6248
80 (China / GUS)	2.6	102	05.93 - 07.95	ACZ	6	1,0	BKUR6ET-10	2397	24	PFR6Q	6458
80	2.6	110	07.92 - 07.95	ABC	6	1,0	BKUR6ET-10	2397	24	PFR6Q	6458
80	2.8	128	09.91 - 07.95	AAH	6	1,0	BKUR6ET-10	2397	24	PFR6Q	6458
90 TD	1.6	59	07.87 - 12.91	SB	4	■	Y-918R	4182		D-POWER 2	6285
90	1.8	82	08.89 - 12.91	DZ	4	0,8	BUR6ET	3172	1	PGR6D	6248
90	2.0	85	04.87 - 12.91	PS	5	0,8	BUR6ET	3172	1	PGR6D	6248
90	2.0	118	08.88 - 10.91	NM	4	0,8	BCP7ET	2078		BCPR7EIX	5690
90	2.2	100	06.84 - 12.91	KV	5	0,8	BUR6ET	3172	1	PGR6D	6248
90	2.3	98	04.87 - 12.91	NG	5	0,8	BPR5EKU	5685		PGR6D	6248
90	2.3	125	06.88 - 12.91	7A	5	0,8	BKUR7ET	7873		PFR7Q	7963
100	1.6	75	03.92 - 07.93	ABB	4	0,8	BUR6ET	3172	1	PGR6D	6248
100	1.8	65	02.86 - 07.90	SH	4	0,8	BUR6ET	3172	1	PGR6D	6248
100	1.8	66	03.83 - 12.90	JW	4	0,8	BUR6ET	3172	1	PGR6D	6248
100	1.8	66	10.84 - 12.90	NP	4	0,8	BUR6ET	3172	1	PGR6D	6248
100	1.8	66	10.84 - 12.90	4B	4	0,8	BUR6ET	3172	1	PGR6D	6248
100	1.8	66	05.83 - 07.89	DS	4	0,8	BUR6ET	3172	1	PGR6D	6248
100	1.8	66	04.85 - 12.90	PH	4	0,8	BUR6ET	3172	1	PGR6D	6248
100 (China)	1.8	110		ANZ	4	1,0	BKUR6ET-10	2397	24	PFR6Q	6458
100 D,TD	2.0	51	08.82 - 11.90		4	■	Y-918R	4182		D-POWER 2	6285
100	2.0	74	12.90 - 07.94	AAE	4	0,8	BUR6ET	3172	1	PGR6D	6248
100	2.0	79	12.93 - 07.94	ADW	4	0,8	BUR6ET	3172	1	PGR6D	6248
100	2.0	85	01.93 - 07.94	ABK	4	0,8	BUR6ET	3172	1	PGR6D	6248
100	2.0	85	12.90 - 12.92	AAD	4	0,8	BUR6ET	3172	1	PGR6D	6248
100	2.0	85	01.88 - 12.92	RT	4	0,8	BUR6ET	3172	1	PGR6D	6248
100	2.0	103	01.92 - 07.94	ACE	4	0,8	BKUR7ET	7873		PFR7Q	7963
100	2.2	88	08.85 - 07.88	PX	5	0,8	BUR6ET	3172	1	PGR6D	6248
100	2.2	101	08.84 - 12.90	KU	5	0,8	BUR6ET	3172	1	PGR6D	6248
100	2.2	121	03.86 - 12.90	MC	5	0,8	BUR6ET	3172	1	PGR6D	6248
100	2.3	98	12.90 - 07.94	AAR	5	0,8	BPR5EKU	5685		PGR6D	6248
100	2.3	100	08.86 - 12.90	NF	5	0,8	BPR5EKU	5685		PGR6D	6248
100	2.4	60	05.91 - 07.94	AAS	5	■	Y-918R	4182		D-POWER 2	6285
100 D	2.4	60	08.89 - 12.90	3D	5	■	Y-918R	4182		D-POWER 2	6285
100 TDI	2.5	85	08.91 - 07.94	AAT	5	■	Y-732U	2408		D-POWER 4	6001
100 TDI	2.5	85	04.91 - 07.92	ABP	5	■	Y-732U	2408		D-POWER 4	6001
100 TDI	2.5	88	01.90 - 12.90	1T	5	■	Y-732U	2408		D-POWER 4	6001
100 (China / GUS)	2.6	102	01.93 - 07.94	ACZ	6	1,0	BKUR6ET-10	2397	24	PFR6Q	6458
100	2.6	110	03.92 - 07.94	ABC	5	1,0	BKUR6ET-10	2397	24	PFR6Q	6458
100	2.8	128	12.90 - 07.94	AAH	6	1,0	BKUR6ET-10	2397	24	PFR6Q	6458

<sup>1)</sup> Bic = Best in class



l kW

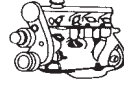

Cyl.

Order-  
No. No.Bic<sup>1)</sup> Order-  
D-Power No.**AUDI**

200	2.2	121	01.85 - 11.90	MC	5	0,8	BUR6ET	3172	1	PGR6D	6248
200	2.2	147	02.88 - 11.90	1B	5	0,8	BUR6ET	3172	1	PGR6D	6248
200	2.2	162	03.89 - 11.90	3B	5	0,6	PFR7B	4853			
200	2.3	140	02.88 - 11.90	2B	5	0,8	BUR6ET	3172	1	PGR6D	6248
Coupe	1.8	66	01.85 - 07.88	JN	4	0,8	BUR6ET	3172	1	PGR6D	6248
Coupe	1.8	66	08.82 - 07.88	DS	4	0,8	BUR6ET	3172	1	PGR6D	6248
Coupe	1.8	81	08.86 - 07.88	PV	4	0,8	BUR6ET	3172	1	PGR6D	6248
Coupe	1.8	82	08.86 - 07.91	DZ	4	0,8	BUR6ET	3172	1	PGR6D	6248
Coupe	2.0	81	08.83 - 07.88	JL	4	0,8	BUR6ET	3172	1	PGR6D	6248
Coupe	2.0	83	05.89 - 07.90	3A	4	0,8	BUR6ET	3172	1	PGR6D	6248
Coupe	2.0	85	08.90 - 07.91	AAD	4	0,8	BUR6ET	3172	1	PGR6D	6248
Coupe	2.0	85	08.91 - 12.95	ABK	4	0,8	BUR6ET	3172	1	PGR6D	6248
Coupe	2.0	101	03.90 - 07.92	6A	4	0,8	BKUR7ET	7873		PFR7Q	7963
Coupe	2.0	103	08.92 - 12.95	ACE	4	0,8	BKUR7ET	7873		PFR7Q	7963
Coupe	2.0	118	11.88 - 07.91	NM	4	0,8	BCP7ET	2078		BCPR7EIX	5690
Coupe	2.2	85	01.85 - 07.88	KX	5	0,8	BUR6ET	3172	1	PGR6D	6248
Coupe	2.2	100	08.84 - 07.91	KV	5	0,8	BUR6ET	3172	1	PGR6D	6248
Coupe	2.2	100	08.84 - 07.88	HY	5	0,8	BUR6ET	3172	1	PGR6D	6248
Coupe S2	2.2	162	09.90 - 09.92	3B	5	0,6	PFR7B	4853			
Coupe S2	2.2	169	10.92 - 12.95	ABY	5	0,6	PFR7B	4853			
Coupe	2.3	98	08.86 - 07.94	NG	5	0,8	BPR5EKU	5685		PGR6D	6248
Coupe	2.3	125	11.88 - 07.91	7A	5	0,8	BKUR7ET	7873		PFR7Q	7963
Coupe	2.6	110	08.92 - 12.95	ABC	6	1,0	BKUR6ET-10	2397	24	PFR6Q	6458
Coupe	2.8	128	08.91 - 12.95	AAH	6	1,0	BKUR6ET-10	2397	24	PFR6Q	6458
Quattro	2.2	147	08.87 - 07.89	MB	5	0,8	BUR6ET	3172	1	PGR6D	6248
V 8 3.6	3.6	184	10.88 - 11.93	PT	8	0,8	BUR6EFSZ	6837			
V 8 4.2	4.2	206	08.91 - 11.93	ABH	8	0,8	BUR6EFSZ	6837			
Cabrio	1.8	92	04.97 - 08.00	ADR	4	1,0	BKUR6ET-10	2397	24	PFR6Q	6458
Cabrio	1.9	66	07.96 - 08.00	AHU	4	█	Y-732U	2408		D-POWER 4	6001
Cabrio	1.9	66	07.95 - 07.96	IZ	4	█	Y-732U	2408		D-POWER 4	6001
Cabrio	2.0	85	01.93 - 09.98	ABK	4	0,8	BUR6ET	3172	1	PGR6D	6248
Cabrio	2.0	103	05.95 - 07.96	ACE	4	0,8	BKUR7ET	7873		PFR7Q	7963
Cabrio	2.3	98	06.91 - 07.94	NG	5	0,8	BPR5EKU	5685		PGR6D	6248
Cabrio (China / GUS)	2.6	102	05.95 - 12.99	ACZ	6	1,0	BKUR6ET-10	2397	24	PFR6Q	6458
Cabrio	2.6	110	01.94 - 08.00	ABC	6	1,0	BKUR6ET-10	2397	24	PFR6Q	6458
Cabrio	2.8	128	11.92 - 08.00	AAH	6	1,0	BKUR6ET-10	2397	24	PFR6Q	6458
Q 7 TDI Fgst 4L-7-036-115-->	3.0	155	03.06 -	BUN	6	█	Y-609AS	5849		D-POWER 49	5849
Q 7 TDI Fgst 4L-7-036-115-->	3.0	171	03.06 -	BUG	6	█	Y-609AS	5849		D-POWER 49	5849
Q 7 FSI	3.6	206	08.06 -	BHK	6	0,9	ILZKR7A	1961			
Q 7 TDI	4.2	230	03.07 -	BTR	8	█	Y-609AS	5849		D-POWER 49	5849
Q 7 FSI	4.2	257	03.06 -	BAR	8	0,9	PFR6W-T				
R 8	4.2	309	04.07 -	BYH	8	0,9	PFR7W-T				
TT / TTS	1.8	110	01.01 - 06.06	AUM	4	0,8	PFR6Q	6458			
TT / TTS	1.8	120	09.05 - 06.06	BVP	4	0,8	PFR6Q	6458			
TT / TTS	1.8	132	09.99 - 09.00	APP	4	0,8	PFR6Q	6458			
TT / TTS (USA)	1.8	132	09.00 - 06.06	AWP	4	0,8	PFR6Q	6458			
TT / TTS	1.8	132	10.98 - 08.00	AJQ	4	0,8	PFR6Q	6458			
TT / TTS	1.8	132	09.00 - 05.05	ARY	4	0,8	PFR6Q	6458			
TT / TTS	1.8	132	09.00 - 06.06	AUQ	4	0,8	PFR6Q	6458			
TT / TTS	1.8	140	09.05 - 06.06	BVR	4	0,8	PFR6Q	6458			
TT / TTS	1.8	165	09.00 - 05.05	BAM	4	0,8	PFR6Q	6458			
TT / TTS	1.8	165	10.98 - 08.01	APX	4	0,8	PFR6Q	6458			

<sup>1)</sup> Bic = Best in class

Fgst = Chassis No.



ℓ kW

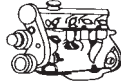

Cyl.

Order-  
No. No.Bic<sup>1)</sup> Order-  
D-Power No.**AUDI**

TT / TTS (USA)	1.8	165	03.00 - 08.02	AMU	4	0,8	PFR6Q	6458			
TT / TTS	1.8	180	03.05 - 05.05	BFV	4	0,8	PFR6Q	6458			
TT / TTS	2.0	147	08.06 -	BWA	4	0,8	PFR6Q	6458			
TT / TTS	3.2	184	07.03 - 06.06	BHE	6	0,9	IZKR7B	7563			
TT / TTS	3.2	184	08.06 -	BUB	6	0,9	IZKR7B	7563			

**AUSTIN**

1100	1.1				4	0,7	BP6ES	7811	4	BPR6EIX	6637
1300	1.3				4	0,7	BP6ES	7811	4	BPR6EIX	6637
1500	1.5				4	0,7	BP6ES	7811	4	BPR6EIX	6637
1700	1.7			O SERIES	4	0,6	BP6EF	4666			
1800	1.8				4	0,7	BP6ES	7811	4	BPR6EIX	6637
2000	2.0			O SERIES	4	0,6	BP6EF	4666			
2200	2.2				6	0,7	BP6ES	7811	4	BPR6EIX	6637
Maestro 1,3HLE	1.3		- 08.88		4	0,7	BP6ES	7811	4	BPR6EIX	6637
Maestro	1.3		03.83 - 07.89	A-PLUS	4	0,8	BPR6ES	7822	2	BPR6EIX	6637
Maestro 1,6HLE	1.6		- 08.88		4	0,7	BP6ES	7811	4	BPR6EIX	6637
Maestro	1.6		05.84 - 07.89	S-Serie	4	0,8	BCPR6ES	2330	12	BCPR6EIX	5689
Maestro (D)	1.6		05.84 - 07.89	S-Serie	4	0,9	BCP7ES	5030		BCPR7EIX	5690
Metro			10.84 - 04.90		4	0,7	BP6ES	7811	4	BPR6EIX	6637
Metro	1.0		01.87 - 01.90		4	0,8	BP5ES	6511	8	BPR5EIX	6597
Metro 310	1.0		09.89 - 04.92		4	0,7	BP6ES	7811	4	BPR6EIX	6637
Metro	1.0		01.90 - 09.90		4	0,9	BPR5ES	7422	6	BPR5EIX	6597
Metro	1.3		10.80 - 04.92		4	0,8	BPR6ES	7822	2	BPR6EIX	6637
Metro 310	1.3		09.89 - 04.92		4	0,8	BPR6ES	7822	2	BPR6EIX	6637
Mini			01.87 - 10.89	not Turbo	4	0,8	BP5ES	6511	8	BPR5EIX	6597
Mini			07.89 - 10.89	ERA Turbo	4	0,8	BPR7ES	2023	19	BPR7EIX	4055
Mini	1.0	31	09.86 - 08.88		4	0,7	BP6ES	7811	4	BPR6EIX	6637
Minor	1.0				4	0,7	BP6ES	7811	4	BPR6EIX	6637

**AUTOBIANCHI**

Y10 Fire	1.0	32	10.87 - 09.92	156A2.100 Cat.	4	0,8	BCPR6ES	2330	12	BCPR6EIX	5689
Y10 Fire/Fire LX/Fire 4WD	1.0	37	09.86 - 12.88	156A3..	4	0,8	BCPR6ES	2330	12	BCPR6EIX	5689
Y10 Touring	1.05	38	03.85 - 02.89	156A0..	4	0,8	BPR6ES	7822	2	BPR6EIX	6637
Y10 Turbo	1.05	63	03.85 - 02.89	156A1..	4	0,6	BR8ES	5422		BR8EIX	5044
Y10 i.e Mia	1.1	37	01.94 - 10.96	156C046	4	0,8	BCPR6ES	2330	12	BCPR6EIX	5689
Y10 i.e Igloo	1.1	37	03.94 - 10.96	156C046	4	0,8	BCPR6ES	2330	12	BCPR6EIX	5689
Y10 i.e Junior	1.1	37	03.94 - 10.96	156C046	4	0,8	BCPR6ES	2330	12	BCPR6EIX	5689
Y10 i.e 4WD Sestrieres	1.1	37	03.94 - 10.96	156C046	4	0,8	BCPR6ES	2330	12	BCPR6EIX	5689
Y10 i.e Selectronic Ville	1.1	37	03.94 - 01.95	156C046	4	0,8	BCPR6ES	2330	12	BCPR6EIX	5689
Y10 i.e.	1.1	40	03.95 -		4	0,8	BCPR6ES	2330	12	BCPR6EIX	5689
Y10 Fire IE alle Modelle	1.1	41	01.89 - 10.96	156C000	4	0,8	BCPR6ES	2330	12	BCPR6EIX	5689
Y10 i.e GT/i.e GT Kat./Elite	1.3	53	11.87 - 09.92	156C5.046	4	0,8	BPR6ES	7822	2	BPR6EIX	6637

**AUVERLAND**

A3 D	1.9	51		PSA engine	4	█	Y-902R	2237		D-POWER 1	7906
A3 TD	1.9	67		PSA engine	4	█	Y-923U	3380		D-POWER 1	7906
A4 D	1.9	51		PSA engine	4	█	Y-902R	2237		D-POWER 1	7906
A4 TD	1.9	67		PSA engine	4	█	Y-923U	3380		D-POWER 1	7906

<sup>1)</sup> Bic = Best in class



l kW

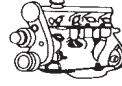

Cyl.

Order-  
No. No.Bic<sup>1)</sup> Order-  
D-Power No.**AVIA**

A21.1 D			10.90 -		4	<input checked="" type="checkbox"/>	Y-208T	1250			
Avia D	3.6	65	- 01.93	D407	4	<input checked="" type="checkbox"/>	Y-208T	1250			

**AZLK (MOSKWITCZ)**

2136 / 2138	1.4				4	0,8	BP5HS	4111			
2140 / 2137 / 2734			74 -	UZAM-331.10.412	4	0,8	BP7ES	2412		BPR7EIX	4055
21412		53		UZAM-331.10.412	4	0,8	BP7ES	2412		BPR7EIX	4055
214101		56		VAZ 2106-70	4	0,7	BP6ES	7811	4	BPR6EIX	6637
Aleko	1.5		- 12.00		4	0,8	BP7ES	2412		BPR7EIX	4055
Aleko	1.6		- 12.00		4	0,7	BP6ES	7811	4	BPR6EIX	6637
Aleko S / SL	1.6		- 12.00		4	0,8	BP5ES	6511	8	BPR5EIX	6597
Aleko	1.8	70	12.86 - 12.00		4	0,8	BPR6ES	7822	2	BPR6EIX	6637
Aleko	2.0	83	01.86 - 12.00	REN-F3R	4	0,9	BPR5ES	7422	6	BPR5EIX	6597
Ish 2126	1.5		09.87 -		4	0,7	BP6ES	7811	4	BPR6EIX	6637

**BARKAS**

B 1000 Serie	0.9	34	01.75 - 12.90		4	0,6	B6HS	4510		BR6HIX	3419
B 1000 Serie	1.3	34	01.75 - 12.90	BM 880	4	0,6	B6HS	4510		BR6HIX	3419

**BEDFORD**

Astra Max D	1.6		02.85 -	16D OHC	4	<input checked="" type="checkbox"/>	Y-902R	2237		D-POWER 1	7906
Astra Van D	1.6		03.82 -	16D OHC	4	<input checked="" type="checkbox"/>	Y-902R	2237		D-POWER 1	7906
Brava	2.3				4	0,8	BPR6ES	7822	2	BPR6EIX	6637
Brava Pickup 4x4	2.2		12.98 -			<input checked="" type="checkbox"/>	Y-306R	6244			
Chevanne	1.3				4	0,7	BP6ES	7811	4	BPR6EIX	6637
HA	1.2				4	0,7	BP6ES	7811	4	BPR6EIX	6637
KB26/41	1.6		01.84 - 01.88		4	0,8	BPR6ES	7822	2	BPR6EIX	6637
Midi	1.8	55	02.85 - 05.90	4ZB1	4	0,8	BPR6ES	7822	2	BPR6EIX	6637
Midi 2.0TD	2.0		03.88 - 05.90		4	<input checked="" type="checkbox"/>	Y-711RS	4444			
Midi 2.0TD	2.0	50	03.88 - 05.90		4	<input checked="" type="checkbox"/>	Y-307R	5837			
Midi	2.0	60	03.88 - 05.90		4	0,8	BPR6ES	7822	2	BPR6EIX	6637
Midi 2.2D	2.2		03.88 - 05.90		4	<input checked="" type="checkbox"/>	Y-711RS	4444			
Midi 2.2D	2.2	44	03.88 - 05.90		4	<input checked="" type="checkbox"/>	Y-307R	5837			
Rascal	1.0	32	02.86 - 05.90		4	0,9	BPR5ES	7422	6	BPR5EIX	6597
TK						0,8	B6S	3510			

**BENTLEY**

Tous types			87 - 89			1,1	BPR5EIX-11	2115		BPR5EIX-11	2115
Arnage	4.4		09.99 - 01	BMW	8		BKR6EQUIP	3199	30		
Arnage	4.4	210	08.98 -	BMW M62B44	8		BKR6EQUIP	3199	30		
Arnage	4.4	210	04.98 - 08.98	BMW M62B44	8	0,8	BKR6EK	2288	20	BKR6EQUIP	3199
Arnage Green Label V8 Biturbo	4.4	260	08.99 - 12.01		8		BKR6EQUIP	3199	30		
Arnage Le Mans	6.8		03.01 -	RR	8	0,9	BKR4EVX	4870			
Arnage Red Label V8 6.8 turbo	6.8		09.99 -	RR	8		BKR5EVX	2546		BKR5EIX	6341
Azure	6.7					0,9	BKR4EVX	4870			
Azure Mulliner	6.8		03.99 -		8		BKR5EVX	2546		BKR5EIX	6341
Azure	6.8		03.95 -		8		BKR5EVX	2546		BKR5EIX	6341
Brooklands	6.8		09.92 - 09.99		8		BKR5EVX	2546		BKR5EIX	6341
Continental GT	6.0		03 -		12	0,8	PFR6Q	6458			
Continental SC / Mulliner	6.8		03.99 - 09.00		8		BKR5EVX	2546		BKR5EIX	6341
Continental R	6.8		12.91 -		8		BKR5EVX	2546		BKR5EIX	6341
Continental R Mulliner	6.8		03.99 -		8		BKR5EVX	2546		BKR5EIX	6341

<sup>1)</sup> Bic = Best in class





ℓ kW

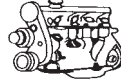

Cyl.

Order-  
No. No.Bic<sup>1)</sup> Order-  
D-Power No.**BENTLEY**

Continental / Mulliner	6.8		02.97 -			8		BKR5EVX	2546		BKR5EIX	6341
Continental R Le Mans	6.8		03.01 -			8		BKR5EVX	2546		BKR5EIX	6341
Continental R	6.8		03.92 -	L4101T	Cat.	8	1,0	BPR4EVX	3436			
Continental	6.8		89 -	L4101	Cat.	8	1,0	BPR4EVX	3436			
Corniche 71-->02	6.8		07.93 -08.95			8	0,9	BKR4EVX	4870			
Corniche 71-->02	6.8		03.87 - 12.88			8	0,7	BPR5EV	4728		BPR5EIX	6597
Corniche 71-->02	6.8		01.89 -06.93			8	0,9	BPR4EVX	3436			
Corniche 71-->02	6.8		09.95 -			8		BKR5EVX	2546		BKR5EIX	6341
Eight	6.8		89 -	L4101	Cat.		1,0	BPR4EVX	3436			
Mulsanne / S / Eight	6.8		12.86 - 12.88			8	0,7	BPR5EV	4728		BPR5EIX	6597
Mulsanne / S / Eight	6.8		01.89 -06.93			8	0,9	BPR4EVX	3436			
Mulsanne / S / Eight	6.8		07.93 -			8	0,9	BKR4EVX	4870			
Mulsanne S	6.8		89 -	L4101	Cat.		1,0	BPR4EVX	3436			
S TYPE	4.6					6	0,6	B6ES	7310			
S TYPE	6.2					8	0,6	BP5E	4669			
Turbo R 85-->96	6.8		01.87 - 12.88			8	0,7	BPR5EV	4728		BPR5EIX	6597
Turbo R 85-->96	6.8		01.89 -09.96			8		BKR5EVX	2546		BKR5EIX	6341
Turbo R	6.8		89 -	L4101T	Cat.	8	1,0	BPR4EVX	3436			

**BERTONE**

Freeclimber 1.6i	1.6	74	02.92 -	M40B16		4	0,8	BKR6EK	2288	20	BKR6EQUIP	3199
Freeclimber 2.0i 4x4	2.0	95	01.91 -	M20B20		6	0,8	ZGR5A	5839	15		
Freeclimber 2.7i 4x4	2.7	95	01.91 -	M20B27		6	0,8	ZGR5A	5839	15		

**BMW**

116i	E87	1.6	85	09.04 -	N45 B16	4		BKR6EQU	6002		BKR6EQUIP	3199
118 D	E87	2.0	90	09.04 -	M47N204D4	4	■	Y-547AS	6670		D-POWER 47	5968
118 i	E87	2.0	95	09.04 -	N46 B20	4	1,1	IZFR6H11	4294			
120 D	E87	2.0	120	09.04 -	M47N204D4	4	■	Y-547AS	6670		D-POWER 47	5968
120 i	E87	2.0	110	09.04 -	N46 B20	4	1,1	IZFR6H11	4294			
120 i	E87	2.0	125	04.07 -	N43 B20	4		ZKBR7AP-HTU				
130 i	E87	3.0	195	09.05 -	N52 B30	6	1,1	ILZFR6D11	1208			
316 g Compact	E36/5	1.6	65	02.96 -07.00	M43 B16	4	0,8	BKR6EK	2288	20	BKR6EQUIP	3199
316 i	E30	1.6	73	09.88 -09.94	M40 B16	4	0,8	BKR6EK	2288	20	BKR6EQUIP	3199
316 i	E30	1.8	75	09.87 -08.88	M10 B18	4	0,8	BP5ES	6511	8	BPR5EIX	6597
316 i	E36	1.6	73	05.91 -08.93	M40 B16	4	0,8	BKR6EK	2288	20	BKR6EQUIP	3199
316 i	E36	1.6	75	08.93 -05.99	M43 B16	4	0,8	BKR6EK	2288	20	BKR6EQUIP	3199
316 i Compact	E36/5	1.6	75	04.94 - 12.98	M43 B16	4	0,8	BKR6EK	2288	20	BKR6EQUIP	3199
316 i Compact	E36/5	1.9	77	01.99 -	M43 B19	4	0,8	BKR6EK	2288	20	BKR6EQUIP	3199
316 i Touring	E46/3	1.8	85	03.04 -	N46 B18	4	1,1	IZFR6H11	4294			
316 i Touring	E46/3	1.8	85	10.01 -	N42 B18	4		BKR6EQUIP	3199	30		
316 i	E46/4	1.6	85	03.04 -	N45 B16	4	1,1	IZFR6H11	4294			
316 i	E46/4	1.8	85	03.04 -	N46 B18	4	1,1	IZFR6H11	4294			
316 i	E46/4	1.8	85	10.01 -	N42 B18	4		BKR6EQUIP	3199	30		
316 i	E46/4	1.9	77	01.99 -	M43 B19	4		BKR6EQUIP	3199	30		
316 ti Compact	E46/5	1.8	85	03.04 -	N46 B18	4	1,1	IZFR6H11	4294			
316 ti Compact	E46/5	1.8	85	05.01 -	N42 B18	4		BKR6EQUIP	3199	30		
318 Ci Coupe	E46/2	1.9	87	09.99 -	M43 B19	4		BKR6EQUIP	3199	30		
318 Ci Coupe	E46/2	2.0	105	03.04 -	N46 B20	4	1,1	IZFR6H11	4294			
318 Ci Coupe	E46/2	2.0	105	09.01 -	N42 B20	4		BKR6EQUIP	3199	30		
318 Ci Cabrio	E46/C	2.0	105	09.01 -	N42 B20	4		BKR6EQUIP	3199	30		
318 d Touring	E46/3	2.0	85	09.02 - 04	M47N D20	4	■	Y-547AS	6670		D-POWER 47	5968

<sup>1)</sup> Bic = Best in class



l kW

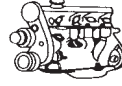

Cyl.

Order-  
No. No.Bic<sup>1)</sup> Order-  
D-Power No.**BMW**

318 d Touring	E46/3	2.0	85	09.01 - 11.03	M47 D20	4	█	Y-507R	4600		D-POWER 32	2691
318 d	E46/4	2.0	85	09.02- 04	M47N D20	4	█	Y-547AS	6670		D-POWER 47	5968
318 d	E46/4	2.0	85	09.01 - 11.03	M47 D20	4	█	Y-507R	4600		D-POWER 32	2691
318 d	E90	2.0	90	09.05 -	M47N204D4	4	█	Y-547AS	6670		D-POWER 47	5968
318 d Touring	E91	2.0	90	09.05 -	M47N204D4	4	█	Y-547AS	6670		D-POWER 47	5968
318 i Touring	E30	1.8	82	04.89 - 09.94	M40 B18	4	0,8	BKR6EK	2288	20	BKR6EQU	3199
318 i	E30	1.8	83	09.87 - 04.91	M40 B18	4	0,8	BKR6EK	2288	20	BKR6EQU	3199
318 i	E36	1.8	83	10.90 - 09.93	M40 B18	4	0,8	BKR6EK	2288	20	BKR6EQU	3199
318 i	E36	1.8	85	08.93 - 09.99	M43 B18	4	0,8	BKR6EK	2288	20	BKR6EQU	3199
318 i Touring	E36/3	1.8	85	09.94 - 09.99	M43 B18	4	0,8	BKR6EK	2288	20	BKR6EQU	3199
318 i Touring	E46/3	1.9	87	09.00 -	M43 B19	4		BKR6EQU	3199	30		
318 i Touring	E46/3	2.0	105	09.01 -	N42 B20	4		BKR6EQU	3199	30		
318 i	E46/4	1.9	87	04.98 -	M43 B19	4		BKR6EQU	3199	30		
318 i	E46/4	2.0	105	03.04 -	N46 B20	4	1,1	IZFR6H11	4294			
318 i	E46/4	2.0	105	09.01 - 02.05	N42 B20	4		BKR6EQU	3199	30		
318 i	E90	2.0	95	09.04 -	N46 B20	4	1,1	IZFR6H11	4294			
318 i Touring	E91	2.0	95	03.06 -	N46 B20	4	1,1	IZFR6H11	4294			
318 iS	E30	1.8	103	09.89 - 10.90	M42 B18	4	0,8	BKR6EK	2288	20	BKR6EQU	3199
318 iS	E36	1.8	103	10.91 - 03.96	M42 B18	4	0,8	BKR6EK	2288	20	BKR6EQU	3199
318 iS Coupe	E36	1.9	103	01.96 - 09.99	M44 B19	4	0,8	BKR6EK	2288	20	BKR6EQU	3199
318 td Compact	E46/5	2.0	85	01.02 -	M47N D20	4	█	Y-547AS	6670		D-POWER 47	5968
318 Tds	E36	1.8	66	11.94 - 02.98	M41 D18	4	█	Y-917U	3219		D-POWER 1	7906
318 ti Compact	E36/5	1.8	103	11.94 - 02.96	M42 B18	4	0,8	BKR6EK	2288	20	BKR6EQU	3199
318 ti Compact	E36/5	1.9	103	01.96 -	M44 B19	4	0,8	BKR6EK	2288	20	BKR6EQU	3199
318 ti Compact	E46/5	2.0	105	03.04 -	N46 B20	4	1,1	IZFR6H11	4294			
318 ti Compact	E46/5	2.0	105	09.01 -	N42 B20	4		BKR6EQU	3199	30		
320 Cd	E46/2	2.0	110	11.03 -	M47N D20	4	█	Y-547AS	6670		D-POWER 47	5968
320 Cd	E46/C	2.0	110	03.05 -	M47N D20	4	█	Y-547AS	6670		D-POWER 47	5968
320 Ci Coupe	E46/2	2.0	110	06.99 -	M52 B20	6		BKR6EQU	3199	30		
320 Ci Coupe	E46/2	2.2	125	08.00 -	M54 B22	6		BKR6EQU	3199	30		
320 Ci Cabrio	E46/C	2.2	125	08.00 -	M54 B22	6		BKR6EQU	3199	30		
320 d Touring	E46/3	2.0	100	09.00 - 08.01	M47 D20	4	█	Y-507R	4600		D-POWER 32	2691
320 d Touring	E46/3	2.0	110	09.01 -	M47N D20	4	█	Y-547AS	6670		D-POWER 47	5968
320 d	E46/4	2.0	100	04.98 - 08.01	M47 D20	4	█	Y-507R	4600		D-POWER 32	2691
320 d	E46/4	2.0	110	09.01 - 04	M47N D20	4	█	Y-547AS	6670		D-POWER 47	5968
320 d	E90	2.0	110	03.05 -	M47N204D4	4	█	Y-547AS	6670		D-POWER 47	5968
320 d Touring	E91	2.0	120	09.05 -	M47N204D4	4	█	Y-547AS	6670		D-POWER 47	5968
320 d Coupe	E92	2.0	130	09.06 -	M47N204D4	4	█	Y-547AS	6670		D-POWER 47	5968
320 i Touring	E30	2.0	90	01.88 - 08.91	M20 B20	6	0,8	ZGR5A	5839	15		
320 i	E30	2.0	90	12.86 - 12.90	M20 B20 Cat.	6	0,8	ZGR5A	5839	15		
320 i	E30	2.0	92	01.88 - 08.88	M20 B20	6	0,8	ZGR5A	5839	15		
320 i	E36	2.0	110	01.90 - 07.95	M50 B20	6	0,8	BKR6EK	2288	20	BKR6EQU	3199
320 i	E36	2.0	110	09.94 - 09.99	M52 B20	6	0,8	BKR6EK	2288	20	BKR6EQU	3199
320 i Touring	E36/3	2.0	110	04.94 - 05.99	M52 B20	6	0,8	BKR6EK	2288	20	BKR6EQU	3199
320 i Touring	E46/3	2.0	110	10.99 - 09.00	M52 B20	6		BKR6EQU	3199	30		
320 i Touring	E46/3	2.2	125	08.00 -	M54 B22	6		BKR6EQU	3199	30		
320 i	E46/4	2.0	110	04.98 -	M52 B20	6		BKR6EQU	3199	30		
320 i	E46/4	2.2	125	08.00 -	M54 B22	6		BKR6EQU	3199	30		
320 i	E90	2.0	110	03.05 -	N46 B20	4	1,1	IZFR6H11	4294			
320 i Touring	E91	2.0	110	10.05 -	N46 B20	4	1,1	IZFR6H11	4294			
320 i Coupe	E92	2.0	110	10.06 -	N46 B20	4	1,1	IZFR6H11	4294			
320 i Coupe	E92	2.0	125	03.07 -	N43 B20	4		ZKBR7AP-HTU				

<sup>1)</sup> Bic = Best in class



ℓ kW

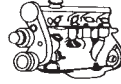

Cyl.

Order-  
No. No.Bic<sup>1)</sup> Order-  
D-Power No.**BMW**

320 i Cabrio	E93	2.0	125	04.07 -	N46 B20	4	1,1	IZFR6H11	4294				
320 td Compact	E46/5	2.0	110	09.01 -	M47N D20	4	█	Y-547AS	6670		D-POWER 47	5968	
323 Ci Coupe	E46/2	2.5	125	04.99 -	M52 B25	6		BKR6EQUP	3199	30			
323 i	E36	2.5	125	06.95 - 04.99	M52 B25	6	0,8	BKR6EK	2288	20	BKR6EQUP	3199	
323 i Touring	E36/3	2.5	125	12.95 - 05.99	M52 B25	6	0,8	BKR6EK	2288	20	BKR6EQUP	3199	
323 i	E46/4	2.5	125	04.98 -	M52 B25	6		BKR6EQUP	3199	30			
323 ti Compact	E36/5	2.5	125	10.97 - 12.98	M52 B25	6	0,8	BKR6EK	2288	20	BKR6EQUP	3199	
323 Ci Cabrio	E46/C	2.5	125	04.00 - 09.00	M52 B25	6		BKR6EQUP	3199	30			
324 d	E30	2.4	63	09.85 - 08.91	M21 D24	6	█	Y-902R	2237		D-POWER 1	7906	
324 Td	E30	2.4	85	09.87 - 12.93	M21 D24	6	█	Y-917U	3219		D-POWER 1	7906	
325 Ci Coupe	E46/2	2.5	141	08.00 -	M54 B25	6		BKR6EQUP	3199	30			
325 Ci Cabrio	E46/C	2.5	141	08.00 -	M54 B25	6		BKR6EQUP	3199	30			
325 d	E90	3.0	145	03.06 -	M57N2 D30	6	█	Y-547AS	6670		D-POWER 47	5968	
325 d Touring	E91	3.0	145	03.06 -	M57N2 D30	6	█	Y-547AS	6670		D-POWER 47	5968	
325 d Coupe	E92	3.0	145	03.06 -	M57N2 D30	6	█	Y-547AS	6670		D-POWER 47	5968	
325 i Touring	E30	2.5	125	07.87 - 91	M20 B25	6	0,8	ZGR5A	5839	15			
325 i	E30	2.5	125	12.86 - 12.90	M20 B25	6	0,8	ZGR5A	5839	15			
325 i	E36	2.5	141	12.89 - 12.94	M50 B25	6	0,8	BKR6EK	2288	20	BKR6EQUP	3199	
325 i Touring	E46/3	2.5	141	09.00 -	M54 B25	6		BKR6EQUP	3199	30			
325 i	E46/4	2.5	141	08.00 -	M54 B25	6		BKR6EQUP	3199	30			
325 i	E90	2.5	160	03.05 -	N52 B25	6	1,1	ILZFR6D11	1208				
325 i Touring	E91	2.5	160	09.05 -	N52 B25	6	1,1	ILZFR6D11	1208				
325 i Coupe	E92	2.5	160	09.06 -	N52 B25	6	1,1	ILZFR6D11	1208				
325 i Cabrio	E93	3.0	160	04.07 -	N52 B30	6	1,1	ILZFR6D11	1208				
325 iX	E30	2.5	125	12.86 - 01.91	M20 B25	6	0,8	ZGR5A	5839	15			
325 iX Touring	E30	2.5	125	06.88 - 91	M20 B25	6	0,8	ZGR5A	5839	15			
325 Td	E36	2.5	85	01.91 - 02.98	M51 D25	6	█	Y-917U	3219		D-POWER 1	7906	
325 Tds	E36	2.5	105	06.93 - 05.99	M51 D25	6	█	Y-917U	3219		D-POWER 1	7906	
325 ti Compact	E46/5	2.5	141	05.01 -	M54 B25	6		BKR6EQUP	3199	30			
325 Xi Touring	E46/3	2.5	141	09.00 -	M54 B25	6		BKR6EQUP	3199	30			
325 Xi	E46/4	2.5	141	09.00 -	M54 B25	6		BKR6EQUP	3199	30			
328 Ci Coupe	E46/2	2.8	142	04.99 - 06.00	M52 B28	6		BKR6EQUP	3199	30			
328 i	E36	2.8	142	01.95 - 09.99	M52 B28	6	0,8	BKR6EK	2288	20	BKR6EQUP	3199	
328 i Touring	E36/3	2.8	142	05.95 - 05.99	M52 B28	6	0,8	BKR6EK	2288	20	BKR6EQUP	3199	
328 i Touring	E46/3	2.8	142	10.99 -	M52 B28	6		BKR6EQUP	3199	30			
328 i	E46/4	2.8	142	04.98 -	M52 B28	6		BKR6EQUP	3199	30			
330 Cd	E46/2	3.0	150	03.03 -	M57N D30	6	█	Y-547AS	6670		D-POWER 47	5968	
330 Cd	E92	3.0	170	09.06 -	M57N2 D30	6	█	Y-547AS	6670		D-POWER 47	5968	
330 Ci Coupe	E46/2	3.0	170	06.00 -	M54 B30	6		BKR6EQUP	3199	30			
330 Ci Cabrio	E46/C	3.0	170	08.00 -	M54 B30	6		BKR6EQUP	3199	30			
330 d Touring	E46/3	3.0	135	02.00 - 11.03	M57 D30	6	█	Y-507R	4600		D-POWER 32	2691	
330 d Touring	E46/3	3.0	150	03.03 -	M57N D30	6	█	Y-547AS	6670		D-POWER 47	5968	
330 d	E46/4	3.0	135	09.00 - 11.03	M57 D30	6	█	Y-507R	4600		D-POWER 32	2691	
330 d	E90	3.0	170	01.06 -	M57N2 D30	6	█	Y-547AS	6670		D-POWER 47	5968	
330 d Touring	E91	3.0	170	09.05 -	M57N2 D30	6	█	Y-547AS	6670		D-POWER 47	5968	
330 i Touring	E46/3	3.0	170	06.00 -	M54 B30	6		BKR6EQUP	3199	30			
330 i	E46/4	3.0	170	08.00 -	M54 B30	6		BKR6EQUP	3199	30			
330 i	E90	3.0	190	03.05 -	N52 B30	6	1,1	ILZFR6D11	1208				
330 i Touring	E91	3.0	190	09.05 -	N52 B30	6	1,1	ILZFR6D11	1208				
330 i Coupe	E92	3.0	200	09.06 -	N52 B30	6	1,1	ILZFR6D11	1208				
330 i Cabrio	E93	3.0	200	04.07 -	N52 B30	6	1,1	ILZFR6D11	1208				
330 Xd Touring	E46/3	3.0	135	09.00 - 11.03	M57 D30	6	█	Y-507R	4600		D-POWER 32	2691	

<sup>1)</sup> Bic = Best in class



ℓ kW

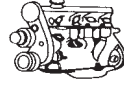

Cyl.

Order-  
No. No.Bic<sup>1)</sup> Order-  
D-POWER No.**BMW**

330 Xd Touring	E46/3	3.0	150	03.03 -	M57N D30	6	█	Y-547AS	6670		D-POWER 47	5968
330 Xd	E46/4	3.0	135	09.00 - 11.03	M57 D30	6	█	Y-507R	4600		D-POWER 32	2691
330 Xd	E46/4	3.0	150	03.03 -	M57N D30	6	█	Y-547AS	6670		D-POWER 47	5968
330 Xi Touring	E46/3	3.0	170	09.99 -	M54 B30	6		BKR6EQU	3199	30		
330 Xi	E46/4	3.0	170	09.99 -	M54 B30	6		BKR6EQU	3199	30		
335 d	E90	3.0	210	09.06 -	M57N2 D30	6	█	Y-547AS	6670		D-POWER 47	5968
335 d Touring	E91	3.0	210	09.06 -	M57N2 D30	6	█	Y-547AS	6670		D-POWER 47	5968
335 d Coupe	E92	3.0	210	09.06 -	M57N2 D30	6	█	Y-547AS	6670		D-POWER 47	5968
518 g Touring	E34/2	1.8	75	11.95 - 06.96	M43 B18	4	0,8	BKR6EK	2288	20	BKR6EQU	3199
518 i	E34	1.8	83	09.89 - 04.94	M40 B18	4	0,8	BKR6EK	2288	20	BKR6EQU	3199
518 i	E34	1.8	85	05.94 - 06.96	M43 B18	4	0,8	BKR6EK	2288	20	BKR6EQU	3199
520 d	E39	2.0	100	09.99 - 08.03	M47 D20	4	█	Y-507R	4600		D-POWER 32	2691
520 d Touring	E39/2	2.0	100	09.99 - 08.03	M47 D20	4	█	Y-507R	4600		D-POWER 32	2691
520 d	E60	2.0	120	09.05 -	M47N204D4	4	█	Y-547AS	6670		D-POWER 47	5968
520 d Touring	E61	2.0	120	11.05 -	M47N204D4	4	█	Y-547AS	6670		D-POWER 47	5968
520 i	E34	2.0	95	01.88 - 08.91	M20 B20	6	0,8	ZGR5A	5839	15		
520 i	E34	2.0	110	03.89 - 06.96	M50 B20	6	0,8	BKR6EK	2288	20	BKR6EQU	3199
520 i	E39	2.0	110	09.98 - 06.03	M52 B20	6		BKR6EQU	3199	30		
520 i	E39	2.0	110	01.96 - 08.98	M52 B20	6	0,8	BKR6EK	2288	20	BKR6EQU	3199
520 i	E39	2.0	125	08.00 - 06.03	M54 B20	6		BKR6EQU	3199	30		
520 i	E39	2.2	125	08.00 - 09.03	M54 B22	6		BKR6EQU	3199	30		
520 i Touring	E39/2	2.0	110	09.98 - 07.01	M52 B20	6		BKR6EQU	3199	30		
520 i Touring	E39/2	2.0	110	03.97 - 08.98	M52 B20	6	0,8	BKR6EK	2288	20	BKR6EQU	3199
520 i Touring	E39/2	2.0	125	08.00 -	M54 B20	6		BKR6EQU	3199	30		
520 i Touring	E39/2	2.2	125	08.00 - 05.04	M54 B22	6		BKR6EQU	3199	30		
520 i	E60	2.2	125	07.03 - 04.05	M54 B22	6		BKR6EQU	3199	30		
523 i	E39	2.5	125	09.98 - 12.00	M52 B25	6		BKR6EQU	3199	30		
523 i	E39	2.5	125	12.95 - 08.98	M52 B25	6	0,8	BKR6EK	2288	20	BKR6EQU	3199
523 i Touring	E39/2	2.5	125	03.97 - 08.98	M52 B25	6	0,8	BKR6EK	2288	20	BKR6EQU	3199
523 i Touring	E39/2	2.5	125	09.98 - 12.00	M52 B25	6		BKR6EQU	3199	30		
523 i	E60	2.5	130	03.05 -	N52 B25	6	1,1	ILZFR6D11	1208			
523 i Touring	E61	2.5	130	03.05 -	N52 B25	6	1,1	ILZFR6D11	1208			
524 Td	E34	2.4	85	03.88 - 08.91	M21 D24	6	█	Y-917U	3219		D-POWER 1	7906
525 d	E39	2.5	120	03.00 - 12.03	M57 D25	6	█	Y-507R	4600		D-POWER 32	2691
525 d Touring	E39/2	2.5	120	03.00 - 12.03	M57 D25	6	█	Y-507R	4600		D-POWER 32	2691
525 d Touring	E61	2.5	130	05.04 -	M57N D25	6	█	Y-547AS	6670		D-POWER 47	5968
525 d	E60	2.5	130	03.04 -	M57N D25	6	█	Y-547AS	6670		D-POWER 47	5968
525 i	E34	2.5	125	01.88 - 08.91	M20 B25	6	0,8	ZGR5A	5839	15		
525 i	E34	2.5	141	01.89 - 06.96	M50 B25	6	0,8	BKR6EK	2288	20	BKR6EQU	3199
525 i	E39	2.5	141	11.99 - 11.03	M54 B25	6		BKR6EQU	3199	30		
525 i Touring	E39/2	2.5	141	08.00 -	M54 B25	6		BKR6EQU	3199	30		
525 i	E60	2.5	141	09.03 - 12.04	M54 B25	6		BKR6EQU	3199	30		
525 i	E60	2.5	160	09.04 -	N52 B25	6	1,1	ILZFR6D11	1208			
525 i	E60N	2.5	140	03.07 -	N53 B25	6		ZKBR7AP-HTU				
525 i Touring	E61	2.5	141	05.04 - 12.04	M54 B25	6		BKR6EQU	3199	30		
525 i Touring	E61	2.5	160	09.04 -	N52 B25	6	1,1	ILZFR6D11	1208			
525 i	E61N	2.5	140	03.07 -	N53 B25	6		ZKBR7AP-HTU				
525 iX	E34	2.5	141	01.92 - 09.95	M50 B25	6	0,8	BKR6EK	2288	20	BKR6EQU	3199
525 iX Touring	E34/2	2.5	141	01.92 - 09.96	M50 B25	6	0,8	BKR6EK	2288	20	BKR6EQU	3199
525 Td	E34	2.5	85	06.92 - 06.96	M51 D25	6	█	Y-917U	3219		D-POWER 1	7906
525 Tds	E34	2.5	105	01.90 - 06.96	M51 D25	6	█	Y-917U	3219		D-POWER 1	7906
525 Tds	E39	2.5	105	03.95 - 10.00	M51 D25	6	█	Y-917U	3219		D-POWER 1	7906

<sup>1)</sup> Bic = Best in class



ℓ kW

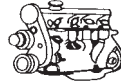

Cyl.

Order-  
No. No.Bic<sup>1)</sup> Order-  
D-Power No.**BMW**

528 i	E39	2.8	142	12.95 - 08.98	M52 B28	6	0,8	BKR6EK	2288	20	BKR6EQUIP	3199
528 i	E39	2.8	142	09.98 - 11.00	M52 B28	6		BKR6EQUIP	3199	30		
528 i Touring	E39/2	2.8	142	03.97 - 08.98	M52 B28	6	0,8	BKR6EK	2288	20	BKR6EQUIP	3199
528 i Touring	E39/2	2.8	142	09.98 - 12.00	M52 B28	6		BKR6EQUIP	3199	30		
530 d	E39	3.0	142	09.98 - 12.03	M57 D30	6	█	Y-507R	4600		D-POWER 32	2691
530 d Touring	E39/2	3.0	142	02.99 - 03.04	M57 D30	6	█	Y-507R	4600		D-POWER 32	2691
530 d	E60	3.0	160	08.02 - 10.05	M57N D30	6	█	Y-547AS	6670		D-POWER 47	5968
530 d	E60	3.0	170	02.05 -	M57N2 D30	6	█	Y-547AS	6670		D-POWER 47	5968
530 d Touring	E61	3.0	160	11.02 - 10.05	M57N D30	6	█	Y-547AS	6670		D-POWER 47	5968
530 d Touring	E61	3.0	170	02.05 -	M57N2 D30	6	█	Y-547AS	6670		D-POWER 47	5968
530 i	E34	3.0	138	01.88 - 08.91	M30 B30	6	0,8	ZGR5A	5839	15		
530 i	E34	3.0	155	04.92 - 06.96	M60 B30	8	0,8	BKR6EK	2288	20	BKR6EQUIP	3199
530 i	E39	3.0	170	08.00 -	M54 B30	6		BKR6EQUIP	3199	30		
530 i Touring	E39/2	3.0	170	08.00 -	M54 B30	6		BKR6EQUIP	3199	30		
530 i	E60	3.0	170	07.03 - 12.04	M54 B30	6		BKR6EQUIP	3199	30		
530 i	E60	3.0	190	10.04 -	N52 B30	6	1,1	ILZFR6D11	1208			
530 i Touring	E61	3.0	190	10.05 -	N52 B30	6	1,1	ILZFR6D11	1208			
530 Xd	E60	3.0	160	10.05 -	M57N D30	6	█	Y-547AS	6670		D-POWER 47	5968
535 d	E60	3.0	200	09.04 -	M57 D35	6	█	Y-547AS	6670		D-POWER 47	5968
535 d Touring	E61	3.0	200	09.04 -	M57 D35	6	█	Y-547AS	6670		D-POWER 47	5968
535 i	E34	3.5	155	01.88 - 08.92	M30 B35	6	0,8	ZGR5A	5839	15		
535 i	E39	3.5	180	06.96 - 08.98	M62 B35	8	0,8	BKR6EK	2288	20	BKR6EQUIP	3199
535 i	E39	3.5	180	09.98 - 09.03	M62 B35	8		BKR6EQUIP	3199	30		
540 i	E34	4.0	210	03.92 - 06.96	M60 B40	8	0,8	BKR6EK	2288	20	BKR6EQUIP	3199
540 i	E39	4.4	210	04.96 - 08.98	M62 B44	8	0,8	BKR6EK	2288	20	BKR6EQUIP	3199
540 i	E39	4.4	210	09.98 - 11.03	M62 B44	8		BKR6EQUIP	3199	30		
540 i Touring	E39/2	4.4	210	09.98 -	M62 B44	8		BKR6EQUIP	3199	30		
540 i Touring	E39/2	4.4	210	03.97 - 08.98	M62 B44	8	0,8	BKR6EK	2288	20	BKR6EQUIP	3199
540 i	E60	4.0	225	10.05 -	N62 B40	8	1,1	IZFR6H11	4294			
545 i	E60	4.4	245	09.03 - 10.05	N62 B44	8		BKR6EQUIP	3199	30		
545 i Touring	E61	4.4	245	05.04 - 08.05	N62 B44	8		BKR6EQUIP	3199	30		
550 i	E60	4.8	270	02.05 -	N62 B48	8	1,1	IZFR6H11	4294			
550 i Touring	E61	4.8	270	02.05 -	N62 B48	8	1,1	IZFR6H11	4294			
630 Ci	E63	3.0	190	09.04 -	N52 B30	6	1,1	ILZFR6D11	1208			
630 Ci Cabrio	E64	3.0	190	09.04 -	N52 B30	6	1,1	ILZFR6D11	1208			
635 Ci	E 63	3.6		04 -	N62 B36	8		BKR6EQUIP	3199	30		
635 CSi	E24	3.4	136	01.85 - 05.89	M30 B35	6	0,8	ZGR5A	5839	15		
635 CSi	E24	3.4	150	06.87 - 08.88	M30 B35	6	0,8	ZGR5A	5839	15		
645 Ci	E63	4.4	245	10.03 - 08.05	N62 B44	8		BKR6EQUIP	3199	30		
645 Ci Cabrio	E64	4.4	245	02.04 - 09.05	N62 B44	8		BKR6EQUIP	3199	30		
650 Ci	E63	4.8	270	10.05 -	N62 B48	8	1,1	IZFR6H11	4294			
650 Ci Cabrio	E64	4.8	270	03.05 -	N62 B48	8	1,1	IZFR6H11	4294			
725 Tds	E38	2.5	105	09.95 - 11.00	M51 D25	6	█	Y-917U	3219		D-POWER 1	7906
728 i	E38	2.8	142	09.98 - 11.01	M52 B28	6		BKR6EQUIP	3199	30		
728 i	E38	2.8	142	09.95 - 08.98	M52 B28	6	0,8	BKR6EK	2288	20	BKR6EQUIP	3199
730 d	E38	3.0	142	09.98 - 12.01	M57 D30	6	█	Y-507R	4600		D-POWER 32	2691
730 d	E65	3.0	150	11.01 - 02.05	M57N D30	6	█	Y-547AS	6670		D-POWER 47	5968
730 d	E65	3.0	170	07.04 -	M57N2 D30	6	█	Y-547AS	6670		D-POWER 47	5968
730 i	E32	3.0	136	09.86 - 08.92	M30 B30	6	0,8	ZGR5A	5839	15		
730 i	E32	3.0	160	04.92 - 09.94	M60 B30	8	0,8	BKR6EK	2288	20	BKR6EQUIP	3199
730 i	E38	3.0	160	09.94 - 09.95	M60 B30	8	0,8	BKR6EK	2288	20	BKR6EQUIP	3199
730 i	E65	3.0	170	10.02 - 02.05	M54 B30	6		BKR6EQUIP	3199	30		

<sup>1)</sup> Bic = Best in class



ℓ kW

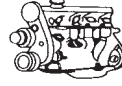

Cyl.

Order-  
No. No.Bic<sup>1)</sup> Order-  
D-Power No.**BMW**

730 i	E65	3.0	190	03.05 -	N52 B30	6	1,1	ILZFR6D11	1208				
735 i	E32	3.4	155	09.86 - 07.92	M30 B35	6	0,8	ZGR5A	5839	15			
735 i	E38	3.5	175	09.98 -	M62 B35	8		BKR6EQU	3199	30			
735 i	E38	3.5	175	03.96 - 08.98	M62 B35	8	0,8	BKR6EK	2288	20	BKR6EQU	3199	
735 i	E65	3.6	200	07.01 - 02.05	N62 B36	8		BKR6EQU	3199	30			
740 i	E32	4.0	210	04.92 - 09.94	M60 B40	8	0,8	BKR6EK	2288	20	BKR6EQU	3199	
740 i	E38	4.0	210	09.94 - 05.95	M60 B40	8	0,8	BKR6EK	2288	20	BKR6EQU	3199	
740 i	E38	4.4	210	05.95 - 08.98	M62 B44	8	0,8	BKR6EK	2288	20	BKR6EQU	3199	
740 i	E38	4.4	210	09.96 - 11.01	M62 B44	8		BKR6EQU	3199	30			
740 i	E65	4.0	225	01.05 -	N62 B40	8	1,1	IZFR6H11	4294				
745 i	E65	4.4	245	07.01 - 02.05	N62 B44	8		BKR6EQU	3199	30			
750 i	E32	5.0	220	09.87 - 09.94	M70 B50	12	0,7	ZFR5F	5165		ZFR5FIX-11	2477	
750 i	E38	5.4	240	11.94 -	M73 B54	12		BKR6EQU	3199	30			
750 i	E65	4.8	270	01.05 -	N62 B48	8	1,1	IZFR6H11	4294				
760 i	E65	6.0	327	01.03 -	N73 B60	12		BKR6EQU	3199	30			
840 Ci	E31	4.0	210	12.93 - 02.96	M60 B40	8	0,8	BKR6EK	2288	20	BKR6EQU	3199	
840 Ci	E31	4.4	210	03.96 - 05.99	M62 B44	8	0,8	BKR6EK	2288	20	BKR6EQU	3199	
850 Ci	E31	5.0	220	05.89 - 10.94	M70 B50	12	0,7	ZFR5F	5165		ZFR5FIX-11	2477	
850 Ci	E31	5.4	240	10.94 - 05.99	M73 B54	12		BKR6EQU	3199	30			
850 CSI	E31	5.6	280	02.93 - 11.96	S70 B56	12	0,7	ZFR5F	5165		ZFR5FIX-11	2477	
M3	E30	2.3	143	07.86 - 12.90	S14 B23	4		--- *					
M3	E36	3.0	210	11.92 - 07.95	S50 B30	6		--- *					
M3	E36	3.2	236	11.95 - 10.99	S50 B32	6	0,7	PKR7A	3641				
M3	E46	3.2	252	11.00 -	S54 B32	6		DCPR8EKP	7415				
M3 CSL	E46	3.2	265	06.03 -	S54 B32	6		DCPR8EKP	7415				
M3	E92	4.0	309	09.07 -	S65 B40	8		LKR8AP	4471				
M3 Sport Evolution	E30	2.5	175	11.89 - 08.91	S14 B25	4		--- *					
M5	E34	3.5	232	10.88 - 12.92	S38 B35	6		--- *					
M5	E34	3.8	250	01.92 - 07.95	S38 B38	6		--- *					
M5	E39	5.0	294	09.98 - 07.03	S62 B50	8		BKR6EQU	3199	30			
M5	E60	5.0	373	11.04 -	S85 B50	10		LKR8AP	4471				
M6	E63	5.0	373	09.04 -	S85 B50	10		LKR8AP	4471				
MG35 CSI	E24	3.5	191	01.85 - 05.89	S38 B35 Kat.	6	0,7	--- *					
X 3 4x4	E83	2.0	110	09.04 -	M47N D20	4	☑	Y-547AS	6670		D-POWER 47	5968	
X 3 4x4	E83	2.0	110	09.05 -	N46 B20	4	1,1	IZFR6H11	4294				
X 3 4x4	E83	2.5	141	01.04 -	M54 B25	6		BKR6EQU	3199	30			
X 3si 4x4	E83	2.5	160	08.06 -	N52 B25	6	1,1	ILZFR6D11	1208				
X 3 4x4	E83	3.0	150	01.03 - 09.05	M57N D30	6	☑	Y-547AS	6670		D-POWER 47	5968	
X 3 4x4	E83	3.0	160	10.04 -	M57N2 D30	6	☑	Y-547AS	6670		D-POWER 47	5968	
X 3 4x4	E83	3.0	170	01.04 -	M54 B30	6		BKR6EQU	3199	30			
X 3si 4x4	E83	3.0	200	06.06 -	N52 B30	6	1,1	ILZFR6D11	1208				
X 3sd 4x4	E83	3.0	210	09.06 -	M57N2 D30	6	☑	Y-547AS	6670		D-POWER 47	5968	
X 5d 4x4	E53	3.0	142	08.01 - 11.03	M57 D30	6	☑	Y-507R	4600		D-POWER 32	2691	
X 5d 4x4	E53	3.0	160	12.03 -	M57N D30	6	☑	Y-547AS	6670		D-POWER 47	5968	
X 5i 4x4	E53	3.0	170	10.99 -	M54 B30	6		BKR6EQU	3199	30			
X 5i 4x4	E53	4.4	210	09.99 - 09.03	M62 B44	8		BKR6EQU	3199	30			
X 5i 4x4	E53	4.4	235	10.03 -	N62 B44	8		BKR6EQU	3199	30			
X 5 4.6 iS 4x4	E53	4.6	255	10.01 - 09.03	M62 B46	8		BKR6EQU	3199	30			
X 5 4.8 iS 4x4	E53	4.8	265	04.04 -	N62 B48	8	1,1	IZFR6H11	4294				
X 5i 4x4	E70	3.0	200	02.07 -	N52 B30	6	1,1	ILZFR6D11	1208				
X 5 4.8 iS 4x4	E70	4.8	261	02.07 -	N62 B48	8	1,1	IZFR6H11	4294				
Z 1		2.5	125	11.88 - 06.91	M20 B25	6	0,8	ZGR5A	5839	15			

<sup>1)</sup> Bic = Best in class

\* only by car dealer



ℓ kW

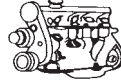

Cyl.

Order-  
No. No.Bic<sup>1)</sup> Order-  
D-Power No.**BMW**

Z 3	E36/7	1.8	85	02.96 - 09.98	M43 B18	4	0,8	BKR6EK	2288	20	BKR6EQUP	3199
Z 3	E36/7	1.8	85	09.98 -	M43 B18	4		BKR6EQUP	3199	30		
Z 3	E36/7	1.9	87	03.99 -	M43 B19	4		BKR6EQUP	3199	30		
Z 3	E36/7	1.9	103	11.95 - 03.99	M44 B19	4	0,8	BKR6EK	2288	20	BKR6EQUP	3199
Z 3	E36/7	2.0	110	09.98 - 12.00	M52 B20	6		BKR6EQUP	3199	30		
Z 3	E36/7	2.2	125	09.00 - .03	M54 B22	6		BKR6EQUP	3199	30		
Z 3	E36/7	2.8	142	09.98 - 12.00	M52 B28	6		BKR6EQUP	3199	30		
Z 3	E36/7	2.8	142	03.97 - 08.98	M52 B28	6	0,8	BKR6EK	2288	20	BKR6EQUP	3199
Z 3	E36/7	3.0	170	09.00 - .03	M54 B30	6		BKR6EQUP	3199	30		
Z 3 M	E36/7	3.2	239	01.97 -	S50 B32	6	0,7	PKR7A	3641			
Z 3 Coupè	E36/7C	2.8	142	09.98 - 12.00	M52 B28	6		BKR6EQUP	3199	30		
Z 3 Coupè	E36/7C	3.0	170	09.00 - .03	M54 B30	6		BKR6EQUP	3199	30		
Z 3 M Coupè	E36/7C	3.2	239	09.98 -	S50 B32	6	0,7	PKR7A	3641			
Z 4	E85	2.0	110	09.04 -	N46 B20	4	1,1	IZFR6H11	4294			
Z 4	E85	2.2	125	09.03 -	M54 B22	6		BKR6EQUP	3199	30		
Z 4	E85	2.5	141	04.03 -	M54 B25	6		BKR6EQUP	3199	30		
Z 4si	E85	2.5	160	10.04 -	N52 B25	6	1,1	ILZFR6D11	1208			
Z 4	E85	3.0	170	04.03 -	M54 B30	6		BKR6EQUP	3199	30		
Z 4si	E85	3.0	195	10.05 -	N52 B30	6	1,1	ILZFR6D11	1208			
Z 4 M	E85	3.2	252	03.06 -	S54 B32	6		DCPR8EK	7415			
Z 4si Coupè	E86	3.0	195	10.05 -	N52 B30	6	1,1	ILZFR6D11	1208			
Z 4 M Coupè	E86	3.2	252	10.05 -	S54 B32	6		DCPR8EK	7415			
Z 8	E52	5.0	294	06.00 - 07.03	S62 B50	8		BKR6EQUP	3199	30		

**BRISTOL**

Beaufighter		5.9		01.80 - 12.89		8	0,9	BPR5ES	7422	6	BPR5EIX	6597
Beaufighter V8 Turbo		5.9		01.80 - 12.89		8	0,9	BPR5ES	7422	6	BPR5EIX	6597
Blenheim		5.9	170	03.94 -	360 V8 Chrysler	8	0,9	BPR5ES	7422	6	BPR5EIX	6597
Brigand Turbo		5.9				8	0,9	BPR5ES	7422	6	BPR5EIX	6597
Britannia Turbo		5.9		10.82 - 12.89		8	0,9	BPR5ES	7422	6	BPR5EIX	6597

**BUICK**

Century		2.2		95 - 96	4	4	1,5	TR55-1	6674		TR55-1IX	7316
Century		2.2		93 - 94	4	4	1,1	TR4	4392		TR4IX	7300
Century		2.5		84 - 92	R	4	1,5	UR55	6950		UR55IX	7272
Century		2.8		87 - 89	W V6	6	1,1	TR4	4392		TR4IX	7300
Century		3.0		82 -	E V6	6	2,0	UR40	4386			
Century		3.1		00 -	J OHV V6	6	1,5	TR55IX	7164		TR55IX	7164
Century		3.1		94 - 99	M OHV V6	6	1,5	TR55IX	7164		TR55IX	7164
Century		3.3		89 - 93	N V6	6	1,5	TR55	1048		TR55IX	7164
Century		3.8		86 - 88	3 V6	6	1,1	TR5	7837		TR5IX	7397
Century		3.8		86 -	B V6	6	1,1	TR5	7837		TR5IX	7397
Lacrosse		3.6		05 -	V6 7 FI 217	6	1,0	PLTR6A-10G	3587			
Lacrosse		3.6		05 -	V6 2 FI	6	1,5	TR55	1048		TR55IX	7164
LeSabre		3.0		86 -	L V6	6	1,1	TR5	7837		TR5IX	7397
LeSabre		3.8		96 - 01	K V6	6	1,5	PTR4B-15	5146			
LeSabre		3.8		02 -	K V6	6	1,5	PTR4B-15	5146			
LeSabre		3.8		86 - 88	3 V6	6	1,1	TR5	7837		TR5IX	7397
LeSabre		3.8		92 - 95	L V6	6	1,5	PTR4B-15	5146			
LeSabre		3.8		88 - 91	C V6	6	1,5	PTR4B-15	5146			
LeSabre		5.0		85 - 90	Y V8	8	1,5	FR45	4636			
Park Avenue		3.8		91 -	K V6	6	1,5	PTR4B-15	5146		TR55IX	7164

<sup>1)</sup> Bic = Best in class



l kW

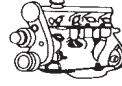

Cyl.

Order-  
No. No.Bic<sup>1)</sup> Order-  
D-Power No.**BUICK**

Park Avenue	3.8		92- 97	1 V6 Super Charged	6	1,5	PTR4B-15	5146		TR55IX	7164
Park Avenue	3.8		02-	V6 1 FI Supercharged	6	1,5	TR55	1048		TR55IX	7164
Park Avenue	3.8		02-	V6 K FI	6	1,5	TR55	1048		TR55IX	7164
Regal	3.8		96-	K V6 MFI	6	1,5	PTR4B-15	5146		TR55IX	7164
Regal	3.8		96-	SC V6 MFI 1	6	1,5	PTR4B-15	5146		TR55IX	7164
Rivera	3.8		96-	SC V6 MFI 1	6	1,5	PTR4B-15	5146		TR55IX	7164
Rivera	3.8		96- 97	K V6 MFI	6	1,5	PTR4B-15	5146		TR55IX	7164

**CADILLAC**

Allante	4.6		87- 90	7 DFI / 8 MFI	8	1,5	TR55	1048		TR55IX	7164
Allante	4.6		91- 94	8 / 9 MFI	8	1,5	TR55	1048		TR55IX	7164
BLS 1.9D	1.9	110	06-	Z19DTH Fiat	4	█	YE07	6092			
Brougham	5.0		91- 92	E TBI	8	1,1	UR4	4762		UR4IX	7401
Brougham	5.7		91- 92	7 TBI	8	0,7	UR5	2139		UR5IX	7177
Brougham	5.7		93-	7 TBI	8	1,1	UR4	4762		UR4IX	7401
Catera	3.0		97- 01	R DOHC MFI	6	0,8	BKR5EK	7956	23	BKR5EIX	6341
Concours	4.6		94- 94	Y SFI	8	1,5	TR55	1048		TR55IX	7164
Concours	4.6		96- 98	9 MFI	8	1,5	TR55	1048		TR55IX	7164
Concours	4.6		95- 95	Y MFI	8	1,5	TR55	1048		TR55IX	7164
CTS-V	5.7	298	05-		8	1,5	TR55	1048		TR55IX	7164
De Ville	4.5		90- 90	3 MFI	8	1,5	TR55	1048		TR55IX	7164
De Ville	4.6		99-	Y MFI	8	1,5	TR55	1048		TR55IX	7164
De Ville	4.6		96- 98	Y MFI	8	1,5	TR55	1048		TR55IX	7164
De Ville	4.6		01-	9 MFI	8	1,5	TR55	1048		TR55IX	7164
De Ville	4.9		91- 91	B MFI	8	1,5	TR55	1048		TR55IX	7164
De Ville	4.9		92- 95	B MFI	8	1,5	TR55	1048		TR55IX	7164
Eldorado	4.6		94- 98	9 MFI / SFI	8	1,5	TR55	1048		TR55IX	7164
Eldorado	4.6		93- 93	9 / Y MFI	8	1,5	TR55	1048		TR55IX	7164
Eldorado	4.6		94- 98	Y MFI / SFI	8	1,5	TR55	1048		TR55IX	7164
Eldorado	4.6		99-	V8 MFI 9	8	1,3	TR55	1048		TR55IX	7164
Eldorado	4.6		99-	V8 MFI Y	8	1,3	TR55	1048		TR55IX	7164
Eldorado	4.9		92- 93	B MFI	8	1,5	TR55	1048		TR55IX	7164
Seville	4.6		99-	V8 MFI 9	8	1,3	TR55	1048		TR55IX	7164
Seville	4.6		99-	V8 MFI Y	8	1,3	TR55	1048		TR55IX	7164
SRX Sport Luxury	4.6	239	10.04-	A V8 FI	8	1,5	TR55	1048		TR55IX	7164
XLR	4.6	239	05-	A V8 FI	8	1,5	TR55	1048		TR55IX	7164

**CATERHAM**

7	1.6	85		K SERIES	4	0,9	BKR6E	6962	28	BKR6EIX	6418
7 Superlight/Sport	1.6	101		K SERIES	4	0,8	BCPR7ES	3330		BCPR7EIX	5690
21	1.6	85		K SERIES	4	0,9	BKR6E	6962	28	BKR6EIX	6418
21 Superlight/Sport	1.6	100		K SERIES	4	0,8	BCPR7ES	3330		BCPR7EIX	5690
Seven	1.1			Honda	4	0,9	CR9EHVX-9	3872			
Seven	1.4			K Series	4	0,8	BKR6ES	3783	28	BKR6EIX	6418
Seven Super Sprint	1.7	99			4	0,6	B8ECS	2821			
Seven	1.7	125		BDR	4	0,6	B8ECS	2821			
Seven R500	1.8				4	0,7	BKR7E	6097		BKR7EVX	3544
Super Seven			85-		4	0,6	B8ECS	2841			
Super Seven Sprint	1.6			Ford Kent T	4	0,8	BP7ES	2412		BPR7EIX	4055
Super Seven GT	1.6			FORD Kent S	4	0,8	BPR7ES	2023	19	BPR7EIX	4055
Super Seven HPC	2.0	110	07.91 -	Opel 16V	4	0,8	BCPR7ES	3330		BCPR7EIX	5690

<sup>1)</sup> Bic = Best in class





ℓ kW

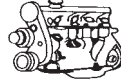

Cyl.

Order-  
No. No.Bic<sup>1)</sup> Order-  
D-Power No.**CHEVROLET**

Aveo	1.2	53	02.05 - 08	SOHC 8V	4	1,1	BPR5EY-11	3028		BPR5EIX-11	2115
Aveo	1.4	69	02.05 - 08	DOHC 16V	4	1,1	BKR6E-11	2756	14	BKR6EIX-11	3764
Aveo 1.4 16V SX	1.4	69	12.05 - 08	F14D3 DOHC	4	1,1	BKR6E-11	2756	14	BKR6EIX-11	3764
Blazer	4.3		96 - 02	V6 W EFI	6	1,5	PZTR5A-15	7862			
Blazer	4.3		95 - 95	V6 W EFI	6	1,3	UR5	2139		UR5IX	7177
Blazer	4.3		03 -	V6 X EFI	6	1,5	PZTR5A-15	7862			
Blazer	5.7		94 -	V8 K TBI	8	1,3	UR6	4079		UR6IX	7348
Blazer	5.7		87 - 93	V8 K TBI	8	1,3	UR5	2139		UR5IX	7177
Blazer	5.7		87 - 93	V8 K EFI	8	1,3	UR5	2139		UR5IX	7177
Blazer	5.7		94 - 94	V8 K EFI	8	1,3	UR6	4079		UR6IX	7348
Camaro	2.8		85 - 89	S V6 EFI	6	1,3	UR5	2139		UR5IX	7177
Camaro	3.1		90 - 92	T V6 EFI	6	1,3	UR5	2139		UR5IX	7177
Camaro	3.4		93 - 95	S V6 EFI	6	1,3	UR5	2139		UR5IX	7177
Camaro	3.8		01 -		6	1,5	PTR4B-15	5146			
Camaro	3.8		96 -	V6 MFI K	6	1,5	TR55	1048		TR55IX	7164
Camaro	5.0		88 - 92	E V8 EFI	8	1,1	UR4	4762		UR4IX	7401
Camaro	5.0		85 - 92	F V8 EFI	8	1,1	UR4	4762		UR4IX	7401
Camaro	5.7		87 - 92	V8 EFI Cast Iron Heads	8	1,1	UR4	4762		UR4IX	7401
Camaro	5.7		93 - 97	P V8 EFI	8	1,5	TR55	1048		TR55IX	7164
Camaro	5.7		98 - 02	G V8 EFI	8	1,5	TR55	1048		TR55IX	7164
Camaro	5.7		87 - 92	V8 EFI Alu Heads	8	0,9	FR4	5188			
Captiva 2.4	2.4	100	09.06 -	Z24SED	4	0,8	BKR5EK	7956	23	BKR5EIX	6341
Captiva 3.2	3.2	169	09.06 -	Z32SED	6	1,3	PTR5A-13	2467	25		
Cavalier	2.4		99 -	L4 MFI T	4	1,5	TR55	1048		TR55IX	7164
Corvette	5.7		88 - 91	8 V8 EFI Cast Iron Heads	8	1,1	UR4	4762		UR4IX	7401
Corvette	5.7		86 - 91	8 V8 EFI Alu Heads	8	0,9	FR4	5188			
Corvette	5.7		01 - 03	G V8 EFI	8	1,3	TR55	1048		TR55IX	7164
Corvette	5.7		01 - 01	S V8 EFI	8	1,3	TR55	1048		TR55IX	7164
Corvette	5.7		92 - 96	P V8 EFI	8	1,3	TR55	1048		TR55IX	7164
Corvette	5.7		96 - 96	5 V8 EFI	8	1,2	TR55	1048		TR55IX	7164
Corvette	5.7		93 - 95	J V8 EFI	8	1,2	TR55	1048		TR55IX	7164
Corvette	5.7		90 - 92	J V8 EFI ZR1	8	1,2	TR55	1048		TR55IX	7164
Corvette	5.7		03 - 04	V8	8	1,5	PZTR5A-15	7862			
Corvette	5.7	294	97 - 00	G V8 EFI	8	1,3	TR55	1048		TR55IX	7164
Corvette	6.0		05 -	V8	8	1,5	PZTR5A-15	7862			
Epica	2.0	106	06.06 -	XK	6	0,9	BKUR6ETB	6992			
Epica	2.5	115	06.06 -		6	0,9	BKUR6ETB	6992			
Evanda	2.0	96	02.05 -	T20SED DOHC 16v	4	0,8	BKR5EK	7956	23	BKR5EIX	6341
Kalos 1.2	1.2	53	02.05 -	B12S1	4	1,1	BPR5EY-11	3028		BPR5EIX-11	2115
Kalos 1.4	1.4	61	02.05 -	F14S3 SOHC	4	0,8	BPR6ES	7822	2	BPR6EIX	6637
Kalos 1.4 16V SX	1.4	69	02.05 -	F14D3 DOHC	4	1,1	BKR6E-11	2756	14	BKR6EIX-11	3764
Lacetti	1.4	70	02.05 -	F14D3	4	1,1	BKR6E-11	2756	14	BKR6EIX-11	3764
Lacetti	1.6	80	02.05 -	F16D3	4	1,1	BKR6E-11	2756	14	BKR6EIX-11	3764
Lacetti	1.8	89	02.05 -	T18SED	4	0,8	BKR5EK	7956	23	BKR5EIX	6341
Lumina	3.8		98 -	V6 MFI K	6	1,5	PTR4B-15	5146			
Malibu	2.4		97 - 99	T MFI DOHC	4	1,5	TR55	1048		TR55IX	7164
Malibu	3.1		00 -	J V6 SFI	6	1,5	TR55	1048		TR55IX	7164
Malibu	3.1		97 - 99	M V6 MFI	6	1,5	TR55	1048		TR55IX	7164
Malibu	3.8		83 -	9 V6 2Verg./Cab.	6	1,1	UR4	4762		UR4IX	7401
Matiz	0.8	38	02.05 -	F8CV	3	1,1	BPR5EY-11	3028		BPR5EIX-11	2115
Matiz	1.0	47	02.05 -	B10S	4	1,1	BPR5EY-11	3028		BPR5EIX-11	2115
Metro	1.0		98 -	L3 TBI 6	3	1,1	BPR6ES-11	4824	13	BPR6EIX-11	3903

<sup>1)</sup> Bic = Best in class



l kW

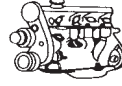

Cyl.

Order-  
No. No.Bic<sup>1)</sup> Order-  
D-Power No.**CHEVROLET**

Metro	1.3		98-	L4 TBI 9	4	1,1	BKR6E-11	2756	14	BKR6EIX-11	3764
Monte Carlo	3.8		96-	V6 MFI K	6	1,5	PTR4B-15	5146			
Niva	1.8	92	02.05-	Z18XE	4	0,8	BKR5EK	7956	23	BKR5EIX	6341
Nubira 1.6	1.6	80	02.05-	A16DMS DOHC	4	1,1	BKR6E-11	2756	14	BKR6EIX-11	3764
Nubira 1.8 CDX	1.8	89	02.05-	T18SED	4	0,8	BKR5EK	7956	23	BKR5EIX	6341
Prizum	1.8		98- 99	L4 MPI 8 DOHC	4	1,1	BKR5EKB-11	3967			
Prizum	1.8		00-	L4 MPI 8 DOHC	4	1,1	IFR5T-11	4996			
Rezzo / Tacuma U100	1.6	77	02.05-	A16DMS	4	1,1	BKR5E-11	6953	33	BKR5EIX-11	5464
Rezzo / Tacuma U100	2.0	89	02.05-	T20SED	4	0,8	BKR5EK	7956	23	BKR5EIX	6341
Suburban	5.7	140	04.95-	L05 V8-EFI	8	0,8	BPR6FS	2623			
Tahoe	4.8		01-	V FI V8	8	1,5	TR55	1048		TR55IX	7164
Tahoe	4.8		00- 00	V FI V8	8	1,5	TR55	1048		TR55IX	7164
Tahoe	5.3		02- 03	Z FLEX V8	8	1,5	TR55	1048		TR55IX	7164
Tahoe	5.3		05-	Z FLEX V8 323	8	1,5	TR55	1048		TR55IX	7164
Tahoe	5.3		04-	Z FI V8	8	1,5	TR55	1048		TR55IX	7164
Tahoe	5.3	201	00-	T FI V8	8	1,5	TR55	1048		TR55IX	7164
Tahoe	5.7	147	04.96- 00	R V8	8	1,5	TR55	1048		TR55IX	7164
Tracker	1.6		98-	L4 MFI 6	4	1,1	BKR6E-11	2756	14	BKR6EIX-11	3764
Trail Blazer 4.2 LTZ	4.2	201	02- 03	S EFI	6	1,3	PTR5A-13	2467	25		
Trail Blazer 5.3	5.3		03-	V8 P EFI	8	1,5	TR55	1048		TR55IX	7164
Viva	1.8	92	02.05-	Z18XE	4	0,8	BKR5EK	7956	23	BKR5EIX	6341

**CHRYSLER**

300	2.7		05-	V6 R FI Dir. Ign.	6	1,3	LZTR5A-13	4306			
300 C	2.7	142	01.05-	V6	6	1,3	LZTR5A-13	4306			
300 C CRD	3.0	142	10.05-	V6 C320CDI Mercedes	6	█	Y-745U	4705		D-POWER 11	6346
300 C	3.5	183	07.04-	V6 G FI	6	1,3	ZFR5LP-13G	7781			
300 C	5.7	250	07.04-	V8 HEMI	8	1,3	LZTR5A-13	4306			
300 C SRT8	6.1	316	06-	W V	8	1,3	LZTR5A-13	4306			
300 M	3.5		03-	V6 K FI Dir.Ign.	6	1,3	ZFR5LP-13G	7781			
300 M	3.5	189	09.99-	V6 G FI	6	1,3	ZFR5LP-13G	7781			
Cirrus	2.4		99-	X DOHC	4	1,3	FR45	4636			
Cirrus	2.5		95-	V6 MPI H DOHC	6	1,1	PFR5G-11	2647			
Concorde	2.7		98-	V6 MPI R DOHC	6	1,3	PTR5A-13	2467	25		
Concorde	3.3		94- 94	V6 FF U	6	1,2	GR45	2822			
Concorde	3.3		93- 96	V6 MPI T	6	1,2	GR45	2822			
Concorde	3.5		93- 97	V6 MPI F	6	0,9	FR5-1	7252			
Crossfire	3.2	160	03-	engine Mercedes SLK	6	1,0	IFR6D10	5344			
Crossfire SRT6	3.2	247		Supercharged	6	1,1	BKR5ES-11	2382	33	BKR5EIX-11	5464
Daytona	2.5	114	92-	EDT L4 Turbo	4	0,8	BPR6ES	7822	2	BPR6EIX	6637
Dodge Viper	8.0		96-	E MPI V10	10	0,9	FR5-1	7252			
ES	2.2	105	88- 88	EDR 2,2 Turbo	4	0,8	BPR6ES	7822	2	BPR6EIX	6637
ES	2.5		89- 89	EDT 2,5	4	0,8	BPR6ES	7822	2	BPR6EIX	6637
ES	2.5	72	88- 89	EDM 2,5	4	0,8	BPR6ES	7822	2	BPR6EIX	6637
GS Turbo 2	2.2	130	88- 89	EDS Turbo2	4	0,8	BPR6ES	7822	2	BPR6EIX	6637
GTS	2.2	109	88- 88	EDR	4	0,8	BPR6ES	7822	2	BPR6EIX	6637
GTS	2.5	72	88- 89	EDM	4	0,8	BPR6ES	7822	2	BPR6EIX	6637
GTS	2.5	108	89- 89	EDT	4	0,8	BPR6ES	7822	2	BPR6EIX	6637
GTS Shelby	2.2	130	89- 89	EDS	4	0,8	BPR6ES	7822	2	BPR6EIX	6637
Imperial	3.3		90- 91	V6 MPI 3	6	1,2	GR45	2822			
Imperial	3.8		91- 93	V6 MPI L	6	1,2	GR45	2822			
Le Baron GTC	2.2		89- 89	EDS	4	0,8	BPR6ES	7822	2	BPR6EIX	6637

<sup>1)</sup> Bic = Best in class



ℓ kW

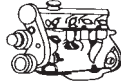

Cyl.

Order-  
No. No.Bic<sup>1)</sup> Order-  
D-Power No.**CHRYSLER**

Le Baron	2.2	105	88 - 88	EDR	4	0,8	BPR6ES	7822	2	BPR6EIX	6637
Le Baron	2.5	72	88 - 89	EDM	4	0,8	BPR6ES	7822	2	BPR6EIX	6637
Le Baron	2.5	108	89 -	EDT	4	0,8	BPR6ES	7822	2	BPR6EIX	6637
Le Baron	3.0	100	90 - 95	EFA V6	6	1,1	BPR5ES-11	4424		BPR5EIX-11	2115
Neon	1.8		03.98 - 10.99		4	0,9	BKR6E	6962	28	BKR6EIX	6418
Neon LE	2.0	98	01.95 -	ECB 16V	4	0,8	BCPR6ES	2330	12	BCPR6EIX	5689
New Yorker	3.3		90 - 93	V6 MPI R	6	1,3	GR45	2822			
New Yorker	3.5		94 - 96	V6 MPI F	6	0,9	FR5-1	7252			
New Yorker	3.8		91 - 93.93	V6 MPI U	6	1,3	GR45	2822			
PT Cruiser	1.6	85	06.01 -		4		--- *				
PT Cruiser	2.0	104	06.00 -		4	1,1	LZTR4A-11	5444			
PT Cruiser CRD	2.2	110	03.02 -		4	█	Y-745U	4705		D-POWER 11	6346
Saratoga	2.5	72	90 - 94	EDM	4	0,8	BPR6ES	7822	2	BPR6EIX	6637
Saratoga	3.0	104	90 - 94	EFA V6	6	1,1	BPR5ES-11	4424		BPR5EIX-11	2115
Sebring	2.0		95 - 99	L4 MPI Y DOHC	4	1,1	BKR6EVX-11	3540		BKR6EIX-11	3764
Sebring 2.0 CRD	2.0	103	07 -	engine by VW	4	█	Y-607AS	9776		D-POWER 50	
Sebring	2.0	104	06.01 -	EC4	4	1,1	LZTR4A-11	5444			
Sebring	2.4		96 - 98	L4 MPI X DOHC	4	1,1	FR45	4636			
Sebring	2.4		01 -	4G64 SOHC	4	1,1	BKR5E-11	6953	33	BKR5EIX-11	5464
Sebring	2.5		95 - 99	V6 MPI N DOHC	6	1,1	PFR5G-11	2647			
Sebring	2.7	149	04.01 -	V6 R DOHC	6		--- *				
Stratus	2.0	96	00 -		4	0,9	BKR6E	6962	28	BKR6EIX	6418
Stratus	2.0	98	95 - 00	ECB 16V	4	0,8	BCPR6ES	2330	12	BCPR6EIX	5689
Stratus	2.5	120	04.95 -	EEB V6 MPI	6	1,1	PFR6B-11	4014			
Vision	3.5	155	94 -	EGE V6 MPI	6	0,9	FR5-1	7252			
Voyager 1	2.5	72	88 - 90	EDM	6	0,8	BPR6ES	7822	2	BPR6EIX	6637
Voyager 1	3.0	100	88 - 91	EFA	6	1,1	BPR5ES-11	4424		BPR5EIX-11	2115
Voyager 2	2.0	98	97-01.01	ECB C00	4	0,9	BKR6E	6962	28	BKR6EIX	6418
Voyager 2	2.4	110	96-01.01	EDZ B00	4	1,1	ZFR5A-11	5084			
Voyager 2	2.5	72	91 - 95	EDM	6	0,8	BPR6ES	7822	2	BPR6EIX	6637
Voyager 2	2.5	88	04.92 - 04.95	VM 425 CLIRE	4	█	Y-923U	3380		D-POWER 1	7906
Voyager 2	2.5	88	04.92 - 04.95	VM HR-492	4	█	Y-923U	3380		D-POWER 1	7906
Voyager 2	2.5	88	05.95 - 01.01	VM HR425 CLIEE	4	█	Y-741U	5065		D-POWER 20	6943
Voyager 2	3.3	120	91 - 95	EGA V6 MPI R	6	1,3	GR4	7038		GR4IX	7149
Voyager 2	3.8	122	96 - 01.01	EGH V6 MPI	6	1,3	GR4	7038		GR4IX	7149
Voyager 3	2.4	112	00 -		4	1,3	FR45	4636			
Wrangler Jeep	2.5		01.93 - 01.01		4	0,9	FR5-1	7252			
Wrangler Jeep	4.0		93 - 99		6	0,9	FR5-1	7252			

**CITROEN**

AX 1.0i	1.0		07.92 - 02.95	TU9M CDZ	4	0,8	BCPR5ES	6130	32	BCPR5EIX	5688
AX 1.0i	1.0		09.86 - 06.92	TU9 C1A	4	0,8	BCP5ES	7496	16	BCPR5EIX	5688
AX 1.0i	1.0	30	10.86 -	TU9..	4	0,7	BCP6ES	4930	17	BCPR6EIX	5689
AX 1.0i	1.0	37	03.95 -	TU9M CDZ	4	0,8	BKR5EK	7956	23	BKR5EIX	6341
AX 1.0i	1.0	37	07.92 -	TU9.M Cat.	4	0,8	BKR5EK	7956	23	BKR5EIX	6341
AX 1.1i	1.1		07.95 -	TU1M HDZ	4	0,8	BKR5EK	7956	23	BKR5EIX	6341
AX 1.1i	1.1		07.92 - 06.95	TU1M HDZ	4	0,8	BCPR5ES	6130	32	BCPR5EIX	5688
AX 1.1i	1.1		09.86 - 06.92	TU1 H1A	4	0,8	BCP5ES	7496	16	BCPR5EIX	5688
AX 1.1	1.1	44	07.92 - 06.95	TU1M HDZ Cat.	4	0,8	BCPR5ES	6130	32	BCPR5EIX	5688
AX 1.3i Sport	1.3	69	02.87 - 12.92	TU24 M4A	4	0,9	BKUR7ET	7873		PFR7Q	7963
AX 1.4 GTi	1.4		09.91 - 12.92	TU3J2 K6B	4	0,8	BKR6EK	2288	20	BKR6EQUP	3199
AX 1.4	1.4		09.86 - 12.92	TU3 K1A, TU3A K1G	4	0,8	BCP5ES	7496	16	BCPR5EIX	5688

<sup>1)</sup> Bic = Best in class

\* only by car dealer



l kW

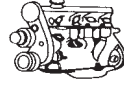

Cyl.

Order-  
No. No.Bic<sup>1)</sup> Order-  
D-Power No.**CITROEN**

AX 1.4i GT	1.4		07.92 - 06.95	TU3MC KDX	4	0,8	BCPR5ES	6130	32	BCPR5EIX	5688
AX 1.4i	1.4		07.92 - 06.95	TU3MC KDX	4	0,8	BCPR5ES	6130	32	BCPR5EIX	5688
AX 1.4 GTi	1.4		07.92 -	TU3J2 KFZ	4	0,8	BKR6EK	2288	20	BKR6EQUP	3199
AX 1.4i	1.4		07.95 -	TU3MC KDX	4	0,8	BKR6EK	2288	20	BKR6EQUP	3199
AX 1.4i Gti	1.4		09.91 - 12.92	TU3FJ2Z	4	0,8	BKR6EK	2288	20	BKR6EQUP	3199
AX 1.4	1.4		07.92 -	TU3M ... Cat.	4	0,8	BCPR5ES	6130	32	BCPR5EIX	5688
AX 1.4 GT	1.4		10.87 - 12.92	TU3S K2A	4	0,7	BGP6ES	4930	17	BCPR6EIX	5689
AX D	1.4	39	09.88 - 09.94	TUD 3 L	4	█	Y-911R	4544		D-POWER 33	4290
AX 1.4i	1.4	55	07.94 -	TU3FM	4	0,8	BKR6EK	2288	20	BKR6EQUP	3199
AX 1.4i	1.4	55	07.92 -	TU3MC Cat.	4	0,8	BKR6EK	2288	20	BKR6EQUP	3199
AX 1.4i GT	1.4	55	07.92 -	TU3FM Cat.	4	0,8	BKR6EK	2288	20	BKR6EQUP	3199
AX D	1.5	40	10.94 - 12.99	TUD 5 VJZ	4	█	Y-731U	5274		D-POWER 9	6281
Berlingo 1.1i	1.1	44	07.96 -	TU1M HDZ	4	0,8	BKR6EK	2288	20	BKR6EQUP	3199
Berlingo 1.4i	1.4	55	01.00 -	TU3JP KFX	4	0,9	BKR6EZ	4619		BKR6EIX	6418
Berlingo 1.4i	1.4	55	07.96 - 12.99	TU3JP-KFX,KFW	4	0,8	BKR6EK	2288	20	BKR6EQUP	3199
Berlingo 1.6i 16V	1.6	81	02.01 -	TU5JP4 NFU	4	0,9	LF6B	6677			
Berlingo	1.8	43	09.98 - 03.99	XUD7 A9A	4	█	Y-938R	5267		D-POWER 1	7906
Berlingo	1.8	43	07.96 - 08.98	XUD7 A9A	4	█	Y-923U	3380		D-POWER 1	7906
Berlingo	1.8	51	09.98 - 03.99	DW8 WJZ	4	█	Y-503R	4279		D-POWER 10	1009
Berlingo	1.8	66	09.98 - 03.99	DW8TD	4	█	Y-503R	4279		D-POWER 10	1009
Berlingo 1.8i	1.8	66	07.96 -	XU7JB LFX	4	0,8	BKR6EK	2288	20	BKR6EQUP	3199
Berlingo	1.9	51	07.96 - 09.98	XUD9A D9B / DJY	4	█	Y-923U	3380		D-POWER 1	7906
Berlingo	1.9	52	09.98 - 12.02	XUD9A	4	█	Y-938R	5267		D-POWER 1	7906
Berlingo HDI	2.0	66	10.99 -	DW10TD	4	█	Y-504R	4359		D-POWER 24	1441
Berlingo Multispace 1.4i	1.4	55	01.97 - 12.99	TU3JP KFX, KFW	4	0,8	BKR6EK	2288	20	BKR6EQUP	3199
Berlingo Multispace 1.4i	1.4	55	01.00 -	TU3JP KFX, KFW	4	0,9	BKR6EZ	4619		BKR6EIX	6418
Berlingo Multispace 1.6i	1.6	81	02.01 -	TU5JP4 NFU	4	0,9	LF6B	6677			
Berlingo Multispace 1.8i	1.8	66	07.97 -	XU7JB LFX	4	0,8	BKR6EK	2288	20	BKR6EQUP	3199
Berlingo Multispace	1.9	51	09.98 - 12.02	DW8 WJZ	4	█	Y-503R	4279		D-POWER 10	1009
Berlingo Multispace	1.9	51	01.97 - 09.98	XUD9A D9B / DJY	4	█	Y-923U	3380		D-POWER 1	7906
Berlingo Multispace HDI	2.0	66	10.99 -	DW10TD	4	█	Y-504R	4359		D-POWER 24	1441
BX 17 D	1.8	44	07.85 - 01.93	XUD 7	4	█	Y-902R	2237		D-POWER 1	7906
BX 17 TD, TRD	1.8	66	03.88 - 01.93	XUD 7 TE	4	█	Y-902R	2237		D-POWER 1	7906
BX 19 D TD, TRD	1.9	51	03.87 -	XUD 9 A/L	4	█	Y-902R	2237		D-POWER 1	7906
BX 4TC				N9TE	4	0,9	BP6ET	1263		PGR6D	6248
BX 14	1.4	47	09.82 - 06.88	XY6D	4	0,8	BP6EFS	3812	5		
BX 14	1.4	47	07.88 -	TU3.A	4	0,8	BCP5ES	7496	16	BCPR5EIX	5688
BX 14	1.4	47	09.82 - 06.88	XY6C	4	0,8	BP6EFS	3812	5		
BX 14	1.4	55		TU3M ...	4	0,8	BCPR5ES	6130	32	BCPR5EIX	5688
BX 15	1.5	59	07.87 - 06.92	XU5.1C	4	0,8	BCP5ES	7496	16	BCPR5EIX	5688
BX 16i Image, Millésime			07.92 -	XU5M BDY cat.	4	0,8	BCPR5ES	6130	32	BCPR5EIX	5688
BX 16 S, 16RS, 16TRS			07.84 - 03.88	XU5S 171C	4	0,8	BP6EFS	3812	5		
BX 16 16V	1.6		07.87 - 06.92	XU9.J4	4	0,8	BGP6ET	4563		BCPR6EIX	5689
BX 16 16V	1.6		07.92 -	XU9.J4 Cat.	4	0,9	BCPR6ET	2197		BCPR6EIX	5689
BX 16	1.6		07.92 -	XU5MZ BDZ Cat.	4	0,8	BCPR5ES	6130	32	BCPR5EIX	5688
BX 16	1.6	68	04.88 - 06.92	XU5.2C	4	0,7	BGP6ES	4930	17	BCPR6EIX	5689
BX 19i GTi 16s			07.92 -	XU9J4 DFW cat.	4	0,9	BCPR6ET	2197		BCPR6EIX	5689
BX 19i GTi 16s			07.87 - 06.92	XU9J4 D6C	4	0,8	BGP6ET	4563		BCPR6EIX	5689
BX 19i GTi, TRI, TZi / 4x4			07.86 - 06.92	XU9J2 D6A	4	0,7	BGP6ES	4930	17	BCPR6EIX	5689
BX 19i	1.9		07.92 -	XU9.JA DKZ Cat.	4	0,8	BCPR5ES	6130	32	BCPR5EIX	5688
BX 19i GTI	1.9		07.88 - 06.92	XU9.J2	4	0,7	BGP6ES	4930	17	BCPR6EIX	5689
BX 19	1.9	77	07.87 - 06.89	XU92C D2A	4	0,8	BCP5ES	7496	16	BCPR5EIX	5688

<sup>1)</sup> Bic = Best in class



ℓ kW

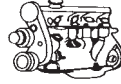

Cyl.

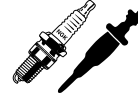
Order-  
No. No.Bic<sup>1)</sup> Order-  
D-Power No.**CITROEN**

<b>BX 19</b>	1.9	77	07.89 - 06.92	XU92C D2E	4	0,7	<b>BCP6ES</b>	<b>4930</b>	<b>17</b>	<b>BCPR6EIX</b>	<b>5689</b>
<b>BX 19</b>	1.9	77	07.87 - 06.89	XU92C	4	0,8	<b>BCP5ES</b>	<b>7496</b>	<b>16</b>	<b>BCPR5EIX</b>	<b>5688</b>
<b>BX 19</b>	1.9	77	07.89 - 06.92	XU92C	4	0,7	<b>BCP6ES</b>	<b>4930</b>	<b>17</b>	<b>BCPR6EIX</b>	<b>5689</b>
<b>C1</b>	1.0	50	06.05 -		4	1,1	<b>LFR6C-11</b>	<b>5788</b>			
<b>C1 Hdi</b>	1.4	40	05.06 -	DV4	4	█	<b>YE04</b>	<b>1101</b>		<b>D-POWER 40</b>	<b>1684</b>
<b>C1 Hdi</b>	1.4	50	06.05 -	DV4TD	4	█	<b>YE05</b>	<b>5207</b>			
<b>C2</b>	1.1	45	08.03 -	TU1JP	4	0,9	<b>BKR6EZ</b>	<b>4619</b>		<b>BKR6EIX</b>	<b>6418</b>
<b>C2 Hdi</b>	1.4	51	12.04 -	DV4TD	4	█	<b>YE05</b>	<b>5207</b>			
<b>C2</b>	1.4	55	08.03 -	TU3JP	4	0,9	<b>BKR6EZ</b>	<b>4619</b>		<b>BKR6EIX</b>	<b>6418</b>
<b>C2 16V</b>	1.6	81	08.03 -	TU5JP4	4	0,9	<b>LFR6B</b>	<b>6677</b>			
<b>C3</b>	1.1	44	04.02 -	TU1JP-HFZ;HFY	4	0,9	<b>BKR6EZ</b>	<b>4619</b>		<b>BKR6EIX</b>	<b>6418</b>
<b>C3 Hdi</b>	1.4	51	12.04 -	DV4TD	4	█	<b>YE05</b>	<b>5207</b>			
<b>C3 Hdi</b>	1.4	52	03.02 - 12.04	DV4TD	4	█	<b>YE04</b>	<b>1101</b>		<b>D-POWER 40</b>	<b>1684</b>
<b>C3 / Pluriel</b>	1.4	55	03 -	TU3JP	4	0,9	<b>BKR6EZ</b>	<b>4619</b>		<b>BKR6EIX</b>	<b>6418</b>
<b>C3 / Pluriel</b>	1.4	55	04.02 -	TU3JP-KFX	4	0,9	<b>BKR6EZ</b>	<b>4619</b>		<b>BKR6EIX</b>	<b>6418</b>
<b>C3</b>	1.4	66	10.03 -	ET3J4~KFU	4	0,8	<b>LZKAR7A</b>	<b>6799</b>			
<b>C3 Hdi</b>	1.4	68	12.04 - 08.05	DV4TED4	4	█	<b>YE05</b>	<b>5207</b>			
<b>C3 X-TR 16V</b>	1.4	68	04 - 12.04	DV4ETD4	4	█	<b>YE04</b>	<b>1101</b>		<b>D-POWER 40</b>	<b>1684</b>
<b>C3 HDi 16V</b>	1.4	68	03.02 - 12.04	DV4TED4	4	█	<b>YE04</b>	<b>1101</b>		<b>D-POWER 40</b>	<b>1684</b>
<b>C3 Hdi</b>	1.6	81	03.06 -	DV4TED6	4	█	<b>YE05</b>	<b>5207</b>			
<b>C3 / Pluriel 16V</b>	1.6	81	03 -	TU5JP4	4	0,9	<b>LFR6B</b>	<b>6677</b>			
<b>C3 / Pluriel</b>	1.6	81	04.02 -	TU5JP4-NFU	4	0,9	<b>LFR6B</b>	<b>6677</b>			
<b>C4 16V</b>	1.4	65	11.04 -	ET3J4~KFU	4	0,8	<b>LZKAR7A</b>	<b>6799</b>			
<b>C4 Coupé Hdi</b>	1.6	68	12.04 -		4	█	<b>YE04</b>	<b>1101</b>		<b>D-POWER 40</b>	<b>1684</b>
<b>C4 Picasso</b>	1.6	81	02.07 -	DV6TED4	4	█	<b>YE05</b>	<b>5207</b>			
<b>C4 Grand Picasso</b>	1.6	81	09.06 -	DV6TED4	4	█	<b>YE05</b>	<b>5207</b>			
<b>C4 Coupé Hdi</b>	1.6	81	12.04 - 06.06	DV6ETD4	4	█	<b>YE04</b>	<b>1101</b>		<b>D-POWER 40</b>	<b>1684</b>
<b>C4 16V</b>	1.6	81	11.04 -	TU5JP4~NFU	4	0,9	<b>LFR6B</b>	<b>6677</b>			
<b>C4 Hdi / Picasso</b>	1.6	81	03.07 -	DV6TED	4	█	<b>YE05</b>	<b>5207</b>			
<b>C4 16V</b>	2.0	100	11.04 -	EW10J4~RFN	4	0,9	<b>LFR6B</b>	<b>6677</b>			
<b>C4 Grand Picasso</b>	2.0	102	09.06 -	DW10TD	4	█	<b>Y-504R</b>	<b>4359</b>		<b>D-POWER 24</b>	<b>1441</b>
<b>C4 Picasso</b>	2.0	102	02.07 -	DW10TD	4	█	<b>Y-504R</b>	<b>4359</b>		<b>D-POWER 24</b>	<b>1441</b>
<b>C4 16V</b>	2.0	103	11.04 -	EW10A	4	0,9	<b>LFR5B</b>	<b>7113</b>			
<b>C4 GRAND PICASSO</b>	2.0	105	09.06 -	EW10A	4	0,9	<b>LFR5B</b>	<b>7113</b>			
<b>C4 PICASSO</b>	2.0	105	02.07 -	EW10A	4	0,9	<b>LFR5B</b>	<b>7113</b>			
<b>C5 Hdi</b>	1.6	81	03.06 -	DV6	4	█	<b>YE05</b>	<b>5207</b>			
<b>C5</b>	1.8	86	06.02 -	EW7J4 6FZ	4	0,9	<b>LFR5B</b>	<b>7113</b>			
<b>C5 Hdi</b>	2.0	66	06.02 -	DW10ATD	4	█	<b>Y-504R</b>	<b>4359</b>		<b>D-POWER 24</b>	<b>1441</b>
<b>C5 Hdi</b>	2.0	81	02.01 -	DW10ATED	4	█	<b>Y-504R</b>	<b>4359</b>		<b>D-POWER 24</b>	<b>1441</b>
<b>C5</b>	2.0	100	10.00 -	EW10J4-RFN	4	0,9	<b>LFR5B</b>	<b>7113</b>			
<b>C5</b>	2.0	105	09.04 -	EW10A	4	0,9	<b>LFR5B</b>	<b>7113</b>			
<b>C5 Hdi 16V</b>	2.2	100	02.01 -	DW12TED4	4	█	<b>Y-504R</b>	<b>4359</b>		<b>D-POWER 24</b>	<b>1441</b>
<b>C5 Hdi</b>	2.2	125	05.06 -	DW12BTED4	4	█	<b>YE08</b>	<b>4966</b>			
<b>C5</b>	3.0	154	10.00 -	ES9J4S XFX	6	1,1	<b>PLFR5A-11</b>	<b>6240</b>			
<b>C6 Hdi</b>	2.2	125	11.06 -	DW12BTED4	4	█	<b>YE08</b>	<b>4966</b>			
<b>C6 Hdi</b>	2.7	150	12.05 -	DT17	6	█	<b>YE12</b>	<b>7794</b>			
<b>C8 Hdi 16V</b>	2.0	80	07.02 -	DW10TED4/RHT	4	█	<b>Y-504R</b>	<b>4359</b>		<b>D-POWER 24</b>	<b>1441</b>
<b>C8</b>	2.0	102	06.02 -	EW10J4-RFN	4	0,9	<b>LFR5B</b>	<b>7113</b>			
<b>C8</b>	2.0	104	09.05 -	EW10A	4	0,9	<b>LFR5B</b>	<b>7113</b>			
<b>C8 Hdi 16V</b>	2.2	94	07.02 -	DW12TED4/4HW	4	█	<b>Y-504R</b>	<b>4359</b>		<b>D-POWER 24</b>	<b>1441</b>
<b>C8 HDI</b>	2.2	96	02 -	DW12	4	█	<b>Y-504R</b>	<b>4359</b>		<b>D-POWER 24</b>	<b>1441</b>
<b>C8</b>	2.2	118	06.02 -	EW12J4-3FZ	4	0,9	<b>LFR5B</b>	<b>7113</b>			

<sup>1)</sup> Bic = Best in class



l kW

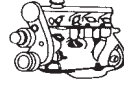

Cyl.

Order-  
No. No.Bic<sup>1)</sup> Order-  
D-Power No.**CITROEN**

C8 V6	3.0	150	10.02-	ES9J4S	6	1,1	PLFR5A-11	6240				
C15 D	1.8	44	06.95-	XUD7	4	█	Y-938R	5267		D-POWER 1	7906	
C15 D	1.8	44	10.84-05.95	XUD7	4	█	Y-902R	2237		D-POWER 1	7906	
C15 D	1.9	44	12.00-	DW8	4	█	Y-503J	1009		D-POWER 10	1009	
C15 E 1.0	1.0		11.86-09.88	XV8 108C	4	0,8	BP6EFS	3812	5			
C15 E	1.0		10.84-09.88	108C-109K	4	0,8	BP6EFS	3812	5			
C15 E	1.0	33	09.88-	TU9 C1A	4	0,8	BCP5ES	7496	16	BCPR5EIX	5688	
C15 E	1.1		10.88-	TU1 H1A	4	0,8	BCP5ES	7496	16	BCPR5EIX	5688	
C15 E	1.1		10.87-09.88	E1A	4	0,7	BCP6ES	4930	17	BCPR6EIX	5689	
C15 E	1.1	44	09.92-06.95	TU1.M HDZ Cat.	4	0,8	BCPR5ES	6130	32	BCPR5EIX	5688	
C15 E	1.3	47	10.87-09.88	G1A	4	0,8	BCP5ES	7496	16	BCPR5EIX	5688	
C15 E	1.4		10.87-	TU3A K1G	4	0,8	BCP5ES	7496	16	BCPR5EIX	5688	
C15E	1.1		07.95-	TU1M HDZ	4	0,8	BKR5EK	7956	23	BKR5EIX	6341	
C25 D	1.9	51	07.87-01.94	D9B	4	█	Y-902R	2237		D-POWER 1	7906	
C25	2.0	58	09.81-03.94	XM7T/XN1T/XN1TA	4	0,7	BP6ES	7811	4	BPR6EIX	6637	
C25 D	2.5	54	07.81-01.94	CRD93	4	█	Y-208T	1250				
C25 TD	2.5	70	08.87-01.94	CRD93LS	4	█	Y-208T	1250				
C 35 D	2.5	50	01.80-01.91	CRD93B	4	█	Y-208T	1250				
C45 D	2.5	50	06.82-01.91	CRD93B	4	█	Y-208T	1250				
C-Crosser Hdi	2.2	115	06.07-	DW12MTED4	4	█	YE08	4966				
CX Athena	2.0			J6RA / J6TA	4	0,8	BP6EFS	3812	5			
CX Reflex Break	2.0			J6RA / J6TA	4	0,8	BP6EFS	3812	5			
CX 2000 Break / Pallas	2.0			M20	4	0,6	BP6HS	4511	18	BPR6HIX	4085	
CX 2200 / 2400	2.2			M22 / M23	4	0,6	BP6HS	4511	18	BPR6HIX	4085	
CX 25 Turbo	2.5			M25/66	4	0,6	BP6HS	4511	18	BPR6HIX	4085	
CX 25 D	2.5	54	07.82-06.88	M25 660	4	█	Y-208T	1250				
CX 25	2.5	54	07.82-12.92	M25 660	4	█	Y-902R	2237		D-POWER 1	7906	
CX 25 TD Turbo 2	2.5	78	01.87-12.92	M25 669/671	4	█	Y-208T	1250				
Dispatch	1.9		09.98-	XUD9A, XUD9TF	4	█	Y-938R	5267		D-POWER 1	7906	
Dispatch	1.9		09.96-07.98	XUD9A, XUD9TF	4	█	Y-923U	3380		D-POWER 1	7906	
Dispatch	1.9		09.98-	DW8, DW8TD	4	█	Y-503R	4279		D-POWER 10	1009	
Dispatch	2.0		03.00-	DW10	4	█	Y-504R	4359		D-POWER 24	1441	
Evasion	1.8	72	09.96-06.00	XU7JP LFW	4	0,8	BKR5EK	7956	23	BKR5EIX	6341	
Evasion TD	1.9	66	03.94-08.98	XUD9TF	4	█	Y-923U	3380		D-POWER 1	7906	
Evasion	1.9	68	09.98-09.02	XUD9TF, XUD9BTF	4	█	Y-938R	5267		D-POWER 1	7906	
Evasion Hdi	2.0	81	09.98-09.02	DW10ATED	4	█	Y-504R	4359		D-POWER 24	1441	
Evasion	2.0	89	07.94-03.95	XU10J2 RFU	4	0,8	BCPR5ES	6130	32	BCPR5EIX	5688	
Evasion	2.0	90	04.95-05.00	XU10J2 RFU	4	0,8	BKR5EK	7956	23	BKR5EIX	6341	
Evasion	2.0	101	06.00-	EW10J4-RFR	4	0,9	LF5B	7113				
Evasion Turbo	2.0	110	09.94-05.00	XU10J2TE RGX	4	0,8	BKR6EK	2288	20	BKR6EQUIP	3199	
Evasion	2.0	110		XU10J2 CTE	4	0,8	BKR6EK	2288	20	BKR6EQUIP	3199	
Evasion TD	2.1	80	05.97-12.98	XUD11BTE	4	█	Y-938R	5267		D-POWER 1	7906	
Evasion TD	2.1	80	05.96-04.97	XUD11BTE	4	█	Y-923U	3380		D-POWER 1	7906	
GS 1015 / 1130 / 1220					4	0,7	BP6ES	7811	4	BPR6EIX	6637	
GS X2 / X3					4	0,7	BP6ES	7811	4	BPR6EIX	6637	
Jumper	1.9	52	06.95-	XUD9AU	4	█	Y-938R	5267		D-POWER 1	7906	
Jumper D	1.9	52	03.94-05.95	XUD9AU	4	█	Y-923U	3380		D-POWER 1	7906	
Jumper	1.9	68	09.98-	XUD9TF	4	█	Y-938R	5267		D-POWER 1	7906	
Jumper TD	1.9	68	03.94-08.98	XUD9TF	4	█	Y-923U	3380		D-POWER 1	7906	
Jumper Hdi	2.0	66	09.98-	DW10TD	4	█	Y-504R	4359		D-POWER 24	1441	
Jumper	2.0	81	-03.95	XU10.J2U RFW	4	0,8	BCPR6ES	2330	12	BCPR6EIX	5689	
Jumper	2.0	81	04.95-	XU10.J2U RFW	4	0,8	BKR6EK	2288	20	BKR6EQUIP	3199	

<sup>1)</sup> Bic = Best in class



ℓ kW

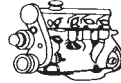

Cyl.

Order-  
No. No.Bic<sup>1)</sup> Order-  
D-Power No.**CITROEN**

Jumper HdI	2.2	74	04.02 -	DW12TED	4	█	Y-504R	4359		D-POWER 24	1441
Jumper HdI	2.2	76	09.98 -	DW10TED4	4	█	Y-504R	4359		D-POWER 24	1441
Jumper HdI	2.2	100	09.98 -	DW12TED4	4	█	Y-504R	4359		D-POWER 24	1441
Jumper D	2.5	63	03.94 -	DJ5	4	█	Y-923U	3380		D-POWER 1	7906
Jumper TD	2.5	76	03.94 - 08.96	DJ5T	4	█	Y-923U	3380		D-POWER 1	7906
Jumper Tdi	2.5	78	09.96 -	DJ5TED	4	█	Y-738U	5390			
Jumper HdI	2.8	93	09.00 - 04.02	4HY	4	█	Y-502R	3852			
Jumpy	1.6	59	10.95 -	1580 SPI 220.A2.000	4	0,8	BCPR7ES	3330		BCPR7EIX	5690
Jumpy HdI	1.6	66	02.07 -	DV6	4	█	YE05	5207			
Jumpy D	1.8	51	09.98 -	DW8	4	█	Y-503R	4279		D-POWER 10	1009
Jumpy D	1.9	51	01.96 - 08.98	XUD9A	4	█	Y-923U	3380		D-POWER 1	7906
Jumpy D	1.9	51	09.98 -	XUD9A	4	█	Y-938R	5267		D-POWER 1	7906
Jumpy D	1.9	51	09.98 -	DW8	4	█	Y-503R	4279		D-POWER 10	1009
Jumpy TD	1.9	68	01.96 - 08.98	XUD9TF/BTF	4	█	Y-923U	3380		D-POWER 1	7906
Jumpy TD	1.9	68	09.96 -	XUD9TF/BTF	4	█	Y-938R	5267		D-POWER 1	7906
Jumpy HdI	2.0	70	02.00 -	DW10TED	4	█	Y-504R	4359		D-POWER 24	1441
Jumpy HdI	2.0	81	02.00 -	DW10ATED	4	█	Y-504R	4359		D-POWER 24	1441
Jumpy HdI	2.0	90	02.07 -		4	█	YE05	5207			
Jumpy	2.0	102	06.01 -	EW10J4-RFN	4	0,9	LFR5B	7113			
Jumpy HdI	2.0	102	02.07 -		4	█	YE05	5207			
Jumpy	2.0	105	12.06 -	EW10A	4	0,9	LFR5B	7113			
Relay	1.9		03.94 - 08.98	XUD9TF, 9AU	4	█	Y-923U	3380		D-POWER 1	7906
Relay	1.9		09.98 -	XUD9TF	4	█	Y-938R	5267		D-POWER 1	7906
Relay	2.0		09.98 -	DW10TED/DU	4	█	Y-504R	4359		D-POWER 24	1441
Relay	2.5		03.94 -	DJ5, DJ5T	4	█	Y-923U	3380		D-POWER 1	7906
Relay	2.5		09.96 -	DJ5TED 12V	4	█	Y-738U	5390			
Saxo 1	1.0	37	02.96 - 09.99	TU9M CDZ	4	0,8	BKR5EK	7956	23	BKR5EIX	6341
Saxo 1	1.1	44	02.96 - 08.99	TU1M+ HDZ	4	0,8	BKR6EK	2288	20	BKR6EQUP	3199
Saxo 1	1.4	55	02.96 - 08.99	TU3JP+ KFX	4	0,8	BKR6EK	2288	20	BKR6EQUP	3199
Saxo 1	1.4	55	02.96 - 08.99	TU3JP KFW	4	0,9	BKR6EK	2288	20	BKR6EQUP	3199
Saxo 1	1.5	43	05.96 - 08.99	TUD 5	4	█	Y-731U	5274		D-POWER 9	6281
Saxo 1	1.6	66	07.98 - 08.99	TU5JP+ NFZ	4	0,8	BKR6EK	2288	20	BKR6EQUP	3199
Saxo 2	1.0	37	09.99 - 12.00	TU9M CDZ	4	0,8	BKR5EK	7956	23	BKR5EIX	6341
Saxo 2	1.1	44	09.99 -	TU1M+ HDZ	4	0,8	BKR6EK	2288	20	BKR6EQUP	3199
Saxo 2	1.1	44	06.00 -	TU1JP HFX	4	0,9	BKR6EZ	4619		BKR6EIX	6418
Saxo 2	1.4	55	09.99 -	TU3JP+ KFX	4	0,9	BKR6EZ	4619		BKR6EIX	6418
Saxo 2	1.4	55	09.99 -	TU3JP KFW	4	0,9	BKR6EZ	4619		BKR6EIX	6418
Saxo 2	1.5	43	09.99 - 05.03	TUD 5	4	█	Y-731U	5274		D-POWER 9	6281
Saxo 2	1.6	66	01.01 -	TU5JP NFT	4	0,9	BKR6EZ	4619		BKR6EIX	6418
Saxo 2	1.6	66	09.99 - 12.00	TU5JP+ NFZ	4	0,9	BKR6EZ	4619		BKR6EIX	6418
Saxo 2	1.6	88	03.01 - 04.02	TU5JP NFX	4	0,8	BKR6EK	2288	20	BKR6EQUP	3199
SM 3L / i					6	0,8	BP5ES	6511	8	BPR5EIX	6597
Synergie	1.9		10.95 - 08.98	XUD9BTF/L3	4	█	Y-923U	3380		D-POWER 1	7906
Synergie	1.9		09.98 - 10.00	XUD9TF, XUD9BTF	4	█	Y-938R	5267		D-POWER 1	7906
Synergie	2.0		08.99 -	DW10TED	4	█	Y-504R	4359		D-POWER 24	1441
Visa Special / Super			-03.91		4	0,8	BP6EFS	3812	5		
Visa 10			-03.91		4	0,8	BP6EFS	3812	5		
Visa Chrono				XYR	4	0,6	BR7EF	3346			
Visa 14				XY7	4	0,8	BP6EFS	3812	5		
Visa 11				XW7	4	0,8	BP6EFS	3812	5		
Visa GT				XY8	4	0,8	BP6EFS	3812	5		
Visa GTi		85	07.87 -	XU5.JA	4	0,7	BCP6ES	4930	17	BCPR6EIX	5689

<sup>1)</sup> Bic = Best in class



l kW

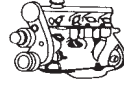

Cyl.

Order-  
No. No.Bic<sup>1)</sup> Order-  
D-Power No.**CITROEN**

Visa Club	0.6		-03.91		4	0,6	BP7EFS	3526				
Visa	0.6		-03.91	V06/...	4	0,8	BP6EFS	3812	5			
Visa 14TRS	1.4		-03.91	150D Cat.	4	0,8	BP6EFS	3812	5			
Visa 17 D	1.8	44	04.84 -03.91	161A	4	█	Y-902R	2237		D-POWER 1	7906	
Xantia	1.6	66	06.93 -05.95	XU5JP BFZ	4	0,8	BCPR5ES	6130	32	BCPR5EIX	5688	
Xantia	1.6	66	06.95 -	XU5JP BFZ	4	0,8	BKR5EK	7956	23	BKR5EIX	6341	
Xantia	1.8	66	01.98 -	XU7JB LFX	4	0,8	BKR6EK	2288	20	BKR6EQUIP	3199	
Xantia	1.8	76	07.93 -03.95	XU7JP LFZ	4	0,8	BCPR5ES	6130	32	BCPR5EIX	5688	
Xantia	1.8	76	04.95 -	XU7JP LFZ	4	0,8	BKR5EK	7956	23	BKR5EIX	6341	
Xantia 16V	1.8	82	07.95 -	XU7JP4 LFY	4	0,8	BKR5EK	7956	23	BKR5EIX	6341	
Xantia D	1.9	51	03.93 -01.96	XUD 9 A/L	4	█	Y-902R	2237		D-POWER 1	7906	
Xantia TDX	1.9	55		XUD9SD	4	█	Y-923U	3380		D-POWER 1	7906	
Xantia	1.9	55	09.98 -	XUD9A/L	4	█	Y-938R	5267		D-POWER 1	7906	
Xantia	1.9	55	05.94 -	XUD9A	4	█	Y-938R	5267		D-POWER 1	7906	
Xantia TD	1.9	68	06.93 -08.98	XUD9TF	4	█	Y-923U	3380		D-POWER 1	7906	
Xantia	1.9	68	09.98 -12.00	XUD9BTF, XUD9BSD	4	█	Y-938R	5267		D-POWER 1	7906	
Xantia Hdi	2.0	66	10.98 -	DW10TD	4	█	Y-504R	4359		D-POWER 24	1441	
Xantia Hdi	2.0	81	10.98 -12.01	DW10ATED	4	█	Y-504R	4359		D-POWER 24	1441	
Xantia	2.0	90	06.95 -	XU10J2 RFX	4	0,8	BKR5EK	7956	23	BKR5EIX	6341	
Xantia	2.0	90	03.93 -05.95	XU10J2 RFX	4	0,8	BCPR5ES	6130	32	BCPR5EIX	5688	
Xantia 16V	2.0	99	06.95 -	XU10J4R RFV	4	0,8	BKR5EK	7956	23	BKR5EIX	6341	
Xantia turbo	2.0	110	07.96 -	XU10J2TE RGX	4	0,8	BKR6EK	2288	20	BKR6EQUIP	3199	
Xantia 16V	2.0	112	93 -	XU10J4D	4	0,8	BKR6ES	3783	28	BKR6EIX	6418	
Xantia	2.1	80	09.98 -	XUD11BTF	4	█	Y-938R	5267		D-POWER 1	7906	
Xantia TD	2.1	80	06.95 -08.98	XUD11BTE	4	█	Y-923U	3380		D-POWER 1	7906	
Xantia	3.0	142	03.97 -	ES9J4 XFZ	6	0,8	BKR6EK	2288	20	BKR6EQUIP	3199	
XM	2.0		05.89 -12.92	XU102C-R2A	4	0,7	BCP6ES	4930	17	BCPR6EIX	5689	
XM 16V	2.0		07.94 -		4	0,8	BCPR6ES	2330	12	BCPR6EIX	5689	
XM	2.0		05.89 -12.92	XU10J2 R6A	4	0,8	BCPR6ES	2330	12	BCPR6EIX	5689	
XM	2.0		05.92 -12.00	XU10J2 RFZ Cat.	4	0,8	BCPR5ES	6130	32	BCPR5EIX	5688	
XM	2.0	99	07.94 -12.00	XU10J4R RFV	4	0,8	BKR5EK	7956	23	BKR5EIX	6341	
XM	2.0	110	96 -	XU10J2CTE	4	0,8	BKR6EK	2288	20	BKR6EQUIP	3199	
XM Turbo	2.0	110	11.92 -12.00	XU10J2TE RGX	4	0,8	BKR6EK	2288	20	BKR6EQUIP	3199	
XM	2.1	80	09.98 -12.00	XUD11ATE/L/BTE	4	█	Y-938R	5267		D-POWER 1	7906	
XM	3.0		05.89 -06.94	ZPJ-SFZ	6	0,9	BCPR6ET	2197		BCPR6EIX	5689	
XM V6 24V	3.0		07.94 -07.97	ZPJ4-UKZ	6	0,8	BCPR7ET	2164		BCPR7EIX	5690	
XM	3.0		07.94 -06.97	ZPJ-UFZ	6	0,9	BCPR6ET	2197		BCPR6EIX	5689	
XM V6 24V	3.0	140	01.97 -12.00	ES9J4-XFZ	6	0,8	BKR6EK	2288	20	BKR6EQUIP	3199	
XM D 12 D	2.1	60	05.89 -06.94	XUD11A/L	4	█	Y-902R	2237		D-POWER 1	7906	
XM D 12 TD	2.1	80	05.89 -08.98	XUD11ATE/L/BTE	4	█	Y-923U	3380		D-POWER 1	7906	
XM TD	2.5	96	07.94 -12.00	DK5ATE	4	█	Y-923U	3380		D-POWER 1	7906	
Xsara	1.4	55	09.97 -08.00	TU3JP KFX	4	0,8	BKR6EK	2288	20	BKR6EQUIP	3199	
Xsara	1.5	43	09.97 -08.00	TUD5	4	█	Y-731U	5274		D-POWER 9	6281	
Xsara	1.6	66	09.97 -08.00	TU5JP NFZ	4	0,8	BKR6EK	2288	20	BKR6EQUIP	3199	
Xsara	1.8	43	10.97 -09.00	XUD7	4	█	Y-938R	5267		D-POWER 1	7906	
Xsara	1.8	66	09.97 -08.00	XU7JB LFX	4	0,8	BKR6EK	2288	20	BKR6EQUIP	3199	
Xsara 16V	1.8	75	09.97 -08.00	XU7JP LFZ	4	0,8	BKR5EK	7956	23	BKR5EIX	6341	
Xsara 16V	1.8	82	09.97 -08.00	XU7JP4 LFY	4	0,8	BKR5EK	7956	23	BKR5EIX	6341	
Xsara	1.9	50	09.97 -09.00	XUD9A DJY	4	█	Y-938R	5267		D-POWER 1	7906	
Xsara	1.9	51	06.99 -08.00	DW8	4	█	Y-503R	4279		D-POWER 10	1009	
Xsara TD	1.9	66	10.97 -09.00	XUD9TE DHY	4	█	Y-938R	5267		D-POWER 1	7906	
Xsara Hdi	2.0	66	04.99 -08.00	DW10TD	4	█	Y-504R	4359		D-POWER 24	1441	

<sup>1)</sup> Bic = Best in class





ℓ kW

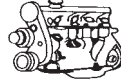

Cyl.

Order-  
No. No.Bic<sup>1)</sup> Order-  
D-Power No.**CITROEN**

Xsara 16V	2.0	120	09.97 - 08.00	XU10J4RS RFS	4	0,8	BKR6EK	2288	20	BKR6EQUIP	3199
Xsara 2 Hdi	1.4	51	12.04 -	DV4TD	4	█	YE05	5207			
Xsara 2 Hdi	1.4	51	02.03 - 12.04	DV4TD	4	█	YE04	1101		D-POWER 40	1684
Xsara 2	1.4	55	09.00 -	TU3JP KFW	4	0,9	BKR6EZ	4619		BKR6EIX	6418
Xsara 2	1.5	43	09.00 -	TUD5	4	█	Y-731U	5274		D-POWER 9	6281
Xsara 2 16V	1.6	81	09.00 -	TU5JP4-NFU	4	0,9	LFR6B	6677			
Xsara 2 16V	1.8	86	09.00 -	EW7J4 6FZ	4	0,9	LFR5B	7113			
Xsara 2	1.9	52	09.00 -	DW8 WJZ	4	█	Y-503R	4279		D-POWER 10	1009
Xsara 2 Hdi	2.0	66	09.00 - 12.02	DW10TD RHY	4	█	Y-504R	4359		D-POWER 24	1441
Xsara 2 Hdi	2.0	81	05.01 -	DW10ATED RHZ	4	█	Y-504R	4359		D-POWER 24	1441
Xsara 2 16V	2.0	101	09.00 -	EW10J4-RFN	4	0,9	LFR5B	7113			
Xsara 2 2.0i 16V VTS [167ch]	2.0	123	09.00 -	XU10J4RS RFS	4	0,9	BKR5EZ	7642		BKR5EIX	6341
Xsara Picasso	1.6	66	12.99 -	TU5JP NFZ, NFV	4	0,9	BKR6EZ	4619		BKR6EIX	6418
Xsara Picasso 1.8i 16V	1.8	86	12.99 -	EW7J4-6FZ	4	0,9	LFR5B	7113			
Xsara Picasso Hdi	2.0	66	01.00 -	DW10TD	4	█	Y-504R	4359		D-POWER 24	1441
Xsara Picasso Hdi	2.0	81	01.00 -	DW10TD	4	█	Y-504R	4359		D-POWER 24	1441
Xsara Picasso	2.0	101	09.00 -	EW10J4-RFM	4	0,9	LFR5B	7113			
ZX 1.0	1.0	44		TU1M	4	0,8	BKR5EK	7956	23	BKR5EIX	6341
ZX 1.1	1.1	40	03.91 - 06.92	TU1	4	0,8	BCP5ES	7496	16	BCPR5EIX	5688
ZX 1.1	1.1	44	07.92 - 03.96	TU1M HDZ	4	0,8	BCPR5ES	6130	32	BCPR5EIX	5688
ZX 1.1	1.1	44	04.96 -	TU1M	4	0,8	BKR5EK	7956	23	BKR5EIX	6341
ZX 1.1i	1.1	44	04.96 -	TU1M HDZ	4	0,8	BKR5EK	7956	23	BKR5EIX	6341
ZX 1.4	1.4	55	07.97 -	TU3JP-KFX	4	0,8	BKR6EK	2288	20	BKR6EQUIP	3199
ZX 1.4	1.4	55	07.92 - 06.97	TU3MC KDY Cat.	4	0,8	BKR6EK	2288	20	BKR6EQUIP	3199
ZX 1.4	1.4	55	03.91 - 12.92	TU32 K2C	4	0,8	BCP5ES	7496	16	BCPR5EIX	5688
ZX 1.4	1.4	55	03.91 - 06.97	TU3MC KDX	4	0,8	BCPR6ES	2330	12	BCPR6EIX	5689
ZX 1.4	1.4	55	07.97 -	TU3JP KFX	4	0,8	BKR6EK	2288	20	BKR6EQUIP	3199
ZX 1.6	1.6	65	03.91 - 06.93	XU5M BDY Cat.	4	0,8	BCPR5ES	6130	32	BCPR5EIX	5688
ZX 1.6	1.6	66	07.93 - 06.95	XU5JP Cat.	4	0,8	BCPR5ES	6130	32	BCPR5EIX	5688
ZX 1.6	1.6	66	07.95 - 07.98	TU5JP	4	0,8	BKR5EK	7956	23	BKR5EIX	6341
ZX 1.6i	1.6	66	07.93 - 06.95	XU5JP BFZ	4	0,8	BCPR5ES	6130	32	BCPR5EIX	5688
ZX 1.6i	1.6	66	07.95 - 07.98	XU5JP BFZ	4	0,8	BKR5EK	7956	23	BKR5EIX	6341
ZX 1.8 D	1.8	44	05.94 - 07.98	XUD7	4	█	Y-923U	3380		D-POWER 1	7906
ZX 1.8	1.8	76	07.95 -	XU7JP Cat.	4	0,8	BKR5EK	7956	23	BKR5EIX	6341
ZX 1.8	1.8	76	07.92 - 06.95	XU7JP LFZ	4	0,8	BCPR5ES	6130	32	BCPR5EIX	5688
ZX 1.8i	1.8	76	07.95 -	XU7JP LFZ	4	0,8	BKR5EK	7956	23	BKR5EIX	6341
ZX 1.8	1.8	82	07.97 -	XU7JP4 LFY	4	0,8	BKR5EK	7956	23	BKR5EIX	6341
ZX 1.9 D	1.9	38	05.94 - 07.98	XUD9A/L	4	█	Y-923U	3380		D-POWER 1	7906
ZX 1.9 TD	1.9	68	05.94 - 07.98	XUD9T/L	4	█	Y-938R	5267		D-POWER 1	7906
ZX 1.9	1.9	88	07.92 -	XU9JA DKZ Cat.	4	0,8	BCPR5ES	6130	32	BCPR5EIX	5688
ZX 1.9	1.9	96	03.91 - 06.92	XU9JA D6A	4	0,7	BCP6ES	4930	17	BCPR6EIX	5689
ZX 2.0	2.0	90	04.96 -	XU10J2C Cat.	4	0,8	BKR5EK	7956	23	BKR5EIX	6341
ZX 2.0	2.0	90	07.92 - 03.96	XU10J2C	4	0,8	BCPR5ES	6130	32	BCPR5EIX	5688
ZX 2.0i	2.0	90	04.96 -	XU10J2 RFX	4	0,8	BKR5EK	7956	23	BKR5EIX	6341
ZX 2.0i	2.0	90	07.92 - 03.96	XU10J2 RFX	4	0,8	BCPR5ES	6130	32	BCPR5EIX	5688
ZX 2.0	2.0	110	07.94 - 06.96	XU10J4D	4	0,8	BCPR6ES	2330	12	BCPR6EIX	5689
ZX 2.0	2.0	110	11.92 - 06.96	XU10J4D RFT Cat.	4	0,8	BKR6EK	2288	20	BKR6EQUIP	3199
ZX 2.0	2.0	110	07.96 -	XU10J4RS-RFS	4	0,9	BKR5EZ	7642		BKR5EIX	6341
ZX D	1.8	44	03.91 - 04.94	XUD 7 A9A	4	█	Y-902R	2237		D-POWER 1	7906
ZX D	1.9	47	03.91 - 04.94	XUD 9 A/L D9B	4	█	Y-902R	2237		D-POWER 1	7906
ZX TD	1.9	68	09.92 - 04.94	XUD 9 T/L D8A	4	█	Y-923U	3380		D-POWER 1	7906
ZX Reflex D	1.8	44	03.91 -	XUD 7 A9A	4	█	Y-902R	2237		D-POWER 1	7906

<sup>1)</sup> Bic = Best in class



ℓ kW

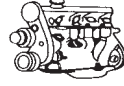

Cyl.

Order-  
No. No.Bic<sup>1)</sup> Order-  
D-Power No.**DACIA**

All models	1.2	40	01.77 -		4	0,6	BP6HS	4511	18	BPR6HIX	4085
All models	1.3	40	01.77 -		4	0,6	BP6HS	4511	18	BPR6HIX	4085
All models	1.4	47	01.77 -		4	0,6	BP6HS	4511	18	BPR6HIX	4085
Denem	1.4				4	0,6	BP6HS	4511	18	BPR6HIX	4085
Duster	1.4				4	0,6	BP6HS	4511	18	BPR6HIX	4085
Duster	1.6		92- 99		4	█	Y-908R	4585		D-POWER 1	7906
Logan 1.4MPI	1.4	55	09.04 -	K7J710	4	0,9	BKR6E	6962	28	BKR6EIX	6418
Logan 1.5dCi	1.5	50	05 -	K9K	4	█	Y-515J	1019		D-POWER 18	6892
Logan 1.6MPI	1.6	64	09.04 -	K7M710 engine by renault	4	0,9	BKR6E	6962	28	BKR6EIX	6418
Logan 1.6 16V	1.6	77	02.06 -	K4MA6	4	0,9	BKR6EZ	4619		BKR6EIX	6418

**DAEWOO**

Aranos	1.8	70	11.94 -	SOHC	4	0,9	BPR5ES	7422	6	BPR5EIX	6597
Aranos	2.0	81	11.94 -	SOHC	4	1,1	BPR5ES-11	4424		BPR5EIX-11	2115
Arcadia	3.2	158	09.93 -	V6	6	1,1	PFR6J-11	2743			
Brougham	2.0	85	09.91 - 12.95	C20LE Holden	4	1,1	BPR5ES-11	4424		BPR5EIX-11	2115
Cielo	1.5			SOHC	4	0,8	BPR6ES	7822	2	BPR6EIX	6637
Cielo	1.5			DOHC	4	1,1	BKR6E-11	2756	14	BKR6EIX-11	3764
Damas	0.8	28	10.91 - 04.93	F8CB Suzuki	3	0,9	BPR5ES	7422	6	BPR5EIX	6597
Espero	1.5	66	95 -	A15MF DOHC 16V	4	1,1	BKR6E-11	2756	14	BKR6EIX-11	3764
Espero	1.8	66	02.95 -	C18LE	4	0,8	BPR6ES	7822	2	BPR6EIX	6637
Espero	2.0	77	02.95 -	C20LE	4	0,8	BPR6ES	7822	2	BPR6EIX	6637
Evanda	2.0	96	03 - 02.05	T20SED	4	0,8	BKR5EK	7956	23	BKR5EIX	6341
Imperial	3.0	135	02.89 - 08.93	C30NE Opel	6	0,7	BPR6HS	7022	3	BPR6HIX	4085
Kalos 1.2 SE	1.2	53	04.03 - 02.05	B12S1	4	1,1	BPR5EY-11	3028		BPR5EIX-11	2115
Kalos 1.4 SE S100	1.4	61	09.02 - 02.05	F14S3	4	0,8	BPR6ES	7822	2	BPR6EIX	6637
Kalos 1.4 SE	1.4	61	04.03 - 02.05	F14S3 SOHC	4	0,8	BPR6ES	7822	2	BPR6EIX	6637
Kalos 1.4 SX	1.4	69	04.03 - 02.05	F14D3 DOHC	4	1,1	BKR6E-11	2756	14	BKR6EIX-11	3764
Korando TD	2.3	74	04.00 -		4	█	Y-916R	2785		D-POWER 6	5906
Korando	2.9		04.00 -		4	█	Y-916R	2785		D-POWER 6	5906
Korando TD, Cabriolet	2.9	88	04.00 -		5	█	Y-916R	2785		D-POWER 6	5906
Labo	0,8		97 -	SOHC	4	0,8	BPR6ES	7822	2	BPR6EIX	6637
Lacetti	1.4	68	09.03 - 02.05	F14D3	4	1,1	BKR6E-11	2756	14	BKR6EIX-11	3764
Lacetti	1.6	80	09.03 - 02.05	F16D3	4	1,1	BKR6E-11	2756	14	BKR6EIX-11	3764
Lacetti	1.8	90	09.03 - 02.05	T18SED	4	0,8	BKR5EK	7956	23	BKR5EIX	6341
Lanos	1.4	55	05.97 - 02.05	A14SMS SOHC	4	0,8	BPR6ES	7822	2	BPR6EIX	6637
Lanos	1.5	63	05.97 - 02.05	A15SMS SOHC	4	0,8	BPR6ES	7822	2	BPR6EIX	6637
Lanos	1.6	78	05.97 - 02.05	A16DMS DOHC	4	1,1	BKR6E-11	2756	14	BKR6EIX-11	3764
Leganza	2.0	100	07.97 -	X20SED DOHC	4	0,8	BKR5EK	7956	23	BKR5EIX	6341
Leganza	2.2		07.97 -	DOHC	4	0,8	BKR6EK	2288	20	BKR6EQUIP	3199
LeMans	1.5			DOHC	4	1,1	BKR6E-11	2756	14	BKR6EIX-11	3764
LeMans	1.5				4	0,8	BPR6ES	7822	2	BPR6EIX	6637
Matiz	0.8	38	06.98 - 02.05	F8CV	3	1,1	BPR5EY-11	3028		BPR5EIX-11	2115
Matiz	1.0	47	03.03 - 02.05	B10S	4	1,1	BPR5EY-11	3028		BPR5EIX-11	2115
Musso	2.0	100	09.96 -	M 161.940	4	0,8	BCP5ES	7496	16	BCPR5EIX	5688
Musso SLTD	2.3	74	04.00 -		4	█	Y-916R	2785		D-POWER 6	5906
Musso 16V	2.3	110	11.96 -	M 161.970	4	0,8	BCP5ES	7496	16	BCPR5EIX	5688
Musso	2.9		04.00 -		4	█	Y-916R	2785		D-POWER 6	5906
Musso SELTD	2.9	88	04.00 -		5	█	Y-916R	2785		D-POWER 6	5906
Musso E32	3.2	162	05.96 -	Mercedes M162990	6	0,8	BCP5ES	7496	16	BCPR5EIX	5688
New Brougham	2.0	85	01.96 - 02.97	SOHC	4	1,1	BPR5ES-11	4424		BPR5EIX-11	2115
New Brougham	2.0	106	01.96 - 02.97	DOHC 16V	4	0,8	BKR5EK	7956	23	BKR5EIX	6341

<sup>1)</sup> Bic = Best in class



ℓ kW

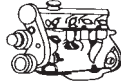

Cyl.

Order-  
No. No.Bic<sup>1)</sup> Order-  
D-Power No.**DAEWOO**

New Brougham	2.2	110	01.96 - 02.97	DOHC 16V	4	0,8	BKR5EK	7956	23	BKR5EIX	6341
New Prince	1.8	81	04.96 - 02.97	SOHC	4	1,1	BPR5ES-11	4424		BPR5EIX-11	2115
New Prince	1.8	101	04.96 - 02.97	DOHC 16V	4	0,8	BKR5EK	7956	23	BKR5EIX	6341
New Prince	2.0	85	04.96 - 02.97	SOHC	4	1,1	BPR5ES-11	4424		BPR5EIX-11	2115
New Prince	2.0	106	04.96 - 02.97	DOHC 16V	4	0,8	BKR5EK	7956	23	BKR5EIX	6341
Nexia	1.5	55	02.95 -	OHC	4	0,8	BPR6ES	7822	2	BPR6EIX	6637
Nexia	1.5	66	02.95 -	DOHC 16V	4	1,1	BKR6E-11	2756	14	BKR6EIX-11	3764
Nexia	1.8	74	12.95 - 10.96	C18LE SOHC	4	0,8	BPR6ES	7822	2	BPR6EIX	6637
Nubira	1.6	80	07.97 - 02.05	A16DMS DOHC	4	1,1	BKR6E-11	2756	14	BKR6EIX-11	3764
Nubira 1.8 CDX	1.8	90	03 - 02.05	T18SED	4	0,8	BKR5EK	7956	23	BKR5EIX	6341
Nubira	2.0	99	07.97 - 02.05	X20SED DOHC	4	0,8	BKR5EK	7956	23	BKR5EIX	6341
Racer	1.5		01.88 - 02.93		4	0,9	BPR5ES	7422	6	BPR5EIX	6597
Rexton 290 RX Td	2.9	87	05.02 -	Mercedes	5	█	Y-929U	6003		D-POWER 41	1749
Rezzo / Tacuma U100	1.6	77	01 - 02.05	A16DMS	4	1,1	BKR5E-11	6953	33	BKR5EIX-11	5464
Rezzo / Tacuma U100	2.0	89	01 - 02.05	T20SED	4	0,8	BKR5EK	7956	23	BKR5EIX	6341
Royal Duke	1.5	65	05.87 - 12.89		4	0,8	BPR6EY	6427		BPR6EIX	6637
Royal Prince i.	1.5	55	01.90 - 12.90		4	0,8	BPR6EY	6427		BPR6EIX	6637
Royal Prince	1.5	65	01.88 - 12.89		4	0,8	BPR6EY	6427		BPR6EIX	6637
Royal Prince i.	1.9	78	01.88 - 12.90		4	0,7	BPR6HS	7022	3	BPR6HIX	4085
Royal Prince i.	2.0	94	01.88 - 12.90		4	0,7	BPR6HS	7022	3	BPR6HIX	4085
Royal Salon i.	2.0	94	01.88 - 12.90		4	0,7	BPR6HS	7022	3	BPR6HIX	4085
Super Salon	2.0	81	09.91 - 12.95	C20LE Holden	4	1,1	BPR5ES-11	4424		BPR5EIX-11	2115
Tacuma	1.6		01 -	L4 DOHC	4	1,1	BKR6E-11	2756	14	BKR6EIX-11	3764
Tacuma	1.8		01 -	L4 SOHC	4	0,9	BPR5ES	7422	6	BPR5EIX	6597
Tacuma	2.0		01 -	L4 DOHC	4	0,8	BKR5EK	7956	23	BKR5EIX	6341
Tico	0.8			SOHC unleaded	3	1,1	BPR5EY-11	3028		BPR5EIX-11	2115
Tico	0.8	30		SOHC leaded	3	0,9	BPR5ES	7422	6	BPR5EIX	6597

**DAIHATSU**

55 WIDE	0.85				3	0,8	BPR6ES	7822	2	BPR6EIX	6637
550	0.55				3	0,8	BPR6ES	7822	2	BPR6EIX	6637
850	0.85				3	0,8	BPR5EY	2828	9	BPR5EIX	6597
850 Cab	0.85				4	0,8	BPR5EY	2828	9	BPR5EIX	6597
Applause A101	1.6	66		HD-E	4	0,9	BKR6E	6962	28	BKR6EIX	6418
Applause A101	1.6	73		HD-E EG	4		BKUR6EK	2213			
Applause A101	1.6	77		HD-E	4	0,9	BKR6E	6962	28	BKR6EIX	6418
Applause A111	1.6	77		HD-E	4	0,9	BKR6E	6962	28	BKR6EIX	6418
Bertone 184BE0	2.7	95		276KB	6	0,8	ZGR5A	5839	15		
Charade G11	1.0	38	83 -	CB22	3	0,8	BPR5EA-L	5823			
Charade G10	1.0	38	81 -	CB20	3	0,8	BPR5EA-L	5823			
Charade G100	1.0	38		CB23	3	1,1	BPR5EY-11	3028		BPR5EIX-11	2115
Charade G100	1.0	40		CB90	3	1,1	BPR5EY-11	3028		BPR5EIX-11	2115
Charade Turbo G11	1.0	50		CB60	3	0,8	BPR5EA-L	5823			
Charade Turbo G100	1.0	50		CB61 Cat	3	0,8	BPR5EA	5623			
Charade GTti G100	1.0	74	03.87 -	CB80	3	0,8	BPR6EKN	1128			
Charade G200	1.3	44		HC	4	1,1	BKR6E-11	2756	14	BKR6EIX-11	3764
Charade G200	1.3	55		HC	4	1,1	BKR6E-11	2756	14	BKR6EIX-11	3764
Charade G200	1.3	62		HC	4	1,1	BKR6E-11	2756	14	BKR6EIX-11	3764
Charade G102	1.3	66	07.91 -	HC-E	4	1,1	BKR6E-11	2756	14	BKR6EIX-11	3764
Charade G112 4WD	1.3	66	02.97 -	HC-E	4	1,1	BKR6E-11	2756	14	BKR6EIX-11	3764
Charade G203	1.5	55		HE	4	1,1	BKR6E-11	2756	14	BKR6EIX-11	3764
Charade G203	1.5	66		HE	4	1,1	BKR6E-11	2756	14	BKR6EIX-11	3764

<sup>1)</sup> Bic = Best in class



l kW

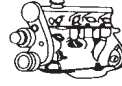

Cyl.

Order-  
No. No.Bic<sup>1)</sup> Order-  
D-Power No.**DAIHATSU**

Charade G201	1.6	77		HD-E	4	1,1	BKR6E-11	2756	14	BKR6EIX-11	3764
Charade CL10,60	1.0	27	86-	CL	4	■	Y-703R	3782			
Charade CL50	1.0		86-	CL	4	■	Y-703R	3782			
Charmant A35	1.3	48		4K OHV	4	0,8	BPR5EY	2828	9	BPR5EIX	6597
Charmant A45	1.6	55		2T OHV	4	0,9	BPR5ES	7422	6	BPR5EIX	6597
Charmant A60	1.6	60		4A-C Cat OHV	4	0,8	BPR5EY	2828	9	BPR5EIX	6597
Charmant A60	1.6	61		4A	4	0,8	BPR5EY	2828	9	BPR5EIX	6597
Copen L880K	0.66	50	04-	JB-DET	4	1,1	IFR6J-11	7658			
Copen	1.3	64	06-	K3-	4	1,1	IFR6J-11	7658			
Cuore L55	0.54	21		AB30	3	0,8	BPR6ES	7822	2	BPR6EIX	6637
Cuore L60	0.61	22		AD10	3	0,8	BPR6ES	7822	2	BPR6EIX	6637
Cuore L201	0.85	30		ED10	3	0,8	BPR6EY	6427		BPR6EIX	6637
Cuore L501	0.85	32	05.95-04.96	ED20	3	0,8	BPR6EY	6427		BPR6EIX	6637
Cuore L80	0.85	32		ED10	3	0,8	BPR6EY	6427		BPR6EIX	6637
Cuore L501	0.85	32	05.96-	ED20	3	1,1	BPR5EY-11	3028		BPR5EIX-11	2115
Cuore L701	1.0	40	06.98- 01	EJ-DE	3	1,1	BKR5E-11	6953	33	BKR5EIX-11	5464
Cuore L701	1.0	43	07.01-	EJ-VE	3	0,8	BKR5EKC	5216			
Cuore L251	1.0	43	05.03-	EJ-VE	3	0,8	BKR5EKC	5216			
Cuore 1.0 Top L276	1.0	52	09.07-	1KR-FE	3	1,1	ILFR6C11				
Delta				4Y	4	0,8	BP5EY	7327		BPR5EIX	6597
Delta Truck D			02.83-	DL40	4	■	Y-128T	7227			
Delta Truck D			08.77-	DG	4	■	Y-128T	7227			
Delta Truck D (3B)			02.83-	3 B	4	■	Y-147T	7493			
Delta Truck D (B)			02.83-	B	4	■	Y-147T	7493			
Domino					3	0,8	BPR6ES	7822	2	BPR6EIX	6637
Esse L245S	0.66		12.05-	KF-VE	3	0,9	LKR7C	4472			
Esse L235S	0.66		12.05-	KF-VE	3	0,9	LKR7C	4472			
Extol	1.3	63	07.00-	K3-VE	4	1,0	BKUR6ETB-10	5742			
Feroza F300	1.6	63	10.88-	HD-E	4	1,1	BKR6E-11	2756	14	BKR6EIX-11	3764
Feroza F300	1.6	70		HD-E	4	1,1	BKR6E-11	2756	14	BKR6EIX-11	3764
Fourtrak	2.0		86-		4	0,8	BPR5EY	2828	9	BPR5EIX	6597
Fourtrak	2.2		86-	DL52	4	0,8	BPR5EY	2828	9	BPR5EIX	6597
Fourtrak	2.8		84- 93	DL50	4	■	Y-146R	7492			
Fourtrak	2.8		10.89- 93	DL-T	4	■	Y-146R	7492			
Gran Move L901	1.0	40	10.99-	EJ-DE	3		BKUR6EK	2213			
Gran Move G303	1.5	66	04.97-	HE-EG	4	1,1	BKR6E-11	2756	14	BKR6EIX-11	3764
Gran Move G301	1.6	67	07.99-	HD-EP	4	1,1	BKR6E-11	2756	14	BKR6EIX-11	3764
Hijet S77/N				CL20	4	■	Y-146R	7492			
Hijet S77	0.9	33		CB41	3	0,8	BPR5EY	2828	9	BPR5EIX	6597
Hijet S76	0.9	33		CB41	3	0,8	BPR5EY	2828	9	BPR5EIX	6597
Hijet S75	0.9	33		CB41	3	0,8	BPR5EY	2828	9	BPR5EIX	6597
Hijet S85	0.9	33		CB41	3	0,8	BPR5EY	2828	9	BPR5EIX	6597
Hijet S86	0.9	33		CB41	3	0,8	BPR5EY	2828	9	BPR5EIX	6597
Hijet	1.0		86-	CB42	3	0,8	BPR5EY	2828	9	BPR5EIX	6597
Hijet	1.3	48	08.98-	HC-ES	4		BKUR6EK	2213			
Materia 1.3	1.3	67	07-	K3-VE	4		IKR7D	4759			
Materia 1.5	1.5	76	07-	3SZ-VE	4		IKR7D	4759			
Mira L235S	0.66		12.05-	KF-VE	3	0,9	LKR7C	4472			
Mira L245S	0.66		12.05-	KF-VE	3	0,9	LKR7C	4472			
Mira	0.85		93-		3	0,9	BPR6EY	6427		BPR6EIX	6637
Move L245S	0.66		12.05-	KF-VE	3	0,9	LKR7C	4472			
Move L235S	0.66		12.05-	KF-VE	3	0,9	LKR7C	4472			

<sup>1)</sup> Bic = Best in class



ℓ kW

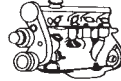

Cyl.

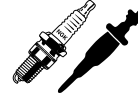
Order-  
No. No.Bic<sup>1)</sup> Order-  
D-Power No.**DAIHATSU**

Move L601	0.85	31	97-10.00	ED20	3	1,1	BPR5EY-11	3028		BPR5EIX-11	2115
Move L901	1.0	40	10.99-	EJ-DE	3		BKUR6EK	2213			
Piaggio-Hijet S85	0.9	33		CB41	3	0,8	BPR6EY	6427		BPR6EIX	6637
Rocky 4WD TD				DL42	4	█	Y-146R	7492			
Rocky F85	2.0	65		3Y	4	0,8	BP5EY	7327		BPR5EIX	6597
Rocky F80	2.0	65		3Y	4	0,8	BP5EY	7327		BPR5EIX	6597
Rocky 4WD	2.8		85-	DL40	4	█	Y-128T	7227			
Rocky 4WD D	2.8	54	85-	DL50	4	█	Y-146R	7492			
Rocky	2.8	67	12.87-04.93	DL51	4	█	Y-146R	7492			
Sirion (M100)(M110)	1.0	40	06.98- 00	EJ-DE	3		BKUR6EK	2213			
Sirion (M100)(M110)	1.0	43	05.00- 04	EJ-VE	3	0,8	BKR5EKC	5216			
Sirion (M300)	1.0	51	01.05-	1KR-FE	3	1,1	LFRC-11	5788			
Sirion (M300)	1.3	64	01.05-	K3-	4	1,1	IFR6J-11	7658			
Sirion (M101)(M111)	1.3	75	09.01- 04	K3-VE2	3	1,0	BKUR6ETB-10	5742			
Sirion (M301)	1.3	75	09.00- 04	K3-VE	4	1,1	IFR6J11	7658			
Sparcar S65	0.55	20		AB20	2	0,8	BPR5EY	2828	9	BPR5EIX	6597
Sportrak	1.6				4	1,1	BKR6E-11	2756	14	BKR6EIX-11	3764
Taft 4WD D			10.82-	DL40	4	█	Y-128T	7227			
Taft	1.6		82-		4	0,8	BPR5EAL	5823			
Terios 1.3	1.3		08-	K3-VE	4	1,1	BKR6EY-11	4368		BKR6EIX-11	3764
Terios 1.3 J100	1.3	61	09.97-	HC-EJ	4		BKUR6EK	2213			
Terios 1.3 J102	1.3	63	05.00-	K3-VE	4	1,0	BKUR6ETB-10	5742			
Terios 1.5	1.5	77	06-	3SZ-VE	4	0,8	IKR7C				
Trevis automatic	1.0	43	09.06-	EJ-DE	4	0,9	BKR6EKC	2848	26		
Trevis Schaltgetriebe / gearbox	1.0	43	09.06-	EJ-DE	4		BKUR6EK	2213			
Valèra	1.5	66	95-	HE-EG	4	1,1	BKR6E-11	2756	14	BKR6EIX-11	3764
Wildcat F10	0.95	30		FE	4	0,7	B6ES	7310			
Wildcat F25	1.6	48		12R	4	0,9	BPR5ES	7422	6	BPR5EIX	6597
Wildcat F20	1.6	48		12R	4	0,9	BPR5ES	7422	6	BPR5EIX	6597
Wildcat F85	2.0	65		3Y	4	0,8	BP5EY	7327		BPR5EIX	6597
Wildcat F80	2.0	65		3Y	4	0,8	BP5EY	7327		BPR5EIX	6597
YRV (M200)	1.0	43	08.00-	EJ-VE	4	0,8	BKR5EKC	5216			
YRV (M201)(M211)	1.3	64	01.01-	K3-VE	4	1,0	BKUR6ETB-10	5742			
YRV (M201)Turbo	1.3	95	02-	K3-VET	4	0,8	BKR6EP-8	2215		BKR6EIX	6418

**DAIMLER**

3.6 Litre	3.6	163	10.86-09.89	AJ6	6	0,8	BCPR6ES	2330	12	BCPR6EIX	5689
4.0 Litre	4.0	164	09.89-09.94	AJ6	6	0,8	BCPR6ES	2330	12	BCPR6EIX	5689
4.0 Super V8	4.0		09.97-03.00		8	1,3	PFR6G-13E	2341			
4.0 Super V8	4.0		03.00-03.02		8	1,1	PFR5G-11E	3000			
4.0 Super V8	4.0		03.02-		8	1,0	IFR5N10	7866			
4.0 V8	4.0		09.98-03.00		8	1,3	PFR5G-13E	2761			
4.0 V8	4.0		03.00-03.02		8	1,1	PFR5G-11E	3000			
4.0 V8	4.0		09.97-09.98		8	1,3	BKR5EVXA-13	1188			
4.0 V8	4.0		03.02-		8	1,0	IFR5N10	7866			
Century 4.0	4.0	180	10.95-09.96	AJ6	6	0,8	BCPR6ES	2330	12	BCPR6EIX	5689
Century 6.0	6.0		10.95-09.96	HE	12	0,6	BR6EF	3177			
Double Six			10.91- 93	HE	12	0,6	BR7EF	3346			
Double Six			86-09.91	HE	12	0,6	BR7EFS	1094			
Double Six	5.3		90-	V12 HE	12	0,6	BR7EFS	1094			
Double Six 6.0	6.0		93-	HE	12	0,6	BR7EF	3346			
Double Six	6.0				12	0,6	BR7EF	3346			

<sup>1)</sup> Bic = Best in class



ℓ kW

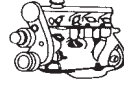

Cyl.

Order-  
No. No.Bic<sup>1)</sup> Order-  
D-Power No.**DAIMLER**

Double Six	6.0		02.93 - 09.94	HE	12	0,6	BR7EFS	1094				
Double six	6.0		09.94 - 09.97	HE	12	0,6	BR6EF	3177				
DS 420 Limousine	4.2		- 09.92	XK	6	0,8	BP5ES	6511	8	BPR5EIX	6597	
Six 4.0	4.0		09.94 - 09.97	AJ6	6	0,8	BCPR6ES	2330	12	BCPR6EIX	5689	
Sovereign 3.6	3.6		86 - 89			0,8	BCPR6ES	2330	12	BCPR6EIX	5689	
Sovereign 4.0	4.0		89 -			0,8	BCPR6ES	2330	12	BCPR6EIX	5689	
4.0 V8	4.0		09.97 - 09.98	AJ26	8	1,3	BKR5EVXA-13	1188				
4.0 V8	4.0		03.00 - 03.02	AJ26	8	1,1	PFR5G-11E	3000				
4.0 Super V8	4.0		03.00 - 03.02	AJ26	8	1,1	PFR5G-11E	3000				
4.0 V8	4.0		09.98 - 03.00	AJ26	8	1,3	PFR5G-13E	2761				
4.0 Super V8	4.0	267	09.97 - 03.00	V8	8	1,3	PFR6G-13E	2341				
4.2 Super V8	4.2		03.02 -	AJ26	8	1,0	IFR5N10	7866				
4.2 V8	4.2		03.02 -	AJ26	8	1,0	IFR5N10	7866				

**DODGE**

Avenger	2.0		95 - 99	L4 MPI Y DOHC	4	1,1	BKR6EVX-11	3540		BKR6EIX-11	3764	
Avenger	2.5		95 -	V6 MPI N DOHC	6	1,1	PFR5G-11	2647				
Charger SRT8	6.1		06 -	W V8 FI	8	1,3	LZTR5A-13	4306				
Colt	1.5		93 - 94	L4 MPI A	4	1,1	BPR5EVX-11	2738		BPR5EIX-11	2115	
Colt	1.8		92 - 94	L4 MPI C	4	1,1	BKR5EVX-11	5182		BKR5EIX-11	5464	
Colt	2.4		93 - 94	L4 MPI G	4	1,1	BKR6EVX-11	3540		BKR6EIX-11	3764	
Colt	2.4		92 - 92	L4 MPI W	4	1,1	BPR5EVX-11	2738		BPR5EIX-11	2115	
Intrepid	2.7		98 -	V6 MPI R DOHC	6	1,3	LZTR5A-13	4306				
Intrepid	3.3		94 - 95	V6 FF U	6	1,3	GR45	2822				
Intrepid	3.3		93 - 97	V6 MPI T	6	1,3	GR45	2822				
Intrepid	3.5		93 - 97	V6 MPI F	6	0,9	FR5-1	7252				
Magnum SRT8	6.1		06 -	W V8 FI	8	1,3	LZTR5A-13	4306				
Neon	2.0		95 - 99	L4 MPI Y DOHC	4	0,9	FR5	4876				
Neon	2.0		95 -	L4 MPI C SOHC	4	0,9	FR5	4876				
R1500-3500	3.9		97 - 99	MPI X	6	1,1	FR5-1	7252				
R1500-3500	3.9		94 - 96	MPI X	6	0,9	FR4	5188				
R1500-3500	5.2		97 - 99	CNG T	8	1,1	FR5-1	7252				
R1500-3500	5.2		97 - 99	MPI Y	8	1,1	FR5-1	7252				
R1500-3500	5.2		95 - 96	CNG T	8	0,9	FR4	5188				
R1500-3500	5.2		94 - 96	MPI Y	8	0,9	FR4	5188				
R1500-3500	5.9		98 - 99	MPI 5	8	1,1	FR5-1	7252				
R1500-3500	5.9		94 - 95	TBI 5	8	1,1	WR5	1071		WR5IX	7510	
R1500-3500	5.9		98 - 99	MPI Z	8	1,1	FR5-1	7252				
R1500-3500	5.9		94 - 97	MPI Z	8	0,9	FR4	5188				
R1500-3500	5.9		97 - 97	MPI 5	8	0,9	FR4	5188				
R1500-3500	8.0		94 - 96	MPI W	10	1,1	PZFR5F-11	4363				
R1500-3500	8.0		97 - 99	MPI W	10	1,1	PZFR5F-11	4363				
Stealth	3.0		91 - 92	V6 MPI B DOHC	6	1,1	PFR6J-11	2743				
Stealth	3.0		93 - 96	V6 MPI J DOHC	6	1,1	PFR6J-11	2743				
Stealth Turbo	3.0		93 - 96	V6 MPI K DOHC	6	1,1	PFR6J-11	2743				
Stealth	3.0		93 - 96	V6 MPI H SOHC	6	1,1	BPR5EVX-11	2738		BPR5EIX-11	2115	
Stealth Turbo	3.0		91 - 92	V6 MPI C DOHC	6	1,1	PFR6J-11	2743				
Stratus	2.0		95 -	L4 MPI C SOHC	4	0,9	FR5	4876				
Stratus	2.4		95 - 00	L4 MPI X DOHC	4	1,1	FR45	4636				
Stratus	2.4		04 -	L4 FI X,G	4	1,1	LZTR4A-11	5444				
Stratus	2.4		01 - 03	L4 FI X,G DOHC/TURBO	4	1,3	LZTR5A-13	4306				
Stratus	2.5		95 -	V6 MPI H DOHC	6	1,1	PFR5G-11	2647				

<sup>1)</sup> Bic = Best in class



ℓ kW

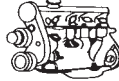

Cyl.

Order-  
No. No.Bic<sup>1)</sup> Order-  
D-Power No.**DODGE**

Viper	8.0		92 -	V10 MPI E	10	0,9	FR5-1	7252			
-------	-----	--	------	-----------	----	-----	-------	------	--	--	--

**DONKERVOORT**

D8 1.8 Turbo 20V	1.8	110		Audi	4	0,8	PFR6Q	6458			
------------------	-----	-----	--	------	---	-----	-------	------	--	--	--

**EAGLE**

Talon	2.0		95 - 99	L4 MPI Y	4	1,1	BKR6EVX-11	3540		BKR6EIX-11	3764
Talon Turbo	2.0		95 - 99	L4 MPI F	4	0,9	BPR6EVX	6764		BPR6EIX	6637

**FERRARI**

Challenge Stradale	3.6	313	01.04 -	F131B	8	0,7	PMR8B	6378			
Enzo	6.0	485	02 -	F140B	12	0,7	PMR8B	6378			
F208 GTB; GTS	2.0	187	04.86 - 10.90	F106N..		0,5	B95EGV	2145			
F328 GTB; GTS	3.2	199	01.88 - 09.89	F105CB..		0,6	D8EVX	2850			
F348 TB; TS	3.4	221	09.89 - 04.94	F119D040 Cat.		0,6	D8EVX	2850			
348 GTB; GTS	3.4	221	01.89 - 03.90	F119D		0,7	DCPR9EVX	6436		DCPR9EIX	2316
348 GTB; GTS	3.4	221	04.90 - 03.93	F119F		0,7	DCPR9EVX	6436		DCPR9EIX	2316
348 GTB; GTS	3.4	236	03.93 - 06.94	F119H		0,7	DCPR9EVX	6436		DCPR9EIX	2316
F348 GTB; GTS / Spider	3.9	221	07.94 - 07.95	F119		0,7	DCPR9EVX	6436		DCPR9EIX	2316
F355 Spider	3.5	280	07.95 -		8	0,7	PMR7A	4259			
F355GTS	3.5	280	05.94 - 01.96	F129B		0,7	PMR8A	5851			
F355 Berlinetta	3.5	280	07.94 -			0,6	CR8EVX	6487			
F355	3.5	280	05.94 - 01.96	F129C		0,7	PMR8A	5851			
F355GTS	3.5	280	02.96 -	F129C		0,7	PMR7A	4259			
F355 F1 berlinetta; GTS; Spider	3.5	280	11.97 -	F129C	8	0,7	PMR7A	4259			
Coupè 360 Modena/F1	3.6	294	12.03 -	F131B	8	0,7	PMR8B	6378			
360 Spider / F1	3.6	294	09.00 - 11.03	F131B	8	0,7	PMR8A	5851			
360 Spider / F1	3.6	294	12.03 -	F131B	8	0,7	PMR8B	6378			
Modena 360 - 360 F1	3.6	294	05.99 - 11.03	F131B	8	0,7	PMR8A	5851			
F40	2.9	353	01.88 - 05.92	F120A		0,5	C8E	7471			
F412	4.9	250	06.85 - 12.88	F101C.. - E..	12	0,6	BP8EVX	2671			
F430 / F430 Spider	4.3	360	01.05 -	F136E	8	0,7	PMR8B	6378			
F456 GTA	5.5	324	07.96 - 04.98	F116C.010	12	0,7	DCPR9EVX	6436		DCPR9EIX	2316
F456 GT	5.5	324	02.96 - 04.98	F116C	12	0,7	DCPR9EVX	6436		DCPR9EIX	2316
F456 GT	5.5	324	04.93 - 01.96	F116B	12	0,7	DCPR9EVX	6436		DCPR9EIX	2316
456 M GTA	5.5	325	05.98 -	F116C.010	12	0,7	DCPR9EVX	6436		DCPR9EIX	2316
465 M GT	5.5	325	05.98 -	F116C	12	0,7	DCPR9EVX	6436		DCPR9EIX	2316
F50	4.7	361	05.95 -	F130B	12	0,7	PMR7A	4259			
512 TR	5.0	316	02.91 - 10.96	F113D	12	0,7	DCPR9EVX	6436		DCPR9EIX	2316
F550 Maranello	5.5	357	08.96 -	F133A	12	0,7	DCPR9EVX	6436		DCPR9EIX	2316
F575 M Maranello / F1	5.7	379	02.02 - 06.06	F133E	12	0,7	DCPR9EVX	6436		DCPR9EIX	2316
F599 GBT	6.0	456	05.06 -	F140C	12	0,7	PMR8B	6378			
F612 Scaglietti /F1	5.7	397	09.04 -	F133E	12	0,7	DCPR9EVX	6436		DCPR9EIX	2316
Mondial T/ T Cabriolet	3.4	221	11.88 - 02.94	F119DL Cat		0,6	D8EVX	2850			
Testarossa	4.9	272	10.84 - 10.91	F113B000 Cat.	12	0,6	D8EVX	2850			

**FIAT**

126 (650)	0.65	22	01.83 - 06.96	141A.000		0,8	BPR6ES	7822	2	BPR6EIX	6637
126 BIS	0.7	19	09.87 - 06.91	126A2.000	2	0,8	BPR6ES	7822	2	BPR6EIX	6637
176 TD	1.7		06.93 -		4	█	Y-922R	4356		D-POWER 1	7906
500	1.2	52	07.07 -	169A4000	4	1,0	ZKR7A-10	1691			
500	1.4	74	07.07 -	169A3000	4	1,0	DCPR7EN-10	4983			

<sup>1)</sup> Bic = Best in class



ℓ kW

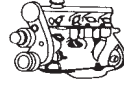

Cyl.

Order-  
No. No.Bic<sup>1)</sup> Order-  
D-Power No.**FIAT**

Barchetta	1.8	96	04.95 - 07.00	183A1.000	4	0,9	BKR6EK	2848	26	BKR6EIX	6418
Barchetta	1.8	96	08.00 -	183A1.000	4	0,9	BKR6EZ	4619		BKR6EIX	6418
Brava i.,80 16V Sx,Hsx	1.2	59	03.98 - 05.99	182B2.000	4	0,9	DCPR8EK	7168			
Brava ;80 16V; Trofeo,Steel Sx,Hsx	1.2	59	06.99 - 05.01	182B2.000	4	0,9	DCPR8E-N	5692			
Brava i. 12V	1.4	55	10.95 - 02.98	182A5.000	4	0,9	BKR6EK	2848	26	BKR6EIX	6418
Brava - 12V- S,SX	1.4	59	10.95 - 05.01	182A3.000	4	0,9	BKR6EK	2848	26	BKR6EIX	6418
Brava 16V	1.6	66	10.95 - 05.01	182A6.000	4	0,9	BKR6EK	2848	26	BKR6EIX	6418
Brava i.,100 16V;Aut. Sx,Hsx,Elx	1.6	76	05.98 - 06.99	182A4.000	4	0,9	BKR6EK	2848	26	BKR6EIX	6418
Brava i. 16V EL; aut. EL; ELX	1.6	76	10.95 - 06.96	182A4.000	4	0,9	BKR6EK	2848	26	BKR6EIX	6418
Brava 100 16V Sx,Hsx,Elx;Aut.	1.6	76	07.99 - 05.01	182A4.000	4	0,9	BKR5EZ	7642		BKR5EIX	6341
Brava 16V	1.8	83	10.95 - 05.01	182A2.000	4	0,9	BKR6EK	2848	26	BKR6EIX	6418
Brava 1,9 JTD	1.9	77	12.98 - 11.99	182B4.000	4	█	Y-747U	4951		D-POWER 26	4694
Brava/o JTD	1.9	77	12.99 - 12.01	182B4.000	4	█	Y-534J	5540		D-POWER 36	3413
Brava / Bravo D	2.0	74	09.95 - 07.96		4	█	Y-923U	3380		D-POWER 1	7906
Brava / Bravo D; TD	1.9	55	04.96 - 11.99		4	█	Y-928U	5700		D-POWER 29	4389
Brava / Bravo D	1.9	55	09.95 - 10.96	160A7.000	4	█	Y-920R	3645		D-POWER 1	7906
Bravo i.,80 16V Sx;Trofeo;Steel	1.2	59	03.98 - 05.99	182B2.000	4	0,9	DCPR8EK	7168			
Bravo 80 16V Sx Trofeo; Steel	1.2	59	06.99 - 05.01	182B2.000	4	0,9	DCPR8E-N	5692			
Bravo i. 12V	1.4	55	10.95 - 02.98	182A5.000	4	0,9	BKR6EK	2848	26	BKR6EIX	6418
Bravo 1.4i 12V S	1.4	59	03.98 - 05.01	182A3.000	4	0,9	BKR6EK	2848	26	BKR6EIX	6418
Bravo i. 16V	1.6	66	10.95 - 05.01	182A6.000	4	0,9	BKR6EK	2848	26	BKR6EIX	6418
Bravo i., 100 16V EL;Aut.	1.6	76	10.95 - 06.01	182A4.000	4	0,9	BKR6EK	2848	26	BKR6EIX	6418
Bravo i.100 16V El,Sx,GT,Steel; Aut.	1.6	76	07.99 - 05.01	182A4.000	4	0,9	BKR5EZ	7642		BKR5EIX	6341
Bravo 1.8L - 16V GT	1.8	83	03.95 - 05.01	182A2.000	4	0,9	BKR6EK	2848	26	BKR6EIX	6418
Bravo 1,9 JTD	1.9	77	12.98 - 11.99	182B4.000	4	█	Y-747U	4951		D-POWER 26	4694
Bravo i. 20V, 155 HGT	2.0	108	10.95 - 05.01	182A1.000	5	0,9	BKR6EK	2848	26	BKR6EIX	6418
Bravo 155 20V	2.0	113	12.99 - 05.01	182A1.000	4	0,9	BKR6EK	2848	26	BKR6EIX	6418
Bravo 1.4 16V	1.4	66	01.07 -	192B2000	4	1,0	DCPR7EN-10	4983			
Bravo 1.9 Multijet	1.9	88	01.07 -	939A1000	4	█	Y-534J	5540		D-POWER 36	3413
Cinquecento 700 ED	0.7	23	07.91 - 02.97	170A.000	2	0,8	BPR6ES	7822	2	BPR6EIX	6637
Cinquecento 900	0.9	29	02.95 - 05.98	1170 A1.046	4	0,8	BPR6ES	7822	2	BPR6EIX	6637
Cinquecento i S,SX,SUITE	0.9	29	07.95 - 12.99		4	0,8	BPR6ES	7822	2	BPR6EIX	6637
Cinquecento 900 -Van	0.9	29	04.96 - 05.98	1170.1046	4	0,8	BPR6ES	7822	2	BPR6EIX	6637
Cinquecento 900	0.9	30	92 - 05.98	170A1.046 Cat.	4	0,8	BPR6ES	7822	2	BPR6EIX	6637
Cinquecento	0.9	30	92 - 05.98	170A1.000	4	0,8	BPR6ES	7822	2	BPR6EIX	6637
Cinquecento	1.1	40	10.94 - 05.98	176B2.000	4	0,8	BCPR6ES	2330	12	BCPR6EIX	5689
Cinquecento Sporting Fire	1.1	40	94 - 05.98	176A6.000	4	0,8	BCPR6ES	2330	12	BCPR6EIX	5689
Cinquecento Sport	1.2	55	04.96 - 05.98	176B2.000	4	0,8	BCPR6ES	2330	12	BCPR6EIX	5689
Coupè 1.8L 16V	1.8	96	02.96 - 02.01	183A1.000	4	0,9	BKR6EK	2848	26	BKR6EIX	6418
Coupè 2.0L 16V	2.0	103	02.94 - 09.96	836A3.000	4	0,8	BPR7ES	2023	19	BPR7EIX	4055
Coupè 2.0L 20 V	2.0	108	10.96 - 02.01	182A1.000	5	0,9	BKR6EK	2848	26	BKR6EIX	6418
Coupè 2.0L 16V Turbo	2.0	140	02.94 - 09.96	175A1.000	4	0,8	BUR6ET	3172	1	PGR6D	6248
Coupè 2.0L 20V Turbo	2.0	162	- 12.96	175A3.000	5	0,9	BKR6EK	2848	26	BKR6EIX	6418
Coupè 2.0L 20V Turbo	2.0	162	10.96 - 02.01	175A3.000	5	0,8	BKUR6ET	6437	27	PFR6Q	6458
Croma CHT- 1.6L	1.6	61	12.85 - 06.90	154A0..48	4	0,8	BPR7ES	2023	19	BPR7EIX	4055
Croma Turbo D	1.9	66	03.88 - 06.90	154 B	4	█	Y-739R	6639			
Croma TD (TDId)	1.9	69	07.90 - 98	154 C6.000; 154 D 1.000	4	█	Y-739R	6639			
Croma 2.0L	2.0	66	86 - 91	154.C2.000	4	0,8	BPR7ES	2023	19	BPR7EIX	4055
Croma CHT- 2.0L	2.0	72	91 - 02.97	154.C5.000	4	0,8	BPR7ES	2023	19	BPR7EIX	4055
Croma 2.0L	2.0	84	86 - 02.97	834.B.146	4	0,8	BPR7ES	2023	19	BPR7EIX	4055
Croma 2.0L - .S	2.0	85	04.95 - 99		4	0,8	BPR7ES	2023	19	BPR7EIX	4055
Croma 2.0L	2.0	85	07.91 - 02.97	154C3.046 Cat.	4	0,8	BPR7ES	2023	19	BPR7EIX	4055

<sup>1)</sup> Bic = Best in class





ℓ kW

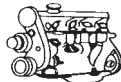

Cyl.

Order-  
No. No.Bic<sup>1)</sup> Order-  
D-Power No.

FIAT											
Croma I 2.0L	2.0	86	91 - 02.97	154.C3.000	4	0,8	BPR7ES	2023	19	BPR7EIX	4055
Croma 2.0L	2.0	89	86 - 91	154C.000	4	0,8	BPR7ES	2023	19	BPR7EIX	4055
Croma 2.0L - 16V	2.0	101	04.95 - 06.00		4	0,8	BPR7ES	2023	19	BPR7EIX	4055
Croma 16V- 2.0L	2.0	101	91 - 02.97	154E1.000	4	0,8	BPR7ES	2023	19	BPR7EIX	4055
Croma Ti Turbo	2.0	110	86 - 02.97	834.C.146	4	0,8	BP6ET	1263			
Croma Ti Turbo	2.0	110	86 - 02.97	154.C4.000	4	0,8	BP6ET	1263			
Croma Turbo	2.0	110	91 - 02.97	154C4.046 /Cat.	4	0,8	BP6ET	1263			
Croma Turbo 2.0L	2.0	110	04.95 - 06.00		4	0,8	BUR6ET	3172	1	PGR6D	6248
Croma Turbo	2.0	114	86 - 02.97	154.A2.000	4	0,8	BP6ET	1263			
Croma D	2.5	55	12.85 - 12.89	8144.67	4	█	Y-902R	2237		D-POWER 1	7906
Croma TD	2.5	74	12.85 - 02.89	8144.91.200	4	█	Y-908R	4585		D-POWER 1	7906
Croma Td	2.5	85	02.89 - 12.92	8144.97.200/.2200	4	█	Y-908R	4585		D-POWER 1	7906
Croma TD	2.5	85	01.94 - 99		4	█	Y-926U	7119			
Croma	2.5	90	01.93 - 12.93		4	█	Y-914U	2643		D-POWER 1	7906
Croma 2.5L	2.5	90	01.94 - 98		4	█	Y-914U	2643		D-POWER 1	7906
Croma V6- 2.5L	2.5	117	93 - 02.97	834G.000	6	0,8	BPR7ES	2023	19	BPR7EIX	4055
Croma V6- 2.5L	2.5	117	04.95 - 99		6	0,8	BPR7ES	2023	19	BPR7EIX	4055
Doblò	1.2	48	12.04 - 02.05	223A5.000	4	1,0	DCPR7EN-10	4893			
Doblò	1.2	48	11.00 - 12.04	223A5.000	4	0,9	BKR5EZ	7642		BKR5EIX	6341
Doblò	1.4	57	09.05 -	350A1.000	4	1,0	ZKR7A-10	1691			
Doblò 1.6	1.6	76	11.00 - 06.05	182B6.000	4	0,9	BKR5EZ	7642		BKR5EIX	6341
Doblò Natural Power Active	1.6	76	11.00 -	182B6.000	4	0,9	BKR6EKC	2848	26	BKR6EIX	6418
Doblò JTD	1.9	77	01.04 -	182B9000	4	█	Y-534J	5540		D-POWER 36	3413
Ducato 10	1.8	49	09.81 - 12.90	XM7T/ 169B XM	4	0,7	BP6ES	7811	4	BPR6EIX	6637
Ducato 14	2.0	55	01.86 - 01.94	170BXN1T/170DXN 1TA	4	0,7	BP6ES	7811	4	BPR6EIX	6637
Ducato 10	2.0	62	06.88 -	170D XN 1TA	4	0,7	BP6ES	7811	4	BPR6EIX	6637
Ducato 18 Maxi	2.0	62	06.86 - 06.90	170C XN 1TA	4	0,7	BP6ES	7811	4	BPR6EIX	6637
Ducato 10-14 Maxi	2.0	80	01.94 -	RFW	4	0,7	BP6ES	7811	4	BPR6EIX	6637
Ducato TD	2.5	68	01.86 - 02.94		4	█	Y-908R	4585		D-POWER 1	7906
Ducato (230) 2,8D	2.8	64	02.98 -			█	Y-502R	3852			
Ducato 10D D	1.9	51	03.94 -		4	█	Y-914U	2643		D-POWER 1	7906
Ducato 10TD	1.9	59	03.94 -	Kat.	4	█	Y-922R	4356		D-POWER 1	7906
Ducato 10TD	1.9	60	03.94 -		4	█	Y-914U	2643		D-POWER 1	7906
Ducato 10 D	2.0	52	02.87 -	149 B1.000	4	█	Y-902R	2237		D-POWER 1	7906
Ducato 10 TD	2.0	60	01.90 - 02.94	280 A1.000	4	█	Y-914U	2643		D-POWER 1	7906
Ducato 10 D	2.5	53	01.86 - 02.94	8144.67	4	█	Y-908R	4585		D-POWER 1	7906
Ducato 14 TD	1.9	60	01.90 - 02.94	280 A 1.000	4	█	Y-914U	2643		D-POWER 1	7906
Ducato 14 D	2.4		01.86 - 02.94		4	█	Y-908R	4585		D-POWER 1	7906
Ducato 14 TD	2.4	68	01.86 - 02.94	8144.21.220	4	█	Y-908R	4585		D-POWER 1	7906
Ducato 14 D	2.5	55	01.86 - 02.94	8144.67.220	4	█	Y-908R	4585		D-POWER 1	7906
Ducato 14 D 4x4	2.5	55	01.89 - 02.94	8144.67.220	4	█	Y-908R	4585		D-POWER 1	7906
Ducato 14 TD	2.5	62	03.94 -	8140.67.2200	4	█	Y-935U	5915		D-POWER 23	4791
Ducato 14 TD 4x4	2.5	68	01.89 - 02.94	8144.21.220	4	█	Y-914U	2643		D-POWER 1	7906
Ducato 14 TDi	2.5	81	03.94 -	8140.47.2280 Kat.		█	Y-935U	5915		D-POWER 23	4791
Ducato 14 Di	2.5	85	03.94 -	8140.47.2200		█	Y-935U	5915		D-POWER 23	4791
Ducato 18 Maxi D	2.5	55	01.86 - 02.94			█	Y-935U	5915		D-POWER 23	4791
Ducato 18 Maxi TD	2.5	68	01.86 - 02.94	8144.21.220	4	█	Y-908R	4585		D-POWER 1	7906
Duna 60 / 60 Weekend	1.1	43	10.86 - 12.90	146A6	4	0,8	BPR6ES	7822	2	BPR6EIX	6637
Duna 70 / 70 Weekend	1.3	48	10.86 - 12.90	146A5	4	0,8	BPR6ES	7822	2	BPR6EIX	6637
Duna DS D	1.7	44	10.86 - 12.90		4	█	Y-902R	2237		D-POWER 1	7906
Fiorino D	1.3	33	06.90 - 08.93	146 B1.000	4	█	Y-902R	2237		D-POWER 1	7906
Fiorino	1.4	51	01.93 -	160.A1.046	4	0,9	BPR5ES	7422	6	BPR5EIX	6597

<sup>1)</sup> Bic = Best in class



ℓ kW

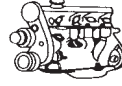

Cyl.

Order-  
No. No.Bic<sup>1)</sup> Order-  
D-Power No.**FIAT**

Fiorino	1.5	55	01.90 - 08.93	149C1.000 Cat.	4	0,8	BPR6ES	7822	2	BPR6EIX	6637
Fiorino D	1.7	42	01.88 -	149 B4.046	4	█	Y-902R	2237		D-POWER 1	7906
Fiorino D	1.7	43	12.87 -	149 B3.000	4	█	Y-902R	2237		D-POWER 1	7906
Grande Punto	1.2	48	09.05 -	199A4000	4	1,0	ZKR7A-10	1691			
Grande Punto	1.4	57	09.05 -	350A1000	4	1,0	ZKR7A-10	1691			
Grande Punto 16V	1.4	70	09.05 -	199A6000	4	1,0	ZKR7A-10	1691			
Grande Punto	1.9	88	09.05 -	939A1000	4	█	Y-543J	6600		D-POWER 46	5618
Grande Punto	1.9	96	09.05 -	199A500	4	█	Y-543J	6600		D-POWER 46	5618
Idea	1.2	59	02.05 -	188A5.000	4	1,0	DCPR7EN-10	4893			
Idea 1.4	1.4	57	09.05 -	350A1.000	4	1,0	ZKR7A-10	1691			
Idea 16V	1.4	70	10.03 - 02.05	843A1.000	4	0,9	DCPR7E-N	4795		DCPR7EIX	6046
Idea	1.4	70	02.05 -	843A1.000	4	1,0	DCPR7EN-10	4893			
Marea i.;80 16V ,Weekend	1.2	59	03.98 - 05.99	182B2.000	4	0,9	DCPR8EKC	7168			
Marea 80 16V Sx,Hsx; Weekend	1.2	60	12.98 - 12.00	182B2.000	4	0,9	DCPR8E-N	5692			
Marea i. 12 V; Weekend	1.4	55	10.96 - 02.98	182A3.000	4	0,9	BKR6EKC	2848	26	BKR6EIX	6418
Marea 16V Sx,Elx,Aut., Weekend	1.6	76	05.98 - 11.98	182A4.000	4	0,9	BKR5EZ	7642		BKR5EIX	6341
Marea i. 16V Sx Bipower	1.6	76	11.97 - 12.03	182A4.000	4	0,9	BKR6EKC	2848	26	BKR6EIX	6418
Marea i. 16V; Weekend	1.6	76	09.96 - 04.98	182A4.000	4	0,9	BKR6EKC	2848	26	BKR6EIX	6418
Marea 100 16V,Sx,Elx,Aut., Weekend	1.6	76	12.98 - 12.03	182A4.000	4	0,9	BKR5EZ	7642		BKR5EIX	6341
Marea i. 16 V, Weekend	1.8	83	09.96 - 11.98	182A2.000	4	0,9	BKR6EKC	2848	26	BKR6EIX	6418
Marea 115 16V; Weekend	1.8	83	12.99 - 01.01	182A2.000	4	0,9	BKR6EKC	2848	26	BKR6EIX	6418
Marea	1.9	55	09.96 - 12.00	182 A8.000	4	█	Y-928U	5700		D-POWER 29	4389
Marea	1.9	74	09.96 - 12.00	182 A7.000	4	█	Y-928U	5700		D-POWER 29	4389
Marea JTD	1.9	77	12.98 - 11.99	186 A6.000	4	█	Y-747U	4951		D-POWER 26	4694
Marea JTD / Marengo	1.9	80	12.99 - 12.02	186 A6.000	4	█	Y-534J	5540		D-POWER 36	3413
Marea i. 155 20 V Weekend	2.0	108	10.96 - 12.03	182 A1.000	5	0,9	BKR6EKC	2848	26	BKR6EIX	6418
Marea 20V	2.0	108	09.96 - 11.98	182 A1.000	5	0,9	BKR6EKC	2848	26	BKR6EIX	6418
Marea	2.4	91	09.96 - 12.00	185 A2.000	5	█	Y-928U	5700		D-POWER 29	4389
Marea JTD	2.4	96	03.99 - 11.99	185 A6.000	5	█	Y-747U	4951		D-POWER 26	4694
Marengo D	1.9	48	01.92 -	160 A 7.000	4	█	Y-902R	2237		D-POWER 1	7906
Marengo D	1.9	66	01.92 -	160 A 6.000	4	█	Y-902R	2237		D-POWER 1	7906
Marengo TD	1.9	66	01.92 -	160 A 6.000	4	█	Y-902R	2237		D-POWER 1	7906
Marengo D	2.0	48	01.86 - 07.89		4	█	Y-902R	2237		D-POWER 1	7906
Marengo D	2.5	53	05.80 - 07.89	8144.61	4	█	Y-208T	1250			
Multipia 100 16V Bluepower	1.6	70	01.99 - 12.04	186 A3.000	4	0,9	BKR6EKC	2848	26	BKR6EIX	6418
Multipia 100 16V Sx	1.6	76	07.99 - 12.04	186 A4.000	4	0,9	BKR5EZ	7642		BKR5EIX	6341
Multipia Nat Power	1.6	76	09.04 -	182B4.000	4	0,9	BKR6EKC	2848	26	BKR6EIX	6418
Multipia 100 16V Bipower	1.6	76	01.99 - 12.04	186 A4.000	4	0,9	BKR6EKC	2848	26	BKR6EIX	6418
Multipia	1.6	76	09.04 -	182B6.000	4	0,9	BKR5EZ	7642		BKR5EIX	6341
Multipia 100 16V Sx	1.6	76	01.99 - 06.99	186 A4.000	4	0,9	BKR6EKC	2848	26	BKR6EIX	6418
Multipia JTD	1.9	77	11.98 - 11.99	182B4.000	4	█	Y-747U	4951		D-POWER 26	4694
Multipia JTD	1.9	81	11.98 - 11.99	182B4.000	4	█	Y-747U	4951		D-POWER 26	4694
Multipia JTD	1.9	85	12.99 -	182B4.000	4	█	Y-534J	5540		D-POWER 36	3413
Palio 8V	1.2	44	01.01 -	188A4.000	4	0,9	BKR5EZ	7642		BKR5EIX	6341
Palio 65 1.2L	1.2	50	01.00 - 12.00	178 E2.000	4	0,9	BKR6EKC	2848	26	BKR6EIX	6418
Palio 75 Weekend	1.2	54	11.97 - 12.00	178B5.000	4	0,9	BKR6EKC	2848	26	BKR6EIX	6418
Palio 16V	1.2	59	09.01 - 11.02	188 A5.000	4	0,9	DCPR8E-N	5692			
Palio 16V	1.2	59	12.02 -	188 A5.000	4	0,9	DCPR7E-N	4795		DCPR7EIX	6046
Palio 1.4L	1.4	51	09.97 -	178 B2.000	4	0,9	BKR5EZ	7642		BKR5EIX	6341
Palio 1.6L 16V	1.6	74	96 - 06.99		4	0,9	BKR6EKC	2848	26	BKR6EIX	6418
Palio 100 16V Weekend	1.6	76	11.97 - 06.99	178B3.000	4	0,9	BKR6EKC	2848	26	BKR6EIX	6418
Palio 100 16V Weekend	1.6	76	07.99 -	178B3.000	4	0,9	BKR5EZ	7642		BKR5EIX	6341

<sup>1)</sup> Bic = Best in class



ℓ kW

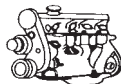

Cyl.

Order-  
No. No.Bic<sup>1)</sup> Order-  
D-Power No.

FIAT											
Palio TD	1.7	51	97 -		4	█	Y-922R	4356		D-POWER 1	7906
Panda 750 CLX -CL-L- Fire	0.75	24	01.86 - 12.96	156A...	4	0,8	BCPR6ES	2330	12	BCPR6EIX	5689
Panda 750 Young	0.75	25	01.86 - 12.96	141B000	4	0,8	BPR6ES	7822	2	BPR6EIX	6637
Panda 900	0.9	29	- 12.96	1170A1.046	4	0,8	BPR6ES	7822	2	BPR6EIX	6637
Panda 900- Jolly-Van	0.9	29	01.97 - 01.01	1170 A1.046	4	0,9	BKR5EZ	7642		BKR5EIX	6341
Panda i.	0.9	29	01.96 - 01.01		4	0,8	BPR6ES	7822	2	BPR6EIX	6637
Panda 45 / 45 S / 4x4	0.9	33	- 12.96	146A..	4	0,8	BPR6ES	7822	2	BPR6EIX	6637
Panda	1,1	40	09.00 -	187A1.000	4	0,9	BKR5EZ	7642		BKR5EIX	6341
Panda 1000	1.0	32	01.86 - 04.96	156A2.048-156A2.146/246	4	0,8	BCPR6ES	2330	12	BCPR6EIX	5689
Panda Van	1.0	33	01.97 -	141C2.000	4	0,9	BKR6EKC	2848	26	BKR6EIX	6418
Panda - 1.0 L- young-L- CLX	1.0	33	06.94 - 12.97	141C2.000	4	0,8	BPR6ES	7822	2	BPR6EIX	6637
Panda 1100 Selecta	1.1	37	07.90 - 12.96	156C.046 Cat.	4	0,8	BCPR6ES	2330	12	BCPR6EIX	5689
Panda 1100	1.1	40	02.95 - 12.96	176B2.000	4	0,8	BCPR6ES	2330	12	BCPR6EIX	5689
Panda 4X4	1.1	40	01.96 - 08.00	156C046	4	0,8	BCPR6ES	2330	12	BCPR6EIX	5689
Panda 4x4	1.1	40	02.95 - 12.96	176B2.000	4	0,8	BCPR6ES	2330	12	BCPR6EIX	5689
Nuova Panda	1.1	40	09.03 - 12.04	187A1.000	4	0,9	BKR5EZ	7642		BKR5EIX	6341
Nuova Panda	1.1	40	12.04 -	187A1.000	4	1,0	DCPR7EN-10	4893			
Nuova Panda Natural Power	1.2	44	06.06 -	188A4.000	4	1,0	DCPR7EN-10	4983			
Nuova Panda	1.2	44	10.04 -	188A4.000	4	1,0	DCPR7EN-10	4893			
Nuova Panda 4x4	1.2	44	10.04 -	188A4.000	4	1,0	DCPR7EN-10	4893			
Nuova Panda	1.2	44	09.03 - 10.04	188A4.000	4	0,9	BKR5EZ	7642		BKR5EIX	6341
Panda D	1.3	27	03.86 - 12.89	156A 5.000	4	█	Y-902R	2237		D-POWER 1	7906
Nuova Panda 100 HP	1.4	74	06.07 -	169A3000	4	1,0	DCPR7EN-10	4983			
Punto 55 S	1.1	40	06.94 - 05.97	176A6.000	4	0,8	BCPR6ES	2330	12	BCPR6EIX	5689
Punto 55 S; Sx; 6 Speed	1.1	40	06.97 - 09.99	176B2.000	4	0,8	BCPR6ES	2330	12	BCPR6EIX	5689
Punto Van	1.1	40	06.97 - 06.00	176B2.000	4	0,8	BCPR6ES	2330	12	BCPR6EIX	5689
Punto 55	1.1	40	11.93 - 05.97	176A6.000	4	0,8	BCPR6ES	2330	12	BCPR6EIX	5689
Punto 60 Cabrio S	1.2	40	06.97 - 06.98	176 B2.000	4	0,8	BCPR6ES	2330	12	BCPR6EIX	5689
Punto 60 - SPI- Cabrio-Selecta	1.2	43	06.94 - 05.98	176A7.000	4	0,8	BCPR6ES	2330	12	BCPR6EIX	5689
Punto 1.2L 8V	1.2	44	09.00 -	188 A4.000	4	0,9	BKR5EZ	7642		BKR5EIX	6341
Punto Cabrio 1.2L	1.2	44	06.98 - 02.01	176 B4.000	4	0,8	BCPR6ES	2330	12	BCPR6EIX	5689
Punto SPI	1.2	44	11.93 - 05.97	176B1.000	4	0,8	BCPR6ES	2330	12	BCPR6EIX	5689
Punto Natural Power	1.2	44	01.04 - 10.04	188 A4.000	4	0,9	BKR5EZ	7642		BKR5EIX	6341
Punto 8V	1.2	44	10.04 -	188A4.000	4	1,0	DCPR7EN-10	4893			
Punto 60 S; Sx; Selecta	1.2	44	06.97 - 09.99	176 B4.000	4	0,8	BCPR6ES	2330	12	BCPR6EIX	5689
Punto 75	1.2	54	11.93 - 05.98	176A8.000	4	0,8	BCPR6ES	2330	12	BCPR6EIX	5689
Punto 1.2L 16V	1.2	59	12.02 - 02.05	188 A5.000	4	0,9	DCPR7E-N	4795		DCPR7EIX	6046
Punto 16V	1.2	59	02.05 -	188A5.000	4	1,0	DCPR7EN-10	4893			
Punto 1.2L 16V	1.2	59	09.00 - 11.02	188 A5.000	4	0,9	DCPR8E-N	5692			
Punto Cabrio 1.2L 16V	1.2	63	06.98 - 02.01	176 B9.000	4	0,9	DCPR8E	4339		DCPR8EIX	6546
Punto 85 16V 1.2L	1.2	63	05.97 - 09.01	176B9.000	4	0,9	DCPR8E	4339		DCPR8EIX	6546
Punto 16V 1.2L Cabrio	1.2	63	06.97 - 06.01	176 B9.000	4	0,9	DCPR8E	4339		DCPR8EIX	6546
Punto 1.4L 16V	1.4	70	06.03 -	843 A1.000	4	0,9	DCPR7E-N	4795		DCPR7EIX	6046
Punto Turbo GT	1.4	96	06.93 - 09.99	176 B6.000/ 176A4.000	4	0,9	BCPR6ET	2197		BCPR6EIX	5689
Punto Sporting	1.6	65	07.95 - 05.97	176A9.000	4	0,9	BCPR7ES	3330			
Punto 90 Cabrio ELX	1.6	65	06.94 - 05.98	176A9.000	4	0,9	BCPR7ES	3330			
Punto 90	1.6	65	01.94 - 05.97	176A9.000	4	0,9	BCPR7ES	3330			
Punto D	1.7	42	11.94 -	176 A 3.000	4	█	Y-902R	2237		D-POWER 1	7906
Punto S, SX, ELX TD	1.7	53	06.93 - 09.96	176 TD, 1697 TT	4	█	Y-922R	4356		D-POWER 1	7906
Punto S, SX, ELX TD	1.7	53	10.96 - 12.99		4	█	Y-928U	5700		D-POWER 29	4389
Punto 70 TD	1.7	53	10.96 - 12.99		4	█	Y-928U	5700		D-POWER 29	4389
Punto 1,8 HGT	1.8	96	09.02 -	188 A1.000	4	0,9	BKR6EZ	4619		BKR6EIX	6418

<sup>1)</sup> Bic = Best in class



l kW

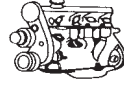

Cyl.

Order-  
No. No.Bic<sup>1)</sup> Order-  
D-Power No.**FIAT**

Punto 1,8 HGT	1.8	96	09.00 - 08.02	188 A1.000	4	0,9	BKR6EKC	2848	26	BKR6EIX	6418
Punto JTD	1.9	59	10.99 - 12.00	188A2.000	4	█	Y-534J	5540		D-POWER 36	3413
Punto JTD	1.9	63	01.01 -	188A7.000	4	█	Y-534J	5540		D-POWER 36	3413
Regata 70	1.3	48	09.83 - 07.89	149A7.000	4	0,8	BPR6ES	7822	2	BPR6EIX	6637
Regata 75 IE	1.5	55	02.87 - 06.90	149C1.000	4	0,8	BPR7ES	2023	19	BPR7EIX	4055
Regata 90 IE	1.6	66	01.87 - 03.89	149C2.000 Cat.	4	0,8	BPR6ES	7822	2	BPR6EIX	6637
Regata 100 IE S / IE Riv.	1.6	74	06.86 - 07.89	149C3.000	4	0,8	BPR6ES	7822	2	BPR6EIX	6637
Regata 100 IE Week./Riv./S	1.6	74	06.86 - 06.90	149A4..	4	0,8	BPR6ES	7822	2	BPR6EIX	6637
Regata 100 S / Weekend	1.6	74	06.86 - 06.90	149A4..	4	0,8	BPR7ES	2023	19	BPR7EIX	4055
Regata D	1.7	43	06.87 -		4	█	Y-902R	2237		D-POWER 1	7906
Regata D	1.9	48	06.87 -		4	█	Y-902R	2237		D-POWER 1	7906
Regata TD	1.9	59	06.86 - 07.89		4	█	Y-902R	2237		D-POWER 1	7906
Ritmo D	1.7	43	10.82 -		4	█	Y-902R	2237		D-POWER 1	7906
Scudo	1.6	58	02.96 -	220A2.000	4	0,8	BCPR7ES	3330			
Scudo	1.9		09.98 -	XUD9TF	4	█	Y-938R	5267		D-POWER 1	7906
Scudo	1.9		09.98 -	DW8, DW8TD	4	█	Y-503R	4279		D-POWER 10	1009
Scudo D	1.9	51	03.96 -		4	█	Y-923U	3380		D-POWER 1	7906
Scudo TD	1.9	68	03.96 -		4	█	Y-923U	3380		D-POWER 1	7906
Sedici	1.9	88	09.05 -	939A1000	4	█	Y-543J	6600		D-POWER 46	5618
Seicento 900 i.e. S; SX; Citymatic	0.9	29	05.98 - 12.00	1170A1.046	4	0,8	BPR6ES	7822	2	BPR6EIX	6637
Seicento 1100	1.1	40	10.00 - 10.04	187A1000	4	0,9	BKR5EZ	7642		BKR5EIX	6341
Seicento 1100	1.1	40	05.98 - 09.00	176B2.000	4	0,8	BCPR6ES	2330	12	BCPR6EIX	5689
Seicento Sporting	1.1	40	03.98 - 09.00	176B2.000	4	0,8	BCPR6ES	2330	12	BCPR6EIX	5689
Seicento	1.1	40	10.04 -	187A1.000	4	1,0	DCPR7EN-10	4893			
Siena 1.4	1.4	51	11.97 -	178 B2.000	4	0,9	BKR5EZ	7642		BKR5EIX	6341
Stilo 1.2 16V	1.2	59	09.01 - 11.02	188.A5000	4	0,9	DCPR8E-N	5692			
Stilo 1.2 16V	1.2	59	12.02 - 06.04	188.A5000	4	0,9	DCPR7E-N	4795		DCPR7EIX	6046
Stilo 1.4 16 V / SW	1.4	70	02.05 -	843A1.000	4	1,0	DCPR7EN-10	4893			
Stilo 1.4 16V / SW	1.4	70	01.04 - 02.05	843.A1000	4	0,9	DCPR7E-N	4795		DCPR7EIX	6046
Stilo 1.6 SW	1.6	76	09.02 -	182.B6000	4	0,9	BKR5EZ	7642		BKR5EIX	6341
Stilo 1.6	1.6	76	09.01 - 05.06	182.B6000	4	0,9	BKR5EZ	7642		BKR5EIX	6341
Stilo 1.8 16V	1.8	96	09.01 -	192.A4000	4	0,9	BKR6EZ	4619		BKR6EIX	6418
Stilo 1.8 SW	1.8	98	09.02 -	192.A4000	4	0,9	BKR6EZ	4619		BKR6EIX	6418
Stilo 1.9 JTD 80 CV	1.9	59	09.01 - 12.03	192.A3000	4	█	Y-534J	5540		D-POWER 36	3413
Stilo 1.9 JTD 115 CV	1.9	85	09.01 -	192.A1000	4	█	Y-534J	5540		D-POWER 36	3413
Stilo 1.9 JTD SW	1.9	86	09.02 -	192.A1000	4	█	Y-534J	5540		D-POWER 36	3413
Stilo 2.4 20V	2.4	125	09.01 -	192.A2000	5	0,9	BKR6EZ	4619		BKR6EIX	6418
Strada	1.2		01.99 - 10.05	188A4.000	4	0,9	BKR5EZ	7642			
Strada	1.2	48	10.04 -	178B7.045	4	1,0	DCPR7EN-10	4893			
Strada 75	1.2	54	05.99 - 05	178B5.000	4	0,9	BKR5EZ	7642			
Strada	1.6		10.99 - 10.04	178D2011	4	0,9	BKR5EZ	7642			
Strada D	1.7	43	10.82 -		4	█	Y-902R	2237		D-POWER 1	7906
Talento D	1.9	51	03.88 -		4	█	Y-902R	2237		D-POWER 1	7906
Tempra 1.4- S.W- .S	1.4	51	10.94 - 10.96	836A4.000	4	0,8	BPR6ES	7822	2	BPR6EIX	6637
Tempra / SX / Sta. Wagon	1.4	56	03.90 - 10.96	159A2.000	4	0,8	BPR6ES	7822	2	BPR6EIX	6637
Tempra 1.6	1.6	55	02.90 - 12.94	159 A3.048	4	0,8	BPR7ES	2023	19	BPR7EIX	4055
Tempra 1.6	1.6	55	09.94 - 10.96	835C1.000	4	0,9	BCPR7ES	3330			
Tempra 1.6 90CV-Liberty S.W.	1.6	66	03.95 -		4	0,9	BCPR7ES	3330			
Tempra ie SX, S.W.	1.8	74	05.95 -		4	0,8	BPR7ES	2023	19	BPR7EIX	4055
Tempra 1800 i.e/a.Modelle	1.8	77	02.90 - 10.96	159A4.046	4	0,8	BPR7ES	2023	19	BPR7EIX	4055
Tempra D - SW	1.9	48	02.90 - 06.96	160 A7.000	4	█	Y-902R	2237		D-POWER 1	7906
Tempra TD	1.9	59	07.90 -	160 B6.046	4	█	Y-902R	2237		D-POWER 1	7906

<sup>1)</sup> Bic = Best in class



ℓ kW

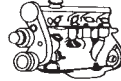

Cyl.

Order-  
No. No.Bic<sup>1)</sup> Order-  
D-Power No.

FIAT											
Tempra TD /SW	1.9	66	02.90 -	160 A6.000	4	■	Y-902R	2237		D-POWER 1	7906
Tempra TD	1.9	68	06.93 -09.96	160 D1.000	4	■	Y-922R	4356		D-POWER 1	7906
Tempra 2.0L	2.0	83	02.90 - 10.96	159A6.046	4	0,8	BPR7ES	2023	19	BPR7EIX	4055
Tipo 1.1L	1.1	41	07.87 -03.93	160A3.000	4	0,8	BCPR6ES	2330	12	BCPR6EIX	5689
Tipo1.4L	1.4	51	02.88 - 11.90	160A1.000	4	0,8	BPR7ES	2023	19	BPR7EIX	4055
Tipo	1.4	51	07.87 - 11.90	160 A1.046	4	0,8	BPR6ES	7822	2	BPR6EIX	6637
Tipo Selecta	1.4	53	02.88 -	160A1.000	4	0,8	BPR6ES	7822	2	BPR6EIX	6637
Tipo	1.4	57	01.90 -05.95	159A2.000	4	0,8	BPR6ES	7822	2	BPR6EIX	6637
Tipo 1.6L	1.6	55	03.93 - 10.94	835C1.000	4	0,9	BCPR7ES	3330			
Tipo i.e.	1.6	55	03.94 -		4	0,9	BCPR7ES	3330			
Tipo i.e.	1.6	55	03.93 - 10.95	835C1.000	4	0,8	BPR7ES	2023	19	BPR7EIX	4055
Tipo Selecta	1.6	57	01.92 -03.93	159A3.046	4	0,8	BPR7ES	2023	19	BPR7EIX	4055
Tipo	1.6	60	02.88 -06.90	160A2.000	4	0,8	BPR7ES	2023	19	BPR7EIX	4055
Tipo	1.6	63	07.87 -03.90	160A2.000	4	0,8	BPR7ES	2023	19	BPR7EIX	4055
Tipo	1.6	63	04.90 - 12.92	159A3.000 DOHC	4	0,8	BPR7ES	2023	19	BPR7EIX	4055
Tipo i.e.	1.6	66	03.93 - 10.95	159 A3.048	4	0,8	BPR7ES	2023	19	BPR7EIX	4055
Tipo i.e	1.6	66	02.88 -06.90	160A1.000	4	0,8	BPR7ES	2023	19	BPR7EIX	4055
Tipo D	1.7	42	07.87 -03.93	149 B 4.000	4	■	Y-902R	2237		D-POWER 1	7906
Tipo IE SX / GT / SLX	1.8	76	11.91 - 10.95	835C2.000	4	0,8	BPR7ES	2023	19	BPR7EIX	4055
Tipo IE 16V	1.8	80	06.89 -05.90	159A4.000	4	0,8	BPR7ES	2023	19	BPR7EIX	4055
Tipo i.e. GT	1.8	80	03.92 -03.93	139A4.000	4	0,8	BPR7ES	2023	19	BPR7EIX	4055
Tipo IE 16V	1.8	102	06.89 -09.91	160A5.000	4	0,8	BP6ET	1263			
Tipo D	1.9	48	07.89 -03.93	149 A1.000	4	■	Y-902R	2237		D-POWER 1	7906
Tipo TD	1.9	66	07.87 -	160 D1.000	4	■	Y-902R	2237		D-POWER 1	7906
Tipo TD	1.9	68	07.87 -03.93	149 A 1.000	4	■	Y-902R	2237		D-POWER 1	7906
Tipo TD	1.9	68	06.93 - 12.94		4	■	Y-922R	4356		D-POWER 1	7906
Tipo 2.0 L	2.0	83	03.90 -03.92	159A6.046	4	0,8	BPR7ES	2023	19	BPR7EIX	4055
Tipo 2.0 L- GT / SLX	2.0	83	11.91 - 10.95	159A6.046 Cat.	4	0,8	BPR7ES	2023	19	BPR7EIX	4055
Tipo IE 16V	2.0	102	05.91 - 10.95	836A3.000 Cat.	4	0,8	BPR7ES	2023	19	BPR7EIX	4055
Tipo i.e. 16V	2.0	109	05.91 - 10.95	160A8.046	4	0,8	BPR7ES	2023	19	BPR7EIX	4055
Ulysse TD	1.9	68	09.94 -	XUD 9 TU	4	■	Y-923U	3380		D-POWER 1	7906
Ulysse JTD	2.0	80	09.02 -	DW10ATED4/RHT	4	■	Y-504R	4359		D-POWER 24	1441
Ulysse i.S	2.0	89	07.94 -	RFU	4	0,9	BKR5EK	7956	23	BKR5EIX	6341
Ulysse i.turbo	2.0	108	07.94 - 12.98	RGX	4	0,8	BKR6EK	2288	20	BKR6EQUIP	3199
Ulysse TD	2.1	80	07.96 -	XUD11ATE	4	■	Y-923U	3380		D-POWER 1	7906
Ulysse JTD	2.2	94	09.02 -	DW12ATED4/4HW	4	■	Y-504R	4359		D-POWER 24	1441
Uno 45 ES/S/Sting/Trend	0.9	33	01.83 - 10.95	146A...	4	0,8	BPR6ES	7822	2	BPR6EIX	6637
Uno 45	1.0	32	06.85 - 10.95	156A2...	4	0,8	BCPR6ES	2330	12	BCPR6EIX	5689
Uno 1.0L- Start	1.0	33	08.94 - 10.95	156A2.000-2.048	4	0,9	BPR5ES	7422	6	BPR5EIX	6597
Uno 1.0 L	1.0	35	08.94 -		4	0,8	BPR6ES	7822	2	BPR6EIX	6637
Uno 60 IE / S	1.1	37	07.91 - 10.95	156C.046 Cat.	4	0,8	BCPR6ES	2330	12	BCPR6EIX	5689
Uno 60 SL / Trend	1.1	41	09.89 -09.92	146A6.000	4	0,8	BPR6ES	7822	2	BPR6EIX	6637
Uno 60 S / SX / Fire	1.1	41	05.85 - 10.95	146A6.000	4	0,8	BCPR6ES	2330	12	BCPR6EIX	5689
Uno Selecta / Selecta S	1.1	43	04.87 -08.89	146A4.048	4	0,8	BPR6ES	7822	2	BPR6EIX	6637
Uno 60 /60 CS / 60 S	1.1	43	05.85 -08.89	146A4...	4	0,8	BPR6ES	7822	2	BPR6EIX	6637
Uno 60 D	1.3	33	06.83 -08.89	127 A 5.	4	■	Y-902R	2237		D-POWER 1	7906
Uno 45 D	1.3	33	06.83 -08.89	127 A 5.	4	■	Y-902R	2237		D-POWER 1	7906
Uno 70 S / SL / SX	1.3	48	05.85 -09.89	149A7...	4	0,8	BPR6ES	7822	2	BPR6EIX	6637
Uno Turbo i.e.	1.3	73	04.85 -08.89	146A2... Cat.	4	0,7	BCPR7ET	2164			
Uno 70 TD	1.4	51	03.86 -08.89	146 A 653, 146 B.	4	■	Y-902R	2237		D-POWER 1	7906
Uno i.e.	1.4	51	08.94 -		4	0,8	BPR6ES	7822	2	BPR6EIX	6637
Uno 60 TD	1.4	51	03.86 -09.92	146 B	4	■	Y-902R	2237		D-POWER 1	7906

<sup>1)</sup> Bic = Best in class



l kW

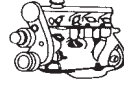

Cyl.

Order-  
No. No.Bic<sup>1)</sup> Order-  
D-Power No.**FIAT**

Uno 70 all models	1.4	51	83 - 10.95	160A1.046	4	0,8	BPR6ES	7822	2	BPR6EIX	6637
Uno TD	1.4	52	09.89 - 12.95	146 B3.000	4	█	Y-902R	2237		D-POWER 1	7906
Uno Turbo IE/ Racing	1.4	82	09.89 - 12.93	146A8.046 Cat.	4	0,7	BCPR7ET	2164			
Uno 75 I.E. SPi	1.5	55	12.87 - 10.95	149C1.000	4	0,8	BPR6ES	7822	2	BPR6EIX	6637
Uno D	1.7		10.89 -		4	█	Y-902R	2237		D-POWER 1	7906
Uno D	1.7		01.91 -		4	█	Y-902R	2237		D-POWER 1	7906
Uno 60 D	1.7	40	09.89 - 09.92	146 B 2.000	4	█	Y-902R	2237		D-POWER 1	7906
Uno D Van	1.7	42	09.89 - 03.96	146 B2.000	4	█	Y-902R	2237		D-POWER 1	7906
Uno 60 D	1.7	44	07.86 - 08.89	149 B 3.	4	█	Y-902R	2237		D-POWER 1	7906

**FISSORE**

Magnum Volumex	2.0	102	01.86 - 03.88	132E.000 Fiat	4	0,8	BPR6ES	7822	2	BPR6EIX	6637
Rayton	3.5	155	03.88 -		6	0,7	BP6ES	7811	4	BPR6EIX	6637
Rayton 4x4 TD	2.4	82	03.88 -	HR 492 HIM	6	█	Y-909R	4602			
Vip V6 i.e.	2.5	118	03.86 - 03.88	019.11 Alfa	6	0,7	BP6ES	7811	4	BPR6EIX	6637

**FORD**

Aerostar	3.0				6	0,9	BPR6EFS	3623	7		
A-Series	2.4			4AA YORK-D		█	Y-208T	1250			
A-Series	3.6			8AA YORK-D		█	Y-208T	1250			
Cougar	2.0	96	08.98 - 01.01	EDBA ZETEC-E SEFI	4	1,3	PTR5A-13	2467	25		
Cougar	2.0	96	08.98 - 01.01	EDBB ZETEC-E SEFI	4	1,3	PTR5A-13	2467	25		
Cougar	2.0	96	08.98 - 01.01	EDBD ZETEC-E SEFI	4	1,3	PTR5A-13	2467	25		
Cougar	2.0	96	08.98 - 01.01	EDBC ZETEC-E SEFI	4	1,3	PTR5A-13	2467	25		
Cougar	2.5	125	08.98 - 01.01	LCBC Duratec VE SEFI	6	1,3	TR55	1048		TR55IX	7164
Cougar	2.5	125	08.98 - 01.01	LCBA Duratec VE SEFI	6	1,3	TR55	1048		TR55IX	7164
Cougar	2.5	125	08.98 - 01.01	LCBE Duratec-VE SEFI	6	1,5	TR55	1048		TR55IX	7164
Cougar	2.5	125	08.98 - 01.01	LCBB Duratec-VE SEFI	6	1,5	TR55	1048		TR55IX	7164
Cougar	2.5	151	08.98 - 01.01	MABB Duratec VE SEFI	6	1,3	TR55	1048		TR55IX	7164
Courier D	1.8	66	03.93 -		4	█	Y-910R	4751		D-POWER 3	3617
Econovan	1.4	48	09.85 -	UC OHC/E 2V	4	0,8	BPR6ES	7822	2	BPR6EIX	6637
Econovan	2.0	41	09.85 -	RF	4	█	Y-107R	1229			
Escort '81 Express Van 55	1.6	40	04.84 - 07.90	LTA	4	█	Y-907R	4479			
Escort '86	1.1	37	01.86 - 07.90	GSG VAL VV	4	1,0	BPR6EFS	3623	7		
Escort '86	1.1	40	01.86 - 07.90	GUC HCS 2V	4	1,0	BPR6EFS	3623	7		
Escort '86	1.3	44	01.86 - 07.90	JLA VAL VV	4	1,0	BPR6EFS	3623	7		
Escort '86	1.3	44	01.86 - 07.90	JLA VAL VV Cat.	4	1,0	BPR6EFS	3623	7		
Escort '86	1.3	44	01.86 - 07.90	JBB HCS 2V	4	1,0	BPR6EFS	3623	7		
Escort '86	1.3	44	01.86 - 07.90	JLB VAL VV	4	1,0	BPR6EFS	3623	7		
Escort '86	1.3	46	01.86 - 07.90	JBA HCS 2V	4	1,0	BPR6EFS	3623	7		
Escort '86	1.4	51	01.86 - 07.90	FUAA CVH 2V	4	0,8	BCPR6ES	2330	12	BCPR6EIX	5689
Escort '86	1.4	54	01.86 - 07.90	F6D CVH CFI	4	1,1	BCPR6ES-11	7121	11	BCPR6EIX-11	4919
Escort '86	1.4	54	01.86 - 07.90	FUC CVH 2V	4	1,1	BCPR7ES-11	1095		BCPR7EIX-11	5691
Escort '86	1.4	54	01.86 - 07.90	F6B CVH CFI	4	1,1	BCPR6ES-11	7121	11	BCPR6EIX-11	4919
Escort '86	1.4	55	01.86 - 07.90	FUA CVH 2V	4	0,8	BCPR6ES	2330	12	BCPR6EIX	5689
Escort '86	1.4	55	01.86 - 07.90	FUA CVH 2V Cat.	4	0,8	BCPR6ES	2330	12	BCPR6EIX	5689
Escort '86	1.6	40	01.86 - 07.90	LTC	4	█	Y-907R	4479			
Escort '86	1.6	58	01.86 - 07.90	LP2 CVH VV	4	0,8	BCPR6ES	2330	12	BCPR6EIX	5689
Escort '86	1.6	65	01.86 - 07.90	LUG CVH 2V	4	0,8	BCPR6ES	2330	12	BCPR6EIX	5689
Escort '86	1.6	66	01.86 - 07.90	L4B CVH FI	4	0,8	BCPR6ES	2330	12	BCPR6EIX	5689
Escort '86	1.6	66	01.86 - 07.90	LUC CVH 2V Cat.	4	0,8	BCPR6ES	2330	12	BCPR6EIX	5689
Escort '86	1.6	66	01.86 - 07.90	LUC CVH 2V	4	0,8	BCPR6ES	2330	12	BCPR6EIX	5689

<sup>1)</sup> Bic = Best in class



ℓ kW

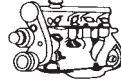

Cyl.

Order-  
No. No.Bic<sup>1)</sup> Order-  
D-Power No.**FORD**

Escort '86	1.6	75	01.86 - 07.90	LJB CVH EFI	4	1,1	BCPR6ES-11	7121	11	BCPR6EIX-11	4919
Escort '86	1.6	77	01.86 - 07.90	LRB CVH FI Cat.	4	0,8	BCPR7ES	3330		BCPR7EIX	5690
Escort '86	1.6	77	01.86 - 07.90	LR2 CVH FI	4	0,8	BCPR7ES	3330		BCPR7EIX	5690
Escort '86	1.6	77	01.86 - 07.90	LRB CVH FI	4	0,8	BCPR7ES	3330		BCPR7EIX	5690
Escort '86	1.6	79	01.86 - 07.90	LJA CVH EFI	4	1,1	BCPR6ES-11	7121	11	BCPR6EIX-11	4919
Escort '86	1.6	97	01.86 - 07.90	LNB CVH FI	4	0,8	BCR8ES	5430			
Escort '86	1.8	44	01.86 - 07.90	RTA	4	█	Y-910R	4751		D-POWER 3	3617
Escort '86	1.8	44	01.86 - 07.90	RTB	4	█	Y-910R	4751		D-POWER 3	3617
Escort '91	1.1	40	08.90 - 09.01	GUF HCS 2V	4	1,0	PTR5D-10	3784	31		
Escort '91	1.3	44	08.90 - 09.01	J4B Endura-E SEFI	4	1,0	PTR5D-10	3784	31		
Escort '91	1.3	44	08.90 - 09.01	J6A HCS CFI	4	1,0	PTR5D-10	3784	31		
Escort '91	1.3	44	08.90 - 09.01	JBE HCS 2V	4	1,0	PTR5D-10	3784	31		
Escort '91	1.3	46	08.90 - 09.01	JBD HCS 2V	4	1,0	PTR5D-10	3784	31		
Escort '91	1.4	52	08.90 - 09.01	F6G CVH CFI	4	1,1	BCPR6ES-11	7121	11	BCPR6EIX-11	4919
Escort '91	1.4	52	08.90 - 09.01	F6F CVH CFI	4	1,1	BCPR6ES-11	7121	11	BCPR6EIX-11	4919
Escort '91	1.4	54	08.90 - 09.01	FUH CVH 2V	4	0,8	BCPR6ES	2330	12	BCPR6EIX	5689
Escort '91	1.4	54	08.90 - 09.01	F4B PTE SEFI	4	1,1	BCPR6ES-11	7121	11	BCPR6EIX-11	4919
Escort '91	1.6	65	08.90 - 09.01	L1H ZETEC-E SEFI	4	1,3	PTR5A-13 *	2467	25		
Escort '91	1.6	66	08.90 - 09.01	L1K ZETEC-E SEFI	4	1,3	PTR5A-13 *	2467	25		
Escort '91	1.6	66	08.90 - 09.01	L1E ZETEC-E SEFI	4	1,3	PTR5A-13 *	2467	25		
Escort '91	1.6	66	08.90 - 09.01	LUK CVH 2V	4	0,8	BCPR6ES	2330	12	BCPR6EIX	5689
Escort '91	1.6	66	08.90 - 09.01	LUJ CVH 2V	4	0,8	BCPR6ES	2330	12	BCPR6EIX	5689
Escort '91	1.6	77	08.90 - 09.01	LJF CVH EFI	4	1,1	BCPR6ES-11	7121	11	BCPR6EIX-11	4919
Escort '91	1.6	79	08.90 - 09.01	LJE CVH EFI	4	1,1	BCPR6ES-11	7121	11	BCPR6EIX-11	4919
Escort '91	1.8	44	08.90 - 09.01	RTF	4	█	Y-910R	4751		D-POWER 3	3617
Escort '91	1.8	44	08.90 - 09.01	RTE	4	█	Y-910R	4751		D-POWER 3	3617
Escort '91	1.8	44	08.90 - 09.01	RTH	4	█	Y-910R	4751		D-POWER 3	3617
Escort '91 TD	1.8	51	08.90 - 09.01	RVA Endura-DE (TC)	4	█	Y-937R	5148		D-POWER 5	7503
Escort '91	1.8	66	08.90 - 09.01	RFS Endura-DE (TC)	4	█	Y-937R	5148		D-POWER 5	7503
Escort '91	1.8	66	08.90 - 09.01	RFK	4	█	Y-910R	4751		D-POWER 3	3617
Escort '91	1.8	66	08.90 - 09.01	RFD	4	█	Y-910R	4751		D-POWER 3	3617
Escort '91	1.8	77	08.90 - 09.01	RDA ZETEC SEFI	4	1,3	PTR5A-13	2467	25		
Escort '91	1.8	85	08.90 - 09.01	RKC ZETEC-E SEFI	4	1,3	PTR5A-13 *	2467	25		
Escort '91	1.8	96	08.90 - 09.01	RQB ZETEC SEFI	4	1,3	PTR5A-13	2467	25		
Escort '91	2.0	110	08.90 - 09.01	N7A DOHC 16V EFI	4	1,1	BCPR6ES-11	7121	11	BCPR6EIX-11	4919
Escort '91	2.0	162	08.90 - 09.01	N5F DOHC COSWORTH	4	0,6	PFR7B	4853			
Escort '91 Cosworth	2.0	162	08.90 - 09.01	N5E DOHC COSWORTH	4	1,1	PFR7B-11	5667			
Escort '91 Cosworth	2.0	184	92 -	NC8 1711 COSWORTH 16V	4	0,8	R7234-10	5558			
Explorer	4.0	115	01.93 -	V6 SEFI	6	1,3	TR55	1048		TR55IX	7164
Explorer	4.0	121	01.93 -	V6 EFI	6	1,3	TR55	1048		TR55IX	7164
Explorer	4.0	152	01.93 -	V6 SOHC SEFI	6	1,3	TR55	1048		TR55IX	7164
Fiesta '01	1.25	51	11.01 -	M7JB Duratec 16V SFI	4	1,3	PTR5A-13	2467	25		
Fiesta '01	1.25	51	11.01 -	M7JA Duratec 16V SFI	4	1,3	PTR5A-13	2467	25		
Fiesta '01	1.25	55	11.01 -	FUJB Duratec 16V SFI	4	1,3	PTR5A-13	2467	25		
Fiesta '01	1.25	55	11.01 -	FUJA Duratec 16V SFI	4	1,3	PTR5A-13	2467	25		
Fiesta '01	1.3	44	11.01 -	BAJA Duratec 8V SFI	4	1,3	PTR5A-13	2467	25		
Fiesta '01	1.3	51	11.01 -	A9JA Duratec 8V SFI	4	1,3	PTR5A-13	2467	25		
Fiesta '01	1.3	51	11.01 -	A9JB Duratec 8V SFI	4	1,3	PTR5A-13	2467	25		
Fiesta '01 TDCI	1.4	50	11.01 -	F6JB DuraTorq-TDCi	4	█	YE04	1101		D-POWER 40	1684
Fiesta '01 TDCI	1.4	50	11.01 -	F6JA DuraTorq-TDCi	4	█	YE04	1101		D-POWER 40	1684
Fiesta '01	1.4	59	11.01 -	FXJB Duratec 16V SFI	4	1,3	PTR5A-13	2467	25		
Fiesta '01 16V	1.4	59	11.01 -	FXJA Duratec 16V SFI	4	1,3	PTR5A-13	2467	25		

<sup>1)</sup> Bic = Best in class

\* Standardtype TR5A-10 / standard type TR5A-10



ℓ kW

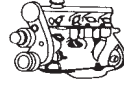

Cyl.

Order-  
No. No.Bic<sup>1)</sup> Order-  
D-Power No.**FORD**

Fiesta '01 TDCI	1.6	66	03.05 -	HHJA DuraTorq-TDCi	4	█	YE04	1101		D-POWER 40	1684
Fiesta '01 TDCI	1.6	66	03.05 -	HHJB DuraTorq-TDCi	4	█	YE04	1101		D-POWER 40	1684
Fiesta '01	1.6	74	11.01 -	FYJB Duratec 16V SFI	4	1,3	PTR5A-13	2467	25		
Fiesta '01 16V	1.6	74	11.01 -	FYJA Duratec 16V SFI	4	1,3	PTR5A-13	2467	25		
Fiesta '01 ST150	2.0	110	03.05 -	N4JB Duratec-ST (MI4) SFI	4	1,3	ITR6F-13	4477			
Fiesta '87	1.0	33	02.87 - 02.89	TKB VAL 1V Cat.	4	1,0	BPR6EFS	3623	7		
Fiesta '87	1.0	33	02.87 - 02.89	TKB VAL 1V	4	1,0	BPR6EFS	3623	7		
Fiesta '87	1.1	35	02.87 - 02.89	GUB VAL 2V	4	1,0	BPR6EFS	3623	7		
Fiesta '87	1.1	36	02.87 - 02.89	GSH VAL VV	4	1,0	BPR6EFS	3623	7		
Fiesta '87	1.1	37	02.87 - 02.89	GSF VAL VV	4	1,0	BPR6EFS	3623	7		
Fiesta '87	1.1	37	02.87 - 02.89	GSF VAL VV Cat.	4	1,0	BPR6EFS	3623	7		
Fiesta '87	1.1	39	02.87 - 02.89	GS1 VAL VV	4	1,0	BPR6EFS	3623	7		
Fiesta '87	1.4	52	02.87 - 02.89	F6A CVH CFI	4	1,1	BCPR6ES-11	7121	11	BCPR6EIX-11	4919
Fiesta '87	1.4	52	02.87 - 02.89	F6C CVH CFI	4	1,1	BCPR6ES-11	7121	11	BCPR6EIX-11	4919
Fiesta '87	1.4	54	02.87 - 02.89	FUD CVH 2V	4	1,1	BCPR6ES-11	7121	11	BCPR6EIX-11	4919
Fiesta '87	1.4	55	02.87 - 02.89	FUB CVH 2V	4	0,8	BCPR6ES	2330	12	BCPR6EIX	5689
Fiesta '87	1.6	40	02.87 - 02.89	LTB D	4	█	Y-907R	4479			
Fiesta '87	1.6	58	02.87 - 02.89	LP3 CVH VV	4	0,8	BCPR7ES	3330		BCPR7EIX	5690
Fiesta '87	1.6	70	02.87 - 02.89	LUD CVH 2V	4	0,8	BCPR6ES	2330	12	BCPR6EIX	5689
Fiesta '87	1.6	70	02.87 - 02.89	LUD CVH 2V Cat.	4	0,8	BCPR6ES	2330	12	BCPR6EIX	5689
Fiesta '89	1.0	33	03.89 - 06.96	TLB HCS 1V	4	1,0	BPR6EFS	3623	7		
Fiesta '89	1.1	37	03.89 - 06.96	G6A HCS CFI	4	1,0	BPR6EFS	3623	7		
Fiesta '89	1.1	40	03.89 - 06.96	GUE HCS 2V	4	1,0	BPR6EFS	3623	7		
Fiesta '89	1.1	40	03.89 - 06.96	GUD HCS 2V	4	1,0	BPR6EFS	3623	7		
Fiesta '89	1.3	44	03.89 - 06.96	J6B HCS CFI	4	1,0	BPR6EFS	3623	7		
Fiesta '89	1.3	44	03.89 - 06.96	JBC HCS 2V	4	1,0	BPR6EFS	3623	7		
Fiesta '89	1.4	52	03.89 - 06.96	F6E CVH CFI	4	1,1	BCPR6ES-11	7121	11	BCPR6EIX-11	4919
Fiesta '89	1.4	54	03.89 - 06.96	FUG CVH 2V	4	1,1	BCPR6ES-11	7121	11	BCPR6EIX-11	4919
Fiesta '89	1.4	54	03.89 - 06.96	FUJ CVH 2V	4	0,8	BCPR6ES	2330	12	BCPR6EIX	5689
Fiesta '89	1.4	54	03.89 - 06.96	F4A PTE SEFI	4	1,1	BCPR6ES-11	7121	11	BCPR6EIX-11	4919
Fiesta '89	1.4	55	03.89 - 06.96	FUF CVH 2V	4	0,8	BCPR6ES	2330	12	BCPR6EIX	5689
Fiesta '89	1.6	66	03.89 - 06.96	L1G ZETEC SEFI	4	1,3	PTR5A-13	2467	25		
Fiesta '89	1.6	66	03.89 - 06.96	LUH CVH 2V	4	0,8	BCPR6ES	2330	12	BCPR6EIX	5689
Fiesta '89	1.6	76	03.89 - 06.96	LJD CVH EFI	4	1,1	BCPR6ES-11	7121	11	BCPR6EIX-11	4919
Fiesta '89	1.6	81	03.89 - 06.96	LJC CVH EFI	4	1,1	BCPR6ES-11	7121	11	BCPR6EIX-11	4919
Fiesta '89	1.6	96	03.89 - 06.96	LHA CVH Turbo	4	0,8	BCR8ES	5430			
Fiesta '89	1.8	44	03.89 - 06.96	RTD D	4	█	Y-910R	4751		D-POWER 3	3617
Fiesta '89	1.8	44	03.89 - 06.96	RTC D	4	█	Y-910R	4751		D-POWER 3	3617
Fiesta '89	1.8	44	03.89 - 06.96	RTG D	4	█	Y-910R	4751		D-POWER 3	3617
Fiesta '89	1.8	77	03.89 - 06.96	RDB ZETEC SEFI	4	1,3	PTR5A-13	2467	25		
Fiesta '89	1.8	96	03.89 - 06.96	RQC ZETEC SEFI	4	1,3	PTR5A-13	2467	25		
Fiesta '96	1.25	55	11.95 - 02.02	DHD ZETEC-SE SEFI	4	1,3	PTR5A-13	2467	25		
Fiesta '96	1.25	55	11.95 - 02.02	DHE ZETEC-SE SEFI	4	1,3	PTR5A-13	2467	25		
Fiesta '96	1.25	55	11.95 - 02.02	DHC ZETEC-SE SEFI	4	1,3	PTR5A-13	2467	25		
Fiesta '96	1.25	55	11.95 - 02.02	DHF ZETEC-SE SEFI	4	1,3	PTR5A-13	2467	25		
Fiesta '96	1.25	55	11.95 - 02.02	DHG ZETEC-SE SEFI	4	1,3	PTR5A-13	2467	25		
Fiesta '96	1.25	55	11.95 - 02.02	DHA ZETEC-SE SEFI	4	1,3	PTR5A-13	2467	25		
Fiesta '96	1.25	55	11.95 - 02.02	DHB ZETEC-SE SEFI	4	1,3	PTR5A-13	2467	25		
Fiesta '96	1.3	37	11.95 - 02.02	JJC Endura-E SEFI	4	1,0	PTR5D-10	3784	31		
Fiesta '96	1.3	37	11.95 - 02.02	JJK Endura-E SEFI	4	1,0	PTR5D-10	3784	31		
Fiesta '96	1.3	37	11.95 - 02.02	JJJ Endura-E SEFI	4	1,0	PTR5D-10	3784	31		
Fiesta '96	1.3	37	11.95 - 02.02	JJA Endura-E SEFI	4	1,0	PTR5D-10	3784	31		

<sup>1)</sup> Bic = Best in class





ℓ kW

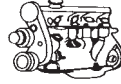

Cyl.

Order-  
No. No.Bic<sup>1)</sup> Order-  
D-Power No.**FORD**

Fiesta '96	1.3	37	11.95 - 02.02	JJM Endura-E SEFI	4	1,0	PTR5D-10	3784	31		
Fiesta '96	1.3	37	11.95 - 02.02	JJE Endura-E SEFI	4	1,0	PTR5D-10	3784	31		
Fiesta '96	1.3	44	11.95 - 02.02	J4J Endura-E SEFI	4	1,0	PTR5D-10	3784	31		
Fiesta '96	1.3	44	11.95 - 02.02	J4R Endura-E SEFI	4	1,0	PTR5D-10	3784	31		
Fiesta '96	1.3	44	11.95 - 02.02	J4T Endura-E SEFI	4	1,0	PTR5D-10	3784	31		
Fiesta '96	1.3	44	11.95 - 02.02	J4C Endura-E SEFI	4	1,0	PTR5D-10	3784	31		
Fiesta '96	1.3	44	11.95 - 02.02	J4Q Endura-E SEFI	4	1,0	PTR5D-10	3784	31		
Fiesta '96	1.3	44	11.95 - 02.02	J4L Endura-E SEFI	4	1,0	PTR5D-10	3784	31		
Fiesta '96	1.4	66	11.95 - 02.02	FHA ZETEC-SE SEFI	4	1,3	PTR5A-13	2467	25		
Fiesta '96	1.4	66	11.95 - 02.02	FHE ZETEC-SE SEFI	4	1,3	PTR5A-13	2467	25		
Fiesta '96	1.6	76	11.95 - 02.02	L1T ZETEC-SE SEFI	4	1,3	PTR5A-13	2467	25		
Fiesta '96	1.6	76	11.95 - 02.02	L1V ZETEC-SE SEFI	4	1,3	PTR5A-13	2467	25		
Fiesta '96	1.8	44	11.95 - 02.02	RTK	4	█	Y-937R	5148		D-POWER 5	7503
Fiesta '96	1.8	44	11.95 - 02.02	RTJ	4	█	Y-937R	5148		D-POWER 5	7503
Focus / C-Max TDCI	1.6	66	06.03 -	HHDB DuraTorq-TDCi	4	█	YE04	1101		D-POWER 40	1684
Focus / C-Max TDCI	1.6	66	06.03 -	HHDA DuraTorq-TDCi	4	█	YE04	1101		D-POWER 40	1684
Focus / C-Max	1.6	74	06.03 -	HWDB Duratec-16V SFI	4	1,3	PTR5A-13	2467	25		
Focus / C-Max	1.6	74	06.03 -	HWDA Duratec-16V SFI	4	1,3	PTR5A-13	2467	25		
Focus / C-Max TDCI	1.6	80	06.03 -	G8DA DuraTorq-TDCi	4	█	YE04	1101		D-POWER 40	1684
Focus / C-Max TDCI	1.6	80	06.03 -	G8DB DuraTorq-TDCi	4	█	YE04	1101		D-POWER 40	1684
Focus / C-Max	1.8	88	06.03 -	CSDA Duratec-HE SFI	4	1,3	ITR6F-13	4477			
Focus / C-Max	1.8	88	06.03 -	CSDB Duratec-HE SFI	4	1,3	ITR6F-13	4477			
Focus / C-Max	1.8	92	06.03 -	QQDB Duratec-HE SFI	4	1,3	ITR6F-13	4477			
Focus / C-Max	1.8	92	06.03 -	Q7DA Duratec-HE SFI	4	1,3	ITR6F-13	4477			
Focus / C-Max	1.8	92	06.03 -	QQDC Duratec-HE SFI	4	1,3	ITR6F-13	4477			
Focus / C-Max	1.8	92	06.03 -	QQDA Duratec-HE SFI	4	1,3	ITR6F-13	4477			
Focus / C-Max	2.0	107	06.03 -	AODA Duratec-HE SFI	4	1,3	ITR6F-13	4477			
Focus / C-Max	2.0	107	06.03 -	AODB Duratec-HE SFI	4	1,3	ITR6F-13	4477			
Focus '04	1.6	66	07.04 -	HHDA DuraTorq-TDCi	4	█	YE04	1101		D-POWER 40	1684
Focus '04	1.6	66	07.04 -	HHDB DuraTorq-TDCi	4	█	YE04	1101		D-POWER 40	1684
Focus '04	1.6	74	07.04 -	HWDB Duratec-16V SFI	4	1,3	PTR5A-13	2467	25		
Focus '04	1.6	74	07.04 -	HWDA Duratec-16V SFI	4	1,3	PTR5A-13	2467	25		
Focus '04	1.6	80	07.04 -	G8DB DuraTorq-TDCi	4	█	YE04	1101		D-POWER 40	1684
Focus '04	1.6	80	07.04 -	G8DA DuraTorq-TDCi	4	█	YE04	1101		D-POWER 40	1684
Focus '04	1.8	92	07.04 -	QQDB Duratec-HE SFI	4	1,3	ITR6F-13	4477			
Focus '04	1.8	92	07.04 -	Q7DA Duratec-HE SFI	4	1,3	ITR6F-13	4477			
Focus '04	2.0	107	07.04 -	AODA Duratec-HE SFI	4	1,3	ITR6F-13	4477			
Focus '04	2.0	107	07.04 -	AODB Duratec-HE SFI	4	1,3	ITR6F-13	4477			
Focus '98	1.4	55	08.98 - 12.04	FXDC ZETEC-SE SEFI	4	1,3	PTR5A-13	2467	25		
Focus '98	1.4	55	08.98 - 12.04	FXDA ZETEC-SE SFI	4	1,3	PTR5A-13	2467	25		
Focus '98	1.4	55	08.98 - 12.04	FXDB ZETEC-SE SFI	4	1,3	PTR5A-13	2467	25		
Focus '98	1.4	55	08.98 - 12.04	FXDD ZETEC-SE SFI	4	1,3	PTR5A-13	2467	25		
Focus '98	1.6	72	08.98 - 12.04	CDDA Duratec SFI	4	1,3	PTR5A-13	2467	25		
Focus '98	1.6	74	08.98 - 12.04	FYDD ZETEC-SE SFI	4	1,3	PTR5A-13	2467	25		
Focus '98	1.6	74	08.98 - 12.04	FYDC ZETEC-SE SFI	4	1,3	PTR5A-13	2467	25		
Focus '98	1.6	74	08.98 - 12.04	FYDA ZETEC-SE SFI	4	1,3	PTR5A-13	2467	25		
Focus '98	1.6	74	08.98 - 12.04	FYDH ZETEC-SE SFI	4	1,3	PTR5A-13	2467	25		
Focus '98	1.6	74	08.98 - 12.04	FYDB ZETEC-SE SFI	4	1,3	PTR5A-13	2467	25		
Focus '98	1.8	55	08.98 - 12.04	BHDB Endura-DI	4	█	Y-524J	5986		D-POWER 27	4520
Focus '98	1.8	55	08.98 - 12.04	BHDA Endura-DI	4	█	Y-524J	5986		D-POWER 27	4520
Focus '98	1.8	66	08.98 - 12.04	C9DB Endura-DI	4	█	Y-524J	5986		D-POWER 27	4520
Focus '98 Turbo Di	1.8	66	08.98 - 12.04	C9DC Endura-DI	4	█	Y-524J	5986		D-POWER 27	4520

<sup>1)</sup> Bic = Best in class



ℓ kW

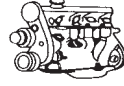

Cyl.

Order-  
No. No.Bic<sup>1)</sup> Order-  
D-Power No.**FORD**

Focus '98	1.8	66	08.98 - 12.04	C9DA Endura-DI	4	☑	Y-524J	5986		D-POWER 27	4520
Focus '98	1.8	74	08.98 - 12.04	FFDA DuraTorq-TDCi	4	☑	Y-524J	5986		D-POWER 27	4520
Focus '98	1.8	85	08.98 - 12.04	EYDL ZETEC-E SFI	4	1,0	TR5A-10	0005		PTR5A-10	5055
Focus '98	1.8	85	08.98 - 12.04	EYDC ZETEC-E SFI	4	1,3	PTR5A-13 *	2467	25		
Focus '98	1.8	85	08.98 - 12.04	EYDG ZETEC-E SFI	4	1,0	TR5A-10	0005		PTR5A-10	5055
Focus '98	1.8	85	08.98 - 12.04	EYDI ZETEC-E SFI	4	1,0	TR5A-10	0005		PTR5A-10	5055
Focus '98	1.8	85	08.98 - 12.04	EYDJ ZETEC-E SFI	4	1,0	TR5A-10	0005		PTR5A-10	5055
Focus '98	1.8	85	08.98 - 12.04	EYDF ZETEC-E SFI	4	1,3	PTR5A-13 *	2467	25		
Focus '98	1.8	85	08.98 - 12.04	EYDE ZETEC-E SFI	4	1,3	PTR5A-13 *	2467	25		
Focus '98	1.8	85	08.98 - 12.04	EYDD ZETEC-E SFI	4	1,3	PTR5A-13 *	2467	25		
Focus '98	1.8	85	08.98 - 12.04	EYDB ZETEC-E SFI	4	1,3	PTR5A-13 *	2467	25		
Focus '98 TDCi	1.8	85	08.98 - 12.04	F9DA DuraTorq-TDCi	4	☑	Y-524J	5986		D-POWER 27	4520
Focus '98	1.8	85	08.98 - 12.04	F9DB DuraTorq-TDCi	4	☑	Y-524J	5986		D-POWER 27	4520
Focus '98	2.0	96	08.98 - 12.04	EDDF ZETEC-E SFI	4	1,3	PTR5A-13 *	2467	25		
Focus '98	2.0	96	08.98 - 12.04	EDDB ZETEC-E SFI	4	1,3	PTR5A-13 *	2467	25		
Focus '98	2.0	96	08.98 - 12.04	EDDC ZETEC-E SFI	4	1,3	PTR5A-13 *	2467	25		
Focus '98	2.0	96	08.98 - 12.04	EDDD ZETEC-E SFI	4	1,3	PTR5A-13 *	2467	25		
Focus '98 RS Turbo	2.0	158	10.02 - 12.04	HMDA Duratec RS SFI	4	1,0	PLTR6A-10G	3587			
Fusion	1.25	55	06.02 -	FUJB Duratec 16V SFI	4	1,3	PTR5A-13	2467	25		
Fusion	1.25	55	06.02 -	FUJA Duratec 16V SFI	4	1,3	PTR5A-13	2467	25		
Fusion TDCi	1.4	50	06.02 -	F6JB DuraTorq-TDCi	4	☑	YE04	1101		D-POWER 40	1684
Fusion TDCi	1.4	50	06.02 -	F6JA DuraTorq-TDCi	4	☑	YE04	1101		D-POWER 40	1684
Fusion	1.4	59	06.02 -	FXJA Duratec 16V SFI	4	1,3	PTR5A-13	2467	25		
Fusion	1.4	59	06.02 -	FXJB Duratec 16V SFI	4	1,3	PTR5A-13	2467	25		
Fusion TDCi	1.6	66	06.02 -	HHJA DuraTorq-TDCi	4	☑	YE04	1101		D-POWER 40	1684
Fusion TDCi	1.6	66	06.02 -	HHJB DuraTorq-TDCi	4	☑	YE04	1101		D-POWER 40	1684
Fusion	1.6	74	06.02 -	FYJB Duratec 16V SFI	4	1,3	PTR5A-13	2467	25		
Fusion	1.6	74	06.02 -	FYJA Duratec 16V SFI	4	1,3	PTR5A-13	2467	25		
Galaxy TDI	1.9		06.95 -	AJM	4	☑	Y-732U	2408		D-POWER 4	6001
Galaxy TDI	1.9	66	02.95 - 02.96	1Z	4	☑	Y-732U	2408		D-POWER 4	6001
Galaxy TDI	1.9	66	02.95 - 03.00	ANU	4	☑	Y-732U	2408		D-POWER 4	6001
Galaxy TDI	1.9	66	09.96 - 03.00	AHU	4	☑	Y-732U	2408		D-POWER 4	6001
Galaxy TDI	1.9	66	03.96 - 03.00	1Z	4	☑	Y-732U	2408		D-POWER 4	6001
Galaxy TDI	1.9	81	02.95 - 08.99	AFN	4	☑	Y-732U	2408		D-POWER 4	6001
Galaxy TDI	1.9	81	09.99 - 03.00	AVG	4	☑	Y-732U	2408		D-POWER 4	6001
Galaxy	2.0	85	02.95 - 03.00	NSE DOHC SEFI	4	1,1	BKR7EVX-11	4685		BKR7EIX-11	6988
Galaxy 16V	2.3	107	02.95 - 03.00	Y5B DOHC 16V SEFI	4	1,1	BKR6EVX-11	3540		BKR6EIX-11	3764
Galaxy VR6 4x4	2.8	128	04.98 - 03.00	AMY CD V6 SEFI	6	0,8	BKR5EKUP	2890			
Galaxy VR6 4x4	2.8	128	02.95 - 03.98	AAA CD V6 SEFI	6	0,8	BKR5EKUP	2890			
Galaxy /2 TDI	1.9	66	04.00 - 02.06	ANU	4	☑	Y-732U	2408		D-POWER 4	6001
Galaxy /2 TDI	1.9	85	04.00 - 02.06	AUY	4	☑	Y-732U	2408		D-POWER 4	6001
Galaxy /2 TDI	1.9	96	04.00 - 02.06	ASZ	4	☑	Y-732U	2408		D-POWER 4	6001
Galaxy /2 TDI	1.9	110	04.00 - 02.06	BTB	4	☑	Y-732U	2408		D-POWER 4	6001
Galaxy /2	2.0	85	04.00 - 02.06	ZVSA DOHC SEFI	4	1,1	BKR7EVX-11	4685		BKR7EIX-11	6988
Galaxy /2 16V	2.3	103	04.00 - 02.06	E5SB DOHC 16V SEFI	4	1,1	BKR6EVX-11	3540		BKR6EIX-11	3764
Galaxy /2 16V	2.3	107	04.00 - 02.06	E5SA DOHC 16V SEFI	4	1,1	BKR6EVX-11	3540		BKR6EIX-11	3764
Galaxy /2 24V	2.8	150	04.00 - 02.06	AYL CD V6 24V SEFI	6	1,1	PZFR5D-11	7968	34		
Granada '85	1.8	66	05.85 - 10.94	REC OHC 2V	4	0,8	APR6FS	2922			
Granada '85	2.0	74	05.85 - 10.94	NE4 OHC 2V	4	0,8	APR6FS	2922			
Granada '85	2.0	74	05.85 - 10.94	NER OHC 2V	4	0,8	APR6FS	2922			
Granada '85	2.0	74	05.85 - 10.94	NRC OHC EFI	4	0,8	APR6FS	2922			
Granada '85	2.0	77	05.85 - 10.94	NEL OHC 2V Cat.	4	0,8	APR6FS	2922			

<sup>1)</sup> Bic = Best in class

\* Standardtype TR5A-10 / standard type TR5A-10



ℓ kW



Cyl.

Order-  
No. No.Bic<sup>1)</sup> Order-  
D-Power No.**FORD**

Granada '85	2.0	77	05.85 - 10.94	NEL OHC 2V	4	0,8	APR6FS	2922			
Granada '85	2.0	77	05.85 - 10.94	N8D DOHC 2V	4	0,8	BCPR6ES	2330	12	BCPR6EIX	5689
Granada '85	2.0	80	05.85 - 10.94	N8B DOHC 2V	4	0,8	BCPR6ES	2330	12	BCPR6EIX	5689
Granada '85	2.0	85	05.85 - 10.94	NRA OHC EFI Cat.	4	0,8	APR6FS	2922			
Granada '85	2.0	85	05.85 - 10.94	NRI OHC EFI	4	0,8	APR6FS	2922			
Granada '85	2.0	85	05.85 - 10.94	NRA OHC EFI	4	0,8	APR6FS	2922			
Granada '85	2.0	85	05.85 - 10.94	N9F DOHC EFI	4	0,8	BCPR6ES	2330	12	BCPR6EIX	5689
Granada '85	2.0	88	05.85 - 10.94	N9D DOHC EFI	4	0,8	BCPR6ES	2330	12	BCPR6EIX	5689
Granada '85	2.0	90	05.85 - 10.94	N9B DOHC EFI	4	0,8	BCPR6ES	2330	12	BCPR6EIX	5689
Granada '85	2.4	92	05.85 - 10.94	ARD V6 EFI	6	1,0	BPR6EFS	3623	7		
Granada '85	2.4	96	05.85 - 10.94	ARC V6 EFI	6	0,8	BCPR6ES	2330	12	BCPR6EIX	5689
Granada '85	2.5	51	05.85 - 10.94	STR D	4	█	Y-902R	2237		D-POWER 1	7906
Granada '85	2.5	68	05.85 - 10.94	SFA D TURBO	4	█	Y-902R	2237		D-POWER 1	7906
Granada '85	2.5	68	05.85 - 10.94	SFB D TURBO	4	█	Y-902R	2237		D-POWER 1	7906
Granada '85	2.8	105	05.85 - 10.94	PR4 V6 EFI	6	0,8	BPR6ES	7822	2	BPR6EIX	6637
Granada '85	2.8	107	05.85 - 10.94	PR3 V6 EFI	6	0,8	BPR6ES	7822	2	BPR6EIX	6637
Granada '85	2.8	110	05.85 - 10.94	PRE V6 EFI	6	0,8	BPR6ES	7822	2	BPR6EIX	6637
Granada '85	2.9	107	05.85 - 10.94	BRF V6 EFI	6	1,0	BPR6EFS	3623	7		
Granada '85	2.9	107	05.85 - 10.94	BRE V6 EFI	6	1,0	BPR6EFS	3623	7		
Granada '85	2.9	107	05.85 - 10.94	BRD V6 EFI	6	1,0	BPR6EFS	3623	7		
Granada '85	2.9	110	05.85 - 10.94	BRC V6 EFI	6	0,8	BCPR6ES	2330	12	BCPR6EIX	5689
Granada '85	2.9	143	05.85 - 10.94	BOA V6 24V EFI	6	1,1	BKR6EVX-11	3540		BKR6EIX-11	3764
Ka '96	1.3	36	09.96 -	JJD Endura-E SEFI	4	1,0	PTR5D-10	3784	31		
Ka '96	1.3	36	09.96 -	JJG Endura-E SEFI	4	1,0	PTR5D-10	3784	31		
Ka '96	1.3	36	09.96 -	JJF Endura-E SEFI	4	1,0	PTR5D-10	3784	31		
Ka '96	1.3	36	09.96 -	JJL Endura-E SEFI	4	1,0	PTR5D-10	3784	31		
Ka '96	1.3	36	09.96 -	JJH Endura-E SEFI	4	1,0	PTR5D-10	3784	31		
Ka '96	1.3	37	09.96 -	JJB Endura-E SEFI	4	1,0	PTR5D-10	3784	31		
Ka '96	1.3	44	09.96 -	J4D Endura-E SEFI	4	1,0	PTR5D-10	3784	31		
Ka '96	1.3	44	09.96 -	J4M Endura-E SEFI	4	1,0	PTR5D-10	3784	31		
Ka '96	1.3	44	09.96 -	J4N Endura-E SEFI	4	1,0	PTR5D-10	3784	31		
Ka '96	1.3	44	09.96 -	J4P Endura-E SEFI	4	1,0	PTR5D-10	3784	31		
Ka '96	1.3	44	09.96 -	BAA Duratec 8V SFI	4	1,3	PTR5A-13	2467	25		
Ka '96	1.3	44	09.96 -	J4K Endura-E SEFI	4	1,0	PTR5D-10	3784	31		
Ka '96	1.3	44	09.96 -	J4S Endura-E SEFI	4	1,0	PTR5D-10	3784	31		
Ka '96	1.3	51	09.96 -	A9A Duratec 8V SFI	4	1,3	PTR5A-13	2467	25		
Ka '96	1.3	51	09.96 -	A9B Duratec 8V SFI	4	1,3	PTR5A-13	2467	25		
Ka '96	1.6	70	09.96 -	CDB Duratec 8V SFI	4	1,3	PTR5A-13	2467	25		
Ka '96	1.6	70	09.96 -	CDC Duratec 8V SFI	4	1,3	PTR5A-13	2467	25		
Maverick '01 16V	2.0	91	12.00 - 11.03	YF ZETEC-E SFI	4	1,3	PTR5A-13	2467	25		
Maverick '01 16V	2.3	110	12.03 -	GZ Duratec-HE SFI	4	1,3	ITR6F-13	4477			
Maverick '01	3.0	145	12.00 - 11.03	AJ Duratec-VE SFI	6	1,1	TR5IX	7397		TR5IX	7397
Maverick '01	3.0	149	12.03 -	AJ Duratec-VE SFI	6	1,1	TR5IX	7397		TR5IX	7397
Maverick '93	2.4	85	06.93 - 04.98	KA24 OHC 12V SEFI	4	1,1	ZFR5E-11	4435			
Maverick '93	2.4	87	06.93 - 04.98	KA24 OHC 12V SEFI	4	1,1	ZFR5E-11	4435			
Maverick '93	2.4	91	06.93 - 04.98	KA24 OHC 12V SEFI	4	1,1	ZFR5E-11	4435			
Maverick '93	2.7	74	04.93 - 04.98	TD27	4	█	Y-712RS	6140			
Maverick '93	2.7	92	05.96 - 04.98	TD27E	4	█	CY58	5486			
Mondeo '01	1.8	81	10.00 -	CGBB Duratec-HE SFI	4	1,3	PTR6F-13	7569			
Mondeo '01	1.8	81	10.00 -	CGBA Duratec-HE SFI	4	1,3	PTR6F-13	7569			
Mondeo '01	1.8	92	10.00 -	CHBB Duratec-HE SFI	4	1,3	PTR6F-13	7569			
Mondeo '01	1.8	92	10.00 -	CHBA Duratec-HE SFI	4	1,3	PTR6F-13	7569			

<sup>1)</sup> Bic = Best in class



ℓ kW

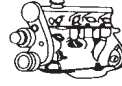

Cyl.

Order-  
No. No.Bic<sup>1)</sup> Order-  
D-Power No.**FORD**

Mondeo '01 TDCi	2.0	66	10.00 -	D5BA DuraTorq-DI	4	☑	Y-525J	7925		D-POWER 35	4090
Mondeo '01 TDCi	2.0	85	10.00 -	HJBC DuraTorq-TDCi	4	☑	Y-525J	7925		D-POWER 35	4090
Mondeo '01 TDCi	2.0	85	10.00 -	D6BA DuraTorq-DI	4	☑	Y-525J	7925		D-POWER 35	4090
Mondeo '01 TDCi	2.0	85	10.00 -	HJBA DuraTorq-TDCi	4	☑	Y-525J	7925		D-POWER 35	4090
Mondeo '01 TDCi	2.0	85	10.00 -	HJBB DuraTorq-TDCi	4	☑	Y-525J	7925		D-POWER 35	4090
Mondeo '01 TDCi	2.0	85	10.00 -	SDBA DuraTorq-TDCi	4	☑	Y-525J	7925		D-POWER 35	4090
Mondeo '01 TDCi	2.0	96	10.00 -	N7BA DuraTorq-TDCi	4	☑	Y-525J	7925		D-POWER 35	4090
Mondeo '01 TDCi	2.0	96	10.00 -	FMBA DuraTorq-TDCi	4	☑	Y-525J	7925		D-POWER 35	4090
Mondeo '01	2.0	107	10.00 -	CJBA Duratec-HE SFI	4	1,3	PTR6F-13	7569			
Mondeo '01	2.0	107	10.00 -	CJBB Duratec-HE SFI	4	1,3	PTR6F-13	7569			
Mondeo '01 TDCi	2.2	110	09.04 -	QJBC DuraTorq-TDCi	4	☑	Y-525J	7925		D-POWER 35	4090
Mondeo '01 TDCi	2.2	110	09.04 -	QJBD DuraTorq-TDCi	4	☑	Y-525J	7925		D-POWER 35	4090
Mondeo '01 TDCi	2.2	114	09.04 -	QJBA DuraTorq-TDCi	4	☑	Y-525J	7925		D-POWER 35	4090
Mondeo '01 TDCi	2.2	114	09.04 -	QJBB DuraTorq-TDCi	4	☑	Y-525J	7925		D-POWER 35	4090
Mondeo '01	2.5	125	10.00 -	LCBD Duratec-VE SFI	6	1,3	TR55IX	7164		TR55IX	7164
Mondeo '01	3.0	150	10.00 -	REBA Duratec-ST SFI	6	1,3	PTR6D-13G	6989			
Mondeo '01 ST 220	3.0	166	10.00 -	MEBA Duratec-ST SFI	6	1,3	PTR6D-13G	6989			
Mondeo '93	1.6	65	01.93 - 07.96	L1J ZETEC-E SEFI	4	1,3	PTR5A-13 *	2467	25		
Mondeo '93	1.6	66	01.93 - 07.96	L1F ZETEC SEFI	4	1,3	PTR5A-13	2467	25		
Mondeo '93	1.8	65	01.93 - 07.96	RFN D TCI	4	☑	Y-910R	4751		D-POWER 3	3617
Mondeo '93	1.8	65	01.93 - 07.96	RFM D TCI	4	☑	Y-910R	4751		D-POWER 3	3617
Mondeo '93	1.8	82	01.93 - 07.96	RKB ZETEC-E SEFI	4	1,3	PTR5A-13 *	2467	25		
Mondeo '93	1.8	85	01.93 - 07.96	RKA ZETEC SEFI	4	1,3	PTR5A-13	2467	25		
Mondeo '93	2.0	100	01.93 - 07.96	NGA ZETEC SEFI	4	1,3	PTR5A-13	2467	25		
Mondeo '93	2.5	125	01.93 - 07.96	SEA Duratec-VE SEFI	6	1,3	TR55	1048		TR55IX	7164
Mondeo '97	1.6	65	08.96 - 09.00	L1J ZETEC-E SEFI	4	1,3	PTR5A-13 *	2467	25		
Mondeo '97	1.6	70	08.96 - 09.00	L1N ZETEC-E SEFI	4	1,3	PTR5A-13 *	2467	25		
Mondeo '97	1.6	70	08.96 - 09.00	L1Q ZETEC-E SEFI	4	1,3	PTR5A-13 *	2467	25		
Mondeo '97	1.6	70	08.96 - 09.00	L1L ZETEC-E SEFI	4	1,3	PTR5A-13 *	2467	25		
Mondeo '97	1.8	66	08.96 - 09.00	RFN Endura-De TCI	4	☑	Y-937R	5148		D-POWER 5	7503
Mondeo '97	1.8	85	08.96 - 09.00	RKJ ZETEC-E SEFI	4	1,3	PTR5A-13 *	2467	25		
Mondeo '97	1.8	85	08.96 - 09.00	RKH ZETEC-E SEFI	4	1,3	PTR5A-13 *	2467	25		
Mondeo '97	1.8	85	08.96 - 09.00	RKF ZETEC-E SEFI	4	1,3	PTR5A-13 *	2467	25		
Mondeo '97	1.8	85	08.96 - 09.00	RKB ZETEC-E SEFI	4	1,3	PTR5A-13 *	2467	25		
Mondeo '97	1.8	85	08.96 - 09.00	RKK ZETEC-E SEFI	4	1,3	PTR5A-13 *	2467	25		
Mondeo '97	2.0	96	08.96 - 09.00	NGD ZETEC-E SEFI	4	1,3	PTR5A-13 *	2467	25		
Mondeo '97	2.0	96	08.96 - 09.00	NGC ZETEC-E SEFI	4	1,3	PTR5A-13 *	2467	25		
Mondeo '97	2.0	96	08.96 - 09.00	NGA ZETEC-E SEFI	4	1,3	PTR5A-13 *	2467	25		
Mondeo '97	2.0	96	08.96 - 09.00	NGB ZETEC-E SEFI	4	1,3	PTR5A-13 *	2467	25		
Mondeo '97	2.5	125	08.96 - 09.00	SEA Duratec-VE SEFI	6	1,3	TR55	1048		TR55IX	7164
Mondeo '97	2.5	125	08.96 - 09.00	SEB Duratec-VE SEFI	6	1,3	TR55	1048		TR55IX	7164
Mondeo '97	2.5	125	08.96 - 09.00	SEC Duratec-VE SEFI	6	1,3	TR55	1048		TR55IX	7164
Mondeo '97 ST 200	2.5	151	08.96 - 09.00	SGA Duratec-VE SEFI	6	1,3	PTR6D-13G	6989			
Orion '86	1.3	44	01.86 - 07.90	JBB HCS 2V	4	1,0	BPR6EFS	3623	7		
Orion '86	1.3	44	01.86 - 07.90	JLB VAL VV	4	1,0	BPR6EFS	3623	7		
Orion '86	1.3	44	01.86 - 07.90	JLA VAL VV Cat.	4	1,0	BPR6EFS	3623	7		
Orion '86	1.3	44	01.86 - 07.90	JLA VAL VV	4	1,0	BPR6EFS	3623	7		
Orion '86	1.4	54	01.86 - 07.90	F6B CVH CFI	4	1,1	BCPR6ES-11	7121	11	BCPR6EIX-11	4919
Orion '86	1.4	54	01.86 - 07.90	F6D CVH CFI	4	1,1	BCPR6ES-11	7121	11	BCPR6EIX-11	4919
Orion '86	1.4	54	01.86 - 07.90	FUC CVH 2V	4	1,1	BCPR7ES-11	1095		BCPR7EIX-11	5691
Orion '86	1.4	55	01.86 - 07.90	FUA CVH 2V Cat.	4	0,8	BCPR6ES	2330	12	BCPR6EIX	5689
Orion '86	1.4	55	01.86 - 07.90	FUA CVH 2V	4	0,8	BCPR6ES	2330	12	BCPR6EIX	5689

<sup>1)</sup> Bic = Best in class

\* Standardtype TR5A-10 / standard type TR5A-10



ℓ kW

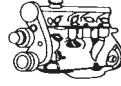

Cyl.

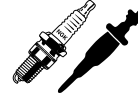
Order-  
No. No.Bic<sup>1)</sup> Order-  
D-Power No.**FORD**

Orion '86	1.6	40	01.86 - 07.90	LTC	4	█	Y-907R	4479			
Orion '86	1.6	65	01.86 - 07.90	LUG CVH 2V	4	0,8	BCPR6ES	2330	12	BCPR6EIX	5689
Orion '86	1.6	66	01.86 - 07.90	L4B CVH FI	4	0,8	BCPR6ES	2330	12	BCPR6EIX	5689
Orion '86	1.6	66	01.86 - 07.90	LUC CVH 2V Cat.	4	0,8	BCPR6ES	2330	12	BCPR6EIX	5689
Orion '86	1.6	66	01.86 - 07.90	LUC CVH 2V	4	0,8	BCPR6ES	2330	12	BCPR6EIX	5689
Orion '86	1.6	75	01.86 - 07.90	LJB CVH EFI	4	1,1	BCPR6ES-11	7121	11	BCPR6EIX-11	4919
Orion '86	1.6	77	01.86 - 07.90	LRB CVH FI Cat.	4	0,8	BCPR7ES	3330		BCPR7EIX	5690
Orion '86	1.6	77	01.86 - 07.90	LRB CVH FI	4	0,8	BCPR7ES	3330		BCPR7EIX	5690
Orion '86	1.6	79	01.86 - 07.90	LJA CVH EFI	4	1,1	BCPR6ES-11	7121	11	BCPR6EIX-11	4919
Orion '86	1.8	44	01.86 - 07.90	RTA	4	█	Y-910R	4751		D-POWER 3	3617
Orion '86	1.8	44	01.86 - 07.90	RTB	4	█	Y-910R	4751		D-POWER 3	3617
Orion '91	1.3	44	08.90 - 07.93	J6A HCS CFI	4	1,0	PTR5D-10	3784	31		
Orion '91	1.3	44	08.90 - 07.93	JBE HCS 2V	4	1,0	PTR5D-10	3784	31		
Orion '91	1.3	46	08.90 - 07.93	JBD HCS 2V	4	1,0	PTR5D-10	3784	31		
Orion '91	1.4	52	08.90 - 07.93	F6G CVH CFI	4	1,1	BCPR6ES-11	7121	11	BCPR6EIX-11	4919
Orion '91	1.4	52	08.90 - 07.93	F6F CVH CFI	4	1,1	BCPR6ES-11	7121	11	BCPR6EIX-11	4919
Orion '91	1.4	54	08.90 - 07.93	FUH CVH 2V	4	0,8	BCPR6ES	2330	12	BCPR6EIX	5689
Orion '91	1.6	66	08.90 - 07.93	L1E ZETEC SEFI	4	1,3	PTR5A-13	2467	25		
Orion '91	1.6	66	08.90 - 07.93	LUJ CVH 2V	4	0,8	BCPR6ES	2330	12	BCPR6EIX	5689
Orion '91	1.6	66	08.90 - 07.93	LUK CVH 2V	4	0,8	BCPR6ES	2330	12	BCPR6EIX	5689
Orion '91	1.6	77	08.90 - 07.93	LJF CVH EFI	4	1,1	BCPR6ES-11	7121	11	BCPR6EIX-11	4919
Orion '91	1.6	79	08.90 - 07.93	LJE CVH EFI	4	1,1	BCPR6ES-11	7121	11	BCPR6EIX-11	4919
Orion '91	1.8	44	08.90 - 07.93	RTF	4	█	Y-910R	4751		D-POWER 3	3617
Orion '91	1.8	44	08.90 - 07.93	RTH	4	█	Y-910R	4751		D-POWER 3	3617
Orion '91	1.8	44	08.90 - 07.93	RTE	4	█	Y-910R	4751		D-POWER 3	3617
Orion '91	1.8	66	08.90 - 07.93	RFK	4	█	Y-910R	4751		D-POWER 3	3617
Orion '91	1.8	66	08.90 - 07.93	RFD	4	█	Y-910R	4751		D-POWER 3	3617
Orion '91	1.8	77	08.90 - 07.93	RDA ZETEC SEFI	4	1,3	PTR5A-13	2467	25		
Orion '91	1.8	96	08.90 - 07.93	RQB ZETEC SEFI	4	1,3	PTR5A-13	2467	25		
P 100	2.3		82 -			█	Y-902R	2237		D-POWER 1	7906
P 100 Turbo	1.8		89 -		4	█	Y-910R	4751		D-POWER 3	3617
P 100 Pick-Up	1.8	55	10.87 - 12.92	RFA DT	4	█	Y-910R	4751		D-POWER 3	3617
P 100 Pick-Up	2.0	57	10.87 - 12.92	NAE OHC VV	4	0,8	APR6FS	2922			
Probe	2.0	85	01.93 - 07.97	FS DOHC 16V SEFI	4	1,1	BCPR6ES-11	7121	11	BCPR6EIX-11	4919
Probe GT	2.2	108	03.91 - 12.92	OHC EFI	4	1,1	ZFR6F-11	4291		ZFR6FIX-11	6441
Probe	2.5	120	01.93 - 07.97	KL V6 24V EFI	6	1,1	ZFR6F-11	4291		ZFR6FIX-11	6441
Puma '97	1.4	66	06.97 - 12.01	FHD ZETEC-SE SEFI	4	1,3	PTR5A-13	2467	25		
Puma '97	1.4	66	06.97 - 12.01	FHF ZETEC-SE SEFI	4	1,3	PTR5A-13	2467	25		
Puma '97	1.6	76	06.97 - 12.01	L1W ZETEC-SE SFI	4	1,3	PTR5A-13	2467	25		
Puma '97	1.7	92	06.97 - 12.01	MHA ZETEC-S VCT SFI	4	1,3	PTR5A-13	2467	25		
Puma '97	1.7	92	06.97 - 12.01	MHB ZETEC-S VCT SFI	4	1,3	PTR5A-13	2467	25		
Scorpio '85	1.8	66	05.85 - 10.94	REC OHC 2V	4	0,8	APR6FS	2922			
Scorpio '85	2.0	74	05.85 - 10.94	NRC OHC EFI	4	0,8	APR6FS	2922			
Scorpio '85	2.0	74	05.85 - 10.94	NE4 OHC 2V	4	0,8	APR6FS	2922			
Scorpio '85	2.0	74	05.85 - 10.94	NER OHC 2V	4	0,8	APR6FS	2922			
Scorpio '85	2.0	77	05.85 - 10.94	NEL OHC 2V	4	0,8	APR6FS	2922			
Scorpio '85	2.0	77	05.85 - 10.94	NEL OHC 2V Cat.	4	0,8	APR6FS	2922			
Scorpio '85	2.0	77	05.85 - 10.94	N8D DOHC 2V	4	0,8	BCPR6ES	2330	12	BCPR6EIX	5689
Scorpio '85	2.0	80	05.85 - 10.94	N8B DOHC 2V	4	0,8	BCPR6ES	2330	12	BCPR6EIX	5689
Scorpio '85	2.0	85	05.85 - 10.94	NRA OHC EFI	4	0,8	APR6FS	2922			
Scorpio '85	2.0	85	05.85 - 10.94	NRA OHC EFI Cat.	4	0,8	APR6FS	2922			
Scorpio '85	2.0	85	05.85 - 10.94	NRI OHC EFI	4	0,8	APR6FS	2922			

<sup>1)</sup> Bic = Best in class



ℓ kW

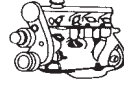

Cyl.

Order-  
No. No.Bic<sup>1)</sup> Order-  
D-Power No.**FORD**

Scorpio '85	2.0	85	05.85 - 10.94	N9F DOHC EFI	4	0,8	BCPR6ES	2330	12	BCPR6EIX	5689
Scorpio '85	2.0	88	05.85 - 10.94	N9D DOHC EFI	4	0,8	BCPR6ES	2330	12	BCPR6EIX	5689
Scorpio '85	2.0	90	05.85 - 10.94	N9B DOHC EFI	4	0,8	BCPR6ES	2330	12	BCPR6EIX	5689
Scorpio '85	2.4	92	05.85 - 10.94	ARD V6 EFI	6	1,0	BPR6EFS	3623	7		
Scorpio '85	2.4	96	05.85 - 10.94	ARC V6 EFI	6	0,8	BCPR6ES	2330	12	BCPR6EIX	5689
Scorpio '85	2.5		11.94 - 07.98	SCB	4	█	Y-741U	5065		D-POWER 20	6943
Scorpio '85	2.5	51	05.85 - 10.94	STR D	4	█	Y-902R	2237		D-POWER 1	7906
Scorpio '85	2.5	68	05.85 - 10.94	SFB D TURBO	4	█	Y-902R	2237		D-POWER 1	7906
Scorpio '85	2.5	68	05.85 - 10.94	SFA D TURBO	4	█	Y-902R	2237		D-POWER 1	7906
Scorpio '85	2.8	105	05.85 - 10.94	PR4 V6 EFI	6	0,8	BPR6ES	7822	2	BPR6EIX	6637
Scorpio '85	2.8	107	05.85 - 10.94	PR3 V6 EFI	6	0,8	BPR6ES	7822	2	BPR6EIX	6637
Scorpio '85	2.8	110	05.85 - 10.94	PRE V6 EFI	6	0,8	BPR6ES	7822	2	BPR6EIX	6637
Scorpio '85	2.9	107	05.85 - 10.94	BRE V6 EFI	6	1,0	BPR6EFS	3623	7		
Scorpio '85	2.9	107	05.85 - 10.94	BRF V6 EFI	6	1,0	BPR6EFS	3623	7		
Scorpio '85	2.9	107	05.85 - 10.94	BRD V6 EFI	6	1,0	BPR6EFS	3623	7		
Scorpio '85	2.9	110	05.85 - 10.94	BRC V6 EFI	6	0,8	BCPR6ES	2330	12	BCPR6EIX	5689
Scorpio '85	2.9	143	05.85 - 10.94	BOA V6 24V EFI	6	1,1	BKR6EVX-11	3540		BKR6EIX-11	3764
Scorpio '95	2.0	85	10.94 - 06.98	NSD DOHC 8V SEFI	4	1,1	PFR6B-11	4014			
Scorpio '95	2.0	100	10.94 - 06.98	N3A DOHC 16V SEFI	4	1,1	PFR6B-11	4014			
Scorpio '95	2.3	108	10.94 - 06.98	Y5A 16V SEFI	4	1,1	BKR6EVX-11	3540		BKR6EIX-11	3764
Scorpio '95	2.5	85	10.94 - 06.98	SCC TCI	4	█	Y-741U	5065		D-POWER 20	6943
Scorpio '95	2.5	92	10.94 - 06.98	SCD TCI	4	█	Y-741U	5065		D-POWER 20	6943
Scorpio '95	2.9	110	10.94 - 06.98	BRG V6 12V SEFI	6	1,0	BPR6EFS	3623	7		
Scorpio '95	2.9	152	10.94 - 06.98	BOB V6 24V SEFI	6	1,1	PFR6B-11	4014			
Sierra '87	1.6	53	01.87 - 12.92	LSF OHC 2V	4	0,8	APR6FS	2922			
Sierra '87	1.6	55	01.87 - 12.92	LSE OHC 2V	4	0,8	APR6FS	2922			
Sierra '87	1.6	55	01.87 - 12.92	LSE OHC 2V Cat.	4	0,8	APR6FS	2922			
Sierra '87	1.6	59	01.87 - 12.92	L6B CVH CFI	4	1,1	BCPR6ES-11	7121	11	BCPR6EIX-11	4919
Sierra '87	1.8	55	01.87 - 12.92	RFL	4	█	Y-910R	4751		D-POWER 3	3617
Sierra '87	1.8	55	01.87 - 12.92	RFA	4	█	Y-910R	4751		D-POWER 3	3617
Sierra '87	1.8	55	01.87 - 12.92	RFB	4	█	Y-910R	4751		D-POWER 3	3617
Sierra '87	1.8	59	01.87 - 12.92	REF OHC 2V	4	0,8	APR6FS	2922			
Sierra '87	1.8	59	01.87 - 12.92	RED OHC 2V Cat.	4	0,8	APR6FS	2922			
Sierra '87	1.8	63	01.87 - 12.92	R6A CVH CFI	4	1,1	BCPR6ES-11	7121	11	BCPR6EIX-11	4919
Sierra '87	1.8	64	01.87 - 12.92	R2C CVH 2V	4	1,1	BCPR6ES-11	7121	11	BCPR6EIX-11	4919
Sierra '87	1.8	66	01.87 - 12.92	RED OHC 2V	4	0,8	APR6FS	2922			
Sierra '87	1.8	66	01.87 - 12.92	R2A CVH 2V	4	1,1	BCPR6ES-11	7121	11	BCPR6EIX-11	4919
Sierra '87	2.0	74	01.87 - 12.92	NE5 OHC 2V	4	0,8	APR6FS	2922			
Sierra '87	2.0	74	01.87 - 12.92	N4B OHC EFI	4	0,8	APR6FS	2922			
Sierra '87	2.0	74	01.87 - 12.92	NEJ OHC 2V	4	0,8	APR6FS	2922			
Sierra '87	2.0	77	01.87 - 12.92	NES OHC 2V	4	0,8	APR6FS	2922			
Sierra '87	2.0	77	01.87 - 12.92	N8C DOHC 2V	4	0,8	BCPR6ES	2330	12	BCPR6EIX	5689
Sierra '87	2.0	77	01.87 - 12.92	NES OHC 2V Cat.	4	0,8	APR6FS	2922			
Sierra '87	2.0	80	01.87 - 12.92	N8A DOHC 2V	4	0,8	BCPR6ES	2330	12	BCPR6EIX	5689
Sierra '87	2.0	85	01.87 - 12.92	N4I OHC EFI	4	0,8	APR6FS	2922			
Sierra '87	2.0	85	01.87 - 12.92	N4A OHC EFI Cat.	4	0,8	APR6FS	2922			
Sierra '87	2.0	85	01.87 - 12.92	N9E DOHC EFI	4	0,8	BCPR6ES	2330	12	BCPR6EIX	5689
Sierra '87	2.0	85	01.87 - 12.92	N4A OHC EFI	4	0,8	APR6FS	2922			
Sierra '87	2.0	88	01.87 - 12.92	N9C DOHC EFI	4	0,8	BCPR6ES	2330	12	BCPR6EIX	5689
Sierra '87	2.0	90	01.87 - 12.92	N9A DOHC EFI	4	0,8	BCPR6ES	2330	12	BCPR6EIX	5689
Sierra '87	2.0	150	01.87 - 12.92	N5B DOHC COSWORTH	4	0,9	R7234-9	5487			
Sierra '87	2.0	162	01.87 - 12.92	N5D DOHC COSWORTH	4	1,1	PFR7B-11	5667			

<sup>1)</sup> Bic = Best in class



ℓ kW

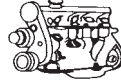

Cyl.

Order-  
No. No.Bic<sup>1)</sup> Order-  
D-Power No.**FORD**

Sierra '87	2.0	162	01.87 - 12.92	N5C DOHC COSWORTH	4	1,1	PFR7B-11	5667			
Sierra '87	2.3	49	01.87 - 12.92	YTR	4	█	Y-902R	2237		D-POWER 1	7906
Sierra '87	2.8	105	01.87 - 12.92	PR8 V6 EFI	6	0,8	BPR6ES	7822	2	BPR6EIX	6637
Sierra '87	2.8	107	01.87 - 12.92	PR7 V6 EFI	6	0,8	BPR6ES	7822	2	BPR6EIX	6637
Sierra '87	2.8	110	01.87 - 12.92	PRG V6 FI	6	0,8	BPR6ES	7822	2	BPR6EIX	6637
Sierra '87	2.9	107	01.87 - 12.92	B4B V6 EFI	6	1,0	BPR6EFS	3623	7		
Sierra '87	2.9	107	01.87 - 12.92	B4C V6 EFI	6	1,0	BPR6EFS	3623	7		
Sierra '87	2.9	110	01.87 - 12.92	B4A V6 EFI	6	0,8	BCPR6ES	2330	12	BCPR6EIX	5689
S-MAX/Galaxy 2006.5	2.0	96	03.06 -	AZWA Duratorq-TDCi	4	█	Y-525J	7925		D-POWER 35	4090
S-MAX/Galaxy 2006.5	2.0	103	03.06 -	QXWA Duratorq-TDCi	4	█	Y-525J	7925		D-POWER 35	4090
S-MAX/Galaxy 2006.5	2.0	103	03.06 -	QXWB ohne DPF	4	█	Y-525J	7925		D-POWER 35	4090
S-MAX/Galaxy 2006.5	2.0	107	03.06 -	AOWA Duratec-HE	4	1,3	ITR6F-13	4477			
Streetka	1.6	70	01.03 - 07.05	CDRB Duratec 8V	4	1,3	PTR5A-13	2467	25		
Streetka	1.6	70	01.03 - 07.05	CDRA Duratec 8V	4	1,3	PTR5A-13	2467	25		
Tourneo Connect	1.8	55	06.02 -	BHPA Endura-DI	4	█	Y-524J	5986		D-POWER 27	4520
Tourneo Connect	1.8	66	06.02 -	HCPB Duratorq-TDCi	4	█	Y-524J	5986		D-POWER 27	4520
Tourneo Connect	1.8	66	06.02 -	HCPA Duratorq-TDCi	4	█	Y-524J	5986		D-POWER 27	4520
Tourneo Connect	1.8	81	06.02 -	RWPA Duratorq-TDCi	4	█	Y-524J	5986		D-POWER 27	4520
Tourneo Connect	1.8	85	06.02 -	EYPC ZETEC-E SFI	4	1,0	TR5A-10	0005		PTR5A-10	5055
Tourneo Connect	1.8	85	06.02 -	EYPA ZETEC-E SFI	4	1,3	PTR5A-13	2467	25		
Transit Connect	1.8	55	06.02 -	BHPA Endura-DI	4	█	Y-524J	5986		D-POWER 27	4520
Transit Connect	1.8	66	06.02 -	HCPB Duratorq-TDCi	4	█	Y-524J	5986		D-POWER 27	4520
Transit Connect	1.8	66	06.02 -	HCPA Duratorq-TDCi	4	█	Y-524J	5986		D-POWER 27	4520
Transit Connect	1.8	85	06.02 -	EYPC ZETEC-E SFI	4	1,0	TR5A-10	0005		PTR5A-10	5055
Transit Connect	1.8	85	06.02 -	EYPA ZETEC-E SFI	4	1,3	PTR5A-13	2467	25		
Transit '86	1.6	46	01.86 - 07.91	LAT OHC VV	4	0,8	APR6FS	2922			
Transit '86	1.6	46	01.86 - 07.91	LAC OHC VV	4	0,8	APR6FS	2922			
Transit '86	2.0	55	01.86 - 07.91	NAV OHC VV	4	0,8	APR6FS	2922			
Transit '86	2.0	56	01.86 - 07.91	NAX OHC	4	0,8	APR6FS	2922			
Transit '86	2.0	56	01.86 - 07.91	NAW OHC	4	0,8	APR6FS	2922			
Transit '86	2.0	57	01.86 - 07.91	N6T OHC CFI	4	0,8	APR6FS	2922			
Transit '86	2.0	57	01.86 - 07.91	NAT OHC VV	4	0,8	APR6FS	2922			
Transit '86	2.0	60	01.86 - 07.91	N6TS OHC CFI	4	0,8	APR6FS	2922			
Transit '86	2.9	110	01.86 - 07.91	B4T V6 EFI	6	0,8	BCPR6ES	2330	12	BCPR6EIX	5689
Transit '86	3.0	78	01.86 - 07.91	HXC V6 ESX 1V	6	0,8	BPR6ES	7822	2	BPR6EIX	6637
Transit '92	2.0	66	08.91 - 07.94	NBA OHC 2V	4	0,8	APR6FS	2922			
Transit '92	2.0	72	08.91 - 07.94	NCA OHC EFI	4	0,8	APR6FS	2922			
Transit '92	2.9	107	08.91 - 07.94	BRT V6 EFI	6	1,1	BCPR6ES-11	7121	11	BCPR6EIX-11	4919
Transit '95	2.0	84	08.94 - 07.00	NSF DOHC 8V SEFI	4	1,1	BKR7EVX-11	4685		BKR7EIX-11	6988
Transit '95	2.0	84	08.94 - 07.00	NSH DOHC-8V SEFI	4	1,1	BKR7EVX-11	4685		BKR7EIX-11	6988
Transit '95	2.0	84	08.94 - 07.00	NSG DOHC 8V SEFI	4	1,1	BKR7EVX-11	4685		BKR7EIX-11	6988
Transit 2000.5 ( <sup>2</sup> Vorderradantrieb)	2.0	55	08.00 - 05.06	D3FA	4	█	Y-525J	7925		D-POWER 35	4090
Transit 2000.5 ( <sup>2</sup> Vorderradantrieb)	2.0	63	08.00 - 05.06	F3FA	4	█	Y-525J	7925		D-POWER 35	4090
Transit 2000.5 ( <sup>2</sup> Vorderradantrieb)	2.0	74	08.00 - 05.06	ABFA	4	█	Y-525J	7925		D-POWER 35	4090
Transit 2000.5 ( <sup>2</sup> Vorderradantrieb)	2.0	92	08.00 - 05.06	F1FA	4	█	Y-525J	7925		D-POWER 35	4090
Transit 2000.5 ( <sup>3</sup> Hinterradantrieb)	2.3	107	01.00 - 05.06	E5FC	4	1,1	PFR6B-11	4014			
Transit 2000.5 ( <sup>3</sup> Hinterradantrieb)	2.3	107	01.00 - 05.06	E5FA	4	1,1	PFR6B-11	4014			
Transit 2000.5 ( <sup>3</sup> Hinterradantrieb)	2.4	55	01.00 - 05.06	F4FA	4	█	Y-525J	7925		D-POWER 35	4090
Transit 2000.5 ( <sup>3</sup> Hinterradantrieb)	2.4	66	01.00 - 05.06	D2FA	4	█	Y-525J	7925		D-POWER 35	4090
Transit 2000.5 ( <sup>3</sup> Hinterradantrieb)	2.4	66	01.00 - 05.06	D2FB	4	█	Y-525J	7925		D-POWER 35	4090
Transit 2000.5 ( <sup>3</sup> Hinterradantrieb)	2.4	85	01.00 - 05.06	FXFA	4	█	Y-525J	7925		D-POWER 35	4090
Transit 2000.5 ( <sup>3</sup> Hinterradantrieb)	2.4	88	01.00 - 05.06	D4FA	4	█	Y-525J	7925		D-POWER 35	4090

<sup>1)</sup> Bic = Best in class    <sup>2)</sup> Front wheel drive    <sup>3)</sup> Rear wheel drive



ℓ kW

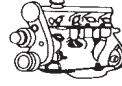

Cyl.

Order-  
No. No.Bic<sup>1)</sup> Order-  
D-Power No.**FORD**

Transit 2000.5 ( <sup>3</sup> Hinterradantrieb )	2.4	92	01.00 - 05.06	DOFA	4	█	Y-525J	7925		D-POWER 35	4090
Transit 2000.5 ( <sup>3</sup> Hinterradantrieb )	2.4	101	01.00 - 05.06	H9FA	4	█	Y-525J	7925		D-POWER 35	4090
Transit 2006.5 ( <sup>2</sup> Vorderradantrieb )	2.2	63	04.06 -	P8FA	4	█	Y-525J	7925		D-POWER 35	4090
Transit 2006.5 ( <sup>2</sup> Vorderradantrieb )	2.2	81	04.06 -	QVFA	4	█	Y-525J	7925		D-POWER 35	4090
Transit 2006.5 ( <sup>2</sup> Vorderradantrieb )	2.2	96	04.06 -	QWFA	4	█	Y-525J	7925		D-POWER 35	4090
Transit 2006.5 ( <sup>3</sup> Hinterradantrieb )	2.4	74	04.06 -	PHFA	4	█	Y-525J	7925		D-POWER 35	4090
Transit 2006.5 ( <sup>3</sup> Hinterradantrieb )	2.4	85	04.06 -	JXFA	4	█	Y-525J	7925		D-POWER 35	4090
Transit 2006.5 ( <sup>3</sup> Hinterradantrieb )	2.4	103	04.06 -	H9FB	4	█	Y-525J	7925		D-POWER 35	4090
Windstar	3.0	109	10.94 -	V6 SEFI	6	1,3	TR5	7837		TR5IX	7397

**FORD (USA)**

Bronco	4.9		87 - 95	Y EFI	6	1,1	WR4-1	4258			
Bronco	5.0		85 - 96	N EFI	8	1,1	UR4	4762		UR4IX	7401
Bronco	5.8		88 - 95	H EFI	8	1,1	UR5	2139		UR5IX	7177
Bronco II	2.3		88 - 88	A EFI	4	1,1	TR5-1	2321		TR5-1IX	7243
Bronco II	2.9		86 - 90	T EFI	6	1,1	TR5	7837		TR5IX	7397
Bronco II	4.0		90 -	X EFI	6	1,1	TR55	1048		TR55IX	7164
GT	5.4	368	09.06 -		8	1,0	TR6	6078			
Mustang (Mexico)	3.0		06 -	V6 24V DOHC	6	1,5	TR55	1048		TR55IX	7164
Mustang	3.8		03 -	V6	6	1,5	TR55	1048		TR55IX	7164
Mustang	4.0		05 -	V6	6	1,1	TR5-1	2321		TR5-1IX	7243
Mustang	4.6		03 -	V8	8	1,5	TR55	1048		TR55IX	7164
Taurus	3.0		89 - 95	Y DOHC V6 SFI	6	1,1	PFR5G-11	2647			
Taurus	3.0		92 - 99	U OHV V6 SFI	6	1,3	TR5	7837		TR5IX	7397
Taurus	3.0		96 - 99	S DOHC V6 SFI	6	1,3	TR55	1048		TR55IX	7164
Taurus	3.0		96 - 99	N SHO V8 SFI	8	1,3	TR5	7837		TR5IX	7397
Taurus	3.2		93 - 95	P SHO V6 SFI	6	1,1	PFR5G-11	2647			
Thunderbird	3.8		88 - 97	4 EFI V6 EFI	6	1,5	TR55-1	6674		TR55-1IX	7316
Thunderbird	3.8		89 - 95	R EFI V6 EFI Supercharged	6	1,5	TR55-1	6674		TR55-1IX	7316
Thunderbird	3.9		- 02	A EFI V8 DOHC	8	1,1	BKR5ES-11	2382	33	BKR5EIX-11	5464
Thunderbird	3.9		03 -	A EFI V8 DOHC	8	1,0	FR5AP-11	5463			
Thunderbird	4.6		94 - 97	W EFI V8 SOHC	8	1,5	TR55	1048		TR55IX	7164
Thunderbird	5.0		91 - 93	T EFI V8 H O	8	1,5	UR45	2451		UR45IX	7559
Thunderbird	5.0		86 - 88	F EFI V8	8	1,5	TR55-1	6674		TR55-1IX	7316

**FREIGHTROVER**

Sherpa D	2.0		05.86 - 03.91	Perkins - Prima 65	4	█	Y-902R	2237		D-POWER 1	7906
Sherpa Van DI D	2.5		01.87 -		4	█	Y-902R	2237		D-POWER 1	7906

**FSO**

125 P	1.3	48	09.68 - 12.90	116C.076	4	0,7	BP6ES	7811	4	BPR6EIX	6637
125P , Montana, Arizona	1.5	60	09.68 - 12.90		4	0,7	BP6ES	7811	4	BPR6EIX	6637
126 BIS	0.7	19	87 -		4	0,8	BPR6ES	7822	2	BPR6EIX	6637
Pick-Up	1.5		86 - 89		4	0,7	BP6ES	7811	4	BPR6EIX	6637
Polonez	1.3	48	01.78 -		4	0,7	BP6ES	7811	4	BPR6EIX	6637
Polonez	1.4	75	09.93 -	16DOHC Rover	4	0,8	BKR6ES	3783	28	BKR6EIX	6418
Polonez 1500	1.5	55	78 -		4	0,7	BP6ES	7811	4	BPR6EIX	6637
Polonez	1.5	60	01.78 -		4	0,7	BP6ES	7811	4	BPR6EIX	6637
Polonez	1.5	60	07.95 -	Cat.	4	0,8	BP6ET	1263		PGR6D	6248
Polonez D	1.6	37	01.86 -	VW - Motor	4	█	Y-918R	4182		D-POWER 2	6285
Polonez	1.6	64	05.87 -		4	0,7	BP6ES	7811	4	BPR6EIX	6637
Polonez 1600	1.6	64	87 -		4	0,8	BP7ES	2412		BPR7EIX	4055

<sup>1)</sup> Bic = Best in class    <sup>2)</sup> Front wheel drive    <sup>3)</sup> Rear wheel drive





ℓ kW

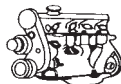

Cyl.

Order-  
No. No.

V-LINE

Bic<sup>1)</sup> Order-  
D-Power No.**FSO**

Polonez	1.6	64	07.95 -	Cat.	4	0,8	BP6ET	1263		PGR6D	6248
Polonez Caro D	1.9	51	10.92 -	XUD Kat.	4	█	Y-902R	2237		D-POWER 1	7906

**GAZ (VOLGA)**

Chaika		161		GAZ-14	8	0,9	BPR5ES	7422	6	BPR5EIX	6597
Gazel 3302/ 2752 (16V)		107		ZMZ-4061.10 / 4063.10	4	0,9	BPR5ES	7422	6	BPR5EIX	6597
Gazel 3302, 33027, 33021, 2705, 3221 (8V)	2,3	73		3M3-402	4	0,6	BP6HS	4511	18	BPR6HIX	4085
Sobol 2217 16V	2,3	96		3M3-4062.10	4	0,9	BPR5ES	7422	6	BPR5EIX	6597
Volga 24	2,4	70		3M3-24D	4	0,6	BP6HS	4511	18	BPR6HIX	4085
Volga 2410	2,3	73		3M3-402	4	0,6	BP6HS	4511	18	BPR6HIX	4085
Volga 3102, 31021, 31022, 31024, 31029	2,3	73		3M3-402	4	0,6	BP6HS	4511	18	BPR6HIX	4085
Volga 3110 8V	2,3	73		3M3-402	4	0,6	BP6HS	4511	18	BPR6HIX	4085
Volga 3110 16V	2,3	96		3M3-4062.10	4	0,9	BPR5ES	7422	6	BPR5EIX	6597
Volga 31105 16V	2,3	96		3M3-4062.10	4	0,9	BPR5ES	7422	6	BPR5EIX	6597
Volga 31105-501	2,4	110	06 -	DCC		1,1	LZTR4A-11	5444			
Volga 3111	2,3	107	00 -	3M3-4062.10	4	0,9	BPR5ES	7422	6	BPR5EIX	6597
Volga 3111	2,5	112	00 -	3M3-4052.10	4	0,9	BPR5ES	7422	6	BPR5EIX	6597

**GME**

Rascal, MIDI					4	0,7	BPR5ES	7422	6	BPR5EIX	6597
--------------	--	--	--	--	---	-----	--------	------	---	---------	------

**HINO**

Ranger			78 -	DG	4	█	Y-128T	7227			
Ranger (B) D	3.0	60	01.83 - 07.88	B	4	█	Y-197R	2188			
Ranger (3B) D	3.4	70	01.83 - 07.88	3 B	4	█	Y-197R	2188			

**HOMMEL**

Berlinette RS 16V	2.0	123	98 -	XU10.J4RS	4	0,9	BKR6EK	2288	20	BKR6EQUIP	3199
-------------------	-----	-----	------	-----------	---	-----	--------	------	----	-----------	------

**HONDA**

Accord 1,6 L CA-46200C..(AT)	1.6	65	86 -	A16A1	4	1,1	BPR6EY-11	4228	10	BPR6EIX-11	3903
Accord 1,6 2D AC-5320C..(MT)	1.6	65	84 -	EZ	4	1,1	BPR6ES-11	4824	13	BPR6EIX-11	3903
Accord 1,6 2D AC-5330C..(MT)	1.6	65	84 -	EZ	4	1,1	BPR6ES-11	4824	13	BPR6EIX-11	3903
Accord 1,6 2D AC-7330C..(AT)	1.6	65	84 -	EZ	4	1,1	BPR6ES-11	4824	13	BPR6EIX-11	3903
Accord 1,6 4D AC-5430C..(MT)	1.6	65	84 -	EZ	4	0,8	BPR6ES	7822	2	BPR6EIX	6637
Accord 1,6 L CA-45200C..(MT)	1.6	65	86 -	A16A1	4	1,1	BPR6EY-11	4228	10	BPR6EIX-11	3903
Accord 1,6 4D AC-7430C..(AT)	1.6	65	84 -	EZ	4	0,8	BPR6ES	7822	2	BPR6EIX	6637
Accord 1,8 2D AD-5330C..(MT)	1.8	74	84 -	ET1	4	1,1	BPR6EY-11	4228	10	BPR6EIX-11	3903
Accord 1,8 4D AD-7430C..(AT)	1.8	74	84 -	ET1	4	1,1	BPR6EY-11	4228	10	BPR6EIX-11	3903
Accord 1,8 2D AD-7330C..(AT)	1.8	74	84 -	ET1	4	1,1	BPR6EY-11	4228	10	BPR6EIX-11	3903
Accord 1,8 4D AD-5430C..(MT)	1.8	74	84 -	ET1	4	1,1	BPR6EY-11	4228	10	BPR6EIX-11	3903
Accord 1,8 i /iLS CE7	1.8	85	96 -	F18A3	4	1,1	ZFR6F-11	4291		ZFR6FIX-11	6441
Accord 1,8 iS CG8	1.8	100	99 -	F18B2	4	1,1	ZFR6F-11	4291		ZFR6FIX-11	6441
Accord 2,0 CB3..(MT/AT)	2.0	66	90 -	F20A2 Cat.	4	1,1	ZFR6F-11	4291		ZFR6FIX-11	6441
Accord 2,0 CB3..(MT/AT)	2.0	66	90 -	F20A6	4	1,1	ZFR6F-11	4291		ZFR6FIX-11	6441
Accord 2,0 EX CA-55300C..(5MT)	2.0	75	86 -	A20A1 Cat.	4	1,1	BPR6EY-11	4228	10	BPR6EIX-11	3903
Accord 2,0 EX CA-56300C..(4AT)	2.0	76	86 -	A20A1 Cat.	4	1,1	BPR6EY-11	4228	10	BPR6EIX-11	3903
Accord TDi CF1	2.0	77	09.99 -	20TN2	4	█	Y-730U	2273		D-POWER 17	6704
Accord TDi	2.0	77	05.95 - 08.99	Rover (L-Serie)	4	█	Y-730U	2273		D-POWER 17	6704
Accord 2,0 EX CA-56300C..(AT)	2.0	78	86 -	A20A2	4	1,1	BPR6EY-11	4228	10	BPR6EIX-11	3903

<sup>1)</sup> Bic = Best in class



ℓ kW

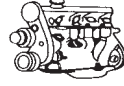

Cyl.

Order-  
No. No.Bic<sup>1)</sup> Order-  
D-Power No.**HONDA**

Accord 2,0 EX	CA-55300C..(MT)	2.0	78	86-	A20A2	4	1,1	BPR6EY-11	4228	10	BPR6EIX-11	3903
Accord 2,0i EX	CA-56800C..(AT)	2.0	85	87-	A20A3 Cat.	4	1,1	BPR6EY-11	4228	10	BPR6EIX-11	3903
Accord 2,0i EX	CA-55800C..(MT)	2.0	85	87-	A20A3 Cat.	4	1,1	BPR6EY-11	4228	10	BPR6EIX-11	3903
Accord 2,0i	CC7..(MT)	2.0	85	93-	F30Z2	4	1,1	ZFR6F-11	4291		ZFR6FIX-11	6441
Accord 2,0 EXi	CA-55400C..(MT)	2.0	90	86-	A20A4	4	1,1	BPR6EY-11	4228	10	BPR6EIX-11	3903
Accord 2,0 EXi	CA-56400C..(AT)	2.0	90	86-	A20A4	4	1,1	BPR6EY-11	4228	10	BPR6EIX-11	3903
Accord 2,0i LS	CE8..	2.0	96	95-		4	1,1	ZFR6F-11	4291		ZFR6FIX-11	6441
Accord 2,0i LS/ES	CE8	2.0	96	96-	F20Z1	4	1,1	ZFR6F-11	4291		ZFR6FIX-11	6441
Accord 2,0 S,LS,ES	CC7..(MT/AT)	2.0	96	93-	F20Z1	4	1,1	ZFR6F-11	4291		ZFR6FIX-11	6441
Accord 2,0i	CB3..(MT/AT)	2.0	98	90-	F20A8	4	1,1	ZFR6F-11	4291		ZFR6FIX-11	6441
Accord 2,0i 16V	CA5	2.0	98	88-	B20A8 Cat.	4	1,1	BCPR6E-11	3132	11	BCPR6EIX-11	4919
Accord 2,0i	CB3..(MT/AT)	2.0	98	90-	F20A4	4	1,1	ZFR6F-11	4291		ZFR6FIX-11	6441
Accord 2,0i 16V EX	CA-55500C..(MT)	2.0	101	87-	B20A2	4	1,1	BCPR6EYN-11	6262			
Accord 2,0iLS/iES	CG9	2.0	108	99-	F20B6	4	1,1	ZFR6F-11	4291		ZFR6FIX-11	6441
Accord 2.0 Sport	CL7	2.0	114	03-	K20A6	4	1,1	ZFR6K-11	6711			
Accord 2,0i	CL7	2.0	114	03-	K20A6	4	1,1	ZFR6K-11	6711			
Accord 2,2i VTEC	CE9	2.2	110	95-	F22Z2	4	1,1	ZFR6F-11	4291		ZFR6FIX-11	6441
Accord 2,2i 16V	CE9..	2.2	110	95-		4	1,1	ZFR6F-11	4291		ZFR6FIX-11	6441
Accord 2,2i (4WS)	CB7..(MT/AT)	2.2	110	90-	F22A3	4	1,1	ZFR6F-11	4291		ZFR6FIX-11	6441
Accord 2,2iR	CH1	2.2	156	99-	H22A7	4	1,1	PZFR6F-11	3271			
Accord 2,3 ES	CL3	2.3	113	01-	F23Z5	4	1,1	ZFR6F-11	4291		ZFR6FIX-11	6441
Accord 2,3 SR	CC7.. (MT)	2.3	116	93-	H23A3	4	1,1	ZFR6F-11	4291		ZFR6FIX-11	6441
Accord 2.4 Sport	CL9	2.4	140	03-	K24A3	4	1,1	IZFR6K-11	6994			
Accord 2,4i	CL9	2.4	140	03-	K24A3	4	1,1	IZFR6K-11	6994			
Accord Aero 2,0 EX	CA-53700C..(MT)	2.0	75	87-	A20A1 Cat. 5MT	4	1,1	BPR6EY-11	4228	10	BPR6EIX-11	3903
Accord Aero 2,0 EX	CA-54700C..(AT)	2.0	76	87-	A20A1 Cat. 4AT	4	1,1	BPR6EY-11	4228	10	BPR6EIX-11	3903
Accord Aero 2,0 EX	CA-53300C..(MT)	2.0	78	86-	A20A2	4	1,1	BPR6EY-11	4228	10	BPR6EIX-11	3903
Accord Aero 2,0 EX	CA-54300C..(AT)	2.0	78	86-	A20A2	4	1,1	BPR6EY-11	4228	10	BPR6EIX-11	3903
Accord Aero 2,0i EX	CA-53800C..(MT)	2.0	85	87-	A20A3 Cat.	4	1,1	BPR6EY-11	4228	10	BPR6EIX-11	3903
Accord Aero 2,0i EX	CA-54800C..(AT)	2.0	85	87-	A20A3 Cat.	4	1,1	BPR6EY-11	4228	10	BPR6EIX-11	3903
Accord Aero 2,0 EXi	CA-53400C..(MT)	2.0	90	86-	A20A4	4	1,1	BPR6EY-11	4228	10	BPR6EIX-11	3903
Accord Aero 2,0 EXi	CA-54400C..(AT)	2.0	90	86-	A20A4	4	1,1	BPR6EY-11	4228	10	BPR6EIX-11	3903
Accord Aero 2,0i	CC9	2.0	98	93-	F20Z3	4	1,1	ZFR6F-11	4291		ZFR6FIX-11	6441
Accord Aero 2,0i LS,ES	CE2 (MT/AT)	2.0	100	94-	F20B3	4	1,1	ZFR6F-11	4291		ZFR6FIX-11	6441
Accord Aero 2,2i	CB8	2.2	110	91- 91	F22A7-F22A8	4	1,1	ZFR6F-11	4291		ZFR6FIX-11	6441
Accord Aero 2,2i LS,ES	CE1 (MT/AT)	2.2	110	94-	F22B5	4	1,1	ZFR6F-11	4291		ZFR6FIX-11	6441
Accord Coupe 2,0	CC1..(MT/AT)	2.0	98	92-	F20A7	4	1,1	ZFR6F-11	4291		ZFR6FIX-11	6441
Accord Coupe 2,0i ES / iLS	(CG4)	2.0	108	01.98-	F20B5	4	1,1	ZFR6F-11	4291		ZFR6FIX-11	6441
Accord Coupe 2,2i	CD7 (MT/AT)	2.2	110	94-	F22B5	4	1,1	ZFR6F-11	4291		ZFR6FIX-11	6441
Accord Coupe 3,0i V6	CG2	3.0	147	98-	J30A1	6	1,1	ZFR5F-11	2262		ZFR5FIX-11	2477
Accord Tourer	CM1	2.0	114	04.03-	K20A6	4	1,1	ZFR6K-11	6711			
Accord Tourer	CM2	2.4	140	04.03-	K24A3	4	1,1	IZFR6K-11	6994			
Civic 1300	AG-5320S..(MT)	1.3	52	84-	EV2	4	1,1	BPR6EY-11	4228	10	BPR6EIX-11	3903
Civic 1300	AG-3320S..(AT)	1.3	52	02.84-	EV2	4	1,1	BPR6EY-11	4228	10	BPR6EIX-11	3903
Civic 1,3	EG3	1.3	55	92-	D13B2	4	1,1	BKR6E-11	2756	14	BKR6EIX-11	3764
Civic 1,3	EC8..(MT/AT)	1.3	55	88-	D13B1	4	1,1	BCPR6E-11	3132	11	BCPR6EIX-11	4919
Civic 1,3	EC8..(MT/AT)	1.3	55	90-	D13B2 Cat.	4	1,1	BCPR6E-11	3132	11	BCPR6EIX-11	4919
Civic IMA 1.3	(ES9)	1.3	61	04-	LDA1	4	1,1	IFR5G-11K	3107			
Civic 1,3i IMA	ES9	1.3	66	03-		4	1,1	IFR5G-11K	3107			
Civic Hybrid	(FD3)	1.3	85	11.05-		4	1,1	ILFR6J-11K	4458			
Civic		1.4		01.97-	PIJ (SOHC)	4	1,1	ZFR5F-11	2262		ZFR5FIX-11	2477
Civic 1,4i	EJ9	1.4	55	96-	D14A3	4	1,1	BKR6E-11	2756	14	BKR6EIX-11	3764

<sup>1)</sup> Bic = Best in class



ℓ kW

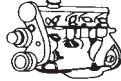

Cyl.

Order-  
No. No.Bic<sup>1)</sup> Order-  
D-Power No.**HONDA**

Civic 1,4i	EJ9	1.4	55	99 -	D14Z1	4	1,1	ZFR5J-11	5584			
Civic 1,4 (FK1)		1.4	61	06 -	L13A7	4	1,1	IFR6G11K				
Civic	EU7	1.4	66	03.01 -	D14Z6	4	1,1	ZFR6J-11	5585			
Civic 1,4iS	EJ9	1.4	66	96 -	D14A4	4	1,1	BKR6E-11	2756	14	BKR6EIX-11	3764
Civic 1,4iS	EJ9	1.4	66	99 -	D14Z2	4	1,1	ZFR5J-11	5584			
Civic 1,4	EC9/ED2..(AT/MT)	1.4	66	88 -	D14A1	4	1,1	BCPR6E-11	3132	11	BCPR6EIX-11	4919
Civic		1.5		01.97 -	P9L(VTEC)	4	1,1	ZFR5F-11	2262		ZFR5FIX-11	2477
Civic		1.5		97 -	VTi	4	1,1	BKR6EN-11	5724			
Civic 1,5S	AH-5330S..(MT)	1.5	63	84 -	EW2	4	1,1	BPR6EY-11	4228	10	BPR6EIX-11	3903
Civic GL	AH-5320S..(MT)	1.5	63	85 -	EW2	4	1,1	BPR6EY-11	4228	10	BPR6EIX-11	3903
Civic GL	AH-3320S..(AT)	1.5	63	85 -	EW2	4	1,1	BPR6EY-11	4228	10	BPR6EIX-11	3903
Civic 1,5VEI	EG4	1.5	66	92 -	D15Z1	4	1,1	ZFR6F-11	4291		ZFR6FIX-11	6441
Civic 1,5i	ED6/ED3	1.5	66	89-09.91	D15B2 Cat.	4	1,1	BCPR6E-11	3132	11	BCPR6EIX-11	4919
Civic 1,5DXI/LSi	EG4/EG8	1.5	66	92 -	D15B2	4	1,1	BKR6E-11	2756	14	BKR6EIX-11	3764
Civic 1,5iGT	AH-5330S..(MT)	1.5	66	86 -	EW4 Cat.	4	1,1	BPR6EY-11	4228	10	BPR6EIX-11	3903
Civic 1,5iGT	AH-5330S..(MT)	1.5	74	85 -	EW3	4	1,1	BPR6EY-11	4228	10	BPR6EIX-11	3903
Civic 1,5iLS	EK3	1.5	84	96 -	D15Z6	4	1,1	ZFR6J-11	5585			
Civic		1.6		01.97 -	PIK(SOHC)	4	1,1	ZFR5F-11	2262		ZFR5FIX-11	2477
Civic 1,6	ED4/ED7	1.6	80	88 -	D16A6 Cat.	4	1,1	BCPR6E-11	3132	11	BCPR6EIX-11	4919
Civic 1,6	ED4/ED7	1.6	81	90- 01	D16Z2 Cat.	4	1,1	BCPR6E-11	3132	11	BCPR6EIX-11	4919
Civic	EU8	1.6	81	03.01 -	D16V1	4	1,1	ZFR6J-11	5585			
Civic 1,6i ES	EK1	1.6	84	96 -	D16Y5	4	1,1	ZFR6J-11	5585			
Civic 1,6ESI	EG5/EG9	1.6	92	92 -	D16Z6	4	1,1	BKR6E-11	2756	14	BKR6EIX-11	3764
Civic VTEC	EE9	1.6	110	90 -	B16A1	4	1,1	BKR6EN-11	5724			
Civic 1,6VTi	EK4	1.6	118	96 -	B16A2	4	1,1	BKR7EN-11	6256			
Civic 1,6VTi	EG6/EG9	1.6	118	92- 95	B16A2	4	1,1	BKR6E-11	2756	14	BKR6EIX-11	3764
Civic 1.7 CTDi	EP4	1.7	74	02 -	4EE2	4	■	Y-541J	4617		D-POWER 42	1983
Civic 1.8 i-VTEC	FD1	1.8	103	09.05 -	R18A	4	1,1	IZFR6K-11S				
Civic 1,8	FK2	1.8	103	06 -	R18A2	4	1,1	IZFR6K-11S				
Civic Type-R	EP3	2.0	147	08.01 - 06	K20A2	4	1,1	IFR7G-11KS	7746			
Civic Type R	FN2	2.0	148	07 -	K20ZA	4	1,1	IFR7G-11KS	7746			
Civic 5 Door		1.4			PIH	4	1,1	BKR6E-11	2756	14	BKR6EIX-11	3764
Civic 1,4i 5Door	MB2	1.4	55	99 -	D14Z3	4	1,1	ZFR5F-11	2262		ZFR5FIX-11	2477
Civic 1,4i 5Door	MA8	1.4	55	96 -	D14A5	4	1,1	BKR6E-11	2756	14	BKR6EIX-11	3764
Civic 1,4i 5Door	MB2	1.4	55	97 -	D14A7	4	1,1	ZFR5F-11	2262		ZFR5FIX-11	2477
Civic 1,4 5 Door	EU7	1.4	66	01 -	D14Z6 SOHC	4	1,1	ZFR5J-11	5584			
Civic 1,4i 5Doorr	MA8 (MT/AT)	1.4	66	95 -	D14A2	4	1,1	BKR6E-11	2756	14	BKR6EIX-11	3764
Civic 1,4 iS 5Door	MB2	1.4	66	97 -	D14A8	4	1,1	ZFR5F-11	2262		ZFR5FIX-11	2477
Civic 1,4iS 5Door	MB2	1.4	66	99 -	D14Z4	4	1,1	ZFR5F-11	2262		ZFR5FIX-11	2477
Civic 1,5 VTEC-E 5Door	MA9	1.5	66	95 -	D15Z3	4	1,1	ZFR6F-11	4291		ZFR6FIX-11	6441
Civic 1,5 Vtec 5Door	MB3	1.5	85	97 -	D15Z8	4	1,1	ZFR5F-11	2262		ZFR5FIX-11	2477
Civic 5 Door		1.6			PIJ DOHC	4	1,1	BKR6E-11	2756	14	BKR6EIX-11	3764
Civic 5 Door		1.6			PIK DOHC	4	1,1	BKR6E-11	2756	14	BKR6EIX-11	3764
Civic 1,6 Vtec 5Door	EU8	1.6	81	01 -	D16V1 SOHC	4	1,1	ZFR6J-11	5585			
Civic 1,6LS 5Door	MB1 (MT/AT)	1.6	83	95 -	D16Y3	4	1,1	BKR6E-11	2756	14	BKR6EIX-11	3764
Civic 1,6i/LS 5Door	MB4	1.6	85	99 -	D16W3	4	1,1	ZFR5F-11	2262		ZFR5FIX-11	2477
Civic 1,6 LS 5Door	MB4	1.6	85	97 -	D16B2	4	1,1	ZFR5F-11	2262		ZFR5FIX-11	2477
Civic 1,6 SR VTEC 5Door	MB1 (MT/AT)	1.6	93	95 -	D16Y2	4	1,1	BKR6E-11	2756	14	BKR6EIX-11	3764
Civic 1,8 VTI 5Door	MB6	1.8	124	97 -	B18C4	4	1,1	BKR6EN-11	5724			
Civic 2.0i Sport (EV1) 5Door		2.0	118	04 -	K20A3	4	1,1	ZFR6K-11	6711			
Civic 1.4i Aerodeck	MB8	1.4	55	98 -	D14A7	4	1,1	ZFR6F-11	4291		ZFR6FIX-11	6441
Civic 1.4iS Aerodeck	MB8	1.4	66	98 -	D14A8	4	1,1	ZFR6F-11	4291		ZFR6FIX-11	6441

<sup>1)</sup> Bic = Best in class



ℓ kW

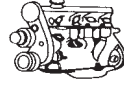

Cyl.

Order-  
No. No.Bic<sup>1)</sup> Order-  
D-Power No.**HONDA**

Civic 1.5iVTEC Aerodeck MB9	1.5	85	98-	D15Z8	4	1,1	ZFR6F-11	4291		ZFR6FIX-11	6441
Civic 1.6iSR Aerodeck MC1	1.6	85	98-	D16B2	4	1,1	ZFR6F-11	4291		ZFR6FIX-11	6441
Civic 1.8iVTi Aerodeck M18C4	1.8	124	98-	B18C4	4	1,1	BKR7EN-11	6256			
Civic Coupe 1,5i/LSi EJ2	1.5	74	94-	D15B7	4	1,1	ZFR6F-11	4291		ZFR6FIX-11	6441
Civic Coupe 1,6iLS EJ6	1.6	77	99-	D16Y7	4	1,1	ZFR5F-11	2262		ZFR5FIX-11	2477
Civic Coupe 1,6 LS EJ6	1.6	77	96- 98	D16Y7	4	1,1	BKR6E-11	2756	14	BKR6EIX-11	3764
Civic Coupe 1,6 LS EJ6	1.6	77	96- 98	D16Y7	4	1,1	BKR6E-11	2756	14	BKR6EIX-11	3764
Civic Coupe 1,6i SR EJ8	1.6	92	96-	D16Y8	4	1,1	BKR6E-11	2756	14	BKR6EIX-11	3764
Civic Coupe 1,6i SR EJ8	1.6	92	96- 98	D16Y8	4	1,1	BKR6E-11	2756	14	BKR6EIX-11	3764
Civic Coupe 1,6 ESi EJ1	1.6	92	94-	D16Z9	4	1,1	BKR6E-11	2756	14	BKR6EIX-11	3764
Civic Coupe 1,6 SR EJ8	1.6	92	99-	D16Y8	4	1,1	ZFR5F-11	2262		ZFR5FIX-11	2477
Civic Coupe 1,7 LS EM2	1.7	88	01-	D17A8	4	1,1	ZFR6J-11	5585			
Civic Coupe 1,7 ES EM2	1.7	92	01-	D17A9	4	1,1	ZFR6J-11	5585			
Civic Shuttle 1,6i EE	1.6	80	88-	D16A6 Cat.	4	1,1	BCPR6E-11	3132	11	BCPR6EIX-11	4919
Civic Shuttle 1,6i EE	1.6	81	88-	D16Z2 Cat.	4	1,1	BCPR6E-11	3132	11	BCPR6EIX-11	4919
Concerto 1,5i HW..(MT/AT)	1.5	66	90-	D15B2 Cat.	4	1,1	BCPR6E-11	3132	11	BCPR6EIX-11	4919
Concerto 1,6i HW..(MT/AT)	1.6	82	90-	D16Z2 SOHC Cat.	4	1,1	BCPR6E-11	3132	11	BCPR6EIX-11	4919
Concerto 1,6-16V HW	1.6	90	90-	D16A8 DOHC	4	1,1	BCPR6E-11	3132	11	BCPR6EIX-11	4919
Concerto TD	1.8	64	10.94-12.95	XUD 7 TE	4	█	Y-902R	2237		D-POWER 1	7906
CR-V RD1	2.0	94	05.97-	B20B3	4	1,1	ZFR5F-11	2262		ZFR5FIX-11	2477
CR-V RD1	2.0	108	03.99-	B20Z1	4	1,1	ZFR6F-11	4291		ZFR6FIX-11	6441
CR-V RE5	2.0	110	07-	R20A2	4	1,1	IZFR6K-11S				
CR-V RD8	2.0	110	02-	K20A4	4	1,1	ZFR6K-11	6711			
CRX AF-5320S..(MT)	1.5	74	84-	EW3	4	1,1	BPR6EY-11	4228	10	BPR6EIX-11	3903
CRX 1,6i-16 ED9	1.6	91	89-	D16Z5 Cat.	4	1,1	BCPR6E-11	3132	11	BCPR6EIX-11	4919
CRX 1,6 EH6..(MT/AT)	1.6	92	92-	D16Z6	4	1,1	BKR6E-11	2756	14	BKR6EIX-11	3764
CRX 16V AS-5330S..(MT)	1.6	92	01.86-	ZC1	4	1,1	BCPR6EY-11	3720		BCPR6EIX-11	4919
CRX 1,6i-16 ED9	1.6	96	88-	D16A9	4	1,1	BCPR6E-11	3132	11	BCPR6EIX-11	4919
CRX VTEC EE8	1.6	110	90-	B16A1	4	1,1	BKR6EN-11	5724			
CRX 1,6 EG2	1.6	118	92-	B16A2	4	1,1	BKR6EN-11	5724			
FR-V BE1	1.7	92	01.05-	D17A2 SOHC VTEC	4	1,1	ZFR6J-11	5585			
FR-V BE3	2.0	110	01.05-	K20A9 DOHC i-VTEC	4	1,1	ZFR6K-11	6711			
HR-V GH2	1.6	77	02.99-	D16W1	4	1,1	ZFR5J-11	5584			
HR-V 1.6 VTEC GH2	1.6	91	10.99-	VTEC	4	1,1	ZFR5J-11	5584			
Insight 6CDS3Y00A ZE1	1.0	56	00-	ECA1	3	1,1	ILZFR6A-11				
Integra Type-R 16V	2.0	162	02.02-	K20A	4	1,1	IFR7G-11KS	7746			
Integra R DC2	1.8	140	99-	B18C6	4	1,1	PFR7G-11	2380			
Integra R DC2	1.8	140	10.97-	B18C6	4	1,1	PFR7G-11	2380			
Integra	1.6	88	03.86-08.89	D16A3	4	1,1	BCPR6E-11	3132	11	BCPR6EIX-11	4919
Jazz 45 AA-4310S.. (4MT)	1.2	33	84-	ER2	4	1,1	BPR5EY-11	3028		BPR5EIX-11	2115
Jazz 55 AA-3320S.. (3HMT)	1.2	40	85-	ER4	4	1,1	BPR5EY-11	3028		BPR5EIX-11	2115
Jazz 56 AA-5320S.. (5MT)	1.2	41	84-	ER1	4	1,1	BPR5EY-11	3028		BPR5EIX-11	2115
Jazz 1,2 (GE2) CHAC	1.2	57	06-	L12A4	4	1,1	BKR6E-11	2756	14	BKR6EIX-11	3764
Jazz 1,2 (GD5)	1.2	57	03-	L12A1 TwinSpark	4	1,1	BKR6E-11	2756	14	BKR6EIX-11	3764
Jazz 1,2 i-DSI	1.2	57	02-	TwinSpark	4	1,1	BKR6E-11	2756	14	BKR6EIX-11	3764
Jazz 1,3 (GE3) CHAC	1.3	61	06-	L13A6	4	1,1	BKR6E-11	2756	14	BKR6EIX-11	3764
Jazz 1,4 (GE3) CHAC	1.4	61	06-	L13A6	4	1,1	BKR6E-11	2756	14	BKR6EIX-11	3764
Jazz 1,4 (GD1)	1.4	61	02-	L13A1TwinSpark	4	1,1	BKR6E-11	2756	14	BKR6EIX-11	3764
Legend V6 2,5i HS..N..(MT)	2.5	110	87-	C25A1 Cat.	6	1,1	BCPR6E-11	3132	11	BCPR6EIX-11	4919
Legend V6 2,5i HS..Y..(AT)	2.5	110	87-	C25A1 Cat.	6	1,1	BCPR6E-11	3132	11	BCPR6EIX-11	4919
Legend V6 2,5i HS..N..(MT)	2.5	127	87-	C25A1	6	1,1	BCPR6E-11	3132	11	BCPR6EIX-11	4919
Legend V6 2,5i HS..Y..(AT)	2.5	127	87-	C25A1	6	1,1	BCPR6E-11	3132	11	BCPR6EIX-11	4919

<sup>1)</sup> Bic = Best in class



ℓ kW

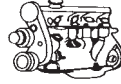

Cyl.

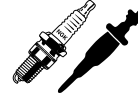
Order-  
No. No.Bic<sup>1)</sup> Order-  
D-Power No.**Honda**

Legend 2,7i	HS/KA4	2.7	124	88 -	C27A1	Cat.	6	1,1	BCPR6E-11	3132	11	BCPR6EIX-11	4919
Legend 3,2	KA7/KA8	3.2	151	91 -	C32A2		6	1,1	PFR6G-11	5555			
Legend 3,2	KA7/KA8	3.2	151	93 -	C32A2		6	1,1	PFR6G-11	5555			
Legend 3,5 V6	KA9	3.5	151	96 -			6	1,1	PFR6G-11	5555			
Legend V6		3.5	151	95 -			6	1,1	PFR6G-11	5555			
Legend 3,5 V6	KB1	3.5	217	07 -	J35A8		6	1,1	IZFR6K-11	6994			
Legend 3.5 SH-AWD	KB1	3.5	217	06 -	J35A8		6	1,1	IZFR6K-11	6994			
Legend Coupe 2,7i	KA3	2.7	124	88 -	C27A1	Cat.	6	1,1	BCPR6EYN-11	6262			
Logo 1,3 i		1.3	48	99 - 01	D13B7		4	1,1	ZFR5J-11	5584			
NSX	NA1	3.0	188	91 -	C30A3/C30A4		6	1,1	PFR6G-11	5555			
NSX	NA2	3.2	206	01.97 -	C32B2		6	1,1	PFR6G-11	5555			
Prelude 1,8	AB-7230C..(AT)	1.8	74	83 -	ET		4	0,8	BPR6EY	6427		BPR6EIX	6637
Prelude 1,8	AB-5240C..(MT)	1.8	74	85 -	ET2		4	1,1	BPR6EY-11	4228	10	BPR6EIX-11	3903
Prelude 1,8	AB-5220C..(MT)	1.8	77	83 -	ET		4	0,8	BPR6EY	6427		BPR6EIX	6637
Prelude 1,8	AB-5230C..(MT)	1.8	77	83 -	ET		4	0,8	BPR6EY	6427		BPR6EIX	6637
Prelude 2,0	BA4..(MT/AT)	2.0	80	88 -	B20A3	Cat.	4	1,1	BCPR6EYN-11	6262			
Prelude 2,0	BA4..(MT/AT)	2.0	80	90 -	B20A3	Cat.	4	1,1	BCPR6EYN-11	6262			
Prelude 2,0	BA4..	2.0	84	88 -	B20A4		4	1,1	BCPR6EYN-11	6262			
Prelude 2,0	BB3..(MT/AT)	2.0	98	92 -	F20A4		4	1,1	ZFR6F-11	4291		ZFR6FIX-11	6441
Prelude 2,0 i	(BB9)	2.0	98	99 -	F20A4		4	1,1	ZFR6F-11	4291		ZFR6FIX-11	6441
Prelude 2,0		2.0	98	97 -			4	1,1	ZFR6F-11	4291		ZFR6FIX-11	6441
Prelude 2,0 16V 4WS) BA4		2.0	101	88 -	B20A5	Cat.	4	1,1	BCPR6EYN-11	6262			
Prelude 2,0i 16V BA2-1300C..(MT)		2.0	101	86 -	BA20A1	DOHC	4	1,1	BCPR6E-11	3132	11	BCPR6EIX-11	4919
Prelude 2,0 16V 4WS)BA4		2.0	103	90 -	B20A9	Cat.	4	1,1	BCPR6EYN-11	6262			
Prelude 2,2 Vti (BB6/BB8)		2.2	136	99 -	H22A5		4	1,1	PZFR6F-11	3271			
Prelude 2,2 VTEC BB1..(MT)		2.2	136	93 -	H22A2		4	1,1	PZFR6F-11	3271			
Prelude 2,2i		2.2	136	97 -	H22A5		4	1,1	PZFR6F-11	3271			
Prelude 2,3	BB2..(MT/AT)	2.3	118	92 -	H23A2		4	1,1	ZFR6F-11	4291		ZFR6FIX-11	6441
S 2000 (AP1)		2.0	177	06.00 -	F20C2		4	1,1	PFR7G-11S	7772			
Shuttle 4WD	AR-6520C..(MT)	1.5	63	85 -	EW2		4	1,1	BPR6EY-11	4228	10	BPR6EIX-11	3903
Shuttle	AN-3520S..(AT)	1.5	63	84 -	EW2		4	1,1	BPR6EY-11	4228	10	BPR6EIX-11	3903
Shuttle	AN-5520S..(MT)	1.5	63	84 -	EW2		4	1,1	BPR6EY-11	4228	10	BPR6EIX-11	3903
Shuttle 2,2i ES		2.2	110	95 -	RA1 (AT)		4	1,1	ZFR6F-11	4291		ZFR6FIX-11	6441
Shuttle 2,3	RA3	2.3	110	98 -	F23A7		4	1,1	ZFR6F-11	4291		ZFR6FIX-11	6441
Stream (RN1)		1.7	92	04.01 -	D17A2		4	1,1	ZFR6J-11	5585			
Stream (RN3)		2.0	115	04.01 -	K20A1		4	1,1	ZFR6K-11	6711			

**HYUNDAI**

Accent		1.3	44	10.94 -	G4EH		4	1,1	BKR5ES-11	2382	33	BKR5EIX-11	5464
Accent		1.3	55	10.94 -	G4EH		4	1,1	BKR5ES-11	2382	33	BKR5EIX-11	5464
Accent/LC		1.3	55	99 -	G4EA		4	1,1	BKR5ES-11	2382	33	BKR5EIX-11	5464
Accent/LC		1.3	64	99 -	G4EA		4	1,1	BKR5ES-11	2382	33	BKR5EIX-11	5464
Accent 1.4		1.4	71	06.06 -			4	1,1	BKR5ES-11	2382	33	BKR5EIX-11	5464
Accent GT 16V		1.5		95 -	G4EK		4	1,1	BKR5ES-11	2382	33	BKR5EIX-11	5464
Accent TDI		1.5	55	04.02 -			3	█	Y-749J	5013			
Accent 12V CRDi		1.5	60	04.02 -	D3-EA		3	█	Y-749J	5013			
Accent		1.5	65	10.94 -	G4EK		4	1,1	BKR5ES-11	2382	33	BKR5EIX-11	5464
Accent/LC		1.5	66	01.00 -	G4EB		4	1,1	BKR5ES-11	2382	33	BKR5EIX-11	5464
Accent/LC 16V		1.5	75	99 -	G4EA		4	1,1	BKR5ES-11	2382	33	BKR5EIX-11	5464
Accent 1.6		1.6	82	06.06 -	G4ED		4	1,1	BKR5ES-11	2382	33	BKR5EIX-11	5464
Amica		1.0		00 -			4	1,1	BKR5E-11	6953	33	BKR5EIX-11	5464
Atos		0.8		- 02	LPG		4	0,8	BKR6ES	3783	28	BKR6EIX	6418

<sup>1)</sup> Bic = Best in class



ℓ kW

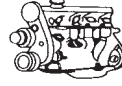

Cyl.

Order-  
No. No.Bic<sup>1)</sup> Order-  
D-Power No.**HYUNDAI**

Atos / MX	1.0	40	99 - 02	G4HC	4	1,1	BKR5ES-11	2382	33	BKR5EIX-11	5464
Atos Prime	1.0	40	99 - 02	G4HC	4	1,1	BKR5ES-11	2382	33	BKR5EIX-11	5464
Atos	1.1	46	03.04 -		4	1,1	BKR5ES-11	2382	33	BKR5EIX-11	5464
Avante	1.5			DOHC	4	1,1	BKR5ES-11	2382	33	BKR5EIX-11	5464
Avante	1.6			DOHC	4	1,1	BKR5ES-11	2382	33	BKR5EIX-11	5464
Avante	1.8			DOHC	4	1,1	BKR5ES-11	2382	33	BKR5EIX-11	5464
Avante	2.0			DOHC	4	1,1	BKR5ES-11	2382	33	BKR5EIX-11	5464
Coupe (RD)	1.6	84	12.96 - 04.02	4G61	4	1,1	BKR5ES-11	2382	33	BKR5EIX-11	5464
Coupe 2.0	2.0	99	01 -	G4GF-EG	4	1,1	BKR5ES-11	2382	33	BKR5EIX-11	5464
Coupe	2.0	102	03.96 -	G4GF DOHC	4	1,1	BKR5ES-11	2382	33	BKR5EIX-11	5464
Coupe 2.0	2.0	102	99 -	G4GC	4	1,1	BPR5ES-11	4424		BPR5EIX-11	2115
Coupe	2.0	105	03.02 -	G4GC-G	4	1,1	BKR5ES-11	2382	33	BKR5EIX-11	5464
Coupe	2.7	121	03.02 -	G6BA-G V6	6	1,1	PFR5J-11	4642			
Dynasty 2.5 V6	2.5				6	1,1	PFR6N-11	3546			
Dynasty 3.0 V6	3.0				6	1,1	PFR6N-11	3546			
Dynasty 3.5 V6	3.5				6	1,1	PFR6N-11	3546			
Elantra	1.5			DOHC	4	1,1	BPR6ES-11	4824	13	BPR6EIX-11	3903
Elantra	1.6		- 99	DOHC	4	1,1	BPR6ES-11	4824	13	BPR6EIX-11	3903
Elantra / XD	1.6	79	00 -	G4ED-G DOHC	4	1,1	BKR5ES-11	2382	33	BKR5EIX-11	5464
Elantra	1.8			DOHC	4	1,1	BPR6ES-11	4824	13	BPR6EIX-11	3903
Elantra CRDI	2.0	83	01 -	D4EA	4	█	Y-749J	5013			
Elantra / XD	2.0	102	00 -	G4GC-G DOHC	4	1,1	BKR5ES-11	2382	33	BKR5EIX-11	5464
Elantra	2.0	105	03 -		4	1,1	BKR5E-11	6953	33	BKR5EIX-11	5464
Exel	1.3	62	96 -	G4EK	4	1,1	BKR6E-11	2756	14	BKR6EIX-11	3764
FC	1.6	76	07.01 -		4	1,1	BKR5ES-11	2382	33	BKR5EIX-11	5464
Galopper	2.5	57	- 01.94	4D55	4	█	Y-115T1	2189			
Galopper TC,TCI	2.5	65	11.95 -	4D56	4	█	CY57	5287		D-POWER 21	4994
Galopper TD 3/5p GLS, Inovation	2.5	74	01.99 -		4	█	CY57	5287		D-POWER 21	4994
Galopper	3.0		98 -	SOHC V6	6	1,1	BKR5ES-11	2382	33	BKR5EIX-11	5464
Galopper	3.0	104	08.98 -	Leaded+LPG	6	0,9	BPR5ES	7422	6	BPR5EIX	6597
Galopper	3.0	104	08.98 -	G6AT Unleaded	6	1,1	BPR5ES-11	4424		BPR5EIX-11	2115
Getz TB	1.1	46	09.02 -	G4HD	4	1,1	BKR5ES-11	2382	33	BKR5EIX-11	5464
Getz TB	1.3	60	09.02 -	G4EA	4	1,1	BKR5ES-11	2382	33	BKR5EIX-11	5464
Getz TB	1.4	71	05 -		4	1,1	BKR5ES-11	2382	33	BKR5EIX-11	5464
Getz D	1.5	60	07.03 -	D3EA	3	█	Y-749J	5013			
Getz TB	1.6	78	09.02 -	G4ED	4	1,1	BKR5ES-11	2382	33	BKR5EIX-11	5464
Grace 2.4	2.4	82		SOHC	4	1,1	BPR6ES-11	4824	13	BPR6EIX-11	3903
Grace H100	2.5			4D55	4	█	Y-115T1	2189			
H 1	2.4	85	09.97 -	H100	4	1,1	BPR6ES-11	4824	13	BPR6EIX-11	3903
H 1 Starex	2.4	82	98 -	G4CS	4	1,1	BPR6ES-11	4824	13	BPR6EIX-11	3903
H 100 D	2.5	57	- 96	D4BA 4D55	4	█	Y-115T1	2189			
H 100 D	2.5	57	- 96	4D56	4	█	CY57	5287		D-POWER 21	4994
H 100 D intercooler	2.5	63	07.94 -	D4BF	4	█	Y-722J	2686			
H 100 i	2.4	84	01.97 -		4	1,1	BP6EY-11	4128			
i30 1.6	1.6	90	01.07 -	G4FC	4	0,7	ZFR5F	5165		ZFR5FIX-11	2477
Lantra 1(J-1)	1.5	63	92 -	G4DJ	4	1,1	BPR6ES-11	4824	13	BPR6EIX-11	3903
Lantra 2(J-2)	1.6	66	09.95 -	G4GR	4	1,1	BKR5ES-11	2382	33	BKR5EIX-11	5464
Lantra 1(J-1)	1.6	78	92 -	G4CR	4	1,1	BPR6ES-11	4824	13	BPR6EIX-11	3903
Lantra 3	1.6	79	09.00 -	G4ED-G DOHC	4	1,1	BKR5ES-11	2382	33	BKR5EIX-11	5464
Lantra 2(J-2)	1.6	84	09.95 -	G4GR	4	1,1	BKR5ES-11	2382	33	BKR5EIX-11	5464
Lantra 1(J-1)	1.8	93	92 -	G4CN	4	1,1	BPR6ES-11	4824	13	BPR6EIX-11	3903
Lantra 2(J-2)	1.8	94	09.95 -	G4GM	4	1,1	BKR5ES-11	2382	33	BKR5EIX-11	5464

<sup>1)</sup> Bic = Best in class



ℓ kW

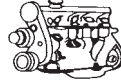

Cyl.

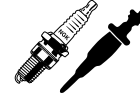
Order-  
No. No.Bic<sup>1)</sup> Order-  
D-Power No.**HYUNDAI**

Lantra D	1.9	50	98 -	XUD9A	4	█	Y-938R	5267		D-POWER 1	7906
Lantra 3	2.0	101	09.00 -	G4GC-G DOHC	4	1,1	BKR5ES-11	2382	33	BKR5EIX-11	5464
Lantra 2(J-2)	2.0	102	02.97 -		4	1,1	BKR5ES-11	2382	33	BKR5EIX-11	5464
LC 1.3i	1.3	55	01 -	G4EA-G	4	1,1	BKR5ES-11	2382	33	BKR5EIX-11	5464
LC 1.5i	1.5	75	01 -	G4EC-G DOHC	4	1,1	BKR5ES-11	2382	33	BKR5EIX-11	5464
M.X.	1.0	43	05.98 -		4	1,1	BKR6ES-11	5553	14	BKR6EIX-11	3764
Matrix CRDI	1.5	81	09.01 -	D3EA	3	█	Y-749J	5013			
Matrix FC	1.6	76	08.01 -	G4ED-G	4	1,1	BKR5ES-11	2382	33	BKR5EIX-11	5464
Matrix	1.8	90	08.01 -	G4GB	4	1,1	BKR5ES-11	2382	33	BKR5EIX-11	5464
Matrix FC	1.8	98	07.01 -		4	1,1	BKR5ES-11	2382	33	BKR5EIX-11	5464
Pony	1.2				4	0,8	BP5ES	6511	8	BPR5EIX	6597
Pony	1.4				4	0,8	BP5ES	6511	8	BPR5EIX	6597
Pony/Exel	1.3		85 -	G13B/G4DG	4	1,1	BPR6ES-11	4824	13	BPR6EIX-11	3903
Pony/Exel	1.5		85 -	G15B/G4DJ Cat.	4	1,1	BPR6ES-11	4824	13	BPR6EIX-11	3903
Pony/Exel	1.5		85 - 94	G15B/G4DJ	4	1,1	BPR6ES-11	4824	13	BPR6EIX-11	3903
Porter	2.4			SOHC	4	1,1	BP6ES-11	1212			
Porter H100	2.5			4D55	4	█	Y-115T1	2189			
Presto	1.3				4	0,8	BPR6ES	7822	2	BPR6EIX	6637
Presto	1.5				4	0,8	BPR6ES	7822	2	BPR6EIX	6637
S Coupe	1.5		92 -	G15B	4	1,1	BKR5ES-11	2382	33	BKR5EIX-11	5464
S Coupe Turbo	1.5		92 -		4	0,8	BKR6ES	3783	28	BKR6EIX	6418
S Coupe N/A	1.5	65	04.92 - 05.96	G4EK	4	1,1	BKR5ES-11	2382	33	BKR5EIX-11	5464
S Coupe Turbo Charge	1.5	85	04.91 - 05.98	G4EK-TC	4	0,8	BKR6ES	3783	28	BKR6EIX	6418
Santa Fe CRDI	2.0	83	04.01 - 05	D4EA	4	█	Y-749J	5013			
Santa Fe	2.0	92	05 -		4	█	Y-749J	5013			
Santa Fe / SM	2.4	107	02.01 - 05	G4JS-G	4	1,1	PGR5C-11	5760			
Santa Fe / SM	2.7	127	02.01 - 05	G6BA-G	6	1,1	PFR5N-11	5838			
Santa Fe	2.7	138	03.06 -			1,1	ILFR5B-11				
Santamo	2.0	101	99 -	DOHC / SOHC	4	1,1	BP6ES-11	1212			
Sonata 1.8i	1.8	70	89 -	G62B	4	1,1	BPR6ES-11	4824	13	BPR6EIX-11	3903
Sonata 2.0i	2.0		93 -	G4CP-D DOHC	4	1,1	BPR6ES-11	4824	13	BPR6EIX-11	3903
Sonata 2.0i	2.0	74	89 -	4G63 DOHC	4	1,1	BPR6ES-11	4824	13	BPR6EIX-11	3903
Sonata 2.0i	2.0	77	06.94 -	G4CP-D SOHC	4	1,1	BUR6EA-11	5428			
Sonata 2.0 EF	2.0	100	09.98 -	G4JP-G DOHC	4	1,1	BPR6ES-11	4824	13	BPR6EIX-11	3903
Sonata 2.4i (NF)	2.4	118	89 -	G4KC	4	1,1	BKR5ES-11	2382	33	BKR5EIX-11	5464
Sonata 2.4i	2.4	120	89 -	4G64	4	1,1	BPR6ES-11	4824	13	BPR6EIX-11	3903
Sonata 2.5 V6	2.5	118	09.98 -	G6BV-EG DOHC	6	1,1	PFR5J-11	4642			
Sonata 2.7 V6	2.7	127	10.01 -	G6BA-G	6	1,1	PFR5B-11	2300			
Sonata 3.0 V6	3.0		91 -	G6AT	6	1,1	PGR5A-11	3573			
Sonata 3.3 V6	3.3	173		G6DB	6	1,1	IFR5G-11				
Starex	2.4	82	02.98 -	SOHC	4	1,1	BP6ES-11	1212			
Stellar 1.6	1.6	56	10.83 - 12.91		4	0,8	BP5ES	6511	8	BPR5EIX	6597
Stellar 2.0	2.0				4	0,8	BP5ES	6511	8	BPR5EIX	6597
Terracan CRDI	2.9	110	10.01 -		4	█	CY57	5287		D-POWER 21	4994
Tiburon	1.6			DOHC	4	1,1	BKR5ES-11	2382	33	BKR5EIX-11	5464
Tiburon	1.8			DOHC	4	1,1	BKR5ES-11	2382	33	BKR5EIX-11	5464
Tiburon	2.0			DOHC	4	1,1	BKR5ES-11	2382	33	BKR5EIX-11	5464
Trajat CRDI	2.0	83	04.01 - 04	4DEA	4	█	Y-749J	5013			
Trajat / FO	2.0	100	05.00 -	G4JP-G DOHC	4	1,1	PFR6N-11	3546			
Trajat / FO	2.0	103	01.04 -		4	1,1	BKR5ES-11	2382	33	BKR5EIX-11	5464
Trajat / FO	2.7	127	07.00 -	G6BA DOHC	6	1,1	PFR5N-11	5838			
Tucson D	2.0	83	09.04 -		4	█	Y-749J	5013			

<sup>1)</sup> Bic = Best in class



l kW

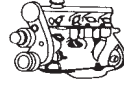

Cyl.

Order-  
No. No.Bic<sup>1)</sup> Order-  
D-Power No.**HYUNDAI**

Tucson	2.0	104	09.04-	G4GC	4	1,1	BKR5ES-11	2382	33	BKR5EIX-11	5464
Tucson V6	2.7	129	09.04-	G6BA	6	1,1	BKR5ES-11	2382	33	BKR5EIX-11	5464
X2	1.3				4	1,1	BPR6ES-11	4824	13	BPR6EIX-11	3903
X2	1.5				4	1,1	BPR6ES-11	4824	13	BPR6EIX-11	3903
XG 300 V6	3.0	138	99-	G6CT-EG DOHC	6	1,1	PFR5N-11	5838			
XG 350 V6	3.5	145	03-		6	1,1	PFR5N-11	5838			

**INFINITI**

FX 25	3.5	206	05-	VQ35DE V6	6	1,1	PLFR5A-11	6240			
FX 45	4.5	233	04-	VK45DE V8	8	1,1	PLFR5A-11	6240			
G20	2.0		91- 94	SR20DE	4	1,1	PFR5B-11	2300			
G20	2.0		99-	SR20DE	4	1,1	PFR5G-11	2647			
G20	2.0		95- 96	SR20DE	4	1,1	PFR5B-11	2300			
I30	3.0		96- 99	VQ30DE V6	6	1,1	PFR5G-11	2647			
J30	3.0		93- 97	VG30DE V6	6	1,1	PFR5G-11	2647			
M30	3.0		90- 92	VG30E	6	1,1	PFR6B-11	4014			
Q45	4.1		97- 98	VH41DE	8	1,1	PFR5G-11	2647			
Q45	4.5		90- 93	VH45D	8	1,1	PFR5B-11	2300			
Q45	4.5		94- 96	VH45DE	8	1,1	PFR5G-11	2647			
QX4	3.3		97- 98	VG33E	6	1,1	BKR5ES-11	2382	33	BKR5EIX-11	5464
QX4	3.3		99-	VD33DE	6	1,0	FR5AP-10	5463			
QX4	3.5		01-	VQ35DE	6	1,1	PLFR5A-11	6240			

**INNOCENTI**

3-Cylinder D CL-001				CL-001	3	█	Y-146R	7492			
500 L / SL	0.5	23	87-07.90	Daihatsu EB	3	0,9	BPR6EY	6427		BPR6EIX	6637
990 Matic / SE / SL / (CB22)	1.0	38	05.86-12.90	Z 670 Daihatsu	4	0,8	BPR5EY	2828	9*	BPR5EIX	6597
Clip ie	1.0	35	09.95-06.97	146C7.000	4	0,9	BPR5ES	7422	6	BPR5EIX	6597
Clip ie Super	1.4	51	09.95-06.97	160A1.046	4	0,8	BPR6ES	7822	2	BPR6EIX	6637
Elba	1.3	49	07.91-08.93	146A5.000	4	0,8	BPR6ES	7822	2	BPR6EIX	6637
Elba D	1.7	42	09.92-	146 B 2.000	4	█	Y-902R	2237		D-POWER 1	7906
Elba ie	1.4	49	11.95-06.97	146C5.000	4	0,8	BPR6ES	7822	2	BPR6EIX	6637
Elba ie	1.6	55	11.95-06.97	146C6.000	4	0,8	BPR6ES	7822	2	BPR6EIX	6637
Elba ie Happy	1.6	55	06.95-06.96	146C6.000	4	0,8	BPR6ES	7822	2	BPR6EIX	6637
Koral 45	0.9	33	10.90-06.97	100GL 064	4	0,8	BPR6ES	7822	2	BPR6EIX	6637
Koral 55	1.1	41	10.90-06.97	128A 064	4	0,8	BPR6ES	7822	2	BPR6EIX	6637
Mille	1.0	35	07.94-06.97	146C7.000	4	0,7	BP6ES	7811	4	BPR6EIX	6637
Mille i.	1.0	35	07.94-06.97	146C7.000	4	0,9	BPR5ES	7422	6	BPR5EIX	6597
Mini 990 D	1.0	27	01.82-12.90	Daihatsu	4	█	Y-146R	7492			
Small 500 L / LS	0.6	23	01.91-06.97	Daihatsu E	3	0,9	BPR6EY	6427		BPR6EIX	6637
Small 990 SE	1.0	38	01.91-06.97	Daihatsu CB	3	0,8	BPR5EY	2828	9*	BPR5EIX	6597

**ISCHMASCHAVTO**

Isch 2126/ 2715/ 27151/ 21171		53		412	4	0,8	BP7ES	2412		BPR7EIX	4055
-------------------------------	--	----	--	-----	---	-----	-------	------	--	---------	------

**ISUZU**

117 Coupe					4	0,7	BP6ES	7811	4	BPR6EIX	6637
Aska	1.8	77	-12.93	4ZB1	4	1,1	BPR5ES-11	4424		BPR5EIX-11	2115
Aska Turbo	2.0	110	-12.93	4ZC1	4	1,1	BPR5ES-11	4424		BPR5EIX-11	2115
Belleite					4	0,7	BP6ES	7811	4	BPR6EIX	6637
Fargo	2.0			4ZC1 Cat.	4	0,8	BPR6ES	7822	2	BPR6EIX	6637
Faster	2.3			4ZD1	4	0,8	BPR6ES	7822	2	BPR6EIX	6637

<sup>1)</sup> Bic = Best in class





ℓ kW

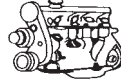

Cyl.

Order-  
No. No.Bic<sup>1)</sup> Order-  
D-Power No.**ISUZU**

Faster	2.3			4ZD1 Cat.	4	1,1	BPR6ES-11	4824	13	BPR6EIX-11	3903
Gemini FR				4FB1		█	Y-306R	6244			
Gemini TD	1.5		12.88 -	4EC1T	4	█	Y-711J	5264		D-POWER 28	4467
Gemini D	1.5		10.85 - 11.88	4EC1		█	Y-306R	6244			
Gemini FF Turbo	1.5		12.88 -	4EC1	4	█	Y-711J	5264		D-POWER 28	4467
Gemini FF D	1.5		12.88 -	4EC1	4	█	Y-710J	2785			
Gemini D	1.5	40	12.88 -	4EC1	4	█	Y-710J	2785			
Gemini TD	1.5	49	02.88 - 12.88	4EC1T	4	█	Y-307R	5837			
Gemini	1.5	54	05.87 -	4XC1, 4XB1	4	0,8	BP5ES	6511	8	BPR5EIX	6597
Gemini 1.5 Turbo	1.5	88	02.88 -	4XC1UT	4	1,1	BPR6ES-11	4824	13	BPR6EIX-11	3903
Gemini 16V	1.6	92	01.89 -	4XE1-W	4	1,1	BKR6E-11	2756	14	BKR6EIX-11	3764
Gemini 16V	1.6	92	01.89 -	4XE1-V	4	1,1	BPR6ES-11	4824	13	BPR6EIX-11	3903
I-Mark				G180Z	4	1,1	BPR6ES-11	4824	13	BPR6EIX-11	3903
Impulse Turbo				4ZCI	4	0,8	BPR6ES	7822	2	BPR6EIX	6637
Impulse				4ZCI	4	0,8	BPR6ES	7822	2	BPR6EIX	6637
Impulse				G200Z	4	1,1	BP5ES-11	7311			
Light Bus BE			76 -	6BB1		█	Y-271-2	7467			
Light Bus BE			76 -	6BD1		█	Y-271-2	7467			
Light Bus BE			80 -	4BD1		█	Y-271-2	7467			
Light Bus BL			07.81 -	4BC1		█	Y-271-2	7467			
Light Bus BL			07.81 -	4BC2		█	Y-271-2	7467			
Light Bus CCM			07.78 -	6BF1		█	Y-271-2	7467			
Light Bus CCM			07.79 -	6BD1		█	Y-271-2	7467			
Midi TD 11V	2.0	51	01.86 -		4	█	Y-711J	5264		D-POWER 28	4467
Midi TD 5V	2.0	51	01.86 -		4	█	Y-307R	5837			
Midi D 5V	2.2	45	01.86 -		4	█	Y-307R	5837			
Midi D 11V	2.2	45	01.86 -		4	█	Y-711J	5264		D-POWER 28	4467
Piazza	2.0	100	06.81 -	G200Z	4	1,1	BP5ES-11	7311			
Piazza Turbo	2.0	132	- 12.90	4ZCI	4	0,8	BPR6ES	7822	2	BPR6EIX	6637
Pickup D	2.0		01.83 -	C190	4	█	Y-306R	6244			
Pickup D	2.2	53	08.87 - 10.88	C223	4	█	Y-710J	2785			
Rodeo	2.3			4ZD1 Cat.	4	1,1	BPR6ES-11	4824	13	BPR6EIX-11	3903
Rodeo	2.3			4ZD1	4	0,8	BPR6ES	7822	2	BPR6EIX	6637
Rodeo	3.2	151	98 -	V DOHC	6	1,1	PFR5G-11	2647			
Trooper 2.2	2.2	66	- 10.88	4ZD1	4	0,8	BPR6ES	7822	2	BPR6EIX	6637
Trooper	2.3		88 -	4ZD1	4	0,8	BPR6ES	7822	2	BPR6EIX	6637
Trooper	2.3		87 -		4	0,8	BPR6ES	7822	2	BPR6EIX	6637
Trooper D	2.3	39	08.87 - 10.88	C223	4	█	Y-710J	2785			
Trooper TD	2.3	53	08.87 - 10.88	C223T	4	█	Y-710J	2785			
Trooper	2.3	66	01.87 -	4ZD1 Cat.	4	1,1	BPR6ES-11	4824	13	BPR6EIX-11	3903
Trooper	2.6			4ZE1	4	0,8	BPR6ES	7822	2	BPR6EIX	6637
Trooper	2.6	85	10.87 -	4ZE1 Cat.	4	1,1	BPR6ES-11	4824	13	BPR6EIX-11	3903
Trooper TD	2.8	71	10.87 - 12.91	4JB1T	4	█	Y-904M	4334			
Trooper TD	2.8	78	10.88 - 12.91	4JB1TC	4	█	Y-904M	4334			
Trooper TD	3.1	83	06.92 -	4JG2T	4	█	Y-711J	5264		D-POWER 28	4467
Trooper	3.5	158	04.00 -	6VE1 V6	6	1,1	PFR6B-11	4014			
Vehicross 3.2 24V	3.2	158	03.97 -	6VDI	6	1,1	BKR6E-11	2756	14	BKR6EIX-11	3764

**IVECO**

242/15 18 D	2.5	50	09.79 -			█	Y-208T	1250			
Daily	2.0				4	0,8	BPR7ES	2023	19	BPR7EIX	4055
Daily D30/35/40-8	2.4	53	10.83 - 06.89	Sofim 8140.61.200	4	█	Y-908R	4585		D-POWER 1	7906

<sup>1)</sup> Bic = Best in class



l kW

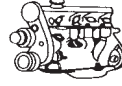

Cyl.

Order-  
No. No.Bic<sup>1)</sup> Order-  
D-Power No.**IVECO**

Daily	2.5				4	<input checked="" type="checkbox"/>	Y-907R	4479				
Daily TDi	2.8	90	09.97 -		6	<input checked="" type="checkbox"/>	Y-502R	3852				

**JAGUAR**

Double Six	5.3		90 -	V 12 HE	12	0,6	BR7EF	3346				
Sovereign 2.9	2.9		08.86 - 08.90	AJ6 SOHC	6	0,8	B8ES	2411		BR8EIX	5044	
Sovereign 3.2	3.2		07.90 - 07.97	AJ6	6	0,8	BCPR6ES	2330	12	BCPR6EIX	5689	
Sovereign 3.6	3.6		08.86 - 08.89	AJ6	6	0,8	BCPR6ES	2330	12	BCPR6EIX	5689	
Sovereign 4.0	4.0		09.89 - 09.97	AJ6	6	0,8	BCPR6ES	2330	12	BCPR6EIX	5689	
Sovereign V12	5.3		81 - 90	V12 HE	12	0,6	BR7EFS	1094				
S-Type V6	2.5	143	02.01 -	AJV6	6	1,3	PTR6D-13	5598				
S-Type V6	3.0	175	10.98 -	FC AJ-V6	6	1,3	PTR6D-13	5598				
S-Type V8	4.0	203	10.98 - 03.00	GC AJ-V8	8	1,3	PFR5G-13E	2761				
S-Type V8	4.0	203	03.00 - 03.02	GC AJ-V8	8	1,1	PFR5G-11E	3000				
S-Type 4.2 V8	4.2		03.02 -	AJ-V8	8	1,0	IFR5N10	7866				
S-Type R	4.2		03.02 -	AJ-V8	8	1,0	IFR5N10	7866				
S-Type R	4.2		03.02 -	AJ28	8	1,0	IFR5N10	7866				
XJ12	5.3		86 - 90	HE(V12)	12	0,6	BR7EF	3346				
XJ12	5.3		91 - 93	HE(V12)	12	0,6	BR7EF	3346				
XJ12	6.0		11.94 - 09.96	HE(V12)	12	0,6	BR6EF	3177				
XJ12	6.0		93 - 11.94	HE(V12)	12	0,6	BR7EF	3346				
XJ12	6.0		92 - 11.94	V12	12	0,6	BR7EF	3346				
XJ12	6.0		11.94 - 09.96	V12	12	0,6	BR6EF	3177				
XJ6 2.9	2.9		08.86 - 08.90	AJ6 SOHC	6	0,8	B8ES	2411		BR8EIX	5044	
XJ6	3.0		03.03 -	AJ-V6	6	1,3	PTR6D-13	5598				
XJ6	3.2		07.90 - 07.97	AJ6 Cat.	6	0,8	BCPR6ES	2330	12	BCPR6EIX	5689	
XJ6	3.6	136	08.86 - 05.92	AJ6	6	0,8	BCPR6ES	2330	12	BCPR6EIX	5689	
XJ6	4.0		09.89 - 09.97	AJ6 Cat.	6	0,8	BCPR6ES	2330	12	BCPR6EIX	5689	
XJ6 V12	5.3		01.91 -	V12	12	0,6	BR7EFS	1094				
XJ8	3.2		03.00 - 03.02	AJ26	8	1,1	PFR5G-11E	3000				
XJ8	3.2		03.02 -	AJ26	8	1,0	IFR5N10	7866				
XJ8	3.2		09.98 - 03.00	AJ26	8	1,3	PFR5G-13E	2761				
XJ8	3.2		09.97 - 09.98	AJ26	8	1,3	BKR5EVXA-13	1188				
XJ8	3.2	174	09.97 - 09.98	V8	8	1,3	BKR6EVXA-13	2563				
XJ8	3.2	176	09.97 -		8	1,3	BKR6EVXA-13	2563				
XJ8	3.5		03.03 -	AJ33	8	1,0	IFR5N10	7866				
XJ8	3.5		03.02 -	AJ26	8	1,0	IFR5N10	7866				
XJ8	4.0		03.00 - 03.02	AJ26	8	1,1	PFR5G-11E	3000				
XJ8	4.0		09.98 - 03.00	AJ26	8	1,3	PFR5G-13E	2761				
XJ8	4.0		09.97 - 09.98	AJ26	8	1,3	BKR5EVXA-13	1188				
XJ8	4.0		03.02 -	AJ26	8	1,0	IFR5N10	7866				
XJ8	4.0	209	09.97 -	V8	8	1,3	BKR6EVXA-13	2563				
XJ8 Supercharged	4.2		03.03 -	AJ33	8	1,0	IFR5N10	7866				
XJ8	4.2		03.02 -	AJ26	8	1,0	IFR5N10	7866				
XJ8	4.2		03.03 -	AJ33	8	1,0	IFR5N10	7866				
XJ8R Supercharged	4.0		09.97 - 02.00	AJ26	8	1,3	PFR6G-13E	2341				
XJ8R 4.0	4.0		03.00 - 03.02	AJ26	8	1,1	PFR5G-11E	3000				
XJ8R	4.0		03.02 -	AJ26	8	1,0	IFR5N10	7866				
XJ8R	4.0	272	09.97 - 03.00		8	1,3	PFR6G-13E	2341				
XJ8R 4.2	4.2		03.02 -		8	1,0	IFR5N10	7866				
XJR	3.6		11.88 - 09.89	AJ6	6	0,8	BCPR6E	1269	12	BCPR6EIX	5689	
XJR 4.0	4.0		09.89 - 09.94	AJ6	6	0,9	BCPR6ES	2330	12	BCPR6EIX-11	4919	

¹) Bic = Best in class



ℓ kW

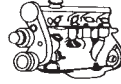

Cyl.

Order-  
No. No.Bic<sup>1)</sup> Order-  
D-Power No.**JAGUAR**

XJR Supercharged X300	4.0	235	08.94 - 08.97	AJ16 Kompressor	6	0,9	BKR7E	6097		BKR7EVX	3544
XJR8 V8 (X308)	4.0	267	09.97 -	V8	8	1,3	PFR6G-13E	2341			
XJS 3.6	3.6		08.86 - 05.91	AJ6	6	0,8	BCPR6ES	2330	12	BCPR6EIX	5689
XJS Coupe	4.0		04.91 - 09.96	AJ6	6	0,8	BCPR6ES	2330	12	BCPR6EIX	5689
XJS	5.3		81 - 90	V12 HE	12	0,6	BR7EFS	1094			
XJS	5.3		91 - 93	V12 HE	12	0,6	BR7EF	3346			
XJS	5.3		86 - 90	HE(V12)	12	0,6	BR7EF	3346			
XJS V12	6.0		05.93 - 11.94	V12	12	0,6	BR7EF	3346			
XJS V12	6.0		11.94 - 05.95	V12	12	0,6	BR6EF	3177			
XK8	4.0		03.00 -	AJ26	8	1,1	PFR5G-11E	3000			
XK8	4.0		09.98 - 03.00	AJ26	8	1,3	PFR5G-13E	2761			
XK8	4.0		09.98 - 03.00	AJ27	8	1,3	PFR5G-13E	2761			
XK8	4.0		09.97 - 09.98	AJ27	8	1,3	BKR5EVXA-13	1188			
XK8	4.0		03.02 -	AJ27	8	1,0	IFR5N10	7866			
XK8	4.0		03.00 - 02.02	AJ27	8	1,1	PFR5G-11E	3000			
XK8	4.0	213	09.97 - 09.98	AJ26	8	1,3	BKR5EVXA-13	1188			
XK8	4.0	213	10.96 - 09.97	AJ / V8	8	1,1	BKR6EVXA-11	6838			
XK8	4.0	389	10.96 - 09.97	AJ26	8	1,1	BKR6EVXA-11	6838			
XK8	4.2		09.02 -	AJ34	8	1,0	IFR5N10	7866			
XKR	4.0		03.02 -	AJ27	8	1,0	IFR5N10	7866			
XKR	4.0	267	05.98 - 03.00	AJ27	8	1,3	PFR6G-13E	2341			
XKR	4.0	267	03.00 - 02.02	AJ27	8	1,1	PFR5G-11E	3000			
XKR	4.2		09.02 -	AJ34	8	1,0	IFR5N10	7866			
X-Type 2.0	2.0	117	12.01 -	AJ-V6	6	1,3	PTR6D-13	5598			
X-Type 2.5	2.5	140	02.01 -	AJ-V6	6	1,3	PTR6D-13	5598			
X-Type 3.0	3.0	173	02.01 -	AJ-V6	6	1,3	PTR6D-13	5598			

**JEEP**

Cherokee TD	2.1	59	01.88 -		6	█	Y-908R	4585		D-POWER 1	7906
Cherokee TD	2.1	65	02.91 - 08.94	J8S 890	4	█	Y-913M	3965		D-POWER 15	5317
Cherokee TD	2.1	65	01.87 - 01.91	Renault J8S 814, J8S 890	4	█	Y-908R	4585		D-POWER 1	7906
Cherokee	2.4	108	08.01 -		4	1,1	LZTR4A-11	5444			
Cherokee	2.5		90 - 98	L4 MPI P	4	0,9	FR5-1	7252			
Cherokee	2.5		86 - 88	L4 TBI H	4	0,9	FR5-1	7252			
Cherokee	2.5		89 - 90	L4 TBI E	4	0,9	FR5-1	7252			
Cherokee TD	2.5	85	05.95 - 07.99	VM HR 425	4	█	Y-741U	5065		D-POWER 20	6943
Cherokee 3.7 V6	3.7	154	10.01 -		6	1,0	ZFR5F-11	2262		ZFR5FIX-11	2477
Cherokee	4.0		89 - 90	L6 MPI L	6	0,9	FR5	4876			
Cherokee	4.0		91 - 00	L6 MPI S	6		--- *				
Cherokee	4.0		87 - 88	L6 MPI M	6	0,9	FR5	4876			
Commanche	2.5		90 - 89	L4 TBI E	4	0,9	FR5-1	7252			
Commanche	2.5		86 - 88	L4 TBI H	4	0,9	FR5-1	7252			
Commanche	2.5		91 - 92	L4 MPI P	4	0,9	FR5-1	7252			
Commanche	4.0		89 - 90	L6 MPI L	6	0,9	FR5-1	7252			
Commanche	4.0		91 - 92	L6 MPI S	6	0,9	FR5-1	7252			
Commanche	4.0		87 - 88	L6 MPI M	6	0,9	FR5-1	7252			
Commander 3.0 CRD	3.0	160	06 -	Mercedes	6	█	Y-745U	4705		D-POWER 11	6346
Compass CRD	2.0	103	06 -		4	█	CZ301				
Grand Cherokee TD	2.5	88	01.93 -	VM HR 425 CLIRE	4	█	Y-923U	3380		D-POWER 1	7906
Grand Cherokee TD	2.5	88	01.93 -	VM HR-492	4	█	Y-923U	3380		D-POWER 1	7906
Grand Cherokee TD	2.5	110	04.99 -	ENC	4	█	Y-741U	5065		D-POWER 20	6943
Grand Cherokee CRD	2.7	120	01.02 -	CDI Mercedes	5	█	Y-745U	4705		D-POWER 11	6346

<sup>1)</sup> Bic = Best in class

\* only by car dealer



l kW

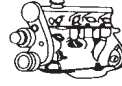

Cyl.

Order-  
No. No.Bic<sup>1)</sup> Order-  
D-Power No.**JEEP**

Grand Cherokee 3.0 CRD	3.0	160	06.05 -	Mercedes	6	█	Y-745U	4705		D-POWER 11	6346
Grand Cherokee TD / Limited	3.1	103	04.98 -	EXA	5	█	Y-741U	5065		D-POWER 20	6943
Grand Cherokee	3.7	0	05 -	V6 K FI	6	1,1	PZFR6F-11	3271			
Grand Cherokee	4.0		91 - 98	L6 MPI S	6	0,9	FR5-1	7252			
Grand Cherokee	4.0	0	03 - 04	L6 S FI	6	0,8	ZFR5N	3459			
Grand Cherokee	4.0	130	02.99 -				--- *				
Grand Cherokee	4.7	0	00 - 04	V8 N FI SOHC	8	1,1	PZFR6F-11	3271			
Grand Cherokee	4.7	0	02 - 04	V8 J FI SOHC&H.O.	8	0,9	BKR7E	6097		BKR7EIX	2667
Grand Cherokee	4.7	0	05 -	V8 N FI	8	1,1	PZFR6F-11	3271			
Grand Cherokee	4.7	173	02.99 - 99	MPI N V8	8	1,1	PZFR6F-11	3271			
Grand Cherokee	5.2		97 - 98	V8 MPI Y	8	0,9	FR5-1	7252			
Grand Cherokee	5.2		93 - 96	V8 MPI Y	8	0,9	FR4	5188			
Grand Cherokee	5.7	0	05 -	V8 2 FI	8	1,1	LZTR4A-11	5444			
Grand Cherokee	5.9		98 -	V8 MPI Z	8	1,0	FR5-1	7252			
Grand Voyager 2.5 Td Le	2.5	88	05.95 -	VM HR425 CLIEE	4	█	Y-741U	5065		D-POWER 20	6943
Grand Wagoneer	5.2		93 - 93	V8 MPI Y	8	0,9	FR4	5188			
Grand Wagoneer	5.9		89 - 91	V8 2Bbl 7	8	1,3	GR4	7038		GR4IX	7149
Grand Wagoneer	5.9		97 -	V8 MPI Z	8	0,9	FR4	5188			
J Serie	4.2		81 - 88	L6 2Bbl C	6	1,1	ZFR5A-11	5084			
J Serie	5.9		75 - 88	V8 2Bbl N	8	1,3	GR4	7038		GR4IX	7149
Liberty	2.4	0	02 -	L4 1 FI	4	1,1	LZTR4A-11	5444			
Liberty	3.7	0	02 -	V6 K FI	6	1,1	PZFR6F-11	3271			
Wagoneer	2.5		91 - 92	L4 MPI P	4	0,9	FR5-1	7252			
Wagoneer	2.5		86 - 88	L4 TPI H	4	0,9	FR5-1	7252			
Wagoneer	2.5		89 - 90	L4 TPI E	4	0,9	FR5-1	7252			
Wagoneer	4.0		89 - 90	L6 L	6	0,9	FR5-1	7252			
Wagoneer	4.0		87 - 88	L6 M	6	0,9	FR5-1	7252			
Wagoneer	4.0		91 - 92	L6 MPI S	6	0,9	FR5-1	7252			
Wrangler Laredo, Sahara, Texan TD	2.1	65	07.88 -		4	█	Y-908R	4585		D-POWER 1	7906
Wrangler	2.5		91 - 01.01	L4 MPI P	4	0,9	FR5-1	7252			
Wrangler, Texan D	2.5		07.88 -		6	█	Y-908R	4585		D-POWER 1	7906
Wrangler	2.5		87 - 88	L4 H	4	0,9	FR5-1	7252			
Wrangler	2.5		89 - 90	L4 TBI H	4	0,9	FR5-1	7252			
Wrangler	2.5		07.88 -		6	█	Y-908R	4585		D-POWER 1	7906
Wrangler, Laredo, Sahara	2.5		07.88 -		6	█	Y-908R	4585		D-POWER 1	7906
Wrangler	4.0		98 - 02	L6 MPI S	6	0,9	FR5-1	7252			
Wrangler	4.0		91 - 95	L6 MPI S	6	0,9	FR5-1	7252			
Wrangler	4.0		96 - 97	L6 MPI V	6	0,9	FR5-1	7252			
Wrangler	4.0	135	91 -	L6 MPI	6	1,1	ZFR5A-11	5084			
Wrangler	4.2		87 - 88	L6 C	6	1,1	ZFR5A-11	5084			
Wrangler	4.2		88 - 89	L6 M	6	1,1	ZFR5A-11	5084			
Wrangler	4.2		90 - 90	L6 T	6	1,1	ZFR5A-11	5084			

**KIA**

Avella	1.3				4	1,1	BPR5EY-11	3028		BPR5EIX-11	2115
Avella	1.5				4	1,1	BPR5ES-11	4424		BPR5EIX-11	2115
Besta 2.2	2.2				4	0,7	BP6ES	7811	4	BPR6EIX	6637
Besta 2.2	2.2	52	03.90 - 07.99	HW	4	█	Y-701R	7464			
Besta 2.7	2.7	60	03.90 - 07.99	VN	4	█	Y-701R	7464			
Bongo	2.4			E-2400	4	█	Y-107T	1253			
Carens 1.6	1.6	77	06.02 -	S6D	4	1,1	BKR6ES-11	5553	14	BKR6EIX-11	3764
Carens 1.8	1.8	81	01 -		4	0,9	BKR6E	6962	28	BKR6EIX	6418

<sup>1)</sup> Bic = Best in class

\* only by car dealer



ℓ kW

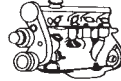

Cyl.

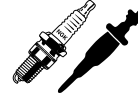
Order-  
No. No.Bic<sup>1)</sup> Order-  
D-Power No.**KIA**

Carens 1.8	1.8	93	06.02 -	TB	4	0,8	BKR6ES	3783	28	BKR6EIX	6418
Carens 2.0 CRDI EX	2.0	83	02 -	D4EA	4	█	Y-749J	5013			
Carens II 2.0	2.0	102	08.04 -	G4GC	4	1,1	BKR5ES-11	2382	33	BKR5EIX-11	5464
Carnival 2.5	2.5	121	12.98 -	K5	6	1,1	PFR6N-11	3546			
Carnival 2.5	2.5	129	12.98 -	KV5 DOHC	6	1,1	PFR6N-11	3546			
Carnival II 2.5	2.5	110	10.01 -		6	1,1	PFR6N-11	3546			
Carnival II 2.7	2.7	139	06.06 -	G6EA V6	6	1,1	ILFR5B-11				
Cee'd 1.4	1.4	80	01.07 -	G4FA	4	0,7	ZFR5F	5165		ZFR5FIX-11	2477
Cee'd 1.6	1.6	90	01.07 -	G4FC	4	0,7	ZFR5F	5165		ZFR5FIX-11	2477
Cee'd 2.0	2.0	105	01.07 -	G4GC	4	0,8	BKR5ES	2460	35	BKR5EIX	6341
Cerato 1.6	1.6	77	05.04 -	G4ED	4	1,1	BKR5ES-11	2382	33	BKR5EIX-11	5464
Cerato 2.0	2.0	106	05.04 -	G4GC	4	1,1	BKR5ES-11	2382	33	BKR5EIX-11	5464
Clarus 1.8	1.8	85	06.96 -	T8 DOHC	4	0,8	BKR5E	7938	35	BKR5EIX	6341
Clarus 2.0	2.0	98	09.96 -	FE DOHC	4	1,1	BK6E-11	7340		BKR6EIX-11	3764
Joice	2.0	103	09.01 -	G4CP	4	1,1	BPR6ES-11	4824	13	BPR6EIX-11	3903
K 2500	2.5	69	05 -	D4BH	4	█	Y-722J	2686			
Magentis	2.0	100	01 - 05		6	0,8	BPR6ES	7822	2	BPR6EIX	6637
Magentis CRDi	2.0	103	06 -	D4EA	4	█	Y-748U	5000		D-POWER 14	6649
Magentis	2.0	106	06 -	G4KA	4	1,1	BKR5ES-11	2382	33	BKR5EIX-11	5464
Magentis V6	2.5	118	01 -		6	0,8	BKR5ES	2460	35	BKR5EIX	6341
Magentis V6	2.5	124	03 -		6	0,8	BKR5ES	2460	35	BKR5EIX	6341
Magentis V6	2.7	138	06 -	G6EA	6	1,1	ILFR5B-11				
Mentor	1.5			B5	4	1,1	BPR5ES-11	4424		BPR5EIX-11	2115
Mentor	1.6		06.94 - 12.00		4	1,1	BPR5ES-11	4424		BPR5EIX-11	2115
Mentor	1.6		01 -	A6	4	0,9	BKR6E	6962	28	BKR6EIX	6418
Opirus	3.8	0	07 -	G6DA	6	1,1	IFR5G-11				
Opirus GH	3.5	149	03 - 06		6	1,1	PFR5N-11	5838			
Picanto	1.1	48	10.03 -	G4HG	4	1,1	BKR5ES-11	2382	33	BKR5EIX-11	5464
Picanto	1.1	55	06 -	D3FA	3	█	Y-527J *				
Power Bango	2.4			E-2400	4	█	Y-107R	1229			
Pregio	2.7	60	06.96 -	J2	4	█	Y-701R	7464			
Pregio	3.0	66	06.97 -	W3 / NB9	4	█	Y-701J	5116		D-POWER 39	1566
Pride	1.3	44	05.95 -		4	1,1	BPR5ES-11	4424		BPR5EIX-11	2115
Pride	1.3	53	05.95 -		4	1,1	BPR5ES-11	4424		BPR5EIX-11	2115
Retona	2.0	61	04.00 -		4	█	Y-721J	6919			
Retona 16V	2.0	94	00 -	FED	4	1,1	BKR6E-11	2756	14	BKR6EIX-11	3764
Rio	1.3	55	00 - 02		4	1,1	BPR5EY-11	3028		BPR5EIX-11	2115
Rio	1.3	60	03 -		4	1,1	BPR5ES-11	4424		BPR5EIX-11	2115
Rio	1.4	71	06.05 -		4	1,1	BKR5ES-11	2382	33	BKR5EIX-11	5464
Rio	1.5	71	03 -		4	1,1	BKR6ES-11	5553	14	BKR6EIX-11	3764
Rio	1.5	72	00 - 02		4	0,9	BKR6E	6962	28	BKR6EIX	6418
Rio CRDi	1.5	81	06.05 -	D4FA	4	█	Y-527J *				
Rio	1.6	82	06.05 -		4	1,1	BKR5ES-11	2382	33	BKR5EIX-11	5464
Roadster	1.8	103	98 -	T8 DOHC	4	0,8	BK6E	3536		BKR6EIX	6418
Rockstar	1.8			SOHC	4	0,7	BP6ES	7811	4	BPR6EIX	6637
Sedona	2.5		09.99 -	KV6	6	1,1	PFR6N-11	3546			
Sephia	1.5	59	96 -	B5E MMO	4	1,1	BPR5ES-11	4424		BPR5EIX-11	2115
Sephia	1.8		06.96 -		4	0,8	BKR5E	7938	35	BKR5EIX	6341
Sephia 2 FB522	1.6	75	04.01 -	OKAB5	4	0,9	BKR6E	6962	28	BKR6EIX	6418
Sephia GTX	1.6	59	09.93 -	B6 SOHC	4	1,1	BPR6ES-11	4824	13	BPR6EIX-11	3903
Shuma 1	1.5	65	05.98 -	BFD	4	1,1	BKR6E-11	2756	14	BKR6EIX-11	3764
Shuma 1	1.8	82	05.98 -	TED	4	0,9	BKR6E	6962	28	BKR6EIX	6418

<sup>1)</sup> Bic = Best in class

\* only by car dealer



l kW

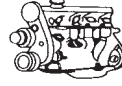

Cyl.

Order-  
No. No.Bic<sup>1)</sup> Order-  
D-Power No.**KIA**

Shuma 2 FB522,FB624	1.6	75	04.01 -	OKAB5	4	0,9	BKR6E	6962	28	BKR6EIX	6418
Shuma 2	1.8	82	01 -	TED	4	0,9	BKR6E	6962	28	BKR6EIX	6418
Sorento	2.4	75	02 -	G4JF	4	1,1	PGR5C-11	5760			
Sorento CRDi	2.5	103	08.02 -		4	█	Y-508J	3709			
Sorento	3.3	177	06 -	G66DB	6	1,1	IFR5G-11				
Sorento	3.5	143	02 -	G6CU	6	1,1	PFR5N-11	5838			
Sorento	3.8	0	06 -	G6DA	6	1,1	IFR5G-11				
Sportage TD	2.0	61	07.96 - 08.99	Mazda engine	4	█	Y-701R	7464			
Sportage	2.0	70	94 - 12.02	SOHC	4	0,8	BKR5E	7938	35	BKR5EIX	6341
Sportage	2.0	83	11.04 -		4	█	Y-749J	5013			
Sportage 16V	2.0	94	94 -	DOHC 16V	4	1,1	BKR6E-11	2756	14	BKR6EIX-11	3764
Sportage 2.0 CRDi	2.0	103	06 -	D4EA	4	█	Y-749J	5013			
Sportage 2.0	2.0	104	06 -	G4GC	4	1,1	BKR5ES-11	2382	33	BKR5EIX-11	5464
Sportage Tci	2.2	0				█	Y-701J	5116		D-POWER 39	1566
Sportage	2.5	129	09.04 -		6	1,1	BKR5ES-11	2382	33	BKR5EIX-11	5464
Sportage 2.7	2.7	129	06 -	G6BA V6	6	1,1	PFR5N-11	5838			
Super Titan	3.0			E-3000	6	█	Y-107T	1253			
Titan	2.5			E-2500	4	█	Y-107T	1253			
Titan	2.7			E-2700	4	█	Y-107T	1253			
Tropic	2.7	0		E-2700	4	█	Y-107T	1253			
Wide Bongo	2.2			LPG engine	4	0,7	BP6ES	7811	4	BPR6EIX	6637

**LADA (AVTOVAZ)**

2120 Nadeschda 1,7i	1.7	60	01.98 -	BA3-21214	4	1,1	BPR6ES-11	4824	13	BPR6EIX-11	3903
2120 Nadeschda 1,8	1.8	59	01.98 -	BA3-2130	4	0,8	BPR6ES	7822	2	BPR6EIX	6637
Aleko D	1.8	44	01.87 -	Ford RTE, RTS	4	█	Y-910R	4751		D-POWER 3	3617
Forma	1.3		09.91 -		4	0,8	BPR6ES	7822	2	BPR6EIX	6637
Forma	1.5	50	09.91 -		4	0,8	BPR6ES	7822	2	BPR6EIX	6637
Forma 21099	1.5	56			4	0,8	BPR6ES	7822	2	BPR6EIX	6637
21102 i	1.5	57	01.96 -	BA3 2111	4	1,1	BPR6ES-11	4824	13	BPR6EIX-11	3903
21103 16V	1.5	67	01.96 -	BA3 2112	4	1,1	BCPR6ES-11	7121	11	BCPR6EIX-11	4919
Lada 110 21101 8V	1.6	59	04 -	BA3 21114	4	1,1	BPR6ES-11	4824	13	BPR6EIX-11	3903
Lada 110 21104	1.6	66	04 -	BA3 21124	4	1,1	BCPR6ES-11	7121	11	BCPR6EIX-11	4919
2110 GTi 16V	2.0	110	01.96 -	C20XE Opel	4	0,9	BKR6E	6962	28	BKR6EIX	6418
110 2.0 GTI	2.0	110	01.00 -	C20XE	4	0,8	BKR6EK	2288	20	BKR6EQUIP	3199
21111	1.5	53	01.98 -	BA3 2120	4	0,8	BPR6ES	7822	2	BPR6EIX	6637
21110 i	1.5	57	01.98 -	BA3 2111	4	1,1	BPR6ES-11	4824	13	BPR6EIX-11	3903
21113 16V	1.5	67	01.98 -	BA3 2112	4	1,1	BCPR6ES-11	7121	11	BCPR6EIX-11	4919
Lada 111 21112 8V	1.6	59	04 -	BA3 21114	4	1,1	BPR6ES-11	4824	13	BPR6EIX-11	3903
Lada 111 21114 16V	1.6	66	04 -	BA3 21124	4	1,1	BCPR6ES-11	7121	11	BCPR6EIX-11	4919
21122 i	1.5	57	01.00 -	VAZ-2111	4	1,1	BPR6ES-11	4824	13	BPR6EIX-11	3903
21120 16V	1.5	67	01.00 -	VAZ-2112	4	1,1	BCPR6ES-11	7121	11	BCPR6EIX-11	4919
Lada 112 21121 8V	1.6	59	04 -	BA3 21114	4	1,1	BPR6ES-11	4824	13	BPR6EIX-11	3903
Lada 112 21124 16V	1.6	66	04 -	BA3 21124	4	1,1	BCPR6ES-11	7121	11	BCPR6EIX-11	4919
2102, 21021, 21022, 21023, 21024, 21026 Lada Kombi	1.2	43		BA3 2101	4	0,7	BP6ES	7811	4	BPR6EIX	6637
2102, 21021, 21022, 21023, 21024, 21026 Lada Kombi	1.3	47		BA3 21011	4	0,7	BP6ES	7811	4	BPR6EIX	6637
21040 / Nova Kombi	1.3	46	01.84 - 06.88	BA3 21011	4	0,7	BP6ES	7811	4	BPR6EIX	6637
21043 / Nova Kombi	1.5	53	01.88 -	BA3-2103	4	0,7	BP6ES	7811	4	BPR6EIX	6637
21051	1.2	43	01.80 - 06.88	BA3 2101	4	0,7	BP6ES	7811	4	BPR6EIX	6637
21050	1.5	53	01.88 -	BA3 21011	4	0,7	BP6ES	7811	4	BPR6EIX	6637

<sup>1)</sup> Bic = Best in class



ℓ kW

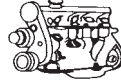

Cyl.

Order-  
No. No.Bic<sup>1)</sup> Order-  
D-Power No.**LADA (AVTOVAZ)**

21060	1.3	47		BA3 21011	4	0,7	BP6ES	7811	4	BPR6EIX	6637
21063	1.5	52		BA3 2103	4	0,7	BP6ES	7811	4	BPR6EIX	6637
21070	1.3	47	01.82-	BA3 21011	4	0,7	BP6ES	7811	4	BPR6EIX	6637
21073	1.5	53	01.88-	BA3 2103	4	0,7	BP6ES	7811	4	BPR6EIX	6637
Lada Kalina 1117	1.6	58	10.04-	BA3 11183	4	1,1	BCPR6ES-11	7121	11	BCPR6EIX-11	4919
Lada Kalina 1119	1.6	58	10.04-	BA3 11183	4	1,1	BCPR6ES-11	7121	11	BCPR6EIX-11	4919
Lada Kalina 1118	1.6	58	10.04-	BA3 11183	4	1,1	BCPR6ES-11	7121	11	BCPR6EIX-11	4919
Lada Kalina 1117 8V	1.6	59	05-	BA3 21114	4	1,1	BPR6ES-11	4824	13	BPR6EIX-11	3903
Lada Kalina 1118 8V	1.6	59	05-	BA3 21114	4	1,1	BPR6ES-11	4824	13	BPR6EIX-11	3903
Lada Kalina 1119 8V	1.6	59	05-	BA3 21114	4	1,1	BPR6ES-11	4824	13	BPR6EIX-11	3903
Lada Kalina 1117 16V	1.6	65	10.04-	BA3 21124	4	1,1	BCPR6ES-11	7121	11	BCPR6EIX-11	4919
Lada Kalina 1119 16V	1.6	65	10.04-	BA3 21124	4	1,1	BCPR6ES-11	7121	11	BCPR6EIX-11	4919
Lada Kalina 1118 16V	1.6	65	10.04-	BA3 21124	4	1,1	BCPR6ES-11	7121	11	BCPR6EIX-11	4919
Lada Niva 2129 1.7 Niva	1.7	59	93-	BA3 21213	4	0,8	BPR6ES	7822	2	BPR6EIX	6637
2105 Nova Junior	1.2				4	0,7	BP6ES	7811	4	BPR6EIX	6637
2105 Nova 1300	1.3				4	0,7	BP6ES	7811	4	BPR6EIX	6637
2105 Nova Spezial	1.5				4	0,7	BP6ES	7811	4	BPR6EIX	6637
21091	1.1	39	01.87-		4	0,8	BPR6ES	7822	2	BPR6EIX	6637
21081 / Fun 1100	1.1	39	01.84-		4	0,8	BPR6ES	7822	2	BPR6EIX	6637
21099	1.3	48	01.90-	BA3 2108	4	0,8	BPR6ES	7822	2	BPR6EIX	6637
21090	1.3	48	01.87-	BA3 2108	4	0,8	BPR6ES	7822	2	BPR6EIX	6637
21093	1.5	53	01.87-	BA3 2103	4	0,8	BPR6ES	7822	2	BPR6EIX	6637
21083 / Fun 1500	1.5	53	01.84-	BA3 2103	4	0,8	BPR6ES	7822	2	BPR6EIX	6637
Lada Samara 2113 8V	1.5	56	04-	BA3 2111	4	1,1	BPR6ES-11	4824	13	BPR6EIX-11	3903
2114 i	1.5	57	01.01-	BA3 2111	4	1,1	BPR6ES-11	4824	13	BPR6EIX-11	3903
21083 i	1.5	57		BA3 2111	4	1,1	BPR6ES-11	4824	13	BPR6EIX-11	3903
21093 i	1.5	57		BA3 2111	4	1,1	BPR6ES-11	4824	13	BPR6EIX-11	3903
2107 Toscana	1.5	55	07.88-		4	0,7	BP6ES	7811	4	BPR6EIX	6637
21213 Niva 1.7	1.7	55	01.93-		4	0,8	BPR6ES	7822	2	BPR6EIX	6637
21214 Niva 1.7i	1.7	60	01.01-	BA3-21214	4	1,1	BPR6ES-11	4824	13	BPR6EIX-11	3903
21210 Niva 1.6	1.6	51	01.77-	BA3 2121	4	0,7	BP6ES	7811	4	BPR6EIX	6637
21310 Niva 1.7i	1.7	60	01.95-	BA3-21214	4	1,1	BPR6ES-11	4824	13	BPR6EIX-11	3903
21312 Niva 1.8	1.8	59	01.95-	BA3-2130	4	0,8	BPR6ES	7822	2	BPR6EIX	6637
Niva D	1.9	47	10.93-	Peugeot XUD 9L	4	█	Y-902R	2237		D-POWER 1	7906
Nova / Vaz 2104, 2105		55	07.88-		4	0,8	BPR6ES	7822	2	BPR6EIX	6637
Nova / Vaz 2104, 2105		55	09.86-06.88		4	0,7	BP6ES	7811	4	BPR6EIX	6637
Nova / Vaz 2107		57	05.81-06.88		4	0,7	BP6ES	7811	4	BPR6EIX	6637
Nova / Vaz 2107		57	07.88-		4	0,8	BPR6ES	7822	2	BPR6EIX	6637
Nova / Vaz 21051	1.2	44	09.81-06.88		4	0,7	BP6ES	7811	4	BPR6EIX	6637
Nova / Vaz 21051	1.2	44	07.88-		4	0,8	BPR6ES	7822	2	BPR6EIX	6637
Nova / Vaz 2102, 2105	1.3	48	05.81-06.88		4	0,7	BP6ES	7811	4	BPR6EIX	6637
Nova / Vaz 2102, 2105	1.3	48	07.88-		4	0,8	BPR6ES	7822	2	BPR6EIX	6637
Nova / Vaz 21043	1.5	55	01.88-06.88		4	0,7	BP6ES	7811	4	BPR6EIX	6637
Nova / Vaz 21043	1.5	55	07.88-		4	0,8	BPR6ES	7822	2	BPR6EIX	6637
Nova i	1.7	59	11.94-		4	0,8	BPR6ES	7822	2	BPR6EIX	6637
Nova i	1.7	62	11.94-		4	0,8	BPR6ES	7822	2	BPR6EIX	6637
1111 Oka / 640	0.65	22	09.89-	BA3 1111	2	0,7	BCP6ES	4930	17	BCPR6EIX	5689
1111 Oka 1.3	1.3	46	01.98-	A-Plus ROV	4	0,8	BPR6ES	7822	2	BPR6EIX	6637
Riva 1200	1.2	47	11.85-	OHC 21012	4	0,7	BP6ES	7811	4	BPR6EIX	6637
Riva 1300	1.3	49	11.85-	OHC 21056	4	0,7	BP6ES	7811	4	BPR6EIX	6637
Riva 1500	1.5	55	11.85-	OHC 21026	4	0,7	BP6ES	7811	4	BPR6EIX	6637
Riva 1600	1.6	63	01.86-	OHC 21062	4	0,7	BP6ES	7811	4	BPR6EIX	6637

<sup>1)</sup> Bic = Best in class



l kW

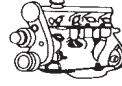

Cyl.

Order-  
No. No.Bic<sup>1)</sup> Order-  
D-Power No.**LADA (AVTOVAZ)**

Sagona GLX	1.5		07.95-		4	0,8	BPR6ES	7822	2	BPR6EIX	6637
Sagona i	1.5		07.94-		4	0,9	BPR5ES	7422	6	BPR5EIX	6597
Sagona D	1.5	40	01.95-	TUD5	4	█	Y-731U	5274		D-POWER 9	6281
Samara D	1.5	40	01.95-	TUD 5	4	█	Y-731U	5274		D-POWER 9	6281
Samara Sport	1.5	65	96-		4	0,8	BPR6ES	7822	2	BPR6EIX	6637
Toscana	1.5	55	01.86-		4	0,7	BP6ES	7811	4	BPR6EIX	6637

**LAMBORGHINI**

Murcielago Coupé	6.5	471	04.06-	L147	12		KR8BI	4347			
------------------	-----	-----	--------	------	----	--	-------	------	--	--	--

**LANCIA**

Dedra 1.6L i.e.	1.6	57	08.89-09.94	835A1.046 Cat.	4	0,8	BPR6ES	7822	2	BPR6EIX	6637
Dedra 1.6L - LE/S.W. LE	1.6	66	10.94-02.98	159B9.000	4	0,9	BCPR7ES	3330			
Dedra 1.6	1.6	66	03.97-02.98	159B9.000	4	0,9	BCPR7ES	3330			
Dedra 1.6i.e. 16V	1.6	76	03.98-01.00	182A4.000	4	0,9	BKR5EZ	7642		BKR5EIX	6341
Dedra 1.6i.e. S.W. 16V	1.6	76	03.98-01.00	182A4.000	4	0,9	BKR5EZ	7642		BKR5EIX	6341
Dedra 1.8L - LE-LS-SW	1.8	74	10.94-02.98	835A2.046	4	0,9	BCPR7ES	3330			
Dedra i.e./ LE	1.8	77	01.89-09.94	835A2.046 Cat.	4	0,8	BPR7ES	2023	19	BPR7EIX	4055
Dedra 1.8- 16V	1.8	83	07.97-01.00	182A2.000	4	0,9	BKR6EKC	2848	26	BKR6EIX	6418
Dedra TD	1.9	66	03.89-09.94	835 A 4.000	4	█	Y-902R	2237		D-POWER 1	7906
Dedra TD ds	1.9	66	10.94-	160 D 1.000	4	█	Y-922R	4356		D-POWER 1	7906
Dedra Eco LE TD	1.9	68	06.93-	160 D 1.000	4	█	Y-922R	4356		D-POWER 1	7906
Dedra i.e. / LS	2.0	83	01.89-09.94	835A5.046 Cat.	4	0,8	BPR7ES	2023	19	BPR7EIX	4055
Dedra i.e. automatica LS	2.0	83	10.94-04.97	835A5.046	4	0,8	BPR7ES	2023	19	BPR7EIX	4055
Dedra 2.0L-16V- S.W.LX / integrale	2.0	102	10.94-02.98	836A3.000	4	0,8	BPR7ES	2023	19	BPR7EIX	4055
Dedra 2000 Turbo	2.0	119	08.91-02.98	835A8.046	4	0,8	BP6ET	1263			
Dedra i.e. Turbo/Integr.	2.0	124	01.91-09.94	835A7.046 Cat.	4	0,8	BP6ET	1263			
Delta / LX	1.3	57	- 93	831A...- 831B.000	4	0,8	BPR7ES	2023	19	BPR7EIX	4055
Delta / LX / Automatic	1.5	59	- 93	831A...- 831B.000	4	0,8	BPR7ES	2023	19	BPR7EIX	4055
Delta	1.6	55	09.93-11.97	851C1.000	4	0,9	BCPR7ES	3330			
Delta (836)	1.6	66	03.96-02.98	182A6.000	4	0,9	BCPR7ES	3330			
Delta 1.6i.e. 16V HPE; LS	1.6	76	12.97-02.98	182A4.000	4	0,9	BKR6EKC	2848	26	BKR6EIX	6418
Delta	1.6	76	03.98-01.00	182A4.000	4	0,9	BKR5EZ	7642		BKR5EIX	6341
Delta 16V - HPE	1.6	76	06.96-11.97	182A4.000	4	0,8	BKR6EKC	2848	26	BKR6EIX	6418
Delta i.e. GT	1.6	77	- 93	182A4.000 Cat.	4	0,8	BPR6ES	7822	2	BPR6EIX	6637
Delta GT	1.6	77	- 93	831A4.000	4	0,8	BPR7ES	2023	19	BPR7EIX	4055
Delta i.e. / Turbo HF	1.6	95	- 93	831A7.000 Cat.	4	0,8	BPR7ES	2023	19	BPR7EIX	4055
Delta i.e. / LE	1.8	66	09.93-11.97	835C4.000	4	0,8	BPR7ES	2023	19	BPR7EIX	4055
Delta 16V/ HPE	1.8	96	06.96-11.97	183A1.000	4	0,8	BKR6EKC	2848	26	BKR6EIX	6418
Delta 1.8- 16V- HPE/LS	1.8	96	12.97-01.00	183A1.000	4	0,9	BKR6EKC	2848	26	BKR6EIX	6418
Delta TD	1.9	59	06.86-06.91	831 D 1.000	4	█	Y-902R	2237		D-POWER 1	7906
Delta TD- ds LE	1.9	66	10.94-	160 D 1.000	4	█	Y-922R	4356		D-POWER 1	7906
Delta TD ds	1.9	66	10.94-	160 D 1.000	4	█	Y-922R	4356		D-POWER 1	7906
Delta HPE Td	1.9	66	10.96-		4	█	Y-928U	5700		D-POWER 29	4389
Delta TD LS	1.9	66	10.94-	160 D 1.000	4	█	Y-922R	4356		D-POWER 1	7906
Delta HPE TD	1.9	66	10.94-	160 D 1.000	4	█	Y-922R	4356		D-POWER 1	7906
Delta i.e. 16V GT	2.0	102	10.94-11.97	836A3.000	4	0,8	BPR7ES	2023	19	BPR7EIX	4055
Delta i.e. 16V / LS	2.0	102	09.93-11.97	836A3.000	4	0,8	BPR7ES	2023	19	BPR7EIX	4055
Delta HPE ie	2.0	102	06.95-		4	0,8	BPR7ES	2023	19	BPR7EIX	4055
Delta i.e. Turbo HF Integr.	2.0	130	07.92-11.97	831C5.046	4	0,8	BPR7ES	2023	19	BPR7EIX	4055
Delta HF Integrale Evo 3	2.0	130	07.92-11.97	831C5.046	4	0,8	BP6ET	1263			
Delta i.e. Turbo HF 16V Inte	2.0	133	10.87-11.97	831 C5.000	4	0,8	BPR7ES	2023	19	BPR7EIX	4055

<sup>1)</sup> Bic = Best in class





ℓ kW

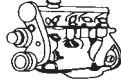

Cyl.

Order-  
No. No.Bic<sup>1)</sup> Order-  
D-Power No.**LANCIA**

Delta i.e. HPE Turbo 16V	2.0	137	01.93 - 09.96	836 A2.000	4	0,8	BPR7ES	2023	19	BPR7EIX	4055
Delta Turbo	2.0	137	09.93 - 11.97	836 A2.000	4	0,8	BP6ET	1263			
Delta HPE Turbo 16V HF	2.0	137	06.95 -		4	0,8	BUR6ET	3172	1	PGR6D	6248
Delta i.e. HPE Turbo 16V HF	2.0	142	12.97 - 01.00	175A4.000	4	0,9	BCPR6ET	2197		BCPR6EIX	5689
Delta HF integrale Spec.ed.	2.0	155	02.94 - 11.97	831E5.046	4	0,8	BUR6ET	3172	1	PGR6D	6248
HPE	1.6				4	0,8	BPR7ES	2023	19	BPR7EIX	4055
HPE i.e.	2.0				4	0,8	BPR7ES	2023	19	BPR7EIX	4055
K- 20V	2.0	107	01.95 - 02.01	838A1.000	5	0,9	BKR6EKC	2848	26	BKR6EIX	6418
K 20V LE	2.0	107	01.95 -	838A1.000	5	0,9	BKR6EKC	2848	26	BKR6EIX	6418
K 20V LS; S.W.	2.0	114	07.98 - 02.01	838 A6.000	5	0,9	BKR6EKC	2848	26	BKR6EIX	6418
K	2.0	114	11.94 - 02.01	838 A6.000	4	0,9	BKR6EKC	2848	26	BKR6EIX	6418
K	2.0	114	07.98 - 02.01	838A6.000	4	0,9	BCPR6ET	2197		BCPR6EIX	5689
K turbo	2.0	151	02.95 - 06.98	838A4.000	4	0,6	BP6ET	1263			
K Turbo 16V Coupé	2.0	151	07.97 - 06.98	838A4.000	4	0,9	BP6ET	1263			
K Turbo 20V; S.W.; Coupé	2.0	162	07.98 - 02.01	175 A3.000	5		BKUR6ET	6437	27	PFR6Q	6458
K i. 20V LS/LE/LX/SW	2.4	129	01.95 - 02.01	838A2.000	5	0,9	BKR6EKC	2848	26	BKR6EIX	6418
K i 20V Coupé	2.5	129	07.97 - 02.01	838A2.000	5	0,9	BKR6EKC	2848	26	BKR6EIX	6418
K i V6 24V aut. Coupé	3.0	150	07.97 - 02.01	838B.000	6	0,9	PFR6B	3500			
K V6 - 24V-LX/LS/SW/coupè	3.0	150	01.95 - 02.01	838B.000	6	0,7	PFR6B	3500			
Kappa i. 20V	2.0	107	01.95 - 02.01	838A1.000	4	0,9	BKR6EKC	2848	26	BKR6EIX	6418
Kappa turbo	2.0	151	02.95 - 02.01	838A4.000	4	0,6	BP6ET	1263			
Kappa TD	2.4		10.94 - 12.98	838 A3.000			Y-935U	5915		D-POWER 23	4791
Kappa	2.4	91	11.94 - 06.96	838.A3.000			Y-928U	5700		D-POWER 29	4389
Kappa / SW (838A) 2,4 JTD	2.4	100	06.98 - 11.99	838 A8.000	5		Y-747U	4951		D-POWER 26	4694
Kappa i. 20V	2.4	129	01.95 - 02.01	838A2.000	4	0,9	BKR6EKC	2848	26	BKR6EIX	6418
Kappa i. V6 24V	3.0	150	01.95 - 02.01	838B.000	4	0,7	PFR6B	3500			
Lybra 16V;Lx;S.W.	1.6	76	09.99 -	182 A4.000	4	0,9	BKR5EZ	7642		BKR5EIX	6341
Lybra 16V;Lx;S.W.	1.8	96	09.02 -	839 A4.000	4	0,9	BKR6EZ	4619		BKR6EIX	6418
Lybra 16V;Lx;S.W.	1.8	96	09.99 - 08.02	839 A4.000	4	0,9	BKR6EKC	2848	26	BKR6EIX	6418
Lybra 1.9 JTD	1.9	77	09.99 - 11.99	AR 32302	4		Y-747U	4951		D-POWER 26	4694
Lybra 1.9 JTD	1.9	85	12.99 -	AR 37101	4		Y-534J	5540		D-POWER 36	3413
Lybra 20V;Lx;S.W.;Aut.	2.0	110	09.02 -	182 B7.000	5	0,9	BKR6EZ	4619		BKR6EIX	6418
Lybra 20V;Lx;S.W.;Aut.	2.0	110	09.99 - 08.02	182 B7.000	5	0,9	BKR6EKC	2848	26	BKR6EIX	6418
Lybra 2.4 JTD	2.4	99	09.99 - 11.99	AR 32501	5		Y-747U	4951		D-POWER 26	4694
Lybra 2.4 JTD	2.4	110	12.99 -	839 A6.000	5		Y-534J	5540		D-POWER 36	3413
Musa	1.4	55	09.05 -	350A1.000	4	1,0	ZKR7A-10	1691			
Musa	1.4	66	10.04 -	192B2.000	4	1,0	DCPR7EN-10	4893			
Musa	1.4	70	09.04 - 02.05	843A1.000	4	0,9	DCPR7E-N	4795		DCPR7EIX	6046
Musa	1.4	70	02.05 -	843A1.000	4	1,0	DCPR7EN-10	4893			
Phedra JTD	2.0	80	09.02 -	DW10ATED4/RHT, RHW	4		Y-504R	4359		D-POWER 24	1441
Phedra JTD	2.2	94	06.03 -	DW12ATED4/4HW	4		Y-504R	4359		D-POWER 24	1441
Phedra 3,0 V6	3.0	150	10.02 -	XFW	6	1,1	PLFR5A-11	6240			
Prisma	1.3	57	12.82 - 12.89	831A2..- 831B000	4	0,8	BPR7ES	2023	19	BPR7EIX	4055
Prisma / LX	1.5	59	- 89	838C..	4	0,8	BPR7ES	2023	19	BPR7EIX	4055
Prisma / IE	1.6	66	05.86 - 12.89	831B7..	4	0,8	BPR7ES	2023	19	BPR7EIX	4055
Prisma TD	1.9	48	06.84 - 12.89	831 D. 000	4		Y-902R	2237		D-POWER 1	7906
Prisma TD ds	1.9	59	05.85 - 12.89	831 D.	4		Y-902R	2237		D-POWER 1	7906
Prisma TD	1.9	59	07.85 -		4		Y-908R	4585		D-POWER 1	7906
Prisma i.e.Integrale / 4WD	2.0	82	07.87 - 12.89	831B4.046	4	0,8	BPR7ES	2023	19	BPR7EIX	4055
Thema i.e. / Wagon	2.0	85	-01.95	834B.146 Cat.	4	0,8	BPR7ES	2023	19	BPR7EIX	4055
Thema i.e. 16V Tur. SW/LS/LX	2.0	108	-01.95	834B2.000	4	0,8	BP6ET	1263			
Thema i.e. Turbo SW	2.0	110	-01.95	834C146 Cat.	4	0,8	BPR7ES	2023	19	BPR7EIX	4055

<sup>1)</sup> Bic = Best in class



l kW

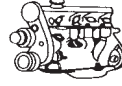

Cyl.

Order-  
No. No.Bic<sup>1)</sup> Order-  
D-Power No.**LANCIA**

Thema 16V / LE / LS	2.0	112	-01.95	834F1.000 Cat.	4	0,8	BPR7ES	2023	19	BPR7EIX	4055
Thema i.e.16V S.W. Fairway	2.0	112	04.94 -01.95	834F1.000	4	0,8	BPR7ES	2023	19	BPR7EIX	4055
Thema i.e. Turbo	2.0	122	-01.95	834C146	4	0,8	BPR7ES	2023	19	BPR7EIX	4055
Thema Turbo 16V LS/LX	2.0	132	-01.95	834C1.000	4	0,8	BP6ET	1263			
Thema i.e. Turbo 16V S.W.Fairway	2.0	148	04.94 -01.95	834C1.246	4	0,8	BUR6ET	3172	1	PGR6D	6248
Thema i.e. Turbo 16V LX	2.0	148	10.91 -01.95	834F2.000 Cat.	4	0,8	BP6ET	1263			
Thema i.e. Turbo 16V	2.0	148	04.94 -		4	0,9	BP6ET	1263			
Thema TD	2.4	74	01.93 -		4	█	Y-914U	2643		D-POWER 1	7906
Thema TD	2.5	85	01.94 -12.94			█	Y-926U	7119			
Thema i.e. V6	2.8	110	-01.95	PRV834AB Cat.	6	1,0	BPR6EFS	3623	7		
Thema i.e. V6 LS / LX / SW	3.0	126	92 -01.95	834F.000	6	0,8	BPR7ES	2023	19	BPR7EIX	4055
Thema 8.32	3.0	150	90 - 92	F105L Cat.	8	0,7	DCPR9E	2641		DCPR9EIX	2316
Thema 8.32	3.0	158	- 89	F105L	8	0,7	D8EA	2120			
Thesis 2.0 TB cambio 6 marce	2.0	136	11.02 -	841E.000	5	0,9	BKUR6ETB	6992			
Thesis 2.0 20 V TB	2.0	136	11.02 -	841E.000	5	0,9	BKUR6ETB	6992			
Thesis 2.4 JTD	2.4	110	11.02 -	841N 000	5	█	Y-534J	5540		D-POWER 36	3413
Thesis 2.4 20V	2.4	125	11.02 -	841D.000	5	0,9	BKR6EZ	4619		BKR6EIX	6418
Thesis 3.0 24V V6	3.0	158	11.02 -	841A.000	6	0,7	PFR6B	3500			
Thesis 3.2 24V V6	3.2	169	11.03 -	841A.000	6	0,7	PFR6B	3500			
Y 1.2 8V: Vanity- LS-Unica	1,2	44	10.00 -12.03	188A4.000	4	0,9	BKR5EZ	7642		BKR5EIX	6341
Y 1.2 16V- LS-LX-Unica	1,2	59	12.02 -12.03	188A5.000	4	0,9	DCPR7E-N	4795		DCPR7EIX	6046
Y 1.2 16V- LS-LX-Unica	1,2	59	10.00 -11.02	188A5.000	4	0,9	DCPR8E-N	5692			
Y 10 Fire	1.0	33	85 -10.96	156A2.000	4	0,8	BCPR6ES	2330	12	BCPR6EIX	5689
Y 10 4WD	1.0	33	85 -10.96	156A2.246	4	0,8	BCPR6ES	2330	12	BCPR6EIX	5689
Y 10 /4x4	1.1	37	09.86 -10.96	156C.046	4	0,6	BCPR7ES	3330			
Y 10 Selectronic i.e.	1.1	37	-10.96	156C.046 Cat.	4	0,8	BCPR6ES	2330	12	BCPR6EIX	5689
Y Elefantino Blu	1.1	40	05.97 -09.00	176B2.000	4	0,8	BCPR6ES	2330	12	BCPR6EIX	5689
Y Elefantino Blu	1.1	40	05.97 -04.00	176B2.000	4	0,9	BKR6E	6962	28	BKR6EIX	6418
Y 8 V Elefantino Blu -unica	1.2	44	10.99 -09.03	188A4.000	4	0,9	BKR5EZ	7642		BKR5EIX	6341
Y 8 V	1.2	44	01.96 -03.97	840.A3.000	4	0,8	BCPR6ES	2330	12	BCPR6EIX	5689
Y 8V LS,LE;ECVT	1.2	44	01.96 -10.99	840 A3.000	4	0,8	BCPR6ES	2330	12	BCPR6EIX	5689
Y 16V elefantino Blu /Rosso	1.2	59	10.00 -11.02	188A5.000	4	0,9	DCPR8E-N	5692			
Y 16V LE	1.2	63	02.98 -09.00	176B9.000	4	0,9	DCPR8E	4339		DCPR8EIX	6546
Y 16V,LE,LS,LX, Elefantino Rosso	1.2	63	04.97 -04.00	176B9.000	4	0,9	DCPR8E	4339		DCPR8EIX	6546
Y 16V	1.2	63	04.97 -03.00	176B9.000	4	0,9	DCPR8E	4339		DCPR8EIX	6546
Y 10 1300; G.T.	1.3	53	11.87 -10.96	146A5.046	4	0,8	BPR6ES	7822	2	BPR6EIX	6637
Y	1.4	55	01.96 -12.97		4	0,9	BCPR6ET	2197		BCPR6EIX	5689
Y i. 12V	1.4	55	01.96 -01.98	840 A2.000 - 4.000	4	0,9	BKR6EKC	2848	26	BKR6EIX	6418
Y i.e. 12V	1.4	59	01.96 -01.98	840A4.000	4	0,9	BKR6EKC	2848	26	BKR6EIX	6418
Ypsilon 8V	1.2	44	09.03 -10.04	188A4.000	4	0,9	BKR5EZ	7642		BKR5EIX	6341
Ypsilon 8V	1.2	44	10.04 -	188A4.000	4	1,0	DCPR7EN-10	4893			
Ypsilon 16V	1.2	57	09.03 -02.05	188A5.000	4	0,9	DCPR7E-N	4795		DCPR7EIX	6046
Ypsilon 16V	1.2	57	02.05 -	188A5.000	4	1,0	DCPR7EN-10	4893			
Ypsilon 16V	1.4	70	09.03 -02.05	843A1.000	4	0,9	DCPR7E-N	4795		DCPR7EIX	6046
Ypsilon	1.4	70	02.05 -	843A1.000	4	1,0	DCPR7EN-10	4893			
Z TD	1.9	68	04.95 -	XUD 9TE	4	█	Y-923U	3380		D-POWER 1	7906
Z i.e.	2.0	89	04.99 -12.01	RFV	4	0,9	BKR5EK	7956	23	BKR5EIX	6341
Z i.e. Turbo,LS	2.0	108	10.94 -03.99	RGX	4	0,8	BKR6EK	2288	20	BKR6EIQP	3199
Z TD	2.1	80	07.96 -	XUD11ATE	4	█	Y-923U	3380		D-POWER 1	7906

<sup>1)</sup> Bic = Best in class



ℓ kW

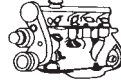

Cyl.

Order-  
No. No.Bic<sup>1)</sup> Order-  
D-Power No.**LAND ROVER**

90			83 -		4	█	Y-907R	4479			
110			83 -		4	█	Y-907R	4479			
90/110 V8			83 -		8	0,7	BP6ES	7811	4	BPR6EIX	6637
Country TD	2.5	83	01.89 -		4	█	Y-909R	4602			
Defender 2.5	2.5		90 -		6	0,8	BP6ES	7811	4	BPR6EIX	6637
Defender TDI	2.5	83	11.89 - 10.98	200/300 Gemini 1	4	█	Y-729U	2203		D-POWER 34	4119
Defender TDI 90 & 110	2.5	102	01.99 -		4	█	Y-917U	3219		D-POWER 1	7906
Defender 3.5 V8	3.5		90 -		8	0,9	BPR5ES	7422	6	BPR5EIX	6597
Discovery 2.0	2.0	99	06.93 - 01.99	Mpi	4	0,9	BKR6E	6962	28	BKR6EIX	6418
Discovery TDI	2.5	83	09.89 - 01.99	200/300 Gemini 1	4	█	Y-729U	2203		D-POWER 34	4119
Discovery TDi ES	2.5	83	09.89 -		4	█	Y-729U	2203		D-POWER 34	4119
Discovery TDi Vogue ES	2.5	90	10.93 -		4	█	Y-729U	2203		D-POWER 34	4119
Discovery & Restylé TD5	2.5	102	01.99 -		5	█	Y-917U	3219		D-POWER 1	7906
Discovery V8	3.5	107	09.89 - 01.99	V8 3.5	8	0,8	BPR6ES	7822	2	BPR6EIX	6637
Discovery V8	3.9	136	02.99 -	V8	8	0,8	BPR6ES	7822	2	BPR6EIX	6637
Discovery	4.0		94 - 99		8	0,8	BPR6ES	7822	2	BPR6EIX	6637
Discovery	4.0		10.98 -		8	1,1	PFR6N-11	3546			
Discovery 3	4.4		08.04 -		8	1,0	IFR5N10	7866			
Freelander	1.8	87	97 -	K SERIES	4	1,1	PFR6N-11	3546			
Freelander	2.0		01 -	KV6	6	1,1	PFR6N-11	3546			
Freelander TDI	2.0	71	10.97 - 08.98	20 T2R	4	█	Y-730U	2273		D-POWER 17	6704
Freelander TD4	2.0	80	08.98 -	M47D20 (BMW)	4	█	Y-507R	4600		D-POWER 32	2691
Freelander TDi	2.5	102	05.98 -		5	█	Y-917U	3219		D-POWER 1	7906
Freelander V6	2.5	130	09.00 -	KV6	6	1,1	PFR6N-11	3546			
Land Rover County D			01.89 -				█	Y-909R	4602		
Land Rover (90,110)	2.25		83 -				█	Y-208T	1250		
Land Rover	2.3		09.83 -		4	0,8	BP6EFS	3812	5		
Land Rover (90,110)	2.5		83 -				█	Y-208T	1250		
Land Rover	2.5	62	09.83 -		4	0,7	BP6ES	7811	4	BPR6EIX	6637
Land Rover	3.5	103	09.83 - 07.90	V8	8	0,7	BP6ES	7811	4	BPR6EIX	6637
Range Rover	2.5		09.89 -	200/300 Gemini 1	4	█	Y-729U	2203		D-POWER 34	4119
Range Rover	2.5	66	04.86 - 10.92	VM UNIT (NOT GEMINI ENG.)	4	█	Y-909R	4602			
Range Rover TDI	2.5	83	01.86 - 12.94	ETC 9091 N	4	█	Y-729U	2203		D-POWER 34	4119
Range Rover Vogue TD	2.5	87	01.90 - 09.94	VM HR-492	4	█	Y-923U	3380		D-POWER 1	7906
Range Rover Vogue TD	2.5	87	01.90 - 09.94	VM 425 SLIRR	4	█	Y-923U	3380		D-POWER 1	7906
Range Rover	2.5	100	09.94 -	M51 D25 (BMW)	6	█	Y-917U	3219		D-POWER 1	7906
Range Rover 3	3.0		02 -	M57 D30 (BMW)	6	█	Y-507R	4600		D-POWER 32	2691
Range Rover	3.5		08.81 - 10.89	V8EFI	8	0,8	BPR6ES	7822	2	BPR6EIX	6637
Range Rover	3.9	127	11.88 - 10.95	V8	8	0,8	BPR6ES	7822	2	BPR6EIX	6637
Range Rover	4.0		09.94 - 12.98		8	0,8	BPR6ES	7822	2	BPR6EIX	6637
Range Rover	4.0	131	01.99 - 02		8	1,1	PFR6N-11	3546			
Range Rover 4	4.2		05.05 -		8	1,0	IFR5N10	7866			
Range Rover	4.2		10.92 - 12.94	V8	8	0,8	BPR6ES	7822	2	BPR6EIX	6637
Range Rover 4	4.4		05.05 -		8	1,0	IFR5N10	7866			
Range Rover	4.4	210	09.99 -	BMW M62 B44	8		BKR6EQUIP	3199	30		
Range Rover	4.6	150	01.99 -		8	1,1	PFR6N-11	3546			
Range Rover	4.6	165	09.94 - 10.98	V8	8	0,8	BPR6ES	7822	2	BPR6EIX	6637
Range Rover III	3.0	130	03.02 -	M57 D30 BMW	6	█	Y-507R	4600		D-POWER 32	2691

**LDV**

Cub	2.3		09.98 -	LD23	4	█	Y-530J	6586			
-----	-----	--	---------	------	---	---	--------	------	--	--	--

<sup>1)</sup> Bic = Best in class



l kW

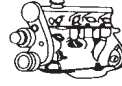

Cyl.

Order-  
No. No.Bic<sup>1)</sup> Order-  
D-Power No.**LEXUS**

ES 300 (MCV20)	3.0		01.00 - 03	2JZ-GE	6	1,1	BKR6EKP-11	3452			
ES 300 (MCV30)	3.0	0	01.04 -	1MZ-FE	6	1,1	IFR6T-11	4589			
GS 300 (JZS160)	3.0		01.00 -	1MZ-FE	6	1,1	BKR6EKP-11	3452			
GS 300 (UZS190)(GRS190)	3.0	0	05.05 -	3GR-FSE	6	1,1	IFR6T-11	4589			
GS 300 (JZS147)	3.0	156	93 - 99	2JZ-GE	6	1,1	BKR5EP-11	3440		BKR5EIX-11	5464
GS 300 (JZS160, UZS161)	3.0	161	01.02 -	2JZ-GE	6	1,1	BKR6EP-11	2978		BKR6EIX-11	3764
GS 300	3.0	163	97 -	2TZ-GE	6	1,1	BKR6EKP-11	3452			
GS 300 (UZS190)(GRS190)	3.0	183	05.05 -	3GR-FE	6	1,1	IFR6T-11	4589			
GS 430 (UZS190)	4.3	208	08.05 -	3UZ-FE	8	1,1	IFR6T-11	4589			
GS 430 (GRS190)	4.3	208	08.05 -	3UZ-FE	8	1,1	IFR6T-11	4589			
GS 430 (JZS160, UZS161)	4.3	208	01.02 -	3UZ-FE	6	1,1	IFR6T-11	4589			
GS 450h Hybrid (GWS191)	3.5	258	02.06 -	2GR-FSE	6	1,0	ILZKAR7A10				
IS 200 (GXE10)	2.0	114	01.00 -	1G-FE	6	1,1	IFR6T-11	4589			
IS 250 (GSE20)	2.5	153	08.05 -	4GR-FSE	6	1,0	ILZKAR7A10				
IS 300 (GXE10)(JCE10/ 15)	2.0	114	09.01 -	1G-FE	6	1,1	IFR6T-11	4589			
IS 300 (GXE10)(JCE10/ 15)	3.0		01.02 -	2JZ-GE	6	1,1	BKR6EP-11	2978		BKR6EIX-11	3764
LS 400	4.0		06.90 - 06.97	1UAZ-FE	8	1,1	BKR5EP-11	3440		BKR5EIX-11	5464
LS 400 (UCF20)	4.0		01.00 -	1UZ-FE	8	1,1	IFR6T-11	4589			
LS 400	4.0	180	90 - 94	1UZ-FE Cat.	8	1,1	BKR6EP-11	2978		BKR6EIX-11	3764
LS 400	4.0	194	10.94 - 12.99	1UZ-FE	8	0,8	BKR6EP-8	2215		BKR6EIX	6418
LS 430 (UCF30)	4.3	0	08.00 -	3UZ-FE without TWC	8	0,8	BKR6EYA	2249			
LS 430 (UCF30)	4.3	207	08.00 -	3UZ-FE with TWC	8	1,1	IFR6T-11	4589			
LS 460 (USF40 , 41)	4.6	0	09.06 -	1UR-FE	8	1,1	ILFR6C11				
LS 460 (USF40 , 41)	4.6	280	07.06 -	1UR-FSE	8	1,0	ILZKAR7A10				
LX 470 (UZJ100)	4.7		01.00 -	2UZ-FE with TWC	8	1,1	IFR6T-11	4589			
LX 470 (UZJ100)	4.7		01.00 -	2UZ-FE without TWC	8	0,8	BKR6EYA	2249			
RX 300 (MCU35,38)	3.0		01.04 - 06	1MZ-FE	6	1,1	IFR6T-11	4589			
RX 300 (MCU15)	3.0	150	07.00 - 06	1MZ-FE	6	1,1	IFR6T-11	4589			
RX 300 (MCU35,38)	3.3		01.04 - 06	3MZ-FE	6	1,1	IFR6T-11	4589			
RX 330 (MCU35,38)	3.0		01.04 -	1MZ-FE	6	1,1	IFR6T-11	4589			
RX 330 (MCU35,38)	3.3		01.04 -	3MZ-FE	6	1,1	IFR6T-11	4589			
RX 400 h (MHU38)	3.3	155	03.05 -	3MZ-FE	6	1,1	IFR6T-11	4589			
SC 430 (UZZ40)	4.3	210	05.01 -	3UZ-FE	8	1,1	IFR6T-11	4589			

**LEYLAND**

400-Serie LTD DI	2.5		01.87 -		5	☑	Y-902R	2237		D-POWER 1	7906
EA Range	1.8				4	☑	Y-302	2100			
Readline					4	☑	Y-302	2100			

**LEYLAND DAF**

200					4	0,7	BP6ES	7811	4	BPR6EIX	6637
400					4	0,7	BP6ES	7811	4	BPR6EIX	6637
Pilot	1.9		96 -	PEUGEOT	4	☑	Y-923U	3380		D-POWER 1	7906
Sherpa	1.7		86 -		4	0,7	BP6ES	7811	4	BPR6EIX	6637
Sherpa	2.0		86 -		4	0,7	BP6ES	7811	4	BPR6EIX	6637
Sherpa	2.0		86 - 88	PERKINS PRIMA	4	☑	Y-902R	2237		D-POWER 1	7906
Sherpa	2.5		04.86 - 89		4	☑	Y-208T	1250			
Sherpa	2.5		89 -	PEUGEOT ENGINE	4	☑	Y-923U	3380		D-POWER 1	7906
Sherpa	3.5				8	0,9	BPR5ES	7422	6	BPR5EIX	6597

<sup>1)</sup> Bic = Best in class



ℓ kW

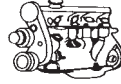

Cyl.

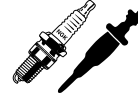
Order-  
No. No.Bic<sup>1)</sup> Order-  
D-Power No.**LOTUS**

Elan 1.6 16V	1.6		10.89 -		4	1,1	BKR6E-11	2756	14	BKR6EIX-11	3764
Elan SE 16V Turbo	1.6		10.89 -		4	0,8	BKR6E	6962	28	BKR6EIX	6418
Elise	1.8	88	96 -	K- SERIES (Including) VVC	4	1,1	PFR6N-11	3546			
Elise 111S	1.8	107	99 -		4	1,1	PFR6N-11	3546			
Elite			76 -	Carbu. Dellorto	4	0,6	BP6ES	7811	4	BPR6EIX	6637
Elite				Carbu. Zenith	4	0,6	BP6ES	7811	4	BPR6EIX	6637
Elite GR, Super 95					4	0,6	B8ES	2411		BR8EIX	5044
Esprit 2.0 Turbo 16V GT3	2.0		10.96 -		4	0,8	BPR6EKN	1128			
Esprit SE 2.2	2.2		11.94 - 07.96	Cat.	4	0,8	BPR6EKN	1128			
Esprit S4	2.2		93 - 07.96		4	0,6	BPR6EKN	1128			
Esprit Sport 300	2.2		93 -		4	0,6	BPR6EKN	1128			
Esprit Turbo	2.2		87 -		4	0,8	BPR6ES	7822	2	BPR6EIX	6637
Esprit HC	2.2		85 -	DOHC	4	0,8	BPR7ES	2023	19	BPR7EIX	4055
Esprit Turbo SE	2.2	197	89 -	910S	4	0,6	BPR6EKN	1128			
Esprit	3.5	260	96 -	918	8	0,9	BKR6EKC	2848	26	BKR6EIX	6418
Europa Special, Twin-Cam, S2, S1			85 -		4	0,8	BP7ES	2412		BPR7EIX	4055
Excel SA / SE	2.2	135	85 - 91	912S	4	0,8	BPR7ES	2023	19	BPR7EIX	4055
Exige 1.8 16V	1.8	132	07.00 -		4	0,8	BKR7E	6097		BKR7EVX	3544
Seven	1.3			1300cc (Ford)	4	0,7	BP6ES	7811	4	BPR6EIX	6637
Seven	1.6			1600cc (Ford)	4	0,6	BP6ES	7811	4	BPR6EIX	6637
Seven	1.6			1558cc (Lotus)	4	0,6	BP7ES	2412		BPR7EIX	4055

**LUBLIN (Daewoo)**

Lublin 1.8	1.8	70	02.96 -		4	0,8	BPR5EY	2828	9	BPR5EIX	6597
Lublin 2.0	2.0	77	02.96 -		4	0,8	BPR5EY	2828	9	BPR5EIX	6597

**LWMC**

Landwind	2.4	92	05 -	4G64S4M Mitsubishi	4	1,1	BKR5E-11	6953	33	BKR5EIX-11	5464
Landwind	2.8	0	05 -	JX493ZQ / ISUZU / 4JB1T		█	Y-904M	4334			

**MAHINDRA**

CJ 340 Classic D	2.1	48	93 -	XD 4.90	4	█	Y-208T	1250			
CJ 540 D	2.1	48	93 -	XD 4.90	4	█	Y-208T	1250			
CJ3			04.86 -	Peugeot	4	█	Y-902R	2237		D-POWER 1	7906
CJ5			04.86 -	Peugeot	4	█	Y-902R	2237		D-POWER 1	7906

**MARUTI**

800	0,8	26	01.91 -		3	0,7	BPR5ES	7422	6	BPR5EIX	6597
-----	-----	----	---------	--	---	-----	--------	------	---	---------	------

**MASERATI**

2.24 V	2.0	180	88 -	AM 475	4	0,9	DCPR8E	4339		DCPR8EIX	6546
222	2.0	162	01.89 - 10.89	471	4	0,7	BP8ES	2912			
222 IE	2.8			V6	6	0,7	DCPR7E	3932		DCPR7EIX	6046
228 I	2.8	184	12.87 -	Bi Turbo Cat.	6	0,7	BP8ES	2912			
3200 GT	3.2	271	12.98 - 09.01	585	8	0,7	PMR8A	5851			
4.18 V	2.0		02.91 -		6	0,7	BP8ES	2912			
4.24 V / Spider 24V	2.0	180	90 -	475	6	0,9	DCPR8E	4339		DCPR8EIX	6546
420 / I / S / SI /	2.0	138	01.87 -	470	6	0,7	BP8ES	2912			
422	2.0	164	88 -	AM 471	6	0,7	BP8ES	2912			
422	2.8			V6	6	0,7	DCPR7E	3932		DCPR7EIX	6046
430	2.8	182	02.88 -	473 Cat.	6	0,7	BP8ES	2912			
Biturbo	2.5		85 -		6	0,7	BP8ES	2912			

<sup>1)</sup> Bic = Best in class



l kW

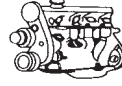

Cyl.

Order-  
No. No.Bic<sup>1)</sup> Order-  
D-Power No.**MASERATI**

Biturbo	2.8		85 -		6	0,7	BP8ES	2912			
Coupè GT / Cambiocorsa	4.2	287	12.03 -	F136R	8	0,7	PMR8B	6378			
Coupè GT / Cambiocorsa	4.2	287	06.02 - 11.03	F136R	8	0,7	PMR8A	5851			
Ghibli	2.0			V8	8	0,7	DCPR9E	2641		DCPR9EIX	2316
Ghibli	2.0	209	09.96 -	496	6	0,7	DCPR9E	2641		DCPR9EIX	2316
Ghibli V6	2.8	209	11.95 -		6	0,7	DCPR9E	2641		DCPR9EIX	2316
Gransport	4.2	294	09.04 -	F136S	8	0,7	PMR8B	6378			
Karif	2.8	165	04.88 -	437 Cat.	6	0,7	BP8ES	2912			
Quattroporte i. V6 24V	2.0	211	11.94 -	475	6	0,7	DCPR9E	2641		DCPR9EIX	2316
Quattroporte i. V6 24V	2.8	209	11.95 - 01.99		6	0,7	DCPR9E	2641		DCPR9EIX	2316
Quattroporte V6 Evoluzione	2.8	260	02.99 - 12.01	588	6	0,9	DCPR8E	4339		DCPR8EIX	6546
Quattroporte V8 Evoluzione	3.2	270	02.99 - 02	578	8	0,7	PMR8A	5851			
Quattroporte 4,2 V8	4.2	294	12.03 -	F136S	8	0,7	PMR8B	6378			
Quattroporte 4,2 V8	4.2	294	11.02 - 11.03		8	0,7	PMR8A	5851			
Racing	2.0	194	02.91 -	475	6	0,7	DCPR9E	2641		DCPR9EIX	2316
Shamal I Turbo 32V	3.2	240	02.91 - 02.96	AM 479 Cat.	8	0,9	DCPR8E	4339		DCPR8EIX	6546
Spyder	2.8	165	01.90 -	473 Cat.	6	0,7	BP8ES	2912			
Spyder GT/Cambiocorsa	4.2	287	12.03 -	F136R	8	0,7	PMR8B	6378			
Spyder GT/Cambiocorsa	4.2	287	10.01 - 11.03	F136R	8	0,7	PMR8A	5851			

**MAYBACH**

Maybach 57/ 62 (240)	5.5	404	09.02 -	M 285.950	12	0,8	IFR6Q-G	5648			
Maybach 62S (240)	6.0	450	09.05 -	M 285.980	12	0,8	IFR6Q-G	5648			

**MAZDA**

121 DA Fgst--> 200000	1.1	40	- 03.91	B1 u.Cat.	4	0,9	BPR5ES	7422	6	BPR5EIX	6597
121 16V	1.25	55	00 -	DHB / DHC / DHD / DHF	4	1,3	PTR5A-13	2467	25		
121 ZQ	1.3	37	03.96 -	JJA / JJC / JJE / J4C	4	1,0	PTR5D-10	3784	31		
121 DB Fgst--> 400000	1.3	39		B3 16V Cat.	4	1,1	BKR6E-11	2756	14	BKR6EIX-11	3764
121 DA Fgst 200001-->	1.3	40		B3 Cat.	4	1,1	BPR6ES-11	4824	13	BPR6EIX-11	3903
121 DA Fgst--> 200000	1.3	44	03.96 -	B3	4	0,9	BPR5ES	7422	6	BPR5EIX	6597
121 DB Fgst 400000-->	1.3	53		B3 16V Cat.	4	1,1	BKR6E-11	2756	14	BKR6EIX-11	3764
121 ZQ	1.3	55	03.96 -	DHA Zetec (FORD)	4	1,3	PTR5A-13	2467	25		
121	1.8	44	03.96 -	RTJ	4	█	Y-910R	4751		D-POWER 3	3617
2 DY Fgst 3*00001-->	1.25	55	03 - 07	MZI FUJB / F8JA	4	1,3	PTR5A-13	2467	25		
2 DY Fgst 3*00001-->	1.25	55	03 - 07	MZI FUJA / F8JB	4	1,3	PTR5A-13	2467	25		
2 DY Fgst 3*00001-->	1.4	59	03 - 07	MZI DOHC FXJA / FXJB	4	1,3	PTR5A-13	2467	25		
2 DY Fgst 3*00001-->	1.6	74	03 - 07	MZI DOHC FYJA	4	1,3	PTR5A-13	2467	25		
3	1.4	59	04 -	ZJ	4	1,1	IFR5E-11	7994			
3	1.6	77	10.03 -	Z6	4	1,1	IFR5E-11	7994			
3	2.0	110	10.03 -	LF	4	1,3	ITR6F-13	4477			
323 BF Fgst--> 400000	1.1	40		E1	4	0,8	BPR6ES	7822	2	BPR6EIX	6637
323 BD1 Fgst 800000 -->	1.1	40		E1	4	0,8	BPR6ES	7822	2	BPR6EIX	6637
323 BG ...	1.3		90 -	B3 Vergaser	4	0,8	BKR5E	7938	35	BKR5EIX	6341
323 BD1 Fgst 800000 -->	1.3	44		E3	4	0,8	BPR6ES	7822	2	BPR6EIX	6637
323 BF Fgst 400001 -->	1.4	44		B3 u.Cat.	4	0,8	BPR6ES	7822	2	BPR6EIX	6637
323 BG Fgst--> 500000	1.4	49		B3E Cat.	4	1,1	BPR6ES-11	4824	13	BPR6EIX-11	3903
323 BJ Fgst 400001-->	1.4	53	02 -	B3 SOHC	4	1,1	BKR5E-11	6953	33	BKR5EIX-11	5464
323 BA Fgst 300001 -->	1.4	54	09.94 -	B3	4	1,1	BKR6E-11	2756	14	BKR6EIX-11	3764
323 BG Fgst 500001 -->	1.4	54		B3 16V Cat.	4	1,1	BKR6E-11	2756	14	BKR6EIX-11	3764
323 BJ Fgst 100001-->	1.4	54	09.98 -	B3	4	1,1	BKR5E-11	6953	33	BKR5EIX-11	5464
323 BA Fgst 500001 -->	1.4	54		B3 16V Cat.	4	1,1	BKR6E-11	2756	14	BKR6EIX-11	3764

<sup>1)</sup> Bic = Best in class

Fgst = Chassis No.



ℓ kW

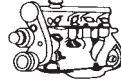

Cyl.

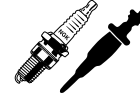
Order-  
No. No.Bic<sup>1)</sup> Order-  
D-Power No.**MAZDA**

323 BF Fgst 400001 -->	1.5	54		B5	u.Cat.	4	0,8	BPR6ES	7822	2	BPR6EIX	6637
323 BW Fgst400001--500000	1.5	54		B5	u.Cat.	4	0,8	BPR6ES	7822	2	BPR6EIX	6637
323 BF Fgst--> 400000	1.5	55		E5		4	0,8	BPR6ES	7822	2	BPR6EIX	6637
323 BW Fgst--> 400000	1.5	55		E5		4	0,8	BPR6ES	7822	2	BPR6EIX	6637
323 BD1 Fgst 800000 -->	1.5	55		E5		4	0,8	BPR6ES	7822	2	BPR6EIX	6637
323 BJ Fgst 100001 -->	1.5	65	09.98 -	ZL		4	1,1	BKR5E-11	6953	33	BKR5EIX-11	5464
323 BA Fgst 500001 -->	1.5	65		Z5 16V	Cat.	4	1,1	BKR6E-11	2756	14	BKR6EIX-11	3764
323 BA Fgst 100001-->	1.5	65	09.94 -	Z5	Cat.	4	1,1	BKR5E-11	6953	33	BKR5EIX-11	5464
323 BG Fgst--> 500000	1.6	62		B6E	Cat.	4	1,1	BPR6ES-11	4824	13	BPR6EIX-11	3903
323 BW Fgst 500001 -->	1.6	63		B6	Cat.	4	1,1	BPR6ES-11	4824	13	BPR6EIX-11	3903
323 BF1 Fgst 400001 -->	1.6	63		B6	Cat.	4	0,8	BPR6ES	7822	2	BPR6EIX	6637
323 BW Fgst 400001-500000	1.6	63		B6	Cat.	4	1,1	BPR5ES-11	4424		BPR5EIX-11	2115
323 BF1 Fgst--> 400000	1.6	63		B6	Cat.	4	1,1	BPR5ES-11	4424		BPR5EIX-11	2115
323 BG Fgst 500001 -->	1.6	65		B6 16V	Cat.	4	1,1	BKR6E-11	2756	14	BKR6EIX-11	3764
323 BF1 Fgst--> 400000	1.6	77		B6		4	0,8	BPR6ES	7822	2	BPR6EIX	6637
323 BF1 Fgst 400001 -->	1.6	103	85 - 91	B6 DOHC	Cat.	4	1,1	BCPR6E-11	3132	11	BCPR6EIX-11	4919
323 Turbo BF2 400001 -->	1.6	103		B6 DOHC	Cat.	4	1,1	BCPR6E-11	3132	11	BCPR6EIX-11	4919
323 BF2 Fgst--> 400000	1.6	110		B6 DOHC		4	0,8	BCPR6E	1269	12	BCPR6EIX	5689
323	1.7					4	█	CY03	4315		D-POWER 8	6160
323 TD BF-->Fgst 300001	1.7	60	99 -	4EE1-T		4	█	CY03	4315		D-POWER 8	6160
323	1.8		89 -	BP DOHC	Cat.	4	1,1	BKR6E-11	2756	14	BKR6EIX-11	3764
323 Turbo	1.8		89 -	BP		4	1,1	BKR6E-11	2756	14	BKR6EIX-11	3764
323	1.8		89 -	BP EGI	Cat.	4	0,8	BKR5E	7938	35	BKR5EIX	6341
323	1.8	84	02.97 -	B6D		4	1,1	BKR5E-11	6953	33	BKR5EIX-11	5464
323 GTR Turbo	1.8	136	95 -			4	1,1	BKR6EVX-11	3540		BKR6EIX-11	3764
323 BG Fgst--> 500000	1.9	76		BP SOHC 16V	Cat.	4	1,1	BKR6E-11	2756	14	BKR6EIX-11	3764
323 BG Fgst 500001 -->	1.9	76		BP SOHC 16V	Cat.	4	1,1	BKR6E-11	2756	14	BKR6EIX-11	3764
323 BJ Fgst 100001 -->	1.9	84	09.98 -	FP		4	1,1	BKR5E-11	6953	33	BKR5EIX-11	5464
323 BA Fgst 500001 -->	1.9	84		BP 16V	Cat.	4	1,1	BKR6E-11	2756	14	BKR6EIX-11	3764
323 BA Fgst 300001 -->	1.9	84	09.94 -	BP 16V	Cat.	4	1,1	BKR5E-11	6953	33	BKR5EIX-11	5464
323 BG Fgst 500001 -->	1.9	94		BP DOHC 16V	Cat.	4	1,1	BKR6E-11	2756	14	BKR6EIX-11	3764
323 BG Fgst--> 500000	1.9	94		BP DOHC 16V	Cat.	4	1,1	BKR6E-11	2756	14	BKR6EIX-11	3764
323 BG Turbo 16V	1.9	120		BP DOHC 16V	Cat.	4	1,1	BKR6E-11	2756	14	BKR6EIX-11	3764
323 BJ Fgst 400001-->	2.0	96	02 -	FS DOHC (High Power)		4	1,1	ZFR5F-11	2262		ZFR5F1X-11	2477
323 BA Fgst 500001 -->	2.0	106	08.94 - 10.98	KF DOHC V6		6	1,1	BKR6E-11	2756	14	BKR6EIX-11	3764
323 BA Fgst 100001 -->	2.0	106	09.94 - 10.98	KF DOHC V6		6	1,1	BKR6E-11	2756	14	BKR6EIX-11	3764
5	2.0	106	06.05 -	LF		4	1,3	ITR5F-13	6044			
5	2.3	0	05 -	L3-VE		4	1,3	ITR5F-13	6044			
6 GG Fgst 100001-->	1.8	88	06.02 - 07	MZR-L8	DOHC	4	1,3	ITR6F-13	4477			
6 Sport-Kombi GY Fgst 100001-->	1.8	88	06.02 - 07	MZR-L8	DOHC	4	1,3	ITR6F-13	4477			
6 Sport-Kombi GY Fgst 100001-->	2.0	104	06.02 - 07	MZR-LF	DOHC	4	1,3	ITR6F-13	4477			
6 GG Fgst 100001-->	2.0	104	06.02 - 07	MZR-LF	DOHC	4	1,3	ITR6F-13	4477			
6 Sport-Kombi 4WD GY Fgst 100001-->	2.3	119	06.02 - 07	MZR-L3	DOHC	4	1,3	ITR6F-13	4477			
6 Sport-Kombi GY Fgst 100001-->	2.3	122	06.02 - 07	MZR-L3	DOHC	4	1,3	ITR6F-13	4477			
6 GG Fgst 100001-->	2.3	122	06.02 - 07	MZR-L3	DOHC	4	1,3	ITR6F-13	4477			
616 GC Fgst 700001-->	2.0	74		FE		4	0,8	BPR6ES	7822	2	BPR6EIX	6637
626 GC Fgst 650001 -->	1.6	59		F6		4	0,8	BPR6ES	7822	2	BPR6EIX	6637
626 GC Fgst--> 650000	1.6	59		F6		4	0,8	BPR6ES	7822	2	BPR6EIX	6637
626	1.8	66	90 -	F8		4	1,1	BKR6E-11	2756	14	BKR6EIX-11	3764
626 GF Fgst 100001-->	1.8	66	07.97 -	FP DOHC		4	0,8	PZFR6F	7550			
626	1.8	66	- 89	F8		4	0,9	BPR5ES	7422	6	BPR5EIX	6597
626	1.8	66	90 -	F8	Cat.	4	1,1	BKR6E-11	2756	14	BKR6EIX-11	3764

<sup>1)</sup> Bic = Best in class

Fgst = Chassis No.



ℓ kW

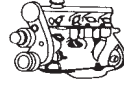

Cyl.

Order-  
No. No.Bic<sup>1)</sup> Order-  
D-Power No.**MAZDA**

626 GF...	1.9	66	07.97 -	FP	4	0,8	PZFR6F	7550				
626 GW Fgst 100001 -->	1.9	66		FP DOHC 16V	4	0,8	PZFR6F	7550				
626 GF Fgst.100001 -->	1.9	66		FP DOHC	4	0,8	PZFR6F	7550				
626 GE Fgst 434202 -->	1.9	66	09.94 -	FP DOHC	4	1,1	BKR6E-11	2756	14	BKR6EIX-11	3764	
626 GF Fgst 400001-->	1.9	74	00 -	FP DOHC	4	0,8	PZFR6F	7550				
626 GW Fgst 208843-->	1.9	74	00 -	FP DOHC	4	0,8	PZFR6F	7550				
626 GE Fgst 100001 -->	1.9	77	92 -	FP DOHC Cat.	4	1,1	BKR6E-11	2756	14	BKR6EIX-11	3764	
626 GD Fgst--> 500000	2.0	66		FE Cat.	4	0,8	BPR6ES	7822	2	BPR6EIX	6637	
626 GV Fgst 200001 -->	2.0	66		FE Cat.	4	0,8	BPR6ES	7822	2	BPR6EIX	6637	
626 GV Fgst--> 200000	2.0	66		FE Cat.	4	0,8	BPR6ES	7822	2	BPR6EIX	6637	
626 GD Fgst 500001-->	2.0	66		FE Cat.	4	0,8	BPR6ES	7822	2	BPR6EIX	6637	
626 GD Fgst--> 500000	2.0	66		FE Cat.	4	1,1	BPR6ES-11	4824	13	BPR6EIX-11	3903	
626 GC Fgst 700001-->	2.0	68		FE Cat.	4	0,8	BPR6ES	7822	2	BPR6EIX	6637	
626 DIDT GF Fgst 186527-->	2.0	74	09.98 -	RF	4	█	Y-529J	4664				
626 DIDT Kombi GF Fgst 116329-->	2.0	74	09.98 -	RF	4	█	Y-529J	4664				
626 GC Fgst--> 700000	2.0	74		FE	4	0,8	BPR6ES	7822	2	BPR6EIX	6637	
626 GD Fgst--> 500000	2.0	79		FE 12 Valve	4	0,8	BCPR6E	1269	12	BCPR6EIX	5689	
626 GF... Fgst 100001-->	2.0	85		FS DOHC	4	0,8	PZFR6F	7550				
626(USA)GE Fgst 803719-->	2.0	85		FS DOHC	4	1,1	BKR5E-11	6953	33	BKR5EIX-11	5464	
626 GE Fgst 4343202-->	2.0	85	94 -	FS DOHC Cat.	4	1,1	BKR6E-11	2756	14	BKR6EIX-11	3764	
626 GF Fgst 400001-->	2.0	85	00 -	FS DOHC	4	0,8	PZFR6F	7550				
626 GW Fgst 200001-->	2.0	85	00 -	FS DOHC	4	0,8	PZFR6F	7550				
626(USA)GE Fgst 802219-->	2.0	85	92 - 98	FS DOHC	4	1,1	BKR5E-11	6953	33	BKR5EIX-11	5464	
626 GW Fgst 100001 -->	2.0	85		FS DOHC 16V	4	0,8	PZFR6F	7550				
626 GC Fgst 700001-->	2.0	88		FE	4	0,8	BPR6ES	7822	2	BPR6EIX	6637	
626 GW Fgst 100001 -->	2.0	100		FS DOHC 16V	4	0,8	PZFR6F	7550				
626 GW Fgst 208843-->	2.0	100	00 -	FS DOHC High Power	4	0,8	PZFR6F	7550				
626 GF...	2.0	100	07.97 -	FS	4	0,8	PZFR6F	7550				
626 GF Fgst 400001-->	2.0	100	00 -	FS DOHC High Power	4	0,8	PZFR6F	7550				
626 GF Fgst.100001 -->	2.0	100		FS DOHC	4	0,8	PZFR6F	7550				
626 GD Fgst 500001-->	2.0	103		FE 16V Cat.	4	1,1	BKR6E-11	2756	14	BKR6EIX-11	3764	
626 GD Fgst--> 500000	2.0	103		FE 16V Cat.	4	1,1	BCPR6E-11	3132	11	BCPR6EIX-11	4919	
626 GD Fgst--> 500000	2.2	85		F2 12 Valve Cat.	4	1,1	ZFR6A-11	1041				
626 GD Fgst 500001-->	2.2	85		F2 12 Valve Cat.	4	1,1	ZFR6F-11	4291		ZFR6FIX-11	6441	
626 GV Fgst 200001-->	2.2	85		F2 12 Valve Cat.	4	1,1	ZFR6F-11	4291		ZFR6FIX-11	6441	
626 GV Fgst--> 200000	2.2	85		F2	4	1,1	ZFR6A-11	1041				
626 GE Fgst 434202 -->	2.5	120	09.94 -	KL DOHC V6	6	1,1	ZFR5F-11	2262		ZFR5FIX-11	2477	
626 GE Fgst 100001-->	2.5	121	92 - 94	KL DOHC V6 Cat.	6	1,1	ZFR6F-11	4291		ZFR6FIX-11	6441	
929	2.0			S 2	4	█	Y-107T	1253				
929 HV Fgst 800001-->	2.0	66		MA	4	0,8	BPR6ES	7822	2	BPR6EIX	6637	
929 HB Fgst 500001-->	2.0	74		FE	4	0,8	BPR6ES	7822	2	BPR6EIX	6637	
929 HC Fgst--> 200000	2.0	85		FE without Cat.	4	0,8	BPR6ES	7822	2	BPR6EIX	6637	
929 HB Fgst 500001-->	2.0	88		FE	4	0,8	BPR6ES	7822	2	BPR6EIX	6637	
929 HC Fgst--> 200000	2.2	85		F2 12Valve Cat.	4	1,1	ZFR6A-11	1041				
929 HC Fgst 200001-->	2.2	94		F2 12Valve Cat.	4	1,1	ZFR6F-11	4291		ZFR6FIX-11	6441	
929 HC Fgst--> 200000	2.2	100		F2 12Val. o.Cat.	4	0,8	BCPR6E	1269	12	BCPR6EIX	5689	
929	2.5		92 -	JS-DE	6	1,1	BKR5EVX-11	5182		BKR5EIX-11	5464	
929 HC Fgst 200001-->	3.0	123		JE Cat.	6	1,1	ZFR6F-11	4291		ZFR6FIX-11	6441	
929 HC Fgst--> 200000	3.0	125		JE Cat.	6	1,1	ZFR6A-11	1041				
929 HC Fgst--> 200000	3.0	140		JE ohne Cat.	6	0,8	BCPR6E	1269	12	BCPR6EIX	5689	
B 1600	1.6				4	0,9	BPR5ES	7422	6	BPR5EIX	6597	
B 1800	1.8				4	0,9	BPR5ES	7422	6	BPR5EIX	6597	

<sup>1)</sup> Bic = Best in class

Fgst = Chassis No.





ℓ kW

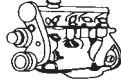

Cyl.

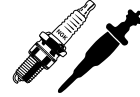
Order-  
No. No.Bic<sup>1)</sup> Order-  
D-Power No.**MAZDA**

B 2000	2.0				4	0,9	BPR5ES	7422	6	BPR5EIX	6597
B 2200	2.0		08.84 -	F 2	4	█	Y-107R	1229			
B 2200	2.2		- 89		4	0,9	BPR5ES	7422	6	BPR5EIX	6597
B 2200	2.2		90 -	F2 EGI	4	1,1	BPR5ES-11	4424		BPR5EIX-11	2115
B 2200	2.2			S 2	4	█	Y-107T	1253			
B 2200	2.2		90 -	F2	4	0,9	BPR5ES	7422	6	BPR5EIX	6597
B 2200	2.2		01.85 - 10.96	R 2	4	█	Y-107R	1229			
B 2500 UF Fgst 702487-->	2.5	57	99 -	WL		█	Y-701J	5116		D-POWER 39	1566
B 2600	2.6		- 89		6	0,9	BPR5ES	7422	6	BPR5EIX	6597
B 2600	2.6		90 -	G6	6	1,1	ZFR5F-11	2262		ZFR5FIX-11	2477
B Serie			97 - 11.02	WLT		█	Y-701J	5116		D-POWER 39	1566
Boxer 3700 / 5500			11.74 -	XC / ZC		█	Y-172	7325			
Demio DW Fgst 300001-->	1.4	46	00 - 03	B3 SOHC	4	1,1	BKR5E-11	6953	33	BKR5EIX-11	5464
Demio DW Fgst 100.001 -->	1.4	46	98 - 03	B3 SOHC	4	1,1	BKR6E-11	2756	14	BKR6EIX-11	3764
Demio DW Fgst 100.001 -->	1.4	53	98 - 03	B3 (High Power)	4	1,1	BKR6E-11	2756	14	BKR6EIX-11	3764
Demio DW Fgst 300001-->	1.5	55	05.00 - 03	B5 SOHC	4	1,1	BKR6E-11	2756	14	BKR6EIX-11	3764
E 2000	2.0		93 -	RF	4	█	Y-107R	1229			
E 2000 SR Fgst 600001-->	2.0	60		FE	4	0,9	BPR5ES	7422	6	BPR5EIX	6597
E 2000 SR Fgst--> 600000	2.0	63	84 - 95	FE	4	0,8	BPR6ES	7822	2	BPR6EIX	6637
E 2000 SR Fgst 800001-->	2.0	70		FE 8V	4	1,1	BKR5E-11	6953	33	BKR5EIX-11	5464
E 2000 SR Fgst 700001-->	2.0	70	95 -	FE	4	1,1	BKR6E-11	2756	14	BKR6EIX-11	3764
E 2000 SR Fgst X100001-->	2.0	70	99 -	FE	4	1,1	BKR5E-11	6953	33	BKR5EIX-11	5464
E 2200	2.2		02.83 - 92	F2	4	█	Y-107R	1229			
E 2200	2.2		93 - 96	R2	4	█	Y-107R	1229			
E 3000	3.0		93 -	L4DE		█	Y-721RS	3687			
E 3000	3.0		93 -	VS		█	Y-721RS	3687			
E Serie			97 -	R2		█	Y-721RS	3687			
Light Bus Parkway			10.80 -	HA 24V		█	Y-157R	2029			
Light Bus Parkway			10.80 -	HA 12V		█	Y-107R	1229			
MPV LW Fgst Y100001-->	2.0	90	06.99 - 04.02	FS DOHC	4	1,1	ZFR5F-11	2262		ZFR5FIX-11	2477
MPV	2.0	100	97 - 06.02	WLT	4	█	Y-701J	5116		D-POWER 39	1566
MPV LW Fgst 200001-->	2.3	104	05.02 -	MZR-L3 DOHC	4	1,3	ITR6F-13	4477			
MPV	2.5	0	06 -	L3-VDT	6	0,8	ILTR6A-8G				
MPV	2.5	0	02 -	AJ	6	1,1	TR5IX	7397		TR5IX	7397
MPV LV Fgst 100001-->	3.0	109	05.96 -	JE 12V	6	1,1	BKR6E-11	2756	14	BKR6EIX-11	3764
MPV LV 52 Fgst 631983-->	3.0	113	09.94 -	JEE	6	1,1	ZFR6F-11	4291		ZFR6FIX-11	6441
MX-3 EC	1.6	65	08.91 -	B6 SOHC Cat.	4	1,1	BKR5E-11	6953	33	BKR5EIX-11	5464
MX-3 EC Fgst 208015-->	1.6	79	94 -	B6 DOHC	4	1,1	BKR6E-11	2756	14	BKR6EIX-11	3764
MX-3 EC Fgst 208015-->	1.8	95	95 -	K8 DOHC	6	1,1	BKR5E-11	6953	33	BKR5EIX-11	5464
MX-3 EC	1.8	98	08.91 -	K8 DOHC Cat.	6	1,1	BKR5E-11	6953	33	BKR5EIX-11	5464
MX-5 NA Fgst 308212-->	1.6	66		B6 DOHC	4	1,1	BKR6E-11	2756	14	BKR6EIX-11	3764
MX-5 NA Fgst 200001-->	1.6	66	95 -	B6 DOHC	4	1,1	BKR6E-11	2756	14	BKR6EIX-11	3764
MX-5 NB Fgst 100001 -->	1.6	81	98 -	B6 DOHC	4	1,1	BKR5E-11	6953	33	BKR5EIX-11	5464
MX-5 NA Fgst 100001-->	1.6	85	90 -	B6 DOHC Cat.	4	1,1	BKR6E-11	2756	14	BKR6EIX-11	3764
MX-5	1.8	93	06 -		4	1,3	ITR5F-13	6044			
MX-5 NA Fgst 100000-->	1.9	96	94 -	BP DOHC Cat.	4	1,1	BKR6E-11	2756	14	BKR6EIX-11	3764
MX-5 NA Fgst 308212-->	1.9	96		BP DOHC	4	1,1	BKR6E-11	2756	14	BKR6EIX-11	3764
MX-5 NB Fgst 300001--> Automatic	1.9	102	01 -	BP DOHC	4	1,1	BKR5E-11	6953	33	BKR5EIX-11	5464
MX-5 NB Fgst 100001-->	1.9	103	98 -	BP DOHC	4	1,1	BKR5E-11	6953	33	BKR5EIX-11	5464
MX-5 NB Fgst 121912--> (Anniversary)	1.9	103	00 -	BP DOHC	4	1,1	BKR5E-11	6953	33	BKR5EIX-11	5464
MX-5 NB Fgst 200001-->	1.9	107	01 -	BP DOHC	4	1,1	BKR5E-11	6953	33	BKR5EIX-11	5464
MX-5	2.0	118	01.06 -	LF-VE	4	1,3	ILTR6A-13G	3789			

<sup>1)</sup> Bic = Best in class

Fgst = Chassis No.



l kW

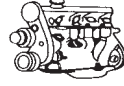

Cyl.

Order-  
No. No.Bic<sup>1)</sup> Order-  
D-Power No.**MAZDA**

MX-6 GE Fgst 400001-->	2.0	85	09.94-	FS DOHC	4	1,1	BKR5E-11	6953	33	BKR5EIX-11	5464
MX-6 GE Fgst 100001-->	2.0	85	92-	FS DOHC Cat.	4	1,1	BKR6E-11	2756	14	BKR6EIX-11	3764
MX-6	2.2		92-	F2	4	1,1	ZFR6F-11	4291		ZFR6FIX-11	6441
MX-6 GE Fgst 400001-->	2.5	120	09.94-	KL DOHC V6	6	1,1	ZFR5F-11	2262		ZFR5FIX-11	2477
MX-6 GE Fgst 100001-->	2.5	121	92-	KL DOHC V6 Cat.	6	1,1	ZFR5F-11	2262		ZFR5FIX-11	2477
Premacy CP Fgst 300001-->	1.9	74		FP DOHC	4	1,1	BKR5E-11	6953	33	BKR5EIX-11	5464
Premacy CP Fgst 151177-->	1.9	74	06.99-	FP DOHC	4	1,1	ZFR5F-11	2262		ZFR5FIX-11	2477
Premacy CP Fgst 151177-->	1.9	85	06.99-	FP DOHC with VICS	4	1,1	ZFR5F-11	2262		ZFR5FIX-11	2477
Premacy CP Fgst 300001-->	2.0	96		FS DOHC	4	1,1	BKR5E-11	6953	33	BKR5EIX-11	5464
Ranger				S 2		☑	Y-107T	1253			
RX-7 FB Fgst 700001-->		83		12 A		0,8	BR8ET	4221		BR8EIX	5044
RX-7 FC Fgst--> 200000		110		13 B		1,1	BR10ET	7480		BR10EIX	6801
RX-7 Turbo FC Fgst-->200000		133		RE 13 B		1,0	SD11A	1199			
RX-7 Turbo FC Fgst 200001-->		147	90-	RE 13 B		1,4	BUR9EQ	5483			
RX-7 Turbo FD Fgst-->100000		176		13B-REV		1,2	BUR9EQP	5255			
RX-8	2.6	141	09.03-	13B-MSP 2+2sparkplug			RE8C-L +	5745+			
							RE9B-T	2809			
RX-8 Sport	2.6	177	09.03-	13B-MSP (high power) 2+2sparkplug			RE8C-L +	5745+			
							RE9B-T	2809			
T 2500	2.5		10.80-	XA 12V		☑	Y-107R	1229			
T 2500	2.5		10.80-	XA 24V		☑	Y-157R	2029			
T 3000	3.0		10.80- 92	HA 12V		☑	Y-107R	1229			
T 3000	3.0		10.80- 92	HA 24V		☑	Y-157R	2029			
T 3000	3.0		93-	L4DE		☑	Y-771R	4262			
T 3000	3.0		93-	HA		☑	Y-771R	4262			
T 3700			04.76-	XC		☑	Y-172	7325			
T 4100	4.1		10.80-	ZB 12V		☑	Y-107R	1229			
T 4100	4.1		10.80-	ZB 24V		☑	Y-157R	2029			
T 5500			75-	ZC		☑	Y-172	7325			
T Serie			97-	VS		☑	Y-771R	4262			
Tribute	2.0		03-	Ford	4	1,3	PTR5A-13	2467	25		
Tribute EP Fgst M00001-->	2.0	91	04.00-	Zetec 16V	4	1,3	PTR5A-13	2467	25		
Tribute EP2 Fgst M00001-->	2.0	91	04.00-	Zetec 16V	4	1,3	PTR5A-13	2467	25		
Tribute	2.3	110	03-	MZR-L3 DOHC	4	1,3	ITR6F-13	4477			
Tribute V6 EP Fgst M00001-->	3.0	145	04.00-	Duratec 24V	6	1,1	TR5IX	7397			
Tribute V6 EP2 Fgst M00001-->	3.0	145	04.00-	Duratec 24V	6	1,1	TR5IX	7397			
Xedos 6 CA Fgst 210758-->	1.6	79	09.94-	B6 DOHC	4	1,1	BKR5E-11	6953	33	BKR5EIX-11	5464
Xedos 6 CA Fgst 210758-->	2.0	103	09.94-	KF DOHC V6	6	1,1	BKR6E-11	2756	14	BKR6EIX-11	3764
Xedos 6 CA Fgst 100001-->	2.0	106	06.92-		4	1,1	BKR6E-11	2756	14	BKR6EIX-11	3764
Xedos 9 TA Fgst 200001-->	2.0	105	10.93-	KF V6 DOHC	6	1,1	BKR6E-11	2756	14	BKR6EIX-11	3764
Xedos 9 TA Fgst 200001-->	2.3	155	02.95-	KJ V6 DOHC Miller Mot	6	0,8	PZFR5F	3741			
Xedos 9 TA V6	2.5	120	01-	KJD	6	1,1	BKR5E-11	6953	33	BKR5EIX-11	5464
Xedos 9 TA Fgst 400001-->	2.5	120		KL-V6 DOHC	6	1,1	ZFR5F-11	2262		ZFR5FIX-11	2477
Xedos 9 TA Fgst 200001-->	2.5	128	10.93-	KL-ZE V6	6	1,1	ZFR5F-11	2262		ZFR5FIX-11	2477

**MERCEDES**

190 (201)	2.0	63	10.82-05.90	M 102.921/924	4	0,8	BP6EFS	3812	5		
190 D (201)	2.0	53	02.89-05.93	OM 601.911	4	☑	Y-916R	2785		D-POWER 6	5906
190 D (201)	2.0	53	02.83-01.89	OM 601.911	4	☑	Y-902R	2237		D-POWER 1	7906
190 D (201)	2.5	66	02.89-05.93	OM 602.911	5	☑	Y-916R	2785		D-POWER 6	5906
190 D (201)	2.5	66	04.85-01.89	OM 602.911	5	☑	Y-902R	2237		D-POWER 1	7906
190 D (201)	2.5	90	02.89-05.93	OM 602.961	5	☑	Y-916R	2785		D-POWER 6	5906

<sup>1)</sup> Bic = Best in class

Fgst = Chassis No.



ℓ kW

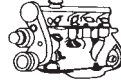

Cyl.

Order-  
No. No.Bic<sup>1)</sup> Order-  
D-Power No.**MERCEDES**

190 D (201)	2.5	90	02.88 - 01.89	OM 602.961	5	■	Y-902R	2237		D-POWER 1	7906
190 DT (201)	2.5	90	02.89 - 05.93	OM 602.961	5	■	Y-918R	4182		D-POWER 2	6285
190 E 1.8 (201)	1.8	80	05.90 - 05.93	M 102.910	4	0,8	BP6EFS	3812	5		
190 E (201)	2.0	87	09.85 - 08.93	M 102.962	4	0,8	BP6EFS	3812	5		
190 E (201)	2.3	97	09.86 - 05.93	M 102.985	4	0,8	BP6EFS	3812	5		
190 E 16V (201)	2.3	125	04.84 - 08.88	M 102.983	4	0,8	BP7EFVX	3344			
190 E 16V (201)	2.5	143	09.88 - 05.93	M 102.990	4	0,8	BP6EFS	3812	5		
190 E 16V Evo.1 (201)	2.5	143	03.89 - 04.90	M 102.991	4	0,8	BP6EFS	3812	5		
190 E 16V Evo.2 (201)	2.5	173	05.90 - 05.93	M 102.992	4	0,8	BP6EFS	3812	5		
190 E (201)	2.6	118	09.86 - 05.93	M 103.942	6	0,8	BP6EFS	3812	5		
200 (124)	2.0	77	12.84 - 05.90	M 102.922	4	0,8	BP6EFS	3812	5		
200 D,TD (124)	2.0	53	02.89 - 06.93	OM 601.912	4	■	Y-916R	2785		D-POWER 6	5906
200 D,TD (124)	2.0	53	12.84 - 01.89	OM 601.912	4	■	Y-902R	2237		D-POWER 1	7906
200 E (124)	2.0	87	12.88 - 09.92	M 102.963	4	0,8	BP6EFS	3812	5		
200 E (124)	2.0	100	10.92 - 06.93	M 111.940	4	0,7	BCP6ES	4930	17	BCPR6EIX	5689
207 D	2.4	53	09.82 - 09.88	OM 616.	4	■	Y-902R	2237		D-POWER 1	7906
208 D	2.3	58	10.88 - 03.95	OM 601...	4	■	Y-916R	2785		D-POWER 6	5906
209 D	3.0	65	04.82 - 09.88	OM 617....	4	■	Y-902R	2237		D-POWER 1	7906
210	2.3	70	08.82 - 08.91	M 102.942/945	4	0,8	BP6EFS	3812	5		
210	2.3	77	08.91 -	M 102. ...	4	0,8	BP6EFS	3812	5		
210 D	2.9	70	10.88 -	OM 602...	5	■	Y-916R	2785		D-POWER 6	5906
220 E (124)	2.2	110	10.92 - 06.93	M 111.960	4	0,7	BCP6ES	4930	17	BCPR6EIX	5689
230 E (124)	2.3	90	12.84 - 09.92	M 102.982	4	0,8	BP6EFS	3812	5		
230 G (461)	2.3	66	04.92 -	M 115.974	4	0,6	BP5EFS	3712			
230 G (461)	2.3	79	04.92 -	M 102.958	4	0,6	BP5EFS	3712			
230 GE (460)	2.3	90	05.87 - 08.92	M 102.987 Cat.	4	0,8	BP6EFS	3812	5		
230 GE (461)	2.3	90	02.93 -	M 102.979	4	0,8	BP6EFS	3812	5		
230 GE (461)	2.3	92	04.92 -	M 102.998	4	0,8	BP6EFS	3812	5		
230 GE (461)	2.3	92	04.92 -	M 102.981	4	0,8	BP6EFS	3812	5		
230 GE (461)	2.3	92	06.93 -	M 102.996	4	0,8	BP6EFS	3812	5		
230 GE (463)	2.3	93	09.89 - 07.93	M 102.989	4	0,8	BP6EFS	3812	5		
250 D,TD (124)	2.5	66	02.89 - 06.93	OM 602.912	5	■	Y-916R	2785		D-POWER 6	5906
250 D,TD (124)	2.5	66	04.85 - 01.89	OM 602.912	5	■	Y-902R	2237		D-POWER 1	7906
250 DT (124)	2.5	93	09.88 - 01.89	OM 602.962	5	■	Y-902R	2237		D-POWER 1	7906
250 DT (124)	2.5	93	02.89 - 06.93	OM 602.962	5	■	Y-916R	2785		D-POWER 6	5906
250 GD (460)	2.5	69	09.87 - 01.89	OM 602.930	5	■	Y-902R	2237		D-POWER 1	7906
250 GD (460)	2.5	69	02.89 - 12.92	OM 602.930	5	■	Y-916R	2785		D-POWER 6	5906
250 GD (463)	2.5	62	06.90 -	OM 602.931	5	■	Y-916R	2785		D-POWER 6	5906
260 E (124)	2.6	118	09.85 - 09.92	M 103.940/943	6	0,8	BP6EFS	3812	5		
260 SE (126)	2.6	118	09.85 - 06.91	M 103.941	6	0,8	BP6EFS	3812	5		
280 E (124)	2.8	142	- 06.95	M 104.942	6	0,7	BCP6ES	4930	17	BCPR6EIX	5689
280 GE (460)	2.8	115	11.79 - 08.89	M 110.994	6	0,7	BP6ES	7811	4	BPR6EIX	6637
280 GE (461)	2.8	110	04.92 -	M 110.994	6	0,7	BP6ES	7811	4	BPR6EIX	6637
290 GD (461)	2.9	70	04.92 -	OM 602.942	5	■	Y-916R	2785		D-POWER 6	5906
300 D (124)	3.0	80	12.84 - 01.89	OM 603.912	6	■	Y-902R	2237		D-POWER 1	7906
300 D (124)	3.0	80	02.89 - 06.93	OM 603.912	6	■	Y-916R	2785		D-POWER 6	5906
300 D 4-Mat. (124)	3.0	80	02.89 - 06.93	OM 603.913	6	■	Y-916R	2785		D-POWER 6	5906
300 D 4-Mat. (124)	3.0	80	09.86 - 01.89	OM 603.913	6	■	Y-902R	2237		D-POWER 1	7906
300 E (124)	3.0	132	09.85 - 09.92	M 103.983	6	0,8	BP6EFS	3812	5		
300 E 4-Matic (124)	3.0	132	09.86 - 06.93	M 103.985	6	0,8	BP6EFS	3812	5		
300 E-24V (124)	3.0	162	09.89 - 06.93	M 104.980	6	0,7	BCP6ES	4930	17	BCPR6EIX	5689
300 GD (460)	3.0	65	12.79 - 12.91	OM 617.931	5	■	Y-902R	2237		D-POWER 1	7906

<sup>1)</sup> Bic = Best in class



ℓ kW

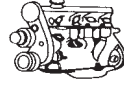

Cyl.

Order-  
No. No.Bic<sup>1)</sup> Order-  
D-Power No.**MERCEDES**

300 GD (460)	3.0	83	03.79 - 01.89	OM 603.912	6	█	Y-902R	2237		D-POWER 1	7906
300 GD (463)	3.0	83	02.89 - 06.93	OM 603.931	6	█	Y-916R	2785		D-POWER 6	5906
300 GE (463)	3.0	128	09.89 - 07.93	M 103.987	6	0,8	BP6EFS	3812	5		
300 SD (140)	3.0	110	02.92 - 04.93	OM 603.971	6	█	Y-916R	2785		D-POWER 6	5906
300 SE 2.8 (140)	2.8	142	02.93 - 10.98	M 104.944	6	0,7	BCP6ES	4930	17	BCPR6EIX	5689
300 SE/SEL (126)	3.0	132	09.85 - 06.91	M 103.981	6	0,8	BP6EFS	3812	5		
300 SE/SEL 3,2 (140)	3.2	170	03.91 - 06.93	M 104.990	6	0,7	BCP6ES	4930	17	BCPR6EIX	5689
300 SED (140)	3.0		02.91 -		6	█	Y-916R	2785		D-POWER 6	5906
300 SL (107)	3.0	132	09.85 - 08.89	M 103.982	6	0,8	BP6EFS	3812	5		
300 SL (129)	3.0	140	03.89 - 06.93	M 103.984	6	0,8	BP6EFS	3812	5		
300 SL-24V (129)	3.0	170	07.89 - 06.93	M 104.981	6	0,7	BCP6ES	4930	17	BCPR6EIX	5689
300 TD (124)	3.0	92	12.84 - 01.89	OM 603.960	6	█	Y-902R	2237		D-POWER 1	7906
300 TD (124)	3.0	92	02.89 - 06.93	OM 603.960	6	█	Y-916R	2785		D-POWER 6	5906
300 TD 4Mat. (124)	3.0	105	09.86 - 01.89	OM 603.963	6	█	Y-902R	2237		D-POWER 1	7906
300 TD 4Mat. (124)	3.0	105	02.89 - 06.93	OM 603.963	6	█	Y-916R	2785		D-POWER 6	5906
300 TD (124)	3.0	108	02.89 - 06.93	OM 603.960	6	█	Y-916R	2785		D-POWER 6	5906
300 TD (124)	3.0	108	01.88 - 01.89	OM 603.960	6	█	Y-902R	2237		D-POWER 1	7906
307 D	2.4	53	09.82 - 09.88	OM 616.	4	█	Y-902R	2237		D-POWER 1	7906
308 D	2.3	58	10.88 - 03.95	OM 601.	4	█	Y-916R	2785		D-POWER 6	5906
309	2.3	77	08.82 -	M 102. ...	4	0,8	BP6EFS	3812	5		
309 D	3.0	65	04.82 - 09.88	OM 617.	4	█	Y-902R	2237		D-POWER 1	7906
310	2.3	70	08.82 - 08.91	M 102.942/945	4	0,8	BP6EFS	3812	5		
310	2.3	77	08.91 -	M 102. ...	4	0,8	BP6EFS	3812	5		
310 D	2.9	70	10.88 -	OM 602.	5	█	Y-916R	2785		D-POWER 6	5906
320 E (124)	3.2	162	10.92 - 06.93	M 104.992	6	0,7	BCP6ES	4930	17	BCPR6EIX	5689
350 D (126)	3.5	115	02.89 - 06.91	OM 603.		█	Y-916R	2785		D-POWER 6	5906
350 D,TD (126)	3.5	100	03.90 - 06.91	OM 603.970	6	█	Y-916R	2785		D-POWER 6	5906
350 GD (463)	3.5	100	09.91 - 06.93	OM 603.972	6	█	Y-916R	2785		D-POWER 6	5906
400 E (124)	4.2	205	10.92 - 06.93	M 119.975	8	0,7	BCP6ES	4930	17	BCPR6EIX	5689
400 SE/SEL (140)	4.2	210	02.91 - 06.93	M 119.971	8	0,7	BCP6ES	4930	17	BCPR6EIX	5689
407 D	2.4	53	07.81 - 09.88	OM 616.	4	█	Y-902R	2237		D-POWER 1	7906
408 D	2.3	58	10.88 -	OM 601.	4	█	Y-916R	2785		D-POWER 6	5906
409 D	3.0	65	04.82 - 08.88	OM 617.	4	█	Y-902R	2237		D-POWER 1	7906
410	2.3	70	08.82 - 08.91	M 102.942/943/945	4	0,8	BP6EFS	3812	5		
410	2.3	77	08.91 -	M 102. ...	4	0,8	BP6EFS	3812	5		
410 D	2.9	70	10.88 -	OM 602.	5	█	Y-916R	2785		D-POWER 6	5906
420 (126)	4.2	150	09.85 - 06.91	M 116.965	8	0,7	BP6ES	7811	4	BPR6EIX	6637
420 SL (107)	4.2	150	01.86 - 08.89	M 116.964	8	0,7	BP6ES	7811	4	BPR6EIX	6637
500 (126)	5.0	170	12.79 - 06.91	M 117.961/63/65	8	0,7	BP6ES	7811	4	BPR6EIX	6637
500 E (124)	5.0	235	06.91 - 06.93	M 119.974	8	0,7	BCP6ES	4930	17	BCPR6EIX	5689
500 SE/SEL (140)	5.0	240	02.91 - 06.93	M 119.970	8	0,7	BCP6ES	4930	17	BCPR6EIX	5689
500 SEC (140)	5.0	240	10.92 - 06.93	M 119.970	8	0,7	BCP6ES	4930	17	BCPR6EIX	5689
500 SL (107)	5.0	164	03.80 - 08.89	M 117.964	8	0,7	BP6ES	7811	4	BPR6EIX	6637
500 SL (129)	5.0	235	09.92 - 06.93	M 119.972	8	0,7	BCP6ES	4930	17	BCPR6EIX	5689
500 SL (129)	5.0	240	03.89 - 06.93	M 119.960	8	0,7	BCP6ES	4930	17	BCPR6EIX	5689
507 D	2.4	53	04.82 - 09.88	OM 616.	4	█	Y-902R	2237		D-POWER 1	7906
508 D	2.3	58	03.89 -	OM 601.	4	█	Y-916R	2785		D-POWER 6	5906
510	2.3	70	08.82 - 08.91	M 102.946	4	0,8	BP6EFS	3812	5		
510	2.3	77	08.91 -	M 102. ...	4	0,8	BP6EFS	3812	5		
560 (126)	5.6	178	09.87 - 06.91	M 117.968	8	0,7	BP6ES	7811	4	BPR6EIX	6637
600 SE/SEL (140)	6.0	290	04.91 - 06.93	M 120.980	12	0,7	BCP6ES	4930	17	BCPR6EIX	5689
600 SEC (140)	6.0	290	10.92 - 06.93	M 120.980	12	0,7	BCP6ES	4930	17	BCPR6EIX	5689

<sup>1)</sup> Bic = Best in class



ℓ kW

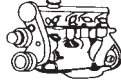

Cyl.

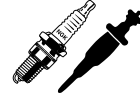
Order-  
No. No.Bic<sup>1)</sup> Order-  
D-Power No.**MERCEDES**

600 SL (129)	6.0	290	07.92 - 06.93	M 120.981	12	0,7	BCP6ES	4930	17	BCPR6EIX	5689
A 140 (168)	1.4	60	10.97 -	M 166.940	4	0,9	BKUR5ET	2789	29	PFR6Q	6458
A 140 (168)	1.6	60	01.01 -	M 166.960	4	0,9	BKUR5ET	2789	29	PFR6Q	6458
A 150 (169)	1.5	70	09.04 -	M 266.920	4	0,9	BKR6EZB	4293			
A 160 (168)	1.6	75	10.97 -	M 166.960	4	0,9	BKUR5ET	2789	29	PFR6Q	6458
A 160 CDI (168)	1.7	44	10.97 - 02.01	OM 668.941	4	█	Y-746R	4842		D-POWER 38	3078
A 160 CDI (168)	1.7	55	02.01 -	OM 668.940	4	█	Y-746R	4842		D-POWER 38	3078
A 170 CDI (168)	1.7	66	08.98 - 02.01	OM 668.940	4	█	Y-746R	4842		D-POWER 38	3078
A 170 CDI (168)	1.7	70	02.01 -	OM 668.942	4	█	Y-746R	4842		D-POWER 38	3078
A 170 (169)	1.7	85	09.04 -	M 266.940	4	0,9	BKR6EZB	4293			
A 190 (168)	1.9	92	03.99 -	M 166.990	4	0,9	BKUR5ET	2789	29	PFR6Q	6458
A 200 (169)	2.0	100	09.04 -	M 266.960	4	0,9	BKR6EZB	4293			
A 210 Evolution (168)	2.0	103	03.02 -	M 166.995	4	0,9	BKUR5ET	2789	29	PFR6Q	6458
B 150 (245)	1.5	70	04.05 -	M 266.920	4	0,9	BKR6EZB	4293			
B 170 (245)	1.7	85	04.05 -	M 266.940	4	0,9	BKR6EZB	4293			
B 200 (245)	2.0	100	04.05 -	M 266.960	4	0,9	BKR6EZB	4293			
C 160 Kompressor (203)	1.8	90	05.02 - 11.06	M 271.921 -> 30853899	4	0,8	ILFR6A	3588			
C 180 D (202)	1.8	65	10.98 - 05.00	OM 604.	4	█	△ Y-925R	5045		D-POWER 16	6848
C 180 (202)	1.8	90	07.97 -	M 111.921	4	0,9	BKUR5ET	2789	29	PFR6Q	6458
C 180 (202)	1.8	90	06.93 - 06.97	M 111.920	4	0,7	BCP6ES	4930	17	BCPR6EIX	5689
C 180 (202)	1.8	95	09.00 - 03.01	M 111.952	4	1,0	IFR6D10	5344			
C 180 Kompressor (203)	1.8	105	12.03 - 11.06	M 271.946 -> 30853899	4	0,8	ILFR6A	3588			
C 180 (203)	2.0	95	05.00 - 05.02	M 111.951	4	1,0	IFR6D10	5344			
C 200 D (202)	2.0	55	07.93 - 05.00	OM 601.913	4	█	Y-916R	2785		D-POWER 6	5906
C 200 D (202)	2.0	65	10.96 - 05.00	OM 604.915	4	█	△ Y-925R	5045		D-POWER 16	6848
C 200 (202)	2.0	100	03.94 - 06.97	M 111.941	4	0,7	BCP6ES	4930	17	BCPR6EIX	5689
C 200 (202)	2.0	100	07.97 -	M 111.945	4	0,9	BKUR5ET	2789	29	PFR6Q	6458
C 200 (202)	2.0	120	09.00 - 03.01	M 111.956	4	1,0	IFR6D10	5344			
C 200 Kompressor (202)	2.0	132	09.95 - 10.96	M 111.944	4	0,8	BKR6ES	3783	28	BKR6EIX	6418
C 200 Kompressor (202)	2.0	141	11.96 -	M 111.944	4	1,0	BKUR6ET-10	2397	24	PFR6Q	6458
C 200 CDI (202)	2.2	75	03.98 - 05.00	OM 611.960	4	█	Y-745U	4705		D-POWER 11	6346
C 200 Kompressor (203)	1.8	105	02.03 - 11.06	M 271.942 -> 30853899	4	0,8	ILFR6A	3588			
C 200 Kompressor (203)	1.8	120	02.03 - 11.06	M 271.940 -> 30853899	4	0,8	ILFR6A	3588			
C 200 CGI Kompressor (203)	1.8	125	02.03 - 11.06	M 271.942 -> 30853899	4	0,8	ILFR6A	3588			
C 200 Kompressor (203)	2.0	120	05.00 -	M 111.955	4	1,0	IFR6D10	5344			
C 200 CDI (203)	2.2	85	05.00 -	OM 611.962	4	█	Y-745U	4705		D-POWER 11	6346
C 200 CDI (203)	2.2	90	04.03 -	OM 646.962	4	█	Y-745U	4705		D-POWER 11	6346
C 220 D (202)	2.2	70	06.95 - 05.00	OM 604.910	4	█	△ Y-925R	5045		D-POWER 16	6848
C 220 D (202)	2.2	70	07.93 - 05.95	OM 604.910	4	█	◆ Y-930U	5568			
C 220 CDI (202)	2.2	75	06.98 -	OM 611.961	4	█	Y-745U	4705		D-POWER 11	6346
C 220 CDI (202)	2.2	92	09.97 - 05.00	OM 611.960	4	█	Y-745U	4705		D-POWER 11	6346
C 220 (202)	2.2	110	06.93 - 09.96	M 111.961	4	0,7	BCP6ES	4930	17	BCPR6EIX	5689
C 220 CDI (203)	2.2	105	05.00 -	OM 611.962	4	█	Y-745U	4705		D-POWER 11	6346
C 220 CDI (203)	2.2	110	05.02 -	OM 646.963	4	█	Y-745U	4705		D-POWER 11	6346
C 230 (202)	2.3	110	09.96 - 05.97	M 111.974	4	0,7	BCP6ES	4930	17	BCPR6EIX	5689
C 230 Kompressor (202)	2.3	142	10.95 -	M 111.975	4	1,0	BKUR6ET-10	2397	24	PFR6Q	6458
C 230 Kompressor (203)	1.8	141	02.04 - 11.06	M 271.948 -> 30853899	4	0,8	ILFR6A	3588			
C 230 Kompressor (203)	2.3	145	03.01 - 05.02	M 111.981	4	1,0	IFR6D10	5344			
C 230 (203)	2.5	150	12.04 -	M 272.920	6	0,8	PLKR7A	4288			
C 230 (204)	2.5	150	01.07 -	M 272.911	6	0,8	PLKR7A	4288			
C 230 (204)	2.5	150	08.07 -	M 272.921	6	0,8	PLKR7A	4288			
C 240 V6 (202)	2.4	125	04.97 -	M 112.910 Twin Spark	6	1,0	PFR5R-11	4292		IFR5D10	4696

<sup>1)</sup> Bic = Best in class



ℓ kW

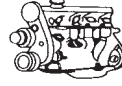

Cyl.

Order-  
No. No.Bic<sup>1)</sup> Order-  
D-Power No.**MERCEDES**

C 240 4-Matic (203)	2.6	125	07.02-	M 112.916 Twin Spark	6	1,0	PFR5R-11	4292		IFR5D10	4696
C 240 (203)	2.6	125	05.00-	M 112.912 Twin Spark	6	1,0	PFR5R-11	4292		IFR5D10	4696
C 250 D (202)	2.5	83	02.95-08.95	OM 605.910	5	█	△ Y-925R	5045		D-POWER 16	6848
C 250 D (202)	2.5	83	07.93-01.95	OM 605.910	5	█	◆ Y-930U	5568			
C 250 Td (202)	2.5	110	05.96-05.00	OM 605.960	5	█	△ Y-925R	5045		D-POWER 16	6848
C 270 CDI (203)	2.7	125	12.00-	OM 612.962	5	█	Y-745U	4705		D-POWER 11	6346
C 280 (202)	2.8	141	06.93-05.97	M 104.941	6	0,7	BCP6ES	4930	17	BCPR6EIX	5689
C 280 V6 (202)	2.8	145	06.97-	M 112.920 Twin Spark	6	1,0	PFR5R-11	4292		IFR5D10	4696
C 280 (203)	3.0	170	11.04-	M 272.940	6	0,8	PLKR7A	4288			
C 280 4-Matic (203)	3.0	170	02.05-	M 272.941	6	0,8	PLKR7A	4288			
C 280 4-Matic (204)	3.0	170	05.07-	M 272.948	6	0,8	PLKR7A	4288			
C 280 (204)	3.0	170	05.07-	M 272.947	6	0,8	PLKR7A	4288			
C 32 AMG Kompressor (203)	3.2	260	00-	M 112.961 Twin Spark	6	1,0	IFR6D10	5344			
C 320 4-Matic (203)	3.2	160	07.02-	M 112.953 Twin Spark	6	1,0	PFR5R-11	4292		IFR5D10	4696
C 320 (203)	3.2	160	05.00-	M 112.946 Twin Spark	6	1,0	PFR5R-11	4292		IFR5D10	4696
C 350 4-Matic (203)	3.5	200	12.04-	M 272.970	6	0,8	PLKR7A	4288			
C 350 (203)	3.5	200	12.04-	M 272.960	6	0,8	PLKR7A	4288			
C 350 4-Matic (204)	3.5	200	05.07-	M 272.971	6	0,8	PLKR7A	4288			
C 350 (204)	3.5	200	05.07-	M 272.961	6	0,8	PLKR7A	4288			
C 36 AMG (202)	3.6	206	01.94-05.97	M 104.941	6	0,8	BKR5EKU	3964			
C 43 AMG (202)	4.3	225	09.97-	M 113.944 Twin Spark	8	1,0	PFR5R-11	4292		IFR5D10	4696
C 55 AMG (203)	5.4	270	02.04-	M 113.988 Twin Spark	8	1,0	IFR6D10	5344			
CL 420 (140)	4.2	205	07.97-10.98	M 119.981	8	1,0	PFR5R-11	4292		IFR5D10	4696
CL 420 (140)	4.2	205	06.96-06.97	M 119.981	8	0,7	BCP6ES	4930	17	BCPR6EIX	5689
CL 500 (140)	5.0	235	09.96-06.97	M 119.980	8	1,0	PFR5R-11	4292		IFR5D10	4696
CL 500 (140)	5.0	235	07.97-10.98	M 119.980	8	1,0	PFR5R-11	4292		IFR5D10	4696
CL 500 (215)	5.0	225	09.00-	M 113.960 Twin Spark	8	1,0	PFR5R-11	4292		IFR5D10	4696
CL 500 (216)	5.5	286	10.06-	M 273.961	8	0,8	PLKR7A	4288			
CL 55 AMG (215)	5.5	265	10.99-	M 113.986 Twin Spark	8	1,0	PFR5R-11	4292		IFR5D10	4696
CL 55 AMG Kompressor (215)	5.5	386	00-	M 113.991 Twin Spark	8	0,8	ILFR6A	3588			
CL 600 (140)	6.0	290	06.96-05.97	M 120.982	12	0,7	BCP6ES	4930	17	BCPR6EIX	5689
CL 600 (140)	6.0	290	06.97-10.98	M 120.982	12	1,0	PFR5R-11	4292		IFR5D10	4696
CL 600 (215)	6.0	270	03.99-	M 137.970 Twin Spark	12	0,8	IFR6Q-G	5648			
CL 600 (215)	6.0	368	02-	M 275.950 Twin Spark	12	0,8	IFR6Q-G	5648			
CL 600 (216)	6.0	381	09.06-	M 275.953 Twin Spark	12	0,8	IFR6Q-G	5648			
CL 63 AMG (216)	6.3	378	09.06-	M 156.984	8	1,0	ILZKAR7A10				
CL 65 AMG (215)	6.0	450	09.03-	M 275.980 Twin Spark	12	0,8	IFR6Q-G	5648			
CLK 200 (208)	2.0	100	06.97- 02	M 111.945	4	0,9	BKUR5ET	2789	29	PFR6Q	6458
CLK 200 Kompressor (208)	2.0	120	06.00-06.02	M 111.956	4	1,0	IFR6D10	5344			
CLK 200 Kompressor (208)	2.0	135	07.97- 02	M 111.944	4	1,0	BKUR6ET-10	2397	24	PFR6Q	6458
CLK 200 Kompressor (209)	1.8	120	09.02-11.06	M 271.940 -> 30853899	4	0,8	ILFR6A	3588			
CLK 200 CGI (209)	1.8	125	02.03-11.06	M 271.942 -> 30853899	4	0,8	ILFR6A	3588			
CLK 220 CDI (209)	2.2	110	01.05-	OM 646.966	4	█	Y-745U	4705		D-POWER 11	6346
CLK 220 CDI (209)	2.2	110	01.05-	OM 646.963	4	█	Y-745U	4705		D-POWER 11	6346
CLK 230 Kompressor (208)	2.3	142	06.97-02.00	M 111.973	4	1,0	BKUR6ET-10	2397	24	PFR6Q	6458
CLK 230 Kompressor (208)	2.3	145	03.00-06.02	M 111.982	4	1,0	IFR6D10	5344			
CLK 240 (209)	2.6	125	02.03-	M 112.912 Twin Spark	6	1,0	PFR5R-11	4292		IFR5D10	4696
CLK 270 CDI (209)	2.7	125	10.02-	OM 612.967	5	█	Y-745U	4705		D-POWER 11	6346
CLK 270 CDI (209)	2.7	125	10.02-	OM 612.962	5	█	Y-745U	4705		D-POWER 11	6346
CLK 280 (209)	3.0	170	01.05-	M 272.940	6	0,8	PLKR7A	4288			
CLK 320 V6 (208)	3.2	160	06.97- 02	M 112.940 Twin Spark	6	1,0	PFR5R-11	4292		IFR5D10	4696
CLK 320 (209)	3.2	160	03.03-	M 112.955 Twin Spark	6	1,0	PFR5R-11	4292		IFR5D10	4696

<sup>1)</sup> Bic = Best in class

△ ◆ siehe Seite 22 / see page 22



ℓ kW

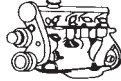

Cyl.

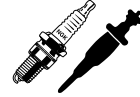
Order-  
No. No.Bic<sup>1)</sup> Order-  
D-Power No.**MERCEDES**

CLK 350 (209)	3.5	200	01.05 -	M 272.960	6	0,8	PLKR7A	4288			
CLK 430 (208)	4.3	205	06.98 - 02	M 113.943 Twin Spark	8	1,0	PFR5R-11	4292		IFR5D10	4696
CLK 500 (209)	5.0	225	06.02 -	M 113.968 Twin Spark	8	1,0	PFR5R-11	4292		IFR5D10	4696
CLK 500 (209)	5.5	286	06 -	M 273.967	8	0,8	PLKR7A	4288			
CLK 55 (208)	5.5	255	08.99 - 03	M 113.980 Twin Spark	8	1,0	PFR5R-11	4292		IFR5D10	4696
CLK 55 AMG (209)	5.4	270	09.02 -	M 113.987 Twin Spark	8	1,0	IFR6D10	5344			
CLK 63 AMG (209)	6.3	378	06 -	M 156.982	8	1,0	ILZKAR7A10				
CLS 350 (219)	3.5	200	10.04 -	M 272.964	6	0,8	PLKR7A	4288			
CLS 350 CGI (219)	3.5	215	04.06 -	M 272.985	6	0,7	SILZKR7A-S				
CLS 500 (219)	5.0	225	04 -	M 113.967 Twin Spark	8	1,0	PFR5R-11	4292		IFR5D10	4696
CLS 500 (219)	5.5	286	04.06 -	M 273.960	8	0,8	PLKR7A	4288			
CLS 55 AMG (219)	5.5	350	01.05 -	M 113.990 Twin Spark	8	0,8	ILFR6A	3588			
CLS 63 AMG (219)	6.3	378	05.06 -	M 156.983	8	1,0	ILZKAR7A10				
E 200 (124)	2.0		07.93 - 06.95	M 111.921	4	0,7	BCP6ES	4930	17	BCPR6EIX	5689
E 200 D (124)	2.0	53	07.93 - 05.95	OM 601.912	4	█	Y-916R	2785		D-POWER 6	5906
E 200 (124)	2.0	100	06.93 - 06.97	M 111.942	4	0,7	BCP6ES	4930	17	BCPR6EIX	5689
E 200 D (210)	2.0	65	01.96 - 03.02	OM 604.917	4	█	△ Y-925R	5045		D-POWER 16	6848
E 200 (210)	2.0	100	07.97 -	M 111.942	4	0,9	BKUR5ET	2789	29	PFR6Q	6458
E 200 (210)	2.0	100	06.95 - 06.97	M 111.942	4	0,8	BCP5ES	7496	16	BCPR5EIX	5688
E 200 Kompressor (210)	2.0	120	06.00 - 03.02	M 111.957	4	1,0	IFR6D10	5344			
E 200 Kompressor (210)	2.0	137	09.96 -	M 111.947	4	1,0	BKUR6ET-10	2397	24	PFR6Q	6458
E 200 CDI (210)	2.2	75	06.98 - 06.99	OM 611.961	4	█	Y-745U	4705		D-POWER 11	6346
E 200 CDI (210)	2.2	85	07.99 -	OM 611.961	4	█	Y-745U	4705		D-POWER 11	6346
E 200 Kompressor (211)	1.8	120	11.02 - 11.06	M 271.941 -> 30853899	4	0,8	ILFR6A	3588			
E 200 Kompressor (211)	1.8	135	04.06 - 11.06	M 271.956 -> 30853899	4	0,8	ILFR6A	3588			
E 200 CDI (211)	2.0	90	07.02 -	OM 646.951	4	█	Y-745U	4705		D-POWER 11	6346
E 220 (124)	2.2	110	06.93 - 06.95	M 111.960	4	0,7	BCP6ES	4930	17	BCPR6EIX	5689
E 220 D (210)	2.2	55	05.96 -	OM 611.913	4	█	△Y-925R	5045		D-POWER 16	6848
E 220 D (210)	2.2	70	03.95 -	OM 604.912	4	█	△Y-925R	5045		D-POWER 16	6848
E 220 CDI (210)	2.2	92	06.98 - 06.99	OM 611.961	4	█	Y-745U	4705		D-POWER 11	6346
E 220 D (210)	2.2	105	07.99 -	OM 611.962	4	█	Y-745U	4705		D-POWER 11	6346
E 220 CDI (210)	2.2	105	07.99 -	OM 611.961	4	█	Y-745U	4705		D-POWER 11	6346
E 220 CDI (211)	2.2	110	03.03 -	OM 646.961	4	█	Y-745U	4705		D-POWER 11	6346
E 230 (210)	2.3	110	06.95 - 06.97	M 111.970	4	0,8	BCP5ES	7496	16	BCPR5EIX	5688
E 240 V6 (210)	2.4	125	04.97 - 06.99	M 112.911 Twin Spark	6	1,0	PFR5R-11	4292		IFR5D10	4696
E 240 (210)	2.6	125	06.00 -	M 112.914 Twin Spark	6	1,0	PFR5R-11	4292		IFR5D10	4696
E 240 4-Matic (211)	2.6	130	03.03 -	M 112.917 Twin Spark	6	1,0	PFR5R-11	4292		IFR5D10	4696
E 240 (211)	2.6	130	03.02 -	M 112.913 Twin Spark	6	1,0	PFR5R-11	4292		IFR5D10	4696
E 250 D (124)	2.5	66	07.93 -	OM 602.912/962	5	█	Y-916R	2785		D-POWER 6	5906
E 250 T,TD (124)	2.5	66	07.93 -	OM 602.962	5	█	Y-916R	2785		D-POWER 6	5906
E 250 D (124)	2.5	83	07.93 - 05.95	OM 605.911	5	█	◆Y-930U	5568			
E 250 D (124)	2.5	83	07.93 - 04.96	OM 605.911/912	5	█	△Y-925R	5045		D-POWER 16	6848
E 250 TD (124)	2.5	93	07.93 - 05.95	OM 602.962	5	█	△Y-925R	5045		D-POWER 16	6848
E 250 D (210)	2.5	83	03.95 -	OM 605.912	5	█	△Y-925R	5045		D-POWER 16	6848
E 250 TD (210)	2.5	110	06.97 - 07.99	OM 605.962	5	█	△Y-925R	5045		D-POWER 16	6848
E 270 CDI (210)	2.7	105	07.99 -	OM 612.961	5	█	Y-745U	4705		D-POWER 11	6346
E 270 CDI (211)	2.7	130	03.03 -	OM 647.961	5	█	Y-745U	4705		D-POWER 11	6346
E 280 (124)	2.8	142	06.93 - 06.95	M 104.945	6	0,7	BCP6ES	4930	17	BCPR6EIX	5689
E 280 (124)	2.8	142	07.93 - 02.97	M 104.942	6	0,7	BCP6ES	4930	17	BCPR6EIX	5689
E 280 (210)	2.8	142	01.96 - 06.99	M 104.945	6	0,8	BCP5ES	7496	16	BCPR5EIX	5688
E 280 V6 (210)	2.8	150	03.97 -	M 112.921 Twin Spark	6	1,0	PFR5R-11	4292		IFR5D10	4696
E 280 (211)	3.0	170	01.06 -	M 272.943	6	0,8	PLKR7A	4288			

<sup>1)</sup> Bic = Best in class

△ ◆ siehe Seite 22 / see page 22



ℓ kW

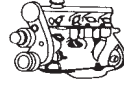

Cyl.

Order-  
No. No.Bic<sup>1)</sup> Order-  
D-Power No.**MERCEDES**

E 280 4-Matic (211)	3.0	170	01.06 -	M 272.944	6	0,8	PLKR7A	4288				
E 280 CDI (211)	3.2	130	05.04 -	OM 648.961	6	▣	Y-745U	4705			D-POWER 11	6346
E 290 TD (210)	2.9	95	06.95 -	OM 602.982	5	▣	Y-929U	6003			D-POWER 41	1749
E 300 TD (124)	3.0	100	06.95 -06.96	OM 606.910	6	▣	△Y-925R	5045			D-POWER 16	6848
E 300 D (124)	3.0	100	07.93 -05.95	OM 606.910	6	▣	Y-930U	5568			D-POWER 30	4275
E 300 TD (124)	3.0	100	07.93 -05.95	OM 606.910	6	▣	◆Y-930U	5568				
E 300 TD (124)	3.0	108	07.93 -	OM 603.960	6	▣	Y-916R	2785			D-POWER 6	5906
E 300 4-Matic (124)	3.0	132	09.86 -06.93	M 103.985	6	0,8	BP6EFS	3812	5			
E 300 24V (124)	3.0	162	06.93 -06.97	M 104.980	6	0,7	BCP6ES	4930	17		BCPR6EIX	5689
E 300 D (210)	3.0	100	03.95 -	OM 606.912	6	▣	△Y-925R	5045			D-POWER 16	6848
E 300 Td T (210)	3.0	130	03.97 -	OM 606.962	6	▣	◆Y-930U	5568				
E 300 Td T (210)	3.0	130	03.97 -	OM 606.962	6	▣	△Y-925R	5045			D-POWER 16	6848
E 320 (124)	3.2	162	06.93 -06.95	M 104.992	6	0,7	BCP6ES	4930	17		BCPR6EIX	5689
E 320 CDI (210)	3.2	145	07.99 -	OM 613.961	6	▣	Y-745U	4705			D-POWER 11	6346
E 320 V6 (210)	3.2	165	06.99 -	M 112.941 Twin Spark	6	1,0	PFR5R-11	4292			IFR5D10	4696
E 320 (210)	3.2	170	06.95 -05.99	M 104.995	6	0,8	BCP5ES	7496	16		BCPR5EIX	5688
E 320 CDI (211)	3.2	150	03.03 -	OM 648.961	6	▣	Y-745U	4705			D-POWER 11	6346
E 320 4-Matic (211)	3.2	165	03.03 -	M 112.954 Twin Spark	6	1,0	PFR5R-11	4292			IFR5D10	4696
E 320 (211)	3.2	165	03.02 -	M 112.949 Twin Spark	6	1,0	PFR5R-11	4292			IFR5D10	4696
E 350 4-Matic (211)	3.5	200	11.04 -	M 272.972	6	0,8	PLKR7A	4288				
E 350 (211)	3.5	200	10.04 -	M 272.964	6	0,8	PLKR7A	4288				
E 400 CDI (211)	4.0	191	02.03 -	OM 628.961	8	▣	Y-745U	4705			D-POWER 11	6346
E 420 (124)	4.2	205	06.93 -06.95	M 119.975	8	0,7	BCP6ES	4930	17		BCPR6EIX	5689
E 420 V8 (210)	4.2	205	07.97 -	M 119.985	8	0,9	BKUR5ET	2789	29		PFR6Q	6458
E 420 V8 (210)	4.2	205	01.96 -06.97	M 119.985	8	0,7	BCP6ES	4930	17		BCPR6EIX	5689
E 430 V8 (210)	4.3	205	04.97 -03.03	M 113.940 Twin Spark	8	1,0	PFR5R-11	4292			IFR5D10	4696
E 50 (210)	5.0	255	02.96 -	M 119.E50	8	0,8	BKR5EKU	3964				
E 50 AMG ( USA ) (210)	5.0	235	02.96 -05.99	M 119.980	8	0,7	BCP6ES	4930	17		BCPR6EIX	5689
E 500 (124)	5.0	235	06.93 -06.95	M 119.974	8	0,7	BCP6ES	4930	17		BCPR6EIX	5689
E 500 4-Matic (211)	5.0	225	03.03 -	M 113.969 Twin Spark	8	1,0	PFR5R-11	4292			IFR5D10	4696
E 500 (211)	5.0	225	03.02 -	M 113.967 Twin Spark	8	1,0	PFR5R-11	4292			IFR5D10	4696
E 500 (211)	5.5	285	04.06 -	M 273.960	8	0,8	PLKR7A	4288				
E 500 (211)	5.5	300	04.06 -	M 273.962	8	0,8	PLKR7A	4288				
E 55 (210)	5.5	260	09.97 -	M 113.980 Twin Spark	8	1,0	PFR5R-11	4292			IFR5D10	4696
E 55 AMG (210)	5.5	260	05.97 -	M 113.980 Twin Spark	8	1,0	PFR5R-11	4292			IFR5D10	4696
E 55 AMG (211)	5.5	350	10.02 -	M 113.990 Twin Spark	8	0,8	ILFR6A	3588				
E 63 AMG (211)	6.3	378	05.06 -	M 156.983	8	1,0	ILZKAR7A10					
G 200 (463)	2.0	80	09.93 -	M 102.965	4	0,8	BP6EFS	3812	5			
G 230 (463)	2.3	93	08.93 -10.94	M 102.989	4	0,8	BP6EFS	3812	5			
G 270 CDI (461)	2.7			OM 612.963	5	▣	Y-745U	4705			D-POWER 11	6346
G 270 CDI (461)	2.7			OM 612.966	5	▣	Y-745U	4705			D-POWER 11	6346
G 270 CDI (461)	2.7	115		OM 612.965	5	▣	Y-745U	4705			D-POWER 11	6346
G 270 CDI (463)	2.7	115	10.01 -	OM 612.965	5	▣	Y-745U	4705			D-POWER 11	6346
290 GDT (461)	2.9	72	08.93 -10.94	OM 602.942/947	6	▣	Y-916R	2785			D-POWER 6	5906
290 GDT (461)	2.9	90	07.97 -	OM 602.983	5	▣	Y-929U	6003			D-POWER 41	1749
G 300 D (463)	3.0	83	08.93 -	OM 603.931	6	▣	Y-916R	2785			D-POWER 6	5906
G 300 (463)	3.0	126	08.93 -10.94	M 103.987	6	0,8	BP6EFS	3812	5			
G 300 TD (463)	3.0	130	08.96 -	OM 606.964	6	▣	△Y-925R	5045			D-POWER 16	6848
G 320 CDI (463)	3.0			OM 642.970	6	▣	CZ302					
G 320 (463)	3.2	155	09.93 -12.97	M 104.996	6	0,8	BCP5ES	7496	16		BCPR5EIX	5688
G 320 (463)	3.2	158	07.97 -	M 112.945 Twin Spark	6	1,0	PFR5R-11	4292			IFR5D10	4696
G 400 CDI (463)	4.0	184	12.00 -	OM 628.962	8	▣	Y-745U	4705			D-POWER 11	6346

<sup>1)</sup> Bic = Best in class

△ ◆ siehe Seite 22 / see page 22





ℓ kW

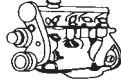

Cyl.

Order-  
No. No.Bic<sup>1)</sup> Order-  
D-Power No.**MERCEDES**

G 500 (463)	5.0	195	08.93 - 10.94	M 117.965	8	0,7	BP6ES	7811	4	BPR6EIX	6637
G 500 (463)	5.0	218	00 -	M 113.962 Twin Spark	8	1,0	PFR5R-11	4292		IFR5D10	4696
G 55 AMG (463)	5.5	260	04.99 -	M 113.982 Twin Spark	8	1,0	PFR5R-11	4292		IFR5D10	4696
G 55 AMG (463)	5.5	350	06.04 -	M 113.993 Twin Spark	8	0,8	ILFR6A	3588			
GL 320 CDI (x 164)	3.0	165	01.06 -	OM 642.940	6	█	CZ302				
GL 450 (x 164)	4.6	250	01.06 -	M 273.923	8	0,8	PLKR7A	4288			
GL 500 (x 164)	5.5	286	01.06 -	M 273.963	8	0,8	PLKR7A	4288			
L 410	2.3	70	08.82 -	M 102.943	4	0,8	BP6EFS	3812	5		
LM 409	2.3	60	01.75 -	M 115. ...	4	0,7	BP6ES	7811	4	BPR6EIX	6637
MB 100	2.4	43	02.89 -	OM 615.970	4	█	Y-902R	2237		D-POWER 1	7906
MB 100 D	2.4	56	09.87 - 01.89	OM 616.963	4	█	Y-902R	2237		D-POWER 1	7906
MB 100 D	2.4	56	02.89 -	OM 616.963	4	█	Y-916R	2785		D-POWER 6	5906
ML 230 (163)	2.3	110	11.98 -	M 111.977	4	0,9	BKUR5ET	2789	29	PFR6Q	6458
ML 270 CDI (163)	2.7	120	12.99 -	OM 612.963	5	█	Y-745U	4705		D-POWER 11	6346
ML 280 CDI (164)	3.0	140	10.05 -	OM 642.940	6	█	CZ302				
ML 320 (163)	3.2	160	11.98 -	M 112.942 Twin Spark	6	1,0	PFR5R-11	4292		IFR5D10	4696
ML 320 CDI (164)	3.0	165	07.05 -	OM 642.940	6	█	CZ302				
ML 350 (163)	3.7	173	09.00 -	M 112.970 Twin Spark	6	1,0	PFR5R-11	4292		IFR5D10	4696
ML 350 (164)	3.5	200	12.04 -	M 272.967	6	0,8	PLKR7A	4288			
ML 400 CDI (163)	4.0	184	09.00 -	OM 628.963	8	█	Y-745U	4705		D-POWER 11	6346
ML 430 (163)	4.3	200	11.98 -	M 113.942 Twin Spark	8	1,0	PFR5R-11	4292		IFR5D10	4696
ML 500 (163)	5.0	215	09.00 -	M 113.965 Twin Spark	8	1,0	PFR5R-11	4292		IFR5D10	4696
ML 500 (164)	5.0	225	12.04 -	M 113.964 Twin Spark	8	1,0	PFR5R-11	4292		IFR5D10	4696
ML 55 AMG (163)	5.5	255	11.99 -	M 113.981 Twin Spark	8	1,0	PFR5R-11	4292		IFR5D10	4696
ML 63 AMG (164)	6.3	375	06 -	M 156.980	8	1,0	ILZKAR7A10				
R 280 (251)	3.0		02.06 -	M 272.945	6	0,8	PLKR7A	4288			
R 280 CDI (251)	3.0	140	02.06 -	OM 642.950	6	█	CZ302				
R 320 CDI (251)	3.0	165	02.06 -	OM 642.950	6	█	CZ302				
R 350 (251)	3.5	200	02.06 -	M 272.967	6	0,8	PLKR7A	4288			
R 500 (251)	5.0	225	02.06 -	M 113.971 Twin Spark	8	1,0	PFR5R-11	4292		IFR5D10	4696
R 63 AMG (251)	6.3	375	11.05 -	M 156.980	8	1,0	ILZKAR7A10				
S 280 (140)	2.8	142	07.93 - 06.97	M 104.944	6	0,7	BCP6ES	4930	17	BCPR6EIX	5689
S 280 (220)	2.8	142	10.99 - 08.05	M 112.922 Twin Spark	6	1,0	PFR5R-11	4292		IFR5D10	4696
S 280 (221)	3.0		05 -	M 272.946 M 112.972	6	0,8	PLKR7A	4288			
S 300 (140)	3.0	130	05.96 - 10.98	OM 606.961	6	█	◆Y-930U	5568			
S 300 (140)	3.0	130	05.96 - 10.98	OM 606.961	6	█	△Y-925R	5045		D-POWER 16	6848
S 320 (140)	3.2	170	07.93 - 06.97	M 119.944	6	0,7	BCP6ES	4930	17	BCPR6EIX	5689
S 320 CDI (220)	3.2	145	08.99 - 09.02	OM 613.960	6	█	Y-745U	4705		D-POWER 11	6346
S 320 CDI (220)	3.2	150	09.02 - 08.05	OM 648.960	6	█	Y-745U	4705		D-POWER 11	6346
S 320 (220)	3.2	165	10.98 - 08.05	M 112.944 Twin Spark	6	1,0	PFR5R-11	4292		IFR5D10	4696
S 350 TD (140)	3.5	110	93 -		6	█	Y-916R	2785		D-POWER 6	5906
S 350 4-Matic (220)	3.7	180	06.03 - 08.05	M 112.975 Twin Spark							
				M 112.972	6	1,0	PFR5R-11	4292		IFR5D10	4696
S 350 (220)	3.7	180	09.02 - 08.05	M 112.972 Twin Spark							
				M 112.972	6	1,0	PFR5R-11	4292		IFR5D10	4696
S 350 (221)	3.5	200	07.05 -	M 272.965 M 112.972	6	0,8	PLKR7A	4288			
S 400 CDI (220)	4.0	184	00 - 08.05	OM 628.960	8	█	Y-745U	4705		D-POWER 11	6346
S 420 (140)	4.2	205	06.93 - 06.97	M 119.981	8	0,7	BCP6ES	4930	17	BCPR6EIX	5689
S 420 (140)	4.2	205	07.93 - 06.97	M 119.971	8	0,7	BCP6ES	4930	17	BCPR6EIX	5689
S 430 4-Matic (220)	4.3	205	09.02 - 08.05	M 113.948 Twin Spark	8	1,0	PFR5R-11	4292		IFR5D10	4696
S 430 (220)	4.3	205	10.98 - 08.05	M 113.941 Twin Spark	8	1,0	PFR5R-11	4292		IFR5D10	4696

<sup>1)</sup> Bic = Best in class



ℓ kW

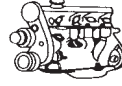

Cyl.

Order-  
No. No.Bic<sup>1)</sup> Order-  
D-Power No.**MERCEDES**

S 450 4-Matic (221)	4.6	250	12.05-	M 273.924 M 112.972	8	0,8	PLKR7A	4288				
S 450 (221)	4.6	250	07.05-	M 273.922	8	0,8	PLKR7A	4288				
S 500 (140)	5.0	235	07.93-06.97	M 119.970	8	0,7	BGP6ES	4930	17	BCPR6EIX	5689	
S 500 (220)	5.0	225	10.98-08.05	M 113.960 Twin Spark	8	1,0	PFR5R-11	4292		IFR5D10	4696	
S 500 4-Matic (220)	5.0	225	09.02-08.05	M 113.966 Twin Spark	8	1,0	PFR5R-11	4292		IFR5D10	4696	
S 500 4-Matic (221)	5.5	285	10.05-	M 273.968 M 112.972	8	0,8	PLKR7A	4288				
S 500 (221)	5.5	285	07.05-	M 273.961	8	0,8	PLKR7A	4288				
S 55 (220)	5.5	265	99-08.05	M 113.980 Twin Spark	8	1,0	PFR5R-11	4292		IFR5D10	4696	
S 55 AMG (220)	5.5	265	04.99-08.05	M 113.986 Twin Spark	8	1,0	PFR5R-11	4292		IFR5D10	4696	
S 55 AMG Kompressor (220)	5.5	368	02-08.05	M 113.991 Twin Spark	8	0,8	ILFR6A	3588				
S 600 (140)	6.0	290	07.93-06.97	M 120.980	12	0,7	BGP6ES	4930	17	BCPR6EIX	5689	
S 600 (140)	6.0	290	06.93-06.97	M 120.982	12	0,7	BGP6ES	4930	17	BCPR6EIX	5689	
S 600 (220)	6.0	270	01.00-08.05	M 137.970 Twin Spark	12	0,8	IFR6Q-G	5648				
S 600 (220)	6.0	368	01-08.05	M 275.950 Twin Spark	12	0,8	IFR6Q-G	5648				
S 600 (221)	6.0	380	03.06-	M 275.953 Twin Spark	12	0,8	IFR6Q-G	5648				
S 63 AMG (221)	6.3	386	10.06-	M 156.984	8	1,0	ILZKAR7A10					
S 65 AMG (220)	6.0	450	03-08.05	M 275.980 Twin Spark	12	0,8	IFR6Q-G	5648				
S 65 AMG (221)	6.0	450	12.05-	M 275.982 Twin Spark	12	0,8	IFR6Q-G	5648				
SL 280 (129)	2.8	141	07.93-06.97	M 104.943	6	0,7	BGP6ES	4930	17	BCPR6EIX	5689	
SL 280 (129)	2.8	142	07.97-05.98	M 104.943	6	0,9	BKUR5ET	2789	29	PFR6Q	6458	
SL 280 (129)	2.8	150	06.98-	M 112.923 Twin Spark	6	1,0	PFR5R-11	4292		IFR5D10	4696	
SL 320 (129)	3.2	165	06.98-	M 112.943 Twin Spark	6	1,0	PFR5R-11	4292		IFR5D10	4696	
SL 320 (129)	3.2	170	07.93-06.97	M 104.991	6	0,7	BGP6ES	4930	17	BCPR6EIX	5689	
SL 320 (129)	3.2	170	07.97-05.98	M 104.991	6	0,9	BKUR5ET	2789	29	PFR6Q	6458	
SL 350 (230)	3.7	180	03.03-	M 112.973 Twin Spark	6	1,0	PFR5R-11	4292		IFR5D10	4696	
SL 500 (129)	5.0	225	98-	M 113.961 Twin Spark	8	1,0	PFR5R-11	4292		IFR5D10	4696	
SL 500 (129)	5.0	235	07.93-06.97	M 119.972	8	0,7	BGP6ES	4930	17	BCPR6EIX	5689	
SL 500 (129)	5.0	235	07.93-06.97	M 119.982	8	0,7	BGP6ES	4930	17	BCPR6EIX	5689	
SL 500 (230)	5.0	225	10.01-	M 113.963 Twin Spark	8	1,0	PFR5R-11	4292		IFR5D10	4696	
SL 500K (230)	5.0	225	01-	M 113.963 Twin Spark	8	1,0	PFR5R-11	4292		IFR5D10	4696	
SL 55 AMG (230)	5.5			M 113.995 Twin Spark	8	0,8	ILFR6A	3588				
SL 55 AMG (230)	5.5	350	10.01-06.02	M 113.992 Twin Spark	8	0,8	ILFR6A	3588				
SL 55 AMG (230)	5.5	368	06.02-	M 113.992 Twin Spark	8	0,8	ILFR6A	3588				
SL 60 (129)	6.0	280	95-	M 119.E60	12	0,8	BKR5EKU	3964				
SL 60 AMG (129)	6.0	280	95-	M 119.E60	12	0,8	BKR5EKU	3964				
SL 600 (129)	6.0	290	98-	M 120.983	12	1,0	PFR5R-11	4292		IFR5D10	4696	
SL 600 (129)	6.0	290	07.93-06.97	M 120.983	12	0,8	BGP5ES	7496	16	BCPR5EIX	5688	
SL 600 (129)	6.0	290	07.93-06.97	M 120.981	12	0,7	BGP6ES	4930	17	BCPR6EIX	5689	
SL 600 (230)	5.5	368	01-	M 275.951 Twin Spark	12	0,8	IFR6Q-G	5648				
SL 65 AMG (230)	6.0	450	04-	M 275.981 Twin Spark	12	0,8	IFR6Q-G	5648				
SL 73 AMG (129)	7.3	386	99-	M 120.E73	12	1,0	PFR5R-11	4292		IFR5D10	4696	
SLK 200 (170)	2.0	100	09.96-	M 111.946	4	0,9	BKUR5ET	2789	29	PFR6Q	6458	
SLK 200 Kompressor (171)	1.8	120	04.04-11.06	M 271.944 -> 30853899	4	0,8	ILFR6A	3588				
SLK 200 Kompressor (170)	2.0	120	03.00-	M 111.958	4	1,0	IFR6D10	5344				
SLK 200 Kompressor (170)	2.0	141	09.96-02.00	M 111.943	4	1,0	BKUR6ET-10	2397	24	PFR6Q	6458	
SLK 230 Kompressor (170)	2.3	142	09.96-02.00	M 111.973	4	1,0	BKUR6ET-10	2397	24	PFR6Q	6458	
SLK 230 Kompressor (170)	2.3	145	03.00-	M 111.983	4	1,0	IFR6D10	5344				
SLK 280 Kompressor (171)	3.0	170	01.05-	M 272.942	6	0,8	PLKR7A	4288				
SLK 32 AMG (170)	3.2	260	01-	M 112.960 Twin Spark	6	1,0	IFR6D10	5344				
SLK 32 AMG Kompressor (170)	3.2	260	11.00-	M 112.960 Twin Spark	6	1,0	IFR6D10	5344				
SLK 320 (170)	3.2	160	03.00-	M 112.947 Twin Spark	6	1,0	PFR5R-11	4292		IFR5D10	4696	
SLK 350 (171)	3.5	200	06.04-	M 272.963	6	0,8	PLKR7A	4288				

<sup>1)</sup> Bic = Best in class



ℓ kW

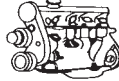

Cyl.

Order-  
No. No.Bic<sup>1)</sup> Order-  
D-Power No.**MERCEDES**

SLK 55 AMG (171)	5.5	265	04.04 -	M 113.989	Twin Spark	8	1,0	IFR6D10	5344			
SLR Mc Laren (199)	5.4	460	04.04 -	M 155.980	Twin Spark	8	0,8	ILFR6A	3588			
Sprinter 208 CDI	2.1	60	04.00 -					Y-745U	4705		D-POWER 11	6346
Sprinter 208 D	2.3	58	04.95 -	OM 601....		4		Y-916R	2785		D-POWER 6	5906
Sprinter 211 CDI	2.1	80	04.00 -					Y-745U	4705		D-POWER 11	6346
Sprinter 212 D	2.9	90	04.95 -	OM 602.980.12 DELA ->136		5		Y-923U	3380		D-POWER 1	7906
Sprinter 212 D	2.9	90	04.95 -	OM 602.980.12 DELA 137 ->		5		Y-929U	6003		D-POWER 41	1749
Sprinter 212 D	2.9	90	04.95 -	OM 602.980.10 DELA 9850->		5		Y-929U	6003		D-POWER 41	1749
Sprinter 212 D	2.9	90	04.95 -	OM 602.980.10 DELA ->9849		5		Y-923U	3380		D-POWER 1	7906
Sprinter 213 CDI	2.1	95	04.00 -					Y-745U	4705		D-POWER 11	6346
Sprinter 214	2.3	105	04.95 -	M 111.979		4	0,9	BKUR5ET	2789	29	PFR6Q	6458
Sprinter 216 CDI	2.7	115	04.00 -					Y-745U	4705		D-POWER 11	6346
Sprinter 308 CDI	2.1	60	04.00 -					Y-745U	4705		D-POWER 11	6346
Sprinter 308 D	2.3	58	04.95 -	00 OM 601.....		4		Y-916R	2785		D-POWER 6	5906
Sprinter 311 CDI	2.1	80	04.00 -	OM 611.981		4		Y-745U	4705		D-POWER 11	6346
Sprinter 312 D	2.9	90	04.95 -	OM 602.980.12 DELA ->136		5		Y-923U	3380		D-POWER 1	7906
Sprinter 312 D	2.9	90	04.95 -	OM 602.980.12 DELA 137 ->		5		Y-929U	6003		D-POWER 41	1749
Sprinter 312 D	2.9	90	04.95 -	OM 602.980.10 DELA ->9849		5		Y-923U	3380		D-POWER 1	7906
Sprinter 312 D	2.9	90	04.95 -	OM 602.980.10 DELA9850->		5		Y-929U	6003		D-POWER 41	1749
Sprinter 313 CDI	2.1	95	04.00 -					Y-745U	4705		D-POWER 11	6346
Sprinter 314	2.3	105	04.95 -	M 111.979		4	0,9	BKUR5ET	2789	29	PFR6Q	6458
Sprinter 316 CDI	2.7	115	04.00 -					Y-745U	4705		D-POWER 11	6346
Sprinter 412 D	2.9	90	04.95 -	OM 602.980.12 DELA 137 ->		5		Y-929U	6003		D-POWER 41	1749
Sprinter 412 D	2.9	90	04.95 -	OM 602.980.10 DELA ->9849		5		Y-923U	3380		D-POWER 1	7906
Sprinter 412 D	2.9	90	04.95 -	OM 602.980.12 DELA ->136		5		Y-923U	3380		D-POWER 1	7906
Sprinter 412 D	2.9	90	04.95 -	OM 602.980.10 DELA 9850 ->		5		Y-929U	6003		D-POWER 41	1749
Unimog 100 L	2.9	71	11.92 -	OM 602.948		5		Y-916R	2785		D-POWER 6	5906
Unimog 600/650	2.4	38	01.88 -	OM 616.		4		Y-902R	2237		D-POWER 1	7906
Unimog U 90	3.0	65	11.92 -	OM 602.941		5		Y-916R	2785		D-POWER 6	5906
V 220 CDI	2.2	90	03.99 -	OM 611.980		4		Y-745U	4705		D-POWER 11	6346
V 230 TD	2.3	72	09.96 -	OM 601.970		4		Y-916R	2785		D-POWER 6	5906
V 230	2.3	105	09.96 -	M 111.978		4	0,8	BKR6EK	2288	20	BKR6EQUIP	3199
V 280 VR6	2.8	125	98 -	M 104.900(AFS)		6	0,8	BKR5EKUP	2890			
Vaneo (414)	1.6	60	01.02 -	M 166.961		4	0,9	BKUR5ET	2789	29	PFR6Q	6458
Vaneo (414)	1.6	75	01.02 -	M 166.961		4	0,9	BKUR5ET	2789	29	PFR6Q	6458
Vaneo CDI (414)	1.7	55	01.02 -	OM 668.914		4		Y-745U	4705		D-POWER 11	6346
Vaneo CDI (414)	1.7	67	01.02 -	OM 668.914		4		Y-745U	4705		D-POWER 11	6346
Vaneo (414)	1.9	92	01.02 -	M 166.991		4	0,9	BKUR5ET	2789	29	PFR6Q	6458
Viano 2.0I CDI (639)	2.2	80	07.03 -	OM 646.982		4		Y-745U	4705		D-POWER 11	6346
Viano 2.2I CDI (639)	2.2	110	09.03 -	OM 646.983		4		Y-745U	4705		D-POWER 11	6346
Viano 3.0I (639)	3.2	140	09.03 -	M 112.951	Twin Spark	6	1,0	PFR5R-11	4292		IFR5D10	4696
Viano 3.2I (639)	3.2	160	09.03 -	M 112	Twin Spark	6	1,0	PFR5R-11	4292		IFR5D10	4696
Viano 3.5I (639)	3.7	170	01.05 -	M 112.976	Twin Spark	6	1,1	PFR5R-11	4292		IFR5D10	4696
Vito 108 D	2.3	60	02.96 -	OM 601.942		4		Y-916R	2785		D-POWER 6	5906
Vito 110 D	2.3	72	02.96 -	OM 601.970		4		Y-916R	2785		D-POWER 6	5906
Vito 113	2.0	95	03.96 -	M 111.948/950		4	1,0	BKUR5ET-10	7553			
Vito 114	2.3	105	03.96 -	M 111.978		4	1,0	BKUR5ET-10	7553			

**MG**

Express 1.4	1.4		02.03 -	K Series		4	1,1	PFR6N-11	3546			
Express 1.8	1.8		02.03 -	K Series		4	1,1	PFR6N-11	3546			
Express 2.0	2.0		02.03 -	K Series		4		Y-730U	2273		D-POWER 17	6704

<sup>1)</sup> Bic = Best in class



l kW

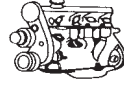

Cyl.

Order-  
No. No.Bic<sup>1)</sup> Order-  
D-Power No.**MG**

MGF 1.6	1.6	81	02.00-	K Series	4	1,1	PFR6N-11	3546				
MGF Roadster	1.8	88	11.95-	NPI	4	1,1	PFR6N-11	3546				
MGF Roadster	1.8	106	11.95-	VV10	4	1,1	PFR6N-11	3546				
MGF Trophy 160 SE	1.8	116	02.95-	K Series WC	4	1,0	PFR6N-11	3546				
MGTF 1.6	1.6	85	03.02-	K Series	4	1,0	PFR6N-11	3546				
MGTF 1.8	1.8	88	03.02-	K Series	4	1,0	PRF6N-11	3546				
MGTF 1.8	1.8	99	03.02-	K Series	4	1,0	PFR6N-11	3546				
MGTF 1.8	1.8	118	03.02-	K Series	4	1,0	PFR6N-11	3546				
RV 8	3.9	140	10.92-10.95	Rover V8 Efi	8	0,8	BPR6ES	7822	2	BPR6EIX	6637	
ZR 105	1.4	74	06.01-	K	4	1,1	PFR6N-11	3546				
ZR 105	1.4	74	06.01-	K	4	1,1	PFR6N-11	3546				
ZR 120	1.8	85	06.01-	K	4	1,1	PFR6N-11	3546				
ZR 120	1.8	85	06.01-	K	4	1,1	PFR6N-11	3546				
ZR 160	1.8	116	06.01-	K VVC	4	1,1	PFR6N-11	3546				
ZR TD	2.0		06.01-		4		Y-730U	2273		D-POWER 17	6704	
ZR TD	2.0		12.02-		4		Y-730U	2273		D-POWER 17	6704	
ZS 110	1.6		07.03-	K Series	4	1,1	PFR6N-11	3546				
ZS 120	1.8	85	06.01-	K	4	1,1	PFR6N-11	3546				
ZS 120	1.8	88	06.01-	K	4	1,1	PFR6N-11	3546				
ZS TD	2.0		12.02-		4		Y-730U	2273		D-POWER 17	6704	
ZS TD	2.0		08.02-		4		Y-730U	2273		D-POWER 17	6704	
ZS 180	2.5	132	06.01-	KV6	6	1,1	PFR6N-11	3546				
ZT 160 Turbo	1.8		10.02-	K Series	4	1,1	PFR6N-11	3546				
ZT 120	1.8		07.03-	K Series	4	1,1	PFR6N-11	3546				
ZT-T 160 Turbo	1.8		10.02-	K series	4	1,1	PFR6N-11	3546				
ZT-T CDTi	2.0		10.02-	M47R (BMW)	4		Y-507R	4600		D-POWER 32	2691	
ZT CDTi	2.0		10.02-	M47R (BMW)	4		Y-507R	4600		D-POWER 32	2691	
ZT-T CDTi	2.0		07.02-	M47R (BMW)	4		Y-507R	4600		D-POWER 32	2691	
ZT CDTi	2.0		07.02-	M47R (BMW)	4		Y-507R	4600		D-POWER 32	2691	
ZT 160	2.5	116	06.01-	KV6	6	1,1	PFR6N-11	3546				
ZT 160	2.5	116	06.01-	KV6	6	1,1	PFR6N-11	3546				
ZT-T 160	2.5	116	06.01-	KV6	6	1,1	PFR6N-11	3546				
ZT-T 160	2.5	116	06.01-	KV6	6	1,1	PFR6N-11	3546				
ZT-T 190	2.5	138	06.01-	KV6	6	1,1	PFR6N-11	3546				
ZT 190	2.5	138	06.01-	KV6	6	1,1	PFR6N-11	3546				
ZT 190	2.5	138	06.01-	KV6	6	1,1	PFR6N-11	3546				

**MINI**

Mini One	1.4	55	09.02-12.04	W10 B14	4		BKR6EQU	3199	30			
Mini One	1.6	66	04.01-	W10 B16	4		BKR6EQU	3199	30			
Mini Cooper	1.6	85	04.01-	W10 B16	4		BKR6EQU	3199	30			
Mini Cooper S 16V	1.6	125	12.01-	W11 B16	4		BKR6EQU	3199	30			
Mini Cooper S 16V JCW	1.6	147	09.04-	W11 B16	4		BKR7EQU	4285				
Mini D	1.6	80	03.07-	W16 D16	4		YE05	5207				
Mini Cooper	1.6	88	09.06-	N12 B16	4	0,8	PLZKBR7A-G					
Mini Cooper S	1.6	128	09.06-	N14 B16	4	0,8	PLZKBR7A-G					

**MITSUBISHI**

1300 Mini Bus / Van				4D56	4		Y-115T1	2189				
1300 Mini Bus / Van				4D56S-QGS Type	4		---*					
2000 GTX	2.0		94-	4G63	4	1,1	BKR5E-11	6953	33	BKR5EIX-11	5464	

<sup>1)</sup> Bic = Best in class

\* only by car dealer



ℓ kW

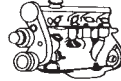

Cyl.

Order-  
No. No.Bic<sup>1)</sup> Order-  
D-Power No.**MITSUBISHI**

3000 GT	3.0		95 -	6G72 MPI TC	6	1,1	PFR6J-11	2743			
3000 GT	3.0		97 -	6G7	6	1,1	PFR6J-11	2743			
3000 GT	3.0	210	09.92 -	6G72/T DOHC	6	1,1	PFR6J-11	2743			
Airtrek	2.0		06.02 -	4G63	4	0,7	PGR6A	4984			
Airtrek	2.0	93	02 -	4G63 MPI	4	1,1	BKR6E-11	2756	14	BKR6EIX-11	3764
Airtrek	2.4		01.03 -	4G64	4	1,1	BKR5E-11	6953	33	BKR5EIX-11	5464
Canter				4D56	4	█	Y-115T1	2189			
Canter			78 -	4D30	4	█	Y-274	2165			
Canter				4DR51	4	█	Y-251	2026			
Carisma	1.6		97 -	4G92 SOHC	4	1,1	BKR6E-11	2756	14	BKR6EIX-11	3764
Carisma 1600 DAO	1.6	66	07.95 -	4G92	4	1,1	BKR6E-11	2756	14	BKR6EIX-11	3764
Carisma	1.8		97 -	4G93 SOHC	4	1,1	BKR6E-11	2756	14	BKR6EIX-11	3764
Carisma 1800 DAO	1.8	85	09.95 -	4G93	4	1,1	BKR6E-11	2756	14	BKR6EIX-11	3764
Carisma Elegance GDI	1.8	92	99 -	4G93 GDI	4	0,6	IZFR6B	3116			
Carisma GDI	1.8	92	09.97 -	4G93 GDI	4	0,8	IZFR6B	3116			
Carisma 1800 DAO	1.8	103	09.95 -	4G93	4	1,1	BKR6E-11	2756	14	BKR6EIX-11	3764
Carisma	1.9	59		F9QT	4	█	Y-515J	1019		D-POWER 18	6892
Carisma TD	1.9	66	10.96 -	F8Q	4	█	Y-932R	4956		D-POWER 25	7947
Carisma 1.9 DI-D(DA..)	1.9	75	09.00 -		4	█	Y-515J	1019		D-POWER 18	6892
Carisma 1.9 DI-D(DA..)	1.9	85	09.00 -		4	█	Y-515J	1019		D-POWER 18	6892
Challenger	2.5		11.98 -		4	█	Y-733J	8944		D-POWER 13	6592
Champ 1300	1.3		94 -	4G13	4	0,8	BP5ES	6511	8	BPR5EIX	6597
Champ 1500	1.5		94 -	4G15	4	1,1	BPR5ES-11	4424		BPR5EIX-11	2115
Colt 1600 Turbo (2)	1.6		01.86 - 88		4	0,8	BPR6ES	7822	2	BPR6EIX	6637
Colt 1600 (2)	1.6				4	0,8	BPR6ES	7822	2	BPR6EIX	6637
Colt 1200 C10 (3)	1.2	40	85 - 88	4G16	4	0,8	BPR6ES	7822	2	BPR6EIX	6637
Colt 1300 (3)	1.3		89 - 92	4G13	4	1,1	BPR6ES-11	4824	13	BPR6EIX-11	3903
Colt 1500 (3)	1.5		-12.93	4G15	4	0,8	BPR6ES	7822	2	BPR6EIX	6637
Colt 1500 (3)	1.5		91 -	4G15 Cat.	4	1,1	BPR6ES-11	4824	13	BPR6EIX-11	3903
Colt 1800 (3)	1.8			4G67 Cat.	4	0,8	BPR7ES	2023	19	BPR7EIX	4055
Colt 1300 (4)	1.3		95 -	4G13	4	1,1	BPR5ES-11	4424		BPR5EIX-11	2115
Colt 1300 (4)	1.3		92 -	4G13 / MPI	4	1,1	BPR5ES-11	4424		BPR5EIX-11	2115
Colt 1300 (4)	1.3	55	93 - 94	4G13 / MPI Cat.	4	1,1	BPR6ES-11	4824	13	BPR6EIX-11	3903
Colt 1500 (4)	1.5	69	94 -	4G15	4	0,8	BP5ES	6511	8	BPR5EIX	6597
Colt 1600 (4)	1.6		95 - 96	4G92 MPI MVV	4	1,1	BKR6E-11	2756	14	BKR6EIX-11	3764
Colt 1600 (4)	1.6		92 - 93	4G92	4	1,1	BKR6E-11	2756	14	BKR6EIX-11	3764
Colt 1600 16V (4)	1.6	83	12.91 -	4G92	4	0,8	BPR6ES	7822	2	BPR6EIX	6637
Colt 1600 (4)	1.6	83	94 - 95	4G92 MPI	4	1,1	BKR6E-11	2756	14	BKR6EIX-11	3764
Colt 1800 GTI 16V (4)	1.8	103	94 -	4G93 MPI	4	1,1	BKR6E-11	2756	14	BKR6EIX-11	3764
Colt 1300 (5)	1.3		97 -	4G13	4	1,1	BPR5ES-11	4424		BPR5EIX-11	2115
Colt 1300 (5)	1.3	55	03.96 -	4G13	4	1,1	BPR5ES-11	4424		BPR5EIX-11	2115
Colt 1300 (5)	1.3	60	09.00 -		4	1,1	BKR6E-11	2756	14	BKR6EIX-11	3764
Colt 1600 (5)	1.6		97 -	4G9(not MVV Magermix)	4	1,1	BKR6E-11	2756	14	BKR6EIX-11	3764
Colt 1600 (5)	1.6		97 -	4G9 MVV	4	1,1	BKR6E-11	2756	14	BKR6EIX-11	3764
Colt 1600 (5)	1.6	66	03.96 -	4G92	4	1,1	BKR6E-11	2756	14	BKR6EIX-11	3764
Colt (5)	1.6	66	03.96 -	4G92	4	1,1	BKR6E-11	2756	14	BKR6EIX-11	3764
Colt CZ (6)	1.1	55	04.05 -	3A91 12V	3	1,1	LFR6C-11	5788			
Colt CZ (6)	1.3	70	04.05 -	4A90 16V	4	1,1	LFR6C-11	5788			
Colt CZC (6)	1.5	80	04.05 -	16V	4	0,8	ILZFR6C-K	6645			
Colt CZ (6)	1.5	80	04.05 -	16V	4	0,8	ILZFR6C-K	6645			
Colt CZC (6)	1.5	110	03.05 -	4G15 Turbo DOHC	4	0,8	ILZFR6C-K	6645			
Colt CZT (6)	1.5	110	03.05 -	4G15 Turbo DOHC	4	0,8	ILZFR6C-K	6645			

<sup>1)</sup> Bic = Best in class



l kW

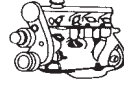

Cyl.

Order-  
No. No.Bic<sup>1)</sup> Order-  
D-Power No.**MITSUBISHI**

Cordia	1.6		82-	4G32	4	0,9	BPR5ES	7422	6	BPR5EIX	6597
Cordia Turbo	1.8	100	85- 88	4G62 / G62B Turbo	4	0,8	BR7ES	5122			
Debonair 3000			89- 90	6G72	4	1,1	PGR6A-11	3738			
Debonair 3000			91-	6G72	4	0,8	BP5ES	6511	8	BPR5EIX	6597
Debonair 3000			- 88	6G72	4	0,8	BP5ES	6511	8	BPR5EIX	6597
Diamante (F31A, F41A) 2500 GDI	2.5		09.99-09.01	6G73		0,8	IZFR5C	7748			
Diamante 3000	3.0		94-	6G72 MPI SOHC	6	1,1	BPR6ES-11	4824	13	BPR6EIX-11	3903
Diamante 3000	3.0		94-	6G72 MPI DOHC	6	0,8	BK6E	3536		BKR6EIX	6418
Diamante (F36A, F46A) 3000 GDI	3.0	0	09.99-09.01	6G72	6	0,8	IZFR5C	7748			
Eclipse	2.0		97-	4G6	4	1,1	BPR6ES-11	4824	13	BPR6EIX-11	3903
Eclipse 2000 D30	2.0	107	11.95-	4G63	4	1,1	BUR7EA-11	7031			
Eclipse 2000	2.0	110	91-10.95	4G63 MPI DOHC	4	0,8	BPR7ES	2023	19	BPR7EIX	4055
Eclipse 2400	2.4	105	09.98-	4G64	4	1,1	BKR5E-11	6953	33	BKR5EIX-11	5464
Eterna 2000 (E74A, E84A)	2.0	0	05.92-10.94	6A12	4	0,8	PFR6J	2645			
Eterna 2500 (EC5A)	2.5	0	08.96-	6A13	4	0,8	PFR6J	2645			
Evolution-V	2.0				4	0,8	PGR7A	3200			
Evolution-VI Tommi Makinen Edit.	2.0		01.99-		4	0,8	IGR7A	7509			
Evolution-VI (CP9A)	2.0	206	02.98-05.99	4G63 TURBO	4	0,8	PGR7A	3200			
Evolution-VII	2.0	206	01-		4	0,8	IGR7A-G	3106			
Evolution-VIII	2.0	195	04-		4	0,8	IGR7A-G	3106			
Evolution-IX	2.0		03.05-	4G63-D4(VT)DOHC	4	0,6	ILFR7H	5245			
Expo 1800 LRV	1.8		94-	4G93 MPI	4	1,1	BKR5E-11	6953	33	BKR5EIX-11	5464
Expo 2400 / LRV	2.4	113	94-	4G64 MPI SOHC	4	1,1	BKR5E-11	6953	33	BKR5EIX-11	5464
Express	2.0			4G63	4	0,7	BP6ES	7811	4	BPR6EIX	6637
Express	2.4			4G64	4	0,7	BP6ES	7811	4	BPR6EIX	6637
FTO	1.8			4G93	4	1,1	BKR5E-11	6953	33	BKR5EIX-11	5464
FTO without MIVEC Front Bank	2.0			6A12	4	1,1	BKR6E-11	2756	14	BKR6EIX-11	3764
FTO with MIVEC Rear Bank	2.0			6A12 MIVEC	4		PFR7M	4877			
FTO with MIVEC Front Bank	2.0			6A12 MIVEC	4		BKR7EKC-N	2095			
FTO without MIVEC Rear Bank	2.0			6A12	4	1,1	PFR6G-11	5555			
Galant 1800	1.8		94-	4G93	4	0,8	BK6E	3536		BKR6EIX	6418
Galant 1800	1.8		90- 91	4G37 Cat.	4	1,1	BPR6ES-11	4824	13	BPR6EIX-11	3903
Galant 1800	1.8		88- 90	4G37 Cat.	4	0,8	BPR6ES	7822	2	BPR6EIX	6637
Galant 1800	1.8		92-	4G37 Cat.	4	1,1	BPR7ES-11	7226			
Galant 1800	1.8	85	93- 94	4G93 MPI	4	1,1	BKR6E-11	2756	14	BKR6EIX-11	3764
Galant	2.0		88- 93	4G63 GTi16	4	0,8	BPR7ES	2023	19	BPR7EIX	4055
Galant	2.0		97-	4G63	4	1,1	BKR6E-11	2756	14	BKR6EIX-11	3764
Galant 2000	2.0		92-	Cat.	4	1,1	BPR7ES-11	7226			
Galant 2000	2.0			4G63 Cat.	4	1,1	BPR6ES-11	4824	13	BPR6EIX-11	3903
Galant 2000	2.0		92- 92	4G63	4	1,1	BPR7ES-11	7226			
Galant 2000	2.0		92- 92	4G63D	4	0,8	BPR6ES	7822	2	BPR6EIX	6637
Galant	2.0		91- 91	4G63	4	0,8	BPR6ES	7822	2	BPR6EIX	6637
Galant 2000	2.0		93- 96	4G63	4	0,8	BK6E	3536		BKR6EIX	6418
Galant TD (E5..8)	2.0	66	11.92-10.96	4D68 SOHC	4	█	CY57	5287		D-POWER 21	4994
Galant TD (EA)	2.0	66	10.96-02.00	4D68	4	█	CY57	5287		D-POWER 21	4994
Galant 2000	2.0	100	96-	4G63	4	1,1	BKR6E-11	2756	14	BKR6EIX-11	3764
Galant 2000	2.0	101	94-	4G63 MPI	4	1,1	BKR6E-11	2756	14	BKR6EIX-11	3764
Galant 2000 V6 (E74A, E84A)	2.0	110	05.92-10.94	6A12 MPI 24V	6	1,1	PFR6J-11	2743			
Galant 2400	2.4		94-	4G64 MPI DOHC	6	1,1	BPR6ES-11	4824	13	BPR6EIX-11	3903
Galant 2400	2.4		94-	4G64 MPI SOHC	6	1,1	BKR6E-11	2756	14	BKR6EIX-11	3764
Galant GDI	2.4	110	10.98-	4G64 GDI	6	0,6	IZFR5B	4080			
Galant V6 24V	2.5		95-	6G73 MPI	6	1,1	PFR6J-11	2743			

<sup>1)</sup> Bic = Best in class



ℓ kW

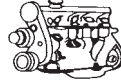

Cyl.

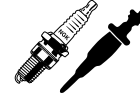
Order-  
No. No.Bic<sup>1)</sup> Order-  
D-Power No.**MITSUBISHI**

Galant V6	2.5		03.97 -	6A13	6	1,1	PFR6G-11	5555			
Galant 2500 (EC5A)	2.5	0	08.96 -	6A13	4	0,8	PFR6J	2645			
Galant 2500 V6	2.5	125	93 - 03.97	6G12 24V	6	1,1	PFR6J-11	2743			
Galant Wagon TD (EA)	2.0	66	10.96 - 02.00	4D68	4	█	CY57	5287		D-POWER 21	4994
Galloper Td	2.5	73	98 -	D4BH	4	█	CY57	5287		D-POWER 21	4994
Galloper	3.0	104	98 -	G6-AT	6	1,1	BPR5ES-11	4424		BPR5EIX-11	2115
Grandis	2.4	121	04.04 -	4G69	4		LZFR6AI	3656			
L200	1.6			4G32 Cat.	4	0,8	BPR6ES	7822	2	BPR6EIX	6637
L200	1.6		92 -	4G32	4	0,9	BPR5ES	7422	6	BPR5EIX	6597
L200	2.0		92 -	4G63	4	0,8	BPR6ES	7822	2	BPR6EIX	6637
L200	2.0		- 92	4G63	4	0,8	BPR7ES	2023	19	BPR7EIX	4055
L200	2.4	82	94 -	4G64 MPI	4	1,1	BPR6ES-11	4824	13	BPR6EIX-11	3903
L200	2.4	97	99 -		4	1,1	BPR6ES-11	4824	13	BPR6EIX-11	3903
L200	2.5		99 -	4D56	4	█	Y-733J	8944		D-POWER 13	6592
L200	2.5		- 93	4D5	4	█	Y-115T1	2189			
L200 (KOT-K3T) * ohne Schnellstartanlage	2.5	51	11.93 - 05.94	4D56 without QGS	4	█	Y-733J	8944		D-POWER 13	6592
L200 (KOT-K3T)	2.5	51	06.94 - 08.96	4D56 SOHC	4	█	CY57	5287		D-POWER 21	4994
L200	2.6		95 -	G54B	4	1,1	BUR6EA-11	5428			
L200	2.6		- 92	4G54	4	1,1	BPR6ES-11	4824	13	BPR6EIX-11	3903
L200	2.6	76	93 -	4G54/B	4	1,1	BPR6ES-11	4824	13	BPR6EIX-11	3903
L300	1.4		94 -	4G33	4	0,7	BP6ES	7811	4	BPR6EIX	6637
L300	1.6	51	80 - 94	4G32	4	0,9	BPR5ES	7422	6	BPR5EIX	6597
L300	2.0		95 -	4G63 FBC	4	1,1	BKR5E-11	6953	33	BKR5EIX-11	5464
L300	2.0		- 92	4G63	4	0,8	BPR6ES	7822	2	BPR6EIX	6637
L300	2.0		10.94 -	4G63 MPI	4	1,1	BKR5E-11	6953	33	BKR5EIX-11	5464
L300	2.0	66	92 -	4G63 Cat.	4	0,8	BPR6ES	7822	2	BPR6EIX	6637
L300	2.0	85	07.94 -	4G63	4	0,9	BPR5ES	7422	6	BPR5EIX	6597
L300	2.4	82	92 -	4G64 Cat.	4	1,1	PGR6A-11	3738			
L300	2.5		97 -	4D56	4	█	Y-733J	8944		D-POWER 13	6592
L300	2.5		- 92	4D5	4	█	Y-115T1	2189			
L300 TD (P)	2.5	64	06.93 - 96	4D56 SOHC	4	█	CY57	5287		D-POWER 21	4994
L300 / 4WD	2.3		04.83 -	4D55	4	█	Y-115T1	2189			
L300 / 4WD QGS Type	2.3			4D55	4	█	Y-115R1	2161			
L400			95 - 97	4D56	4	█	CY57	5287		D-POWER 21	4994
L400	2.0		95 -	4G63 MPI	4	1,1	BKR5E-11	6953	33	BKR5EIX-11	5464
L400	2.4		95 -	4G64 MPI	4	1,1	BKR5E-11	6953	33	BKR5EIX-11	5464
L400	2.5		98 -	4D56	4	█	Y-733J	8944		D-POWER 13	6592
L400 TD	2.5	73	12.94 -	4D56	4	█	CY57	5287		D-POWER 21	4994
Lancer 1200	1.2		08.84 - 89	4G16	4	0,8	BPR6ES	7822	2	BPR6EIX	6637
Lancer 1300	1.3		89 - 92	4G13	4	0,8	BPR6ES	7822	2	BPR6EIX	6637
Lancer 1300	1.3		10.92 -	4G13	4	0,8	BP5ES	6511	8	BPR5EIX	6597
Lancer 1300	1.3		97 -	4G1	4	1,1	BPR5ES-11	4424		BPR5EIX-11	2115
Lancer 1300	1.3		- 09.92	4G13 Cat.	4	0,8	BPR6ES	7822	2	BPR6EIX	6637
Lancer	1.3	55	03.96 -	4G13	4	1,1	BUR6EA-11	5428			
Lancer 1300	1.3	55	10.92 -	4G13 MPI	4	1,1	BPR5ES-11	4424		BPR5EIX-11	2115
Lancer	1.3	60	09.03 -		4	1,1	BKR6E-11	2756	14	BKR6EIX-11	3764
Lancer 1500	1.5		94 -	4G91 MPI	4	1,1	BK6E-11	7340		BKR6EIX-11	3764
Lancer 1500	1.5		86 - 92	4G15 Cat.	4	1,1	BPR6ES-11	4824	13	BPR6EIX-11	3903
Lancer 1500	1.5		08.84 - 92	4G15	4	0,8	BPR6ES	7822	2	BPR6EIX	6637
Lancer 1500	1.5	69	93 -	4G15	4	0,8	BP5ES	6511	8	BPR5EIX	6597
Lancer 1600 Twin Carb.	1.6				4	0,8	BPR6ES	7822	2	BPR6EIX	6637
Lancer 1600 Turbo	1.6		86 - 88	4G32T	4	0,8	BPR6ES	7822	2	BPR6EIX	6637

<sup>1)</sup> Bic = Best in class

\* without quick glow system



ℓ kW

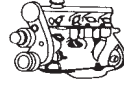

Cyl.

Order-  
No. No.Bic<sup>1)</sup> Order-  
D-Power No.**MITSUBISHI**

Lancer 1600	1.6		97 -	4G9 (not MVV Magermix)	4	1,1	BKR6E-11	2756	14	BKR6EIX-11	3764
Lancer 1600	1.6		97 -	4G9 MVV	4	1,1	BKR5E-11	6953	33	BKR5EIX-11	5464
Lancer 1600	1.6		90-09.92	4G61 DOHC	4	0,8	BPR6ES	7822	2	BPR6EIX	6637
Lancer 1600	1.6		94 -	4G92 MVV	4	1,1	BKR5E-11	6953	33	BKR5EIX-11	5464
Lancer	1.6	72	09.03 -	4G18	4	1,1	BKR6E-11	2756	14	BKR6EIX-11	3764
Lancer 1600	1.6	83	10.92 -	4G92 MPI	4	1,1	BKR6E-11	2756	14	BKR6EIX-11	3764
Lancer	1.8		93 -	4G93 GTi16	4	1,1	BKR6E-11	2756	14	BKR6EIX-11	3764
Lancer	1.8		90- 92	4G37 GTi16	4	0,8	BPR6ES	7822	2	BPR6EIX	6637
Lancer	1.8		90- 92	4G37 GLXi	4	1,1	BPR6ES-11	4824	13	BPR6EIX-11	3903
Lancer 1800 16V	1.8		93 -	4G93 MPI	4	0,8	BK6E	3536		BKR6EIX	6418
Lancer 1800	1.8			4G67	4	0,8	BPR7ES	2023	19	BPR7EIX	4055
Lancer 1800	1.8			4G37 Cat.	4	1,1	BPR6ES-11	4824	13	BPR6EIX-11	3903
Lancer 2000	2.0		01.05 -	4G94	4	1,1	BKR5E-11	6953	33	BKR5EIX-11	5464
Lancer Evolution- IX	2.0		03.05 -	4G63-D4(VT)DOHC	4	0,6	ILFR7H	5245			
Lancer Evolution-V	2.0				4	0,8	PGR7A	3200			
Lancer Evolution-VI Tommi Makinen Edit.	2.0		01.99 -		4	0,8	IGR7A	7509			
Lancer (CB/CD)	2.0	50	12.93-06.96	4D68	4	█	CY57	5287		D-POWER 21	4994
Lancer	2.0	99	09.03 -	4G63	4	1,1	IGR6A-11	5743			
Lancer Evolution-VIII	2.0	195	04 -		4	0,8	IGR7A-G	3106			
Lancer Evolution-VI (CP9A)	2.0	206	02.98-05.99	4G63 TURBO	4	0,8	PGR7A	3200			
Lancer Evolution-VII	2.0	206	01 -		4	0,8	IGR7A-G	3106			
Laser 1800	1.8			4G37	4	1,1	BPR6ES-11	4824	13	BPR6EIX-11	3903
Laser 2000	2.0			4G63	4	1,1	BPR6ES-11	4824	13	BPR6EIX-11	3903
Laser 2000 Turbo	2.0			4G63	4	0,8	BPR6ES	7822	2	BPR6EIX	6637
Legnum 2500 (EC5A)	2.5	0	08.96 -	6A13	4	0,8	PFR6J	2645			
Mirage	1.5		94 -	4G15 MPI	4	1,1	BPR5ES-11	4424		BPR5EIX-11	2115
Mirage	1.8		94 -	4G93 MPI	4	1,1	BKR5E-11	6953	33	BKR5EIX-11	5464
Montero Sport			97 -		4	█	Y-733J	8944		D-POWER 13	6592
Montero			92- 93	4D56	4	█	Y-115T1	2189			
Montero			94- 95	4D56	4	█	CY57	5287		D-POWER 21	4994
Montero			96 -	4D56	4	█	Y-733J	8944		D-POWER 13	6592
Montero			85 -	4D55T			--- *				
Montero V6 3000	3.0		91 -	6G72	6	1,1	BPR5ES-11	4424		BPR5EIX-11	2115
Multicar M25		40	01.91 -	VW028B-1Y	4	█	Y-918R	4182		D-POWER 2	6285
Multicar M26		40	01.91 -	VW028B-1Y	4	█	Y-918R	4182		D-POWER 2	6285
Outlander	2.0	93	05.03 -		4	1,1	IGR6A-11	5743			
Outlander	2.0	100	05.03 -	4G63	4	1,1	IGR6A-11	5743			
Outlander 2.0 DI-D	2.0	103	06 -		4	█	CZ301				
Outlander 2.0 Turbo	2.0	148	05 -		4	1,1	IGR6A-11	5743			
Outlander	2.0	177	05.03 -		4	1,1	IGR6A-11	5743			
Outlander	2.4	102	05.03 -		4		LZFR6AI	3656			
Outlander	2.4	118	05.03 -	4G69	4		LZFR6AI	3656			
Pajero			85 -	4D55T	4		--- *				
Pajero				4D56 S-QGS Type	4		--- *				
Pajero			92- 93	4D56	4	█	Y-115T1	2189			
Pajero Sport			97 -	4D56-QGS	4		--- *				
Pajero	2.4		97 -	4G64	4	1,1	BPR6ES-11	4824	13	BPR6EIX-11	3903
Pajero 2400	2.4		03.91 -	4G64	4	1,1	BPR6ES-11	4824	13	BPR6EIX-11	3903
Pajero TD Intercooler (IV)	2.5	62	08.93-05.99	4D56 T	4	█	Y-733J	8944		D-POWER 13	6592
Pajero TD not QGS Type	2.5	62	06.86 -	4D56 Turbo not QGS Type		█	Y-115T1	2189			
Pajero TD Intercooler (V)	2.5	73	11.93-01.98	4D56 T	4	█	CY57	5287		D-POWER 21	4994
Pajero 2600	2.6			4G54	4	0,9	BPR5ES	7422	6	BPR5EIX	6597

<sup>1)</sup> Bic = Best in class

\* only by car dealer





ℓ kW

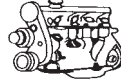

Cyl.

Order-  
No. No.Bic<sup>1)</sup> Order-  
D-Power No.**MITSUBISHI**

Pajero 2600	2.6		92 -		4	1,1	BP6ES-11	1212			
Pajero 2600	2.6			4G54 Cat.	4	1,1	BPR5ES-11	4424		BPR5EIX-11	2115
Pajero (V4..)	2.8	92	06.94 - 04.00	4M40	4	█	CY55	3861			
Pajero	3.0		97 -	6G72 12Ventiler	6	1,1	BPR5ES-11	4424		BPR5EIX-11	2115
Pajero Sport	3.0		99 -	6G72 24Ventiler	6	1,1	PFR6J-11	2743			
Pajero 3000 V6	3.0		89 -	6G72	6	1,1	BPR5ES-11	4424		BPR5EIX-11	2115
Pajero	3.0	130	97 -	6G72 24Ventiler	6	1,1	PFR6J-11	2743			
Pajero 3.2 DI-D	3.2	118	04.00 -		4	█	Y-532J	7782			
Pajero	3.5	143	97 -	6G74	6	1,1	PFR5J-11	4642			
Pajero GDI V60	3.5	149	04.00 -	V6	6	0,6	IZFR5B	4080			
Pajero 3500 V6	3.5	153	04.94 - 97	6G74 DOHC	6	1,1	PFR6J-11	2743			
Pajero Pinin (H66W,H67W)	1.8	88	00 -	4G93 GDI	4	0,6	IZFR6B	3116			
Pajero Pinin (H76W,H77W)	2.0	95	09.00 -	4G94 GDI	4	0,6	IZFR5B	4080			
Santamo	2.0	102	99 -	DOHC / SOHC	4	1,1	BP6ES-11	1212			
Sapporo 1200	1.2				4	0,8	BPR6ES	7822	2	BPR6EIX	6637
Sapporo 1400	1.4				4	0,9	BPR5ES	7422	6	BPR5EIX	6597
Sapporo 1600	1.6				4	0,9	BPR5ES	7422	6	BPR5EIX	6597
Sapporo 1600 Twin Carb.	1.6				4	0,8	BPR6ES	7822	2	BPR6EIX	6637
Sapporo 2400	2.4			4G64	4	1,1	BPR7ES-11	7226			
Shogun	2.5		01.96 - 03.00	4D56	4	█	Y-733J	8944		D-POWER 13	6592
Shogun	2.5		85 - 12.90	4D56	4	█	Y-115T1	2189			
Shogun	2.5		94 - 95	4D56	4	█	CY57	5287		D-POWER 21	4994
Shogun	2.6		83 - 90	4G54	4	0,9	BPR5ES	7422	6	BPR5EIX	6597
Shogun	2.6		83 - 90	4G54	4	0,9	BPR5ES	7422	6	BPR5EIX	6597
Shogun	3.0		91 - 94	6G72	6	1,1	BPR5ES-11	4424		BPR5EIX-11	2115
Shogun	3.0		94 -	6G72	6	1,1	PFR6J-11	2743			
Shogun	3.0		91 - 94	6G72	6	1,1	BPR5ES-11	4424		BPR5EIX-11	2115
Shogun	3.0		83 - 90	6G72	6	1,1	BPR5ES-11	4424		BPR5EIX-11	2115
Shogun	3.5		91 -	6G74	6	1,1	PFR5J-11	4642			
Shogun	3.5		00 -		6	0,8	IZFR5B	4080			
Shogun PININ	1.8		00 -	4G93 GDI	4	0,8	IZFR6B	3116			
Shogun PININ	2.0		00 -	4G94 GDI	4	0,8	IZFR5B	4080			
Sigma			80 -	4D55 / T QGS Type		█	Y-115R1	2161			
Sigma			80 -	4D55		█	Y-115T1	2189			
Sigma V6	3.0		91 - 93	6G72 DOHC 24V	6	1,1	PFR6J-11	2743			
Sigma V6	3.0		91 - 93	6G72 SOHC	6	1,1	BPR6ES-11	4824	13	BPR6EIX-11	3903
Sigma 3000	3.0		94 -	6G72 MPI V6-24V	6	1,1	PFR6J-11	2743			
Sigma 3000	3.0		93 -	6G72 MPI V6	6	1,1	BPR6ES-11	4824	13	BPR6EIX-11	3903
Space Gear	2.0		97 -	4G69	4	1,1	BKR5E-11	6953	33	BKR5EIX-11	5464
Space Gear	2.0	83	04.95 -	4G63 MPI	4	1,1	BKR5E-11	6953	33	BKR5EIX-11	5464
Space Gear	2.4	97	04.95 -	4G64 MPI	4	1,1	BKR5E-11	6953	33	BKR5EIX-11	5464
Space Gear	2.5		98 -	4D56 Turbo	4	█	Y-733J	8944		D-POWER 13	6592
Space Gear	2.5	73	12.94 -	4D56	4	█	CY57	5287		D-POWER 21	4994
Space Gear	2.5	73	06.94 - 05.95	4D56 Turbo	4	█	Y-733J	8944		D-POWER 13	6592
Space Runner 1800	1.8		94 -	4G93	4	0,8	BK6E	3536		BKR6EIX	6418
Space Runner	1.8		97 -	4G93	4	1,1	BKR6E-11	2756	14	BKR6EIX-11	3764
Space Runner 1800	1.8	90	91 - 99	4G93 MPI	4	1,1	BKR6E-11	2756	14	BKR6EIX-11	3764
Space Runner 1800	1.8	90	09.91 - 92	4G93	4	1,1	BKR6E-11	2756	14	BKR6EIX-11	3764
Space Runner	2.0	60	06.93 -	4D68	4	█	CY57	5287		D-POWER 21	4994
Space Runner	2.0	100	99 -	4G63 MPI	4	1,1	BKR6E-11	2756	14	BKR6EIX-11	3764
Space Runner GDI	2.4	110	99 -	4G64 GDI	4	0,6	IZFR5B	4080			
Space Star 1300	1.3	63	12.98 -	4G13	4	1,1	BKR5E-11	6953	33	BKR5EIX-11	5464

<sup>1)</sup> Bic = Best in class



ℓ kW

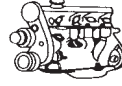

Cyl.

Order-  
No. No.Bic<sup>1)</sup> Order-  
D-Power No.**MITSUBISHI**

Space Star	1.6		99-	4G92	4	1,1	BKR5E-11	6953	33	BKR5EIX-11	5464
Space Star 1600	1.6	72	12.98-	4G16	4	1,1	BKR5E-11	6953	33	BKR5EIX-11	5464
Space Star 1800 GDI	1.8	90	03.99-	4G93	4	0,8	IZFR6B	3116			
Space Star GDI	1.8	92	99-	4G93 GDI	4	0,6	IZFR6B	3116			
Space Star	1.9	59		F9QT	4	■	Y-515J	1019		D-POWER 18	6892
Space Star 1.9 DI-D	1.9	75	12.00-	DCI Renault	4	■	Y-515J	1019		D-POWER 18	6892
Space Wagon			86- 88		4	0,8	BPR6ES	7822	2	BPR6EIX	6637
Space Wagon 1800	1.8		94-	4G93 MPI	4	1,1	BKR6E-11	2756	14	BKR6EIX-11	3764
Space Wagon 1800	1.8		84- 91	4G37	4	0,8	BPR6ES	7822	2	BPR6EIX	6637
Space Wagon 1800	1.8		09.91- 93	4G93	4	1,1	BKR6E-11	2756	14	BKR6EIX-11	3764
Space Wagon 1800	1.8		94-	4G93	4	0,8	BK6E	3536		BKR6EIX	6418
Space Wagon	2.0		97-	4G63	4	1,1	BKR5E-11	6953	33	BKR5EIX-11	5464
Space Wagon 2000 4WD	2.0		89-		4	0,8	BPR7ES	2023	19	BPR7EIX	4055
Space Wagon 2000	2.0		89- 91	4G63 Cat.	4	1,1	BPR7ES-11	7226			
Space Wagon (N)	2.0	60	06.93-	4D68	4	■	CY57	5287		D-POWER 21	4994
Space Wagon Gdi (N5.)	2.0	98	02.02-	4G94	4	1,1	HB6BIX-11P	5705			
Space Wagon 2000	2.0	98	92-	4G63 MPI Cat.	4	1,1	BKR6E-11	2756	14	BKR6EIX-11	3764
Space Wagon 2400	2.4		93- 95	4G64 Cat.	4	1,1	BKR6E-11	2756	14	BKR6EIX-11	3764
Space Wagon GDI (N84W,N94W)	2.4	110	10.98-07.00	4G64 GDI	4	0,6	IZFR5B	4080			
Starion Turbo	2.0		82- 88	4G63	4	0,8	BR7ES	5122			
Starion 2000	2.0				4	0,8	BPR7ES	2023	19	BPR7EIX	4055
Starion 2600 Turbo	2.6		89-	4G54 Cat.		1,1	BPR6ES-11	4824	13	BPR6EIX-11	3903
Tredia	1.6		86-		4	0,9	BPR5ES	7422	6	BPR5EIX	6597
Truck / 4WD			83-	4D55T		■	Y-115R1	2161			

**MORGAN**

4/4	1.6	71	01.82- 93	CVH Ford	4	0,8	BCPR6ES	2330	12	BCPR6EIX	5689
4/4	1.6	72	01.82-	132D.000	4	0,7	BP6ES	7811	4	BPR6EIX	6637
4/4	1.8		94- 98	FORD ZETEC	4	1,0	PTR5A-10	5055			
4/4	1.8	89	02.93-	Zetec 16V	4	1,3	PTR5A-13	2467	25		
Aero 8	4.4	210	00-	BMW M62B44	8		BKR6EQU	3199	30		
Plus 4	2.0	98	09.87- 92	M16i	4	0,8	BCPR6ES	2330	12	BCPR6EIX	5689
Plus 4	2.0	99	09.92- 96	T16	4	0,8	BCPR6ES	2330	12	BCPR6EIX	5689
Plus 8	3.5	116	08.77-01.90	V8 Rover	8	0,7	BP6ES	7811	4	BPR6EIX	6637
Plus 8	3.5	136	01.90- 01	V8 Rover Cat.	8	0,7	BP6ES	7811	4	BPR6EIX	6637
Plus 8	3.5	142	01.90- 01	V8 Rover	8	0,7	BP6ES	7811	4	BPR6EIX	6637
Plus 8	4.0		01-	ROVER V8	8	1,1	PFR6N-11	3546			
Plus 8	4.6		97- 99	ROVER V8	8	1,1	PFR6N-11	3546			

**MOSKWITCZ**

siehe AZLK		0									
------------	--	---	--	--	--	--	--	--	--	--	--

**NISSAN**

100 NX B13	1.6	66	10.90- 95	GA16DE Cat.	4	0,9	BKR6E	6962	28	BKR6EIX	6418
100 NX B13	1.6	66	10.90- 93	GA16DS Cat.	4	0,9	BKR6E	6962	28	BKR6EIX	6418
100 NX B13	1.6	75	94-	GA16DE	4	0,8	BKR5E	7938	35	BKR5EIX	6341
100 NX B13	2.0	105	10.90- 95	SR20DE Cat.	4	0,9	BKR6EY	3696		BKR6EIX	6418
200 SX Turbo S13	1.8	124	89- 93	CA18DET	4	1,1	PFR6A-11	4045			
200 SX Turbo S14	2.0	147	08.94-	SR20DET	4	0,9	PFR6B-9	3100			
200 SX Turbo S30	1.8	124	09.88-	CA18DET Cat.	4	1,1	PFR6A-11	4045			
200 SX Turbo S30	1.8	129	09.88-	CA18DET	4	1,1	BCPR6ES-11	7121	11	BCPR6EIX-11	4919
300 ZX Z31	3.0	122	01.84- 89	VG30	6	1,1	BCPR6ES-11	7121	11	BCPR6EIX-11	4919

<sup>1)</sup> Bic = Best in class



ℓ kW

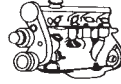

Cyl.

Order-  
No. No.Bic<sup>1)</sup> Order-  
D-Power No.**NISSAN**

300 ZX	Z32	3.0		90 -	VG30DE	6	1,1	PFR6B-11	4014				
300 ZXTT Biturbo	Z32	3.0	197	90 - 95	VG30DETT	6	1,1	PFR6B-11	4014				
300 ZX Biturbo	Z32	3.0	206	01.90 - 95	VG30DETT Cat.	6	1,1	PFR6B-11	4014				
300 ZXT Turbo	Z31	3.0	149	02.87 - 90	VG30ET Cat.	6	1,1	BCPR6E-11	3132	11	BCPR6EIX-11	4919	
350 Z Roadster		3.5	206	02.05 -	VQ35DE	6	1,1	PLFR5A-11	6240				
350 Z		3.5	206	09.03 -	VQ35DE	6	1,1	PLFR5A-11	6240				
350 Z		3.5	221	06 -	VQ35DE	6	1,1	PLFR5A-11	6240				
350 Z Roadster		3.5	221	06 -	VQ35DE	6	1,1	PLFR5A-11	6240				
Almera	N15	1.4	55	09.95 -	GA14DE	4	0,8	BKR5E	7938	35	BKR5EIX	6341	
Almera	N15	1.6	66	95 - 00	QG15DE	4	1,1	BKR5E-11	6953	33	BKR5EIX-11	5464	
Almera	N15	1.6	66	09.95 -	GA16DE	4	0,8	BKR5E	7938	35	BKR5EIX	6341	
Almera	N15/Hatchback	2.0	55	07.95 - 00	CD20E	4	█	CY52	3017				
Almera dCi	N16	1.5	60	01.03 -	K9K	4	█	Y-515J	1019		D-POWER 18	6892	
Almera	N16	1.5	66	02.00 - 09.02	QG15DE	4	1,1	BKR5E-11	6953	33	BKR5EIX-11	5464	
Almera	N16	1.5	72	10.02 -	QG15DE	4	1,1	LFR5A-11	6376				
Almera	N16	1.8	84	02.00 - 09.02	QG18DE	4	1,1	BKR5E-11	6953	33	BKR5EIX-11	5464	
Almera	N16	1.8	85	10.02 -	QG18DE	4	1,1	LFR5A-11	6376				
Almera Di	N15	2.2	82	02.00 - 03	YD22DDT	4	█	Y-519J	2500				
Almera Gti	N15	2.0	105	95 -	SR20DE	4	1,1	BKR5EY-11	2355		BKR5EIX-11	5464	
Almera Tino	ATV10	1.8	84	00 - 02	QG18DE	4	1,1	BKR5E-11	6953	33	BKR5EIX-11	5464	
Almera Tino	ATV10	1.8	85	03 -	QG18DE	4	1,1	LFR5A-11	6376				
Almera Tino	ATV10	2.0	100	00 - 02	SR20DE	4	1,1	PFR6G-11	5555				
Almera Tino	2.2 VDI	2.2	84	04.02 -	YD22ET	4	█	Y-519J	2500				
Axxess	M11	2.4		93 -	KA24E	6	1,1	ZFR5E-11	4435				
Bluebird		1.8		90 -	CA18S	4	0,8	BCP5ES	7496	16	BCPR5EIX	5688	
Bluebird		1.8		- 89	CA18S	4	0,8	BPR6ES	7822	2	BPR6EIX	6637	
Bluebird		1.8		90 -	CA18NS	4	0,8	BCP5ES	7496	16	BCPR5EIX	5688	
Bluebird	T12	1.6	66	12.85 - 88	CA16S	4	0,8	BCPR6ES	2330	12	BCPR6EIX	5689	
Bluebird	T12	2.0	77	12.85 -	CA20S	4	0,8	BCPR6ES	2330	12	BCPR6EIX	5689	
Bluebird	T72	1.6		- 88	CA16	4	0,8	BCPR5ES	6130	32	BCPR5EIX	5688	
Bluebird	T72	1.6	62	09.88 -	CA16S	4	0,8	BCPR6ES	2330	12	BCPR6EIX	5689	
Bluebird	T72	2.0	77	09.88 - 92	CA20S	4	0,8	BCPR6ES	2330	12	BCPR6EIX	5689	
Bluebird	T72	2.0	85	09.88 -	CA20E	4	1,1	BCPR6ES-11	7121	11	BCPR6EIX-11	4919	
Bluebird	U13	1.6		94 -	CA16NS	4	0,8	BCP5ES	7496	16	BCPR5EIX	5688	
Bluebird	U13	2.0		93 -	CA20E	4	1,1	BCPR6ES-11	7121	11	BCPR6EIX-11	4919	
Bluebird	U13	2.0		93 -	CA20S	4	0,7	BCP6ES	4930	17	BCPR6EIX	5689	
Bluebird 16V	T12	1.8	99	11.88 - 90	CA18DE Cat.	4	1,1	PFR6A-11	4045				
Bluebird 16V	T72	1.8	95	02.89 - 90	CA18DE Cat.	4	1,1	PFR6A-11	4045				
Bluebird 4X EX + 4X IN	T12	2.0	77	03.86 - 92	CA20E Twin Spark Cat.	4	1,1	BCPR5ES-11+	3524+		BCPR5EIX-11+	3306+	
								BCPR6ES-11	7121		BCPR6EIX-11	4919	
Bluebird 4X EX + 4X IN	T72	2.0	77	09.88 - 90	CA20E Twin Spark Cat.	4	1,1	BCPR5ES-11+	3524+		BCPR5EIX-11+	3306+	
								BCPR6ES-11	7121		BCPR6EIX-11	4919	
Bluebird 4X EX + 4X IN	U11	2.0	77	04.86 - 90	CA20E Twin Spark Cat.	4	1,1	BCPR5ES-11+	3524+		BCPR5EIX-11+	3306+	
								BCPR6ES-11	7121		BCPR6EIX-11	4919	
Bluebird Turbo	T12	1.8	88	12.85 -	CA18T	4	1,1	BCPR6ES-11	7121	11	BCPR6EIX-11	4919	
Bluebird Turbo	T72	1.8	99	09.88 -	CA18T	4	1,1	BCPR6ES-11	7121	11	BCPR6EIX-11	4919	
Bluebird/819/910	T12	2.0	47	12.85 - 02.90	LD20	4	█	CY51	2696				
Bluebird/819/910	T72	2.0	49	09.88 - 04.90	LD20	4	█	CY51	2696				
Bluebird/819/910 QGS Type 1		2.0		01.81 -	LD20, LD20T	4	█	Y-204RS	4573				
Bluebird/819/910 QGS Type 1		2.8		08.81 -	LD28		█	Y-204RS	4573				
Bluebird/819/910 QGS Type 2		2.0		01.81 -	LD20, LD20T	4	█	Y-204SS	7629				
Bluebird/819/910 QGS Type 2		2.8		08.81 -	LD28		█	Y-204SS	7629				

<sup>1)</sup> Bic = Best in class



ℓ kW

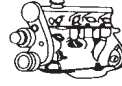

Cyl.

Order-  
No. No.Bic<sup>1)</sup> Order-  
D-Power No.**NISSAN**

Bluebird/Hatchback T12	2.0	47	12.85 - 02.90	LD20	4	☑	CY51	2696				
Bluebird/Hatchback T72	2.0	49	09.88 - 04.90	LD20	4	☑	CY51	2696				
Brougham	2.3		93 -	TD23		☑	Y-707RS	4937				
Brougham	3.0			VG30E	6	1,1	BCP6ES-11	7210			BCPR6EIX-11	4919
C120 / Vanette	2.0		87 -	LD20		☑	CY51	2696				
C120 / Vanette QGS Type 1	2.0		09.82 -	LD20		☑	Y-204RS	4573				
Caball	2.2		82 -	SD22		☑	Y-112R1	1032				
Caball	3.0		12.81 -	ED30		☑	Y-272R-1	2731				
Cabstar	2.2		01.82 -	SD22		☑	Y-112R1	1032				
Cabstar	2.3			SD23		☑	Y-112M1	2531				
Cabstar	2.3			TD23		☑	Y-707RS	4937				
Cabstar	2.5			TD25		☑	Y-707RS	4937				
Cabstar	2.5			SD25		☑	Y-112M1	2531				
Cabstar	2.7			TD27		☑	Y-707RS	4937				
Cabstar	3.3			ED33		☑	Y-272R-1	2731				
Cabstar	3.3			ED33		☑	Y-955RS	4995				
Cabster	2.3			TD23		☑	Y-707RS	4937				
Cabster	3.3			ED33		☑	Y-955RS	4995				
Cabster F23/H41	1.6		93 -	Z16	4	0,8	BP5ES	6511	8		BPR5EIX	6597
Cabster F23/H41	2.0			Z20S,NA20S	4	0,9	BPR5ES	7422	6		BPR5EIX	6597
Cabster F23/H41	2.0		93 -	Z20	4	0,8	BP5ES	6511	8		BPR5EIX	6597
Cabster F23/H41	2.4		93 -	Z24	6	0,7	BP6ES	7811	4		BPR6EIX	6637
Cabster F23 & H41	2.5			TD25		☑	Y-707RS	4937				
Cabster F23 & H41	2.7			TD27		☑	Y-707RS	4937				
Cedric	2.0	92	07.87 -	VG20E	4	1,1	BCPR6ES-11	7121	11		BCPR6EIX-11	4919
Cedric (MY34)	2.5		06.99 - 06.00	VQ25DD Ne-Di	4	1,1	PFR5P-11	4341				
Cedric	3.0	118	07.87 -	VG30E	6	1,1	BCPR6ES-11	7121	11		BCPR6EIX-11	4919
Cedric Turbo	3.0	144	07.87 -	VG30ET	6	1,1	BCPR6ES-11	7121	11		BCPR6EIX-11	4919
Cedric Turbo 24V	2.0	136	07.87 -	VG20DET	6	1,1	BCPR6ES-11	7121	11		BCPR6EIX-11	4919
Cedric/220C/280C	2.0		06.79 -	SD20		☑	Y-112T	6327				
Cedric/220C/280C	2.2		06.79 -	SD22		☑	Y-112T	6327				
Cedric/220C/280C	2.3		84 -	SD23		☑	Y-112R1	1032				
Cedric/220C/280C	2.3			TD23		☑	Y-707RS	4937				
Cedric/220C/280C QGS Type 1	2.8		06.82 -	LD28		☑	Y-204RS	4573				
Cedric/220C/280C QGS Type 1	2.8		06.82 -	LD28		☑	Y-204RS	4573				
Cedric/220C/280C QGS Type 2	2.8		06.82 -	LD28		☑	Y-204SS	7629				
Cefiro (PA33)	2.5		12.98 - 12.01	VQ25DD Ne-Di	4	1,1	PFR5P-11	4341				
Cherry N12	1.7	45	87 -	CD17	4	☑	CY51	2696				
Chery N12 QGS Type 1	1.7		10.82 -	CD17		☑	Y-117RS	2930				
Chery N12 QGS Type 2	1.7		10.82 -	CD17		☑	Y-117SS	2231				
Civilian	2.2		82 -	SD22		☑	Y-112R1	1032				
Civilian	3.0		12.81 -	ED30		☑	Y-272R-1	2731				
Civilian	3.3		04.88 -	ED33		☑	Y-955RS	4995				
Clipper	2.2		82 -	SD22		☑	Y-112R1	1032				
Clipper	3.0		12.81 -	ED30		☑	Y-272R-1	2731				
D21	1.6			Z 16S	4	0,7	BP6ES	7811	4		BPR6EIX	6637
D21	2.0			Z 20S	4	0,8	BPR6ES	7822	2		BPR6EIX	6637
D21	2.4			Z 24S	4	0,9	BPR5ES	7422	6		BPR5EIX	6597
D21	2.5		93 -	TD25		☑	Y-707RS	4937				
D21	2.7		93 -	TD27T		☑	Y-712RS	6140				
D21	2.7		93 -	TD27		☑	Y-707RS	4937				
D21	3.0			VG30E	6	0,9	BKR6EY	3696			BKR6EIX	6418

<sup>1)</sup> Bic = Best in class



ℓ kW

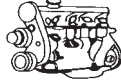

Cyl.

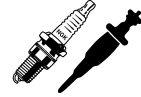
Order-  
No. No.Bic<sup>1)</sup> Order-  
D-Power No.**NISSAN**

EXA	1.8			CA18DE	4	1,1	PFR6A-11	4045				
F22	2.3			SD23		■	Y-162R1	2431				
F22	2.3			TD23		■	Y-707RS	4937				
F22	2.5			TD25		■	Y-707RS	4937				
F22	2.5			SD25		■	Y-162R1	2431				
F22	2.5		12.81 -	SD25		■	Y-112M1	2531				
F22	2.7			TD27		■	Y-707RS	4937				
F22	3.3			ED33		■	Y-955RS	4995				
F22 QGS Type 1	2.3		02.82 -	SD23		■	Y-112RS1	1132				
Gloria (MY34)	2.5		06.99 - 06.00	VQ25DD Ne-Di	4	1,1	PFR5P-11	4341				
Hommer	2.2		01.82 -	SD22		■	Y-112R1	1032				
Infiniti G20	2.0		94 -	SR20DE	4	0,9	BKR6E	6962	28	BKR6EIX	6418	
Junior	2.5			SD25		■	Y-112M1	2531				
Kubistar X76	1.1	43	03 -	D7F	4	0,8	BKR5EK	7956	23	BKR5EIX	6341	
Kubistar Cdi	1.5	48	08.03 -	K9K	4	■	Y-515J	1019		D-POWER 18	6892	
Kubistar Cdi	1.5	60	08.03 -	K9K	4	■	Y-515J	1019		D-POWER 18	6892	
Laurel C32 (4,5,6 Cyl CX51.)	2.8		02.87 -	RD28T	6	■	CX51+	2896+				
(1,2,3 Cyl.CZ51)						■	CZ51	3209				
Laurel QGS Type 1	2.8		10.81 -	LD28	6	■	Y-204RS	4573				
Laurel QGS Type 2	2.8		10.81 -	LD28	6	■	Y-204SS	7629				
Laurel A31	2.0		93 -	CA20S	4	0,7	BCP6ES	4930	17	BCPR6EIX	5689	
Laurel A31	2.0		94 -	RB20E	4	1,1	BCPR5ES-11	3524		BCPR5EIX-11	3306	
Laurel A31	2.4		94 -	RB24S	6	0,9	BKR6E	6962	28	BKR6EIX	6418	
Laurel C32	2.0	77	01.85 -	CA20S	4	0,8	BCPR6ES	2330	12	BCPR6EIX	5689	
Laurel C32	2.4	81	01.85 -	L24S	6	0,8	BPR6ES	7822	2	BPR6EIX	6637	
Laurel C32	2.4	93	01.85 -	L24E	6	1,1	BCPR6ES-11	7121	11	BCPR6EIX-11	4919	
Laurel C32	3.0	112	03.86 -	VG30E Cat.	6	0,9	BCPR6EY	1146		BCPR6EIX	5689	
Laurel C32	3.0	122	01.85 -	VG30S	6	1,1	BCP6ES-11	7210		BCPR6EIX-11	4919	
Maxima QX A32	2.0	103	95 - 00	VQ20DE	6	1,1	PFR6G-11	5555				
Maxima QX A32	3.0	141	95 - 00	VQ30DE	6	1,1	PFR6G-11	5555				
Maxima A33	2.0	103	00 -	VQ20DE	6	1,1	PFR6G-11	5555				
Maxima A33	3.0	147	00 -	VQ30DE	6	1,1	PFR6G-11	5555				
Maxima J30	3.0			VG30DE	6	1,1	PFR5C-11	2271				
Maxima J30	3.0	125	10.88 - 95	VG30E	6	1,1	BKR6ES-11	5553	14	BKR6EIX-11	3764	
Micra K9	1.5		04.84 -	TUD5	4	■	Y-731U	5274		D-POWER 9	6281	
Micra K10	1.0	37	12.82 - 92	MA10S	4	0,9	BPR5ES	7422	6	BPR5EIX	6597	
Micra K10	1.0	40	93 -	MA10	4	0,9	BPR5ES	7422	6	BPR5EIX	6597	
Micra K10	1.2	40	01.86 - 93	MA12	4	1,1	BPR5ES-11	4424		BPR5EIX-11	2115	
Micra K10	1.2	42	07.86 - 11.88	MA12S Cat.	4	1,1	BPR5ES-11	4424		BPR5EIX-11	2115	
Micra K10	1.2	44	07.86 - 11.88	MA12S	4	1,1	BPR5ES-11	4424		BPR5EIX-11	2115	
Micra Super S K10	1.3	55	93 -	CG13DE	4	1,1	BKR5E-11	6953	33	BKR5EIX-11	5464	
Micra 16V K11	1.0	40	93 - 00	CG10DE Cat.	4	1,1	BKR5E-11	6953	33	BKR5EIX-11	5464	
Micra K11	1.0	44	00 - 02	CG10DE	4	1,1	BKR5E-11	6953	33	BKR5EIX-11	5464	
Micra 16V K11	1.3	55	93 - 00	CG13DE Cat.	4	1,1	BKR5E-11	6953	33	BKR5EIX-11	5464	
Micra 16 V Sport K11	1.3	60	00 - 02	CGA3DE	4	1,1	BKR5E-11	6953	33	BKR5EIX-11	5464	
Micra K12	1.2	48	02.03 -	CR12DE	4	1,1	LFR5AP-11	4775				
Micra K12	1.2	59	02.03 -	CR12DE	4	1,1	LFR5AP-11	4775				
Micra K12	1.4	65	02.03 -	CR14DE	4	1,1	LFR5AP-11	4775				
Micra dCi K12	1.5	48	04.03 -	K9K	4	■	Y-515J	1019		D-POWER 18	6892	
Micra dCi K12	1.5	60	09.03 -	K9K	4	■	Y-515J	1019		D-POWER 18	6892	
Micra C+C K12	1.6	81	06 -		4	1,1	LFR5AP-11	4775				
Micra K12	1.6	81	07.05 -		4	1,1	LFR5AP-11	4775				

<sup>1)</sup> Bic = Best in class



l kW

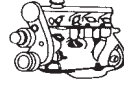

Cyl.

Order-  
No. No.Bic<sup>1)</sup> Order-  
D-Power No.**NISSAN**

Micra SR160 K12	1.6	85	07-	HR16DE	4	1,1	PLZKAR6A-11	5118			
Murano 3.5 E51 /NE51	3.5	172	12.02-	VQ35DE	6	1,1	PLFR5A-11	6240			
Nomad	2.0			LD20			☑ CY51	2696			
Note	1.4	65	03.06-		4	1,1	LFR5AP-11	4775			
Note	1.6	81	03.06-		4	1,1	PLFR5A-11	6240			
Note	1.6	85	03.06-	HR16DE	4	1,1	PLZKAR6A-11	5118			
Pathfinder D21	2.0			Z20S	4	0,8	BPR6ES	7822	2	BPR6EIX	6637
Pathfinder D21	2.4			KA24	6	1,1	ZFR5E-11	4435			
Pathfinder D21	2.4			Z24S	6	0,8	BPR6ES	7822	2	BPR6EIX	6637
Pathfinder D21	2.4			Z24i	6	0,9	BPR5ES	7422	6	BPR5EIX	6597
Pathfinder D21	2.5		93-	TD25	4		☑ Y-707RS	4937			
Pathfinder D21	2.7		93-	TD27	4		☑ Y-707RS	4937			
Pathfinder D21	2.7		93-	TD27T	4		☑ Y-712RS	6140			
Pathfinder D21	3.0		92-	VG30E	6	0,9	BKR6EY	3696		BKR6EIX	6418
Pathfinder D21	3.0			VG30i	6	1,1	BCPR5ES-11	3524		BCPR5EIX-11	3306
Pathfinder R50	3.3	110	97- 00	VG33E V6	6	1,1	BKR5ES-11	2382	33	BKR5EIX-11	5464
Pathfinder R50	3.3	110	92-12.00	VG33E V6	6	1,1	BKR5E-11	6953	33	BKR5EIX-11	5464
Pathfinder R50	3.5	162	01.00-	VQ35E V6	6	1,1	PLFR5A-11	6240			
Pathfinder R51M	4.0	198	09.05-	VQ40DE	6	1,1	LFR5AIX-11	4469			
Patrol Y60 & 260	2.0		04.89-	RB30S	4	0,9	BKR6E	6962	28	BKR6EIX	6418
Patrol	2.7		02.93-	TD27	6		☑ Y-707RS	4937			
Patrol / 160/ Y60 (4,5,6 Cyl CX51.) (1,2,3 Cyl.CZ51)	2.8			RD28T	6		☑ CX51+	2896+			
							☑ CZ51	3209			
Patrol 260	2.8	88	02.87-03.89	L28	6	0,8	BPR6ES	7822	2	BPR6EIX	6637
Patrol 160	2.8	88	07.80-08.88	L28	6	0,8	BPR6ES	7822	2	BPR6EIX	6637
Patrol Y61 (4,5,6 Cyl CX51.) (1,2,3 Cyl.CZ51)	2.8	95	04.98-	RD28 only if NGK is OE	6		☑ CX51+	2896+			
							☑ CZ51	3209			
Patrol 3.0 Di Y61	3.0	116	05.00-	ZD30DDTi only if NGK is OE	6		☑ CZ71	6836			
Patrol	3.3		11.84-	SD33 12V	6		☑ Y-705RS	1249			
Patrol	3.3		11.84-	SD33 24V	6		☑ Y-755RS	7771			
Patrol	3.3		11.84-	SD33T 12V	6		☑ Y-705RS	1249			
Patrol	3.3		11.84-	SD33T 24V	6		☑ Y-755RS	7771			
Patrol 160	4.2		-12.98	TD42 24V	6		☑ Y-757RS	4018			
Patrol Y60	4.2		93-	TB42E	6	0,9	BPR5E	7281	6	BPR5EIX	6597
Patrol	4.2			TD42 12V	6		☑ Y-707RS	4937			
Patrol 160	4.2		-12.98	TD42 12V	6		☑ Y-707RS	4937			
Patrol Y60	4.2		95-	TB42S	6	0,7	BP6ES	7811	4	BPR6EIX	6637
Patrol Y60	4.2		93- 94	RB42S	6	0,9	BPR5E	7281	6	BPR5EIX	6597
Patrol	4.2		- 92	TB42S	6	0,8	BP5ES	6511	8	BPR5EIX	6597
Patrol	4.2			TD42 24V	6		☑ Y-757RS	4018			
Patrol	4.5		98-	TB45E	6	1,1	BPR5E-11	5638		BPR5EIX-11	2115
Pick Up B120	1.2		93-	A12	4	0,8	BP5ES	6511	8	BPR5EIX	6597
Pick Up B120	1.2			A12S	4	0,9	BPR5ES	7422	6	BPR5EIX	6597
Pick Up B120	1.5			A15S	4	0,9	BPR5ES	7422	6	BPR5EIX	6597
Pick Up D21	1.6		09.85-	Z16	4	0,8	BPR6ES	7822	2	BPR6EIX	6637
Pick Up D21	2.0		04.92-	Z20S	4	0,8	BPR6ES	7822	2	BPR6EIX	6637
Pick Up D21	2.0		09.85-04.92	Z20	4	0,8	BPR6ES	7822	2	BPR6EIX	6637
Pick Up 720	2.2	71	03.86-04.93	Z22	4	0,7	BP6ES	7811	4	BPR6EIX	6637
Pick-Up 720	2.3		87-	SD23	4		☑ Y-705RS	1249			
Pick Up D21	2.4	74	09.85-04.92	Z24	4	0,8	BPR6ES	7822	2	BPR6EIX	6637
Pick Up D21	2.4	76	10.88-04.92	Z24i	4	0,8	BPR6ES	7822	2	BPR6EIX	6637
Pick Up D22	2.4	88	98- 01	KA24E	4	1,1	ZFR5E-11	4435			

<sup>1)</sup> Bic = Best in class



ℓ kW

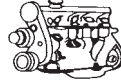

Cyl.

Order-  
No. No.Bic<sup>1)</sup> Order-  
D-Power No.**NISSAN**

Pick Up	MD21	2.4	93	94 - 98	KA24E	4	1,1	ZFR5E-11	4435			
Pick Up	D22	2.4	98	02 -	KA24E	4	1,1	BKR6E-11	2756	14	BKR6EIX-11	3764
Pick-Up	720	2.5		87 -	SD25	4	█	Y-705RS	1249			
Pick-Up	720	2.5			TD25	4	█	Y-707RS	4937			
Pick-Up	720	2.7			TD27	4	█	Y-707RS	4937			
Pick-Up		2.7			TD27T	4	█	Y-712RS	6140			
Pick Up		3.0		93 -	VG30E	6	0,9	BKR6EY	3696		BKR6EIX	6418
Pick Up		3.0		90 -	VG30I	6	1,1	BCPR5ES-11	3524		BCPR5EIX-11	3306
Prairie	M10	1.5	51	01.83 - 09.88	E15S	4	0,9	BPR5ES	7422	6	BPR5EIX	6597
Prairie	M10	1.8	66	07.83 - 09.88	CA18S	4	0,8	BPR6ES	7822	2	BPR6EIX	6637
Prairie	M10	2.0	67	01.86 - 09.88	CA20S	4	0,8	BPR6ES	7822	2	BPR6EIX	6637
Prairie	M11	2.0		90 - 92	CA20S	4	0,8	BCPR6ES	2330	12	BCPR6EIX	5689
Prairie	M11	2.0	67	10.88 - 89	CA20S	4	0,8	BPR6ES	7822	2	BPR6EIX	6637
Prairie	M11	2.0	98	93 - 95	CA20S	4	0,7	BCP6ES	4930	17	BCPR6EIX	5689
Prairie	M11	2.4	98	94 - 95	KA24E		1,1	ZFR5E-11	4435			
Prairie	M11	3.0	98	92 - 95	KA24E	4	1,1	ZFR5E-11	4435			
Prairie 4 x EX + 4 x IN	M10	2.0	72	01.86 - 09.88	CA20E Twin Spark Cat.	4	1,1	BCPR5ES-11+	3524+		BCPR5EIX-11+	3306+
								BCPR6ES-11	7121		BCPR6EIX-11	4919
Prairie 4 x EX + 4 x IN	M11	2.0	72	10.88 - 92	CA20E Twin Spark Cat.	4	1,1	BCPR5ES-11+	3524+		BCPR5EIX-11+	3306+
								BCPR6ES-11	7121		BCPR6EIX-11	4919
Prairie 4 x EX + 4 x IN	M11	2.0	73	10.88 - 92	CA20E Twin Spark	4	1,1	BCPR5ES-11+	3524+		BCPR5EIX-11+	3306+
								BCPR6ES-11	7121		BCPR6EIX-11	4919
Prairie 4 x EX + 4 x IN	M11	2.0	98	93 - 95	CA20E Twin Spark	4	1,1	BCPR5ES-11+	3524+		BCPR5EIX-11+	3306+
								BCPR6ES-11	7121		BCPR6EIX-11	4919
President	H250	4.4		93 -	Y44S	6	0,9	BP4ES	6928			
Primastar	J4	2.0	88	03 -	F4R	4	0,9	BKR6EZ	4619		BKR6EIX	6418
Primera	P10	1.6	66	93 -	GA16DS	4	0,9	BKR6EY	3696		BKR6EIX	6418
Primera	P10	1.6	66	93 - 96	GA16DE	4	0,8	BKR5E	7938	35	BKR5EIX	6341
Primera	P10	2.0	85	93 - 96	SR20DE	4	0,9	BKR5EY	7390		BKR5EIX	6341
Primera	P10E	1.6	66	06.90 - 93	GA16DS Cat.	4	0,9	BKR6E	6962	28	BKR6EIX	6418
Primera	P10E	1.6	70	06.90 - 92	GA16DS	4	0,9	BKR6E	6962	28	BKR6EIX	6418
Primera	P10E	2.0	55	01.91 - 06.96	CD20	4	█	CY52	3017			
Primera	P10E	2.0	85	06.90 - 96	SR20Di	4	0,9	BKR5EY	7390		BKR5EIX	6341
Primera	P10E	2.0	89	06.90 - 96	SR20Di SPI	4	0,9	BKR5EY	7390		BKR5EIX	6341
Primera	P10E	2.0	110	06.90 - 96	SR20DE EGI Cat.	4	0,9	BKR6EY	3696		BKR6EIX	6418
Primera	P11	1.6	66	96 -	GA16DE	4	0,9	BKR6E	6962	28	BKR6EIX	6418
Primera 16V	P11	1.6	74	09.96 - 00	GA16DE	4	0,8	BKR5E	7938	35	BKR5EIX	6341
Primera	P11	1.6	78	02.00 - 07.02	QG16DE	4	1,1	BKR5E-11	6953	33	BKR5EIX-11	5464
Primera	P11	1.8	83	02.00 - 02	QG18DE	4	1,1	BKR5E-11	6953	33	BKR5EIX-11	5464
Primera 16V	P11	2.0	85	09.96 - 99	SR20DE	4	1,1	BKR5EY-11	2355		BKR5EIX-11	5464
Primera	P11	2.0	91	96 - 99	SR20DE	4	0,9	BKR5EY	7390		BKR5EIX	6341
Primera 16V	P11	2.0	96	09.96 - 99	SR20DE	4	1,1	BKR5EY-11	2355		BKR5EIX-11	5464
Primera	P11	2.0	103	00 - 02	SR20DE	4	1,1	PFR6G-11	5555			
Primera	P11	2.0	109	96 - 99	SR20DE	4	0,9	BKR5EY	7390		BKR5EIX	6341
Primera	P11	2.0	110	06.97 - 99	SR20DE	4	0,9	BKR6EY	3696		BKR6EIX	6418
Primera	P12	1.8	85	03.02 -	QG18DE	4	1,1	LFR5A-11	6376			
Primera Traveller	P12	1.8	85	03.02 -	QG18DE	4	1,1	LFR5A-11	6376			
Primera 1.9 dCi	P12	1.9	88	09.03 -	F9Q...	4	█	Y-515J	1019		D-POWER 18	6892
Primera	P12	2.0	103	03.02 -	QR20DE	4	1,1	LFR5A-11	6376			
Primera Di	P12	2.2	93	03.02 -	YD22ET	4	█	Y-519J	2500			
Primera	W10	1.6	66	07.90 - 93	GA16DS Cat.	4	0,9	BKR6E	6962	28	BKR6EIX	6418
Primera	W10	1.6	66	93 - 97	GA16DE	4	0,9	BKR5EY	7390		BKR5EIX	6341

<sup>1)</sup> Bic = Best in class



l kW

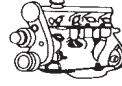

Cyl.

Order-  
No. No.Bic<sup>1)</sup> Order-  
D-Power No.**NISSAN**

Primera W10	1.6	66	93-	GA16DS	4	0,9	BKR6E	6962	28	BKR6EIX	6418
Primera W10	1.6	70	07.90- 93	GA16DS	4	0,9	BKR6E	6962	28	BKR6EIX	6418
Primera / Wagon W10	2.0	55	07.90-04.96	CD20	4	█	CY52	3017			
Primera W10	2.0	85	07.90- 96	SR20Di	4	0,9	BKR5EY	7390		BKR5EIX	6341
Primera W10	2.0	89	07.90- 96	SR20Di SPI	4	0,9	BKR5EY	7390		BKR5EIX	6341
Primera GT (made in UK)	2.0	110	04.97-	SR20DE	4	1,1	BKR5EY-11	2355		BKR5EIX-11	5464
Primera HP12	2.0		08.01-06.03	SR20VE	4	0,9	PLFR6A-9	4342			
Primera Wagon WHP12	2.0		08.01-06.03	SR20VE	4	0,9	PLFR6A-9	4342			
Pulsar N13	1.0	37	06.86-	E10S	4	0,8	BP5ES	6511	8	BPR5EIX	6597
Pulsar N13	1.3	50	06.86-	E13S	4	0,8	BP5ES	6511	8	BPR5EIX	6597
Pulsar N13	1.4		10.88-	GA14S	4	0,7	BCP6ES	4930	17	BCPR6EIX	5689
Pulsar N13	1.6		10.88-	GA16S	4	0,7	BCP6ES	4930	17	BCPR6EIX	5689
Pulsar N13	1.6	54	06.86-	E16i Cat.	4	1,1	BPR6ES-11	4824	13	BPR6EIX-11	3903
Pulsar N13	1.6	62	06.86-	E16S	4	0,8	BPR6ES	7822	2	BPR6EIX	6637
Pulsar N13	1.6	62	06.86-	E16i	4	1,1	BPR6ES-11	4824	13	BPR6EIX-11	3903
Pulsar N13	1.6	81	02.87-10.88	CA16D DOHC Cat.	4	1,1	PFR6A-11	4045			
Pulsar N13	1.6	88	02.87-10.88	CA16D DOHC	4	1,1	BCPR6ES-11	7121	11	BCPR6EIX-11	4919
Pulsar N13	1.8	92	10.88-	CA18D DOHC	4	1,1	PFR6A-11	4045			
Pulsar / Cherry / N13	1.7	41	05.86-08.90	CD17	4	█	CY51	2696			
Pulsar NX	1.6		90-	GA16i	4	1,1	BCPR5ES-11	3524		BCPR5EIX-11	3306
Qashqai 1.6	1.6	84	02.07-	HR16DE	4	1,1	PLZKAR6A-11	5118			
QX4	3.5		01-	VQ35DE	6	1,1	PFR5G-11	2647			
Sentra	1.7		87-	CD17	4	█	CY51	2696			
Serena C23	1.6	71	07.93-	GA16DE Cat.	4	0,8	BKR5E	7938	35	BKR5EIX	6341
Serena C25/NC25	2.0		05.05-	MR20DE	4	1,1	LZKAR6AP-11	6643			
Serena C23M	2.0	49	07.92-01.96	LD20	4	█	CY51	2696			
Serena C23	2.0	93	01.92-	SR20DE Cat.	4	0,9	BKR5EY	7390		BKR5EIX	6341
Serena C23	2.3	55	01.95-02.98	LD23	4	█	Y-712RS	6140			
Silvia S12	2.0	107	10.83-	CA20E	4	0,7	BCP6ES	4930	17	BCPR6EIX	5689
Silvia S12	2.0	107	10.83-	FJ20E	4	1,1	BPR6ES-11	4824	13	BPR6EIX-11	3903
Silvia S12	2.0	111	10.83-	FJ20E	4	1,1	BPR6ES-11	4824	13	BPR6EIX-11	3903
Silvia RS12 4x EX + 4 x IN	1.8	90	89- 95	CA18E	4	1,1	BCPR5ES-11+	3524+		BCPR5EIX-11+	3306+
							BCPR6ES-11	7121		BCPR6EIX-11	4919
Silvia Turbo S12	1.8	90	10.83-	CA18ET Cat.	4	1,1	BCPR6ES-11	7121	11	BCPR6EIX-11	4919
Silvia Turbo S12	1.8	101	10.83-	CA18ET	4	1,1	BCPR6ES-11	7121	11	BCPR6EIX-11	4919
Silvia Turbo 4x EX + 4 x IN S12(CH)	1.8	90	10.83- 95	CA18ET Cat.	4	1,1	BCPR5ES-11+	3524+		BCPR5EIX-11+	3306+
							BCPR6ES-11	7121		BCPR6EIX-11	4919
Skyline	2.0			CA20	4	0,8	BCPR6ES	2330	12	BCPR6EIX	5689
Skyline	2.0	72	09.85-	CA20S	4	0,7	BCP6ES	4930	17	BCPR6EIX	5689
Skyline	2.4			L24E	6	1,1	BPR6ES-11	4824	13	BPR6EIX-11	3903
Skyline	2.4			L24	6	1,1	BPR6ES-11	4824	13	BPR6EIX-11	3903
Skyline	2.6			RB26DETT	6	1,1	PFR7A-11	4579			
Skyline	2.8			L28S	6	0,8	BPR6ES	7822	2	BPR6EIX	6637
Skyline	2.8			L28S	6	0,8	BPR6ES	7822	2	BPR6EIX	6637
Skyline	3.0			RB30S	6	1,1	BCPR6ES-11	7121	11	BCPR6EIX-11	4919
Skyline	3.0			VG30S	6	1,1	BCP6ES-11	7210		BCPR6EIX-11	4919
Skyline / 180K QGS Type 1	2.0		10.81-	LD20	4	█	Y-204RS	4573			
Skyline / 180K QGS Type 1	2.8		10.81-	LD28		█	Y-204RS	4573			
Skyline / 180K QGS Type 2	2.0		10.81-	LD20	4	█	Y-204SS	7629			
Skyline / 180K QGS Type 2	2.8		08.81-	LD28		█	Y-204SS	7629			
Stanza	2.0			CA20S	4	1,1	BCPR6ES-11	7121	11	BCPR6EIX-11	4919
Stanza / T11	1.7			CD17T	4	█	Y-120RS	7463			

<sup>1)</sup> Bic = Best in class





ℓ kW

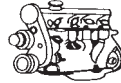

Cyl.

Order-  
No. No.Bic<sup>1)</sup> Order-  
D-Power No.**NISSAN**

Stanza / T11	2.0		87 -	LD20	4	█	CY51	2696				
Stanza 4 x EX + 4 x IN	2.0			CA20 Twin Spark	4	1,1	BPR5ES-11+	4424+			BPR5EIX-11+	2115+
							BPR6ES-11	4824			BPR6EIX-11	3903
Stanza Turbo	1.8			CA18ET	4	1,1	BCPR6ES-11	7121	11		BCPR6EIX-11	4919
Sunny B11	1.5	51	03.82-05.88	E15S	4	0,8	BPR6ES	7822	2		BPR6EIX	6637
Sunny B11	1.6	51	03.85-05.88	E16 Cat.	4	1,1	BPR6ES-11	4824	13		BPR6EIX-11	3903
Sunny B12	1.0	37	01.86-09.88	E10S	4	0,9	BPR5ES	7422	6		BPR5EIX	6597
Sunny B12	1.3	44	01.86 -	E13S	4	0,9	BPR5ES	7422	6		BPR5EIX	6597
Sunny B12	1.4		10.88 -	GA14S	4	0,8	BCPR6ES	2330	12		BCPR6EIX	5689
Sunny B12	1.5	52	01.86-10.88	E15S	4	0,7	BP6ES	7811	4		BPR6EIX	6637
Sunny B12	1.6		01.86-10.88	E16i Cat.	4	1,1	BPR6ES-11	4824	13		BPR6EIX-11	3903
Sunny B12	1.6		06.86-10.88	E16i	4	1,1	BPR6ES-11	4824	13		BPR6EIX-11	3903
Sunny B12	1.6		10.88 -	GA16S	4	0,8	BCPR6ES	2330	12		BCPR6EIX	5689
Sunny B12	1.6	62	10.88 -	CA16S	4	1,1	BPR6ES-11	4824	13		BPR6EIX-11	3903
Sunny B12	1.6	62	06.86-10.88	E16S	4	0,8	BPR6ES	7822	2		BPR6EIX	6637
Sunny B12	1.6	62	10.88 -	CA16S	4	0,8	BCPR6ES	2330	12		BCPR6EIX	5689
Sunny B12	1.6	66	10.88 -	GA16i Cat.	4	1,1	BCPR6ES-11	7121	11		BCPR6EIX-11	4919
Sunny B12	1.7		06.86-08.90	CD17	4	█	CY51	2696				
Sunny B13	1.0		93 -	E10S Cat.	4	0,8	BP5ES	6511	8		BPR5EIX	6597
Sunny B13	1.3		93 -	GA13DS	4	0,9	BKR6E	6962	28		BKR6EIX	6418
Sunny B13	1.4	55	93 -	GA14DS	4	0,9	BKR6E	6962	28		BKR6EIX	6418
Sunny B13	1.6			GA16DS	4	0,9	BKR6E	6962	28		BKR6EIX	6418
Sunny B13	1.6			GA16DE	4	0,9	BKR6E	6962	28		BKR6EIX	6418
Sunny B13	1.7	40	93 - 96	CD17	4	█	CY51	2696				
Sunny B13	2.0		91 -	SR20DE	4	0,9	BKR6EY	3696			BKR6EIX	6418
Sunny B14	1.3		95 -	GA13DS	4	0,9	BKR6E	6962	28		BKR6EIX	6418
Sunny B14	1.3		95 -	GA13DE	4	1,1	BKR6E-11	2756	14		BKR6EIX-11	3764
Sunny B14	1.4		95 -	GA14DE	4	0,9	BKR6E	6962	28		BKR6EIX	6418
Sunny B14	1.6		95 -	GA16DE	4	1,1	BKR6E-11	2756	14		BKR6EIX-11	3764
Sunny B14	1.8		95 -	GA18DE(B)	4	0,9	BKR6E	6962	28		BKR6EIX	6418
Sunny B14	1.8		95 -	GA18DE(A)	4	1,1	BKR6E-11	2756	14		BKR6EIX-11	3764
Sunny B14	2.0			CD20	4	█	CY51	2696				
Sunny B14	2.0		95 -	SR20DE	4	0,8	BKR6EY	3696			BKR6EIX	6418
Sunny B14	2.0	55	10.90 -	CD20	4	█	CY52	3017				
Sunny N13	1.0		10.88 -	E10S	4	0,9	BPR5ES	7422	6		BPR5EIX	6597
Sunny N13	1.0	37	06.86-10.88	E10S	4	0,8	BPR6ES	7822	2		BPR6EIX	6637
Sunny N13	1.3	49	06.86-10.88	E13S	4	0,8	BPR6ES	7822	2		BPR6EIX	6637
Sunny N13	1.4	55	10.88 -	GA14S	4	0,7	BCP6ES	4930	17		BCPR6EIX	5689
Sunny N13	1.5	52	06.86-10.88	E15S	4	0,8	BPR6ES	7822	2		BPR6EIX	6637
Sunny N13	1.6		10.88 -	GA16S	4	0,8	BCPR6ES	2330	12		BCPR6EIX	5689
Sunny N13	1.6	54	06.86 -	E16i Cat.	4	1,1	BPR5ES-11	4424			BPR5EIX-11	2115
Sunny N13	1.6	62	06.86-10.88	E16S	4	0,8	BPR6ES	7822	2		BPR6EIX	6637
Sunny N13	1.6	62	06.86 - 91	E16i	4	1,1	BPR5ES-11	4424			BPR5EIX-11	2115
Sunny N13	1.6	66	10.88 -	GA16i Cat.	4	1,1	BCP6ES-11	7210			BCPR6EIX-11	4919
Sunny N13	1.6	88	02.87-10.88	CA16D DOHC	4	1,1	BCPR6ES-11	7121	11		BCPR6EIX-11	4919
Sunny N13	1.7		06.86-08.90	CD17	4	█	CY51	2696				
Sunny N14	1.4	55	10.90 - 93	GA14DS	4	0,8	BKR5E	7938	35		BKR5EIX	6341
Sunny N14	1.4	55	10.92 - 95	GA14DE	4	0,8	BKR5E	7938	35		BKR5EIX	6341
Sunny N14	1.6	66	10.90 - 93	GA16DS	4	0,9	BKR6E	6962	28		BKR6EIX	6418
Sunny N14	1.6	66	10.92 - 95	GA16DE	4	0,8	BKR5E	7938	35		BKR5EIX	6341
Sunny N14	1.6	75	10.92 -	GA16DE	4	0,8	BKR5E	7938	35		BKR5EIX	6341
Sunny N14	1.7		91 - 91	CD17	4	█	CY52	3017				

<sup>1)</sup> Bic = Best in class



ℓ kW

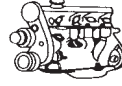

Cyl.

Order-  
No. No.Bic<sup>1)</sup> Order-  
D-Power No.**NISSAN**

Sunny	N14	2.0		95-	SR20DET	4	0,6	PFR7B	4853				
Sunny	N14	2.0	55	10.90-	CD20	4	█	CY52	3017				
Sunny	N15	2.0	55	10.90-	CD20	4	█	CY52	3017				
Sunny	Y10	1.6	66	94-	GA16DS	4	0,9	BKR6E	6962	28	BKR6EIX	6418	
Sunny	Y10	1.6	67	94-	SR16DE	4	0,8	BKR5E	7938	35	BKR5EIX	6341	
Sunny	Y10	1.7	40	93- 96	CD17	4	█	CY51	2696				
Sunny	Y10	2.0	55	10.90-	CD20	4	█	CY52	3017				
Sunny	Y10	2.0	105	93-	GA20DE	4	0,9	BKR6EY	3696		BKR6EIX	6418	
Sunny	Y10L	1.6	66	10.90- 93	GA16DS	4	0,9	BKR6E	6962	28	BKR6EIX	6418	
Sunny	Y10L	1.6	66	10.92- 00	GA16DE	4	0,8	BKR5E	7938	35	BKR5EIX	6341	
Sunny	Y11	1.7	40	05.92-04.98	CD17	4	█	CY51	2696				
Sunny 16V	B12	1.6	88	01.86-09.88	CA16DE	4	1,1	BCPR6ES-11	7121	11	BCPR6EIX-11	4919	
Sunny GTI	B12	1.6	81	01.86-09.89	CA16DE	4	1,1	PFR6A-11	4045				
Sunny GTI	B12	1.8	92	10.89- 91	CA18DE	4	1,1	PFR6A-11	4045				
Sunny GTI	N13	1.6	81	02.87-10.89	CA16DE.	4	1,1	PFR6A-11	4045				
Sunny GTI	N13	1.8	92	10.89- 91	CA18DE	4	1,1	PFR6A-11	4045				
Sunny GTI	N14	2.0	105	10.90-05.95	SR20DE Cat.	4	0,9	BKR6EY	3696		BKR6EIX	6418	
Sunny GTI-R	N14	2.0	162	10.93- 95	SR20DET Cat.	4	0,9	PFR7B-9	4180				
Terrano 1		2.0			Z20S	4	0,8	BPR6ES	7822	2	BPR6EIX	6637	
Terrano 1	WD21	2.4	76	08.87-07.92	Z24i Cat.	6	0,9	BPR5ES	7422	6	BPR5EIX	6597	
Terrano 1	4 x EX + 4 x IN	2.4	76	08.86-	Z24i Twin Spark	4	0,9	BPR5ES	7422	6	BPR5EIX	6597	
Terrano 1		2.5			TD25	4	█	Y-707RS	4937				
Terrano 1		2.7			TD27	4	█	Y-707RS	4937				
Terrano 1	WYD21	3.0	95	08.88- 90	VG30i	6	1,1	BCPR5ES-11	3524		BCPR5EIX-11	3306	
Terrano 1	WD/WHYD21	3.0	109	01.90-07.96	VG30E Cat.	6	0,9	BKR6EY	3696		BKR6EIX	6418	
Terrano 2	R20	2.4	86	05.96- 01	KA24E	6	1,1	ZFR5E-11	4435				
Terrano 2	R20	2.4	87	05.96- 01	KA24E	6	1,1	ZFR5E-11	4435				
Terrano 2	R20	2.4	91	07.93- 96	KA24E	6	1,1	ZFR5E-11	4435				
Terrano 2 not Europe		2.7		07.93-	TD27T	4	█	Y-712RS	6140				
Terrano 2	R20 only Europa	2.7	92	05.96-	TD27T For EU	4	█	CY58	5486				
Terano 2	R20	3.0	113	05.02-	ZD30DDTI only if NGK is OE	6	█	CZ71	6836				
Tino 1.8 16V	V10	1.8	88	99-	NEOQG18DE	4	1,1	BKR5E-11	6953	33	BKR5EIX-11	5464	
Tino 2.0 16V	V10	2.0	99	99-	SR20DE	4	1,1	PFR6G-11	5555				
Tino 2.0 16V	V10	2.2	84	07.00-	YD22DT	4	█	Y-519J	2500				
Trade JX1100		2.0		03.85-	LD20	4	█	Y-204RS	4573				
Trade PF1104		2.0	46	10.87-	LD20IIE	4	█	Y-918R	4182		D-POWER 2	6285	
Urvan	E24	2.0		95-	NA20S	4	1,1	BPR6ES-11	4824	13	BPR6EIX-11	3903	
Urvan	E24	2.0	64	11.86-	Z20 OHC	4	0,9	BPR5ES	7422	6	BPR5EIX	6597	
Urvan	E24	2.4		95-	Z24	6	0,7	BP6ES	7811	4	BPR6EIX	6637	
Urvan	E24	2.4	74	02.87-	Z24S OHC	6	0,9	BPR5ES	7422	6	BPR5EIX	6597	
Urvan	E24	2.4	74	05.89- 96	Z24i	6	0,9	BPR5ES	7422	6	BPR5EIX	6597	
Urvan	E24L	2.5		93-	TD25	4	█	Y-707RS	4937				
Urvan	QGS Type 2	2.0		05.82-	LD20T	4	█	Y-204SS	7629				
Urvan	QGS Type 2	2.3		05.82-	SD23	4	█	Y-112M1	2531				
Urvan / E20 / E23 / E24		2.2		09.80-	SD22	4	█	Y-181T	2728				
Urvan / E20 / E23 / E24		2.2		09.80-	SD22	4	█	Y-112T	6327				
Urvan / E20 / E23 / E24		2.3			TD23	4	█	Y-707RS	4937				
Urvan / E20 / E23 / E24		2.3		05.82-	SD23	4	█	Y-162R1	2431				
Urvan / E20 / E23 / E24		2.7		87-	TD27	4	█	Y-707RS	4937				
Urvan / E20 / E23 / E24 QGS Type 1		2.0		05.82-	LD20T	4	█	Y-204RS	4573				
Urvan / E20 / E23 / E24 QGS Type 1		2.3		05.82-	SD23	4	█	Y-112R1	1032				
Vanette		2.0			CD20	4	█	CY52	3017				

<sup>1)</sup> Bic = Best in class



ℓ kW

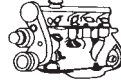

Cyl.

Order-  
No. No.Bic<sup>1)</sup> Order-  
D-Power No.**NISSAN**

Vanette	2.0		93 -	SR20E	4	0,9	BKR5EY	7390		BKR5EIX	6341
Vanette C22	2.4	74	09.86 - 93	Z24i	4	0,9	BPR5ES	7422	6	BPR5EIX	6597
Vanette GC22	1.5	51	09.86 -	A15S	4	0,9	BPR5ES	7422	6	BPR5EIX	6597
Vanette GC22	2.0	64	09.86 -	Z20S	4	0,8	BPR6ES	7822	2	BPR6EIX	6637
Vanette C220	2.0	44	04.87 - 11.94	LD20 II OHV	4	█	CY51	2696			
Vanette C220	2.0	47	01.91 - 11.94	LD20 IIL	4	█	CY51	2696			
Vanette GC22	2.0	47	09.86 - 03.93	LD20 OHV	4	█	CY51	2696			
Vanette Cargo	2.0	49	07.92 - 09.94	LD20 OHV	4	█	CY51	2696			
Vanette Cargo (NL)	1.6	71	03.95 -		4	0,8	BKR5E	7938	35	BKR5EIX	6341
Vanette E (NL)	1.6	71	03.95 -		4	0,8	BKR5E	7938	35	BKR5EIX	6341
X-Trail PNT30	2.0		02.01 -	SR20VET	4	0,9	PLFR6A-9	4342			
X-Trail T30	2.0	103	06.01 -	QR20DE	4	1,1	LFR5A-11	6376			
X-Trail T30	2.5	121	03 -	QR25DE	4	1,1	LFR5A-11	6376			

**NISSAN (Spain)**

L 35 D	2.9	56	05.85 -		6	█	Y-902R	2237		D-POWER 1	7906
Mot. A 4.28 D	2.8	62	09.87 - 05.93	A 4.28	4	█	Y-902R	2237		D-POWER 1	7906
Patrol			-03.88			█	Y-902R	2237		D-POWER 1	7906
Patrol D	2.8	62	09.87 -	A 4.28	4	█	Y-902R	2237		D-POWER 1	7906
Trade D	2.8	62	09.87 -	A 4.28	4	█	Y-902R	2237		D-POWER 1	7906

**OLDSMOBILE**

Delta 88	3.8		94 - 94	V6 SFI L	6	1,5	TR55	1048		TR55IX	7164
Delta 88	3.8		95 - 95	V6 MFI K	6	1,5	TR55	1048		TR55IX	7164
Delta 88	3.8		96 - 99	V6 MFI K	6	1,5	PTR4B-15	5146			
Delta 88	3.8		95 - 95	V6 MFI 1 SC	6	1,5	TR55	1048		TR55IX	7164
Intrigue	3.5		99 -	V6 MFI H	6	1,3	TR55	1048		TR55IX	7164
Intrigue	3.8		98 - 99	V6 MFI K	6	1,5	PTR4B-15	5146			
LSS	3.8		96 - 99	V6 MFI 1 SC	6	1,5	PTR4B-15	5146			
LSS	3.8		96 - 99	V6 MFI K	6	1,5	PTR4B-15	5146			

**OPEL**

Agila 12V	1.0	43	07.00 -	Z10XE	3	0,8	BKR5EK	7956	23	BKR5EIX	6341
Agila 12V	1.0	44	04 -	Z10XEP	3	1,1	ZFR5F-11	2262		ZFR5FIX-11	2477
Agila 16V	1.2	55	07.00 -	Z12XE	4	0,8	BKR5EK	7956	23	BKR5EIX	6341
Agila 16V	1.2	59	07.04 -	Z12XEP	4	1,1	ZFR5F-11	2262		ZFR5FIX-11	2477
Agila 1.3 CDTI	1.3	51	08.03 -	Z13DT	4	█	YE06	5285			
Arena 1.9D	1.9	44	01.98 -	F8Q M6	4	█	Y-506R	4409		D-POWER 7	2419
Arena 2.5D	2.5	55	07.98 - 02.01	S8U V7	4	█	Y-908R	4585		D-POWER 1	7906
Ascona B	1.3	55	08.79 - 08.88	13S OHC	4	0,8	BPR6ES	7822	2	BPR6EIX	6637
Ascona B	1.6	51	09.81 - 08.88	16N OHC II	4	0,8	BPR6ES	7822	2	BPR6EIX	6637
Ascona C	1.6	40	03.82 - 09.88	16 D, DA OHC	4	█	Y-924U	4950		D-POWER 1	7906
Ascona C	1.6	55	09.87 - 08.88	C16NZ	4	0,9	BPR5ES	7422	6	BPR5EIX	6597
Ascona C	1.6	55	09.87 - 09.88	E16NZ OHC	4	0,8	BPR6ES	7822	2	BPR6EIX	6637
Ascona C	1.6	60	09.81 - 09.88	16SV OHC	4	0,8	BPR6ES	7822	2	BPR6EIX	6637
Ascona C	1.6	60	09.81 - 08.88	16SH OHC	4	0,8	BPR6ES	7822	2	BPR6EIX	6637
Ascona C	1.8	62	09.87 - 09.88	E18NV OHC II	4	0,8	BPR6ES	7822	2	BPR6EIX	6637
Ascona C	1.8	82	09.86 - 09.88	18SE OHC II	4	0,8	BPR6ES	7822	2	BPR6EIX	6637
Ascona C	2.0	85	09.86 - 09.88	20NE	4	0,9	BPR5ES	7422	6	BPR5EIX	6597
Ascona C	2.0	85	09.86 - 09.88	C20NE OHC	4	0,9	BPR5ES	7422	6	BPR5EIX	6597
Ascona C	2.0	95	03.87 - 09.88	20SEH OHC II	4	0,8	BPR6ES	7822	2	BPR6EIX	6637
Astra F	1.4	44	08.96 - 02.98	X14NZ OHC I	4	0,8	BKR5EK	7956	23	BKR5EIX	6341

! Fahrzeuge mit Aluschutzrohr SW 16  
Fahrzeuge ohne Aluschutzrohr SW 21BKR5EK = V-Linie 23  
BPR5ES = V-Linie 6! Cars with protection tube Hex 16  
Cars without protection tube Hex 21BKR5EK = V-Linie 23  
BPR5ES = V-Linie 6<sup>1)</sup> Bic = Best in class

\* only by car dealer



ℓ kW

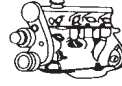

Cyl.

Order-  
No. No.Bic<sup>1)</sup> Order-  
D-Power No.**OPEL**

Astra F	1.4	44	08.95 - 02.98	C14NZ OHC I	4	0,8	BKR5EK	7956	23	BKR5EIX	6341
Astra F	1.4	44	09.91 - 07.95	C14NZ OHC 1	4	0,9	BPR5ES	7422	6	BPR5EIX	6597
Astra F	1.4	55	09.91 - 03.93	14NV OHC 1	4	0,8	BKR5EK	7956	23	BKR5EIX	6341
Astra F	1.4	60	03.93 - 07.95	14SE OHC	4	0,9	BPR5ES	7422	6	BPR5EIX	6597
Astra F	1.4	60	08.95 - 02.98	14SE OHC	4	0,8	BKR5EK	7956	23	BKR5EIX	6341
Astra F	1.4	60	08.95 - 02.98	C14SE OHC	4	0,8	BKR5EK	7956	23	BKR5EIX	6341
Astra F	1.4	60	09.91 - 07.95	C14SE OHC	4	0,9	BPR5ES	7422	6	BPR5EIX	6597
Astra F	1.4	66	02.96 - 02.98	X14XE DOHC	4	0,8	BKR5EK	7956	23	BKR5EIX	6341
Astra F	1.6	52	04.94 - 12.94	X16SZ OHC	4	0,9	BPR5ES	7422	6	BPR5EIX	6597
Astra F	1.6	52	03.93 - 03.94	X16SZ OHC	4	0,9	BPR5ES	7422	6	BPR5EIX	6597
Astra F	1.6	52	01.95 - 02.96	X16SZ OHC	4	0,8	BKR5EK	7956	23	BKR5EIX	6341
Astra F	1.6	55	09.97 -	16NZR OHC	4	0,8	BKR5EK	7956	23	BKR5EIX	6341
Astra F	1.6	55	02.96 - 08.00	X16SZR OHC	4	0,8	BKR5EK	7956	23	BKR5EIX	6341
Astra F	1.6	55	09.91 - 07.95	C16NZ OHC	4	0,9	BPR5ES	7422	6	BPR5EIX	6597
Astra F	1.6	55	08.95 - 02.96	C16NZ OHC	4	0,8	BKR5EK	7956	23	BKR5EIX	6341
Astra F	1.6	55	08.94 - 02.98	16LZ2 OHC	4	0,8	BKR5EK	7956	23	BKR5EIX	6341
Astra F	1.6	74	08.94 - 02.98	X16XEL DOHC	4	0,8	BKR5EK	7956	23	BKR5EIX	6341
Astra F	1.6	74	08.95 - 02.98	C16SE OHC I	4	0,8	BKR5EK	7956	23	BKR5EIX	6341
Astra F	1.6	74	02.92 - 07.95	C16SE OHC I	4	0,9	BPR5ES	7422	6	BPR5EIX	6597
Astra F	1.7	42	09.91 - 09.92	17 D OHC II	4	█	Y-924U	4950		D-POWER 1	7906
Astra F	1.7	44	09.92 - 08.94	17 DR	4	█	Y-924U	4950		D-POWER 1	7906
Astra F Eco D	1.7	50	08.94 - 02.98	X17 DTL	4	█	Y-924U	4950		D-POWER 1	7906
Astra F TD	1.7	60	12.91 - 02.98	17DT TC4 EE1	4	█	CY03	4315		D-POWER 8	6160
				OHC Isuzu Mot.956633-->							
Astra F TD	1.7	60	04.96 - 02.98	X17DT TC4 EE1	4	█	CY03	4315		D-POWER 8	6160
				OHC Isuzu Mot.956633-->							
Astra F	1.8	66	08.95 - 02.98	C18NZ OHC II	4	0,8	BKR5EK	7956	23	BKR5EIX	6341
Astra F	1.8	66	09.91 - 07.95	C18NZ OHC II	4	0,9	BPR5ES	7422	6	BPR5EIX	6597
Astra F 16V	1.8	85	02.96 - 02.98	X18XE DOHC	4	0,8	BKR5EK	7956	23	BKR5EIX	6341
Astra F 16V	1.8	85	02.94 - 03.96	C18XEL DOHC	4	0,8	BKR5EK	7956	23	BKR5EIX	6341
Astra F 16V	1.8	92	05.93 - 04.94	C18XE DOHC II	4	0,8	BKR5EK	7956	23	BKR5EIX	6341
Astra F	2.0	85	08.95 - 02.98	C20NE OHC II	4	0,8	BKR5EK	7956	23	BKR5EIX	6341
Astra F	2.0	85	09.91 - 07.95	C20NE OHC II	4	0,9	BPR5ES	7422	6	BPR5EIX	6597
Astra F 16V	2.0	100	02.95 - 02.98	X20XE DOHC	4	0,8	BKR5EK	7956	23	BKR5EIX	6341
Astra F 16V	2.0	110	09.92 - 02.98	C20XE-LN DOHC I	4	0,8	BKR5EK	7956	23	BKR5EIX	6341
Astra F 16V	2.0	110	09.91 - 08.92	C20XE-LN DOHC I	4	0,8	BKR6EK	2288	20	BKR6EQUP	3199
Astra F 16V	2.0	110	09.92 - 02.98	C20XE DOHC	4	0,8	BKR5EK	7956	23	BKR5EIX	6341
Astra F 16V	2.0	110	09.91 - 08.92	C20XE DOHC	4	0,8	BKR6EK	2288	20	BKR6EQUP	3199
Astra G 16V	1.2	48	03.98 - 00	X12XE DOHC	4	0,8	BKR5EK	7956	23	BKR5EIX	6341
Astra G	1.2	55	08.00 -	Z12XE	4	0,8	BKR5EK	7956	23	BKR5EIX	6341
Astra G	1.4	66	08.00 -	Z14XE DOHC	4	0,8	BKR5EK	7956	23	BKR5EIX	6341
Astra G 16V	1.4	66	03.98 -	X14XE DOHC	4	0,8	BKR5EK	7956	23	BKR5EIX	6341
Astra G 16V	1.6	55	03.98 - 08.00	X16SZR	4	0,8	BKR5EK	7956	23	BKR5EIX	6341
Astra G	1.6	62	08.00 -	Z16SE	4	0,8	BKR5EK	7956	23	BKR5EIX	6341
Astra G	1.6	74	12.02 -	Z16XEP	4	1,1	ZFR5F-11	2262		ZFR5FIX-11	2477
Astra G 16V	1.6	74	08.00 -	Z16XE	4	0,8	BKR5EK	7956	23	BKR5EIX	6341
Astra G 16V	1.6	74	03.98 -	X16XEL	4	0,8	BKR5EK	7956	23	BKR5EIX	6341
Astra G D	1.7	50	02.98 -	X17DTL	4	█	Y-924U	4950		D-POWER 1	7906
Astra G DTI 16V	1.7	55	09.99 -	Y17DT	4	█	Y-541J	4617		D-POWER 42	1983
Astra G 16V	1.8	85	03.98 -	X18XE1	4	0,8	BKR5EK	7956	23	BKR5EIX	6341
Astra G 16V	1.8	92	08.00 -	Z18XE	4	0,8	BKR5EK	7956	23	BKR5EIX	6341
Astra G DTI 16V	2.0	60	02.98 -	X20DTL SOHC	4	█	Y-748U	5000		D-POWER 14	6649

! Fahrzeuge mit Aluschutzrohr SW 16  
 Fahrzeuge ohne Aluschutzrohr SW 21  
<sup>1)</sup> Bic = Best in class

BKR5EK = V-Linie 23  
 BPR5ES = V-Linie 6

139

! Cars with protection tube Hex 16  
 Cars without protection tube Hex 21  
 \* only by car dealer

BKR5EK = V-Linie 23  
 BPR5ES = V-Linie 6



ℓ kW

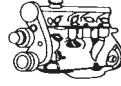

Cyl.

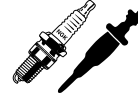
Order-  
No. No.Bic<sup>1)</sup> Order-  
D-Power No.**OPEL**

Astra G DTI II	2.0	60	08.00 -	Y20DTL	4	■	Y-748U	5000		D-POWER 14	6649
Astra G DTI II 16V	2.0	74	08.00 -	Y20DTH	4	■	Y-523J	3703		D-POWER 37	6298
Astra G 16V	2.0	100	03.98 -	X20XEV	4	0,8	BKR5EK	7956	23	BKR5EIX	6341
Astra G 16V	2.0	118	10.99 - 09.02	X20XER DOHC	4	0,8	BKR5EK	7956	23	BKR5EIX	6341
Astra G 16V Turbo	2.0	140	09.00 -	Z20LET	4	0,8	BKR5EK	7956	23	BKR5EIX	6341
Astra G	2.2	92	03 -	Y22DTR	4	■	Y-523J	3703		D-POWER 37	6298
Astra G 16V	2.2	108	01.99 -	X22XE DOHC	4	0,8	BKR5EK	7956	23	BKR5EIX	6341
Astra H	1.4	55	03.04 -	Z14XEL	4	1,1	ZFR5F-11	2262		ZFR5FIX-11	2477
Astra H	1.4	66	03.04 -	Z14XEP	4	1,1	ZFR5F-11	2262		ZFR5FIX-11	2477
Astra H	1.6	71	08.06 -	Z16YNG	4		BKR6EIX-LPG	3356			
Astra H	1.6	74	03.04 -	Z16XEP	4	1,1	ZFR5F-11	2262		ZFR5FIX-11	2477
Astra H	1.6	132	03.07 -	Z16LET	4	1,0	PFR6T-10G	5542			
Astra H CDTI	1.7	59	03.04 -	Z17DTL	4	■	Y-541J	4617		D-POWER 42	1983
Astra H CDTI	1.7	74	03.04 -	Z17DTH	4	■	Y-541J	4617		D-POWER 42	1983
Astra H	1.8	92	03.04 -	Z18XE	4	1,1	ZFR5F-11	2262		ZFR5FIX-11	2477
Astra H	1.8	103	05.06 -	Z18XER	4	1,1	ZFR5F-11	2262		ZFR5FIX-11	2477
Astra H CDTI	1.9	74	06.05 -	Z19DTL Fiat	4	■	YE07	6092			
Astra H CDTI	1.9	88	04.05 -	Z19DTJ Fiat	4	■	YE07	6092			
Astra H CDTI	1.9	88	04.04 -	Z19DT Fiat	4	■	YE07	6092			
Astra H CDTI 16V	1.9	110	09.04 -	Z19DTH Fiat	4	■	YE07	6092			
Astra H Turbo	2.0	125	03.04 -	Z20LEL	4	0,7	ZFR5F	5165		ZFR5FIX-11	2477
Astra H GTC Turbo	2.0	147	03.05 -	Z20LER	4	0,7	ZFR5F	5165		ZFR5FIX-11	2477
Astra H OPC Turbo	2.0	177	09.05 -	Z20LEH	4	0,8	PFR6T-G	6314			
Bedford Blitz D		46	09.80 -		4	■	Y-208T	1250			
Calibra	2.0	85	08.95 - 08.97	C20NE OHC II	4	0,8	BKR5EK	7956	23	BKR5EIX	6341
Calibra	2.0	85	06.90 - 07.95	C20NE OHC II	4	0,9	BPR5ES	7422	6	BPR5EIX	6597
Calibra 16V	2.0	100	11.93 - 08.97	X20XEV DOHC	4	0,8	BKR5EK	7956	23	BKR5EIX	6341
Calibra 16V	2.0	110	06.90 - 04.97	C20XE-LN DOHC	4	0,8	BKR6EK	2288	20	BKR6EQUP	3199
Calibra 16V	2.0	110	02.90 - 08.92	C20XE	4	0,8	BKR6EK	2288	20	BKR6EQUP	3199
Calibra 16V	2.0	110	09.92 - 02.94	C20XE	4	0,8	BKR5EK	7956	23	BKR5EIX	6341
Calibra Turbo	2.0	150	03.92 - 08.97	C20LET DOHC	4	1,1	ZFR6F-11	4291		ZFR6FIX-11	6441
Calibra	2.5	125	09.93 - 08.97	C25XE DOHC	6	0,8	BKR5EK	7956	23	BKR5EIX	6341
Campo	2.3	66	11.88 - 09.91	4ZD1	4	0,8	BPR6ES	7822	2	BPR6EIX	6637
Campo	2.3	72	08.94 - 08.95	4ZD1	4	0,8	BPR6ES	7822	2	BPR6EIX	6637
Campo TDS	3.1	80	09.92 -	4JG2T (31 TD/TDS)	4	■	Y-719RS1	6900			
Combo CDTI	1.3	51	10.04 -	Y13DT	4	■	YE06	5285			
Combo CDTI	1.3	55	10.05 -	Y13DTJ	4	■	YE06	5285			
Combo	1.4	44	02.96 - 10.01	X14SZ OHC	4	0,8	BKR5EK	7956	23	BKR5EIX	6341
Combo	1.4	44	03.93 - 10.01	C14NZ OHC	4	0,8	BKR5EK	7956	23	BKR5EIX	6341
Combo	1.4	60	03.93 - 10.01	C14SE OHC	4	0,8	BKR5EK	7956	23	BKR5EIX	6341
Combo	1.4	66	10.04 -	Z14XEP	4	0,7	ZFR5F	5165		ZFR5FIX-11	2477
Combo	1.6	64	10.01 -	Z16SE	4	0,8	BKR5EK	7956	23	BKR5EIX	6341
Combo CNG	1.6	69	05 -	Y16YNG	4		BKR6EIX-LPG	3356			
Combo CNG	1.6	71	08.05 -	Z16YNG	4		BKR6EIX-LPG	3356			
Combo	1.7	44	04.96 - 10.01	X17D (4EE1)/OHC	4	■	CY03	4315		D-POWER 8	6160
Combo	1.7	44	07.94 - 10.01	17D 4EE1 OHC	4	■	CY03	4315		D-POWER 8	6160
Combo DI 16V	1.7	48	10.01 -	Y17DTL	4	■	Y-541J	4617		D-POWER 42	1983
Combo DTI 16V	1.7	55	10.01 -	Y17DT	4	■	Y-541J	4617		D-POWER 42	1983
Corsa A	1.0	33	09.82 - 09.92	10S OHV	4	0,7	BPR6HS	7022	3	BPR6HIX	4085
Corsa A	1.2	33	02.90 - 03.93	12NV OHC I	4	0,8	BPR6ES	7822	2	BPR6EIX	6637
Corsa A	1.2	33	09.90 - 03.93	C12NZ OHC I	4	0,9	BPR5ES	7422	6	BPR5EIX	6597
Corsa A	1.2	33	03.87 - 06.90	E12GV OHV	4	0,7	BPR6HS	7022	3	BPR6HIX	4085

! Fahrzeuge mit Aluschutzrohr SW 16  
Fahrzeuge ohne Aluschutzrohr SW 21BKR5EK = V-Linie 23  
BPR5ES = V-Linie 6! Cars with protection tube Hex 16  
Cars without protection tube Hex 21BKR5EK = V-Linie 23  
BPR5ES = V-Linie 6<sup>1)</sup> Bic = Best in class

\* only by car dealer



ℓ kW

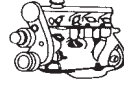

Cyl.

Order-  
No. No.Bic<sup>1)</sup> Order-  
D-Power No.**OPEL**

Corsa A	1.2	37	09.86 - 03.93	A12ST OHC	4	0,8	BPR6ES	7822	2	BPR6EIX	6637
Corsa A	1.2	37	09.82 - 03.93	12S OHC	4	0,8	BPR6ES	7822	2	BPR6EIX	6637
Corsa A	1.2	40	09.84 - 03.93	S12ST OHC	4	0,8	BPR6ES	7822	2	BPR6EIX	6637
Corsa A	1.2	40	09.82 - 02.90	12ST OHC	4	0,8	BPR6ES	7822	2	BPR6EIX	6637
Corsa A	1.3	44	09.85 - 10.89	C13N OHC	4	0,8	BPR6ES	7822	2	BPR6EIX	6637
Corsa A	1.3	44	03.86 - 10.89	13NB OHC	4	0,8	BPR6ES	7822	2	BPR6EIX	6637
Corsa A	1.3	51	09.82 - 03.93	13S OHC	4	0,8	BPR6ES	7822	2	BPR6EIX	6637
Corsa A	1.3	52	09.82 - 10.89	13SB OHC	4	0,8	BPR6ES	7822	2	BPR6EIX	6637
Corsa A Sprint	1.3	61	04.85 - 03.93	13E irmscher	4	0,8	BPR6ES	7822	2	BPR6EIX	6637
Corsa A	1.4	44	10.89 - 03.93	C14NZ OHC I	4	0,9	BPR5ES	7422	6	BPR5EIX	6597
Corsa A	1.4	53	10.89 - 09.92	14NV OHC I	4	0,8	BPR6ES	7822	2	BPR6EIX	6637
Corsa A	1.4	60	09.91 - 03.93	C14SE OHC I	4	0,9	BPR5ES	7422	6	BPR5EIX	6597
Corsa A D (Isuzu-Mot.)	1.5	37	09.87 - 03.93	15 D/4 EC1	4	█	Y-711J	5264		D-POWER 28	4467
Corsa A D (Isuzu-Mot.)	1.5	37	09.87 - 03.93	AAD Motor 804795 --> 15 D/4 EC1	4	█	Y-306R	6244			
Corsa A TD (Isuzu-Mot.)	1.5	49	02.88 - 03.93	AAD --> Motor 804 794 15DT/T4 EC1-	4	█	Y-711J	5264		D-POWER 28	4467
Corsa A	1.6	55	03.88 - 09.91	AADT OHC 804795--> C16NZ	4	0,9	BPR5ES	7422	6	BPR5EIX	6597
Corsa A Irmischer	1.6	72	06.90 - 03.92	C16SEI irmscher	4	0,8	BPR6ES	7822	2	BPR6EIX	6637
Corsa A	1.6	74	02.92 - 03.93	C16SE DOHC	4	0,9	BPR5ES	7422	6	BPR5EIX	6597
Corsa A	1.6	74	03.88 - 03.92	E16SE OHC I	4	0,8	BPR6ES	7822	2	BPR6EIX	6637
Corsa B 12V	1.0	40	03.97 - 08.00	X10XE DOHC	3	0,8	BKR5EK	7956	23	BKR5EIX	6341
Corsa B	1.2	33	03.93 - 07.95	C12NZ OHC I	4	0,9	BPR5ES	7422	6	BPR5EIX	6597
Corsa B	1.2	33	08.95 - 12.97	C12NZ OHC I	4	0,8	BKR5EK	7956	23	BKR5EIX	6341
Corsa B	1.2	33	03.93 - 07.95	X12SZ OHC	4	0,9	BPR5ES	7422	6	BPR5EIX	6597
Corsa B	1.2	33	03.93 - 07.95	12NZ	4	0,9	BPR5ES	7422	6	BPR5EIX	6597
Corsa B	1.2	33	08.95 - 12.97	12NZ	4	0,8	BKR5EK	7956	23	BKR5EIX	6341
Corsa B	1.2	33	08.95 - 03.98	X12SZ OHC	4	0,8	BKR5EK	7956	23	BKR5EIX	6341
Corsa B 16V	1.2	48	09.97 - 08.01	X12XE	4	0,8	BKR5EK	7956	23	BKR5EIX	6341
Corsa B	1.4	44	08.95 - 08.98	C14NZ OHC I	4	0,8	BKR5EK	7956	23	BKR5EIX	6341
Corsa B	1.4	44	03.93 - 07.95	C14NZ OHC I	4	0,9	BPR5ES	7422	6	BPR5EIX	6597
Corsa B	1.4	44	03.96 - 07.00	X14SZ	4	0,8	BKR5EK	7956	23	BKR5EIX	6341
Corsa B	1.4	60	03.93 - 07.95	C14SE OHC I	4	0,9	BPR5ES	7422	6	BPR5EIX	6597
Corsa B	1.4	60	08.95 - 07.97	C14SE OHC I	4	0,8	BKR5EK	7956	23	BKR5EIX	6341
Corsa B	1.4	63	06.98 - 10.00	C14SEL OHC	4	0,8	BKR5EK	7956	23	BKR5EIX	6341
Corsa B 16V	1.4	66	11.94 - 08.00	X14XE DOHC	4	0,8	BKR5EK	7956	23	BKR5EIX	6341
Corsa B D	1.5	37	03.93 - 08.00	15D (4EC1) OHC Isuzu	4	█	CY03	4315		D-POWER 8	6160
Corsa B TD	1.5	49	03.93 - 08.00	X/15DT (T4EC1) OHC Isuzu	4	█	CY03	4315		D-POWER 8	6160
Corsa B	1.5	49	04.96 - 08.01	X15DT 4EE1 OHC	4	█	CY03	4315		D-POWER 8	6160
Corsa B	1.6	74	06.98 - 10.00	C16SEL DOHC	4	0,8	BKR5EK	7956	23	BKR5EIX	6341
Corsa B 16V	1.6	78	08.94 - 08.01	X16XE DOHC	4	0,8	BKR5EK	7956	23	BKR5EIX	6341
Corsa B	1.6	80	03.93 - 08.94	C16XE DOHC I	4	0,8	BKR5EK	7956	23	BKR5EIX	6341
Corsa B D	1.7	44	04.96 - 08.01	X17D (4EE1)/OHC	4	█	CY03	4315		D-POWER 8	6160
Corsa B TD	1.7	44	03.93 - 08.00	17D (4EE1)/OHC	4	█	CY03	4315		D-POWER 8	6160
Corsa C 12V	1.0	43	08.00 -	Z10XE	3	0,8	BKR5EK	7956	23	BKR5EIX	6341
Corsa C 12V	1.0	44	06.03 -	Z10XEP	3	1,1	ZFR5F-11	2262		ZFR5FIX-11	2477
Corsa C	1.2	55	08.00 -	Z12XE	4	0,8	BKR5EK	7956	23	BKR5EIX	6341
Corsa C	1.2	59	07.04 -	Z12XEP	4	1,1	ZFR5F-11	2262		ZFR5FIX-11	2477
Corsa C CDTI	1.3	51	06.03 -	Z13DT	4	█	YE06	5285			
Corsa C	1.4	66	06.03 -	Z14XEP	4	1,1	ZFR5F-11	2262		ZFR5FIX-11	2477
Corsa C	1.4	66	08.00 -	Z14XE	4	0,8	BKR5EK	7956	23	BKR5EIX	6341

! Fahrzeuge mit Aluschutzrohr SW 16  
Fahrzeuge ohne Aluschutzrohr SW 21  
<sup>1)</sup> Bic = Best in class

BKR5EK = V-Linie 23  
BPR5ES = V-Linie 6

141

! Cars with protection tube Hex 16  
Cars without protection tube Hex 21  
\* only by car dealer

BKR5EK = V-Linie 23  
BPR5ES = V-Linie 6



ℓ kW

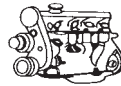

Cyl.

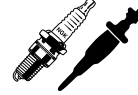
Order-  
No. No.Bic<sup>1)</sup> Order-  
D-Power No.**OPEL**

Corsa C	1.6	62	08.00 -	Z16SE	4	0,8	BKR5EK	7956	23	BKR5EIX	6341
Corsa C CNG	1.6	71	04 -	Y16YNG	4		BKR6EIX-LPG	3356			
Corsa C DI 16V	1.7	50	08.00 -	Y17DTL	4	█	Y-541J	4617		D-POWER 42	1983
Corsa C DTI 16V	1.7	55	08.00 -	Y17DT	4	█	Y-541J	4617		D-POWER 42	1983
Corsa C CDTI	1.7	74	06.03 -	Z17DTH	4	█	Y-541J	4617		D-POWER 42	1983
Corsa C	1.8	92	08.00 -	Z18XE	4	0,8	BKR5EK	7956	23	BKR5EIX	6341
Corsa D 12V	1.0	44	07.06 -	Z10XEP	3	1,1	ZFR5F-11	2262		ZFR5FIX-11	2477
Corsa D	1.2	59	07.06 -	Z12XEP	4	1,1	ZFR5F-11	2262		ZFR5FIX-11	2477
Corsa D DTI 16V	1.3	55	07.06 -	Z13DTJ	4	█	YE06	5285			
Corsa D CDTI	1.3	66	07.05 -	Z13XDTH	4	█	YE06	5285			
Corsa D	1.4	66	07.06 -	Z14XEP	4	1,1	ZFR5F-11	2262		ZFR5FIX-11	2477
Corsa D	1.6	132	04.07 -	Z16LET	4	1,0	PFR6T-10G	5542			
Corsa D OPC	1.6	141	08.07 -	Z16LER	4	1,0	PFR6T-10G	5542			
Frontera	2.0	85	02.95 - 06.98	X20SE OHC II	4	0,8	BKR5EK	7956	23	BKR5EIX	6341
Frontera	2.0	85	02.95 -	X20XE OHC	4	0,8	BKR5EK	7956	23	BKR5EIX	6341
Frontera	2.0	85	09.91 - 02.92	G20NE OHC II	4	0,9	BPR5ES	7422	6	BPR5EIX	6597
Frontera 16V	2.2	100	02.95 - 06.98	X22XE DOHC	4	0,8	BKR5EK	7956	23	BKR5EIX	6341
Frontera A TD Intercool	2.3	74	03.92 - 09.95	DTR OHC	4	█	Y-924U	4950		D-POWER 1	7906
Frontera A 2,3 TD Intercooler	2.3	74	09.91 - 02.95	23 DTR OHC	4	█	Y-924U	4950		D-POWER 1	7906
Frontera	2.4	92	09.91 - 02.95	G24NE CIH	6	0,7	BPR6HS	7022	3	BPR6HIX	4085
Frontera A TDI	2.5	85	06.96 - 08.98	25TD VM41B (25TDS)	4	█	Y-741U	5065		D-POWER 20	6943
Frontera A TDI	2.5	85	09.96 - 10.98	25TD/TDS/OHC	4	█	Y-741U	5065		D-POWER 20	6943
Frontera A TDI	2.8	83	02.95 - 11.98	28TD 4JB1T (28TDI) Isuzu	4	█	Y-904M1	7995			
Frontera B DTI 16V	2.2	85	10.98 - 09.02	Y22DTH	4	█	Y-523J	3703		D-POWER 37	6298
Frontera B DTI 16V	2.2	85	10.98 - 09.02	X22DTH	4	█	Y-748U	5000		D-POWER 14	6649
Frontera B 16V	2.2	100	10.98 -	X22XE DOHC	4	0,8	BKR5EK	7956	23	BKR5EIX	6341
Frontera B	2.2	100	10.98 - 12.00	X22SE	4	0,8	BKR5EK	7956	23	BKR5EIX	6341
Frontera B V6	3.2	151	08.98 -	Y32NE 6VD1	6	1,1	PFR5G-11	2647			
GT Turbo	2.0	194	02.07 -	Z20NHH	4	0,8	ILTR6C				
Kadett E	1.2	40	09.84 - 08.88	12S,ST OHC	4	0,8	BPR6ES	7822	2	BPR6EIX	6637
Kadett E	1.2	40	09.84 - 09.91	12S,SC OHV	4	0,7	BPR6HS	7022	3	BPR6HIX	4085
Kadett E	1.3	44	03.86 - 10.89	13N,NB OHC	4	0,8	BPR6ES	7822	2	BPR6EIX	6637
Kadett E	1.3	44	09.85 - 10.89	C13N OHC	4	0,8	BPR6ES	7822	2	BPR6EIX	6637
Kadett E	1.3	55	09.84 - 10.89	13S,SC OHC	4	0,8	BPR6ES	7822	2	BPR6EIX	6637
Kadett E	1.4	44	10.89 - 09.93	14NV OHC I	4	0,8	BPR6ES	7822	2	BPR6EIX	6637
Kadett E	1.4	44	10.89 - 09.91	C14NZ OHC I	4	0,9	BPR5ES	7422	6	BPR5EIX	6597
Kadett E	1.4	44	01.90 - 08.91	E14LV OHC I	4	0,8	BPR6ES	7822	2	BPR6EIX	6637
Kadett E D (Isuzu-Mot.)	1.5	37	09.84 - 08.91	4 EC1 Isuzu	4	█	Y-306R	6244			
				--> Mot. 804 794							
Kadett E D	1.6	40	09.84 - 02.89	16 D, DA OHC	4	█	Y-924U	4950		D-POWER 1	7906
Kadett E	1.6	55	09.87 - 09.93	C16NZ OHC	4	0,9	BPR5ES	7422	6	BPR5EIX	6597
Kadett E	1.6	55	09.87 - 09.91	E16NZ OHC	4	0,8	BPR6ES	7822	2	BPR6EIX	6637
Kadett E	1.6	55	09.87 - 08.91	E16SE OHC	4	0,8	BPR6ES	7822	2	BPR6EIX	6637
Kadett E	1.6	60	09.86 - 09.91	16SV OHC I	4	0,8	BPR6ES	7822	2	BPR6EIX	6637
Kadett E D	1.7	42	02.89 - 09.92	17 D OHC II	4	█	Y-924U	4950		D-POWER 1	7906
Kadett E D	1.7	44	09.92 - 09.93	17 DR	4	█	Y-924U	4950		D-POWER 1	7906
Kadett E	1.8	62	09.86 - 08.91	S18NV OHC II	4	0,8	BPR6ES	7822	2	BPR6EIX	6637
Kadett E	1.8	62	03.87 - 07.89	E18NV OHC II	4	0,8	BPR6ES	7822	2	BPR6EIX	6637
Kadett E	1.8	66	09.90 - 09.91	C18NZ OHC II	4	0,9	BPR5ES	7422	6	BPR5EIX	6597
Kadett E	1.8	82	09.86 - 09.91	18SE OHC II	4	0,8	BPR6ES	7822	2	BPR6EIX	6637
Kadett E	2.0	85	09.86 - 03.93	C20NE OHC	4	0,9	BPR5ES	7422	6	BPR5EIX	6597
Kadett E	2.0	85	09.86 - 09.91	Z0NE OHC	4	0,9	BPR5ES	7422	6	BPR5EIX	6597

! Fahrzeuge mit Aluschutzrohr SW 16  
Fahrzeuge ohne Aluschutzrohr SW 21BKR5EK = V-Linie 23  
BPR5ES = V-Linie 6! Cars with protection tube Hex 16  
Cars without protection tube Hex 21BKR5EK = V-Linie 23  
BPR5ES = V-Linie 6<sup>1)</sup> Bic = Best in class

\* only by car dealer



ℓ kW

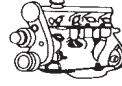

Cyl.

Order-  
No. No.Bic<sup>1)</sup> Order-  
D-Power No.**OPEL**

Kadett E	2.0	91	03.87 - 09.91	20SER OHC II	4	0,8	BPR6ES	7822	2	BPR6EIX	6637
Kadett E	2.0	95	09.86 - 09.91	20SEH OHC II	4	0,8	BPR6ES	7822	2	BPR6EIX	6637
Kadett E	2.0	110	04.89 - 09.91	20XEJ DOHC	4	0,8	BKR6EK	2288	20	BKR6EQUP	3199
Kadett E	2.0	110	03.88 - 09.91	C20XE DOHC	4	0,8	BKR6EK	2288	20	BKR6EQUP	3199
Manta	2.0	77	08.77 - 08.88	20E CIH Cat.	4	0,7	BPR6HS	7022	3	BPR6HIX	4085
Manta	2.0	81	08.77 - 08.88	20E CIH	4	0,7	BPR6HS	7022	3	BPR6HIX	4085
Meriva CDTI	1.3	55	09.03 -	Z13DTJ	4	█	YE06	5285			
Meriva	1.4	66	06.05 -	Z14XEP	4	1,1	ZFR5F-11	2262		ZFR5FIX-11	2477
Meriva	1.6	64	05.03 -	Z16SE	4	0,8	BKR5EK	7956	23	BKR5EIX	6341
Meriva	1.6	74	01.06 -	Z16XEP	4	1,1	ZFR5F-11	2262		ZFR5FIX-11	2477
Meriva	1.6	74	05.03 -	Z16XE	4	0,8	BKR5EK	7956	23	BKR5EIX	6341
Meriva Turbo OPC	1.6	132	09.06 -	Z16LET	4	1,0	PFR6T-10G	5542			
Meriva DTI	1.7	55	09.03 -	Y17DT	4	█	Y-541J	4617		D-POWER 42	1983
Meriva CDTI	1.7	74	09.03 -	Z17DTH	4	█	Y-541J	4617		D-POWER 42	1983
Meriva CDTI	1.7	92	09.06 -	Z17DTR	4	█	YE06	5285			
Meriva	1.8	92	05.03 -	Z18XE	4	0,8	BKR5EK	7956	23	BKR5EIX	6341
Monterey TD	3.1	84	11.91 - 02.98	4JG2-TC (3.1 D)	4	█	Y-719RS1	6900			
Monterey 24V	3.2	130	04.92 - 12.98	6VDI SOHC	6	0,9	BKR6E	6962	28	BKR6EIX	6418
Monterey	3.5	158	02.98 - 07.99	6VE1	6	1,1	BKR5EVX-11	5182		BKR5EIX-11	5464
Movano 1.9 DTI	1.9	59	09.00 -	F9Q M7	4	█	Y-515J	1019		D-POWER 18	6892
Movano 2.2 DTI	2.2	66	09.00 -	G9T C7	4	█	Y-517J	3319			
Movano 2.5 D	2.5	59	10.98 - 10.00	S8U W7	4	█	Y-935U	5915		D-POWER 23	4791
Omega A	1.8	60	09.86 - 03.94	18NV OHC II	4	0,8	BPR6ES	7822	2	BPR6EIX	6637
Omega A	1.8	60	09.87 - 03.90	E18NVR OHC II	4	0,8	BPR6ES	7822	2	BPR6EIX	6637
Omega A	1.8	62	09.86 - 03.94	S18NV OHC II	4	0,8	BPR6ES	7822	2	BPR6EIX	6637
Omega A	1.8	66	09.86 - 09.90	18SV OHC II	4	0,8	BPR6ES	7822	2	BPR6EIX	6637
Omega A	1.8	85	09.86 - 09.92	18SEH OHC II	4	0,8	BPR6ES	7822	2	BPR6EIX	6637
Omega A	2.0	74	09.86 - 03.94	20NE	4	0,9	BPR5ES	7422	6	BPR5EIX	6597
Omega A	2.0	74	09.86 - 03.94	20NEJ	4	0,8	BKR6EK	2288	20	BKR6EQUP	3199
Omega A	2.0	74	04.90 - 02.92	C20NEJ OHC	4	0,8	BKR6EK	2288	20	BKR6EQUP	3199
Omega A	2.0	85	09.86 - 03.94	C20NE OHC	4	0,9	BPR5ES	7422	6	BPR5EIX	6597
Omega A	2.0	90	09.89 - 03.94	20SE OHC II	4	0,8	BKR6EK	2288	20	BKR6EQUP	3199
Omega A D	2.3	54	09.86 - 02.94	23 YD OHC	4	█	Y-924U	4950		D-POWER 1	7906
Omega A D	2.3	66	09.86 - 09.88	23 YDT OHC	4	█	Y-924U	4950		D-POWER 1	7906
Omega A TD	2.3	74	09.88 - 02.94	23 DTR OHC	4	█	Y-924U	4950		D-POWER 1	7906
Omega A	2.4	92	09.88 - 03.94	C24NE CIH	6	0,7	BPR6HS	7022	3	BPR6HIX	4085
Omega A	2.6	110	09.90 - 03.94	C26NE CIH	6	0,7	BPR6HS	7022	3	BPR6HIX	4085
Omega A 3000	3.0	115	03.87 - 03.88	C30LE CIH	6	0,7	BPR6HS	7022	3	BPR6HIX	4085
Omega A 3000	3.0	115	03.87 - 03.94	C30NE CIH	6	0,7	BPR6HS	7022	3	BPR6HIX	4085
Omega A 3000	3.0	115	03.87 - 09.90	30NE CIH	6	0,7	BPR6HS	7022	3	BPR6HIX	4085
Omega A	3.0	130	03.87 - 03.94	C30NE CIH	6	0,7	BPR6HS	7022	3	BPR6HIX	4085
Omega A	3.0	130	03.87 - 09.90	30NE CIH	6	0,7	BPR6HS	7022	3	BPR6HIX	4085
Omega A 3000 24V	3.0	147	09.89 - 03.94	C30SE	6	0,8	BKR6EK	2288	20	BKR6EQUP	3199
Omega A 3000 24V	3.0	147	09.90 - 03.94	C30SEJ DOHC	6	0,8	BKR6EK	2288	20	BKR6EQUP	3199
Omega A 3000 24V Evo	3.0	170	03.91 - 09.92	C30XEI DOHC	6	0,8	BKR6EK	2288	20	BKR6EQUP	3199
Omega B DI 16V	2.0	74	09.97 -	X20DILC	4	█	Y-748U	5000		D-POWER 14	6649
Omega B DTI	2.0	74	09.99 -	Y20DTH	4	█	Y-523J	3703		D-POWER 37	6298
Omega B D	2.0	74	10.98 - 09.00	X20DTH OHC	4	█	Y-748U	5000		D-POWER 14	6649
Omega B	2.0	85	01.94 - 09.99	20SE OHC	4	0,8	BKR5EK	7956	23	BKR5EIX	6341
Omega B	2.0	85	01.94 - 09.00	X20SE OHC	4	0,8	BKR5EK	7956	23	BKR5EIX	6341
Omega B 16V	2.0	100	01.94 - 09.00	X20XEV DOHC	4	0,8	BKR5EK	7956	23	BKR5EIX	6341
Omega B DTI 16V	2.2	88	05.01 -	Y22DTR	4	█	Y-523J	3703		D-POWER 37	6298

! Fahrzeuge mit Aluschutzrohr SW 16  
 Fahrzeuge ohne Aluschutzrohr SW 21  
<sup>1)</sup> Bic = Best in class

BKR5EK = V-Linie 23  
 BPR5ES = V-Linie 6

143

! Cars with protection tube Hex 16  
 Cars without protection tube Hex 21  
 \* only by car dealer

BKR5EK = V-Linie 23  
 BPR5ES = V-Linie 6





ℓ kW

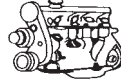

Cyl.

Order-  
No. No.Bic<sup>1)</sup> Order-  
D-Power No.**OPEL**

Omega B DTI 16V	2.2	88	08.01 -	Y22DTH	4	█	Y-523J	3703		D-POWER 37	6298
Omega B 2.2	2.2	106	09.99 - 09.00	Y22XE	4	0,8	BKR5EK	7956	23	BKR5EIX	6341
Omega B	2.2	108	08.00 -	Z22XE	4	0,8	BKR5EK	7956	23	BKR5EIX	6341
Omega B TD	2.5	96	08.96 - 10.01	X25TD OHC	6	█	Y-917U	3219		D-POWER 1	7906
Omega B TD	2.5	96	02.94 - 02.96	U25TD (Mot. BMW)	6	█	Y-917U	3219		D-POWER 1	7906
Omega B V6	2.5	125	01.94 - 09.00	X25XE DOHC	6	0,8	BKR5EK	7956	23	BKR5EIX	6341
Omega B	2.6	132	08.00 - 07.03	Y26SE	6		BKR5EQUPA	3566			
Omega B 24V	3.0	155	09.94 - 10.01	X30XE DOHC	6	0,8	BKR5EK	7956	23	BKR5EIX	6341
Omega B	3.2	160	05.01 - 07.03	Y32SE	6		BKR5EQUPA	3566			
Senator A D	2.0			Mot.-Nr. 90310 -->	4	█	Y-208T	1250			
Senator A D	2.0			--> Mot.-Nr. 90309	4	█	Y-403T	7494			
Senator B	2.5	103	03.88 - 09.90	25NE CIH	6	0,7	BPR6HS	7022	3	BPR6HIX	4085
Senator B	2.6	110	09.90 - 09.93	C26NE CIH	6	0,7	BPR6HS	7022	3	BPR6HIX	4085
Senator B	3.0	115	08.87 - 09.90	C30LE CIH	6	0,7	BPR6HS	7022	3	BPR6HIX	4085
Senator B	3.0	130	08.87 - 09.90	30NE CIH	6	0,7	BPR6HS	7022	3	BPR6HIX	4085
Senator B	3.0	150	09.89 - 06.93	C30SE DOHC	6	0,8	BKR6EK	2288	20	BKR6EQUP	3199
Senator B	3.6	145	08.89 - 09.93	C3,6NEI irmscher	6	0,8	BKR6EK	2288	20	BKR6EQUP	3199
Senator B	3.6	145	08.89 - 09.93	C3,6NE irmscher	6	0,8	BKR6EK	2288	20	BKR6EQUP	3199
Senator B	4.0	200	01.91 - 09.93	C40SE irmscher	6	0,8	BKR6EK	2288	20	BKR6EQUP	3199
Signum	1.6	74	03 -	Z16XE DOHC	4		BKR5EQUPA	3566			
Signum	1.8	85	05.03 -	Z18XEL	4		BKR5EQUPA	3566			
Signum 16V	1.8	92	05.03 -	Z18XE	4		BKR5EQUPA	3566			
Signum	1.8	103	09.05 -	Z18XER	4	1,1	ZFR5F-11	2262		ZFR5FIX-11	2477
Signum CDTI	1.9	74	06.05 -	Z19DTL Fiat	4	█	YE07	6092			
Signum CDTI	1.9	88	04.04 -	Z19DT Fiat	4	█	YE07	6092			
Signum CDTI 16V	1.9	110	04.04 -	Z19DTH Fiat	4	█	YE07	6092			
Signum DTI 16V	2.0	74	05.03 -	Y20DTH	4	█	Y-523J	3703		D-POWER 37	6298
Signum Turbo	2.0	129	05.03 -	Z20NET	4	1,0	PFR6T-10G	5542			
Signum DTI 16V	2.2	92	05.03 -	Y22DTR	4	█	Y-523J	3703		D-POWER 37	6298
Signum DI 16V	2.2	114	05.03 -	Z22YH	4		BKR5EQUPA	3566			
Signum V6 CDTI	3.0	130	09.03 -	Y30DT	6	█	*CZ24				
Signum 3.2 V6	3.2	155	05.03 -	Z32SE	6		BKR5EQUPA	3566			
Sintra TDI	2.2	85	01.98 -	X22DTH	4	█	Y-748U	5000		D-POWER 14	6649
Sintra 16V	2.2	104	09.96 - 09.99	X22XE DOHC	4	0,8	BKR5EK	7956	23	BKR5EIX	6341
Sintra 24V	3.0	155	09.96 - 09.99	X30XE DOHC	6	0,8	BKR5EK	7956	23	BKR5EIX	6341
Speedster Turbo	2.0	147	03 -	Z20LET	4	0,8	BKR5EK	7956	23	BKR5EIX	6341
Tigra A	1.4	63	08.97 - 12.00	C14SEL OHC	4	0,8	BKR5EK	7956	23	BKR5EIX	6341
Tigra A 16V	1.4	66	08.94 - 12.00	X14XE DOHC	4	0,8	BKR5EK	7956	23	BKR5EIX	6341
Tigra A	1.6	74	06.97 - 08.98	C16SEL DOHC	4	0,8	BKR5EK	7956	23	BKR5EIX	6341
Tigra A 16V	1.6	78	08.94 - 08.98	X16XE DOHC	4	0,8	BKR5EK	7956	23	BKR5EIX	6341
Tigra CDTI Turbo	1.3	52	06.04 -	Z13DT	4	█	YE06	5285			
Tigra B	1.4	66	06.04 -	Z14XEP	4	1,1	ZFR5F-11	2262		ZFR5FIX-11	2477
Tigra B	1.8	92	06.04 -	Z18XE	4	1,1	ZFR5F-11	2262		ZFR5FIX-11	2477
Vectra A	1.4	55	09.88 - 09.92	14NV OHC I	4	0,8	BPR6ES	7822	2	BPR6EIX	6637
Vectra A	1.6	52	09.93 - 08.95	X16SZ OHC	4	0,8	BKR5EK	7956	23	BKR5EIX	6341
Vectra A	1.6	55	09.88 - 08.94	C16NZ	4	0,9	BPR5ES	7422	6	BPR5EIX	6597
Vectra A	1.6	55	09.88 - 09.89	E16NZ OHC	4	0,8	BKR5EK	7956	23	BKR5EIX	6341
Vectra A	1.6	60	09.88 - 09.92	16SV OHC I	4	0,8	BPR6ES	7822	2	BPR6EIX	6637
Vectra A D	1.7	42	02.88 - 09.92	17D OHC II	4	█	Y-924U	4950		D-POWER 1	7906
Vectra A TD	1.7	60	10.92 - 08.95	17DT Isuzu TC4EE1	4	█	CY03	4315		D-POWER 8	6160
Vectra A TD	1.7	60	03.90 -	Isuzu TC4EC1 817253-->	4	█	Y-743U	5642			
Vectra A TD	1.7	60	10.92 - 08.95	X17DT Isuzu TC4EE1	4	█	CY03	4315		D-POWER 8	6160

! Fahrzeuge mit Aluschutzrohr SW 16  
Fahrzeuge ohne Aluschutzrohr SW 21BKR5EK = V-Linie 23  
BPR5ES = V-Linie 6! Cars with protection tube Hex 16  
Cars without protection tube Hex 21BKR5EK = V-Linie 23  
BPR5ES = V-Linie 6<sup>1)</sup> Bic = Best in class

\* only by car dealer



ℓ kW

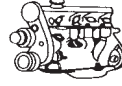

Cyl.

Order-  
No. No.Bic<sup>1)</sup> Order-  
D-Power No.**OPEL**

Vectra A 4x4	1.8	65	01.89 - 08.95	E18NVR OHC II	4	0,8	BPR6ES	7822	2	BPR6EIX	6637
Vectra A	1.8	65	09.88 - 08.95	E18NVR OHC II	4	0,8	BPR6ES	7822	2	BPR6EIX	6637
Vectra A	1.8	66	09.89 - 08.95	18SV	4	0,8	BPR6ES	7822	2	BPR6EIX	6637
Vectra A 4x4	1.8	66	09.89 - 08.95	18SV	4	0,8	BPR6ES	7822	2	BPR6EIX	6637
Vectra A	1.8	66	09.89 - 08.95	C18SV OHC	4	0,8	BPR6ES	7822	2	BPR6EIX	6637
Vectra A	1.8	66	03.90 - 08.95	C18NZ OHC II	4	0,8	BKR5EK	7956	23	BKR5EIX	6341
Vectra A 4x4	1.8	66	09.89 - 08.95	C18SV OHC	4	0,8	BPR6ES	7822	2	BPR6EIX	6637
Vectra A	2.0	85	09.89 - 08.95	C20NE OHC	4	0,8	BKR5EK	7956	23	BKR5EIX	6341
Vectra A	2.0	85	09.89 - 08.95	20NE	4	0,8	BKR5EK	7956	23	BKR5EIX	6341
Vectra A 4x4	2.0	85	01.89 - 08.95	C20NE OHC	4	0,8	BKR5EK	7956	23	BKR5EIX	6341
Vectra A 4x4	2.0	85	01.89 - 08.95	20NE	4	0,8	BKR5EK	7956	23	BKR5EIX	6341
Vectra A	2.0	95	09.88 - 09.92	20SEH OHC II	4	0,8	BPR6ES	7822	2	BPR6EIX	6637
Vectra A 4x4	2.0	95	01.89 - 09.92	20SEH OHC II	4	0,8	BPR6ES	7822	2	BPR6EIX	6637
Vectra A 16V	2.0	100	08.92 - 08.95	20XE	4	0,8	BKR5EK	7956	23	BKR5EIX	6341
Vectra A 16V	2.0	100	12.94 - 08.95	X20XEV DOHC	4	0,8	BKR5EK	7956	23	BKR5EIX	6341
Vectra A 16V	2.0	100	08.92 - 08.95	C20XE-LN	4	0,8	BKR5EK	7956	23	BKR5EIX	6341
Vectra A 16V	2.0	100	08.92 - 08.95	C20XE	4	0,8	BKR5EK	7956	23	BKR5EIX	6341
Vectra A 2000 16V 4x4	2.0	110	09.89 - 08.92	C20XE DOHC	4	0,8	BKR6EK	2288	20	BKR6EQU	3199
Vectra A 2000 16V 4x4	2.0	110	09.89 - 08.92	20XE	4	0,8	BKR6EK	2288	20	BKR6EQU	3199
Vectra A 2000 16V	2.0	110	09.89 - 08.92	C20XE DOHC	4	0,8	BKR6EK	2288	20	BKR6EQU	3199
Vectra A 2000 16V	2.0	110	09.89 - 08.92	20XE	4	0,8	BKR6EK	2288	20	BKR6EQU	3199
Vectra A	2.0	150	09.92 - 08.95	C20LET DOHC	4	1,1	ZFR6F-11	4291		ZFR6FIX-11	6441
Vectra A	2.5	125	03.93 - 08.95	C25XE DOHC	6	0,8	BKR5EK	7956	23	BKR5EIX	6341
Vectra A	2.5	125	02.93 - 08.95	25XE	6	0,8	BKR5EK	7956	23	BKR5EIX	6341
Vectra B	1.6	55	08.95 -	16LZ2 OHC	4	0,8	BKR5EK	7956	23	BKR5EIX	6341
Vectra B	1.6	55	08.95 - 02.00	X16SZR OHC	4	0,8	BKR5EK	7956	23	BKR5EIX	6341
Vectra B	1.6	74	08.00 -	Z16XE DOHC	4	0,8	BKR5EK	7956	23	BKR5EIX	6341
Vectra B	1.6	74	08.95 -	X16XEL DOHC	4	0,8	BKR5EK	7956	23	BKR5EIX	6341
Vectra B TD	1.7	60	08.95 -	X17TD/TC4 EE1 Isuzu	4	█	CY03	4315		D-POWER 8	6160
Vectra B	1.8	85	08.00 -	Z18XEL	4	0,8	BKR5EK	7956	23	BKR5EIX	6341
Vectra B	1.8	85	08.95 - 09.00	X18XE	4	0,8	BKR5EK	7956	23	BKR5EIX	6341
Vectra B	1.8	85	03.99 -	X18XE1	4	0,8	BKR5EK	7956	23	BKR5EIX	6341
Vectra B	1.8	92	08.00 -	Z18XE	4	0,8	BKR5EK	7956	23	BKR5EIX	6341
Vectra B Di	2.0	60	08.99 -	X20DTL SOHC	4	█	Y-748U	5000		D-POWER 14	6649
Vectra B DTI	2.0	74	08.97 -	X20DTH OHC	4	█	Y-748U	5000		D-POWER 14	6649
Vectra B DTI 16V	2.0	74	09.97 - 07.99	X20DILC	4	█	Y-748U	5000		D-POWER 14	6649
Vectra B DTI 16V	2.0	74	08.00 -	Y20DTH	4	█	Y-523J	3703		D-POWER 37	6298
Vectra B	2.0	80	08.95 -	20NEJ OHC	4	0,8	BKR5EK	7956	23	BKR5EIX	6341
Vectra B	2.0	100	02.97 -	C20SEL DOHC	4	0,8	BKR5EK	7956	23	BKR5EIX	6341
Vectra B	2.0	100	08.95 -	X20XEV	4	0,8	BKR5EK	7956	23	BKR5EIX	6341
Vectra B DTI 16V	2.2	92	08.00 -	Y22DTR	4	█	Y-523J	3703		D-POWER 37	6298
Vectra B	2.2	106	10.99 -	C22SEL DOHC	4	0,8	BKR5EK	7956	23	BKR5EIX	6341
Vectra B V6	2.5	125	08.95 -	X25XE DOHC	6	0,8	BKR5EK	7956	23	BKR5EIX	6341
Vectra B i500	2.5	143	01.98 -	X25XE DOHC	6	0,8	BKR5EK	7956	23	BKR5EIX	6341
Vectra B V6	2.6	125	08.00 -	Y26SE	6		BKR5EQU	3566			
Vectra C	1.6	74	06.04 -	Z16XE DOHC	4		BKR5EQU	3566			
Vectra C	1.6	77	01.06 -	Z16XEP	4	1,1	ZFR5F-11	2262		ZFR5FIX-11	2477
Vectra C	1.8	85	04.02 -	Z18XEL	4		BKR5EQU	3566			
Vectra C 16V	1.8	92	08.02 -	Z18XE	4		BKR5EQU	3566			
Vectra C	1.8	103	01.06 -	Z18XER	4	1,1	ZFR5F-11	2262		ZFR5FIX-11	2477
Vectra C CDTI	1.9	74	06.05 -	Z19DTL Fiat	4	█	YE07	6092			
Vectra C CDTI	1.9	88	04.04 -	Z19DT Fiat	4	█	YE07	6092			

! Fahrzeuge mit Aluschutzrohr SW 16  
Fahrzeuge ohne Aluschutzrohr SW 21  
<sup>1)</sup> Bic = Best in class

BKR5EK = V-Linie 23  
BPR5ES = V-Linie 6

145

! Cars with protection tube Hex 16  
Cars without protection tube Hex 21  
\* only by car dealer

BKR5EK = V-Linie 23  
BPR5ES = V-Linie 6



ℓ kW

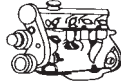

Cyl.

Order-  
No. No.Bic<sup>1)</sup> Order-  
D-Power No.**OPEL**

Vectra C CDTI 16V	1.9	110	04.04 -	Z19DTH Fiat	4	█	YE07	6092			
Vectra C DTI	2.0	74	04.02 -	Y20DTH	4	█	Y-523J	3703		D-POWER 37	6298
Vectra C GTS Turbo	2.0	129	03.03 -	Z20NET	4	1,0	PFR6T-10G	5542			
Vectra C DTI	2.2	92	04.02 -	Y22DTR	4	█	Y-523J	3703		D-POWER 37	6298
Vectra C DI 16V	2.2	114	10.03 -	Z22YH	4		BKR5EQUPA	3566			
Vectra C V6 CDTI	3.0	130	06.03 -	Y30DT	6	█	*CZ24				
Vectra C GTS	3.2	155	08.02 -	Z32SE	6		BKR5EQUPA	3566			
Vivaro DI	1.9	60	09.01 -		4	█	Y-515J	1019		D-POWER 18	6892
Vivaro DTI	1.9	74	09.01 -	F9Q 760	4	█	Y-515J	1019		D-POWER 18	6892
Vivaro	2.0	86	08.01 -		4	0,9	PFR6G-9	4377			
Vivaro 16V	2.0	88	09.01 -	F4R 720	4	0,9	PFR6G-9	4377			
Vivaro DTI	2.5	98	05.03 -	G9U - 730	4	█	Y-517J	3319			
Zafira CNG	1.6	71	09.01 -	Z16YNG	4		BKR6EIX-LPG	3356			
Zafira 16V	1.6	74	08.00 -	Z16XE	4	0,8	BKR5EK	7956	23	BKR5EIX	6341
Zafira 16V	1.6	74	03.99 -	X16XE DOHC	4	0,8	BKR5EK	7956	23	BKR5EIX	6341
Zafira A 16V	1.8	85	04.99-09.00	X18XE1	4	0,8	BKR5EK	7956	23	BKR5EIX	6341
Zafira 16V	1.8	85	03.99-09.00	X18XE DOHC	4	0,8	BKR5EK	7956	23	BKR5EIX	6341
Zafira 16V	1.8	92	09.00 -	Z18XE	4	0,8	BKR5EK	7956	23	BKR5EIX	6341
Zafira DI 16V	2.0	60	09.99 - 11.00	X20DTL	4	█	Y-748U	5000		D-POWER 14	6649
Zafira DTI 16V	2.0	74	08.99 -	Y20DTL	4	█	Y-748U	5000		D-POWER 14	6649
Zafira DTI 16V	2.0	74	08.00 -	Y20DTH	4	█	Y-523J	3703		D-POWER 37	6298
Zafira DTI 16V	2.0	74	04.99 -	X20DILC	4	█	Y-748U	5000		D-POWER 14	6649
Zafira Turbo 16V OPC	2.0	141	01 -	Z20LET	4	0,8	BKR5EK	7956	23	BKR5EIX	6341
Zafira B 16V	1.6	74	07.05 -	Z16XEP	4	1,1	ZFR5F-11	2262		ZFR5FIX-11	2477
Zafira B 16V	1.8	103	07.05 -	Z18XER	4	1,1	ZFR5F-11	2262		ZFR5FIX-11	2477
Zafira B CDTI	1.9	74	07.05 -	Z19DTL Fiat	4	█	YE07	6092			
Zafira B CDTI	1.9	88	07.05 -	Z19DT Fiat	4	█	YE07	6092			
Zafira B CDTI 16V	1.9	110	07.05 -	Z19DTH Fiat	4	█	YE07	6092			
Zafira B Turbo	2.0	147	07.05 -	Z20LER	4	0,7	ZFR5F	5165		ZFR5FIX-11	2477
Zafira B OPC	2.0	177	09.05 -	Z20LEH	4	0,8	PFR6T-G	6314			
Zafira B DI	2.2	110	07.05 -	Z22YH	4		BKR5EQUPA	3566			

**OTOSAN**

600 Pickup D	1.9			ERK 1.9	4	█	Y-902R	2237		D-POWER 1	7906
--------------	-----	--	--	---------	---	---	--------	------	--	-----------	------

**PANTHER**

Deville	4.2					0,8	BP5ES	6511	8	BPR5EIX	6597
Deville V12	4.2					0,8	BP5ES	6511	8	BPR5EIX	6597
J72 V12	4.2					0,8	BP5ES	6511	8	BPR5EIX	6597
J72SE	4.2					0,8	BP5ES	6511	8	BPR5EIX	6597
Kalistra	1.6	71	01.82 - 12.92	Ford	4	0,9	BKR6E	6962	28	BKR6EIX	6418
Kalistra V6	2.8	99	01.82 - 12.89	Ford	6	0,8	BPR6ES	7822	2	BPR6EIX	6637
R10 Spezial					4	0,8	BP6EFS	3812	5		

**PERODUA**

Kenari	0.85		00 -	EJ-VE	3	0,8	BKR5EKC	5216			
Kenari	1.0		11.00 -	EJ-VE	3	0,8	BKR5EKC	5216			
Nippa	0.85		08.97 - 01.00		3	0,9	BPR5ES	7422	6	BPR5EIX	6597

**PEUGEOT**

104 GL,ZA,ZL	0.9	32	10.72 - 06.88	XV...	4	0,8	BP6EFS	3812	5		
104 GL,GR,SL,Z,ZA,ZR,S,ZS	1.1	36	07.76 - 06.88	XW3/XW5/XW7	4	0,8	BP6EFS	3812	5		

! Fahrzeuge mit Aluschutzrohr SW 16  
Fahrzeuge ohne Aluschutzrohr SW 21

BKR5EK = V-Linie 23  
BPR5ES = V-Linie 6

! Cars with protection tube Hex 16  
Cars without protection tube Hex 21  
\* only by car dealer

BKR5EK = V-Linie 23  
BPR5ES = V-Linie 6

<sup>1)</sup> Bic = Best in class



ℓ kW

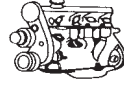

Cyl.

Order-  
No. No.Bic<sup>1)</sup> Order-  
D-Power No.**PEUGEOT**

106 D	1.4	37	08.91 - 06.94	TUD3/L	4	█	Y-911R	4544		D-POWER 33	4290
106 D	1.5	42	07.94 - 03.96	TUD5	4	█	Y-731U	5274		D-POWER 9	6281
106 D	1.5	42	04.96 - 10.03	TUD5	4	█	Y-731U	5274		D-POWER 9	6281
106i XN, XA, Kid	0.9	37	07.95 - 03.96	TU9M-CDZ	4	0,8	BKR5EK	7956	23	BKR5EIX	6341
106i XN, XA, Kid	0.9	37	07.92 - 06.95	TU9M-CDZ	4	0,8	BCPR5ES	6130	32	BCPR5EIX	5688
106 XN	0.9	37	08.91 - 12.92	TU9-C1A	4	0,8	BCP5ES	7496	16	BCPR5EIX	5688
106 XN, XR	1.1	38	08.91 - 12.92	TU1-H1A	4	0,8	BCP5ES	7496	16	BCPR5EIX	5688
106i XN, XR, XT, Green	1.1	44	07.92 - 06.95	TU1M-HDZ	4	0,8	BCPR5ES	6130	32	BCPR5EIX	5688
106i XN, XR, XT, Green	1.1	44	07.95 - 03.96	TU1M-HDZ	4	0,8	BKR6EK	2288	20	BKR6EQUP	3199
106 Rallye	1.3	74	11.93 - 03.96	TU2J2-MFZ	4	0,8	BKR6EK	2288	20	BKR6EQUP	3199
106 XR, XT	1.4	51	08.91 - 12.92	TU3.2-K2D	4	0,7	BCP6ES	4930	17	BCPR6EIX	5689
106 Xsi	1.4	55	07.92 - 03.96	TU3JP cat.~KFX	4	0,8	BKR6EK	2288	20	BKR6EQUP	3199
106 Xsi	1.4	55	08.91 - 12.92	TU3JP~KFX	4	0,8	BKR6EK	2288	20	BKR6EQUP	3199
106i XR, XS, XT	1.4	55	07.92 - 06.95	TU3MC~KDX	4	0,8	BCPR5ES	6130	32	BCPR5EIX	5688
106i XR, XS, XT	1.4	55	07.95 - 03.96	TU3MC~KDX	4	0,8	BKR6EK	2288	20	BKR6EQUP	3199
106i XS, XT, Griffe	1.6	66	07.94 - 03.96	TU5JP~NFZ	4	0,8	BKR6EK	2288	20	BKR6EQUP	3199
106 Xsi	1.6	74	12.93 - 06.95	TU5J2~NFW	4	0,8	BKR6ES	3783	28	BKR6EIX	6418
106 Xsi	1.6	74	07.95 - 05.96	TU5J2~NFW	4	0,8	BKR6EK	2288	20	BKR6EQUP	3199
106i (2), Kid	1.0	37	04.96 -	TU9M~CDZ /Y	4	0,8	BKR5EK	7956	23	BKR5EIX	6341
106 (2) Pop Art	1.1	44	05.00 -	TU1JP	4	0,9	BKR6EZ	4619		BKR6EIX	6418
106i (2)	1.1	44	04.96 -	TU1M+ ~HDZ	4	0,8	BKR6EK	2288	20	BKR6EQUP	3199
106i (2)	1.4	55	04.96 - 12.99	TU3JP~KFX	4	0,8	BKR6EK	2288	20	BKR6EQUP	3199
106i (2)	1.4	55	01.00 -	TU3JP~KFX	4	0,9	BKR6EZ	4619		BKR6EIX	6418
106i (2)	1.6	66	04.96 - 12.99	TU5JP~NFZ	4	0,8	BKR6EK	2288	20	BKR6EQUP	3199
106i (2)	1.6	66	01.00 -	TU5JP~NFZ	4	0,9	BKR6EZ	4619		BKR6EIX	6418
106 (2) Rallye	1.6	74	06.96 -	TU5J2~NFW	4	0,8	BKR6EK	2288	20	BKR6EQUP	3199
106 16V (2) S16, Gti	1.6	88	06.96 - 12.99	TU5J4~NFX	4	0,8	BKR6EK	2288	20	BKR6EQUP	3199
106 16V (2) S16, Gti	1.6	88	01.00 -	TU5J4~NFX	4	0,9	BKR6EZ	4619		BKR6EIX	6418
107 Hdi	1.4	51	01.05 -	DV4	4	█	YE05	5207			
205 XE, GL, Junior	0.9	33	07.92 -	TU9M Cat.	4	0,8	BCPR5ES	6130	32	BCPR5EIX	5688
205 XE, GL, Junior	0.9	33	07.87 - 12.92	TU9	4	0,8	BCP5ES	7496	16	BCPR5EIX	5688
205 Entreprise XA, XRA	1.1		88 -	E1	4	0,8	BCP6ES	4930	17	BCPR6EIX-11	4919
205 XR, XL, GL, GR	1.1	34	07.87 - 12.92	TU1	4	0,8	BCP5ES	7496	16	BCPR5EIX	5688
205	1.1	44		TU1M	4	0,8	BKR5EK	7956	23	BKR5EIX	6341
205 GR, Color Line	1.1	44	07.92 - 06.95	TU1M Cat.	4	0,8	BCPR5ES	6130	32	BCPR5EIX	5688
205 GR, Color, Sacre' Num	1.1	44	03.95 -	TU1.M Cat.	4	0,8	BKR6EK	2288	20	BKR6EQUP	3199
205	1.1	44	- 06.92		4	0,8	BCPR6ES	2330	12	BCPR6EIX	5689
205 Enterprise, XA, XRA	1.3		88 -	G1	4	0,7	BCP6ES	4930	17	BCPR6EIX	5689
205 Rallye	1.3	75	03.88 - 06.92	TU2.4	4	0,9	BKUR7ET	7873		PFR7Q	7963
205 Rallye	1.4		03.88 - 06.92	TU2.4	4	0,9	BKUR7ET	7873		PFR7Q	7963
205 XR, GR, SR, CJ	1.4	43	07.87 - 12.92	TU3 , TU3A	4	0,8	BCP5ES	7496	16	BCPR5EIX	5688
205 XR, GR, SR, CJ	1.4	55	07.92 -	TU3FM Cat.	4	0,8	BCPR5ES	6130	32	BCPR5EIX	5688
205 XR, GR, SR, SJ, Sacre' N	1.4	55	07.95 -	TU3.MC Cat.	4	0,8	BKR6EK	2288	20	BKR6EQUP	3199
205 XR, XS	1.4	55	07.92 - 06.95	TU3MC Cat.	4	0,8	BCPR6ES	2330	12	BCPR6EIX	5689
205	1.4	55		TU3M	4	0,8	BKR6EK	2288	20	BKR6EQUP	3199
205 XT, XS, GT, CT	1.4	62	07.87 - 12.92	TU3S	4	0,7	BCP6ES	4930	17	BCPR6EIX	5689
205 GR, XS, XT, Auto	1.6		07.90 - 12.92	XU5.1C	4	0,7	BCP6ES	4930	17	BCPR6EIX	5689
205 Enterprise XA, XRA	1.6		88 -	E1E / G1E	4	0,7	BCP6ES	4930	17	BCPR6EIX	5689
205 GR, XS, XT, Auto	1.6	58	07.87 - 06.90	XU5.1C	4	0,8	BCP5ES	7496	16	BCPR5EIX	5688
205 XS, GT, Auto	1.6	65	07.92 -	XU5.M Cat.	4	0,8	BCPR5ES	6130	32	BCPR5EIX	5688
205 GTi / CTi	1.6	83	07.87 - 06.92	XU5JA	4	0,7	BCP6ES	4930	17	BCPR6EIX	5689
205 Turbo 16 Stan.	1.8		84 -		4	0,8	R5724-9	6434			

<sup>1)</sup> Bic = Best in class



ℓ kW

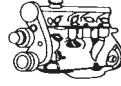

Cyl.

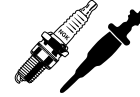
Order-  
No. No.Bic<sup>1)</sup> Order-  
D-Power No.**PEUGEOT**

205 D	1.8	44	10.83 - 08.98	XUD7	4	█	Y-902R	2237		D-POWER 1	7906
205 D	1.8	44	09.98 - 12.99	XUD7	4	█	Y-938R	5267		D-POWER 1	7906
205	1.8	58	09.98 - 12.99	XUD7T	4	█	Y-938R	5267		D-POWER 1	7906
205 TD	1.8	58	07.85 - 08.98	XUD7T	4	█	Y-902R	2237		D-POWER 1	7906
205 D	1.9	47	10.87 - 08.98	XUD9	4	█	Y-902R	2237		D-POWER 1	7906
205	1.9	51	09.98 - 12.99	XUD9A	4	█	Y-938R	5267		D-POWER 1	7906
205 Gentry	1.9	75	07.92 -	XU9.J1 Cat.	4	0,8	BCPR5ES	6130	32	BCPR5EIX	5688
205 GTi	1.9	88	07.92 -	XU9.JA Cat.	4	0,8	BCPR5ES	6130	32	BCPR5EIX	5688
205 GTi / Gentry	1.9	94	- 12.92	XU9.JA	4	0,7	BCP6ES	4930	17	BCPR6EIX	5689
206	1.1	44	01.00 -	TU1.JP-HFZ;HFY	4	0,9	BKR6EZ	4619		BKR6EIX	6418
206	1.1	44	09.98 - 12.99	TU1.JP-HFZ, HFY	4	0,8	BKR6EK	2288	20	BKR6EQUIP	3199
206 & SW	1.4	51	12.04 -	DV4TD	4	█	YE05	5207			
206 & SW Hdi	1.4	51	11.01 - 12.04	DV4TD	4	█	YE04	1101		D-POWER 40	1684
206	1.4	55	09.98 - 12.99	TU3.JP-KFX	4	0,8	BKR6EK	2288	20	BKR6EQUIP	3199
206	1.4	55	01.00 -	TU3.JP-KFX	4	0,9	BKR6EZ	4619		BKR6EIX	6418
206	1.6	66	09.98 - 08.00	TU5.JP-NFZ	4	0,8	BKR6EK	2288	20	BKR6EQUIP	3199
206	1.6	66	01.00 -	TU5.JP-NFZ	4	0,9	BKR6EZ	4619		BKR6EIX	6418
206 16V CC	1.6	81	03.01 -	TU5.JP4-NFU	4	0,9	LFR6B	6677			
206 D	1.9	51	09.98 -	DW8/ DW8B	4	█	Y-503R	4279		D-POWER 10	1009
206 & SW Hdi	2.0	66	10.99 -	DW10TD	4	█	Y-504R	4359		D-POWER 24	1441
206 S16,GT,CC	2.0	101	04.99 -	EW10J4	4	0,9	LFR5B	7113			
206 & SW	1.1	44	09.98 - 12.99	TU1.JP~HFZ, HFY	4	0,9	BKR6EK	2288	20	BKR6EQUIP	3199
206 & SW	1.1	44	01.00 -	TU1.JP~HFZ, HFY	4	0,9	BKR6EZ	4619		BKR6EIX	6418
206 & SW	1.4	55	01.00 -	TU3.JP~KFX	4	0,9	BKR6EZ	4619		BKR6EIX	6418
206 & SW	1.4	55	09.98 - 12.99	TU3.JP~KFX	4	0,9	BKR6EK	2288	20	BKR6EQUIP	3199
206 & SW	1.4	66	04 -	ET3J4~KFU	4	0,8	LZKAR7A	6799			
206 & SW	1.6	66	01.00 -	TU5.JP~NFZ	4	0,9	BKR6EZ	4619		BKR6EIX	6418
206 & SW	1.6	66	09.98 - 12.99	TU5.JP~NFZ	4	0,9	BKR6EK	2288	20	BKR6EQUIP	3199
206 & SW Hdi	1.6	81	04 - 06.06	DV6TED4	4	█	YE04	1101		D-POWER 40	1684
206 & SW 16V, CC	1.6	81	03.01 -	TU5.JP4~NFU	4	0,9	LFR6B	6677			
206 & SW S16, GT, CC	2.0	101	04.99 -	EW10J4~RFR, RFN	4	0,9	LFR5B	7113			
206 Coupé 16V XS, XT	1.6	81	03.01 -	TU5.JP4	4	0,9	LFR6B	6677			
206 Coupé 16V	2.0	102	04.99 -	EW10J4	4	0,9	LFR5B	7113			
207 Hdi	1.4	51	07.06 -	DV4TD	4	█	YE05	5207			
207 16V	1.4	66	04.06 -		4	0,8	LZKAR7A	6799			
207 Hdi	1.6	66	07.06 -	DV6TD	4	█	YE05	5207			
207 Hdi	1.6	81	07.06 -	DV6	4	█	YE05	5207			
207 Hdi 16V	1.6	81	07.06 -	DV6TED4	4	█	YE05	5207			
207 16V	1.6	81	04.06 -		4	0,9	LFR6B	6677			
207 RC	1.6	129	04.07 -	EP6DTS	4	0,8	PLZKBR7A-G				
207	1.6	129	11.06 -	EP6DTS	4	0,8	PLZKBR7A-G				
305 GR,SR	1.6	58	07.87 - 07.90	XU5.1C	4	0,8	BCP5ES	7496	16	BCPR5EIX	5688
305 D	1.8	44	10.82 - 06.88	XUD7	4	█	Y-902R	2237		D-POWER 1	7906
305 D	1.9	47	10.82 - 06.88	XUD 9	4	█	Y-902R	2237		D-POWER 1	7906
305 GTX	1.9	75	07.87 - 07.90	XU9.2C	4	0,8	BCP5ES	7496	16	BCPR5EIX	5688
306	1.1		96 -	TU1.M+	4	0,8	BKR6EK	2288	20	BKR6EQUIP	3199
306	1.1	44	02.93 - 06.95	TU1.M-HDZ	4	0,8	BCPR5ES	6130	32	BCPR5EIX	5688
306	1.1	44	07.95 -	TU1.M-HDZ	4	0,8	BKR5EK	7956	23	BKR5EIX	6341
306	1.4	55	01.00 -	TU3.JP-KFX	4	0,9	BKR6EZ	4619		BKR6EIX	6418
306	1.4	55	07.95 - 12.99	TU3.JP-KFX	4	0,8	BKR6EK	2288	20	BKR6EQUIP	3199
306	1.4	55	02.93 - 06.95	TU3.MC-KDX	4	0,8	BCPR5ES	6130	32	BCPR5EIX-11	3306
306	1.6	66	01.00 -	TU5.JP-NFZ	4	0,9	BKR6EZ	4619		BKR6EIX	6418

<sup>1)</sup> Bic = Best in class



l kW

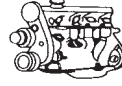

Cyl.

Order-  
No. No.Bic<sup>1)</sup> Order-  
D-Power No.**PEUGEOT**

306	1.6	66	02.93 - 12.99	TU5JP-NFZ	4	0,8	BKR6EK	2288	20	BKR6EQU	3199
306	1.8	43	10.93 - 08.98	XUD7	4	█	Y-902R	2237		D-POWER 1	7906
306 D	1.8	44	09.98 - 07.02	DW8	4	█	Y-503R	4279		D-POWER 10	1009
306	1.8	44	09.98 -	XUD7	4	█	Y-938R	5267		D-POWER 1	7906
306 TD	1.8	59	09.98 - 07.02	DW8TD	4	█	Y-503R	4279		D-POWER 10	1009
306 / Cabrio	1.8	74	02.93 - 03.95	XU7JP-LFZ	4	0,8	BCPR5ES	6130	32	BCPR5EIX	5688
306	1.8	74	04.95 -	XU7JP-LFZ	4	0,8	BKR5EK	7956	23	BKR5EIX	6341
306 16V	1.8	81	04.97 -	XU7JP4-LFY	4	0,8	BKR5EK	7956	23	BKR5EIX	6341
306	1.9	51	09.98 - 12.99	XUD9A/XUD9BSD	4	█	Y-938R	5267		D-POWER 1	7906
306 D	1.9	51	02.93 - 08.98	XUD9A	4	█	Y-902R	2237		D-POWER 1	7906
306	1.9	51	09.98 - 07.02	DW8	4	█	Y-503R	4279		D-POWER 10	1009
306 D	1.9	68	09.98 - 12.99	XUD9TE	4	█	Y-938R	5267		D-POWER 1	7906
306 D	1.9	68	03.93 - 08.98	XUD9TE	4	█	Y-923U	3380		D-POWER 1	7906
306 Hdi	2.0	66	04.99 - 07.02	DW10TD	4	█	Y-504R	4359		D-POWER 24	1441
306 D	2.0	80	09.98 -	DW10TD	4	█	Y-504R	4359		D-POWER 24	1441
306	2.0	89	- 03.97	XU10.J4-RFY	4	0,8	BKR6ES	3783	28	BKR6EIX	6418
306	2.0	89	04.95 - 04.97	XU10.J2-RFX	4	0,8	BKR5EK	7956	23	BKR5EIX	6341
306	2.0	89	02.93 - 03.95	XU10.J2-RFX	4	0,8	BCPR5ES	6130	32	BCPR5EIX-11	3306
306	2.0	98	04.97 -	XU10J4R-RFV	4	0,8	BKR5EK	7956	23	BKR5EIX	6341
306	2.0	120	07.96 -	XU10.J4RS-RFS	4	0,9	BKR5EZ	7642		BKR5EIX	6341
307 Hdi	1.4	51	01.02 - 12.04	DV4TD	4	█	YE04	1101		D-POWER 40	1684
307 & SW	1.4	51	12.04 - 05.05	DV4TD	4	█	YE05	5207			
307 & SW Hdi	1.4	51	01.02 - 12.04	DV4TD	4	█	YE04	1101		D-POWER 40	1684
307	1.4	55	04.01 -	TU3JP-KFX	4	0,9	BKR6EZ	4619		BKR6EIX	6418
307 & SW XR	1.4	55	04.01 - 99	TU3JP~KFX	4	0,9	BKR6EZ	4619		BKR6EIX	6418
307 & SW 16V	1.4	66	03.04 -	ET3J4 KFU	4	0,8	LZKAR7A	6799			
307 & SW Hdi	1.6	68	07.06 -	DV6TD	4	█	YE05	5207			
307	1.6	81	04.01 -	TU5JP4-NFU	4	0,9	LFR6B	6677			
307 & SW 16V	1.6	81	04.01 -	TU5JP4~NFU	4	0,9	LFR6B	6677			
307 & SW Hdi	1.6	81	07.06 -	DV6	4	█	YE05	5207			
307 & SW Hdi	1.6	81	03.04 - 06.06	DV6TED4	4	█	YE04	1101		D-POWER 40	1684
307 & SW Hdi	2.0	66	04.01 -	DW10TD	4	█	Y-504R	4359		D-POWER 24	1441
307 & SW Hdi	2.0	81	09.01 -	DW10ATED	4	█	Y-504R	4359		D-POWER 24	1441
307 & SW Hdi	2.0	100	03.04 -	DW10TED	4	█	Y-504R	4359		D-POWER 24	1441
307	2.0	101	04.01 -	EW10J4-RFN	4	0,9	LFR5B	7113			
307 & SW 16V	2.0	101	04.01 -	EW10J4~RFN	4	0,9	LFR5B	7113			
307 Coupé 16V	2.0	102	03 -	EW10J4	4	0,9	LFR5B	7113			
307 & SW	2.0	104	09.06 -	EW10A	4	0,9	LFR5B	7113			
309 XE,GE	1.1	40	- 12.92	TU1	4	0,8	BCP5ES	7496	16	BCPR5EIX	5688
309 GE,GL,GR	1.1	40	- 12.92	E1A	4	0,8	BCP5ES	7496	16	BCPR5EIX	5688
309 XA,XR,XL	1.1	40	- 12.92	E1A	4	0,8	BCP5ES	7496	16	BCPR5EIX	5688
309 Vital	1.1	40	07.92 -	TU1M Cat.	4	0,8	BCPR5ES	6130	32	BCPR5EIX	5688
309 GE,GL,GR,XE,XL,XR,XA	1.3	47	- 12.92	G1A	4	0,8	BCP5ES	7496	16	BCPR5EIX	5688
309 XL,GL	1.4	44	- 12.92	TU3	4	0,8	BCP5ES	7496	16	BCPR5EIX	5688
309 GXR	1.4	55	09.92 -	TU3M Cat.	4	0,8	BCPR5ES	6130	32	BCPR5EIX	5688
309	1.5	42	03.94 - 12.95	TUD5	4	█	Y-731U	5274		D-POWER 9	6281
309 GR,SR	1.6	53	07.87 - 06.89	XU5.1C	4	0,8	BCP5ES	7496	16	BCPR5EIX	5688
309 SR,GRX	1.6	65	07.92 -	XU5M Cat.	4	0,8	BCPR5ES	6130	32	BCPR5EIX	5688
309 GR,GRX,SR,SX,XS,XR	1.6	68	07.89 - 12.92	XU5.2C	4	0,7	BCP6ES	4930	17	BCPR6EIX	5689
309 D	1.8	44	06.86 - 12.93	XUD7	4	█	Y-902R	2237		D-POWER 1	7906
309 TD	1.8	58	11.89 - 12.93	XUD7T	4	█	Y-902R	2237		D-POWER 1	7906

<sup>1)</sup> Bic = Best in class



ℓ kW

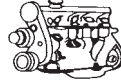

Cyl.

Order-  
No. No.Bic<sup>1)</sup> Order-  
D-Power No.**PEUGEOT**

309 D	1.9	47	06.86 - 12.93	XUD9 / XUD9Y	4	█	Y-902R	2237		D-POWER 1	7906
309	1.9	75	03.86 - 07.89	XU9.J1 Cat.	4	0,8	BCPR5ES	6130	32	BCPR5EIX	5688
309 GT	1.9	75	07.87 - 06.89	XU9.2C	4	0,8	BCP5ES	7496	16	BCPR5EIX	5688
309 XS,SX	1.9	80	07.89 - 06.92	XU9.2C	4	0,7	BCP6ES	4930	17	BCPR6EIX	5689
309 XS,SX	1.9	80	07.92 -	XU9M Cat.	4	0,8	BCPR5ES	6130	32	BCPR5EIX	5688
309 GTi	1.9	88	07.92 -	XU9.JA Cat.	4	0,8	BCPR5ES	6130	32	BCPR5EIX	5688
309 GTi	1.9	94	- 12.92	XU9.JA	4	0,7	BCP6ES	4930	17	BCPR6EIX	5689
309 GTi 16V	1.9	110	07.92 -	XU9.J4 Cat.	4	0,9	BCPR6ET	2197		BCPR6EIX	5689
309 GTi 16V	1.9	118	- 06.92	XU9.J4	4	0,8	BCP6ET	4563		BCPR6EIX	5689
405 GL	1.4	47	07.87 - 06.92	TU3	4	0,8	BCP5ES	7496	16	BCPR5EIX	5688
405 GL	1.4	55	07.92 - 06.95	TU3M-KDX Cat.	4	0,8	BCPR5ES	6130	32	BCPR5EIX	5688
405	1.4	55	07.95 - 04.97	TU3M-KDX Cat.	4	0,8	BKR6EK	2288	20	BKR6EQUIP	3199
405 Sillage,Style	1.6		07.94 - 03.95	XU5JP-BFZ Cat.	4	0,8	BCPR5ES	6130	32	BCPR5EIX	5688
405 GL,GR,SR	1.6	55	07.87 - 06.92	XU51C	4	0,8	BCP5ES	7496	16	BCPR5EIX	5688
405 GL,GR,SR	1.6	65	07.92 - 06.94	XU5M-BDY Cat.	4	0,8	BCPR5ES	6130	32	BCPR5EIX	5688
405	1.6	66	04.95 -	XU5JP-BFZ	4	0,8	BKR5EK	7956	23	BKR5EIX	6341
405	1.8		04.95 -	XU7JP-LFZ	4	0,8	BKR5EK	7956	23	BKR5EIX	6341
405 TD	1.8	68	03.88 - 12.92	XUD7TE	4	█	Y-902R	2237		D-POWER 1	7906
405 Signa,Style	1.8	74	07.92 - 03.95	XU7JP-LFZ Cat.	4	0,8	BCPR5ES	6130	32	BCPR5EIX	5688
405 GRi,SRi,Si,X4	1.9		07.87 - 06.92	XU9J2-D6A	4	0,7	BCP6ES	4930	17	BCPR6EIX	5689
405 GR,SR	1.9		07.87 - 06.92	XU92C	4	0,7	BCP6ES	4930	17	BCPR6EIX	5689
405 Mi16,X4	1.9		07.90 - 06.92	XU9J4-D6C	4	0,9	BCPR6ET	2197		BCPR6EIX	5689
405 GLD	1.9	47	07.88 - 12.92	XUD9Y	4	█	Y-902R	2237		D-POWER 1	7906
405	1.9	51	09.98 - 12.99	XUD9A	4	█	Y-938R	5267		D-POWER 1	7906
405 D	1.9	51	03.88 -	XUD9A	4	█	Y-902R	2237		D-POWER 1	7906
405	1.9	55	10.95 -	XUD9SD	4	█	Y-923U	3380		D-POWER 1	7906
405 TD	1.9	68	09.92 - 12.97	XUD9TE / XUD9TF	4	█	Y-923U	3380		D-POWER 1	7906
405 Mi16,X4	1.9	116	07.87 - 06.90	XU9J4-D6C	4	0,8	BCP6ET	4563		BCPR6EIX	5689
405 Signature,STI	2.0		07.92 - 03.95	XU10J2-RFX Cat.	4	0,8	BCPR5ES	6130	32	BCPR5EIX	5688
405 Signature,STI	2.0	90	07.92 - 03.95	XU10J2-RFX Cat.	4	0,8	BKR5EK	7956	23	BKR5EIX	6341
405 Mi16	2.0	110	07.92 -	XU10J4-RFY Cat.	4	0,8	BKR6ES	3783	28	BKR6EIX	6418
405 T16	2.0	147	09.92 - 04.97	XU10J4TE-RGZ Cat.	4	0,8	BKR6EK	2288	20	BKR6EQUIP	3199
406	1.6	66	10.95 -	XU5JP-BFZ	4	0,8	BKR5EK	7956	23	BKR5EIX	6341
406	1.8	66	10.95 -	XU7JP-L6A	4	0,8	BKR5EK	7956	23	BKR5EIX	6341
406	1.8	81	10.95 -	XU7JP4-LFY	4	0,8	BKR5EK	7956	23	BKR5EIX	6341
406	1.9	68	09.98 - 12.99	XUD9TE /TF/BTF	4	█	Y-938R	5267		D-POWER 1	7906
406 TD	1.9	68	10.95 - 08.98	XUD9TE/TF/BTF	4	█	Y-923U	3380		D-POWER 1	7906
406 Hdi	2.0	81	12.98 - 04.04	DW10ATED	4	█	Y-504R	4359		D-POWER 24	1441
406	2.0	97	10.95 -	XU10J4R-RFV	4	0,8	BKR5EK	7956	23	BKR5EIX	6341
406 Coupé 16V	2.0	97	06.97 - 03.99	XU10J4R-RFV	4	0,8	BKR5EK	7956	23	BKR5EIX	6341
406 Coupé 16V	2.0	101	04.99 -	EW10J4-RFR	4	0,9	LFR5B	7113			
406	2.0	107	07.96 -	XU10J2TE-RGX	4	0,8	BKR6EK	2288	20	BKR6EQUIP	3199
406	2.1	80	09.98 - 12.99	XUD11BTE	4	█	Y-938R	5267		D-POWER 1	7906
406 TD	2.1	80	10.95 - 08.98	XUD11BTE	4	█	Y-923U	3380		D-POWER 1	7906
406 Coupé	2.2	100	03.01 -	DW12TED4	4	█	Y-504R	4359		D-POWER 24	1441
406 Coupé 16V	2.2	118	05.00 -	EW12J4-3FZ	4	0,9	LFR5B	7113			
406 24V V6	3.0	140	10.96 -	ES9J4-XFZ	6	0,8	BKR6EK	2288	20	BKR6EQUIP	3199
406 Coupé V6	3.0	143	06.97 - 05.00	ES9J4-XFZ	6	0,8	BKR6EK	2288	20	BKR6EQUIP	3199
406 Coupé V6	3.0	154	06.00 -	ES9J4S-XFX	6	1,1	PLFR5A-11	6240			
406 Phase 2	1.8	66	04.99 -	XU7JB-LFX	4	0,8	BKR6EK	2288	20	BKR6EQUIP	3199
406 Phase 2	1.8	81	04.99 - 08.00	XU7JP4-LFY	4	0,8	BKR5EK	7956	23	BKR5EIX	6341
406 Phase 2	1.8	86	09.00 -	EW7J4-6FZ	4	0,9	LFR5B	7113			

<sup>1)</sup> Bic = Best in class



ℓ kW

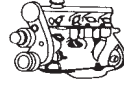

Cyl.

Order-  
No. No.Bic<sup>1)</sup> Order-  
D-Power No.**PEUGEOT**

406 TD Phase 2	2.0	66	04.99 - 04.04	DW10TD	4	█	Y-504R	4359		D-POWER 24	1441
406 TD Phase 2	2.0	81	04.99 - 04.04	DW10ATED	4	█	Y-504R	4359		D-POWER 24	1441
406 Phase 2	2.0	101	04.99 -	EW10J4-RFR	4	0,9	LFR5B	7113			
406 Hdi Phase 2	2.2	100	09.00 - 05.03	DW12TED4	4	█	Y-504R	4359		D-POWER 24	1441
406 Phase 2	2.2	117	05.00 -	EW12J4-3FZ	4	0,9	LFR5B	7113			
406 Phase 2	3.0	140	04.99 - 09.00	ES9J4-XFZ	6	0,8	BKR6EK	2288	20	BKR6EQU	3199
406 Phase 2	3.0	154	10.00 -	ES9J4S-XFX	6	1,1	PLFR5A-11	6240			
407 Hdi	1.6	81	03.06 -	DV6TED	4	█	YE05	5207			
407 Hdi	1.6	81	04.04 - 06.06	DV6TED	4	█	YE04	1101		D-POWER 40	1684
407 Hdi	2.0	93	04.04 -	DW10TED	4	█	Y-504R	4359		D-POWER 24	1441
407	2.0	104	09.06 -	EW10A	4	0,9	LFR5B	7113			
407 Hdi	2.2	125	05.06 -	DW12BTED4	4	█	YE08	4966			
504			11.77 -	Injection/Einspritzer	4	0,8	BP5ES	6511	8	BPR5EIX	6597
504				Carburettor/Vergaser	4	0,8	BP5ES	6511	8	BPR5EIX	6597
504 D Pick Up	2.3	47	07.84 - 12.90	XD 2	4	█	Y-902R	2237		D-POWER 1	7906
505 GL,SR,ST,SX	1.8	62	10.85 - 12.93	XN.. / XM..	4	0,7	BP6ES	7811	4	BPR6EIX	6637
505 Ti,STi	2.0	81	07.85 - 12.89	ZEJ..	4	0,8	BP6EFS	3812	5		
505 GTi	2.2		05.81 - 12.93	ZAJ..	4	0,8	BP6EFS	3812	5		
505 Turbo	2.2	105	- 10.88	N9T	4	0,6	BR7ES	5122			
505 Turbo	2.2	110	03.84 - 10.88	N9TE	4	0,8	BP6ET	1263		PGR6D	6248
505 D	2.5	51	06.87 - 12.93	XD 3	4	█	Y-902R	2237		D-POWER 1	7906
505 TD	2.5	66	10.83 - 12.93	XD 3 T	4	█	Y-902R	2237		D-POWER 1	7906
505 TD	2.5	77	10.86 - 12.93	XD 3 TE	4	█	Y-902R	2237		D-POWER 1	7906
505 V6	2.8	105	08.86 - 12.93	ZN3J	6	0,6	BR7EF	3346			
605 SL	2.0	79	07.89 - 06.92	XU102C-R2A	4	0,7	BCP6ES	4930	17	BCPR6EIX	5689
605 SRi	2.0	89	09.89 - 12.92	XU10J2-R6A	4	0,8	BCPR6ES	2330	12	BCPR6EIX	5689
605 SLI	2.0	89	07.92 - 07.94	XU10J2-RFZ Cat.	4	0,8	BCPR5ES	6130	32	BCPR5EIX	5688
605	2.0	99	08.94 - 05.99	XU10J4R-RFV	4	0,8	BKR5EK	7956	23	BKR5EIX	6341
605 SRTi Turbo	2.0	104	12.92 - 05.99	XU10J2TE-RGX	4	0,8	BKR6EK	2288	20	BKR6EQU	3199
605 D	2.1	60	09.89 - 06.94	XUD11A/L	4	█	Y-902R	2237		D-POWER 1	7906
605 TD	2.1	80	09.98 - 07.00	XUD11ATE/BTE	4	█	Y-938R	5267		D-POWER 1	7906
605 TD	2.1	80	09.89 - 06.94	XUD11ATE/L, BTE	4	█	Y-923U	3380		D-POWER 1	7906
605 TD	2.5	96	07.94 - 05.99	DK5ATE	4	█	Y-923U	3380		D-POWER 1	7906
605 SR,SV	3.0	125	07.89 - 06.97	ZPJ-SFZ Cat.	6	0,9	BCPR6ET	2197		BCPR6EIX	5689
605 3.0	3.0	140	07.97 - 05.99	ES9J4-XFZ	6	0,8	BKR6EK	2288	20	BKR6EQU	3199
605 SV 24V	3.0	147	07.89 - 06.97	ZPJ4-SKZ Cat.	6	0,9	BCPR6ET	2197		BCPR6EIX	5689
607 Hdi	2.0	81		DW10TED	4	█	Y-504R	4359		D-POWER 24	1441
607	2.0	101	05.00 -	EW10J4-RFN	4	0,9	LFR5B	7113			
607 Hdi 16V	2.2	100	05.00 -	DW12TED4	4	█	Y-504R	4359		D-POWER 24	1441
607	2.2	118	05.00 -	EW12J4-3FZ	4	0,9	LFR5B	7113			
607 Hdi	2.2	125	06.06 -	DW12BTED4	4	█	YE08	4966			
607 Hdi	2.7	150	12.04 -	DT17	6	█	YE12	7794			
607 3.0 V6	3.0	152	05.00 -	ES9J4S-XFX	6	1,1	PLFR5A-11	6240			
806	1.8	74	10.96 - 06.00	XU7JP-LFW	4	0,8	BKR5EK	7956	23	BKR5EIX	6341
806 TD	1.9	68	06.94 - 08.98	XUD9TF	4	█	Y-923U	3380		D-POWER 1	7906
806 D	1.9	68	09.98 - 01.01	XUD9TF	4	█	Y-938R	5267		D-POWER 1	7906
806 D	1.9	68	09.98 -	XUD9BTF	4	█	Y-938R	5267		D-POWER 1	7906
806 D	2.0	80	09.98 -	DW10TED	4	█	Y-504R	4359		D-POWER 24	1441
806 D Hdi	2.0	81	09.99 -	DW10ATED	4	█	Y-504R	4359		D-POWER 24	1441
806 16V	2.0	89	06.94 - 03.95	XU10J2-RFU	4	0,8	BCPR5ES	6130	32	BCPR5EIX	5688
806	2.0	90	04.95 - 05.00	XU10J2-RFU	4	0,8	BKR5EK	7956	23	BKR5EIX	6341
806	2.0	101	06.00 -	EW10J4-RFR	4	0,9	LFR5B	7113			

<sup>1)</sup> Bic = Best in class





ℓ kW

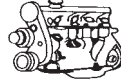

Cyl.

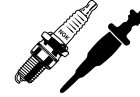
Order-  
No. No.Bic<sup>1)</sup> Order-  
D-Power No.**PEUGEOT**

806 Turbo	2.0	110	06.94 - 05.00	XU10J2TE-RGX	4	0,8	BKR6EK	2288	20	BKR6EQUIP	3199
806 TD	2.1	80	07.96 -	XUD11ATE	4	█	Y-923U	3380		D-POWER 1	7906
806 D	2.1	80	06.96 - 08.98	XUD11BTE	4	█	Y-923U	3380		D-POWER 1	7906
806 D	2.1	80	09.98 - 01.01	XUD11BTE	4	█	Y-938R	5267		D-POWER 1	7906
807 Hdi	2.0	80	06.02 -	DW10ATED4/RHT	4	█	Y-504R	4359		D-POWER 24	1441
807	2.0	102	06.02 - 09.05	EW10J4-RFR	4	0,9	LFR5B	7113			
807	2.0	104	10.05 -	EW10A	4	0,9	LFR5B	7113			
807 Hdi	2.2	94	06.02 -	DW12TED4/4HW	4	█	Y-504R	4359		D-POWER 24	1441
807	2.2	118	06.02 -	EW12J4-3FZ	4	0,9	LFR5B	7113			
807	3.0	154	06.02 -	ES9J4S-XFX	6	1,1	PLFR5A-11	6240			
1007	1.4	55	04.05 -		4		BKR6E-11	2756			
1007	1.6	81	04.05 -		4	0,9	LFR6B	6677			
1007	1.4	51	01.05 -	DV4TD	4	█	YE05	5207			
4007 2.2 Hdi	2.2	115	07.07 -	DW12MTED4	4	█	YE08	4966			
Boxer D	1.8	44	09.98 -	XUD7	4	█	Y-938R	5267		D-POWER 1	7906
Boxer D	1.9	51	03.94 - 08.98	XUD9A	4	█	Y-923U	3380		D-POWER 1	7906
Boxer D	1.9	51	09.98 -	XUD9AU	4	█	Y-938R	5267		D-POWER 1	7906
Boxer TD	1.9	68	03.94 - 08.98	XUD9TF	4	█	Y-923U	3380		D-POWER 1	7906
Boxer	1.9	68	09.98 -	XUD9TF	4	█	Y-938R	5267		D-POWER 1	7906
Boxer	2.0	81	-03.95	XU10J2U-RFW	4	0,8	BCPR6ES	2330	12	BCPR6EIX	5689
Boxer	2.0	81	04.95 -	XU10J2U-RFW	4	0,8	BKR6EK	2288	20	BKR6EQUIP	3199
Boxer	2.5	63	03.94 - 08.98	DJ5	4	█	Y-923U	3380		D-POWER 1	7906
Boxer Tdi	2.5	76	09.96 -	DJ5TED	4	█	Y-738U	5390			
Boxer TD	2.5	76	03.94 - 08.96	DJ5T	4	█	Y-923U	3380		D-POWER 1	7906
Boxer Hdi	2.8	93	10.97 -	Sofim	4	█	Y-924U	4950		D-POWER 1	7906
Boxer 2 Hdi	2.0	66	09.98 -	DW10TD	4	█	Y-504R	4359		D-POWER 24	1441
Boxer 2 Hdi	2.2	100	03.01 -	DW10TED4	4	█	Y-504R	4359		D-POWER 24	1441
Expert	1.6	59	95 -	1580 SPI 222A2.000	4	0,8	BCPR7ES	3330		BCPR7EIX	5690
Expert	1.8	44	09.98 -	DW8	4	█	Y-503R	4279		D-POWER 10	1009
Expert TD	1.8	59	09.98 -	DW8TD	4	█	Y-503R	4279		D-POWER 10	1009
Expert	1.8	74	96 -	XU7JP	4	0,8	BKR5EK	7956	23	BKR5EIX	6341
Expert	1.9	51	09.98 -	XUD9A	4	█	Y-938R	5267		D-POWER 1	7906
Expert	1.9	51	01.96 - 08.98	XUD9A	4	█	Y-923U	3380		D-POWER 1	7906
Expert TD	1.9	66	09.95 - 08.98	XUD 9TE	4	█	Y-923U	3380		D-POWER 1	7906
Expert TD	1.9	68	09.98 -	XUD9BTF	4	█	Y-938R	5267		D-POWER 1	7906
Expert	1.9	68	01.96 - 08.98	XUD9BTF	4	█	Y-923U	3380		D-POWER 1	7906
Expert	1.9	68	01.96 - 08.98	XUD9TF	4	█	Y-923U	3380		D-POWER 1	7906
Expert TD	1.9	68	09.98 -	XUD9TF	4	█	Y-938R	5267		D-POWER 1	7906
Expert Hdi	2.0	70	02.00 -	DW10TED	4	█	Y-504R	4359		D-POWER 24	1441
Expert Hdi	2.0	81	02.00 -	DW10ATED	4	█	Y-504R	4359		D-POWER 24	1441
Expert	2.0	101	06.00 -	EW10J4-RFN	4	0,9	LFR5B	7113			
Expert	2.0	104	01.07 -	EW10A	4	0,9	LFR5B	7113			
Expert	2.1	80	07.96 -	XUD11ATE	4	█	Y-923U	3380		D-POWER 1	7906
J5, J7, J9					4	0,8	BP5ES	6511	8	BPR5EIX	6597
J 5 D	1.9	51	11.87 -	XUD9A	4	█	Y-902R	2237		D-POWER 1	7906
J 5 D	2.5	54	09.81 - 06.91	CRD93	4	█	Y-208T	1250			
J 5 TD	2.5	70	07.87 - 06.91	CRD93LS	4	█	Y-208T	1250			
J 9 Transporter D		59	05.81 -		4	█	Y-902R	2237		D-POWER 1	7906
J 9 Transporter D	2.1	41	05.81 -	XDP4.90	4	█	Y-902R	2237		D-POWER 1	7906
J 9 Transporter D	2.5	53	10.82 -	XD3P	4	█	Y-902R	2237		D-POWER 1	7906
Partner	1.1	44	07.96 -	TU1M+HDZ	4	0,8	BKR6EK	2288	20	BKR6EQUIP	3199
Partner Hdi	1.4	55	03.06 -		4	█	YE05	5207			

<sup>1)</sup> Bic = Best in class



l kW

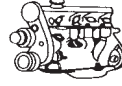

Cyl.

Order-  
No. No.Bic<sup>1)</sup> Order-  
D-Power No.**PEUGEOT**

Partner	1.4	55	07.96 -	TU3JP-KFX;KFW	4	0,8	BKR6EK	2288	20	BKR6EQU	3199
Partner Hdi	1.6	66	03.06 -		4	█	YE05	5207			
Partner	1.8	66	07.97 -	XU7JB-LFX	4	0,8	BKR6EK	2288	20	BKR6EQU	3199
Partner Combi	1.8	43	07.96 -08.98	XUD7	4	█	Y-923U	3380		D-POWER 1	7906
Partner Combi	1.8	44	09.98 -03.02	XUD7	4	█	Y-938R	5267		D-POWER 1	7906
Partner Combi	1.8	44	09.98 -03.02	DW8	4	█	Y-503R	4279		D-POWER 10	1009
Partner Combi	1.8	59	09.98 -03.02	DW8TD	4	█	Y-503R	4279		D-POWER 10	1009
Partner Combi	1.9	51	09.98 -03.02	XUD9A	4	█	Y-938R	5267		D-POWER 1	7906
Partner Combi	1.9	51	07.96 -08.98	XUD9A	4	█	Y-923U	3380		D-POWER 1	7906
Partner Combi	1.9	51	09.98 -03.02	DW8 / DW8B	4	█	Y-503R	4279		D-POWER 10	1009
Partner Combi Hdi	2.0	66	10.99 -03.02	DW10TD	4	█	Y-504R	4359		D-POWER 24	1441
Partner Multispace	1.4	55	01.97 -12.99	TU3JP-KFX;KFW	4	0,8	BKR6EK	2288	20	BKR6EQU	3199
Partner Multispace	1.4	55	01.00 -	TU3JP-KFX;KFW	4	0,9	BKR6EZ	4619		BKR6EIX	6418
Partner Multispace	1.6	81	02.01 -	TU5JP4-NFU	4	0,9	LF6B	6677			
Partner Multispace	1.8	66	07.97 -	XU7JB-LFX	4	0,8	BKR6EK	2288	20	BKR6EQU	3199
Partner Multispace	1.9	51	01.97 -09.98	XUD9A	4	█	Y-923U	3380		D-POWER 1	7906
Partner Multispace	1.9	51	09.98 -	DW8 / DW8B	4	█	Y-503R	4279		D-POWER 10	1009
Partner Multispace Hdi	2.0	66	10.99 -	DW10TD	4	█	Y-504R	4359		D-POWER 24	1441

**PIAGGIO**

Ape Car D	0.5	11	01.83 -			█	Y-918R	4182		D-POWER 2	6285
Porter 1.3i 16V	1.3	48	05.98 -	HC-ES	4		BKUR6EK	2213			

**PLYMOUTH**

Breeze	2.0		96 - 99	L4 MPI X DOHC		1,2	FR45	4636			
Breeze	2.0		96 -	L4 MPI C SOHC		0,9	FR5	4876			
Neon	2.0		95 -	L4 MPI C SOHC		0,9	FR5	4876			
Neon	2.0		95 -	L4 MPI Y DOHC		0,9	FR5	4876			

**PONTIAC**

Bonneville	3.8		98 - 99	V6 MFI 1 SC	6	1,5	PTR4B-15	5146			
Bonneville	3.8		96 - 99	V6 MFI K	6	1,5	PTR4B-15	5146			
Bonneville	3.8		96 - 97	V6 SFI 1 SC	6	1,5	PTR4B-15	5146			
Firebird	3.8		96 - 99	V6 MFI K	6	1,5	PTR4B-15	5146			
Grand Prix	3.1		94 - 95	V6 MFI M	6	1,5	TR55	1048		TR55IX	7164
Grand Prix	3.4		91 - 95	V6 MFI X	6	1,1	TR5	7837		TR5IX	7397
Grand Prix	3.8		97 -	V6 MFI 1 SC	6	1,5	PTR4B-15	5146			
Grand Prix	3.8		97 -	V6 MFI K	6	1,5	PTR4B-15	5146			
Grand Prix	3.8		98 -	V6 MFI 1 SC	6	1,5	PTR4B-15	5146			
GTO	5.7	0	05 -	V8	8	1,5	TR55	1048		TR55IX	7164
Trans Sport	2.3	101	01.93 -	L4 16V G	4	0,8	BCPR6ES	2330	12	BCPR6EIX	5689
Trans Sport V6	3.1		90 - 95	V6 SFI D	6	1,3	UR5	2139		UR5IX	7177
Trans Sport V6	3.4		96 -	V6 MFI E	6	1,3	TR55	1048		TR55IX	7164
Trans Sport V6	3.8		94 - 95	V6 SFI L	6	1,3	TR55	1048		TR55IX	7164
Trans Sport V6	3.8		01.92 - 93	V6 MFI L	6	1,3	TR55	1048		TR55IX	7164

**PORSCHE**

911 Carrera	3.2	160	89 - 89	930.21	6	0,7	BR8EVX	1262		BR8EIX	5044
911 Carrera	3.2	160	89 - 89	930.25	6	0,7	BR8EVX	1262		BR8EIX	5044
911 Speedster	3.2	160	89 - 89	930.25	6	0,7	BR8EVX	1262		BR8EIX	5044
911 Carrera	3.2	170	84 - 89	930.26	6	0,7	BR8EVX	1262		BR8EIX	5044
911 Carrera	3.2	170	84 - 89	930.20	6	0,7	BR8EVX	1262		BR8EIX	5044

<sup>1)</sup> Bic = Best in class



ℓ kW

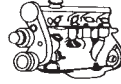

Cyl.

Order-  
No. No.Bic<sup>1)</sup> Order-  
D-Power No.**PORSCHE**

911 Turbo	3.3	221	81 - 89	930.66	6	0,6	BP8EVX	2671			
911 Turbo (964)	3.3	236	91 - 92	M30.69	6	0,7	BPR8EVX	5573			
911 Turbo S (964)	3.3	280	92 - 92	M30.69SL	6	0,7	BPR8EVX	5573			
911 Turbo Look (964)	3.6	184	92 - 92	M64.02	6	0,8	BCPR7ET	2164		BCPR7EIX	5690
911 Turbo Look (964)	3.6	184	92 - 92	M64.01	6	0,8	BCPR7ET	2164		BCPR7EIX	5690
911 Carrera RS America (964)	3.6	184	92 - 92	M64.01	6	0,8	BCPR7ET	2164		BCPR7EIX	5690
911 Carrera 2 (964)	3.6	184	90 - 93	M64.02	6	0,8	BCPR7ET	2164		BCPR7EIX	5690
911 Carrera 2 (964)	3.6	184	90 - 93	M64.01	6	0,8	BCPR7ET	2164		BCPR7EIX	5690
911 Carrera 4 (964)	3.6	184	90 - 93	M64.01	6	0,8	BCPR7ET	2164		BCPR7EIX	5690
911 Carrera RS (964)	3.6	191	92 - 92	M64.03	6	0,8	BCPR7ET	2164		BCPR7EIX	5690
911 Carrera 2 CUP (964)	3.6	195	90 - 90	M30...	6	0,8	BCPR7ET	2164		BCPR7EIX	5690
911 Turbo 3,6 (964)	3.6	265	93 - 93	M64.50	6	0,8	BKR6EK	2288	20	BKR6EQUIP	3199
911 Carrera 2 Speedster (993)	3.6	184	94 - 94	M64.01	6	0,8	BCPR7ET	2164		BCPR7EIX	5690
911 Carrera 2 (993)	3.6	184	94 - 95	M64.02	6	0,8	BCPR7ET	2164		BCPR7EIX	5690
911 Carrera 2 Speedster (993)	3.6	184	94 - 94	M64.02	6	0,8	BCPR7ET	2164		BCPR7EIX	5690
911 Carrera 4 Turbo Look (993)	3.6	184	94 - 94	M64.01	6	0,8	BCPR7ET	2164		BCPR7EIX	5690
911 Carrera 2 (993)	3.6	184	94 - 95	M64.01	6	0,8	BCPR7ET	2164		BCPR7EIX	5690
911 Carrera (993)	3.6	200	93 - 97	M64.08	6	0,8	BCPR7ET	2164		BCPR7EIX	5690
911 Carrera (993)	3.6	200	93 - 97	M64.24	6	0,8	BCPR7ET	2164		BCPR7EIX	5690
911 Carrera (993)	3.6	200	94 - 95	M64.06	6	0,8	BCPR7ET	2164		BCPR7EIX	5690
911 Carrera 4 (993)	3.6	200	95 - 95	M64.05	6	0,8	BCPR7ET	2164		BCPR7EIX	5690
911 Carrera (993)	3.6	200	94 - 95	M64.05	6	0,8	BCPR7ET	2164		BCPR7EIX	5690
911 Carrera (993)	3.6	200	93 - 97	M64.07	6	0,8	BCPR7ET	2164		BCPR7EIX	5690
911 Carrera (993)	3.6	200	93 - 97	M64.23	6	0,8	BCPR7ET	2164		BCPR7EIX	5690
911 Carrera 4 (993)	3.6	210	97 - 98	M64.21	6	0,8	BCPR7ET	2164		BCPR7EIX	5690
911 Carrera S (993)	3.6	210	97 - 98	M64.22	6	0,8	BCPR7ET	2164		BCPR7EIX	5690
911 Carrera S (993)	3.6	210	97 - 98	M64.21	6	0,8	BCPR7ET	2164		BCPR7EIX	5690
911 Carrera 4 S (993)	3.6	210	97 - 98	M64.21	6	0,8	BCPR7ET	2164		BCPR7EIX	5690
911 Carrera (993)	3.6	210	97 - 97	M64.21	6	0,8	BCPR7ET	2164		BCPR7EIX	5690
911 Carrera (993)	3.6	210	97 - 97	M64.22	6	0,8	BCPR7ET	2164		BCPR7EIX	5690
911 Carrera 4s (993)	3.6	221	96 - 96	M64.21	6	0,8	BCPR7ET	2164		BCPR7EIX	5690
911 Turbo 3.6 (993)	3.6	265	94 - 94	M64.50	6	0,8	BKR6EK	2288	20	BKR6EQUIP	3199
911 Turbo (993)	3.6	300	95 - 97	M64.60	6	0,8	BKR6EK	2288	20	BKR6EQUIP	3199
911 Turbo 3,6 (993)	3.6	300	98 - 98	M64.60	6	0,8	BKR6EK	2288	20	BKR6EQUIP	3199
911 GT2 (993)	3.6	316	96 - 98	M64.60R	6	0,8	BKR6EK	2288	20	BKR6EQUIP	3199
911 Carrera 4 (993)	3.8	210	96 - 96	M64.05	6	0,8	BCPR7ET	2164		BCPR7EIX	5690
911 Carrera (993)	3.8	210	96 - 96	M64.05	6	0,8	BCPR7ET	2164		BCPR7EIX	5690
911 Carrera (993)	3.8	210	96 - 96	M64.06	6	0,8	BCPR7ET	2164		BCPR7EIX	5690
911 Carrera RS America (993)	3.8	221	95 - 96	M64.20	6	0,8	BCPR7ET	2164		BCPR7EIX	5690
911 Carrera 2 (996)	3.4	221	99 - 00	M96.01	6		BKR6EQUIP	3199	30		
911 Carrera (996)	3.4	221	98 - 98	M96.01	6		BKR6EQUIP	3199	30		
911 Carrera 4 (996)	3.4	221	01 - 00	M96.04	6		BKR6EQUIP	3199	30		
911 Carrera 2 (996)	3.4	221	01 - 04	M96.04	6		BKR6EQUIP	3199	30		
911 Carrera 4 (996)	3.4	221	99 - 00	M96.02	6		BKR6EQUIP	3199	30		
911 Carrera (996)	3.6	235	01 - 03	M96.03	6		BKR7EQUIP	4285			
911 GT3 (996)	3.6	265	00 - 00	M96.76	6	0,8	BKR6EK	2288	20	BKR6EQUIP	3199
911 GT3 (996)	3.6	280	01 - 04	M96.76	6	0,7	BKR7EIX	2667		BKR7EIX	2667
911 Turbo (996)	3.6	309	01 - 06	M96.70	6	0,8	BCPR7ET	2164		BCPR7EIX	5690
911 GT2 (996)	3.6	340	01 - 04	M96.70S	6		BKR7EKC	7354			
911 Carrea (997)	3.6	239	04 -	M96.05	6		BKR7EQUIP	4285			
911 Carrea S (997)	3.8	261	04 -	M97.01	6		BKR7EQUIP	4285			
924 S	2.5	110	09.85 - 07.88	M 44.07/08/09/10	4	0,8	BPR6ES	7822	2	BPR6EIX	6637

<sup>1)</sup> Bic = Best in class



ℓ kW

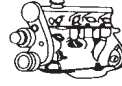

Cyl.

Order-  
No. No.Bic<sup>1)</sup> Order-  
D-Power No.**PORSCHE**

928 S4/CS	5.0	235	08.86 - 07.91	M 28.41/42	8	0,8	BPR6ES	7822	2	BPR6EIX	6637
928 GT	5.0	243	01.89 - 07.91	M 28.47	8	0,8	BPR6ES	7822	2	BPR6EIX	6637
928 GTS	5.4	250	08.91 - 11.95	M 28.49/50	8	0,8	BPR6ES	7822	2	BPR6EIX	6637
944 2.5	2.5	118	01.85 - 07.88	M 44.05/06/09/10	4	0,7	BPR6ES	7822	2	BPR6EIX	6637
944	2.5	135	08.86 - 07.88	M 44.40	4	0,7	BPR6ES	7822	2	BPR6EIX	6637
944 2.5 Turbo	2.5	162	08.85 - 07.88	M 44.50/51	4	0,7	BPR6ES	7822	2	BPR6EIX	6637
944 Turbo	2.5	162	08.85 - 07.88	M 44.50/51	4	0,7	BPR6ES	7822	2	BPR6EIX	6637
944 Turbo	2.5	184	09.87 - 07.91	M 44.52	4	0,7	BPR6ES	7822	2	BPR6EIX	6637
944 2.5 Turbo	2.5	184	09.87 - 07.91	M 44.52	4	0,7	BPR6ES	7822	2	BPR6EIX	6637
944	2.7	121	11.88 - 08.89	M 44.11/12	4	0,7	BPR6ES	7822	2	BPR6EIX	6637
944 S2	3.0	155	12.88 - 07.91	M 44.41	4	0,7	BPR7ES	2023	19	BPR7EIX	4055
959	2.8	330	05.86 - 07.88	959.50	6	0,7	BR8EVX	1262		BR8EIX	5044
968	3.0	176	08.91 - 11.95	M 44.43/44	4	0,8	BPR6ES	7822	2	BPR6EIX	6637
968 Turbo S	3.0	224	01.93 - 11.95		4	0,8	BKR6ES	3783	28	BKR6EIX	6418
Boxster (986)	2.5	150	09.96 - 08.99	M 96.20	6	0,8	BKR6EK	2288	20	BKR6EQUP	3199
Boxster (986)	2.7	168	07.02 -	M 96.23	6		BKR6EQUP	3199	30		
Boxster (986)	2.7	168	09.99 - 07.02	M 96.22	6		BKR6EQUP	3199	30		
Boxster S (986)	3.2	185	09.99 - 07.02	M 96.21	6		BKR6EQUP	3199	30		
Boxster S (986)	3.2	191	07.02 -	M 96.24	6		BKR6EQUP	3199	30		
Boxster (987)	2.7	176	12.04 -	M 96.25	6		BKR7EQUP	4285			
Cayenne (955)	2.5	128	04 -	BAC	5	█	Y-741U	5065		D-POWER 20	6943
Cayenne (955)	3.2	184	10.03 -	M 02.2Y BFD	6	0,9	IZKR7B	7563			
Cayenne S (955)	4.5	250	10.02 -	M 48.00	8		BKR6EQUP	3199	30		
Cayenne Turbo (955)	4.5	331	10.02 -	M 48.50	8		PFR7Q	7963			

**PRAGA**

14mm					4	0,7	B6HS	4510		BR6HIX	3419
18mm					4	0,7	A7	1110			

**PROTON**

1300	1.3		- 10.92		4	0,8	BPR6ES	7822	2	BPR6EIX	6637
1300	1.3		10.92 -	Multipoint	4	0,9	BPR5ES	7422	6	BPR5EIX	6597
1500	1.5		10.92 -	Multipoint	4	0,9	BPR5ES	7422	6	BPR5EIX	6597
1500	1.5		- 10.92		4	0,8	BPR6ES	7822	2	BPR6EIX	6637
313	1.3	55	96 -	(Mitsubishi)	4	1,1	BPR5ES-11	4424		BPR5EIX-11	2115
315	1.5	64	96 -	(Mitsubishi)	4	1,1	BKR6E-11	2756	14	BKR6EIX-11	3764
318 GTI	1.9	100	09.99 -		4	1,1	BKR6E-11	2756	14	BKR6EIX-11	3764
413	1.3	55	05.96 -	C96	4	1,1	BPR5ES-11	4424		BPR5EIX-11	2115
415	1.5	66	03.95 -	C97	4	1,1	BPR5ES-11	4424		BPR5EIX-11	2115
416	1.6	85	03.95 -	C98	4	1,1	BKR6E-11	2756	14	BKR6EIX-11	3764
418	1.8	85	05.96 -	C99	4	1,1	BKR6E-11	2756	14	BKR6EIX-11	3764
418 LRS	1.8	99	98 -		4	1,1	BKR6E-11	2756	14	BKR6EIX-11	3764
Persona	1.3			4G13	4	0,8	BPR6ES	7822	2	BPR6EIX	6637
Persona	1.5		11.93 -	4G15	4	0,9	BPR5ES	7422	6	BPR5EIX	6597
Persona	1.6		11.93 -	4G92	4	1,1	BKR6E-11	2756	14	BKR6EIX-11	3764
Persona	1.8		09.96 -	4G92	4	1,1	BKR6E-11	2756	14	BKR6EIX-11	3764
Satria	1.3		03.00 -		4	0,9	BPR5ES	7422	6	BPR5EIX	6597
Wira	1.5		03.00 -	4G15	4	1,1	BPR5ES-11	4424		BPR5EIX-11	2115
Wira	1.6		05.00 -	4G92	4	1,1	BKR6E-11	2756	14	BKR6EIX-11	3764
Wira	1.8		05.00 -		4	1,1	BKR6E-11	2756	14	BKR6EIX-11	3764

<sup>1)</sup> Bic = Best in class



ℓ kW

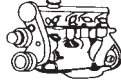

Cyl.

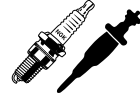
Order-  
No. No.Bic<sup>1)</sup> Order-  
D-Power No.**RELIANT**

Kitten					4	0,9	BPR5ES	7422	6	BPR5EIX	6597
Rebel			74 -		4	0,8	BPR6ES	7822	2	BPR6EIX	6637
Regal			74 -		4	0,8	BPR6ES	7822	2	BPR6EIX	6637
Rialto					4	0,9	BPR5ES	7422	6	BPR5EIX	6597
Robin			- 09.96		4	0,9	BPR5ES	7422	6	BPR5EIX	6597
Robin			09.96 -		4	0,8	BCPR5ES	6130	32	BCPR5EIX	5688
Scimitar	2.8				6	0,8	BPR6ES	7822	2	BPR6EIX	6637
Scimitar	3.0				6	0,8	BPR6ES	7822	2	BPR6EIX	6637
SS1	1.3				4	0,8	BCPR6E	1269	12	BCPR6EIX	5689
SS1	1.6				4	0,8	BCPR7ES	3330		BCPR7EIX	5690
SS1	1.8				4	1,1	BCPR6E-11	3132	11	BCPR6EIX-11	4919

**RENAULT**

Alpine A 310	2.6	110			6	0,8	BP6EFS	3812	5		
Alpine A 610	3.0			Z7X-744	6	0,9	BKUR7ET	7873		PFR7Q	7963
Alpine V 6 Turbo, Le Mans	2.5			Z7U-730/734 Z6W	6	0,6	BP7EFVX	3344			
Alpine V 6	2.9		03.85 - 12.92		6	0,8	BP6EFS	3812	5		
Avantime 16V Turbo	2.0	121	04.02 -	F4R-760 / 761	4	0,8	BKR6EIX	6418		BKR6EIX	6418
Avantime 2.0i 16V Turbo	2.0	121	04.02 -	F4R-T 760 / 762	4	0,9	PFR6G-9	4377			
Avantime	2.2	110	06.02 - 03		4	█	Y-517J	3319			
Avantime 24V V6	3.0	154	02.02 -		6	1,1	PLFR5A-11	6240			
Cavalier D					4	█	Y-902R	2237		D-POWER 1	7906
Cherokee D	2.1	59			4	█	Y-908R	4585		D-POWER 1	7906
Clio	1.1	35	06.90 - 03.96	C1E-700	4	0,8	BP5ES	6511	8	BPR5EIX	6597
Clio	1.2	40	06.90 - 02.98	E5F-710/716	4	0,8	BCP5ES	7496	16	BCPR5EIX	5688
Clio	1.2	40	06.90 - 02.98	E7F-706/700	4	0,8	BCP5ES	7496	16	BCPR5EIX	5688
Clio	1.2	40	11.94 - 03.96	C3G-720	4	0,8	BP5ESZ	4691		BPR5EIX	6597
Clio	1.2	40	06.90 - 02.98	E5F 710, E5F 716	4	0,8	BCP5ES	7496	16	BCPR5EIX	5688
Clio	1.2	44	07.97 - 02.98	D7F-730	4	0,8	BKR5EK	7956	23	BKR5EIX	6341
Clio	1.2	44	01.96 - 06.97	D7F-730	4	0,9	BK5ESZ	5675			
Clio	1.4	55	04.96 -	E7J-754	4	0,8	BCP5ES	7496	16	BCPR5EIX	5688
Clio	1.4	55	06.90 - 02.98	E6J-712 / 713	4	0,8	BCP5ES	7496	16	BCPR5EIX	5688
Clio	1.4	55	06.90 -	E7J-718 / 719	4	0,8	BCP5ES	7496	16	BCPR5EIX	5688
Clio	1.4	58	06.90 - 02.98	E7J-710 / 711	4	0,8	BCP5ES	7496	16	BCPR5EIX	5688
Clio	1.7	66	06.90 - 03.96	F2N 770	4	0,8	BP7ES	2412		BPR7EIX	4055
Clio	1.8	65	06.96 - 02.98	F3P-755	4	0,9	BP6ESZ	7639		PGR6D	6248
Clio	1.8	65	06.90 - 04.96	F3P-710/714	4	0,9	BP6ESZ	7639		PGR6D	6248
Clio	1.8	66	06.90 - 02.98	F3P	4	0,7	BP6ESZ	7639		PGR6D	6248
Clio	1.8	79	08.95 -	F3P-R758	4	0,7	BP6ES	7811	4	BPR6EIX	6637
Clio RSi	1.8	79	08.94 -	F3P 758 Cat.	4	0,8	BP7ES	2412		BPR7EIX	4055
Clio	1.8	81	02.91 - 04.96	F3P 712	4	0,7	BP6ESZ	7639		PGR6D	6248
Clio 16V	1.8	100	03.91 - 03.96	F7P 720, F7P 722	4	0,8	BKR6EK	2288	20	BKR6EQUIP	3199
Clio	1.9	47	05.90 - 02.91		4	█	Y-908R	4585		D-POWER 1	7906
Clio	1.9	48	05.90 - 09.98	F8Q-714/730/732	4	█	Y-913M	3965		D-POWER 15	5317
Clio	1.9	48	03.91 - 08.98	F8Q676/678/692/696	4	█	Y-927R	5171		D-POWER 19	4916
Clio Williams 2.0 16S	2.0	110	12.93 - 01.96	F7R-700	4	0,8	BKR6EK	2288	20	BKR6EQUIP	3199
Clio 2	1.2	44	10.99 -	D7F-726	4	0,9	BKR6EZ	4619		BKR6EIX	6418
Clio 2	1.2	44	03.98 -	D7F 720, 722	4	0,8	BKR5EK	7956	23	BKR5EIX	6341
Clio 2 16V	1.2	55	03.00 -	D4F-712	4	0,8	LZKAR7A	6799			
Clio 2	1.4	55	03.98 - 03.01	E7J-780	4	0,9	BKR5EZ	7642		BKR5EIX	6341
Clio 2 16V	1.4	73	03.98 - 06.00	K4J 712, 713	4	0,9	BKR6EZ	4619		BKR6EIX	6418
Clio 2	1.6	66	03.98 - 09.99	K7M-745	4	0,8	BKR5EK	7956	23	BKR5EIX	6341

<sup>1)</sup> Bic = Best in class



ℓ kW

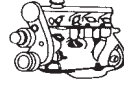

Cyl.

Order-  
No. No.Bic<sup>1)</sup> Order-  
D-Power No.**RENAULT**

Clio 2 16V	1.6	66	03.98 - 09.99	K7M-744	4	0,8	BKR5EK	7956	23	BKR5EIX	6341
Clio 2	1.6	81	02.99 -	K4M 748	4	0,9	BKR6EZ	4619		BKR6EIX	6418
Clio 2	1.9	48	03.98 - 12.03	F8Q630 / 662 BBOEOF	4	█	Y-506R	4409		D-POWER 7	2419
Clio 2	1.9	48	03.99 - 12.03	F8Q632	4	█	Y-516J	1436		D-POWER 12	6416
Clio 2 dTi	1.9	59	01.99 - 06.01	F9Q782	4	█	Y-740U	5104		D-POWER 22	4818
Clio 2 dTi	1.9	59	03.99 - 12.03	F9Q780	4	█	Y-515J	1019		D-POWER 18	6892
Clio 2 Dti	1.9	59	01.99 - 12.03	F9Q716	4	█	Y-740U	5104		D-POWER 22	4818
Clio 2 16V RS	2.0	126	01.00 -	F4R 730	4	1,0	PFR6E-10	3688			
Clio 2 Phase 2 8S	1.2	44	06.01 -	D7F 726	4	0,9	BKR5EZ	7642		BKR5EIX	6341
Clio 2 Phase 2	1.2	44	06.01 -	D7FGPL	4		BKR5EVX	2546		BKR5EIX	6341
Clio 2 Phase 2 16S	1.2	55	01.02 -	D4F-712	4	0,8	LZKAR7A	6799			
Clio 2 Phase 2 16S	1.4	72	06.01 -	K4J 710, 711	4	0,9	BKR6EZ	4619		BKR6EIX	6418
Clio 2 Phase 2 dCi	1.5	48	06.01 -	K9K704, 710	4	█	Y-515J	1019		D-POWER 18	6892
Clio 2 Phase 2 dCi	1.5	59	11.01 -	K9K702	4	█	Y-515J	1019		D-POWER 18	6892
Clio 2 Phase 2 dCi	1.5	74	04 -		4	█	Y-515J	1019		D-POWER 18	6892
Clio 2 Phase 2 16S	1.6	81	06.01 -	K4M 744, 745	4	0,9	BKR6EZ	4619		BKR6EIX	6418
Clio 2 Phase 2 16V RS	2.0	126	06.01 -	F4R 730	4	1,0	PFR6E-10	3688			
Clio 3 16V	1.2	55	07 -	D4F 722, 740, 772	4	0,9	LZKAR7B				
Clio 3 16V	1.2	55	06.05 -	D4F 740/764	4	0,8	LZKAR7A	6799			
Clio 3 TCE	1.2	74	05.07 -	D4F 780	4	0,7	ILKAR7A-7				
Clio 3 16V	1.4	70	06.05 -	K4J 780	4		BKR6EZ	4619			
Clio 3 Dci	1.5	51	06.05 -	K9K 768	4	█	Y-515J	1019		D-POWER 18	6892
Clio 3 Dci	1.5	62	06.05 -	K9K 766	4	█	Y-515J	1019		D-POWER 18	6892
Clio 3 Dci	1.5	77	06.05 -	K9K 764	4	█	Y-515J	1019		D-POWER 18	6892
Clio 3 16V	1.6	81	06.05 -	K4M 800/801/804	4		BKR6EZ	4619			
Clio 3 16V	2.0	103	04.06 -	M4R (Nissan)	4	1,1	PLZKAR6A-11	5118			
Clio 3 RS	2.0	147	06 -	F4R 830	4	0,9	PFR7Z-TG				
Grand Espace Turbo	2.0	121	03 -	F4R 760, 762	4	0,9	PFR6G-9	4377			
Grand Espace dCi 16S	2.2	85	06.00 - 09.02	G9T-710	4	█	Y-517J	3319			
Grand Espace dT	2.2	81	01.98 - 08.00	G8T-714/716	4	█	Y-730U	2273		D-POWER 17	6704
Grand Espace dCi 16S	2.2	96	06.00 - 09.02		4	█	Y-517J	3319			
Grand Espace dci	2.2	110	03 -	G9T	4	█	Y-517J	3319			
Espace 1	2.0	74	07.84 - 03.91	J6R	4	0,8	BP6EFS	3812	5		
Espace 1	2.0	77	06.87 - 03.91	J7R	4	0,7	BP7EFS	3526			
Espace 1	2.1	65	10.84 - 10.90	J8S240/774	4	█	Y-908R	4585		D-POWER 1	7906
Espace 2	2.0		04.91 - 10.96	J7R-768 Cat	4	0,8	BP6EFS	3812	5		
Espace 2	2.2	81	04.91 - 10.96	J7T-772 CAT	4	0,7	BP7EFS	3526			
Espace 2	2.2	85	91 - 10.96	G8T-714/716/760	4	█	Y-730U	2273		D-POWER 17	6704
Espace 2	2.8	113	04.91 - 10.96	Z7W-712/ 717 Cat	6	0,7	BP7EFS	3526			
Espace 3 dCi	1.9	74	02.99 - 12.02	F9Q-722	4	█	Y-515J	1019		D-POWER 18	6892
Espace 3 dTi	1.9	74	02.99 - 12.02	F9Q716/730/734	4	█	Y-740U	5104		D-POWER 22	4818
Grand Espace dTi	1.9	74	01.00 -	F9Q-730/734	4	█	Y-740U	5104		D-POWER 22	4818
Espace 3	2.0	85	11.96 - 09.00	F3R-728 /729 /768 /769	4	0,9	BPR5ES	7422	6	BPR5EIX	6597
Espace 3	2.0	103	10.98 -	F4R-700 /701	4	0,8	BKR6EK	2288	20	BKR6EQU	3199
Espace 3 dT	2.2	81	01.97 - 08.00	G8T-714/716	4	█	Y-730U	2273		D-POWER 17	6704
Espace 3 dCi	2.2	85	06.00 - 12.02	G9T-710	4	█	Y-517J	3319			
Espace 3 dCi	2.2	96	06.00 - 12.02		4	█	Y-517J	3319			
Espace 3	3.0	121	11.96 - 09.98	Z7X-775 V6	6	0,9	BCPR6ET	2197		BCPR6EIX	5689
Espace 3	3.0	140	10.98 -	L7X-727 V6 24V	6	1,0	PFR6E-10	3688			
Espace 4 DCI	1.9	86	10.02 -	F9Q	4	█	Y-515J	1019		D-POWER 18	6892
Grand Espace 4 Dci	1.9	86	10.02 -	F9Q	4	█	Y-515J	1019		D-POWER 18	6892
Espace 4	2.0	103	10.02 -	F4Rt	4	0,8	BKR6EK	2288	20	BKR6EQU	3199

<sup>1)</sup> Bic = Best in class



ℓ kW

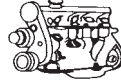

Cyl.

Order-  
No. No.Bic<sup>1)</sup> Order-  
D-Power No.**RENAULT**

Grand Espace 4	2.0	121	03 -	F4R	4	0,9	PFR6G-9	4377			
Espace 4 Turbo	2.0	121	10.02 -	F4R-760	4	0,9	PFR6G-9	4377			
Grand Espace 4 Dci	2.2	110	10.02 -		4	█	Y-517J	3319			
Espace 4 dci	2.2	110	03 -	G9T	4	█	Y-517J	3319			
Espace 4 dCi	3.0	132	10.02 -	P9X701	6	█	*CZ24				
Grand Espace 4	3.5	180	10.02 -	V4Y-711	6	1,1	PLFR5A-11	6240			
Espace 4	3.5	180	10.02 -	V4Y-711	6	1,1	PLFR5A-11	6240			
Express	1.6	40	07.86 - 03.98	F8M-720/730/736/760	4	█	Y-913M	3965		D-POWER 15	5317
Express	1.9	48	09.91 - 03.98	F8Q-684/722/724/ 774/776	4	█	Y-913M	3965		D-POWER 15	5317
Express	1.9	48	01.96 - 03.98	F8Q-640/680/682	4	█	Y-927R	5171		D-POWER 19	4916
Express	1.9	48	09.94 - 12.95	F8Q-640/644/646/648	4	█	Y-927R	5171		D-POWER 19	4916
Express	1.0		03.86 - 08.91	C1C706/700	4	0,8	BP5ES	6511	8	BPR5EIX	6597
Express	1.1	35	06.87 - 10.97	C1E-...	4	0,8	BP5ES	6511	8	BPR5EIX	6597
Express	1.4	44	03.86 - 09.91	C1J-... / C2J-...	4	0,8	BP5ES	6511	8	BPR5EIX	6597
Express	1.0		10.91 -	C1C-...	4	0,8	BP5ES	6511	8	BPR5EIX	6597
Express	1.2		10.91 - 10.97	C1G-...	4	0,8	BP5ES	6511	8	BPR5EIX	6597
Express	1.2	40	10.91 -	C3G-710 Cat.	4	0,9	BP5ESZ	4691		BPR5EIX	6597
Express	1.4		08.92 -	C3J-760 Cat.	4	0,9	BPR5ES	7422	6	BPR5EIX	6597
Express	1.4		10.91 -	E6J-...	4	0,8	BCP5ES	7496	16	BCPR5EIX	5688
Express	1.4	59	10.91 -	E7J... Cat.	4	0,8	BCP5ES	7496	16	BCPR5EIX	5688
Grand Scenic Dci	1.5	74	03.04 -	K9K	4	█	Y-515J	1019		D-POWER 18	6892
Grand Scenic 16 V	1.6	85	03.04 -	K4M	4	0,9	BKR6EZ	4619		BKR6EIX	6418
Grand Scenic Dci	1.9	88	03.04 -	F9Q	4	█	Y-515J	1019		D-POWER 18	6892
Grand Scenic 16 V	2.0	100	03.04 -	F4R	4	0,9	BKR6EZ	4619		BKR6EIX	6418
Grand Scenic Turbo	2.0	121	03.04 -	F4RT-760 / 762	4	0,9	PFR6G-9	4377			
Kangoo	1.2	44	05.00 -	D7FGPL	4		BKR5EVX	2546		BKR5EIX	6341
Kangoo	1.2	44	05.00 -	D7F-710 / 720 / 722 / 726 / 744 Euro2000	4	0,9	BKR6EZ	4619		BKR6EIX	6418
Kangoo	1.2	44	05.00 -	D7F726	4	0,9	BKR6EZ	4619		BKR6EIX	6418
Kangoo (XCOA)	1.2	44	10.97 - 04.00	D7F-710	4	0,8	BKR5EK	7956	23	BKR5EIX	6341
Kangoo 16V	1.2	55	07 -	D4F 722, 740, 772	4	0,9	LZKAR7B				
Kangoo 16V	1.2	55	07.00 -	D4F-712 / 714	4	0,8	LZKAR7A	6799			
Kangoo	1.4	55	07.00 -	K7J 700, 701	4	0,9	BKR5EZ	7642			
Kangoo (XCOC)	1.4	55	10.97 - 03.99	E7J-634 / 635 / 780	4	0,8	BKR5EZ	7642		BKR5EIX	6341
Kangoo dCi	1.5	48	06.01 -	K9K	4	█	Y-515J	1019		D-POWER 18	6892
Kangoo dCi	1.5	59	06.01 -	K9K	4	█	Y-515J	1019		D-POWER 18	6892
Kangoo 16V	1.6	70	07.01 -	K4M 708, 750, 752	4	0,9	BKR6EZ	4619		BKR6EIX	6418
Kangoo	1.6	70	07.01 -	K7M-746	4	0,8	BKR5EK	7956	23	BKR5EIX	6341
Kangoo Express D	1.9	40	03.98 -	F8Q-662	4	█	Y-516J	1436		D-POWER 12	6416
Kangoo Express D	1.9	48	03.99 -	F8Q-632	4	█	Y-516J	1436		D-POWER 12	6416
Kangoo Express D	1.9	48	03.98 -	F8Q-630	4	█	Y-506R	4409		D-POWER 7	2419
Kangoo dTi	1.9	59	03.98 -	F9Q780	4	█	Y-515J	1019		D-POWER 18	6892
Kangoo dCi 4X4	1.9	59	11.01 -		4	█	Y-515J	1019		D-POWER 18	6892
Kangoo 2 4X4	1.6	70	03 -	K4M	4	0,9	BKR6EZ	4619		BKR6EIX	6418
Kangoo Express Dci	1.5	48	07.03 -	K9K	4	█	Y-515J	1019		D-POWER 18	6892
Kangoo Express Dci	1.5	59	04 -	K9K	4	█	Y-515J	1019		D-POWER 18	6892
Kangoo Express Dci	1.9	62	04 -	F9Q	4	█	Y-515J	1019		D-POWER 18	6892
Laguna / Nevada	1.8	66	01.94 - 12.00	F3P-670/674/676/678	4	0,9	BP6ESZ	7639		PGR6D	6248
Laguna / Nevada	1.8	70	01.94 - 12.00	F3P-720/724	4	0,9	BP6ESZ	7639		PGR6D	6248
Laguna / Nevada	1.9	103	03.94 - 12.00	N7Q-700	4	0,8	BKR5EK	7956	23	BKR5EIX	6341
Laguna / Nevada	2.0	83	01.94 - 03.01	F3R-722/723	4	0,9	BP6ESZ	7639		PGR6D	6248

<sup>1)</sup> Bic = Best in class

\*only by car dealer



l kW

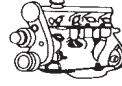

Cyl.

Order-  
No. No.Bic<sup>1)</sup> Order-  
D-Power No.**RENAULT**

Laguna / Nevada D	2.2	62	09.94 -	G8T...	4	█	Y-730U	2273		D-POWER 17	6704
Laguna / Nevada dT	2.2	85	03.96 -	G8T.Turbo	4	█	Y-730U	2273		D-POWER 17	6704
Laguna / Nevada	3.0	123	04.94 - 05.96	Z7X-760/765	6	0,8	BKR6EK	2288	20	BKR6EQU	3199
Laguna / Nevada	3.0	143	06.96 - 04.98	L7X 700/701	6	1,0	PFR6E-10	3688			
Laguna 2	1.6	81	01.01 -	K4M-720	4	0,8	BKR6ES	3783	28	BKR6EIX	6418
Laguna 2	1.8	87	01.01 -	K4M-720	4	0,8	BKR6ES	3783	28	BKR6EIX	6418
Laguna 2 / Estate dCi	1.9	74	03.99 -	F9Q710/717/718	4	█	Y-515J	1019		D-POWER 18	6892
Laguna 2 / Estate dCi	1.9	81	03.01 -		4	█	Y-515J	1019		D-POWER 18	6892
Laguna 2 / Estate dCi	1.9	88	01.01 -	F9QC750	4	█	Y-515J	1019		D-POWER 18	6892
Laguna 2 / Estate dCi	2.2	110	01.02 -	G9T710	4	█	Y-517J	3319			
Laguna 2	3.0	152	01.01 -	L7X-731	6	1,1	PLFR5A-11	6240			
Laguna 2 / Estate	1.6	81	01.01 -	K4M 720	4	0,9	BKR6EZ	4619		BKR6EIX	6418
Laguna 2 / Estate	1.8	87	01.01 -	F4P 760	4	0,8	BKR6ES	3783	28	BKR6EIX	6418
Laguna 2 / Estate 16 V	2.0	100	04 -	F4R atmo	4	0,9	BKR6EZ	4619		BKR6EIX	6418
Laguna 2 / Estate Turbo	2.0	121	03 -	F4RT-762	4	0,9	PFR6G-9	4377			
Laguna 2 / Estate	3.0	154	01.01 -	L7X	6	1,0	PFR6E-10	3688			
Laguna 3 16V	1.6	85	02.07 -	K4M	4	0,9	BKR6EZ	4619		BKR6EIX	6418
Laguna 3 16V	2.0	100	02.07 -	F4R	4	0,9	BKR6EZ	4619		BKR6EIX	6418
Laguna 3 Turbo	2.0	121	02.07 -	F4R 762	4	0,9	PFR6G-9	4377			
Laguna 3 Turbo	2.0	151	02.07 -	F4R 830	4	0,9	PFR7Z-TG				
Laguna / Nevada Phase 2	1.6	81	04.98 - 12.00	K4M-720/724	4	0,8	BKR5EK	7956	23	BKR5EIX	6341
Laguna / Nevada Phase 2	1.8	88	09.98 - 12.00	F4P-760	4	0,8	BKR6ES	3783	28	BKR6EIX	6418
Laguna / Nevada Phase2 dTi	1.9	74	10.97 -	F9Q-716/730/734	4	█	Y-740U	5104		D-POWER 22	4818
Laguna / Nevada Phase2 dCi	1.9	81	01.00 -	F9Q718	4	█	Y-515J	1019		D-POWER 18	6892
Laguna / Nevada Phase 2	2.0	85	04.98 - 08.98	F3R-...	4	0,8	BPR6ES	7822	2	BPR6EIX	6637
Laguna / Nevada Phase 2	2.0	103	02.99 - 12.00	F4R-780	4	0,8	BKR6ES	3783	28	BKR6EIX	6418
Laguna / Nevada Phase2 dT	2.2	80	04.98 -	G8T-Turbo	4	█	Y-730U	2273		D-POWER 17	6704
Laguna / Nevada Phase 2	3.0	143	05.98 - 12.00	L7X-700/701	6	1,0	PFR6E-10	3688			
Logan (X90)	1.4	55	05 -	K7J	4	0,9	BKR6E	6962	28	BKR6EIX	6418
Logan (X90)	1.6	66	05 -	K7M	4	0,9	BKR6E	6962	28	BKR6EIX	6418
Master T28 , T33 , T35			07.98 -		4	█	Y-502R	3852			
Master dCi	1.9	59	06.00 -	F9Q-770	4	█	Y-515J	1019		D-POWER 18	6892
Master	2.0	58		829../J5R..	4	0,7	BP6ES	7811	4	BPR6EIX	6637
Master D T30	2.1	45	11.81 - 96	852	4	█	Y-908R	4585		D-POWER 1	7906
Master	2.2			J7T-782	4	0,8	BP6EFS	3812	5		
Master dCi 16S	2.2	66	05.01 -		4	█	Y-517J	3319			
Master dCi	2.2	85	00 -	G9T-710	4	█	Y-517J	3319			
Master D T 30	2.4	52	06.82 - 96	8140 / S8U	4	█	Y-908R	4585		D-POWER 1	7906
Master Turbo D T 35	2.5	55	06.82 - 96	S9U	4	█	Y-908R	4585		D-POWER 1	7906
Master D	2.5	59	07.98 -	S8U-770/772	4	█	Y-502R	3852			
Master D	2.5	69	09.97 -	S8V-748	4	█	Y-935U	5915		D-POWER 23	4791
Master dCi 16S	2.5	88	10.00 -		4	█	Y-517J	3319			
Master dTi	2.8	85	09.97 -	S9W-700/702	4	█	Y-502R	3852			
Master DCI	3.0	96	01.07 -	ZD30CDTi	4	█	Y-522J				
Mégane	1.8	88	10.00 - 09.03	F4P-720 / 722	4	1,1	BKR6E-11	2756	14	BKR6EIX-11	3764
Mégane DTI	1.9	59	02.01 -	F9Q 744	4	█	Y-515J	1019		D-POWER 18	6892
Mégane / Classic	1.4	51	10.95 - 03.99	E7J 624	4	0,8	BCP5ES	7496	16	BCPR5EIX	5688
Mégane / Classic	1.4	55	10.95 - 03.99	E7J 764	4	0,8	BCP5ES	7496	16	BCPR5EIX	5688
Mégane / Classic	1.6	66	10.95 - 10.98	K7M 702, 703, 720	4	0,8	BCPR5ES	6130	32	BCPR5EIX	5688
Mégane / Classic GPL	1.6	66	07.97 - 04.99	K7M 702	4	0,6	BKR5EIX	6341		BKR5EIX	6341
Mégane / Classic	1.6	66	10.98 - 04.99	K7M 702, 703, 720	4	0,9	BKR5EZ	7642		BKR5EIX	6341
Mégane / Classic D	1.9	48	03.98 -	F8Q788	4	█	Y-506R	4409		D-POWER 7	2419

<sup>1)</sup> Bic = Best in class





ℓ kW

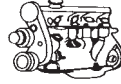

Cyl.

Order-  
No. No.Bic<sup>1)</sup> Order-  
D-Power No.**RENAULT**

Mégane / Classic D	1.9	48	01.96 -	F8Q620/624	4	█	Y-927R	5171		D-POWER 19	4916
Mégane / Classic D	1.9	48	03.99 - 02.01	F8Q622	4	█	Y-516J	1436		D-POWER 12	6416
Mégane / Classic dT	1.9	66	01.96 -	F8Q784/786	4	█	Y-932R	4956		D-POWER 25	7947
Mégane / Classic di	1.9	66	01.96 - 08.99	F9Q730/734	4	█	Y-740U	5104		D-POWER 22	4818
Mégane / Classic dTi	1.9	74	01.96 -	F9Q716/730/734	4	█	Y-740U	5104		D-POWER 22	4818
Mégane / Classic dCi	1.9	77	03.99 -	F9Q731/732/736/740	4	█	Y-515J	1019		D-POWER 18	6892
Mégane / Classic	2.0	85	10.95 - 03.99	F3R 750, 751, 791, 796, 797, 798	4	0,9	BPR5ES	7422	6	BPR5EIX	6597
Mégane / Classic	2.0	110	10.95 - 03.99	F7R 710, 714	4	0,8	BKR6EK	2288	20	BKR6EQUIP	3199
Mégane / Classic Phase 2	1.4	55	04.99 -	E7J 626	4	0,8	BKR6ES	3783	28	BKR6EIX	6418
Mégane / Classic Phase 2	1.4	70	09.99 -	K4J 750	4	0,9	BKR6EZ	4619		BKR6EIX	6418
Mégane / Classic Phase 2	1.6	66	04.99 -	K7M 704	4	0,8	BKR5EK	7956	23	BKR5EIX	6341
Mégane / Classic Phase 2	1.6	81	04.99 -	K4M 700, 701, 704, 706	4	0,9	BKR6EZ	4619		BKR6EIX	6418
Mégane 2	1.4	70	03 -	K4J 730	4	0,9	BKR6EZ	4619		BKR6EIX	6418
Mégane 2	1.6	85	03 -	K4M 760	4	0,9	BKR6EZ	4619		BKR6EIX	6418
Mégane 2	2.0	100	03 -	F4R	4	0,9	BKR6EZ	4619		BKR6EIX	6418
Mégane 2	2.0	121	05 -	F4R 762	4	0,9	PFR6G-9	4377			
Mégane RS	2.0	147	06 -	F4R 830	4	0,9	PFR7Z-TG				
Mégane RS	2.0	169	07 -	F4RT 774	4	0,9	PFR7Z-TG				
Mégane 2 1.5 dCi	1.5	59	09.03 -	K9K722	4	█	Y-515J	1019		D-POWER 18	6892
Mégane 2 1.5 dCi	1.5	59	09.03 -	K9K722	4	█	Y-515J	1019		D-POWER 18	6892
Mégane 2 Coupé	1.5	74	04 -	K9K	4	█	Y-515J	1019		D-POWER 18	6892
Mégane 2 Coupe dci	1.9	88	09.02 -	F9Q800	4	█	Y-515J	1019		D-POWER 18	6892
Mégane 2 1.5 dCi	1.5	59	09.02 -	K9K722	4	█	Y-515J	1019		D-POWER 18	6892
Mégane 2 Coupé / cab 16 V	1.4	72	03 -	K4J	4	0,9	BKR6EZ	4619		BKR6EIX	6418
Mégane 2 Coupé / cab 16V	1.6	85	03 -	K4M	4	0,9	BKR6EZ	4619		BKR6EIX	6418
Mégane 2 Coupé / cab	2.0	100	03 -	F4R	4	0,9	BKR6EZ	4619		BKR6EIX	6418
Mégane Coupé / cabrio	1.6	66	10.95 - 10.98	K7M 702, 703	4	0,8	BCPR5ES	6130	32	BCPR5EIX	5688
Mégane Coupé / cabrio	1.6	66	10.98 - 03.99	K7M 702, 703	4	0,9	BKR5EZ	7642		BKR5EIX	6341
Mégane Coupé / cabrio	2.0	85	10.95 - 03.99	F3R 750, 751, 791, 796, 797, 798	4	0,9	BPR5ES	7422	6	BPR5EIX	6597
Mégane Coupé / cabrio	2.0	110	10.95 - 03.99	F7R 710, 714	4	0,8	BKR6EK	2288	20	BKR6EQUIP	3199
Mégane Coupé / cab. phase 2	1.4	70	09.99 -	K4J 750	4	0,9	BKR6EZ	4619		BKR6EIX	6418
Mégane Coupé / cab. phase 2	1.6	81	04.99 -	K4M 700, 701	4	0,9	BKR6EZ	4619		BKR6EIX	6418
Mégane Coupé / cab. phase 2	1.8	87	05.01 -	F4P 760	4	0,8	BKR6ES	3783	28	BKR6EIX	6418
Mégane Phase 2 D	1.9	48	03.99 -	F8Q622/790	4	█	Y-516J	1436		D-POWER 12	6416
Mégane Phase 2 D	1.9	48	09.99 -	F8Q620/624	4	█	Y-927R	5171		D-POWER 19	4916
Mégane Phase 2 dTi	1.9	59	04.01 -	F9QT770	4	█	Y-515J	1019		D-POWER 18	6892
Mégane Phase 2 dTi	1.9	74	01.96 -	F9Q716/730/734	4	█	Y-740U	5104		D-POWER 22	4818
Mégane Phase 2 dCi	1.9	77	03.99 -	F9Q718/722/731/ 736/780	4	█	Y-515J	1019		D-POWER 18	6892
Mégane RS	2.0	165	03.04 -	F4RT	4	0,9	PFR7G-9	4371			
Mégane Scenic	1.9	48	03.99 -	F8Q622/790	4	█	Y-516J	1436		D-POWER 12	6416
Mégane Scenic	1.9	48	10.96 - 08.99	F8Q620/624	4	█	Y-927R	5171		D-POWER 19	4916
Mégane Scenic	1.9	48	03.98 -	F8Q788	4	█	Y-506R	4409		D-POWER 7	2419
Mégane Scenic di	1.9	66	10.96 - 08.99	F9Q716/730/734	4	█	Y-740U	5104		D-POWER 22	4818
Mégane Scenic	1.9	66	01.96 -	F8Q784/786	4	█	Y-932R	4956		D-POWER 25	7947
Mégane Scenic dTi	1.9	74	01.96 -	F9Q716/730/734	4	█	Y-740U	5104		D-POWER 22	4818
Modus	1.2	55	06.07 -	D4F 722, 740, 772	4	0,9	LZKAR7B				
Modus 16 V	1.2	55	09.04 - 05.07	D4F	4	0,8	LZKAR7A	6799			
Modus	1.2	74	05.07 -	D4F 780, 784	4	0,7	ILKAR7A-7				
Modus 16 V	1.4	81	09.04 -	K4M	4	0,9	BKR6EZ	4619		BKR6EIX	6418

<sup>1)</sup> Bic = Best in class



l kW

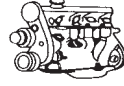

Cyl.

Order-  
No. No.Bic<sup>1)</sup> Order-  
D-Power No.**RENAULT**

Modus Dci	1.5	48	09.04 -	K9K	4	█	Y-515J	1019		D-POWER 18	6892
Modus Dci	1.5	59	09.04 -	K9K	4	█	Y-515J	1019		D-POWER 18	6892
Modus 16 V	1.6	83	09.04 -	K4J	4	0,9	BKR6EZ	4619		BKR6EIX	6418
R 4 alle Modelle			- 90		4	0,6	BP6HS	4511	18	BPR6HIX	4085
R 5	1.0	30	10.84 - 12.96	C1C-700	4	0,7	BP6ES	7811	4	BPR6EIX	6637
R 5	1.1	33	10.79 - 12.96	688 ..., C1E	4	0,6	BP6HS	4511	18	BPR6HIX	4085
R 5	1.2	40	10.86 - 12.96	C1G-720/722	4	0,7	BP6ES	7811	4	BPR6EIX	6637
R 5	1.4	43	10.84 - 12.96	C1J-768	4	0,7	BP6ES	7811	4	BPR6EIX	6637
R 5	1.4	44	10.84 - 12.96	C3J-700/702/760	4	0,9	BPR5ES	7422	6	BPR5EIX	6597
R 5	1.4	44	06.87 - 12.96	C2J-784	4	0,7	BP6ES	7811	4	BPR6EIX	6637
R 5	1.4	49	10.84 - 12.96	C2J-780/781/782	4	0,7	BP6ES	7811	4	BPR6EIX	6637
R 5	1.4	49	10.84 - 12.96	C2J-788/789/798	4	0,7	BP6ES	7811	4	BPR6EIX	6637
R 5	1.4	50	06.87 - 12.96	C2J-700	4	0,7	BP6ES	7811	4	BPR6EIX	6637
R 5 Turbo	1.4	77	10.84 - 12.96	C1J-782/784	4	0,7	B8EVX	7051		BR8EIX	5044
Super 5	1.6	40	09.85 - 12.90	F8M720/730	4	█	Y-913M	3965		D-POWER 15	5317
R 5	1.7	55	10.86 - 12.96	F3N-716/717	4	0,8	BPR6ES	7822	2	BPR6EIX	6637
R 5	1.7	66	06.87 - 12.96	F2N-740/742	4	0,7	BP6ES	7811	4	BPR6EIX	6637
R 5	1.7	69	10.86 - 12.96	F3N-702	4	0,8	BP7ES	2412		BPR7EIX	4055
R 9	1.2	40	09.85 - 03.91	C1G-700/710	4	0,7	BP6ES	7811	4	BPR6EIX	6637
R 9	1.4	45	09.81 -		4	0,7	BP6ES	7811	4	BPR6EIX	6637
R 9 Turbo	1.4	77	09.84 - 03.91	C1J-760,764,770	4	0,7	B8EVX	7051		BR8EIX	5044
R 9 D	1.6	40	01.83 - 12.92	F8M700/730	4	█	Y-913M	3965		D-POWER 15	5317
R 9	1.7			F3N-718	4	0,8	BPR6ES	7822	2	BPR6EIX	6637
R 9	1.7		09.84 -	F2N-../F3N-708	4	0,8	BP7ES	2412		BPR7EIX	4055
R 11	1.4	44	03.83 - 12.88	C1J 715/C2J73	4	0,7	BP6ES	7811	4	BPR6EIX	6637
R 11 Turbo	1.4	77	09.83 - 03.91	C1J-760,764,770	4	0,6	B8EVX	7051		BR8EIX	5044
R 11 D	1.6	40	01.83 - 03.91	F8M700/730	4	█	Y-913M	3965		D-POWER 15	5317
R 11	1.7			F3N-718	4	0,8	BPR6ES	7822	2	BPR6EIX	6637
R 11	1.7		10.83 - 03.91	F2N-..., F3N-708	4	0,8	BP7ES	2412		BPR7EIX	4055
R 19	1.2	40	09.88 - 30.92	C1G 730	4	0,9	BP5ESZ	4691		BPR5EIX	6597
R 19	1.4	43	09.88 - 03.92	C1J 742, C2J 772	4	0,9	BP5ESZ	4691		BPR5EIX	6597
R 19	1.4	50	09.88 - 03.96	C2J-776	4	0,8	BP5ES	6511	8	BPR5EIX	6597
R 19	1.4	59	09.88 - 03.92	E6J...,E7J.... Cat.	4	0,8	BGP5ES	7496	16	BCPR5EIX	5688
R 19	1.7	54	03.86 -	F3N-740/741	4	0,8	BPR6ES	7822	2	BPR6EIX	6637
R 19	1.7	55	09.88 - 03.96	F2N-724	4	0,8	BP7ES	2412		BPR7EIX	4055
R 19	1.7	66	09.88 - 03.92	F3N 746	4	0,8	BPR6ES	7822	2	BPR6EIX	6637
R 19	1.7	66	09.88 - 03.92	F3N-742/743 Cat	4	0,8	BP7ES	2412		BPR7EIX	4055
R 19	1.7	68	09.88 - 03.96	F2N-720/721	4	0,8	BP7ES	2412		BPR7EIX	4055
R 19 16V	1.8		06.89 - 03.96	F7P-704 Cat.	4	0,7	BGP6ES	4930	17	BCPR6EIX	5689
R 19	1.8	54	94 -	F3N-740 / 741	4	0,8	BPR6ES	7822	2	BPR6EIX	6637
R 19	1.8	81	06.89 - 03.92	F7P-700 Cat.	4	0,8	BKR6EK	2288	20	BKR6EIQP	3199
R 19 D	1.9	48	06.88 - 02.91	F8Q	4	█	Y-908R	4585		D-POWER 1	7906
R 19 D	1.9	48	03.91 - 12.95	F8Q706/742/764	4	█	Y-913M	3965		D-POWER 15	5317
R 19 tD	1.9	66	09.90 - 06.96	F8Q610/740/744/768	4	█	Y-933R	6136		D-POWER 25	7947
R 19 Phase 2	1.2	40	04.92 - 12.95	C1G-730	4	0,8	BP5ESZ	4691		BPR5EIX	6597
R 19 Phase 2	1.2	45	04.92 - 12.95	E7F730 Cat	4	0,8	BGP5ES	7496	16	BCPR5EIX	5688
R 19 Phase 2	1.4		04.92 - 12.95	E6J...,E7J.... Cat.	4	0,8	BGP5ES	7496	16	BCPR5EIX	5688
R 19 Phase 2	1.4		04.92 - 12.95	C1J-...	4	0,8	BP5ESZ	4691		BPR5EIX	6597
R 19 Phase 2	1.4	44	04.92 - 12.95	C3J-710 Cat.	4	0,9	BPR5ES	7422	6	BPR5EIX	6597
R 19 Phase 2	1.4	55	04.92 - 12.95	E7J-706	4	0,8	BGP5ES	7496	16	BCPR5EIX	5688
R 19 Phase 2	1.4	55	04.92 - 12.95	E7J-745	4	0,8	BGP5ES	7496	16	BCPR5EIX	5688
R 19 Phase 2	1.8		04.92 - 12.95	F3P-705	4	0,7	BP6ES	7811	4	BPR6EIX	6637

<sup>1)</sup> Bic = Best in class



ℓ kW

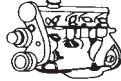

Cyl.

Order-  
No. No.Bic<sup>1)</sup> Order-  
D-Power No.**RENAULT**

R 19 Phase 2	1.8		04.92 - 12.95	F3P-707	4	0,7	BP6ES	7811	4	BPR6EIX	6637
R 19 Phase 2	1.8		04.92 - 12.95	F7P-700 Cat.	4	0,9	BP6ESZ	7639		PGR6D	6248
R 19 Phase 2	1.8	70	04.92 - 12.95	F3P-704/706 Cat.	4	0,7	BP6ES	7811	4	BPR6EIX	6637
R 19 Phase 2	1.8	99	04.92 - 12.95	F7P-704 Cat.	4	0,8	BKR6EK	2288	20	BKR6EQUIP	3199
R 21	1.4	51	09.89 - 10.93	C2J-...	4	0,7	BP6ES	7811	4	BPR6EIX	6637
R 21	1.7		09.89 - 12.95	F3N-726	4	0,8	BPR6ES	7822	2	BPR6EIX	6637
R 21 Nevada	1.7		09.89 - 12.95	F3N-722/723	4	0,8	BP7ES	2412		BPR7EIX	4055
R 21 Nevada	1.7	65	03.86 - 12.95	F2N-711	4	0,8	BP7ES	2412		BPR7EIX	4055
R 21 Nevada	1.7	65	02.88 - 12.95	F2N-754	4	0,8	BP7ES	2412		BPR7EIX	4055
R 21 D / Nevada	1.9	48	09.89 - 02.91	F8Q	4	█	Y-908R	4585		D-POWER 1	7906
R 21 D / Nevada	1.9	48	03.91 - 95	F8Q710	4	█	Y-908R	4585		D-POWER 1	7906
R 21	2.0	66	08.86 - 12.95	F2R-702	4	0,8	BP7ES	2412		BPR7EIX	4055
R 21	2.0	76	03.86 - 12.95	J6R-...	4	0,8	BP6EFS	3812	5		
R 21 Nevada	2.0	85	- 12.92	J7R-750/751	4	0,8	BP7EFS	3526			
R 21 Nevada	2.0	98	05.89 - 12.95	J7R-754	4	0,8	BCP6ET	4563		BCPR6EIX	5689
R 21	2.0	99	06.90 - 12.93	J7R-746/747	4	0,8	BP6EFS	3812	5		
R 21 Nevada	2.0	110	09.89 - 12.95	J7R-740	4	0,8	BCP6ET	4563		BCPR6EIX	5689
R 21 Nevada Turbo	2.0	119	01.93 -	J7R-756	4	0,8	BP7EFVX	3344			
R 21 Nevada Turbo	2.0	119	08.89 - 10.93	J7R-752	4	0,8	BP7EFVX	3344			
R 21 D / Nevada	2.1	53	09.89 - 12.93	J8S...	4	█	Y-908R	4585		D-POWER 1	7906
R 21 TD / Nevada	2.1	65	03.86 - 12.93	J8S...	4	█	Y-908R	4585		D-POWER 1	7906
R 21 Nevada	2.2	79	01.93 -	J7T-754/755	4	0,9	BP7EFS	3526			
R 25	2.0	74	01.84 - 12.92	J6R-706/707	4	0,8	BP6EFS	3812	5		
R 25	2.0	74	01.84 - 12.92	J6R-762/763	4	0,8	BP6EFS	3812	5		
R 25	2.0	88	06.87 - 12.92	J7R-722/723	4	0,9	BP7EFS	3526			
R 25	2.0	103	10.88 - 12.92	J7R-720/721/726	4	0,8	BCP6ET	4563		BCPR6EIX	5689
R 25 D	2.1	47	01.84 - 12.92	J8S-736	4	█	Y-908R	4585		D-POWER 1	7906
R 25 TD	2.1	63	01.84 - 12.92	J8S-708-/-738	4	█	Y-908R	4585		D-POWER 1	7906
R 25	2.2	79	10.86 - 12.92	J7T-706/707/730/731/ 732/733	4	0,9	BP7EFS	3526			
R 25 V6 Turbo	2.5	147	05.89 - 12.92	Z7U-700 Cat.	6	0,8	BP7EFVX	3344			
R 25 V6	2.8	110	06.87 - 12.92	Z7W-706/707 Cat.	6	0,9	BP7EFS	3526			
R 25 V6	2.8	110	06.87 - 12.92	Z7W-700/701	6	0,9	BP7EFS	3526			
Rapid 1,4	1.4		91 -		4	0,8	BCP5ES	7496	16	BCPR5EIX	5688
Rapid	1.9		03.86 -		4	█	Y-913M	3965		D-POWER 15	5317
Rapid Express	1.9	34	09.94 -	F8Q640	4	█	Y-927R	5171		D-POWER 19	4916
Safrane	1.9		06.92 - 09.96	N7Q 710, 711	4	0,8	BKR5EK	7956	23	BKR5EIX	6341
Safrane	2.0	77	06.92 - 09.96	J7R-732/733	4	0,8	BP6EFS	3812	5		
Safrane	2.0	97	04.92 - 09.96	J7R 734/735/738/739	4	0,8	BCP6ET	4563		BCPR6EIX	5689
Safrane dT	2.1	65	06.92 - 09.96	J8S760	4	█	Y-908R	4585		D-POWER 1	7906
Safrane	2.2		06.92 - 09.96	J7T-762	4	0,8	BP6EFS	3812	5		
Safrane	2.2	103	06.92 - 09.96	J7T-760/761	4	0,8	BCP6ET	4563		BCPR6EIX	5689
Safrane dT	2.5	83	03.93 - 09.96	S8U762/763	4	█	Y-914U	2643		D-POWER 1	7906
Safrane V6	3.0	123	10.96 -	Z7X-W755	6	0,8	BKR6EK	2288	20	BKR6EQUIP	3199
Safrane V6	3.0	125	06.92 - 09.96	Z7X-721/722/723/ 753/755	6	0,9	BCPR6ET	2197		BCPR6EIX	5689
Safrane Biturbo	3.0	194	94 - 09.96	Z7X-726	6	0,9	BKUR7ET	7873		PFR7Q	7963
Safrane Phase 2	1.9	100	10.96 - 12.00	N7Q-710/711	4	0,8	BKR5EK	7956	23	BKR5EIX	6341
Safrane Phase 2 dT	2.2	85	10.96 - 11.00	G8T740	4	█	Y-730U	2273		D-POWER 17	6704
Safrane Phase 2	2.5	121	10.96 - 12.00	N7U-700/701	6	0,8	BCPR6ES	2330	12	BCPR6EIX	5689
Safrane Phase 2 V6	3.0	125	10.96 - 03.99	Z7X-721/722/723/ 753/755	6	0,9	BCPR6ET	2197		BCPR6EIX	5689

<sup>1)</sup> Bic = Best in class



l kW

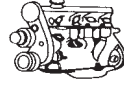

Cyl.

Order-  
No. No.Bic<sup>1)</sup> Order-  
D-Power No.**RENAULT**

Safrane Phase 2 V6	3.0	143	04.99-	L7X-713	6	1,0	PFR6E-10	3688				
Scenic	1.4	55	10.95-03.99	E7J-764	4	0,8	BCP5ES	7496	16	BCPR5EIX	5688	
Scenic	1.6	66	10.95-09.98	K7M-702,703,720	4	0,8	BCPR5ES	6130	32	BCPR5EIX	5688	
Scenic	1.6	66	10.98-03.99	K7M-702,703,720	4	0,9	BKR5EZ	7642		BKR5EIX	6341	
Scenic GPL	1.6	66	07.97-03.99	K7M-702	4	0,8	BKR5EK	7956	23	BKR5EIX	6341	
Scenic D	1.9	48	03.99-	F8Q-622/790	4	█	Y-516J	1436		D-POWER 12	6416	
Scenic D	1.9	48	03.98-	F8Q-788	4	█	Y-506R	4409		D-POWER 7	2419	
Scenic D	1.9	48	10.96-08.99	F8Q-620/624	4	█	Y-927R	5171		D-POWER 19	4916	
Scenic di	1.9	66	10.96-08.99	F9Q-716730/734	4	█	Y-740U	5104		D-POWER 22	4818	
Scenic dTi	1.9	74	01.96-	F9Q-716/730/734	4	█	Y-740U	5104		D-POWER 22	4818	
Scenic	2.0	85	10.95-03.99	F3R-750,751,791,796, 797,798	4	0,9	BPR5ES	7422	6	BPR5EIX	6597	
Scenic dT	1.9	66	01.96-	F8Q-784/786	4	█	Y-932R	4956		D-POWER 25	7947	
Scenic dci RX4	1.9	75	99-		4	█	Y-515J	1019		D-POWER 18	6892	
Scenic 2 & Break	1.4	72	03-	K4J	4	0,9	BKR6EZ	4619		BKR6EIX	6418	
Scenic 2 DCI	1.5	74	04-	K9K	4	█	Y-515J	1019		D-POWER 18	6892	
Scenic 2 & Break	1.6	85	03-	K4M	4	0,9	BKR6EZ	4619		BKR6EIX	6418	
Scenic 2 & Break	2.0	100	03-	F4R	4	0,9	BKR6EZ	4619		BKR6EIX	6418	
Scenic 2 dci	1.5	59	03-	K9K	4	█	Y-515J	1019		D-POWER 18	6892	
Scenic 2 dci	1.9	88	03-	F9Q	4	█	Y-515J	1019		D-POWER 18	6892	
Scenic Phase 2	1.4	70	09.99-	K4J- 750	4	0,9	BKR6EZ	4619		BKR6EIX	6418	
Scenic Phase 2	1.6	81	09.99-	K4M-708,709	4	0,9	BKR6EZ	4619		BKR6EIX	6418	
Scenic Phase 2	1.8	87	07.00-	F4P-760	4	0,8	BKR6ES	3783	28	BKR6EIX	6418	
Scenic Phase 2 D	1.9	48	09.99-		4	█	Y-927R	5171		D-POWER 19	4916	
Scenic Phase 2 dTi	1.9	59	06.01-	F9Q-T770	4	█	Y-515J	1019		D-POWER 18	6892	
Scenic Phase 2 dTi	1.9	74	09.99-	F9Q-730/734	4	█	Y-740U	5104		D-POWER 22	4818	
Scenic Phase 2 dCi RX4	1.9	77	09.00-	F9Q....	4	█	Y-515J	1019		D-POWER 18	6892	
Scenic Phase 2 dCi	1.9	77	03.99-	F9Q718/731/736	4	█	Y-515J	1019		D-POWER 18	6892	
Scenic Phase 2	2.0	103	08.99-	F4R-740,741	4	0,8	BKR6ES	3783	28	BKR6EIX	6418	
Scenic Phase 2	2.0	103	03.00-	F4R-744	4	0,8	BKR6ES	3783	28	BKR6EIX	6418	
Sport Spider	2.0	110	03.95-	F7R-710/712/720	4	0,8	BKR6EK	2288	20	BKR6EQUP	3199	
Super 5	1.0			C1C.	4	0,8	BP5ES	6511	8	BPR5EIX	6597	
Super 5	1.1			C1E	4	0,8	BP5ES	6511	8	BPR5EIX	6597	
Super 5	1.2			C1G	4	0,8	BP5ES	6511	8	BPR5EIX	6597	
Super 5	1.4			C2J	4	0,8	BP5ES	6511	8	BPR5EIX	6597	
Super 5 GT Turbo	1.4			C1J-782/784/788	4	0,7	B8EVX	7051		BR8EIX	5044	
Super 5	1.4	44	08.92-	C3J-760	4	0,9	BPR5ES	7422	6	BPR5EIX	6597	
Super 5 D	1.6	40	09.85-12.96	F8M-720/730	4	█	Y-913M	3965		D-POWER 15	5317	
Super 5	1.7			F2N...	4	0,8	BP7ES	2412		BPR7EIX	4055	
Supercinc D	1.6	40	09.85-		4	█	Y-913M	3965		D-POWER 15	5317	
Trafic T800 / P800	1.4	35	03.80-04.89	C1J-.../847-...	4	0,7	BP6ES	7811	4	BPR6EIX	6637	
Trafic V1000 / T1000 / 4X4	1.6			A1M-.../ 841	4	0,7	BP6ES	7811	4	BPR6EIX	6637	
Trafic P1200 / T1200	1.6			A1M-.../ 841	4	0,7	BP6ES	7811	4	BPR6EIX	6637	
Trafic T1100 / P1000	1.7	50	06.86-04.89	F1N-...	4	0,8	BP7ES	2412		BPR7EIX	4055	
Trafic D T 1000	1.9	45	11.97-	F8Q-600/606	4	█	Y-506R	4409		D-POWER 7	2419	
Trafic dCi	1.9	60	05.01-	F9Q762	4	█	Y-515J	1019		D-POWER 18	6892	
Trafic dCi	1.9	74	05.01-	F9Q760	4	█	Y-515J	1019		D-POWER 18	6892	
Trafic T1100/P1400/T1400/V1000	2.0	59	09.89-12.97	J5R- 829	4	0,7	BP6ES	7811	4	BPR6EIX	6637	
Trafic D P1000, P1200, 4x4	2.1	43	11.81-10.97	852/720/750	4	█	Y-908R	4585		D-POWER 1	7906	
Trafic D T800, T1000, T1200	2.1	43	09.80-10.97	J8S-620/758	4	█	Y-908R	4585		D-POWER 1	7906	
Trafic D T 1000	2.1	56	11.97-	S8U-758/780/782	4	█	Y-935U	5915		D-POWER 23	4791	
Trafic T1400	2.2			J7T 780	4	0,8	BP6EFS	3812	5			

<sup>1)</sup> Bic = Best in class



ℓ kW

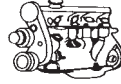

Cyl.

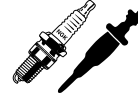
Order-  
No. No.Bic<sup>1)</sup> Order-  
D-Power No.**RENAULT**

Trafic D	2.5	52	10.82 - 10.97	S8U	4	█	Y-208T	1250			
Trafic D	2.5	55	03.90 - 10.97	Sofim 8140	4	█	Y-908R	4585		D-POWER 1	7906
Twingo easy	1.2	40	09.94 - 96	C3G-702	4	0,9	BP5ESZ	4691		BPR5EIX	6597
Twingo	1.2	40	03.93 - 06.97	C3G-700	4	0,9	BP5ESZ	4691		BPR5EIX	6597
Twingo	1.2	44	04.00 -	D7FGPL	4		BKR5EVX	2546		BKR5EIX	6341
Twingo	1.2	44	07.97 - 07.98	D7F-700 / 701 / 702 / 703 / 704 / 706	4	0,8	BKR5EK	7956	23	BKR5EIX	6341
Twingo	1.2	44	08.98 -	D7F-702, 703	4	0,8	BKR5EK	7956	23	BKR5EIX	6341
Twingo Euro2000	1.2	44	04.00 -	D7F-726	4	0,9	BKR6EZ	4619		BKR6EIX	6418
Twingo 16V	1.2	55	11.00 -	D4F-702	4	0,8	LZKAR7A	6799			
Twingo	1.2	44	01.96 - 06.97	D7F-730	4	0,8	BK5ESZ	5675			
Twingo 2	1.2	44	06.07 -	D4F 764	4	0,9	LZKAR7B				
Twingo 2	1.2	55	06.07 -	D4F 722, 740 , 772	4	0,9	LZKAR7B				
Twingo 2	1.2	74	06.07 -	D4F 780, 784	4	0,7	ILKAR7A-7				
Twingo 2 DCI	1.5	48	06.07 -	K9K	4	█	Y-515J	1019		D-POWER 18	6892
Vel Satis 16V Turbo	2.0	121	03.02 -	F4R-760 / 762	4	0,9	PFR6G-9	4377			
Vel Satis	2.0	147	06 -	F4R 830	4	0,9	PFR7Z-TG				
Vel Satis Dci	2.2	85	03.02 - 12.03	G9T	4	█	Y-517J	3319			
Vel Satis Dci	2.2	85	03.02 -		4	█	Y-517J	3319			
Vel Satis Dcil	2.2	110	03.02 - 12.03	G9T702	4	█	Y-517J	3319			
Vel Satis Dci V6	3.0	132	03.02 - 12.03	P9X (Isuzu)	6	█	*CZ24				
Vel Satis 24V V6	3.5	180	02.02 -	V4Y-701	6	1,1	PLFR5A-11	6240			

**ROLLS ROYCE**

Corniche 71-->02	6.75		07.93 - 08.95		8	0,9	BKR4EVX	4870			
Corniche 71-->02	6.75		03.87 - 12.88		8	0,7	BPR5EV	4728		BPR5EIX	6597
Corniche 71-->02	6.75		01.89 - 06.93		8	0,9	BPR4EVX	3436			
Corniche 71-->02	6.75		09.95 -		8		BKR5EVX	2546		BKR5EIX	6341
Flying Spur	6.75		08.94 - 07.95		8		BKR5EVX	2546		BKR5EIX	6341
Park Ward	5.4		10.00 -	V12 BMW	12		BKR6EQUP	3199	30		
Park Ward	6.8		02.97 - 09.00		8	0,9	BKR4EVX	4870			
Phantom	6.75		68 - 91		8	0,8	BP5ES	6511	8	BPR5EIX	6597
Silver Cloud	4.56				6	0,6	B6ES	7310			
Silver Cloud	6.25				8	0,8	BP5ES	6511	8	BPR5EIX	6597
Silver Dawn	6.75		94 - 98		8		BKR5EVX	2546		BKR5EIX	6341
Silver Seraph	5.4	240	98 - 07.99	BMW M73B54	12	0,8	BKR6EK	2288	20	BKR6EQUP	3199
Silver Seraph	5.4	240	08.99 -	BMW M73B54	12		BKR6EQUP	3199	30		
Silver Spirit/ Spur	6.75		12.86 - 12.88		8	0,7	BPR5EV	4728		BPR5EIX	6597
Silver Spirit/ Spur	6.75		07.93 -		8	0,9	BKR4EVX	4870			
Silver Spirit/ Spur	6.75		01.89 - 06.93		8	0,9	BPR4EVX	3436			

**ROVER**

25	1.1	43	11.99 -	K Series	4	1,0	PFR6N-11	3546			
25	1.4	62	11.99 -	K Series	4	1,1	PFR6N-11	3546			
25	1.6	79	11.99 -	K Series	4	1,0	PFR6N-11	3546			
25	1.8	85	99 -	K Series with VVC	4	1,1	PFR6N-11	3546			
25 Steptronic	1.8	86	05.01 -		4	1,1	PFR6N-11	3546			
25	1.8	107	02.00 -	K Series	4	1,1	PFR6N-11	3546			
25 TD	2.0	74	11.99 -		4	█	Y-730U	2273		D-POWER 17	6704
45	1.4	76	11.99 -	K Series	4	1,1	PFR6N-11	3546			
45	1.6	80	11.99 -	K Series	4	1,1	PFR6N-11	3546			
45	1.8	86	99 -	K Series	4	1,1	PFR6N-11	3546			

<sup>1)</sup> Bic = Best in class

\*only by car dealer



ℓ kW

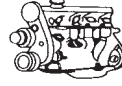

Cyl.

Order-  
No. No.Bic<sup>1)</sup> Order-  
D-Power No.**ROVER**

45 TD	2.0	73	11.99 -		4	☑	Y-730U	2273		D-POWER 17	6704
45	2.0	110	99 -	KV6	6	1,1	PFR6N-11	3546			
75 Turbo	1.8		07.02 -	K Series	4	1,1	PFR6N-11	3546			
75	1.8	87	02.99 -	K Series	4	1,0	PFR6N-11	3546			
75	2.0		02.99 -	M47R (BMW)	4	☑	Y-507R	4600		D-POWER 32	2691
75 2.0 CDT	2.0	85	99 -	M47R (BMW)	4	☑	Y-507R	4600		D-POWER 32	2691
75	2.0	109	02.99 -	K V6	6	1,0	PFR6N-11	3546			
75	2.5	128	02.99 -	K V6	6	1,0	PFR6N-11	3546			
90, 110 D			01.83 -		4	☑	Y-208T	1250			
111	1.1	44	91 -	K8 8 VALVE	4	0,9	BKR6E	6962	28	BKR6EIX	6418
114	1.4		91 -	K16	4	0,9	BKR6E	6962	28	BKR6EIX	6418
114 D	1.4	39		Peugeot TUD 3	4	☑	Y-911R	4544		D-POWER 33	4290
114	1.4	55	91 -	K8	4	0,9	BKR6E	6962	28	BKR6EIX	6418
115 SD/CSD	1.5	57	01.95 - 98	TUD 5	4	☑	Y-731U	5274		D-POWER 9	6281
211	1.1	43	01.98 - 04.99	K Series 8 V	4	0,8	BKR6ES	3783	28	BKR6EIX	6418
213 Mk.1	1.3		06.84 - 09.90	Honda	4	1,1	BPR6EY-11	4228	10	BPR6EIX-11	3903
214 Mk.2	1.4		10.89 -	K Series	4	0,9	BKR6E	6962	28	BKR6EIX	6418
214 Mk.3	1.4		11.95 -		4	0,9	BKR6E	6962	28	BKR6EIX	6418
216 Mk.1	1.6		03.85 - 09.90	Injection	4	0,8	BCPR6ES	2330	12	BCPR6EIX	5689
216 Mk.1	1.6		03.85 - 09.90	Vergaser/Carb.	4	0,7	BCP6ES	4930	17	BCPR6EIX	5689
216 Mk.3	1.6		11.95 -		4	0,9	BKR6E	6962	28	BKR6EIX	6418
216 Mk.2	1.6		09.90 -	DOHC	4	1,1	BCPR6E-11	3132	11	BCPR6EIX-11	4919
216 Mk.2	1.6		10.89 -	SOHC	4	1,1	BCPR6E-11	3132	11	BCPR6EIX-11	4919
217 SD, 218 SD/SLD	1.9	49	09.91 -	XUD 9	4	☑	Y-902R	2237		D-POWER 1	7906
218 Mk.3	1.8		01.96 -	K Series with VVC	4	1,1	PFR6N-11	3546			
218 TD	1.8	65	09.91 -	XUD 7 TE	4	☑	Y-902R	2237		D-POWER 1	7906
218 D	1.9	49	09.91 -	XUD 9	4	☑	Y-902R	2237		D-POWER 1	7906
220 Mk.2	2.0		06.91 -	T16 TURBO	4	0,9	BKR6E	6962	28	BKR6EIX	6418
220 SDi	2.0	63	10.95 -	20 T2R	4	☑	Y-730U	2273		D-POWER 17	6704
220 SDi	2.0	77	10.95 -	20T2N (Intercooled)	4	☑	Y-730U	2273		D-POWER 17	6704
400 D			01.87 -			☑	Y-902R	2237		D-POWER 1	7906
414 Mk.2	1.4		05.95 -		4	0,9	BKR6E	6962	28	BKR6EIX	6418
414 Mk.1	1.4		03.90 - 07.95		4	0,9	BKR6E	6962	28	BKR6EIX	6418
416 Mk.2	1.6		05.95 -	Schaltgetriebe	4	0,9	BKR6E	6962	28	BKR6EIX	6418
416 Mk.2	1.6		05.95 -	Automatik	4	1,1	BKR6E-11	2756	14	BKR6EIX-11	3764
416 Mk.1	1.6		03.90 -	SOHC	4	1,1	BCPR6E-11	3132	11	BCPR6EIX-11	4919
416 Mk.1	1.6		03.90 - 12.91	DOHC	4	1,1	BCPR6E-11	3132	11	BCPR6EIX-11	4919
Tourer 1.6	1.6	80	03.96 - 04.99	K Series	4	0,8	BKR6ES	3783	28	BKR6EIX	6418
418 SLD/GSD TD	1.8	65	09.91 - 03.96	XUD 7 T	4	☑	Y-902R	2237		D-POWER 1	7906
418	1.8	105	03.96 - 10.97	K Series	4	1,0	PFR6N-11	3546			
420 Turbo	2.0		92 -	T16 TURBO	4	0,9	BKR6E	6962	28	BKR6EIX	6418
420 Mk.2	2.0		12.95 -		4	0,7	BCP6ES	4930	17	BCPR6EIX	5689
420 Mk.1	2.0		10.91 - 11.94		4	0,9	BKR6E	6962	28	BKR6EIX	6418
420 SDi, SLDi TD	2.0		10.95 - 99	20 T2R, 20T2N (Intercooled)	4	☑	Y-730U	2273		D-POWER 17	6704
420 D / SD	2.0	63	07.95 -		4	☑	Y-730U	2273		D-POWER 17	6704
420 Di / Sdi	2.0	77	07.95 -		4	☑	Y-730U	2273		D-POWER 17	6704
618	1.8		02.96 -	Honda	4	1,1	ZFR6F-11	4291		ZFR6FIX-11	6441
620 Turbo	2.0		94 -	T Series	4	0,9	BKR6E	6962	28	BKR6EIX	6418
620 SDi, SLDi TD	2.0		10.95 - 99	20 T2R, 20T2N (Intercooled)	4	☑	Y-730U	2273		D-POWER 17	6704
620	2.0	85	04.93 -	HONDA	4	1,1	ZFR6F-11	4291		ZFR6FIX-11	6441
623	2.3	116	04.94 -	HONDA	4	1,1	ZFR6F-11	4291		ZFR6FIX-11	6441
820 i	2.0		91 -	20T4 MPI	4	0,9	BKR6E	6962	28	BKR6EIX	6418

<sup>1)</sup> Bic = Best in class



ℓ kW

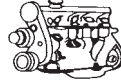

Cyl.

Order-  
No. No.Bic<sup>1)</sup> Order-  
D-Power No.**ROVER**

820	2.0		11.91 -	T16 / Turbo/ Inj.	4	0,9	BKR6E	6962	28	BKR6EIX	6418
820	2.0		05.88 - 09.90	Vergaser/Carb.	4	0,8	BPR6ES	7822	2	BPR6EIX	6637
820	2.0		03.91 - 10.91	M16 Turbo Inj.	4	0,9	BKR6E	6962	28	BKR6EIX	6418
820	2.0		07.86 - 10.91	M16 Inj.	4	0,9	BKR6E	6962	28	BKR6EIX	6418
820 E,SE	2.0	88	10.86 - 90	M16E	4	0,8	BCPR6ES	2330	12	BCPR6EIX	5689
820 i,Si	2.0	98	10.86 - 90	M16i	4	0,8	BCPR6ES	2330	12	BCPR6EIX	5689
820 Turbo	2.0	132	10.92 -	20T4 TURBO MPI	4	0,9	BKR6E	6962	28	BKR6EIX	6418
825 i	2.5		01.96 -	KV6	6	0,9	BKR6E	6962	28	BKR6EIX	6418
825	2.5		07.86 - 02.88		6	1,1	BCPR6E-11	3132	11	BCPR6EIX-11	4919
825 D/SD/SLD	2.5		90 - 03.96	VM	4	█	Y-902R	2237		D-POWER 1	7906
825	2.5		03.96 - 10.99	VM	4	█	Y-741U	5065		D-POWER 20	6943
825 SD TD	2.5	87	01.93 -	VM HR-492/VM 425 SLIRR	4	█	Y-923U	3380		D-POWER 1	7906
827	2.7		02.88 - 01.96	C27A V6	6	1,1	BCPR6E-11	3132	11	BCPR6EIX-11	4919
2400 TD			82 -		4	█	Y-902R	2237		D-POWER 1	7906
City Rover 1.4	1.4		10.03 -	K Series	4	0,8	BK6E	3536		BKR6EIX	6418
FL 2 / R (Hire Car) D			08.83 -			█	Y-208T	1250			
FX 4R Taxi D			08.83 -			█	Y-208T	1250			
Maestro 500/700 D			86 - 89		4	█	Y-902R	2237		D-POWER 1	7906
Maestro	1.3	51	03.89 - 12.94		4	0,8	BPR6ES	7822	2	BPR6EIX	6637
Maestro	1.6	63	07.89 - 04.92	S Series	4	0,8	BCPR6ES	2330	12	BCPR6EIX	5689
Maestro TD	2.0	60	07.89 -	Perkins-Prima 80 T	4	█	Y-902R	2237		D-POWER 1	7906
Maestro Van TD	2.0	60	01.86 -		4	█	Y-902R	2237		D-POWER 1	7906
Metro	1.1		05.90 - 12.94	K8	4	0,9	BKR6E	6962	28	BKR6EIX	6418
Metro /16V/16V GTI	1.4		05.90 - 01.95	K8/K16/K16	4	0,9	BKR6E	6962	28	BKR6EIX	6418
Metro D	1.4	39	01.92 - 01.95	Peugeot TUD 3	4	█	Y-911R	4544		D-POWER 33	4290
MG RV8	3.9	140	94 -	V8i	8	0,8	BPR6ES	7822	2	BPR6EIX	6637
Mini	1.0		10.89 - 04.92		4	0,8	BPR6ES	7822	2	BPR6EIX	6637
Mini	1.3		10.89 -	not Turbo	4	0,8	BPR6ES	7822	2	BPR6EIX	6637
Mini	1.3		10.89 - 01.90	Turbo	4	0,8	BPR7ES	2023	19	BPR7EIX	4055
Mini Cooper i	1.3	46	91 -	12A2EF77/SPI	4	0,8	BPR6ES	7822	2	BPR6EIX	6637
Montego	1.4		12.94 -		4	0,7	BCP6ES	4930	17	BCPR6EIX	5689
Montego	1.6		04.89 - 01.93		4	0,8	BCPR6ES	2330	12	BCPR6EIX	5689
Montego	2.0		04.89 - 12.94		4	0,8	BPR6ES	7822	2	BPR6EIX	6637
Montego TD	2.0	60	09.88 -	Perkins-Prima 80 T	4	█	Y-902R	2237		D-POWER 1	7906
Sterling	2.5		10.87 -	C25A V6	6	0,8	BCPR6ES	2330	12	BCPR6EIX	5689
Sterling	2.7		02.88 -	C27A V6	6	1,1	BCPR6E-11	3132	11	BCPR6EIX-11	4919
Vanden Plas EFi	1.6	75	03.85 - 09.89	S-Series	4	1,1	BCPR6E-11	3132	11	BCPR6EIX-11	4919
Vitesse	1.6	75	03.85 - 09.89	S-Series	4	0,8	BCPR6ES	2330	12	BCPR6EIX	5689

**SAAB**

900 Turbo 16V/S/SE/Cabrio.	2.0			B202L	4	0,6	BCP7EVX	7681		BCPR7EIX	5690
900	2.0		- 93	B202	4	0,7	BCP5EVX	5664		BCPR5EIX	5688
900	2.0		- 93	B212	4	0,7	BCP5EVX	5664		BCPR5EIX	5688
900 Turbo	2.0		83 - 93	B201 mit / with APC	4	0,8	BP7EVX	7270		BPR7EIX	4055
900 Turbo 16V	2.0		- 93	B202	4	0,8	BCP7EV	3733		BCPR7EIX	5690
900 S/Cabrio.	2.0		- 93	B202S	4	0,6	BCP7EVX	7681		BCPR7EIX	5690
900	2.0	74	- 93	B201C	4	0,7	BP6ES	7811	4	BPR6EIX	6637
900	2.0	96	08.94 - 02.98	B204i	4	0,7	BCP5EVX	5664		BCPR5EIX	5688
900	2.0	136	10.93 -	B204L	4	1,1	BCPR7ES-11	1095		BCPR7EIX-11	5691
900	2.3	110	10.93 -	B234I	4	0,7	BCP6EVX	6323		BCPR6EIX	5689
900	2.5		10.93 -	B258i, B308i	6	0,9	BKR6EK	2288	20	BKR6EQUIP	3199
900	2.5	125	94 -	B258 Motronic	6	0,8	BKR5EK	7956	23	BKR5EIX	6341

<sup>1)</sup> Bic = Best in class



l kW

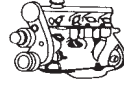

Cyl.

Order-  
No. No.Bic<sup>1)</sup> Order-  
D-Power No.**SAAB**

9000 CDi-16	2.0			B202i	4	0,7	BCP6EVX	6323				
9000	2.0		94 - 96	B202 mit Di	4	0,8	BCPR7ES	3330			BCPR7EIX	5690
9000	2.0		94 - 96	B202S mit Di	4	0,8	BCPR7ES	3330			BCPR7EIX	5690
9000	2.0		- 93	B202i ohne Di	4	0,7	BCP5EVX	5664			BCPR5EIX	5688
9000	2.0	87	09.84 - 12.98	B202L	4	1,0	BCPR7ES-11	1095			BCPR7EIX-11	5691
9000	2.0	96	94 - 98	B204i	4	0,7	BCP5EVX	5664			BCPR5EIX	5688
9000	2.0	110	94 - 98	B204 E	4	1,1	BCPR7ES-11	1095			BCPR7EIX-11	5691
9000	2.3	96	94 - 96	B234I	4	0,7	BCP6EVX	6323			BCPR6EIX	5689
9000 CS 2.3-16	2.3	107	09.91 -	B234I Cat.	4	1,1	BCPR6ES-11	7121	11		BCPR6EIX-11	4919
9000	2.3	125	94 - 98	B234 E	4	1,1	BCPR7ES-11	1095			BCPR7EIX-11	5691
9000	2.3	147	92 - 98	B234L	4	1,1	BCPR7ES-11	1095			BCPR7EIX-11	5691
9000 Aero	2.3	165	93 - 98	B234R	4	1,1	BCPR7ES-11	1095			BCPR7EIX-11	5691
9000 V6	3.0	155	11.94 -	B308 V6	6	0,8	BKR5EK	7956	23		BKR5EIX	6341
9-3 t	1.8	110	09.02 -	B207L	4	1,0	PFR6T-10G	5542				
9-3 TiD	1.9	88	03.05 -	Z19DT Fiat	4	█	YE07	6092				
9-3 TiD	1.9	110	03.05 -	Z19DTH Fiat	4	█	YE07	6092				
9-3 16V Pack	2.0	96	04.98 -	B204i	4	0,7	BCP5EVX	5664				
9-3	2.0	96	02.98 -	B204Ei	4	0,7	BCP5EVX	5664			BCPR5EIX	5688
9-3	2.0	110	09.02 -	L 850	4	1,0	PFR6T-10G	5542				
9-3	2.0	110	10.98 -	B204E	4	1,1	BCPR7ES-11	1095			BCPR7EIX-11	5691
9-3 Turbo	2.0	129	09.02 -	B207E	4	1,0	PFR6T-10G	5542				
9-3	2.0	136	00 -	B205L	4	1,0	PFR6H-10	6290				
9-3	2.0	136	98 - 99	B204L	4	1,1	BCPR7ES-11	1095			BCPR7EIX-11	5691
9-3	2.0	147	08.98 - 99	B204R	4	1,1	BCPR7ES-11	1095			BCPR7EIX-11	5691
9-3	2.0	150	00 -	B205R	4	1,0	PFR6H-10	6290				
9-3 Turbo	2.0	154	09.02 -	B207R	4	1,0	PFR6T-10G	5542				
9-3 TiD	2.2	85	09.98 -	X22DTH Opel		█	Y-748U	5000			D-POWER 14	6649
9-3	2.3	110	02.98 - 12.98	B234I	4	0,7	BCP6EVX	6323			BCPR6EIX	5689
9-3	2.3	169	10.99 - 09.01	B235R	4	1,0	PFR6H-10	6290				
9-3	2.5	125	98 -	B258 Motronic	6	0,8	BKR5EK	7956	23		BKR5EIX	6341
9-3 Aero Turbo	2.8	184	04.05 -	B28 HFV6	6	1,0	PLFR6C-10G	1959				
9-5	2.0	110	09.97 -	B205E	4	1,1	BCPR7ES-11	1095			BCPR7EIX-11	4485
9-5	2.0	140	09.97 -	B205E Trim Kit	4	1,0	PFR6H-10	6290				
9-5 TiD	2.2	88	01.02 -		4	█	Y-748U	5000			D-POWER 14	6649
9-5	2.3	125	09.97 -	B235E	4	1,1	BCPR6ES-11	7121	11		BCPR6EIX-11	4919
9-5 t SE	2.3	136	01.01 -	B205L	4	1,0	PFR6H-10	6290				
9-5	2.3	162	07.03 -	B235L	4	1,1	BCPR6ES-11	7121	11		BCPR6EIX-11	4919
9-5	2.3	165	07.98 -	B235R	4	1,0	PFR6H-10	6290				
9-5	2.3	169	10.99 - 09.01	B235R	4	1,0	PFR6H-10	6290				
9-5	2.3	184	10.99 -	B235R	4	1,0	PFR6H-10	6290				
9-5 V6	3.0	147	09.97 -	B308E	6	1,1	BKR7ES-11	2387			BKR7EIX-11	6988

**SAM SUNG**

SM518	1.8			DOHC	4	1,1	PFR5G-11	2647				
SM520	2.0			DOHC	4	1,1	PFR5G-11	2647				
SM520	2.0			DOHC LPG	4		BKR6EIX-LPG	3356				
SM520 V6	2.0			DOHC	6	1,1	PFR5G-11	2647				
SM525 V6	2.5			DOHC	6	1,1	PFR5G-11	2647				

**SAO**

PENZA	1.3				4	0,9	BPR5ES	7422	6		BPR5EIX	6597
-------	-----	--	--	--	---	-----	--------	------	---	--	---------	------

<sup>1)</sup> Bic = Best in class





ℓ kW

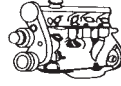

Cyl.

Order-  
No. No.Bic<sup>1)</sup> Order-  
D-Power No.**SEAT**

1.430 Especial 1.600	1.6	70			4	0,6	BP7ES	2412		BPR7EIX	4055
1.430 Especial 1.800	1.8	79			4	0,6	BP7ES	2412		BPR7EIX	4055
124 D	1.2	48			4	0,7	BP6ES	7811	4	BPR6EIX	6637
124 D	1.6	70			4	0,6	BP7ES	2412		BPR7EIX	4055
124 D	1.8	79			4	0,6	BP7ES	2412		BPR7EIX	4055
124 Especial	1.4	55			4	0,7	BP6ES	7811	4	BPR6EIX	6637
124 Sport 1.600	1.6	81			4	0,6	BP7ES	2412		BPR7EIX	4055
124 Sport 1.800	1.8	87			4	0,6	BP7ES	2412		BPR7EIX	4055
124-2.000	1.9				4	0,6	BP7ES	2412		BPR7EIX	4055
127	0.9	33			4	0,7	BP6ES	7811	4	BPR6EIX	6637
127	0.9	37			4	0,7	BP6ES	7811	4	BPR6EIX	6637
127	1.0	38			4	0,7	BP6ES	7811	4	BPR6EIX	6637
128-1.200 3p	1.2	48			4	0,7	BP6ES	7811	4	BPR6EIX	6637
128-1.430 3p	1.4	57			4	0,7	BP6ES	7811	4	BPR6EIX	6637
131/Supermirafiori 1.430	1.4	55			4	0,7	BP6ES	7811	4	BPR6EIX	6637
131/Supermirafiori 1.600	1.6	70			4	0,6	BP7ES	2412		BPR7EIX	4055
131/Supermirafiori 1.800	1.8	79			4	0,6	BP7ES	2412		BPR7EIX	4055
131/Supermirafiori 2.000	1.9				4	0,6	BP7ES	2412		BPR7EIX	4055
132-1.600	1.6	70			4	0,6	BP7ES	2412		BPR7EIX	4055
132-1.800	1.8	79			4	0,6	BP7ES	2412		BPR7EIX	4055
132-2.000	1.9				4	0,6	BP7ES	2412		BPR7EIX	4055
133	0.8	25			4	0,7	BP6ES	7811	4	BPR6EIX	6637
133	0.8	27			4	0,7	BP6ES	7811	4	BPR6EIX	6637
1430	1.4	42			4	0,7	BP6ES	7811	4	BPR6EIX	6637
1500	1.5	55			4	0,7	BP6ES	7811	4	BPR6EIX	6637
600 D, E	0.8				4	0,6	BP6HS	4511	18*	BPR6HIX	4085
850 Coupé	0.8				4	0,7	BP6ES	7811	4	BPR6EIX	6637
850 D	0.8	27			4	0,7	BP6ES	7811	4	BPR6EIX	6637
850 Especial	0.8	35			4	0,7	BP6ES	7811	4	BPR6EIX	6637
850 Spider	0.9				4	0,7	BP6ES	7811	4	BPR6EIX	6637
Alhambra	1.8	110	06.00 -	AWC	4	0,8	PFR6Q	6458			
Alhambra	1.8	110	05.98 - 02.00	AJH	4	0,8	BKR6ETA-10	7998			
Alhambra TDI	1.9	66	07.96 - 02.00	AHU	4	█	Y-732U	2408		D-POWER 4	6001
Alhambra TDI	1.9	66	04.95 - 07.96	1Z	4	█	Y-732U	2408		D-POWER 4	6001
Alhambra	1.9	66	06.00 -	ANU	4	█	Y-732U	2408		D-POWER 4	6001
Alhambra TDI	1.9	81	09.97 - 02.00	AFN	4	█	Y-732U	2408		D-POWER 4	6001
Alhambra TDI	1.9	85	06.00 -	AUY	4	█	Y-732U	2408		D-POWER 4	6001
Alhambra	2.0	85	03.96 - 02.00	ADY	4	0,8	BKUR6ET	6437	27	PFR6Q	6458
Alhambra	2.0	85	06.00 -	ATM	4	1,0	BKUR6ET-10	2397	24	PFR6Q	6458
Alhambra	2.8	128	06.96 -	AAA	6	0,8	BKR5EKUP	2890			
Alhambra	2.8	150	06.00 -	AYL	6	1,1	PZFR5D-11	7968	34		
Alhambra	2.8	150	06.00 - 04.02	AUE	6	1,1	PZFR5D-11	7968	34		
Altea	1.4	63	05.06 -	BXW	4	1,1	ZFR6T-11G	5960			
Altea	1.6	75	05.05 - 09	BSF	4	1,0	BKUR6ET-10	2397	24	PFR6Q	6458
Altea	1.6	75	03.04 - 05.05	BGU	4	1,0	BKUR6ET-10	2397	24	PFR6Q	6458
Altea	1.6	75	05.05 - 05.07	BSE	4	1,0	BKUR6ET-10	2397	24	PFR6Q	6458
Altea FSI	1.8	118	01.07 -	BYT	4	0,8	PFR6S-8E				
Altea FSI 16V	2.0	110	11.05 -	BVZ	4	1,1	PZFR5N-11TG				
Altea FSI 16V	2.0	110	11.05 -	BVY	4	1,1	PZFR5N-11TG				
Altea	2.0	110	11.04 - 11.05	BLY	4	1,1	PZFR5N-11TG				
Altea	2.0	110	05.04 - 11.05	BLR	4	1,1	PZFR5N-11TG				
Altea TFSI	2.0	147	02.06 -	BWA	4	0,8	PFR6Q	6458			

<sup>1)</sup> Bic = Best in class



ℓ kW

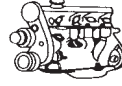

Cyl.

Order-  
No. No.Bic<sup>1)</sup> Order-  
D-Power No.**SEAT**

Arosa	1.0	37	02.97 - 09.99	AER	4	0,8	BUR6ET	3172	1	PGR6D	6248
Arosa	1.0	37	07.00 - 06.04	AUC	4	1,1	PZFR5D-11	7968	34		
Arosa	1.0	37	07.99 - 07.00	ALD	4	1,1	PZFR5D-11	7968	34		
Arosa	1.0	37	07.99 - 07.00	ANV	4	1,1	PZFR5D-11	7968	34		
Arosa	1.0	37	11.98 - 02.00	AHT	4	1,0	BKR6ETA-10	7998			
Arosa	1.0	37	08.97 - 06.99	ALL	4	0,8	BUR6ET	3172	1	PGR6D	6248
Arosa	1.4	44	07.99 - 10.00	ANW	4	1,1	PZFR5D-11	7968	34		
Arosa	1.4	44	05.97 - 09.99	AKV	4	0,8	BUR6ET	3172	1	PGR6D	6248
Arosa	1.4	44	02.97 - 11.97	AEX	4	0,8	BUR6ET	3172	1	PGR6D	6248
Arosa	1.4	44	09.00 - 06.04	AUD	4	1,1	PZFR5D-11	7968	34		
Arosa	1.4	44	07.99 - 10.00	AKK	4	1,1	PZFR5D-11	7968	34		
Arosa	1.4	44	12.97 - 08.99	APQ	4	0,8	BUR6ET	3172	1	PGR6D	6248
Arosa 16V	1.4	55	01.98 -	AHW	4	1,0	BKUR6ET-10	2397	24	PFR6Q	6458
Arosa TDI	1.4	55	09.99 - 06.04	AMF	3	■	Y-732U	2408		D-POWER 4	6001
Arosa 16V	1.4	74	09.00 - 06.04	AUB	4	1,0	BKUR6ET-10	2397	24	PFR6Q	6458
Arosa 16V	1.4	74	10.99 - 09.00	AQQ	4	1,0	BKUR6ET-10	2397	24	PFR6Q	6458
Arosa 16V	1.4	74	01.99 -	ANM	4	1,0	BKUR6ET-10	2397	24	PFR6Q	6458
Arosa 16V	1.4	74	01.99 - 09.00	AFK	4	1,0	BKUR6ET-10	2397	24	PFR6Q	6458
Arosa SDI	1.7	44	08.97 - 10.03	AKU	4	■	Y-732U	2408		D-POWER 4	6001
Cordoba / Vario	1.0	37	08.99 - 08.02	ALD	4	1,1	PZFR5D-11	7968	34		
Cordoba	1.0	37	07.00 -	AUC	4	1,1	PZFR5D-11	7968	34		
Cordoba / Vario	1.0	37	09.96 -	AER	4	0,8	BUR6ET	3172	1	PGR6D	6248
Cordoba / Vario	1.0	37	08.99 - 07.00	ANV	4	1,1	PZFR5D-11	7968	34		
Cordoba	1.0	51	05.00 -	AVZ	4	1,0	BKUR6ETB-10	5742			
Cordoba	1.3	40	02.93 - 08.94	2G	4	0,8	BUR6ET	3172	1	PGR6D	6248
Cordoba	1.3	40	02.93 - 08.94	AAV	4	0,8	BP5ET	2287		BPR5EIX	6597
Cordoba	1.4	40	01.98 -	ANX	4	0,8	BUR6ET	3172	1	PGR6D	6248
Cordoba / Vario	1.4	44	09.97 -	AKV	4	0,8	BUR6ET	3172	1	PGR6D	6248
Cordoba / Vario	1.4	44	05.99 - 08.00	ANW	4	1,1	PZFR5D-11	7968	34		
Cordoba / Vario	1.4	44	08.99 - 08.02	AKK	4	1,1	PZFR5D-11	7968	34		
Cordoba / Vario	1.4	44	12.97 - 05.98	APQ	4	0,8	BUR6ET	3172	1	PGR6D	6248
Cordoba / Vario	1.4	44	09.95 - 12.97	AEX	4	0,8	BUR6ET	3172	1	PGR6D	6248
Cordoba	1.4	44	09.93 - 12.95	ABD	4	0,8	BP5ET	2287		BPR5EIX	6597
Cordoba / Vario	1.4	44	06.00 -	AUD	4	1,1	PZFR5D-11	7968	34		
Cordoba 16 V Automatic	1.4	55	05.04 -	BKY	4	1,1	PZFR5D-11	7968	34		
Cordoba 16 V Schaltgetriebe / gearbox	1.4	55	05.04 -	BKY	4	1,0	BKUR6ET-10	2397	24	PFR6Q	6458
Cordoba 16 V Automatic	1.4	55	09.02 - 04.04	BBY	4	1,1	PZFR5D-11	7968	34		
Cordoba 16V	1.4	55	05.99 - 06.00	APE	4	1,0	BKUR6ET-10	2397	24	PFR6Q	6458
Cordoba 16V	1.4	55	06.00 -	AUA	4	1,0	BKUR6ET-10	2397	24	PFR6Q	6458
Cordoba	1.4	63	05.06 -	BXW	4	1,1	ZFR6T-11G	5960			
Cordoba 16 V	1.4	74	05.05 -	BBZ	4	1,0	BKUR6ET-10	2397	24	PFR6Q	6458
Cordoba / Vario 16V	1.4	74	07.00 -	AUB	4	1,0	BKUR6ET-10	2397	24	PFR6Q	6458
Cordoba / Vario 16V	1.4	74	06.97 -	AFH	4	0,8	BKUR6ET	6437	27	PFR6Q	6458
Cordoba / Vario 16V	1.4	74	09.99 - 07.00	AQQ	4	1,0	BKUR6ET-10	2397	24	PFR6Q	6458
Cordoba	1.6	52	11.93 -	ABM	4	0,8	BUR5ET	3377	22	PGR6D	6248
Cordoba / Vario	1.6	55	09.94 - 09.97	1F	4	0,8	BUR5ET	3377	22	PGR6D	6248
Cordoba	1.6	55	02.93 - 07.94	ABU	4	0,8	BUR6ET	3172	1	PGR6D	6248
Cordoba / Vario	1.6	55	05.97 - 12.98	AEE	4	0,8	BUR6ET	3172	1	PGR6D	6248
Cordoba / Vario	1.6	55	09.97 - 08.02	ALM	4	0,8	BUR6ET	3172	1	PGR6D	6248
Cordoba / Vario	1.6	74	05.99 - 08.02	AEH	4	1,0	BKUR6ET-10	2397	24	PFR6Q	6458
Cordoba / Vario	1.6	74	09.95 - 05.98	AFT	4	1,0	BKUR6ET-10	2397	24	PFR6Q	6458

<sup>1)</sup> Bic = Best in class



ℓ kW

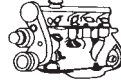

Cyl.

Order-  
No. No.Bic<sup>1)</sup> Order-  
D-Power No.**SEAT**

Cordoba / Vario	1.6	74	03.00 - 10.00	APF	4	1,0	BKUR6ET-10	2397	24	PFR6Q	6458
Cordoba	1.6	74	01.96 -	AEK	4	0,9	BKUR5ET	2789	29	PFR6Q	6458
Cordoba / Vario	1.6	74	05.00 -	AUR	4	1,0	BKUR6ET-10	2397	24	PFR6Q	6458
Cordoba	1.6	74	05.99 - 08.02	AKL	4	1,0	BKUR6ET-10	2397	24	PFR6Q	6458
Cordoba	1.6	77	11.06 -	BTS	4	1,1	ZFR6T-11G	5960			
Cordoba	1.8	55	08.91 -	AAM	4	0,8	BUR5ET	3377	22	PGR6D	6248
Cordoba / Vario	1.8	66	07.94 -	ADZ	4	0,8	BUR6ET	3172	1	PGR6D	6248
Cordoba	1.8	66	07.96 -	ACC	4	0,8	BUR6ET	3172	1	PGR6D	6248
Cordoba	1.8	66	02.93 - 08.94	ABS	4	0,8	BUR6ET	3172	1	PGR6D	6248
Cordoba	1.8	95	02.94 - 06.96	ADL	4	0,8	BKUR7ET	7873		PFR7Q	7963
Cordoba 16 V	1.8	100			4	0,8	BUR6ET	3172	1	PGR6D	6248
Cordoba	1.8	115	09.00 -	AYP	4	1,0	BKUR6ET-10	2397	24	PFR6Q	6458
Cordoba 20V	1.8	115	12.99 -	AQX	4	1,0	BKUR6ET-10	2397	24	PFR6Q	6458
Cordoba / Vario D	1.9	47	02.93 -	1Y	4	█	Y-918R	4182		D-POWER 2	6285
Cordoba / Vario SDI	1.9	47	07.96 -	AEY	4	█	Y-732U	2408		D-POWER 4	6001
Cordoba SDI	1.9	50	06.99 - 08.02	AQM	4	█	Y-732U	2408		D-POWER 4	6001
Cordoba SDI	1.9	50	04.99 - 08.02	AGP	4	█	Y-732U	2408		D-POWER 4	6001
Cordoba / Vario TD	1.9	55	02.93 - 08.97	AAZ	4	█	Y-918R	4182		D-POWER 2	6285
Cordoba TDI	1.9	66	10.99 - 05.01	ALH	4	█	Y-732U	2408		D-POWER 4	6001
Cordoba / Vario TDI	1.9	66	07.95 - 12.96	1Z	4	█	Y-732U	2408		D-POWER 4	6001
Cordoba TDI	1.9	66	04.99 - 08.02	AGR	4	█	Y-732U	2408		D-POWER 4	6001
Cordoba / Vario TDI	1.9	66	12.96 -	AHU	4	█	Y-732U	2408		D-POWER 4	6001
Cordoba / Vario TDI	1.9	81	03.97 -	AFN	4	█	Y-732U	2408		D-POWER 4	6001
Cordoba TDI	1.9	81	03.99 - 08.02	ASV	4	█	Y-732U	2408		D-POWER 4	6001
Cordoba / Vario	2.0	85	04.96 -	AGG	4	0,8	BUR6ET	3172	1	PGR6D	6248
Cordoba	2.0	85	09.02 -	AZL	4	1,0	BKUR6ET-10	2397	24	PFR6Q	6458
Cordoba	2.0	85	02.93 - 06.96	2E	4	0,8	BUR6ET	3172	1	PGR6D	6248
Cordoba	2.0	85	04.03 -	BBX	4	1,0	BKUR6ET-10	2397	24	PFR6Q	6458
Cordoba 16V	2.0	110	07.96 -	ABF	4	1,0	BKUR6ET-10	2397	24	PFR6Q	6458
Fura Crono	1.4	55			4	0,7	BP6ES	7811	4	BPR6EIX	6637
Ibiza	0.9	29	06.84 - 09.93	100GL	4	0,8	BPR6ES	7822	2	BPR6EIX	6637
Ibiza	1.0	33	03.93 -	AAU	4	0,8	BP5ET	2287		BPR5EIX	6597
Ibiza	1.0	37	07.00 - 05.02	AUC	4	1,1	PZFR5D-11	7968	34		
Ibiza	1.0	37	09.96 -	AER	4	0,8	BUR6ET	3172	1	PGR6D	6248
Ibiza	1.0	37	08.99 - 07.00	ANV	4	1,1	PZFR5D-11	7968	34		
Ibiza	1.0	37	08.99 - 05.02	ALD	4	1,1	PZFR5D-11	7968	34		
Ibiza 16V	1.0	51	06.00 - 05.02	AST	4	1,0	BKUR5ET-10	7553			
Ibiza 16V	1.0	51	05.00 - 05.02	AVZ	4	1,0	BKUR5ET-10	7553			
Ibiza	1.2	47	07.01 -		3	1,1	PZFR5J-11				
Ibiza	1.3	40	02.93 - 08.94	2G	4	0,8	BP6ET	1263		PGR6D	6248
Ibiza	1.3	40	02.93 - 08.94	AAV	4	0,8	BP5ET	2287		BPR5EIX	6597
Ibiza	1.4	44	09.97 -	AKV	4	0,8	BUR6ET	3172	1	PGR6D	6248
Ibiza	1.4	44	06.00 - 05.02	AUD	4	1,1	PZFR5D-11	7968	34		
Ibiza	1.4	44	12.97 - 05.98	APQ	4	0,8	BUR6ET	3172	1	PGR6D	6248
Ibiza	1.4	44	05.99 - 08.00	ANW	4	1,1	PZFR5D-11	7968	34		
Ibiza	1.4	44	09.95 - 12.97	AEX	4	0,8	BUR6ET	3172	1	PGR6D	6248
Ibiza	1.4	44	09.93 - 12.95	ABD	4	0,8	BP5ET	2287		BPR5EIX	6597
Ibiza	1.4	44	08.99 - 05.02	AKK	4	1,1	PZFR5D-11	7968	34		
Ibiza 16V Schaltgetriebe / gearbox	1.4	55	01.02 - 04.04	BBY	4	1,0	BKUR6ET-10	2397	24	PFR6Q	6458
Ibiza 16V Automatic	1.4	55	01.02 - 04.04	BBY	4	1,1	PZFR5D-11	7968	34		
Ibiza 16V Schaltgetriebe / gearbox	1.4	55	05.04 - 06.06	BKY	4	1,0	BKUR6ET-10	2397	24	PFR6Q	6458
Ibiza 16V Automatic	1.4	55	05.04 - 06.06	BKY	4	1,1	PZFR5D-11	7968	34		

<sup>1)</sup> Bic = Best in class



ℓ kW

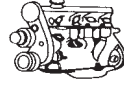

Cyl.

Order-  
No. No.Bic<sup>1)</sup> Order-  
D-Power No.**SEAT**

Ibiza 16V	1.4	55	09.99 - 06.00	APE	4	1,0	BKUR6ET-10	2397	24	PFR6Q	6458
Ibiza	1.4	55	05.98 -	AHW	4	1,0	BKUR6ET-10	2397	24	PFR6Q	6458
Ibiza 16V	1.4	55	06.00 - 05.02	AUA	4	1,0	BKUR6ET-10	2397	24	PFR6Q	6458
Ibiza	1.4	63	05.06 -	BXW	4	1,1	ZFR6T-11G	5960			
Ibiza 16V	1.4	74	09.99 - 07.00	AQQ	4	1,0	BKUR6ET-10	2397	24	PFR6Q	6458
Ibiza 16V	1.4	74	07.00 - 05.02	AUB	4	1,0	BKUR6ET-10	2397	24	PFR6Q	6458
Ibiza 16V	1.4	74	06.97 -	AFH	4	0,8	BKUR6ET	6437	27	PFR6Q	6458
Ibiza 16V	1.4	74	04.02 -	BBZ	4	1,0	BKUR6ET-10	2397	24	PFR6Q	6458
Ibiza	1.6	55	09.97 - 05.02	ALM	4	0,8	BUR6ET	3172	1	PGR6D	6248
Ibiza	1.6	55	05.97 - 12.98	AEE	4	0,8	BUR6ET	3172	1	PGR6D	6248
Ibiza	1.6	55	09.94 - 09.97	1F	4	0,8	BUR5ET	3377	22	PGR6D	6248
Ibiza	1.6	55	02.93 - 07.94	ABU	4	0,8	BUR6ET	3172	1	PGR6D	6248
Ibiza	1.6	74	06.99 - 05.02	AKL	4	1,0	BKUR6ET-10	2397	24	PFR6Q	6458
Ibiza	1.6	74	03.00 -	APF	4	1,0	BKUR6ET-10	2397	24	PFR6Q	6458
Ibiza	1.6	74	01.96 -	AEK	4	0,9	BKUR5ET	2789	29	PFR6Q	6458
Ibiza	1.6	74	05.00 - 05.02	AUR	4	1,0	BKUR6ET-10	2397	24	PFR6Q	6458
Ibiza	1.6	74	09.95 - 05.98	AFT	4	1,0	BKUR6ET-10	2397	24	PFR6Q	6458
Ibiza	1.6	74	05.99 - 05.02	AEH	4	1,0	BKUR6ET-10	2397	24	PFR6Q	6458
Ibiza	1.6	77	11.06 -	BTS	4	1,1	ZFR6T-11G	5960			
Ibiza D	1.7		09.87 -		4	█	Y-902R	2237		D-POWER 1	7906
Ibiza	1.7	72	02.92 - 09.93	021C3000 Cat.	4	0,9	BCP7ES	5030		BCPR7EIX	5690
Ibiza	1.8	55	08.91 -	AAM	4	0,8	BUR5ET	3377	22	PGR6D	6248
Ibiza	1.8	66	03.95 - 06.99	ACC	4	0,8	BUR6ET	3172	1	PGR6D	6248
Ibiza	1.8	66	02.93 - 08.94	ABS	4	0,8	BUR6ET	3172	1	PGR6D	6248
Ibiza	1.8	66	07.94 -	ADZ	4	0,8	BUR6ET	3172	1	PGR6D	6248
Ibiza	1.8	95	02.94 - 06.96	ADL	4	0,8	BKUR7ET	7873		PFR7Q	7963
Ibiza 16V	1.8	100			4	0,8	BUR6ET	3172	1	PGR6D	6248
Ibiza 20V	1.8	110	12.03 -	BKV	4	0,8	PFR6Q	6458			
Ibiza 20V	1.8	110	12.03 -	BJX	4	0,8	PFR6Q	6458			
Ibiza 20V Turbo	1.8	115	05.00 - 05.02	AYP	5	1,0	BKUR6ET-10	2397	24	PFR6Q	6458
Ibiza 20V Turbo	1.8	115	12.99 -	AQX	5	1,0	BKUR6ET-10	2397	24	PFR6Q	6458
Ibiza Cupra 20V	1.8	132	05.04 -	BBU	4	0,8	PFR6Q	6458		PFR6Q	6458
Ibiza Cupra 20V	1.8	132	05.04 -	BLZ	4	0,8	PFR6Q	6458			
Ibiza SDI	1.9	47	07.96 -	AEY	4	█	Y-732U	2408		D-POWER 4	6001
Ibiza D	1.9	47	02.93 -	1Y	4	█	Y-918R	4182		D-POWER 2	6285
Ibiza SDI	1.9	50	05.99 - 05.02	AQM	4	█	Y-732U	2408		D-POWER 4	6001
Ibiza SDI	1.9	50	04.99 - 05.02	AGP	4	█	Y-732U	2408		D-POWER 4	6001
Ibiza TD	1.9	55	02.93 - 08.97	AAZ	4	█	Y-918R	4182		D-POWER 2	6285
Ibiza TDI	1.9	66	04.99 - 05.02	AGR	4	█	Y-732U	2408		D-POWER 4	6001
Ibiza TDI	1.9	66	05.99 - 05.02	ALH	4	█	Y-732U	2408		D-POWER 4	6001
Ibiza TDI	1.9	66	12.96 -	AHU	4	█	Y-732U	2408		D-POWER 4	6001
Ibiza TDI	1.9	66	07.96 - 12.96	1Z	4	█	Y-732U	2408		D-POWER 4	6001
Ibiza TDI	1.9	81	03.99 - 05.02	ASV	4	█	Y-732U	2408		D-POWER 4	6001
Ibiza TDI	1.9	81	03.97 -	AFN	4	█	Y-732U	2408		D-POWER 4	6001
Ibiza Cupra TDI	1.9	118	03.04 -	BPX	4	█	Y-741U	5065		D-POWER 20	6943
Ibiza	2.0	85	02.93 - 06.96	2E	4	0,8	BUR6ET	3172	1	PGR6D	6248
Ibiza	2.0	85	04.96 -	AGG	4	0,8	BUR6ET	3172	1	PGR6D	6248
Ibiza	2.0	85	04.03 -	BBX	4	1,0	BKUR6ET-10	2397	24	PFR6Q	6458
Ibiza	2.0	85	07.02 - 04.04	AZL	4	1,0	BKUR6ET-10	2397	24	PFR6Q	6458
Ibiza Cupra	2.0	110	07.96 -	ABF	4	1,0	BKUR6ET-10	2397	24	PFR6Q	6458
Ibiza/Malaga 1,2	1.2	46	06.84 - 08.89	021-A-1000	4	0,9	BCP7ES	5030		BCPR7EIX	5690
Ibiza/Malaga 1,2i	1.2	52	08.89 - 03.93	021-C-1000 Cat.	4	0,9	BCP7ES	5030		BCPR7EIX	5690

<sup>1)</sup> Bic = Best in class



ℓ kW

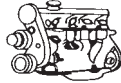

Cyl.

Order-  
No. No.Bic<sup>1)</sup> Order-  
D-Power No.**SEAT**

Ibiza/Málaga 1,5	1.5	65	04.89 - 08.91	021-D-2000	4	0,9	BCP7ES	5030		BCPR7EIX	5690
Ibiza/Málaga 1,5i	1.5	66	09.87 - 09.93	021-C-2000 Cat.	4	0,9	BCP7ES	5030		BCPR7EIX	5690
Ibiza/Málaga 1,5i SXi	1.5	74	06.88 - 08.91	021-B-2000	4	0,9	BCP7ES	5030		BCPR7EIX	5690
Inca	1.4	44	12.97 - 06.03	APQ	4	0,8	BUR6ET	3172	1	PGR6D	6248
Inca	1.4	44	09.00 - 06.03	AUD	4	1,1	PZFR5D-11	7968	34		
Inca	1.4	44	11.95 - 12.97	AEX	4	0,8	BUR6ET	3172	1	PGR6D	6248
Inca	1.4	44	12.97 - 09.00	AKV	4	0,8	BUR6ET	3172	1	PGR6D	6248
Inca 16V	1.4	55	09.00 - 06.03	AUA	4	1,0	BKUR6ET-10	2397	24	PFR6Q	6458
Inca	1.6	55	06.97 - 09.00	AEE	4	0,8	BUR6ET	3172	1	PGR6D	6248
Inca	1.6	55	11.95 - 05.97	1F	4	0,8	BUR5ET	3377	22	PGR6D	6248
Inca D	1.7	42	07.96 - 09.00	AHB	4	█	Y-918R	4182		D-POWER 2	6285
Inca SDI	1.9	47	11.95 - 09.00	AEY	4	█	Y-732U	2408		D-POWER 4	6001
Inca SDI	1.9	47	09.00 - 06.03	AYQ	4	█	Y-732U	2408		D-POWER 4	6001
Inca D	1.9	47	11.95 - 06.03	1Y	4	█	Y-918R	4182		D-POWER 2	6285
León 16V	1.4	55	02.02 - 10.05	BCA	4	1,0	BKUR6ET-10	2397	24	PFR6Q	6458
León	1.4	55	01.00 - 05.02	AHW	4	1,0	BKUR6ET-10	2397	24	PFR6Q	6458
León	1.4	55	11.99 - 05.00	APE	4	1,0	BKUR6ET-10	2397	24	PFR6Q	6458
León	1.4	55	00 -	AKQ	4	1,0	BKUR6ET-10	2397	24	PFR6Q	6458
León 16V	1.4	55	06.00 - 02.02	AXP	4	1,0	BKUR6ET-10	2397	24	PFR6Q	6458
León	1.4	63	06.06 -	BXW	4	1,1	ZFR6T-11G	5960			
León	1.6	74	11.98 - 10.05	AEH	4	1,0	BKUR6ET-10	2397	24	PFR6Q	6458
León	1.6	74	10.98 - 10.05	AKL	4	1,0	BKUR6ET-10	2397	24	PFR6Q	6458
León	1.6	75	07.05 -	BSF	4	1,0	BKUR6ET-10	2397	24	PFR6Q	6458
León	1.6	75	07.05 -	BSE	4	1,0	BKUR6ET-10	2397	24	PFR6Q	6458
León	1.6	75	10.05 -	BFQ	4	1,0	BKUR6ET-10	2397	24	PFR6Q	6458
León	1.6	77	11.99 -	ATN	4	1,0	BKUR6ET-10	2397	24	PFR6Q	6458
León 16V	1.6	77	05.01 - 04.02	AZD	4	1,0	BKUR6ET-10	2397	24	PFR6Q	6458
León 16V	1.6	77	06.00 - 04.01	AUS	4	1,0	BKUR6ET-10	2397	24	PFR6Q	6458
León 20V	1.8	92	10.98 - 12.03	AGN	4	1,0	BKUR6ET-10	2397	24	PFR6Q	6458
León 20V	1.8	132	05.01 - 10.05	AUQ	4	0,8	PFR6Q	6458		PFR6Q	6458
León turbo	1.8	132	11.99 -	APP	4	0,8	PFR6Q	6458		PFR6Q	6458
León 20V	1.8	132	04.00 -	AJQ	4	0,8	PFR6Q	6458		PFR6Q	6458
León 20V	1.8	132	06.00 - 10.05	APG	4	1,0	BKUR6ET-10	2397	24	PFR6Q	6458
León 20V	1.8	132	09.00 - 04.04	ARY	4	0,8	PFR6Q	6458		PFR6Q	6458
León 20V	1.8	132	09.00 - 10.05	AUQ	4	0,8	PFR6Q	6458		PFR6Q	6458
León Cupra	1.8	154	05.02 - 05.03	AMK	4	0,8	PFR6Q	6458		PFR6Q	6458
León Cupra	1.8	165	05.03 -	BAM	4	0,8	PFR6Q	6458		PFR6Q	6458
León SDI	1.9	50	03.00 - 10.03	AQM	4	█	Y-732U	2408		D-POWER 4	6001
León TDI	1.9	66	03.99 - 10.05	ALH	4	█	Y-732U	2408		D-POWER 4	6001
León TD	1.9	66	04.99 - 09.02	AGR	4	█	Y-732U	2408		D-POWER 4	6001
León TDI	1.9	81	11.99 - 10.05	ASV	4	█	Y-732U	2408		D-POWER 4	6001
León TDI	1.9	81	10.98 - 09.02	AHF	4	█	Y-732U	2408		D-POWER 4	6001
León TDI	1.9	110	09.00 - 12.05	ARL	4	█	Y-732U	2408		D-POWER 4	6001
León	2.0	110	07.05 - 11.05	BLR	4	1,1	PZFR5N-11TG				
León	2.0	110	11.05 -	BVZ	4	1,1	PZFR5N-11TG				
León	2.0	110	07.05 - 11.05	BLY	4	1,1	PZFR5N-11TG				
León	2.0	110	11.05 - 05.06	BVY	4	1,1	PZFR5N-11TG				
León 16V	2.3	125	05.01 - 11.03	AQN	5	1,1	PZFR5D-11	7968	34		
León 24V	2.8	150	06.01 - 04.04	BDE	6	1,1	PZFR5D-11	7968	34		
León 24V	2.8	150	05.01 - 07.01	AUE	6	1,1	PZFR5D-11	7968	34		
Malaga D	1.7		09.87 - 08.91		4	█	Y-902R	2237		D-POWER 1	7906
Marbella 0,8	0.9	25	01.87 - 12.91	903 08NCA	4	0,8	BPR6ES	7822	2	BPR6EIX	6637

<sup>1)</sup> Bic = Best in class



ℓ kW

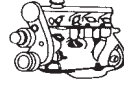

Cyl.

Order-  
No. No.Bic<sup>1)</sup> Order-  
D-Power No.**SEAT**

Marbella 0,9	0.9	29	86 - 12.92	09NCA Verg.	4	0,8	BPR6ES	7822	2	BPR6EIX	6637
Marbella 0,9	0.9	30	92 - 05.98	09NCB Cat.	4	0,9	BPR5ES	7422	6	BPR5EIX	6597
Panda 35	0.8	26			4	0,7	BP6ES	7811	4	BPR6EIX	6637
Panda 45	0.9	33			4	0,7	BP6ES	7811	4	BPR6EIX	6637
Ritmo D	1.7	40	09.80 - 08.88		4	■	Y-208T	1250			
Ritmo 65 / Ronda 1,2	1.2	47			4	0,7	BP6ES	7811	4	BPR6EIX	6637
Ritmo 75 / Ronda 1,4	1.4	57			4	0,7	BP6ES	7811	4	BPR6EIX	6637
Ritmo Crono 100 / Ronda CLX	1.6	74			4	0,7	BP6ES	7811	4	BPR6EIX	6637
Ronda 1,2	1.2	44	05.84 - 08.91	021.1000	4	0,9	BCP7ES	5030		BCPR7EIX	5690
Ronda 1,2	1.2	47	05.84 - 08.91	124B.6000	4	0,8	BPR6ES	7822	2	BPR6EIX	6637
Ronda 1,5	1.5	63	05.84 - 08.91	021A.2000	4	0,9	BCP7ES	5030		BCPR7EIX	5690
Ronda 1,6	1.6	68	05.84 - 08.91	022A.000	4	0,7	BP7ES	2412		BPR7EIX	4055
Ronda D	1.7		09.87 - 08.88		4	■	Y-902R	2237		D-POWER 1	7906
Sport 1.200	1.2	49			4	0,7	BP6ES	7811	4	BPR6EIX	6637
Sport 1.430	1.4	57			4	0,7	BP6ES	7811	4	BPR6EIX	6637
Terra 0,9	0.9	29	09.87 - 08.91	09NCA	4	0,8	BPR6ES	7822	2	BPR6EIX	6637
Terra 0,9	0.9	29	08.91 - 05.98	09NCB Cat.	4	0,9	BPR5ES	7422	6	BPR5EIX	6597
Terra Kombi D	1.4		10.91 -	1W	4	■	Y-918R	4182		D-POWER 2	6285
Terra D	1.4	35	01.90 -		4	■	Y-918R	4182		D-POWER 2	6285
Terra D	1.4	35	10.90 -		4	■	Y-918R	4182		D-POWER 2	6285
Toledo 16V	1.4	55	02.02 - 10.05	BCA	4	1,0	BKUR6ET-10	2397	24	PFR6Q	6458
Toledo	1.4	55	01.00 - 05.02	AHW	4	1,0	BKUR6ET-10	2397	24	PFR6Q	6458
Toledo 16V	1.4	55	06.00 -	AXP	4	1,0	BKUR6ET-10	2397	24	PFR6Q	6458
Toledo 16V	1.4	55	11.99 -	APE	4	1,0	BKUR6ET-10	2397	24	PFR6Q	6458
Toledo	1.4	55	00 -	AKQ	4	1,0	BKUR6ET-10	2397	24	PFR6Q	6458
Toledo SRE	1.4	63	05.06 -	BXW	4	1,1	ZFR6T-11G	5960			
Toledo	1.6	52	11.93 - 10.99	ABM	4	0,8	BUR5ET	3377	22	PGR6D	6248
Toledo	1.6	54	08.91 - 10.99	EZ	4	1,0	BUR5ET-10	7264	21	PGR6D	6248
Toledo	1.6	55	03.93 -	ABU	4	0,8	BUR6ET	3172	1	PGR6D	6248
Toledo	1.6	55	11.93 - 03.99	1F	4	0,8	BUR5ET	3377	22	PGR6D	6248
Toledo	1.6	74	04.96 - 03.99	AFT	4	1,0	BKUR6ET-10	2397	24	PFR6Q	6458
Toledo	1.6	74	01.96 - 03	AEK	4	0,9	BKUR5ET	2789	29	PFR6Q	6458
Toledo	1.6	74	02.99 - 10.05	AKL	4	1,0	BKUR6ET-10	2397	24	PFR6Q	6458
Toledo	1.6	74	09.99 -	APF	4	1,0	BKUR6ET-10	2397	24	PFR6Q	6458
Toledo	1.6	74	11.98 - 10.05	AEH	4	1,0	BKUR6ET-10	2397	24	PFR6Q	6458
Toledo	1.6	75	09.04 - 05.05	BGU	4	1,0	BKUR6ET-10	2397	24	PFR6Q	6458
Toledo	1.6	75	05.05 -	BSF	4	1,0	BKUR6ET-10	2397	24	PFR6Q	6458
Toledo	1.6	75	05.05 -	BSE	4	1,0	BKUR6ET-10	2397	24	PFR6Q	6458
Toledo	1.6	75	10.05 -	BFQ	4	1,0	BKUR6ET-10	2397	24	PFR6Q	6458
Toledo 16V	1.6	77	06.00 -	AUS	4	1,0	BKUR6ET-10	2397	24	PFR6Q	6458
Toledo 16V	1.6	77	09.00 - 04.02	AZD	4	1,0	BKUR6ET-10	2397	24	PFR6Q	6458
Toledo	1.6	77	11.99 -	ATN	4	1,0	BKUR6ET-10	2397	24	PFR6Q	6458
Toledo	1.8	66	08.91 - 12.92	RP	4	0,8	BUR6ET	3172	1	PGR6D	6248
Toledo	1.8	66	05.91 - 07.94	ABS	4	0,8	BUR6ET	3172	1	PGR6D	6248
Toledo	1.8	66	11.94 - 05.99	ADZ	4	0,8	BUR6ET	3172	1	PGR6D	6248
Toledo	1.8	66	01.95 -	ACC	4	0,8	BUR6ET	3172	1	PGR6D	6248
Toledo 16V	1.8	92	08.91 - 05.94	PL	4	0,8	BKUR7ET	7873		PFR7Q	7963
Toledo	1.8	92	09.00 - 10.05	APG	4	1,0	BKUR6ET-10	2397	24	PFR6Q	6458
Toledo 20V	1.8	92	10.98 - 12.03	AGN	4	1,0	BKUR6ET-10	2397	24	PFR6Q	6458
Toledo 16V	1.8	98	08.91 -	KR	4	0,8	BCP7ET	2078		BCPR7EIX	5690
Toledo	1.8	132	05.01 - 04.04	ARY	4	0,8	PFR6Q	6458			
Toledo	1.8	132	05.01 - 10.05	AUQ	4	0,8	PFR6Q	6458			

<sup>1)</sup> Bic = Best in class



ℓ kW

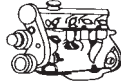

Cyl.

Order-  
No. No.Bic<sup>1)</sup> Order-  
D-Power No.**SEAT**

Toledo	1.8	132	03.00-01.01	AJQ	4	0,8	PFR6Q	6458			
Toledo turbo	1.8	132	11.99-	APP	4	0,8	PFR6Q	6458			
Toledo 20V Cupra R	1.8	154	05.02-05.03	AMK	4	0,8	PFR6Q	6458			
Toledo 20V Cupra R	1.8	165	05.03-	BAM	4	0,8	PFR6Q	6458			
Toledo D	1.9	47	03.91-03.99	1Y	4	█	Y-918R	4182		D-POWER 2	6285
Toledo SDI	1.9	50	05.01-10.03	AQM	4	█	Y-732U	2408		D-POWER 4	6001
Toledo TD	1.9	55	03.91-04.97	AAZ	4	█	Y-918R	4182		D-POWER 2	6285
Toledo TDI	1.9	66	03.99-10.05	ALH	4	█	Y-732U	2408		D-POWER 4	6001
Toledo Tdi	1.9	66	08.93-12.96	1Z	4	█	Y-732U	2408		D-POWER 4	6001
Toledo TDI	1.9	66	05.99-09.02	AGR	4	█	Y-732U	2408		D-POWER 4	6001
Toledo TDI	1.9	81	10.99-10.05	ASV	4	█	Y-732U	2408		D-POWER 4	6001
Toledo TDI	1.9	81	05.99-09.02	AHF	4	█	Y-732U	2408		D-POWER 4	6001
Toledo TDI	1.9	81	12.96-03.99	AFN	4	█	Y-732U	2408		D-POWER 4	6001
Toledo TDI	1.9	110	10.00-12.05	ARL	4	█	Y-732U	2408		D-POWER 4	6001
Toledo	2.0	85	06.99-	AQY	4	1,0	BKUR6ET-10	2397	24	PFR6Q	6458
Toledo 2,0i	2.0	85	07.95-03.99	AGG	4	0,8	BUR6ET	3172	1	PGR6D	6248
Toledo	2.0	85	05.91-	2E	4	0,8	BUR6ET	3172	1	PGR6D	6248
Toledo	2.0	100		9A	4	0,8	BKUR7ET	7873		PFR7Q	7963
Toledo FSI 16V	2.0	110	11.04-11.05	BLY	4	1,1	PZFR5N-11T	7742			
Toledo FSI 16V	2.0	110	11.05-	BVY	4	1,1	PZFR5N-11T	7742			
Toledo FSI 16V	2.0	110	11.05-	BVZ	4	1,1	PZFR5N-11T	7742			
Toledo FSI 16V	2.0	110	09.04-11.05	BLR	4	1,1	PZFR5N-11T	7742			
Toledo	2.0	110	05.94-03.99	ABF	4	1,0	BKUR6ET-10	2397	24	PFR6Q	6458
Toledo VR5	2.3	110	10.98-11.00	AGZ	5	0,8	BKR5EKUP	2890			
Toledo	2.3	125	09.00-11.03	AQN	5	1,1	PZFR5D-11	7968	34		
Toledo	2.8	150	05.01-	AUE	6	1,1	PZFR5D-11	7968	34		
Toledo	2.8	150	05.02-04.04	BDE	6	1,1	PZFR5D-11	7968	34		
VAN	1.0	33	-09.96		4	0,8	BUR6ET	3172	1	PGR6D	6248
VAN	1.0	37	09.96-	AER	4	0,8	BUR6ET	3172	1	PGR6D	6248
VAN	1.4	44			4	0,8	BUR6ET	3172	1	PGR6D	6248
VAN	1.6	55			4	0,8	BUR5ET	3377	22	PGR6D	6248

**SKODA**

105 L / S	1.0	34	76-12.90		4	0,6	BP6HS	4511	18	BPR6HIX	4085
120 A	1.2	37	76-12.90		4	0,6	BP6HS	4511	18	BPR6HIX	4085
120 GLS / LS / LSE / Garde	1.2	39	76-12.90		4	0,6	BP6HS	4511	18	BPR6HIX	4085
125 L / GL / GLE	1.2	37	76-12.90		4	0,6	BP6HS	4511	18	BPR6HIX	4085
130 L / GL / Garde	1.3	46	76-12.90		4	0,6	BP6HS	4511	18	BPR6HIX	4085
135 LE / LSE	1.3		08.89-08.92		4	0,8	BKR6ES	3783	28	BKR6EIX	6418
135 LX / GLX	1.3		01.93- 96		4	0,8	BKR6ES	3783	28	BKR6EIX	6418
135 L / GL / Rapid	1.3	43	08.87-08.90	u.Cat.	4	0,8	BCPR5ES	6130	32	BCPR5EIX	5688
135 Favorit LX / GLX	1.3		01.93- 95		4	0,8	BKR6ES	3783	28	BKR6EIX	6418
135 Favorit L / LS	1.3		04.88- 95		4	0,8	BCPR5ES	6130	32	BCPR5EIX	5688
135 Favorit LE / LSE	1.3		08.89- 95		4	0,8	BKR6ES	3783	28	BKR6EIX	6418
135 Forman L / LS	1.3		08.90- 95		4	0,8	BCPR5ES	6130	32	BCPR5EIX	5688
135 Forman LE / LSE	1.3		02.91- 95		4	0,8	BKR6ES	3783	28	BKR6EIX	6418
135 Forman LX / GLX	1.3		01.93- 95		4	0,8	BKR6ES	3783	28	BKR6EIX	6418
135 / 136	1.3	46	-12.90		4	0,6	BP6HS	4511	18	BPR6HIX	4085
136 L / GL / Rapid	1.3	46	87-12.90		4	0,7	BCP6ES	4930	17	BCPR6EIX	5689
136 Favorit					4	0,8	BCPR6E	1269	12	BCPR6EIX	5689
136 Favorit			93- 95		4	0,9	BCPR6ET	2197		BCPR6EIX	5689
136 Favorit			93- 95		4	0,9	BKR6E	6962	28	BKR6EIX	6418

<sup>1)</sup> Bic = Best in class



ℓ kW

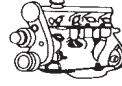

Cyl.

Order-  
No. No.Bic<sup>1)</sup> Order-  
D-Power No.**SKODA**

<b>136 Favorit</b>					4	0,6	BP7EFS	3526				
<b>Coupe</b>	1.2	43	- 12.90		4	0,6	BP6HS	4511	18	BPR6HIX	4085	
<b>Fabia</b>	1.0	37	10.00-08.02	AQV	4	1,0	BKR6ETA-10	7998				
<b>Fabia</b>	1.0	37	02.00-	ATY	4	1,0	BKR6ETA-10	7998				
<b>Fabia</b>	1.0	37	10.00-08.02	ARV	4	1,0	BKR6ETA-10	7998				
<b>Fabia</b>	1.2	40	05.04-12.07	BMD	3	0,9	ZFR5P-G	6893				
<b>Fabia</b>	1.2	40	07.01-05.04	AWY	3	0,9	ZFR5P-G	6893				
<b>Fabia</b>	1.2	44	12.06-	BBM	4	0,9	ZFR5P-G	6893				
<b>Fabia</b>	1.2	47	11.04-12.07	BME	3	0,9	ZFR5P-G	6893				
<b>Fabia</b>	1.2	47	01.03-12.04	AZQ	3	0,9	ZFR5P-G	6893				
<b>Fabia</b>	1.2	52	01.07-	BZG	3	0,9	ZFR5P-G	6893				
<b>Fabia</b>	1.4	44	04.00-03.03	AZE	4	0,8	PFR6Q	6458				
<b>Fabia</b>	1.4	44	04.00-03.03	AZF	4	0,8	PFR6Q	6458				
<b>Fabia TDI</b>	1.4	50	10.05-	BNM	3	█	Y-741U	5065		D-POWER 20	6943	
<b>Fabia</b>	1.4	50	08.00-05.03	AQW	4	1,0	BKUR5ET-10	7553				
<b>Fabia</b>	1.4	50	08.99-05.03	AME	4	1,0	BKUR5ET-10	7553				
<b>Fabia</b>	1.4	50	08.99-01.01	ATZ	4	1,0	BKUR5ET-10	7553				
<b>Fabia</b>	1.4	55	04.03-10.05	AMF	3	█	Y-741U	5065		D-POWER 20	6943	
<b>Fabia 16 V</b>	1.4	55	05.04-12.07	BKY	4	0,9	ZFR5P-G	6893				
<b>Fabia 16V Automatic</b>	1.4	55	04.02-05.04	BBY	4	1,1	PZFR5D-11	7968	34			
<b>Fabia 16V Schaltgetriebe / gearbox</b>	1.4	55	04.02-05.04	BBY	4	1,0	BKUR6ET-10	2397	24	PFR6Q	6458	
<b>Fabia</b>	1.4	55	10.99-08.03	AUA	4	1,0	BKUR6ET-10	2397	24	PFR6Q	6458	
<b>Fabia</b>	1.4	59	01.07-	BMS	3	█	CZ101					
<b>Fabia</b>	1.4	59	05.06-12.07	BUD	4	1,1	ZFR6T-11G	5960				
<b>Fabia TDI</b>	1.4	59	10.05-	BNV	3	█	Y-741U	5065		D-POWER 20	6943	
<b>Fabia</b>	1.4	63	01.07-	BXW	4	1,1	ZFR6T-11G	5960				
<b>Fabia</b>	1.4	74	05.02-12.04	BBZ	4	1,0	BKUR6ET-10	2397	24	PFR6Q	6458	
<b>Fabia</b>	1.4	74	10.99-08.03	AUB	4	1,0	BKUR6ET-10	2397	24	PFR6Q	6458	
<b>Fabia</b>	1.6	77	04.07-	BTS	4	1,1	ZFR6T-11G	5960				
<b>Fabia SDI</b>	1.9	47	11.99-	ASY	4	█	Y-732U	2408		D-POWER 4	6001	
<b>Fabia TDI PD</b>	1.9	74	01.00-10.05	ATD 6Y-2-451088 -->	4	█	Y-741U	5065		D-POWER 20	6943	
<b>Fabia</b>	1.9	74	10.05-12.07	AXR	4	█	Y-741U	5065		D-POWER 20	6943	
<b>Fabia TDI PD</b>	1.9	74	01.00-10.05	ATD -->6Y-2-451087	4	█	Y-732U	2408		D-POWER 4	6001	
<b>Fabia</b>	1.9	77	04.07-	BLS	4	█	CZ101					
<b>Fabia</b>	1.9	77	04.07-	BSW	4	█	Y-741U	5065		D-POWER 20	6943	
<b>Fabia</b>	1.9	96	10.05-04.07	BLT	4	█	Y-741U	5065		D-POWER 20	6943	
<b>Fabia TD RS</b>	1.9	96	06.03-10.05	ASZ	4	█	Y-741U	5065		D-POWER 20	6943	
<b>Fabia</b>	2.0	85	12.99-12.07	AZL	4	1,0	BKUR6ET-10	2397	24	PFR6Q	6458	
<b>Felicia</b>	1.0	37	08.99-	AHT	4	1,0	BKR6ETA-10	7998				
<b>Felicia</b>	1.3	40	08.96-08.01	AMG	4	1,0	BKUR5ET-10	7553				
<b>Felicia 135i</b>	1.3	40	10.94-07.96	MPI	4	1,0	BKUR5ET-10	7553				
<b>Felicia</b>	1.3	43	10.94-07.96		4	0,8	BCPR5ES	6130	32	BCPR5EIX	5688	
<b>Felicia 135i</b>	1.3	43	08.96-	AMJ	4	0,8	BCPR5ES	6130	32	BCPR5EIX	5688	
<b>Felicia 136i</b>	1.3	50	10.94-07.96	136M	4	0,8	BKR6ES	3783	28	BKR6EIX	6418	
<b>Felicia 136i</b>	1.3	50	10.94-07.96	136B	4	0,8	BCPR6ES	2330	12	BCPR6EIX	5689	
<b>Felicia</b>	1.3	50	08.96-08.01	AMH	4	1,0	BKUR5ET-10	7553				
<b>Felicia</b>	1.4	74	99-		4	1,0	BKUR6ET-10	2397	24	PFR6Q	6458	
<b>Felicia</b>	1.6	55	05.95-08.01	AEE	4	0,8	BUR6ET	3172	1	PGR6D	6248	
<b>Felicia D</b>	1.9	47	10.95-08.01	AEF	4	█	Y-918R	4182		D-POWER 2	6285	
<b>Felicia D</b>	1.9	47	97-	AEY	4	█	Y-732U	2408		D-POWER 4	6001	
<b>Octavia</b>	1.4	44	02.99-03.01	AMD	4	1,0	BKUR6ET-10	2397	24	PFR6Q	6458	
<b>Octavia Automatik</b>	1.4	55	08.00-01.02	AXP	4	1,1	PZFR5D-11	7968	34			

<sup>1)</sup> Bic = Best in class





ℓ kW

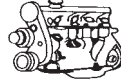

Cyl.

Order-  
No. No.Bic<sup>1)</sup> Order-  
D-Power No.**SKODA**

Octavia	1.4	55	00 -	AKQ	4	1,0	BKUR6ET-10	2397	24	PFR6Q	6458
Octavia	1.4	55	05.99 -	AHW	4	1,0	BKUR6ET-10	2397	24	PFR6Q	6458
Octavia Schaltgetriebe / gearbox	1.4	55	08.00 - 01.02	AXP	4	1,0	BKUR6ET-10	2397	24	PFR6Q	6458
Octavia	1.4	55	00 -	APE	4	1,0	BKUR6ET-10	2397	24	PFR6Q	6458
Octavia	1.4	55	01.02 -	BCA	4	1,0	BKUR6ET-10	2397	24	PFR6Q	6458
Octavia	1.4	59	05.06 -	BUD	4	1,1	ZFR6T-11G	5960			
Octavia	1.6	55	10.96 - 09.04	AEE	4	0,8	BUR6ET	3172	1	PGR6D	6248
Octavia	1.6	74	08.98 -	AKL	4	1,0	BKUR6ET-10	2397	24	PFR6Q	6458
Octavia	1.6	74	02.97 -	AEH	4	1,0	BKUR6ET-10	2397	24	PFR6Q	6458
Octavia	1.6	75	05.04 - 05.05	BGU	4	1,0	BKUR6ET-10	2397	24	PFR6Q	6458
Octavia	1.6	75	04.02 -	BFQ	4	1,0	BKUR6ET-10	2397	24	PFR6Q	6458
Octavia	1.6	75	05.05 -	BSE	4	1,0	BKUR6ET-10	2397	24	PFR6Q	6458
Octavia	1.6	75	05.05 -	BSF	4	1,0	BKUR6ET-10	2397	24	PFR6Q	6458
Octavia	1.6	75	08.00 - 04.02	AVU	4	1,0	BKUR6ET-10	2397	24	PFR6Q	6458
Octavia	1.6	85	02.04 -	BLF	4		ZFR6S-Q	6449			
Octavia 20V	1.8	92	10.96 -	AGN	4	1,0	BKUR6ET-10	2397	24	PFR6Q	6458
Octavia Turbo	1.8	110	01.00 - 07.00	ARZ	4	0,8	PFR6Q	6458			
Octavia Turbo	1.8	110	08.00 -	AUM	4	0,8	PFR6Q	6458			
Octavia	1.8	110	05.98 -	AGU	4	0,8	PFR6Q	6458			
Octavia Turbo	1.8	110	08.00 - 05.06	ARX	4	0,8	PFR6Q	6458			
Octavia	1.8	110	98 -	AEB	4	0,8	PFR6Q	6458			
Octavia RS Turbo	1.8	132	12.00 - 01.06	AUQ	4	0,8	PFR6Q	6458			
Octavia SDI	1.9	47	09.96 -	AEY	4	█	Y-732U	2408		D-POWER 4	6001
Octavia SDI	1.9	50	08.00 - 12.03	AQM	4	█	Y-732U	2408		D-POWER 4	6001
Octavia SDI	1.9	50	05.97 -	AGP	4	█	Y-732U	2408		D-POWER 4	6001
Octavia TD (SK)	1.9	50	97 -		4	█	Y-918R	4182		D-POWER 2	6285
Octavia TD	1.9	66	10.96 -	AGR	4	█	Y-732U	2408		D-POWER 4	6001
Octavia TDI	1.9	66	97 -	1Z	4	█	Y-732U	2408		D-POWER 4	6001
Octavia TDI	1.9	66	08.00 -	ALH	4	█	Y-732U	2408		D-POWER 4	6001
Octavia TDI	1.9	74	08.00 - 01.06	ATD	4	█	Y-732U	2408		D-POWER 4	6001
Octavia	1.9	77	05.04 -	BJB	4	█	Y-607AS	9776		D-POWER 50	
Octavia	1.9	77	05.04 -	BKC	4	█	Y-607AS	9776		D-POWER 50	
Octavia TDI	1.9	77	05.06 -	BLS	4	█	Y-607AS	9776		D-POWER 50	
Octavia TDI	1.9	77	03.06 -	BXE	4	█	Y-607AS	9776		D-POWER 50	
Octavia TDI	1.9	81	10.00 -	ASV	4	█	Y-732U	2408		D-POWER 4	6001
Octavia TDI	1.9	81	08.97 - 01.06	AHF	4	█	Y-732U	2408		D-POWER 4	6001
Octavia TDI	1.9	81	97 -	AFN	4	█	Y-732U	2408		D-POWER 4	6001
Octavia TDI	1.9	96	09.02 - 09.04	ASZ	4	█	Y-741U	5065		D-POWER 20	6943
Octavia	2.0	85	03.02 - 01.06	AZJ	4	1,1	PZFR5D-11	7968	34		
Octavia	2.0	85	05.99 - 03.02	AQY	4	1,0	BKUR6ET-10	2397	24	PFR6Q	6458
Octavia	2.0	85	09.00 - 01.05	AEG	4	1,0	BKUR6ET-10	2397	24	PFR6Q	6458
Octavia	2.0	85	05.99 -	APK	4	1,0	BKUR6ET-10	2397	24	PFR6Q	6458
Octavia	2.0	85	11.99 -	AZH	4	1,0	BKUR6ET-10	2397	24	PFR6Q	6458
Octavia Combi GLX / SLX	2.0	88	11.99 -	ATF	4	1,1	PZFR5D-11	7968	34		
Octavia	2.0	100	05.04 -	BKD	4	█	YE14	7768		D-POWER 48	7768
Octavia	2.0	100	05.04 -	AZV	4	█	YE14	7768		D-POWER 48	7768
Octavia	2.0	103	11.05 -	BMM	4	█	Y-607AS	9776		D-POWER 50	
Octavia	2.0	110	11.04 - 11.05	BLY	4	1,1	PZFR5N-11TG				
Octavia	2.0	110	11.04 - 11.05	BLR	4	1,1	PZFR5N-11T	7742			
Octavia	2.0	110	11.04 - 11.05	BLX	4	1,1	PZFR5N-11T	7742			
Octavia	2.0	110	11.05 -	BVZ	4	1,1	PZFR5N-11TG				
Octavia	2.0	110	11.05 -	BVX	4	1,1	PZFR5N-11T	7742			

<sup>1)</sup> Bic = Best in class



ℓ kW

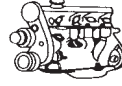

Cyl.

Order-  
No. No.Bic<sup>1)</sup> Order-  
D-Power No.**SKODA**

Octavia	2.0	110	11.05 -	BVY	4	1,1	PZFR5N-11T	7742				
Octavia RS	2.0	147	10.05 -	BWA	4	0,8	PFR6Q	6458				
Pickup 135 L	1.3		06.90 - 96	u.Cat.	4	0,8	BCPR5ES	6130	32	BCPR5EIX	5688	
Pickup 135 LX	1.3		01.93 - 96		4	0,8	BKR6ES	3783	28	BKR6EIX	6418	
Pickup 135 LE	1.3		10.91 - 96		4	0,8	BKR6ES	3783	28	BKR6EIX	6418	
Pickup	1.9	47	97 -	AEY	4	█	Y-732U	2408		D-POWER 4	6001	
Pick-up 135i	1.3	40	96 -	135M	4	1,0	BKUR5ET-10	7553				
Pick-up 136i	1.3	50	96 -	136M	4	1,0	BKUR5ET-10	7553				
Rapid	1.3				4	0,6	BP6HS	4511	18	BPR6HIX	4085	
Rapid	1.3		91 - 92		4	0,7	BP5EFS	3712				
Roomster	1.2	47	05.06 - 01.07	BME	3	0,9	ZFR5P-G	6893				
Roomster	1.4	50	07.06 -	BNM	3	█	Y-741U	5065		D-POWER 20	6943	
Roomster	1.4	59	05.06 -	BNV	3	█	Y-741U	5065		D-POWER 20	6943	
Roomster	1.4	59	07.06 -	BMS	3	█	CZ101					
Roomster	1.4	63	05.06 -	BXW	4	1,1	ZFR6T-11G	5960				
Roomster	1.6	77	05.06 -	BTS	4	1,1	ZFR6T-11G	5960				
Roomster TDI	1.9	74	03.06 - 05.06	AXR	4	█	Y-741U	5065		D-POWER 20	6943	
Roomster TDI	1.9	77	05.06 -	BSW	4	█	Y-741U	5065		D-POWER 20	6943	
Roomster TDI	1.9	77	11.06 -	BLS	4	█	CZ101					
Superb Turbo	1.8	110	10.01 -	AWT	4	0,8	PFR6Q	6458				
Superb	1.9	74	06.02 - 10.05	AVB	4	█	Y-741U	5065		D-POWER 20	6943	
Superb	1.9	77	10.05 -	BSV	4	█	CZ101					
Superb	1.9	85	01.07 -	BPZ	4	█	CZ101					
Superb	1.9	96	01.04 -	AVF	4	█	Y-741U	5065		D-POWER 20	6943	
Superb TDI PD	1.9	96	10.01 -	AWX	4	█	Y-741U	5065		D-POWER 20	6943	
Superb	2.0	85	12.01 -	AZM	4	1,0	BKUR6ET-10	2397	24	PFR6Q	6458	
Superb	2.0	91	02.06 -	BWW	4	█	CZ101					
Superb	2.0	103	10.05 -	BSS	4	█	CZ101					
Superb	2.5	114	12.01 - 08.03	AYM	6	█	Y-501U	3786		D-POWER 31	4187	
Superb	2.5	120	06.03 -	BDG	6	█	Y-501U	3786		D-POWER 31	4187	
Superb	2.8	140	05.02 -	BBG	6	0,8	BKR6EKUB	3584				
Superb	2.8	142	12.01 -	AMX	6	0,8	BKR6EKUB	3584				

**SMART**

Smart	0.6	33	10.98 - 01.04	M 160 ... Twin Spark	3	0,65	BKR6EKE	5649				
Smart	0.6	40	10.98 - 01.04	M 160 ... Twin Spark	3	0,65	BKR6EKE	5649				
Smart Crossblade	0.6	52	10.02 - 01.04	M 160 ... Twin Spark	3	0,65	BKR6EKE	5649				
Smart fortwo	0.7	37	01.04 -	M 160/1 Twin Spark	3		LKR8A	5214				
Smart	0.7	37	10.02 - 01.04	M 160/1 Twin Spark	3		LKR8A	5214				
Smart fortwo	0.7	45	01.04 -	M 160/1 Twin Spark	3		LKR8A	5214				
Smart	0.7	60	10.02 - 01.04	M 160/1 Twin Spark	3		LKR8A	5214				
Smart CDI	0.8	29	07.98 - 01.04	OM 660 DE 08 LA	3	█	Y-543J	6600		D-POWER 46	5618	
Smart fortwo CDI	0.8	30	01.04 -	OM 660	3	█	Y-543J	6600		D-POWER 46	5618	
Smart fortwo Brabus	0.7	55	01.04 -	M 132.930	3	0,8	ILZFR6C-K	6645				
Smart Roadster	0.7	45	10.02 - 11.05	M 160/1 Twin Spark	3		LKR8A	5214				
Smart Roadster	0.7	60	06.03 - 11.05	M 160/1 Twin Spark	3		LKR8A	5214				
Smart Roadster Brabus	0.7	74	12.03 -	M 160/1 Twin Spark	3		LKR8A	5214				
Smart forfour CDI	1.5	50	09.04 -	OM 639.939	3	█	YE13	8643				
Smart forfour CDI	1.5	70	09.04 -	OM 639.939	3	█	YE13	8643				
Smart forfour Brabus	1.5	130	05.05 -	M 122.950	4	0,8	ILZFR6C-K	6645				

<sup>1)</sup> Bic = Best in class



ℓ kW

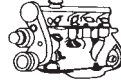

Cyl.

Order-  
No. No.Bic<sup>1)</sup> Order-  
D-Power No.**SSANGYONG**

Actyon 200xdi	2.0	104	11.06 -		4	█	Y-745U	4705		D-POWER 11	6346
Korando	2.0	100	07.96 -	M161E20 M111.940	4	0,8	BCP5ES	7496	16	BCPR5EIX	5688
Korando D	2.2	51	01.93 -	DC 23	4	█	Y-710J	7880			
Korando D	2.3	55	03.97 -	OM 601 DM	4	█	Y-916R	2785		D-POWER 6	5906
Korando TD	2.3	73	03.99 - 03.00		4	█	Y-916R	2785		D-POWER 6	5906
Korando	2.3	110	09.96 - 02.99	M161E23 M111.970	4	0,8	BCP5ES	7496	16	BCPR5EIX	5688
Korando D	2.9	73	12.96 -	MB-OM 602	5	█	Y-916R	2785		D-POWER 6	5906
Korando TD	2.9	88	03.99 - 03.00		5	█	Y-916R	2785		D-POWER 6	5906
Korando GPL	3.2	162	07.97 - 03.00		6	0,8	BKR5EIX	6341		BKR5EIX	6341
Korando	3.2	162	09.96 - 03.00	M162E32 M104...	6	0,8	BCP5ES	7496	16	BCPR5EIX	5688
Kyron Xdi	2.0	104	06 -	Mercedes		█	Y-745U	4705		D-POWER 11	6346
Musso	2.0	100	05.96 -	M161E20 M111.940	4	0,8	BCP5ES	7496	16	BCPR5EIX	5688
Musso 601 D	2.3	58	07.93 - 01.00	MB-OM 601	4	█	Y-916R	2785		D-POWER 6	5906
Musso TD	2.3	73	03.99 - 03.00		4	█	Y-916R	2785		D-POWER 6	5906
Musso	2.3	110	05.96 - 02.99	M161E23 M111.970	4	0,8	BCP5ES	7496	16	BCPR5EIX	5688
Musso 602 D	2.9	73	07.93 - 01.00	MB-OM 602	5	█	Y-916R	2785		D-POWER 6	5906
Musso Sports 290S TD	2.9	88	03.04 -		5	█	Y-916R	2785		D-POWER 6	5906
Musso TD	2.9	88	03.99 -		5	█	Y-916R	2785		D-POWER 6	5906
Musso E32	3.2	162	01.96 -	M162E32 M104...	6	0,8	BCP5ES	7496	16	BCPR5EIX	5688
Rexton RX 270XDi	2.7	120	07.04 -		5	█	Y-745U	4705		D-POWER 11	6346
Rexton 270XVT	2.7	137	07 -		5	█	Y-745U	4705		D-POWER 11	6346
Rexton RX 290s	2.9	88			5	█	Y-916R	2785		D-POWER 6	5906
Rexton RX 320s	3.2	162			6	0,7	BCP6ES	4930	17	BCPR6EIX	5689
Rodius Xdi	2.7	120	05.05 -		5	█	Y-745U	4705		D-POWER 11	6346

**STEYR**

Puch 290 GD	2.9	72	08.93 -	OM602	5	█	Y-916R	2785		D-POWER 6	5906
Puch 300 GD	3.0	83	09.89 -	OM617/603	6	█	Y-916R	2785		D-POWER 6	5906
Puch 350 GTD	3.5	100	09.91 -	OM617/603	6	█	Y-916R	2785		D-POWER 6	5906

**SUBARU**

1600					4	0,8	BPR6ES	7822	2	BPR6EIX	6637
1800 Turbo					4	0,8	BPR7ES	2023	19	BPR7EIX	4055
Forester	2.0	90	09.97 -	EJ20J	4	1,1	BCPR6ES-11	7121	11	BCPR6EIX-11	4919
Forester	2.0	92		EJ20	4	1,1	BKR5E-11	6953	33	BKR5EIX-11	5464
Forester	2.0	116	09.05 -	EJ20	4	0,8	ILFR6B	6481			
Forester 2.0Turbo	2.0	130	03.99 -	EJ20	4	0,8	PFR6B	3500			
Forester 2.5 Turbo	2.5	155	05 -	EJ25	4	0,8	PFR6G	4793			
Forester	2.5	169	06 -	EJ25	4	0,8	ILFR6B	6481			
Impreza 1,6	1.6	66	93 - 00	EJ16	4	1,1	BKR6E-11	2756	14	BKR6EIX-11	3764
Impreza	1.6	70	03 - 06	EJ16	4	0,8	PFR6G	4793			
Impreza	1.6	70	12.00 - 03	EJ16	4	1,1	BKR6E-11	2756	14	BKR6EIX-11	3764
Impreza 1,8	1.8	76	93 - 00	EJ18	4	1,1	BKR6E-11	2756	14	BKR6EIX-11	3764
Impreza 2.0 RS	2.0	92	11.04 -	EJ20	4	1,1	BKR6E-11	2756	14	BKR6EIX-11	3764
Impreza	2.0	92	12.00 -	EJ20	4	1,1	BKR6E-11	2756	14	BKR6EIX-11	3764
Impreza R	2.0	118	06 -	EJ20	4	0,8	ILFR6B	6481			
Impreza Turbo	2.0	155	05.94 - 07.96	EJ20	4	0,8	PFR6G	4793			
Impreza Turbo	2.0	160	03.94 - 00	EJ20	4	0,8	PFR6B	3500			
Impreza WRX Turbo	2.0	160	12.00 -	EJ20	4	0,8	PFR6B	3500			
Impreza WRX Turbo	2.0	165	11.02 -	EJ20	4	0,8	PFR6B	3500			
Impreza WRX Sti	2.0	195	03 -	EJ20	4	0,8	PFR6G	4793			
Impreza WRX Sti	2.0	236	02.04 -		4	0,8	PFR6G	4793			

<sup>1)</sup> Bic = Best in class



l kW

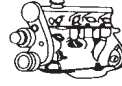

Cyl.

Order-  
No. No.Bic<sup>1)</sup> Order-  
D-Power No.**SUBARU**

Impreza WRX	2.5	169	09.05-	EJ25	4	0,8	ILFR6B	6481				
Impreza WRX ST1	2.5	206	09.05-	EJ25	4	0,8	ILFR6B	6481				
Justy 1000	1.0		85- 03	EF10 Cat.	4	1,1	BPR6ES-11	4824	13	BPR6EIX-11	3903	
Justy 1200	1.2	55	87- 03	EF12/EF12 Cat.	4	1,1	BPR6ES-11	4824	13	BPR6EIX-11	3903	
Justy 1300	1.3	50	10.95- 03	G13BA	4	0,8	BPR6ES	7822	2	BPR6EIX	6637	
Justy	1.3	63	- 03	G13BB	4	1,1	BKR6E-11	2756	14	BKR6EIX-11	3764	
Justy G3X	1.3	69	09.03-	M13A DOHC	4	1,1	BKR6E-11	2756	14	BKR6EIX-11	3764	
Justy G3X	1.5	73	09.03-	M15A DOHC	4	1,1	IFR6J-11	7658				
L-1800	1.8	66	85- 89		4	0,8	BPR6ES	7822	2	BPR6EIX	6637	
L-1800 MPFJ	1.8	72	87-	EA82	4	1,1	BPR6ES-11	4824	13	BPR6EIX-11	3903	
L-1800 Turbo	1.8	97	87- 89	EA82 u.Cat.	4	0,8	BPR7ES	2023	19	BPR7EIX	4055	
L-1800 Turbo	1.8	100	85- 89	EA82	4	0,8	BPR7ES	2023	19	BPR7EIX	4055	
Legacy 1,8 Super Station	1.8	76	90- 91	EJ18/4	4	1,1	BKR6E-11	2756	14	BKR6EIX-11	3764	
Legacy 1,8 Station	1.8	76	90-	EJ18/4	4	1,1	BKR6E-11	2756	14	BKR6EIX-11	3764	
Legacy 1,8 Sedan	1.8	76	90- 91	EJ18/4	4	1,1	BKR6E-11	2756	14	BKR6EIX-11	3764	
Legacy 2.0	2.0		05.04-	only CNG DOHC	4	0,8	ILFR7F-D					
Legacy 2,0 Super Station	2.0	84	92-	EJ20	4	1,1	BKR6E-11	2756	14	BKR6EIX-11	3764	
Legacy 2,0 Sedan	2.0	84	92-	EJ20/4	4	1,1	BKR6E-11	2756	14	BKR6EIX-11	3764	
Legacy	2.0	85	05.94-	EJ20	4	1,1	BKR6E-11	2756	14	BKR6EIX-11	3764	
Legacy 2,0	2.0	92	12.98- 03	EJ20	4	1,1	BKR6E-11	2756	14	BKR6EIX-11	3764	
Legacy	2.0	101	09.03-	EJ20	4	1,1	BKR6E-11	2756	14	BKR6EIX-11	3764	
Legacy 2,0 Turbo	2.0	147	93- 96	EJ20	4	0,8	PFR6G	4793				
Legacy 2,0 Turbo Sedan	2.0	147	92- 93	EJ20	4	0,8	BKR6EVX	3539		BKR6EIX	6418	
Legacy 2,0 Turbo Sup.Stat.	2.0	147	92- 93	EJ20	4	0,8	BKR6EVX	3539		BKR6EIX	6418	
Legacy	2.2	94	05.94-	EJ22	4	1,1	BKR6E-11	2756	14	BKR6EIX-11	3764	
Legacy 2,2 Station	2.2	96	94-	EJ22	4	1,1	BKR6E-11	2756	14	BKR6EIX-11	3764	
Legacy 2,2 Super Station	2.2	100	90-	EJ22/4	4	1,1	BKR6E-11	2756	14	BKR6EIX-11	3764	
Legacy 2,2 Sedan	2.2	100	90- 93	EJ22	4	1,1	BKR6E-11	2756	14	BKR6EIX-11	3764	
Legacy Outback	2.5	110	96-	EJ25	4	1,1	PFR6B-11	4014				
Legacy 2,5 Outback	2.5	115	12.98- 03	EJ25	4	1,1	BKR6E-11	2756	14	BKR6EIX-11	3764	
Legacy	2.5	121	09.03-	EJ25	4	1,1	PFR5B-11	2300				
Legacy Outback H6-3.0	3.0	154	01- 03		6	1,1	PLFR6A-11	7654				
Legacy H6-3.0	3.0	154	01- 03		6	1,1	PLFR6A-11	7654				
Legacy 3.0R spec.B Kombi	3.0	180	02.05-	EZ30	6	0,8	ILFR6B	6481				
Legacy 3.0 R	3.0	180	11.03-	EZ30	6	0,8	ILFR6B	6481				
Libero 1200	1.2	38	87-	EF12	4	1,1	BPR6ES-11	4824	13	BPR6EIX-11	3903	
M80 Mini Jumbo	0.8			M80	4	0,9	BKR6E	6962	28	BKR6EIX	6418	
MV Pickup	1.8		80- 94		4	0,8	BPR6ES	7822	2	BPR6EIX	6637	
Outback 2.5	2.5	121	09.03-	EJ25	4	1,1	PFR5B-11	2300				
Outback 3.0 R	3.0	180	11.03-	EZ30	6	0,8	ILFR6B	6481				
Pleo (RA1,RA2)	0.66		10.01-01.04	EN07	4		KR8BI	4347				
R1 (RJ1,RJ2)	0.66		06-	EN07	4		KR8BI	4347				
R2 (RC1,RC2)	0.66		12.03-	EN07	4		KR8BI	4347				
Sumo	1.0				3	1,1	BPR6ES-11	4824	13	BPR6EIX-11	3903	
Sumo	1.2				3	1,1	BPR6ES-11	4824	13	BPR6EIX-11	3903	
SVX	3.3	162	92-	EG33	6	1,1	PFR6G-11	5555				
Tribeca B9	3.0	184	06-	EZ 30	6	0,8	ILFR6B	6481				
Vivio	0.7		03.92-	Vergaser/Carb	4	1,1	BKR5E-11	6953	33	BKR5EIX-11	5464	
Vivio	0.7		03.92-	MFI	4	1,1	BKR6E-11	2756	14	BKR6EIX-11	3764	
XT Turbo	1.8	88	90- 90	Cat.	4	1,1	BPR6ES-11	4824	13	BPR6EIX-11	3903	
XT Turbo	1.8	97	87- 89	u.Cat.	4	0,8	BPR7ES	2023	19	BPR7EIX	4055	
XT-Turbo	1.8	100	85- 89		4	0,8	BPR7ES	2023	19	BPR7EIX	4055	

<sup>1)</sup> Bic = Best in class



ℓ kW

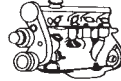

Cyl.

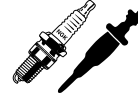
Order-  
No. No.Bic<sup>1)</sup> Order-  
D-Power No.**SUZUKI**

Alto (HA24V)	0.6		01.05 -	K6A	4		KR7AI	7789			
Alto (SB308)	0.8	29	86 - 92	F8B	4	0,9	BPR5ES	7422	6	BPR5EIX	6597
Alto	1.0		01.01 -	G10B	4	0,9	BKR6E	6962	28	BKR6EIX	6418
Alto (SH410)	1.0	39	94 - 00	G10B	4	0,8	BPR5EY	2828	9	BPR5EIX	6597
Alto (SH410)	1.0	53	94 - 12.00	G10B	4	0,8	BPR5EY	2828	9	BPR5EIX	6597
Alto (FF)	1.1	46	06.02 -	K10A DOHC 16V	4	0,8	DCPR7E	3932		DCPR7EIX	6046
Alto Lapin HE21S	1.6		01.02 -	K6A...	4	0,8	DCPR7E	3932		DCPR7EIX	6046
Baleno (SY413)	1.3	63	04.95 -	G13BB	4	0,9	BKR6E	6962	28	BKR6EIX	6418
Baleno	1.6		95 -	G16A (16V)	4	0,9	BKR6E	6962	28	BKR6EIX	6418
Baleno (SY416)	1.6	72	04.95 -	G16B	4	0,9	BKR6E	6962	28	BKR6EIX	6418
Baleno	1.8		11.00 -	16V	4	1,1	IFR6J-11	7658			
Baleno	1.8	89	03.96 - 12.00	J18A	4	1,1	BKR6E-11	2756	14	BKR6EIX-11	3764
Baleno D	1.9	46	98 -		4	█	Y-923U	3380		D-POWER 1	7906
Baleno TD	1.9	55	98 -		4	█	Y-923U	3380		D-POWER 1	7906
Cappuccino 660 12V Turbo	0.66	47	05.95 -	K6A DOHC Cat.	3	0,8	DCPR7EVX	1179		DCPR7EIX	6046
Cappuccino 660 12V Turbo	0.66	47	09.91 -	F6A DOHC Cat.	3	0,8	DCPR7EVX	1179		DCPR7EIX	6046
Carry Super (SK410)	1.0	31	92 -	F10A Cat.	4	0,9	BPR5ES	7422	6	BPR5EIX	6597
Carry Super (SK410)	1.0	33	87 -	F10A u.Cat.	4	0,9	BPR5ES	7422	6	BPR5EIX	6597
Carry Van	1.3		99 -	G13BB	4	0,9	BKR6E	6962	28	BKR6EIX	6418
Cervo	0.55				3	0,9	BPR5ES	7422	6	BPR5EIX	6597
Escudo	1.6	71	12.97 - 04.00	G16A	4	1,1	BKR6E-11	2756	14	BKR6EIX-11	3764
Escudo	1.6	71	08.90 - 11.97	G16A	4	0,9	BKR6E	6962	28	BKR6EIX	6418
Escudo	1.6	71	05.00 -	G16A	4	1,1	IFR6E-11	6741			
Escudo	2.0		10.96 - 11.97	J20A	4	0,9	BKR6E	6962	28	BKR6EIX	6418
Escudo	2.0		12.94 - 10.96	H20A	4	0,9	BKR6E	6962	28	BKR6EIX	6418
Escudo	2.0		11.97 - 04.00	J20A	4	1,1	BKR6E-11	2756	14	BKR6EIX-11	3764
Escudo	2.0		04.00 - 04.05	J20A	4	1,1	IFR5J-11	7418			
Escudo	2.0		04.00 -	H25A	6	1,1	IFR5J-11	7418			
Escudo (TD54W)	2.0		05.05 -	J20A	4	1,1	IFR6J11	7658			
Escudo	2.5		03.98 - 04.00	H25A	6	1,1	BKR6E-11	2756	14	BKR6EIX-11	3764
Escudo	2.5		10.96 - 11.97	H25A	6	0,9	BKR6E	6962	28	BKR6EIX	6418
Escudo (TD94W)	2.7		06.05 -	H27A	4	1,1	IFR6J11	7658			
Grand Vitara	1.6	69	03.98 -	J16A	4	1,1	BKR6E-11	2756	14	BKR6EIX-11	3764
Grand Vitara (JB416)	1.6	78	09.05 -	M16A VVT	4	1,1	IFR6J11	7658			
Grand Vitara DDIS (JB419D)	1.9	95	06 -	F9Q	4	█	Y-515J	1019		D-POWER 18	6892
Grand Vitara	2.0		10.00 -	J20	4	1,1	IFR5J-11	7418			
Grand Vitara TDiC (SQ420D)	2.0	64	05.00 -	RF	4	█	Y-701R	7464			
Grand Vitara TD (XL7) (JA420D)	2.0	80	04 -	RHW	4	█	Y-504R	4359		D-POWER 24	1441
Grand Vitara Tdi II (SQ420D)	2.0	80	03.01 -	RHZ	4	█	Y-504R	4359		D-POWER 24	1441
Grand Vitara D	2.0	81	04.01 -	HDi PSA	4	█	Y-504R	4359		D-POWER 24	1441
Grand Vitara	2.0	94	01.98 - 09.00	J20A	4	1,1	BKR6E-11	2756	14	BKR6EIX-11	3764
Grand Vitara (JB420)	2.0	103	09.05 -	J20A	4	1,1	IFR5J-11	7418			
Grand Vitara	2.5		10.00 -	H25	6	1,1	IFR5J-11	7418			
Grand Vitara V6 (SV620)	2.5	106	04.98 - 09.00	H25	6	1,1	BKR6E-11	2756	14	BKR6EIX-11	3764
Grand Vitara V6 (SV620)	2.5	125	01.98 -	H25A	6	1,1	BKR6E-11	2756	14	BKR6EIX-11	3764
Grand Vitara XL-7	2.7	127	07.01 -	H27A	6	1,1	IFR5J-11	7418			
Ignis DDiS (RM413D)	1.3	51	09.03 -	Z13DT	4	█	YE06	5285			
Ignis	1.3	61	10.00 -	M13A	4	1,1	IFR5E-11	7994			
Ignis	1.3	69	09.03 -	M13A mit V V T	4	1,1	IFR6J-11	7658			
Ignis	1.5	73	09.03 -	M15A mit V V T	4	1,1	IFR6J-11	7658			
Jimny Cabrio	1.3	59	10.98 -	G13BB	4	0,9	BKR6E	6962	28	BKR6EIX	6418
Jimny	1.3	60	10.00 -	M13A	4	1,1	IFR5E-11	7994			

<sup>1)</sup> Bic = Best in class



l kW

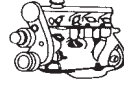

Cyl.

Order-  
No. No.Bic<sup>1)</sup> Order-  
D-Power No.**SUZUKI**

Jimny DDiS (SN415D)	1.5	48	12.03-	K9K	4	█	Y-515J	1019		D-POWER 18	6892
Liana	1.3	66	02.04-	M13A	4	1,1	IFR6J-11	7658			
Liana	1.3	66	03.01-01.04		4	1,1	BKR6E-11	2756	14	BKR6EIX-11	3764
Liana DDiS (RH414D)	1.4	66	07.04-	DV4 8HY	4	█	YE04	1101		D-POWER 40	1684
Liana	1.6	78	02.04-	M16A	4	1,1	IFR6J-11	7658			
Liana	1.6	78	03.01-01.04		4	1,1	BKR6E-11	2756	14	BKR6EIX-11	3764
SA 413 / SA 413GS	1.3	54		G13A	4	0,8	BPR6ES	7822	2	BPR6EIX	6637
Samurai	1.0	33	90-	F10A	4	0,9	BPR5ES	7422	6	BPR5EIX	6597
Samurai	1.3	44	88- 90	G13A u.Cat.	4	0,9	BPR5ES	7422	6	BPR5EIX	6597
Samurai	1.3	47	88- 89	G13A	4	0,9	BPR5ES	7422	6	BPR5EIX	6597
Samurai (SJ413)	1.3	51	90-	G13BA Cat.	4	0,9	BPR5ES	7422	6	BPR5EIX	6597
Samurai Pick-up	1.3	51	10.99-10.00	G13BA	4	0,9	BPR5ES	7422	6	BPR5EIX	6597
Samurai	1.3	51	92-	G13BA	4	0,9	BPR5ES	7422	6	BPR5EIX	6597
Samurai TD	1.9	46	09.98-	XUD9	4	█	Y-923U	3380		D-POWER 1	7906
SB 308	0.8	29		F8B	4	0,9	BPR5ES	7422	6	BPR5EIX	6597
SC 80					4	0,9	BPR5ES	7422	6	BPR5EIX	6597
SC 100					4	0,9	BPR5ES	7422	6	BPR5EIX	6597
SJ 413	1.3	44	87- 88	G13A u.Cat.	4	0,9	BPR5ES	7422	6	BPR5EIX	6597
SJ 413	1.3	47	85- 88	G13A	4	0,8	BPR6ES	7822	2	BPR6EIX	6637
SK 408					4	0,9	BPR5ES	7422	6	BPR5EIX	6597
SK 410 Super Carry	1.0	31	85-	F10A	4	0,9	BPR5ES	7422	6	BPR5EIX	6597
Swift (SF310)	1.0	37	89- 90	G10A u.Cat.	3	0,8	BPR6ES	7822	2	BPR6EIX	6637
Swift (SF310)Typ1+2	1.0	39	92-	G10A SOHC Cat.	3	0,8	BPR6ES	7822	2	BPR6EIX	6637
Swift (SF310)	1.0	40	89- 92	G10A Cat.	3	0,8	BPR6ES	7822	2	BPR6EIX	6637
Swift (SF413)	1.3			G13	4	0,8	BPR6ES	7822	2	BPR6EIX	6637
Swift (SA413)	1.3	47	86- 89	G13A u.Cat.	4	0,8	BPR6ES	7822	2	BPR6EIX	6637
Swift (SF413)	1.3	50	92-	G13BA Cat.	4	0,8	BPR6ES	7822	2	BPR6EIX	6637
Swift (SA413)	1.3	50	84- 89	G13A	4	0,8	BPR6ES	7822	2	BPR6EIX	6637
Swift (SF310)	1.3	50	89- 92	G13BA u.Cat.	4	0,8	BPR6ES	7822	2	BPR6EIX	6637
Swift (C91S)(RS413D)	1.3	52	09.05-	Z13DT	4	█	YE06	5285			
Swift (SF413)	1.3	52	89- 92	G13BA Cat.	4	0,8	BPR6ES	7822	2	BPR6EIX	6637
Swift (C11S)(RS413)	1.3	68	05.05-	M13A	4	1,1	IFR6J11	7658			
Swift (SF413)Typ1+2	1.3	74	89-	G13B OHC Cat.	4	0,8	BPR6ES	7822	2	BPR6EIX	6637
Swift (SA413)	1.3	74	86-	G13B	4	0,8	BPR6ES	7822	2	BPR6EIX	6637
Swift (C21S)(RS415)	1.5	75	05.05-	M15A VVT	4	1,1	IFR6J11	7658			
Swift (ZC31S)	1.6		09.05-	M16A	4	1,1	IFR6J11	7658			
Swift	1.6		95-		4	1,1	BPR6ES-11	4824	13	BPR6EIX-11	3903
Swift (SF416)Typ1+2	1.6	68	92-	G16B OHC Cat.	4	0,9	BKR6E	6962	28	BKR6EIX	6418
Swift (SF416)	1.6	70	89- 92	G16B Cat.	4	0,9	BKR6E	6962	28	BKR6EIX	6418
Swift Sport (RS416)	1.6	92	01.07-	M16A VVT	4	1,1	IFR6J11	7658			
SX 306 Cappuccino	0.65	47	94-	F6A		0,8	DCPR7EVX	1179		DCPR7EIX	6046
SX4 (RW416)	1.5	73	06-	M15A	4	1,1	IFR6J11	7658			
SX4 (RW416)	1.6	79	06-	M16A VVT	4	1,1	IFR6J11	7658			
SX4 (RW419D)	1.9	88	06-	D19AA	4	█	Y-534J	5540		D-POWER 36	3413
Vitara	1.6		10.00-	G16A	4	1,1	IFR6E-11	6741			
Vitara (SE416) Typ 2	1.6	59		G16A SOHC	4	0,9	BPR5ES	7422	6	BPR5EIX	6597
Vitara	1.6	59	91-	G16B Cat.	4	0,8	BPR6ES	7822	2	BPR6EIX	6637
Vitara	1.6	60	91-	G16A	4	0,9	BPR5ES	7422	6	BPR5EIX	6597
Vitara (SE416) Typ 1	1.6	60	88-	G16A SOHC Cat.	4	0,9	BPR5ES	7422	6	BPR5EIX	6597
Vitara	1.6	70	09.93-	G16B	4	0,9	BKR6E	6962	28	BKR6EIX	6418
Vitara Long	1.6	71	91-	G16B SOHC Cat.	4	0,9	BKR6E	6962	28	BKR6EIX	6418
Vitara 16V	1.6	71	04.95-	G16A	4	0,9	BKR6E	6962	28	BKR6EIX	6418

<sup>1)</sup> Bic = Best in class



ℓ kW

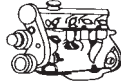

Cyl.

Order-  
No. No.Bic<sup>1)</sup> Order-  
D-Power No.**SUZUKI**

Vitara TD	1.9	50	04.96 - 03.98		4	█	Y-938R	5267		D-POWER 1	7906
Vitara TD	1.9	55	97 - 98		4	█	Y-923U	3380		D-POWER 1	7906
Vitara TD	1.9	66	05.00 -	XUD... PSA Group	4	█	Y-923U	3380		D-POWER 1	7906
Vitara	2.0			J20A	6	0,9	BKR6E	6962	28	BKR6EIX	6418
Vitara D	2.0	52	95 -	RFL-4	4	█	Y-701R	7464			
Vitara (SV620)	2.0	100	06.95 -	H20A	6	0,9	BKR6E	6962	28	BKR6EIX	6418
Vitara V6 (SV620)	2.5	125	05.98 -	H25A	6	1,1	BKR6E-11	2756	14	BKR6EIX-11	3764
Wagon R+ (SR410)	1.0	48	97 -	K10A	4	0,8	DCPR7E	3932		DCPR7EIX	6046
Wagon R+	1.0	55	02.04 -	G10	4	1,1	BPR6ES-11	4824	13	BPR6EIX-11	3903
Wagon R+	1.2	51	98 -	K12A	4	0,8	DCPR7E	3932		DCPR7EIX	6046
Wagon R+ DDiS (RB413D)	1.3	51	09.03 -	Z13DT	4	█	YE06	5285			
Wagon R GL	1.3	56	04.00 -	G13BB	4	1,1	BKR6E-11	2756	14	BKR6EIX-11	3764
Wagon R+	1.3	68	02.04 -	M13A mit VVT	4	1,1	IFR6J-11	7658			
Wagon R+	1.3	69		G13BB	4	1,1	BKR6E-11	2756	14	BKR6EIX-11	3764
X-90	1.6	71	10.95 -	G16A	4	0,9	BKR6E	6962	28	BKR6EIX	6418
X-90	1.6	71	03.96 -	G16B/G16W	4	0,9	BKR6E	6962	28	BKR6EIX	6418

**TALBOT**

1500/1501 S/1508 GT/GTS	1.5				4	0,7	BP6ES	7811	4	BPR6EIX	6637
Express D	1.9	51	11.87 -	XUD 9 A	4	█	Y-902R	2237		D-POWER 1	7906
Express D	2.5	55	09.81 - 10.93	CRD 93	4	█	Y-208T	1250			
Express TD	2.5	70	09.81 - 10.93	CRD 93 LS	4	█	Y-208T	1250			
Horizon D	1.9	51	11.87 -	XUD9A	4	█	Y-902R	2237		D-POWER 1	7906

**TATRA**

613-3	3.5	123	01.84 - 03.94		6	0,7	BCP6ES	4930	17	BCPR6EIX	5689
613-4	3.5	124	93 -		8	0,9	BKR6E	6962	28	BKR6EIX	6418

**TAXI**

Fairway	2.7			NISSAN	4	█	Y-707RS	4937			
---------	-----	--	--	--------	---	---	---------	------	--	--	--

**TOFAS**

124 Serce	1.3	48	09.83 -		4	0,7	BP6ES	7811	4	BPR6EIX	6637
131 Dogan	1.6	55	03.81 -		4	0,7	BP6ES	7811	4	BPR6EIX	6637
131 Dogan S/SX/SLX	1.6	55	06.92 -		4	0,8	BPR6ES	7822	2	BPR6EIX	6637
131 Kartal SL / SLX	1.6	55	06.92 -		4	0,8	BPR6ES	7822	2	BPR6EIX	6637
131 Kartal L	1.6	55	03.81 - 06.92		4	0,7	BP6ES	7811	4	BPR6EIX	6637
Sahin	1.6	55	02.82 -		4	0,7	BP6ES	7811	4	BPR6EIX	6637
Tempra	1.6	63	11.90 -		4	0,8	BPR6ES	7822	2	BPR6EIX	6637
Tempra i.e.	2.0	88	07.92 -		4	0,8	BPR6ES	7822	2	BPR6EIX	6637

**TOFAS / FIAT**

Brava 16V	1.2		11.98 - 09.01	16V	4	0,9	DCPR8E-N	5692			
Brava 1.4 12V	1.4		10.95 - 10.98	12V	4	0,9	BKR6EKC	2848	26		
Bravo 16V	1.2		11.98 - 09.01	16V	4	0,9	DCPR8E-N	5692			
Bravo 1.4 12V	1.4		10.95 - 10.98	12V	4	0,9	BKR6EKC	2848	26		
Doblo 16V	1.3		11.01 -	MPI 16V	4	0,9	DCPR8E-N	5692			
Marea 1.4 12V	1.4		10.96 - 02.99	12V	4	0,9	BKR6EKC	2848	26		
Marea 2.0 20V	2.0		10.96 - 02.99	20V	4	0,9	BKR6EKC	2848	26		
Palio 1.2 i.e.	1.2		10.01 -	16V	4	0,9	DCPR8E-N	5692			
Palio Weekend 1.2 i.e.	1.2		10.01 -	16V	4	0,9	DCPR8E-N	5692			
Palio Weekend 16V	1.3		03.00 -	MPI 16V	4	0,9	DCPR8E-N	5692			

<sup>1)</sup> Bic = Best in class



ℓ kW

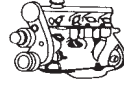

Cyl.

Order-  
No. No.Bic<sup>1)</sup> Order-  
D-Power No.**TOFAS / FIAT**

Palio 16V	1.3		03.00 -	MPI 16V	4	0,9	DCPR8E-N	5692				
Palio 1.4 i.e.	1.4		03.98 - 09.01		4	0,8	BKR5EK	7956	23	BKR5EIX	6341	
Palio Weekend 1.4 i.e.	1.4		09.98 - 06.01		4	0,8	BKR5EK	7956	23	BKR5EIX	6341	
Siena 16V	1.3		03.00 -	MPI 16V	4	0,9	DCPR8E-N	5692				
Siena 1.4 i.e.	1.4		05.98 - 06.01		4	0,8	BKR5EK	7956	23	BKR5EIX	6341	
Stilo 16V	1.2		10.01 -	16V	4	0,9	DCPR8E-N	5692				
Stilo S.W. 1.6 16V	1.6		01.03 -	16V	4	0,9	BKR5EZ	7642				
Stilo 1.6 16V	1.6		10.01 -	16V	4	0,9	BKR5EZ	7642				
Stilo 1.8 16V	1.8		10.01 -	16V	4	0,9	BKR6EZ	4619		BKR6EIX	6418	
Stilo S.W. 1.8 16V	1.8		01.03 -	16V	4	0,9	BKR6EZ	4619		BKR6EIX	6418	

**TOYOTA**

4 Runner TD	2.4		01.90 - 12.96	2L-T	4	█	Y-715R	5376				
4 Runner D	2.4			2L	4	█	Y-118R	2187				
4 Runner	2.4	82	89 -	22R/22RE Cat.	4	0,8	BPR5EY	2828	9	BPR5EIX	6597	
4 Runner D	2.5		01.93 -	2L-T	4	█	Y-715R	5376				
4 Runner (RZN180,185,VZN180 185)	2.7		01.00 -	3RZ-FE	6	0,8	BKR5EYA	2087				
4 Runner (RZN185)	2.7	112	98 - 12.99	3RZ-FE	6	0,8	BKR5EYA	2087				
4 Runner (VZN185)	2.7	112	98 - 12.99	3RZ-FE	6	0,8	BKR5EYA	2087				
4 Runner D	2.8		01.93 -	3L	4	█	Y-715R	5376				
4 Runner	2.8		93 -	3L	4	█	Y-715R	5376				
4 Runner	2.8			2L	4	█	Y-168R	2162				
4 Runner	3.0	105	89 -	3VZ-E Cat.	6	0,8	BKR5EYA	2087				
4 Runner (RZN180,185,VZN180,185)	3.4		01.00 -	5VZ-FE	6	1,1	BKR5EKB-11	3967				
4 Runner (VZN185)	3.4	136	98 - 12.99	5VZ-FE	6	1,1	BKR5EKB-11	3967				
4 Runner (RZN185)	3.4	136	98 - 12.99	5VZ-FE	6	1,1	BKR5EKB-11	3967				
4 Runner (GRN210,215)	4.0		01.04 -	1GR-FE	6	1,1	LF6C-11	5788				
Auris 1.4 VVT-i (ZRE131,151,152) (ZZE150)	1.4	71	10.06 -	4ZZ-FE	4	1,1	BKR5EYA-11	2526				
Avalon (MCX20)	3.0		01.01 - 12.01	1MZ-FE	6	1,1	BKR6EKB-11	3583				
Avalon (MCX20)	3.0		01.02 -	1MZ-FE	6	1,1	BKR6EKP-11	3452				
Avensis (ZZT250,251)(AZT250)	1.6		09.03 -	3ZZ-FE	4	1,1	BKR5EYA-11	2526				
Avensis (ZZT220, 221)	1.6		01.02 -	3ZZ-FE	4	1,1	BKR5EYA-11	2526				
Avensis (ST220)	1.6		01.02 -	3ZZ-FE	4	1,1	BKR5EYA-11	2526				
Avensis (AZT220)	1.6		01.02 -	3ZZ-FE	4	1,1	BKR5EYA-11	2526				
Avensis (AT220,221,ST220)	1.6	81	04.98 -	4A-FE	4	1,1	BKR6EYA-11	4073				
Avensis (ZZT250,251)(AZT250)	1.8		09.03 -	1ZZ-FE	4	1,1	BKR5EYA-11	2526				
Avensis (AZT220)	1.8		01.02 -	1ZZ-FE	4	1,1	BKR5EYA-11	2526				
Avensis (AT220,221,ST220)	1.8	81	01.98 -	7A-FE	4	1,3	BKR6EP-13	2550				
Avensis (ST220)	1.8	95	01.02 -	1ZZ-FE	4	1,1	BKR5EYA-11	2526				
Avensis (ZZT220, 221)	1.8	95	01.02 -	1ZZ-FE	4	1,1	BKR5EYA-11	2526				
Avensis (ZZT250,251)(AZT250)	2.0		09.03 -	1AZ-FSE	4	1,1	IFR6A-11					
Avensis (1AZ-FE)	2.0		01.03 -	1AZ-FE with 3way cat	4	1,1	IFR6T-11	4589				
Avensis (1AZ-FE)	2.0		01.03 -	1AZ-FE without cat	4	1,1	BKR6EYA-11	4073				
Avensis (ST220)	2.0		01.02 -	3S-FE	4	1,1	BKR6EKB-11	3583				
Avensis (ZZT220, 221)	2.0		01.02 -	3S-FE	4	1,1	BKR6EKB-11	3583				
Avensis (AZT220)	2.0		01.02 -	3S-FE	4	1,1	BKR6EKB-11	3583				
Avensis (CT220)	2.0	66	01.98 -	2C-T	4	█	Y-532J	7782				
Avensis (CDT220, 250)	2.0	81	07.00 -	1CD-FTV	4	█	Y-531J	2979		D-POWER 44	5467	
Avensis (AT220,221,ST220)	2.0	94	01.98 -	3S-FE	4	1,1	BKR6EKP-11	3452				
Avensis (ST220)	2.0	108	01.02 -	1AZ-FSE	4	1,1	IFR6A-11T					
Avensis (AZT220)	2.0	108	01.02 -	1AZ-FSE	4	1,1	IFR6A-11T					

<sup>1)</sup> Bic = Best in class





ℓ kW

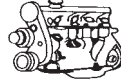

Cyl.

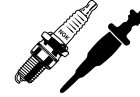
Order-  
No. No.Bic<sup>1)</sup> Order-  
D-Power No.**TOYOTA**

Avensis (ZZT250,251)(AZT250)	2.4	120	09.03 -	2AZ-FSE	4	1,1	IFR6A-11T				
Avensis II (ZZT250;251)(AZT250)	1.6	81	03.03 -	3ZZ-FE	4	1,1	BKR5EYA-11	2526			
Avensis II (ZZT250;251)(AZT250)	1.8	95	03.03 -	1ZZ-FE	4	1,1	BKR5EYA-11	2526			
Avensis II (ATZ250)	2.0	110	01.03 -	1AZ-FE WT-i	4	1,1	IFR6T-11	4589			
Avensis II (ATZ250) D4	2.0	110	01.03 -	1AZ-FE WT-i D4	4	1,1	IFR6A-11				
Avensis Verso (ACM20)	2.0	110	05.01 -	1AZ-FE	4	1,1	IFR6T-11	4589			
Avensis Verso (ACM20)	2.4		01.04 -	2AZ-FE	4	1,1	BKR6EYA-11	4073			
Aygo	1.0	50	05.05 -	1KR-FE	3	1,1	LFR6C-11	5788			
Aygo	1.4	52	06.05 -		4	█	YE05	5207			
Camry (ACV30,31)	2.0		08.01 -	1AZ-FE	4	1,1	IFR6T-11	4589			
Camry (MCV30)	2.0		08.01 -	1AZ-FE	4	1,1	IFR6T-11	4589			
Camry	2.0		- 92	1-CT	4	█	Y-146R	7492			
Camry	2.0	62	90 - 91	2C-T	4	█	Y-703R	3782			
Camry (SV20,21,25,VZV21)	2.0	89	86 -	3S-FE Cat.	4	1,1	BCPR6EY-11	3720	BCPR6EIX-11	4919	
Camry (SV20,21,25,VZV21)	2.0	94	87 -	3S-FE	4	1,1	BCPR6EY-11	3720	BCPR6EIX-11	4919	
Camry (SVX20, MCV20)	2.2		01.00 -	5S-FE	4	1,1	BKR6EKB-11	3583			
Camry (MCV20)	2.2		98 - 12.99	5S-FE	4	1,1	BKR6EKP-11	3452			
Camry (SVX20)	2.2		98 - 12.99	5S-FE	4	1,1	BKR6EKP-11	3452			
Camry MCV20	2.2	100	08.96 - 12.99	5S-FE without 3way cat	4	1,1	BKR6EKB-11	3583			
Camry SXV20	2.2	100	08.96 - 12.99	5S-FE with 3way cat	4	1,1	BKR6EKP-11	3452			
Camry SXV20	2.2	100	08.96 - 12.99	5S-FE without 3way cat	4	1,1	BKR6EKB-11	3583			
Camry MCV20	2.2	100	08.96 - 12.99	5S-FE with 3way cat	4	1,1	BKR6EKP-11	3452			
Camry (SXV10,VCV10)	2.2	100	92 -	5S-FE	4	1,1	BKR6EYA-11	4073			
Camry (ACV30,31)	2.4		08.01 -	2AZ-FE	6	1,1	IFR6T-11	4589			
Camry (MCV30)	2.4		08.01 -	2AZ-FE	6	1,1	IFR6T-11	4589			
Camry (SV21,25,VZV21)	2.5	118	88 - 92	2VZ-FE Cat.	6	1,1	BCPR6EP-11	3350	BCPR6EIX-11	4919	
Camry (MCV30)	3.0		08.01 -	1MZ-FE	6	1,1	IFR6T-11	4589			
Camry (ACV30,31)	3.0		08.01 -	1MZ-FE	6	1,1	IFR6T-11	4589			
Camry (SVX20, MCV20)	3.0	137	01.00 -	1MZ-FE V6	6	1,1	BKR6EKP-11	3452			
Camry MCV20	3.0	138	08.96 - 12.99	1MZ-FE without 3way cat	6	1,1	BKR6EKB-11	3583			
Camry SXV20	3.0	138	08.96 - 12.99	1MZ-FE without 3way cat	6	1,1	BKR6EKB-11	3583			
Camry (SXV10,VCV10)	3.0	138	92 -	3VZ-FE	6	1,1	BCPR6EP-11	3350	BCPR6EIX-11	4919	
Camry SXV20	3.0	138	08.96 - 12.99	1MZ-FE with 3way cat	6	1,1	BKR6EKP-11	3452			
Camry MCV20	3.0	138	08.96 - 12.99	1MZ-FE with 3way cat	6	1,1	BKR6EKP-11	3452			
Carina E (AT190,191,ST191)	1.6		93 -	4A-FE Standard engine	4	0,8	BKR6EYA	2249			
Carina E (AT190,191,ST191)	1.6	77	93 -	4A-FE Lean Burn engine	4	1,3	BKR6EP-13	2550			
Carina E (AT190,191,ST191)	1.8	79	95 -	7A-FE	4	1,3	BKR6EP-13	2550			
Carina E	2.0		02.92 -	2C	4	█	Y-703R	3782			
Carina E (AT190,191,ST191)	2.0	98	93 - 97	3S-FE Cat.	4	1,1	BKR6EYA-11	4073			
Carina E (AT190,191,ST191)	2.0	116	93 -	3S-GE Cat.	4	0,8	BKR6EP-8	2215	BKR6EIX	6418	
Carina E (DK)	1.6		92 -	4A-FE Cat.	4	0,8	BKR6EYA	2249			
Carina E (DK)	1.6		92 -	4A-FE Cat. Lean Burn	4	1,3	BKR6EP-13	2550			
Carina E (DK)	1.8		92 -	7A-FE Cat. Lean Burn	4	1,3	BKR6EP-13	2550			
Carina E (DK)	2.0		92 -	3S-FE Cat. Lean Burn	4	1,1	BKR6EP-11	2978	BKR6EIX-11	3764	
Carina E (DK)	2.0		92 -	3S-FE Cat.	4	1,1	BKR6EYA-11	4073			
Carina II (AT171,177,ST171)	1.6	66	- 90	4A-F	4	0,8	BCRE527Y	2074			
Carina II (AT171,177,ST171)	1.6	66	87 - 92	4A-F Cat.	4	0,8	BCRE527Y	2074			
Carina II (AT171,177,ST171)	1.6	72	90 - 92	4A-FE with EGR	4	0,8	BCPR5EY	1266	BCPR5EIX	5688	
Carina II (AT171,177,ST171)	1.6	72	90 - 92	4A-FE	4	0,8	BCPR5EY	1266	BCPR5EIX	5688	
Carina II (AT171,177,ST171)	1.6	72	90 - 92	4A-FE without EGR	4	1,3	BCPR6EP-13	3837			
Carina II (AT171,177,ST171)	1.6	72	90 - 92	4A-FE Cat.	4	1,3	BCPR6EP-13	3837			
Carina II (AT171,177,ST171)	1.6	75	88 - 90	4A-FE u.Cat.	4	1,3	BCPR6EP-13	3837			

<sup>1)</sup> Bic = Best in class



ℓ kW

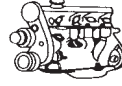

Cyl.

Order-  
No. No.Bic<sup>1)</sup> Order-  
D-Power No.**TOYOTA**

Carina II	2.0		- 92	2C	4	☑	Y-146R	7492			
Carina II	2.0		93-	2C	4	☑	Y-703R	3782			
Carina II	2.0	89	- 88	3S-F	4	0,9	BCPR6EY	1146		BCPR6EIX	5689
Carina II (AT171,177,ST171)	2.0	89	88- 92	3S-F	4	1,1	BCPR6EY-11	3720		BCPR6EIX-11	4919
Carina II (AT171,177,ST171)	2.0	98	88- 92	3S-FE Cat.	4	1,1	BCPR6EY-11	3720		BCPR6EIX-11	4919
Celica (AT160,ST162,165)	1.6	62	- 88	4A	4	0,8	BPR5EY	2828	9	BPR5EIX	6597
Celica (AT180,ST182,184,185)	1.6	77	90- 94	4A-FE	4	0,8	BCPR5EY	1266		BCPR5EIX	5688
Celica (AT160,ST162,165)	1.6	91	- 89	4A-GE Cat.	4	1,1	BCPR5EP-11	2097		BCPR5EIX-11	3306
Celica (AT160,ST162,165)	1.6	91	- 89	4A-GE	4	1,1	BCPR6EY-11	3720		BCPR6EIX-11	4919
Celica (ZZT230,231)	1.8		08.99-	2ZZ-GE	4	1,1	IFR6T-11	4589			
Celica (ZZT230,231)	1.8		08.99-	1ZZ-FE	4	1,1	BKR5EYA-11	2526			
Celica (AT200,ST202,204,205)	1.8	85	03.94-	7A-FE	4	0,8	BKR6EYA	2249			
Celica S (ZZT230)	1.8	105	08.99-	1ZZ-FE	4	1,1	BKR5EYA-11	2526			
Celica	2.0		90- 99	3S-GTE	4	0,8	BKR6EP-8	2215		BKR6EIX	6418
Celica (ST202,204,205)	2.0		98-	3S-GE	4	0,8	BKR6EP-8	2215		BKR6EIX	6418
Celica (AT200)	2.0		98-	3S-GE	4	0,8	BKR6EP-8	2215		BKR6EIX	6418
Celica (AT160,162,165)	2.0		- 88	3S-FE	4	1,1	BCPR6EY-11	3720		BCPR6EIX-11	4919
Celica (AT200,ST202,204,205)	2.0	95	94-	3S-FE	4	1,1	BKR6EYA-11	4073			
Celica (AT160,162,165)	2.0	103	- 89	3S-GE Cat.	4	1,1	BCPR6EP-11	3350		BCPR6EIX-11	4919
Celica (AT160,162,165)	2.0	110	86- 89	3S-GE	4	1,1	BCPR6EY-11	3720		BCPR6EIX-11	4919
Celica (AT180,200,ST182,184,185,202,204,205)	2.0	115	90-	3S-GE Cat.	4	0,8	BKR6EP-8	2215		BKR6EIX	6418
Celica (AT180,200,ST182,184,185,202,204,205)	2.0	129	03.94-	3S-GE	4	0,8	BKR6EP-8	2215		BKR6EIX	6418
Celica (ST202,204,205)	2.2		98-	5S-FE	4	1,1	BKR6EP-11	2978		BKR6EIX-11	3764
Celica (AT200)	2.2		98-	5S-FE	4	1,1	BKR6EP-11	2978		BKR6EIX-11	3764
Celica (AT180,ST182,184,185)	2.2	100	91-	5S-FE Cat.	4	1,1	BKR6EP-11	2978		BKR6EIX-11	3764
Celica (AT180,ST182,184,185)	2.2	100	- 90	5S-FE Cat.	4	1,1	BKR5EYA-11	2526			
Celica Supra	3.0			7M-GE	6	0,9	BCPR6EY	1146		BCPR6EIX	5689
Celica Turbo	2.0	136	- 89	3S-GTE	4	0,8	BCPR5EP-8	2950		BCPR5EIX	5688
Celica Turbo (AT200,ST202,204,205)	2.0	150	90-	3S-GTE	4	0,8	BKR6EP-8	2215		BKR6EIX	6418
Coaster			- 93	13B		☑	Y-197T	2190			
Coaster			05.82-	B, 2B, 3B	4	☑	Y-197R	2188			
Coaster			- 93	13B		☑	Y-147T	7493			
Coaster	4.0		05.82-	2H	6	☑	Y-197R	2188			
Corolla	1.2			3K	4	0,9	BPR5ES	7422	6	BPR5EIX	6597
Corolla (ZZE120,121,122,123)	1.3		10.01- 07	2NZ-FE	4	1,1	BKR5EYA-11	2526			
Corolla (EE110,111)	1.3		98-12.99	2E	4	0,8	BPR6EY	6427		BPR6EIX	6637
Corolla (EE110,111)	1.3		98-12.99	4E-FE (16V DOHC)	4	1,1	BKR5EKB-11	3967			
Corolla (EE100,101,105,AE101,102)	1.3		94- 07	2E	4	0,8	BPR6EY	6427		BPR6EIX	6637
Corolla (AE110,111,112,115)	1.3		98-12.99	2E	4	0,8	BPR6EY	6427		BPR6EIX	6637
Corolla (EE110,111,AE110-112,115, ZZE111,112)	1.3		01.00- 07	2E	4	0,8	BPR6EY	6427		BPR6EIX	6637
Corolla (EE110,111,AE110-112,115, ZZE111,112)	1.3		01.00- 07	4E-FE	4	1,1	BKR5EKB-11	3967			
Corolla (AE110,111,112,115)	1.3		98-12.99	4E-FE	4	1,1	BKR5EKB-11	3967			
Corolla	1.3		07.97-12.99	4E-FE	4	1,1	BKR5EYA-11	2526			
Corolla (EE100,101,105,AE101,102)	1.3		92- 97	4E-FE	4	0,8	BKR5EYA	2087			
Corolla (EE100,101,105,AE101,102)	1.3		95-12.99	2E o.Cat.	4	1,1	BPR5EY-11	3028		BPR5EIX-11	2115
Corolla (EE100,101,105,AE101,102)	1.3		93- 97	2E	4	0,8	BPR6EY	6427		BPR6EIX	6637
Corolla	1.3		- 00	2A (8V SOHC)	4	0,8	BPR5EY	2828	9	BPR5EIX	6597
Corolla (NZE120,121)	1.3		10.01- 07	2NZ-FE	4	1,1	BKR5EYA-11	2526			

<sup>1)</sup> Bic = Best in class



ℓ kW

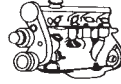

Cyl.

Order-  
No. No.Bic<sup>1)</sup> Order-  
D-Power No.**TOYOTA**

Corolla (EE80,90,97,100,105,AE82,92,95,101)	1.3	55	86 - 92	2E	4	1,1	BPR6EY-11	4228	10	BPR6EIX-11	3903
Corolla (EE90,97,AE92,95)	1.3	55	90 - 92	2E-E	4	0,8	BPR5EY	2828	9	BPR5EIX	6597
Corolla (EE105)	1.3	63	07.97 - 07	2E	4	0,8	BPR6EY	6427		BPR6EIX	6637
Corolla EE110,111,AE110,111,112,115	1.4		01.98 - 07	4E-FE	4	1,1	BKR5EKB-11	3967			
Corolla (NZE120,121)	1.4		10.01 - 07	4ZZ-FE	4	1,1	BKR5EYA-11	2526			
Corolla (ZZE120,121,122,123)	1.4		10.01 - 07	4ZZ-FE	4	1,1	BKR5EYA-11	2526			
Corolla	1.4		- 91		4	0,9	BPR5ES	7422	6	BPR5EIX	6597
Corolla (EE100,101,105,AE101,102)	1.4	65	92 - 94	4E-FE	4	0,8	BKR6EYA	2249			
Corolla (EE110,111,AE110-112,115,ZZE111,112)	1.4	71	01.00 - 07	4ZZ-FE	4	1,1	BKR5EYA-11	2526			
Corolla (NZE120,121 ZZE120,121,122,123)	1.4	71	01.02 - 07	4ZZ-FE	4	1,1	BKR5EYA-11	2526			
Corolla	1.5			1N,1NT	4	█	Y-118R	2187			
Corolla (NZE120,121)	1.5		10.01 - 07	1NZ-FE	4	1,1	BKR5EYA-11	2526			
Corolla (AE110,111,112,115)	1.5		98 - 12.99	5A-FE	4	1,1	BKR5EYA-11	2526			
Corolla (EE110,111,AE110-112,115,ZZE111,112)	1.5		01.00 - 07	5A-FE	4	1,1	BKR5EYA-11	2526			
Corolla (EE110,111)	1.5		98 - 12.99	5A-FE	4	1,1	BKR5EYA-11	2526			
Corolla (ZZE120,121,122,123)	1.5		10.01 - 07	1NZ-FE	4	1,1	BKR5EYA-11	2526			
Corolla (EE110,111)	1.6		98 - 12.99	4A-FE	4	0,8	BKR6EYA	2249			
Corolla (AE110,111,112,115)	1.6		98 - 12.99	4A-FE	4	0,8	BKR6EYA	2249			
Corolla Spacio (AE111)	1.6		01.00 - 07	4A-FE	4	0,8	BKR6EYA	2249			
Corolla (EE110,111,AE110-112,115,ZZE111,112)	1.6		01.00 - 07	4A-FE	4	0,8	BKR6EYA	2249			
Corolla (EE100,101,105,AE101,102)	1.6		95 - 12.99	4A-FE	4	0,8	BKR6EYA	2249			
Corolla (EE110,111,AE110-112,115,ZZE111,112)	1.6		01.00 - 07	4A-F	4	0,8	BCRE527Y	2074			
Corolla (AE110,111,112,115)	1.6		98 - 12.99	4A-F	4	0,8	BCRE527Y	2074			
Corolla (EE110,111)	1.6		98 - 12.99	4A-F	4	0,8	BCRE527Y	2074			
Corolla	1.6	55		2T	4	0,8	BPR5EA-L	5823			
Corolla (EE90,97,100,101,105,AE92,95,101,102)	1.6	66	87 - 12.99	4A-F	4	0,8	BCRE527Y	2074			
Corolla (EE90,97,AE92,95)	1.6	77	89 - 91	4A-FE Cat.	4	0,8	BCPR5EY	1266		BCPR5EIX	5688
Corolla (ZZE121)	1.6	81	11.01 - 07	3ZZ-FE	4	1,1	BKR5EYA-11	2526			
Corolla (EE110,111,AE110-112,115,ZZE111,112)	1.6	81	01.00 - 07	3ZZ-FE	4	1,1	BKR5EYA-11	2526			
Corolla (ZZE120,121,122,123)	1.6	81	10.01 - 07	3ZZ-FE	4	1,1	BKR5EYA-11	2526			
Corolla (NZE120,121)	1.6	81	10.01 - 07	3ZZ-FE	4	1,1	BKR5EYA-11	2526			
Corolla	1.6	81	07.97 - 07	4A-FE	4	1,1	BKR5EYA-11	2526			
Corolla (EE100,101,105,AE101,102)	1.6	84	92 - 94	4A-FE	4	0,8	BKR6EYA	2249			
Corolla (EE90,97,AE92,95)	1.6	85	90 -	4A-GE Cat.	4	0,8	BKR6EP-8	2215		BKR6EIX	6418
Corolla (EE90,AE92)	1.6	85	- 89	4A-GE Cat.	4	1,1	BCPR5EP-11	2097		BCPR5EIX-11	3306
Corolla	1.6	85	93 -	4A-GE Cat.	4	0,8	BKR6EYA	2249			
Corolla	1.8		12.92 -	1C	4	█	Y-703R	3782			
Corolla (EE110,111,AE110-112,115,ZZE111,112)	1.8		01.00 -	7A-FE	4	0,8	BKR6EYA	2249			
Corolla (EE110,111)	1.8		98 - 12.99	7A-FE	4	0,8	BKR6EYA	2249			
Corolla	1.8		- 92	1C	4	█	Y-146R	7492			
Corolla (AE110,111,112,115)	1.8		98 - 12.99	7A-FE	4	0,8	BKR6EYA	2249			
Corolla (EE100,101,105,AE101,102)	1.8		93 - 12.99	7A-FE	4	0,8	BKR6EYA	2249			

<sup>1)</sup> Bic = Best in class



l kW

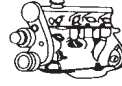

Cyl.

Order-  
No. No.Bic<sup>1)</sup> Order-  
D-Power No.**TOYOTA**

Corolla (NZE120,121)	1.8	99	10.01 - 07	1ZZ-FE	4	1,1	BKR5EYA-11	2526				
Corolla (ZZE120,121,122,123)	1.8	99	10.01 - 07	1ZZ-FE	4	1,1	BKR5EYA-11	2526				
Corolla (ZZE123) Sport	1.8	141	02 - 07	2ZZ-GE	4	1,1	IFR6T-11	4589				
Corolla (NZE120,121)	1.8	141	10.01 - 07	2ZZ-GE	4	1,1	IFR6T-11	4589				
Corolla (ZZE120,121,122,123)	1.8	141	10.01 - 07	2ZZ-GE	4	1,1	IFR6T-11	4589				
Corolla 4WD	1.6		95 -	4A-FE	4	0,8	BCPR5EY	1266		BCPR5EIX	5688	
Corolla 4WD	1.6	84	93 -	4A-FE	4	0,8	BCPR5EY	1266		BCPR5EIX	5688	
Corolla Spacio (AE111)	1.6		01.01 - 07	4A-FE	4	0,8	BKR6EYA	2249				
Corolla Verso (ZZE121, 122)	1.6		09.01 - 07	3ZZ-FE	4	1,1	BKR5EYA-11	2526				
Corolla Verso (ZNR10)	1.6		08.05 - 07	3ZZ-FE	4	1,1	BKR5EYA-11	2526				
Corolla Verso (ZNR10)	1.8		08.05 - 07	1ZZ-FE	4	1,1	BKR5EYA-11	2526				
Corolla Verso (ZZE121, 122)	2.0		09.01 - 07	1ZZ-FE	4	1,1	BKR5EYA-11	2526				
Corona (AZT220)	1.6		01.02 -	3ZZ-FE	4	1,1	BKR5EYA-11	2526				
Corona (AT171,177,ST171)	1.6		- 89	4A-FE Cat.	4	1,3	BCPR5EP-13	2529				
Corona (AT190,ST191)	1.6		93 -	4A-FE	4	1,1	BKR5EYA-11	2526				
Corona (ST210, AT210)	1.6		01.00 -	4A-FE	4	0,8	BKR6EYA	2249				
Corona (ZZT220, 221)	1.6		01.02 -	3ZZ-FE	4	1,1	BKR5EYA-11	2526				
Corona (ST220)	1.6		01.02 -	3ZZ-FE	4	1,1	BKR5EYA-11	2526				
Corona (AT171,177,ST171)	1.6	66	88 - 92	4A-F Cat.	4	0,8	BCRE527Y	2074				
Corona (AT171,177,ST171)	1.6	70		4A-F	4	0,8	BCRE527Y	2074				
Corona	1.6	70		4A-F Cat. not Europe	4	1,1	BCPR5EY-11	4120		BCPR5EIX-11	3306	
Corona (AT171,177,ST171)	1.6	72	90 - 92	4A-FE	4	1,3	BCPR6EP-13	3837				
Corona (AT171,177,ST171)	1.6	75	90 - 92	4A-FE	4	0,8	BCPR5EY	1266		BCPR5EIX	5688	
Corona (AT220,221,ST220)	1.6	81	04.98 -	4A-FE	4	1,3	BKR6EP-13	2550				
Corona	1.8			1S-I	4	1,1	BRE527Y-11	6029				
Corona (ZZT220, 221)	1.8		01.02 -	1ZZ-FE	4	1,1	BKR5EYA-11	2526				
Corona (AZT220)	1.8		01.02 -	1ZZ-FE	4	1,1	BKR5EYA-11	2526				
Corona (ST220)	1.8		01.02 -	1ZZ-FE	4	1,1	BKR5EYA-11	2526				
Corona	1.8	57	86 -	2Y	4	0,8	BPR5EY	2828	9	BPR5EIX	6597	
Corona (AT220,221,ST220)	1.8	81	01.98 -	7A-FE	4	1,3	BKR6EP-13	2550				
Corona (ST210, AT210)	2.0		01.00 -	3S-FE	4	1,1	BKR6EKB-11	3583				
Corona (AT171,177,ST171)	2.0		- 92	3S-F	4	1,1	BCPR6EY-11	3720		BCPR6EIX-11	4919	
Corona (ST220)	2.0		01.02 -	1AZ-FSE	4	1,1	IFR6A-11T					
Corona (ST220)	2.0		01.02 -	3S-FE	4	1,1	BKR6EKB-11	3583				
Corona	2.0		93 -	2C	4	█	Y-703R	3782				
Corona (AZT220)	2.0		01.02 -	3S-FE	4	1,1	BKR6EKB-11	3583				
Corona (ZZT220, 221)	2.0		01.02 -	1AZ-FSE	4	1,1	IFR6A-11T					
Corona (ZZT220, 221)	2.0		01.02 -	3S-FE	4	1,1	BKR6EKB-11	3583				
Corona (AZT220)	2.0		01.02 -	1AZ-FSE	4	1,1	IFR6A-11T					
Corona	2.0		- 92	2C	4	█	Y-146R	7492				
Corona (AT171,177,ST171)	2.0	89	- 92	3S-FE Cat.	4	1,1	BCPR6EY-11	3720		BCPR6EIX-11	4919	
Corona (AT220,221,ST220)	2.0	94	01.98 -	3S-FE	4	1,1	BKR6EKP-11	3452				
Corona (AT190,191,ST191)	2.0	98	93 -	3S-FE	4	1,1	BKR6EYA-11	4073				
Corona (AT171,177,ST171)	2.0	116	92 -	3S-GE	4	0,8	BKR6EP-8	2215		BKR6EIX	6418	
Corona Super Glow System	2.2		08.82 -	L	4	█	Y-118R	2187				
Corona	2.2		08.82 -	L	4	█	Y-118T1	2951				
Corona	2.4			2L / 2L-T	4	█	Y-118R	2187				
Cressida	2.0	73	85 -	21R	4	0,8	BPR5EY	2828	9	BPR5EIX	6597	
Cressida	2.0	80	- 88	1G-E	4	0,8	BPR6EY	6427		BPR6EIX	6637	
Cressida	2.0	80		1G-GE	4	1,1	BCPR6EY-11	3720		BCPR6EIX-11	4919	
Cressida	2.0	99	90 -	1G-FE	4	0,8	BKR6EYA	2249				
Cressida Super Glow System	2.2		08.82 -	L	4	█	Y-118R	2187				

<sup>1)</sup> Bic = Best in class



ℓ kW

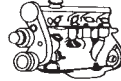

Cyl.

Order-  
No. No.Bic<sup>1)</sup> Order-  
D-Power No.**TOYOTA**

Cressida	2.2		08.82 -	L	4	█	Y-118T1	2951			
Cressida	2.4	77		22R	4	0,8	BPR5EY	2828	9	BPR5EIX	6597
Cressida	2.5		93 -	2L	4	█	Y-715R	5376			
Cressida	2.8	92	84 -	5M-E	6	0,8	BPR5EY	2828	9	BPR5EIX	6597
Cressida	2.8	125	85 -	5M-GE	6	0,8	BPR6EY	6427		BPR6EIX	6637
Cressida	3.0	142	88 -	7M-GE Cat.	6	1,1	BCPR5EP-11	2097		BCPR5EIX-11	3306
Crown			09.83 - 91	2L	4	█	Y-118T1	2951			
Crown (JZS155)	2.0		98 -	1G-FE	4	1,1	BKR5EYA-11	2526			
Crown	2.0		93 -	1G-FE	4	0,8	BKR6EYA	2249			
Crown (GS151)	2.0		98 -	1G-FE	4	1,1	BKR5EYA-11	2526			
Crown	2.2		08.80 -	L	4	█	Y-118T1	2951			
Crown Super Glow System	2.2		08.80 -	L	4	█	Y-118R	2187			
Crown	2.5		93 -	2L	4	█	Y-715R	5376			
Crown	2.8			5M	6	0,8	BPR5EY	2828	9	BPR5EIX	6597
Crown	2.8		86 -	5M-GE	6	0,8	BPR5EY	2828	9	BPR5EIX	6597
Crown (GS151)	2.9		98 -	2JZ-GE with 3way cat.	6	1,1	BKR5EKB-11	3967			
Crown (JZS155)	2.9		98 -	2JZ-GE without 3way cat.	6	0,8	BKR6EYA	2249			
Crown (JZS155)	2.9		98 - 12.99	2JZ-GE with 3way cat.	6	1,1	BKR5EKB-11	3967			
Crown (GS151)	2.9		98 -	2JZ-GE without 3way cat.	6	0,8	BKR6EYA	2249			
Crown (JZS175)	3.0		01.01 -	2JZ-GE	6	1,1	IFR5A-11N				
Crown (JZS155)	3.0		01.00 -	2JZ-GE	6	1,1	BKR5EKP-B-11	4302			
Crown	3.0		93 - 12.99	2JZ-GE	6	0,8	BKR6EYA	2249			
Crown	3.0	140		6M-GE	6	0,8	BPR6EY	6427		BPR6EIX	6637
Crown	3.0	140		7M-GE	6	0,9	BCPR6EY	1146		BCPR6EIX	5689
Dyna (KDY220,230,250,260)	2.5		08.01 -	2KD-FTV	4	█	Y-531J	2979		D-POWER 44	5467
Dyna 2500				2L		█	Y-168R	2162			
Dyna 2500				2L		█	Y-118R	2187			
Dyna 2500			93 -	2L		█	Y-715R	5376			
Dyna 2800	2.8		93 -	3L	4	█	Y-715R	5376			
Dyna 3000			04.82 -	3B	4	█	Y-197T	2190			
Dyna 3000			08.80 -	2B		█	Y-197T	2190			
Dyna 3000	3.0		93 -	B / 11B	4	█	Y-197T	2190			
Dyna 3000	3.0		93 -	B / 11B	4	█	Y-147T	7493			
Dyna 3000	3.0		04.82 -	B	4	█	Y-147T	7493			
Dyna 3000	3.0		05.82 - 89	B	4	█	Y-197R	2188			
Dyna 3000	3.0		90 - 91	B	4	█	Y-178T	3030			
Dyna 3700			04.82 -	H, 2H	6	█	Y-197R	2188			
Dyna 3700			93 -	14B		█	Y-147T	7493			
Dyna 3700			93 -	14B		█	Y-197T	2190			
Dyna All E/G				A11	4	0,8	BPR5EY	2828	9	BPR5EIX	6597
Echo (SCP10,NCP10,11,12,13)	1.0		01.99 -	1SZ-FE	4	0,8	BKR5EYA	2087			
Echo (NCP10,11,12,13, SCP10)	1.3		01.01 -	2NZ-FE	4	1,1	BKR5EYA-11	2526			
Echo Verso (NCP20,21 ,22)	1.3	63	08.99 -	2NZ-FE	4	1,1	BKR5EYA-11	2526			
Echo (NCP10,11,12,13, SCP10)	1.5	78	01.01 - 12.01	1NZ-FE	4	1,1	BKR5EYA-11	2526			
Echo (NCP10,11,12,13, SCP10)	1.5	78	01.02 -	1NZ-FE	4	0,8	BKR5EYA	2087			
Echo (NCP20, 21, 22)	1.5	78	01.02 -	1NZ-FE	4	0,8	BKR5EYA	2087			
Hiace 3700			93 -	14B 24V		█	Y-197T	2190			
Hiace 3700			93 -	14B 12V		█	Y-147T	7493			
Hiace	1.8		95 -	2Y o.Cat.	4	0,8	BPR5EY	2828	9	BPR5EIX	6597
Hiace (RZH102-105,112-115,125, 135,153,155)	2.0		98 -	1RZ	4	0,8	BP5EY	7327		BPR5EIX	6597
Hiace (YH51,53,56,60,61,63,66,73)	2.0	65	85 - 89	3Y	4	0,8	BPR5EY	2828	9	BPR5EIX	6597

<sup>1)</sup> Bic = Best in class



l kW

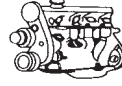

Cyl.

Order-  
No. No.Bic<sup>1)</sup> Order-  
D-Power No.**TOYOTA**

Hiace (RZH102,103,104,109, 112-115,119,125)	2.0	74	90 - 98	1R-Z	4	0,8	BPR5EY	2828	9	BPR5EIX	6597
Hiace	2.2		07.79 -	L	4	█	Y-118T1	2951			
Hiace Super Glow System	2.2		07.79 -	L	4	█	Y-118R	2187			
Hiace (YH51,53,56,60,61,63,66,73)	2.2	69	- 89	4Y, 4YZ	4	0,8	BPR5EY	2828	9	BPR5EIX	6597
Hiace (RCH12,13,19,22,23,29)	2.4		01.00 -	2RZ-E	4	1,1	BPR5EP-11	3971			
Hiace (RZH102-105,112-115,125, 135,153,155)	2.4		98 -	2RZ-E	4	1,1	BPR5EP-11	3971			
Hiace (RZH102-105,112-115,125, 135,153, 155)	2.4		98 -	2RZ	4	0,8	BP5EY	7327		BPR5EIX	6597
Hiace 2500 (LH102-104, 112-115,125)	2.4		93 -	2L	4	█	Y-715R	5376			
Hiace Super Glow System	2.4		09.83 - 92	2L	4	█	Y-118R	2187			
Hiace Super Glow System	2.4		09.83 - 92	2L	4	█	Y-118R	2187			
Hiace	2.4		- 92	2L 24V	4	█	Y-168R	2162			
Hiace	2.4		- 92	2L 12V	4	█	Y-118R	2187			
Hiace (RZH102,103,104,109, 112-115,119,125)	2.4		90 -	2R-Z	4	0,8	BP5EY	7327		BPR5EIX	6597
Hiace	2.4		09.83 - 92	2L	4	█	Y-118T1	2951			
Hiace (RZH102,103,104,109, 112-115,119,125)	2.4	88	90 -	2R-ZE	4	1,1	BPR5EP-11	3971			
Hiace (KLH 12, 22 28)	2.5		08.01 -	2KD-FTV	4	█	Y-531J	2979		D-POWER 44	5467
Hiace (LH102-104,112-115,125)	2.5		98 -	2L	4	█	Y-715R	5376			
Hiace (RCH 13,19,23,29)	2.7		01.04 -	3RZ-FE	4	1,1	IFR5A-11				
Hiace (RCH12,13,19,22,23,29)	2.7	105	01.00 - 03	3RZ-FE	6	0,8	IFR5T-8N	3508			
Hiace (LH102-104,112-115,125)	2.8		98 -	3L	4	█	Y-715R	5376			
Hiace 2800	2.8		93 -	3L	4	█	Y-715R	5376			
Hiace 3000	3.0		93 -	B / 11B 24V	4	█	Y-197T	2190			
Hiace 3000	3.0		93 -	B / 11B 12V	4	█	Y-147T	7493			
Hilux Super Glow System			09.83 - 92	2L	4	█	Y-118R	2187			
Hilux			09.83 - 92	2L	4	█	Y-118T1	2951			
Hilux 2500			- 90	2C	4	█	Y-703R	3782			
Hilux	1.6		90 - 90	1Y,1Y-C	4	0,8	BPR5EY	2828	9	BPR5EIX	6597
Hilux	1.8			2Y-C	4	0,8	BPR5EY	2828	9	BPR5EIX	6597
Hilux	1.8		95 -	2Y	4	0,8	BP5EY	7327		BPR5EIX	6597
Hilux	1.8	61	88 - 94	2Y	4	0,8	BPR5EY	2828	9	BPR5EIX	6597
Hilux (VZN 167, 172)	2.0		01.01 -	1RZ	4	0,8	BP5EY	7327		BPR5EIX	6597
Hilux	2.0		95 -	3Y	4	0,8	BP5EY	7327		BPR5EIX	6597
Hilux (RZN142,144,147-149,154, 168,169,173,174,193)	2.0		01.01 -	1RZ	4	0,8	BP5EY	7327		BPR5EIX	6597
Hilux	2.0		88 - 94	3Y,3Y-C	4	0,8	BPR5EY	2828	9	BPR5EIX	6597
Hilux (RZN142,144,147-149,154, 168,169,173,174,193)	2.0		01.01 -	1RZ-E	4	0,8	BPR5EY	2828	9	BPR5EIX	6597
Hilux (TGN10,11,15,16,26,36)	2.0	100	07.05 -	1TR-FE	4	1,1	LFRC6-11	5788			
Hilux Super Glow System	2.2		07.79 -	L	4	█	Y-118R	2187			
Hilux	2.2		07.79 -	L	4	█	Y-118T1	2951			
Hilux	2.2		90 - 90	4Y-E	4	1,1	BPR5EP-11	3971			
Hilux	2.2		88 - 94	4Y,4Y-C	4	0,8	BPR5EY	2828	9	BPR5EIX	6597
Hilux	2.2		95 -	4Y	4	0,8	BP5EY	7327		BPR5EIX	6597
Hilux	2.2		- 89	4Y-E	4	1,1	BPR5EY-11	3028		BPR5EIX-11	2115
Hilux	2.4		- 92	2L 24V	4	█	Y-168R	2162			
Hilux (VZN 167, 172)	2.4		01.01 -	2RZ-FE	6	0,8	BKR5EYA	2087			

<sup>1)</sup> Bic = Best in class

Fgst = Chassis No.



ℓ kW

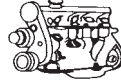

Cyl.

Order-  
No. No.Bic<sup>1)</sup> Order-  
D-Power No.**TOYOTA**

Hilux Super Glow System	2.4		09.83 - 92	2L	4	█	Y-118R	2187			
Hilux	2.4		- 92	2L 12V	4	█	Y-118R	2187			
Hilux (RZN142,144,147-149,154,168,169,173,174,193)	2.4		01.01 -	2RZ-FE	6	0,8	BKR5EYA	2087			
Hilux	2.4		88 -	22R	4	0,8	BPR5EY	2828	9	BPR5EIX	6597
Hilux 2500	2.4		93 -	2L	4	█	Y-715R	5376			
Hilux	2.4	84	88 -	22R-E Cat.	4	0,8	BPR5EY	2828	9	BPR5EIX	6597
Hilux (KDN145,150,165,170,190)	2.5		08.01 -	2KD-FTV	4	█	Y-531J	2979		D-POWER 44	5467
Hilux (RZN142,144,147-149,154,168,169,173,174,193)	2.7		01.01 -	3RZ-F	6	0,8	BKR5EYA	2087			
Hilux	2.7		96 -	3RZ-FE	6	0,8	BKR5EYA	2087			
Hilux (RZN142,144,147-149,154,168,169,173,174,193)	2.7		01.01 -	3RZ-FE	6	0,8	BKR5EYA	2087			
Hilux (TNG10,11,15,16,26,36)	2.7	118	07.05 -	2TR-FE	4	1,1	LFR6C-11	5788			
Hilux 2800	2.8		93 -	3L	4	█	Y-715R	5376			
Hilux	3.0	105	89 -	3VZ-E	6	0,8	BKR5EYA	2087			
Hilux	3.4		96 -	5VZ-FE	6	1,1	BKR5EKB-11	3967			
Hilux (GRN215W)	4.0		08.05 -	1GR-FE	6	1,1	LFR6C-11	5788			
Hilux (GGN15,25)	4.0	175	07.05 -	1GR-FE	6	1,1	LFR6C-11	5788			
Land Cruiser				3B 4 Zyl., 2H 6Zyl.	6	█	Y-147T	7493			
Land Cruiser			05.82 -	H / 2H	6	█	Y-197R	2188			
Land Cruiser			10.81 -	2B		█	Y-197R	2188			
Land Cruiser	2.4			2L 2.4L	4	█	Y-118R	2187			
Land Cruiser (FJ62,70,73,75,RJ70)	2.4	77		22R	4	0,8	BPR5EY	2828	9	BPR5EIX	6597
Land Cruiser	2.4	77	- 12.96	22R-E	4	0,8	BPR5EY	2828	9	BPR5EIX	6597
Land Cruiser	2.5		90 -	2L 2.5L	4	█	Y-715R	5376			
Land Cruiser (HZJ70,73,75)	2.5			2L-T	4	█	Y-715R	5376			
Land Cruiser	2.5		93 -	2L-T	4	█	Y-715R	5376			
Land Cruiser (RZJ120,125)	2.7		01.03 -	3RZ-FE with 3way cat.	4	1,1	BKR5EYA-11	2526			
Land Cruiser (RZJ120,125)	2.7		01.03 -	3RZ-FE without 3way cat.	4	0,8	BKR5EYA	2087			
Land Cruiser (RZJ90,95, VZJ90,95)	2.7		05.96 -	3RZ-F	6	0,8	BKR5EYA	2087			
Land Cruiser (RZJ90,95, VZJ90,95)	2.7		05.96 -	3RZ-FE	6	0,8	BKR5EYA	2087			
Land Cruiser (TRJ120,125)	2.7		01.05 -	2TR-FE	6	1,1	ILFR6C11				
Land Cruiser (KZJ90,95)	2.8		98 -	3L	4	█	Y-715R	5376			
Land Cruiser	2.8		93 -	3L	4	█	Y-715R	5376			
Land Cruiser (LJ90,95)	2.8		98 -	3L	4	█	Y-715R	5376			
Land Cruiser (KZJ120)	3.0		09.02 -	1KD-FTV		█	Y-531J	2979		D-POWER 44	5467
Land Cruiser (LJ120,125)	3.0		09.02 -	1KD-FTV		█	Y-531J	2979		D-POWER 44	5467
Land Cruiser (KDJ 120,125)	3.0		09.02 -	1KD-FTV		█	Y-531J	2979		D-POWER 44	5467
Land Cruiser D4D	3.0	120	02 -	1KD-FTV	4	█	Y-531J	2979		D-POWER 44	5467
Land Cruiser (RZJ90,95, VZJ90,95)	3.4	131	05.96 -	5VZ-FE	6	1,1	BKR5EKB-11	3967			
Land Cruiser (20W/121W)	4.0		08.05 -	1GR-FE	6	1,1	LFR6C-11	5788			
Land Cruiser (FJ62,70,73,75,RJ70)	4.0		08.87 - 12.89	3F-E	6	0,8	BPR5EY	2828	9	BPR5EIX	6597
Land Cruiser (TRJ120, 125)	4.0		01.05 -	1GR-FE	6	1,1	LFR6C-11	5788			
Land Cruiser (FJ62,70,73,75,RJ70)	4.0	107	88 -	3F	6	0,8	BPR4EY	2128			
Land Cruiser (FJ62,70,73,75,RJ70)	4.0	115	01.90 - 08.92	3F-E Cat.	6	1,1	BPR5EY-11	3028		BPR5EIX-11	2115
Land Cruiser (RZJ120,125)	4.0	183	02 -	1GR-FE	6	1,1	LFR6C-11	5788			

<sup>1)</sup> Bic = Best in class



l kW

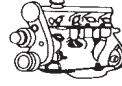

Cyl.

Order-  
No. No.Bic<sup>1)</sup> Order-  
D-Power No.**TOYOTA**

Land Cruiser (HDJ100)	4.2		98 -	1HD-T	6	█	Y-532J	7782				
Land Cruiser (HZJ105)	4.2		98 -	1HD-T	6	█	Y-532J	7782				
Land Cruiser	4.2	88	81 -	2F	6	0,8	BPR4EY	2128				
Land Cruiser (FZJ70,73,75)	4.5		98 - 12.99	1FZ-F	6	0,8	BKR5EYA	2087				
Land Cruiser (UZJ100)	4.5		01.02 -	1FZ-FE	6	1,1	BKR5EKB-11	3967				
Land Cruiser (FZJ100,105)	4.5		98 - 12.99	1FZ-FE	6	1,1	BKR5EKB-11	3967				
Land Cruiser (FZJ100,105)	4.5		01.02 -	1FZ-FE	6	1,1	BKR5EKB-11	3967				
Land Cruiser (UZJ100,FZJ100,105)	4.5		01.01 -	1FZ-FE	6	1,1	BKR5EKB-11	3967				
Land Cruiser (FZJ80)	4.5		96 -	1FZ-F	6	0,8	BKR5EYA	2087				
Land Cruiser (FZJ70,73,75)	4.5		98 - 12.99	1FZ-FE	6	0,8	BKR5EYA	2087				
Land Cruiser (UZJ100)	4.5		98 - 12.99	1FZ-FE	6	1,1	BKR5EKB-11	3967				
Land Cruiser (FZJ71,74,78,79)	4.5		01.00 -	1FZ-FE	6	1,1	BKR5EKB-11	3967				
Land Cruiser	4.5		93 -	1FZ-FE	6	0,8	BKR5EYA	2087				
Land Cruiser (UZJ100,FZJ100,105)	4.7		01.01 -	2UZ-FE with 3way cat.	8	1,1	IFR6T-11	4589				
Land Cruiser (FZJ100,105)	4.7	173	01.98 -	2UZ-FE	8	1,1	IFR6T-11	4589				
Land Cruiser (UZJ100)	4.7	173	01.98 -	2UZ-FE	8	1,1	IFR6T-11	4589				
Liteace	1.3	42		4K,4K-C	4	0,8	BPR5EA-L	5823				
Liteace (KR41,42)	1.5		98 -	5K	4	0,8	BPR5EY	2828	9	BPR5EIX	6597	
Liteace (SR40)	1.5		98 -	5K	4	0,8	BPR5EY	2828	9	BPR5EIX	6597	
Liteace (KM30,36,37, YM30,35))	1.5	52	86 - 90	5K,5K-C	4	0,8	BPR5EY	2828	9	BPR5EIX	6597	
Liteace (KM30,36,37, YM30,35)	1.8		90 -	2Y-C Cat.	4	1,1	BPR5EP-11	3971				
Liteace (KM30,36,37, YM30,35,40,41)	1.8		89 -	2Y-C	4	0,8	BP5EY	7327		BPR5EIX	6597	
Liteace (KR41,42)	1.8		98 -	7K	4	0,8	BPR5EY	2828	9	BPR5EIX	6597	
Liteace (KR42,SR40)	1.8		01.00 -	7K-E	4	1,1	BPR5EY-11	3028		BPR5EIX-11	2115	
Liteace 2000	1.8			1C	4	█	Y-146R	7492				
Liteace (SR40)	1.8		98 -	7K	4	0,8	BPR5EY	2828	9	BPR5EIX	6597	
Liteace (KM30,36,37, YM30,35,40,41)	1.8		- 89	2Y-CU Cat.	4	1,1	BPR5EP-11	3971				
Liteace (KM30,36,37, YM30,35)	1.8		90 -	2Y Cat.	4	0,8	BP5EY	7327		BPR5EIX	6597	
Liteace (KM30,36,37, YM30,35)	1.8		90 -	2Y-CU Cat.	4	0,8	BP5EY	7327		BPR5EIX	6597	
Liteace (KM30,36,37, YM30,35,40,41)	1.8		86 - 89	2Y Cat.	4	1,1	BPR5EP-11	3971				
Liteace (KM30,36,37, YM30,35,40,41)	1.8	57	86 - 88	2Y	4	0,8	BP5EY	7327		BPR5EIX	6597	
Liteace (KM30,36,37, YM30,35,40,41)	1.8	58	86 - 89	2Y-C Cat.	4	1,1	BPR5EP-11	3971				
Liteace (KR41,42)	2.0		98 -	3S-FE	4	1,1	BKR6EKB-11	3583				
Liteace 2000	2.0			2C	4	█	Y-703R	3782				
Liteace (SR40)	2.0		98 -	3S-FE	4	1,1	BKR6EKB-11	3583				
Liteace (KM30,36,37, YM30,35,40,41)	2.0		93 -	3Y	4	0,8	BP5EY	7327		BPR5EIX	6597	
Liteace (KM30,36,37, YM30,35,40,41)	2.0			3Y-CU	4	1,1	BPR5EP-11	3971				
Liteace	2.2		93 -	4Y-E	4	1,1	BPR5EP-11	3971				
Model F	2.0			3Y-EC	4	0,8	BPR5EY	2828	9	BPR5EIX	6597	
Model F (YR21,22,31)	2.0	65	08.84 - 90	3Y	4	0,8	BPR5EY	2828	9	BPR5EIX	6597	
Model F (YR21,22,31)	2.0	65	08.84 - 88	3Y-C Cat.	4	1,1	BPR5EP-11	3971				
Model F (YR21,22,31)	2.0	65		3Y-C	4	0,8	BPR5EY	2828	9	BPR5EIX	6597	
Model F	2.2		08.85 -	4Y-E Cat.	4	1,1	BPR5EP-11	3971				
Model F	2.2		90 -	4Y-E	4	0,8	BPR5EY	2828	9	BPR5EIX	6597	
Model F	2.2		08.85 -	4Y-EC	4	0,8	BPR5EY	2828	9	BPR5EIX	6597	
Model F (YR21,22,31)	2.2	73	08.85 -	4Y-EC Cat.	4	1,1	BPR5EP-11	3971				
Model F / Tarago	2.0			2C	4	█	Y-146R	7492				
MR 2	1.6			4A-GZE	4	1,1	BCPR6EP-11	3350		BCPR6EIX-11	4919	
MR 2 (AW11)	1.6	85	86 - 90	4A-GE Cat.	4	1,1	BCPR5EP-11	2097		BCPR5EIX-11	3306	
MR 2 (AW11)	1.6	91	86 - 88	4A-GE	4	1,1	BCPR6EY-11	3720		BCPR6EIX-11	4919	
MR 2 (ZZW30)	1.8	103	12.99 -	1ZZ-FE	4	1,1	BKR5EYA-11	2526				
MR 2 (SW20)	2.0		93 -	3S-GTE	4	0,8	BKR6EP-8	2215		BKR6EIX	6418	

<sup>1)</sup> Bic = Best in class





ℓ kW

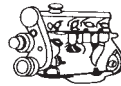

Cyl.

Order-  
No. No.Bic<sup>1)</sup> Order-  
D-Power No.**TOYOTA**

MR 2 (SW20)	2.0	115	90 - 93	3S-GE	Cat.	4	0,8	BKR6EP-8	2215		BKR6EIX	6418
MR 2 (SW20)	2.0	118	89 - 92	3S-GE		4	0,8	BKR6EYA	2249			
MR 2 (SW20)	2.0	129	94 -	3S-GE		4	0,8	BKR6EP-8	2215		BKR6EIX	6418
MR 2	2.2		93 -	5S-FE		4	1,1	BKR6EP-11	2978		BKR6EIX-11	3764
MR 2 (SW20)	2.2	89	90 -	3S-FE	Cat.	4	1,1	BKR6EYA-11	4073			
Paseo (EL54)	1.5		03.96 - 03.98	5E-FE (only Europe)		4	1,1	BKR5EP-11	3440		BKR5EIX-11	5464
Paseo (EL54)	1.5	66	07.95 - 12.97	5E-FE (only Europe)		4	0,8	BKR5EYA	2087			
Pick-up	2.2		08.82 -	L		4	█	Y-118T1	2951			
Pick-up Super Glow System	2.2		08.82 -	L		4	█	Y-118R	2187			
Picnic (SXM10)	2.0	94	09.96 - 09.01	3S-FE		4	1,1	BKR6EKP-11	3452			
Picnic (ACM20)	2.0	110	05.01 -	1AZ-FE		4	1,1	IFR6T-11	4589			
Previa 2.0 D	2.0	85	04.01 -	1CD-FTV		4	█	Y-531J	2979		D-POWER 44	5467
Previa (TCR10,11,20,21)	2.4		96 -	2TZ-FE	without Cat.	4	0,8	BKR5EYA	2087			
Previa (TCR10,11,20,21)	2.4	97	05.90 - 00	2TZ-FE	Cat.	4	1,1	BKR5EP-11	3440		BKR5EIX-11	5464
Previa (TCR10,11,20,21)	2.4	97	05.90 -	2TZ-FE	3 way Cat.	4	0,8	BKR5EYA	2087			
Previa (ACR30)	2.4	115	03.00 -	2AZ-FE		4	1,1	IFR6T-11	4589			
Prius (Hybrid)(NHW11)	1.5	53	05.00 - 03	1NZ-FXE		4	1,1	IFR5A-11				
Prius (Hybrid) (NHW20)	1.5	57	03 -	1NZ-FXE		4	1,1	IFR5A-11				
RAV 4 (ZCA25,26, ACA20,21,22,23)	1.8	92	05.00 -	1ZZ-FE		4	1,1	BKR5EYA-11	2526			
RAV 4 (ZCA25,26, ACA20,21,22,23)	2.0		05.00 -	1AZ-FE		4	1,1	IFR6T-11	4589			
RAV 4 (SXA10,11)	2.0		98 - 00	3S-FE		4	1,1	BKR6EKP-11	3452			
RAV 4 (ACA30, 33, 38)	2.0		11.05 - 01.07	1AZ-FE		4	1,1	IFR6T-11	4589			
RAV 4 (ACA 30,31, 33,38)	2.0		01.07 -	1AZ-FE		4	1,1	IFR6A-11				
RAV 4 2.0 D	2.0	85	10.01 -	1CD-FTV		4	█	Y-531J	2979		D-POWER 44	5467
RAV 4 (SXA10)	2.0	95	94 - 97	3S-FE		4	1,1	BKR6EYA-11	4073			
RAV 4 (ZCA25,26, ACA20,21,22,23)	2.4		01.04 -	2AZ-FE		4	1,1	IFR6T-11	4589			
RAV 4 (ACA31W/36W)	2.4		11.05 -	2AZ-FE		4	1,1	IFR6T-11	4589			
RAV 4 (ACA30, 33, 38)	2.4		11.05 - 01.07	2AZ-FE		4	1,1	IFR6T-11	4589			
RAV 4 (ACA 30,31,33,38)	2.4		01.07 -	2AZ-FE		4	1,1	IFR6A-11				
Spacecruiser	1.8			2Y		4	0,8	BPR5EY	2828	9	BPR5EIX	6597
Spacecruiser	2.0			3Y		4	0,8	BPR5EY	2828	9	BPR5EIX	6597
Starlet (EP70,EP71,EP76,EP80,EP81)	1.0	40	85 - 92	1E		4	0,8	BPR6EY	6427		BPR6EIX	6637
Starlet	1.3		95 -	2E-E		4	0,8	BPR4EY	2128			
Starlet (EP90,91)	1.3		98 -	2E		4	0,8	BPR6EY	6427		BPR6EIX	6637
Starlet (EP90,91)	1.3		98 -	4E-FE		4	0,8	BKR5EYA	2087			
Starlet (EP80,81)	1.3	53	93 -	2E		4	0,8	BPR6EY	6427		BPR6EIX	6637
Starlet (EP80,81)	1.3	53	88 - 92	2E		4	1,1	BPR5EY-11	3028		BPR5EIX-11	2115
Starlet (EP70,71,76)	1.3	55	88 -	2E-C		4	1,1	BPR6EY-11	4228	10	BPR6EIX-11	3903
Starlet	1.3	55	93 -	4A-FE		4	1,1	BKR5EYA-11	2526			
Starlet (EP80,81)	1.3	55	02.96 -	4E-FE		4	0,8	BKR5EYA	2087			
Starlet (EP80,81)	1.3	55	90 - 12.95	2E-E	Cat.	4	0,8	BPR5EY	2828	9	BPR5EIX	6597
Starlet	1.5		93 -	1N		4	█	Y-715R	5376			
Starlet	1.5		90 - 92	1N		4	█	Y-715R	5376			
Starlet (P7)	1.5	40	12.86 - 11.89	1N		4	█	Y-118R	2187			
Supra	2.8			5M-GE		6	0,8	BPR6EY	6427		BPR6EIX	6637
Supra (JZA80)	3.0		96 -	2JZ-GE		6	0,8	BKR6EYA	2249			
Supra (MA70)	3.0		90 - 92	7M-GE		6	0,9	BCPR6EY	1146		BCPR6EIX	5689
Supra (JZA80)	3.0		95 - 95	2JZ-GE		6	1,1	BKR6EP-11	2978		BKR6EIX-11	3764
Supra (JZA80)	3.0		95 -	2JZ-GTE		6	1,1	BKR6EP-11	2978		BKR6EIX-11	3764
Supra (MA70)	3.0	150	86 - 88	7M-GE		6	0,9	BCPR6EY	1146		BCPR6EIX	5689
Supra (MA70)	3.0	150	87 - 89	7M-GE	Cat.	6	1,1	BCPR5EP-11	2097		BCPR5EIX-11	3306
Supra (JZA80)	3.0	165	93 - 94	2JZ-GE		6	1,1	BKR5EP-11	3440		BKR5EIX-11	5464

<sup>1)</sup> Bic = Best in class

Fgst = Chassis No.



l kW

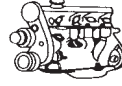

Cyl.

Order-  
No. No.Bic<sup>1)</sup> Order-  
D-Power No.**TOYOTA**

Supra Turbo (MA70)	3.0	175	87 - 92	7M-GTE	6	0,8	BCPR6EPN-8	5275			
Supra V6 Biturbo (JZA80)	3.0	243	93 - 94	2JZ-GTE	6	1,1	BKR6EP-11	2978		BKR6EIX-11	3764
Tarago	2.0			2C	4	█	Y-146R	7492			
Targo (ACR30)	2.4		03.00 -	2AZ-FE	4	1,1	IFR6T-11	4589			
Tarago	2.4	97	90 -	2TZ-FE	4	1,1	BKR5EP-11	3440		BKR5EIX-11	5464
Tercel (EL50,53)	1.3		98 -	2E	4	0,8	BPR6EY	6427		BPR6EIX	6637
Tercel	1.3			2E	4	0,8	BPR6EY	6427		BPR6EIX	6637
Tercel (EL50,53)	1.5		98 -	5E-FE	4	1,1	BKR5EKB-11	3967			
Tercel	1.5		93 -	3E-E	4	1,1	BPR5EY-11	3028		BPR5EIX-11	2115
Tercel	1.5	50	86 - 88	3A-C	4	0,8	BPR5EY	2828	9	BPR5EIX	6597
Tercel (AL25)	1.5	50	88 -	3A-C Cat.	4	1,1	BPR5EY-11	3028		BPR5EIX-11	2115
Tercel	1.5	52	81 - 91	3A	4	0,8	BPR5EA-L	5823			
Townace (KR41,42)	1.5		98 -	5K	4	0,8	BPR5EY	2828	9	BPR5EIX	6597
Townace (SR40)	1.5		98 -	5K	4	0,8	BPR5EY	2828	9	BPR5EIX	6597
Townace (SR40)	1.8		98 -	7K	4	0,8	BPR5EY	2828	9	BPR5EIX	6597
Townace (KR42,SR40)	1.8		01.00 -	7K-E	4	1,1	BPR5EY-11	3028		BPR5EIX-11	2115
Townace (KR41,42)	1.8		98 -	7K	4	0,8	BPR5EY	2828	9	BPR5EIX	6597
Townace (KR41,42)	2.0		98 -	3S-FE	4	1,1	BKR6EKB-11	3583			
Townace (SR40)	2.0		98 -	3S-FE	4	1,1	BKR6EKB-11	3583			
Toyo-Ace			01.82 -	2L		█	Y-197R	2188			
Toyo-Ace Super Glow System			09.83 -	2L		█	Y-118R	2187			
Toyo-Ace			09.83 -	2L		█	Y-118R	2187			
Toyo-Ace			09.83 -	2L		█	Y-168R	2162			
Toyo-Ace Super Glow System	2.2		03.79 -	L	4	█	Y-118R	2187			
Toyo-Ace Super Glow System	2.2		03.79 -	L	4	█	Y-118R	2187			
Toyo-Ace	2.2		03.79 -	L	4	█	Y-118T1	2951			
Toyo-Ace	3.0		01.82 -	B	4	█	Y-197R	2188			
Yaris 1.0 (SCP90, NCP90; 91 ZSP90)	1.0		11.05 -	1KR-FE	3	1,1	LFR6C-11	5788			
Yaris 1.0 16V (SCP10)	1.0	48	01.99 -	1SZ-FE	4	0,8	BKR5EYA	2087			
(NCP10,11,12,13)											
Yaris 1.0 (KSP90) VVTI	1.0	51	08.05 -	1KR-FE	3	1,1	LFR6C-11	5788			
Yaris 1.0 (NCP90,91) VVTI	1.0	51	08.05 -	1KR-FE	3	1,1	LFR6C-11	5788			
Yaris 1.3 (NCP 92, 93)	1.3		01.06 -	2NZ-FE	4	1,1	BKR5EYA-11	2526			
Yaris 1.3 (KSP90)(SCP90)	1.3		11.05 -	2SZ-FE	4	0,8	BKR5EYA	2087			
Yaris 1.3 16V (NCP10,11,12,13)	1.3	63	01.01 -	2NZ-FE	4	1,1	BKR5EYA-11	2526			
(SCP10)											
Yaris 1.3 (NCP10,11,12,13)	1.3	64	04.02 -	2SZ-FE	4	0,8	BKR5EYA	2087			
(SCP10,12)											
Yaris 1.3 (NCP90,91) VVTI	1.3	64	08.05 - 11.06	2NZ-FE	4	1,1	BKR5EYA-11	2526			
Yaris 1.3 (KSP90 )(ZSP90) VVTI	1.3	64	08.05 - 11.06	2NZ-FE	4	1,1	BKR5EYA-11	2526			
Yaris 1.4 (NLP90)	1.4	55	11.05 -	1ND-TV	4	█	Y-542J	5665		D-POWER 45	5513
Yaris 1.4 D-4D (NLP10)	1.4	55	12.01 -	1ND-TV	4	█	Y-542J	5665		D-POWER 45	5513
Yaris 1.5 (NCP92, 93)	1.5		01.06 -	1NZ-FE	4	0,8	BKR5EYA	2087			
Yaris 1.5 (NCP90,91)	1.5	78	02.06 - 11.06	1NZ-FE	4	0,8	BKR5EYA	2087			
Yaris 1.5 (KSP90)(ZSP90)	1.5	78	08.05 - 11.06	1NZ-FE	4	0,8	BKR5EYA	2087			
Yaris 1.5 (NCP20, 21, 22)	1.5	78	01.02 -	1NZ-FE	4	0,8	BKR5EYA	2087			
Yaris 1.5TS (NCP10,11,12,13)	1.5	78	01.02 -	1NZ-FE	4	0,8	BKR5EYA	2087			
(SCP10)											
Yaris 1.5 (NCP10,11,12,13)	1.5	78	01.01 - 12.01	1NZ-FE	4	1,1	BKR5EYA-11	2526			
(SCP10)											
Yaris Verso (NCP20,21,22 )	1.3	63	08.99 -	2NZ-FE	4	1,1	BKR5EYA-11	2526			
Yaris Verso (NCP20,21,22 )	1.5	78	01 - 12.00	1NZ-FE	4	1,1	BKR5EYA-11	2526			

<sup>1)</sup> Bic = Best in class



ℓ kW

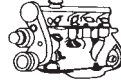

Cyl.

Order-  
No. No.Bic<sup>1)</sup> Order-  
D-Power No.**TRABANT**

601	1,1	29	05.90 - 12.91	VW-Motor	4	0,7	BP6ES	7811	4	BPR6EIX	6637
-----	-----	----	---------------	----------	---	-----	-------	------	---	---------	------

**TVR**

280 i	2.8				6	0,8	BPR6ES	7822	2	BPR6EIX	6637
280 s	2.8				6	0,8	BPR6ES	7822	2	BPR6EIX	6637
290 i	2.9				6	0,8	BPR6ES	7822	2	BPR6EIX	6637
350 i	3.5				8	0,8	BPR6ES	7822	2	BPR6EIX	6637
400	4.0				8	0,8	B7ECS	2528			
450	4.5				8	0,8	B7ECS	2528			
Cerbera	4.0		09.98 -	IL6 4.0L	6	0,9	DCPR8E	4339		DCPR8EIX	6546
Cerbera	4.2	306	95 -	AJP (TVR engine)	8	0,7	BKR5EKU	3964			
Chimaera	4.0			V8 Rover	8	0,8	B7ECS	2528			
Chimaera	4.3			V8 Rover	8	0,8	B7ECS	2528			
Chimaera	5.0			V8 Rover	8	0,8	B7ECS	2528			
Griffith	3.9				8	0,8	B7ECS	2528			
Griffith	4.3				8	0,8	B7ECS	2528			
Griffith	4.5				8	0,8	B7ECS	2528			
Griffith 500	5.0		95 -	V8 Rover	8	0,8	B7ECS	2528			
S2					6	0,8	BCPR6ES	2330	12	BCPR6EIX	5689
S3				With Cat.	6	1,0	BPR6EFS	3623	7		
S3				non Cat.	6	0,8	BCPR6ES	2330	12	BCPR6EIX	5689
S3C	2.9				6	1,0	BPR6EFS	3623	7		
Speed	3.9			39	8	0,8	B7ECS	2528			
Speed	4.3			43	8	0,8	B7ECS	2528			
Tamora	3.6			IL6	6	0,9	DCPR8E	4339		DCPR8EIX	6546
Tasmin	2.0				4	0,6	APR6FS	2922			
Tasmin	2.8				6	0,8	BCPR6ES	2330	12	BCPR6EIX	5689
Tuscan	3.5				8	0,9	BPR5ES	7422	6	BPR5EIX	6597
Tuscan Speed Six	4.0		09.98 -		6	0,9	DCPR8E	4339		DCPR8EIX	6546

**UAZ**

31512, 31514, 31516, 31519					4	0,6	B5HS	4210			
31512, 31514	2.3	73		3M3-402	4	0,6	BP6HS	4511	18	BPR6HIX	4085
3159 Bars					4	0,9	BPR5ES	7422	6	BPR5EIX	6597
3303, 3714, 3153, 3741, 3909, 3962, 3221					4	0,6	B5HS	4210			
425 PP Promiscuo D			08.81 -	Peugeot	4	█	Y-902R	2237		D-POWER 1	7906

**VAZ-GM**

Chevrolet Niva 1.7i	1.7	60	01.02 -	VAZ-2121	4	1,1	BPR6ES-11	4824	13	BPR6EIX-11	3903
---------------------	-----	----	---------	----------	---	-----	-----------	------	----	------------	------

**VOLGA**

siehe GAZ		0									
-----------	--	---	--	--	--	--	--	--	--	--	--

**VOLVO**

240	1.8	66	11.78 - 07.88	B17A	4	0,7	BP6ES	7811	4	BPR6EIX	6637
240	2.0	72	08.84 - 07.89	B200K	4	0,7	BP6ES	7811	4	BPR6EIX	6637
240i	2.0	77	08.88 - 08.92		4	0,8	BPR6ES	7822	2	BPR6EIX	6637
240i	2.0	86	08.87 - 07.92	B200E	4	0,8	BPR6ES	7822	2	BPR6EIX	6637
240i	2.3		08.92 -	B230FD	4	0,8	BPR6ES	7822	2	BPR6EIX	6637
240 / 240i	2.3	78	03.79 - 07.88	B23A/B23E/B230A	4	0,7	BP6ES	7811	4	BPR6EIX	6637
240	2.3	78	08.86 - 07.90	B230K	4	0,8	BPR6ES	7822	2	BPR6EIX	6637

<sup>1)</sup> Bic = Best in class



ℓ kW

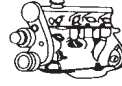

Cyl.

Order-  
No. No.Bic<sup>1)</sup> Order-  
D-Power No.**VOLVO**

240i	2.3	85	08.84 - 08.93	B230F Cat.	4	0,8	BPR6ES	7822	2	BPR6EIX	6637
240i	2.3	96	08.87 - 07.92	B230E	4	0,8	BPR6ES	7822	2	BPR6EIX	6637
240 D	2.4	60	08.79 - 08.93	D 24	4	■	Y-918R	4182		D-POWER 2	6285
340	1.4	47	08.84 -	B14	4	0,8	BPR6ES	7822	2	BPR6EIX	6637
340 D	1.6	40	09.84 - 07.91	D 16	4	■	Y-913M	3965		D-POWER 15	5317
340	1.7	61	07.85 - 07.91	B172K	4	0,8	BPR6ES	7822	2	BPR6EIX	6637
340 / 340i	2.0	82	08.82 - 07.88	B200E/B200K	4	0,8	BPR6ES	7822	2	BPR6EIX	6637
360 D	1.6		07.84 -	D 16	4	■	Y-913M	3965		D-POWER 15	5317
360 / 360i	2.0	72	08.82 - 07.89	B19E/B200E	4	0,8	BPR6ES	7822	2	BPR6EIX	6637
360 / 360i	2.0	72	08.82 - 07.90	B200K/B200F Cat.	4	0,8	BPR6ES	7822	2	BPR6EIX	6637
440i	1.6	62	02.92 - 12.95	B16F Cat.	4	0,7	ZGR5B	7345			
440	1.7	58	09.88 - 12.96	B18K/B Cat.	4	0,8	BPR6ES	7822	2	BPR6EIX	6637
440	1.7	58	09.89 - 12.91	B18KD Cat.	4	0,7	ZGR5B	7345			
440	1.7	64	09.88 - 02.92	B18KPD Cat.	4	0,7	ZGR5B	7345			
440i	1.7	70	09.88 - 03.92	B18F Cat.	4	0,7	ZGR5B	7345			
440i	1.7	75	09.89 - 12.96	B18FP Cat.	4	0,7	ZGR5B	7345			
440i	1.7	78	09.88 - 12.89	B18ED Cat.	4	0,8	BPR7ES	2023	19	BPR7EIX	4055
440i	1.7	88	09.88 - 07.96	B18FTM/FT Cat.	4	0,8	BPR7ES	2023	19	BPR7EIX	4055
440i	1.8	66	09.91 - 07.96	B18U Cat.	4	0,7	ZGR5B	7345			
440i	1.8	69	09.91 - 12.95	B18 u. Cat.	4	0,8	BPR6ES	7822	2	BPR6EIX	6637
440 TD	1.9	66	01.93 - 12.96	Renault F8Q Turbo	4	■	Y-933R	6136		D-POWER 25	7947
440i	2.0	81	09.92 -	B20U Cat.	4	0,8	BPR7ES	2023	19	BPR7EIX	4055
440i	2.0	81	08.92 - 07.95	B20F Cat.	4	0,8	BPR7ES	2023	19	BPR7EIX	4055
460	1.7	64	01.90 - 09.91	B18KPD Cat.	4	0,7	ZGR5B	7345			
460 / 460i	1.7	66	03.90 - 12.95	B18KP/EP/ Cat	4	0,8	BPR6ES	7822	2	BPR6EIX	6637
460i	1.7	75	01.90 - 09.92	B18FP Cat.	4	0,7	ZGR5B	7345			
460i	1.7	88	01.90 - 12.95	B18FT Cat.	4	0,8	BPR7ES	2023	19	BPR7EIX	4055
460i	1.8	66	09.91 - 12.95	B18U Cat.	4	0,7	ZGR5B	7345			
460i	1.8	69	09.91 - 12.95	B18 u. Cat.	4	0,8	BPR6ES	7822	2	BPR6EIX	6637
460 TD	1.9	66	06.94 - 08.97	D 19 T	4	■	Y-933R	6136		D-POWER 25	7947
460i	2.0	81	09.92 - 12.95	B20F Cat.	4	0,8	BPR7ES	2023	19	BPR7EIX	4055
480i	1.7	70	09.87 - 03.90	B18F Cat.	4	0,7	ZGR5B	7345			
480i	1.7	75	10.89 - 09.92	B18FP Cat.	4	0,7	ZGR5B	7345			
480	1.7	78	04.86 - 07.89	B18E	4	0,8	BPR7ES	2023	19	BPR7EIX	4055
480i	1.7	78	10.87 - 08.88	B18ED Cat.	4	0,8	BPR7ES	2023	19	BPR7EIX	4055
480i	1.7	88	03.88 - 07.96	B18FT Cat.	4	0,8	BPR7ES	2023	19	BPR7EIX	4055
480i	2.0	81	09.92 - 12.95	B20F Cat.	4	0,8	BPR7ES	2023	19	BPR7EIX	4055
740	2.0	76	08.84 - 07.89	B200K	4	0,8	BPR6ES	7822	2	BPR6EIX	6637
740i	2.0	76	08.83 - 07.91	B19E/B200E	4	0,8	BPR6ES	7822	2	BPR6EIX	6637
740i	2.0	82	08.89 - 07.91	B200F Cat.	4	0,8	BPR6ES	7822	2	BPR6EIX	6637
740i Turbo	2.0	105	08.86 - 07.92	B200ET/FT Cat.	4	0,8	BPR6ES	7822	2	BPR6EIX	6637
740i	2.3	80	08.86 - 07.90	B230K	4	0,8	BPR6ES	7822	2	BPR6EIX	6637
740i	2.3	85	08.87 - 07.95	B230F Cat.	4	0,8	BPR6ES	7822	2	BPR6EIX	6637
740i	2.3	96	08.84 - 07.92	B230E/B230F Cat.	4	0,8	BPR6ES	7822	2	BPR6EIX	6637
740i 16V	2.3	111	04.88 - 08.92	B234F Cat.	4	0,8	BPR6ES	7822	2	BPR6EIX	6637
740i Turbo	2.3	114	08.86 - 07.91	B230FT Cat.	4	0,8	BPR6ES	7822	2	BPR6EIX	6637
740i Turbo	2.3	130	08.86 - 07.89	B230ET	4	0,8	BPR6ES	7822	2	BPR6EIX	6637
740 D	2.4	60	04.84 - 07.92	D 24	6	■	Y-918R	4182		D-POWER 2	6285
740 TD	2.4	80	04.87 - 07.92	D 24 T	6	■	Y-918R	4182		D-POWER 2	6285
740 TD (air condition)	2.4	85	08.87 - 07.92	D 24 TIC	6	■	Y-918R	4182		D-POWER 2	6285
740i 16V (I)	2.0	76	08.88 - 07.91	B204E	4	0,8	BPR6ES	7822	2	BPR6EIX	6637
760i Turbo	2.0	120	08.87 - 07.89	B200ET	4	0,8	BPR6ES	7822	2	BPR6EIX	6637

<sup>1)</sup> Bic = Best in class



ℓ kW

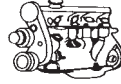

Cyl.

Order-  
No. No.Bic<sup>1)</sup> Order-  
D-Power No.**VOLVO**

760i Turbo	2.3	114	08.84 - 07.92	B230ET/FT Cat.	4	0,8	BPR6ES	7822	2	BPR6EIX	6637
760 TD	2.4	85	08.87 - 07.92	D 24 TIC	6	■	Y-918R	4182		D-POWER 2	6285
760i	2.8	100	08.82 - 08.91	B28F/B280F Cat.	6	1,0	BPR6EFS	3623	7		
760i / 780i	2.8	108	05.86 - 07.91	B280E	6	0,6	BP7EFS	3526			
780i Turbo / 16V /Interco.	2.0	120	08.87 - 07.90	B200ET/B204GT	4	0,8	BPR6ES	7822	2	BPR6EIX	6637
780 TD	2.4	85	08.85 -	D 24 TIC	6	■	Y-918R	4182		D-POWER 2	6285
780i	2.8	108	05.86 - 07.91	B280F Cat.	6	1,0	BPR6EFS	3623	7		
850	2.0	93	08.94 - 12.96	B5202S	5	0,8	BCPR6ES	2330	12	BCPR6EIX	5689
850i	2.0	96	09.91 - 12.96	B5204F	5	0,8	BCPR6ES	2330	12	BCPR6EIX	5689
850 T	2.0	154	02.93 - 12.96	B5204T	5	0,8	BCPR6ES	2330	12	BCPR6EIX	5689
850i T5	2.3	166	04.94 - 12.96	B5234FT	5	0,6	BCP7EVX	7681		BCPR7EIX	5690
850 T5 R	2.3	177	94 -	B5234T5	5	0,8	BKR7EVX	3544		BKR7EIX	2667
850 R	2.3	184	08.95 - 12.96	B5234T	5	0,8	BKR7EVX	3544		BKR7EIX	2667
850 TDi	2.5	103		D5252 (Audi)	5	■	Y-732U	2408		D-POWER 4	6001
850i	2.5	103	10.92 - 07.94	B5252S	5	0,8	BCPR6ES	2330	12	BCPR6EIX	5689
850i	2.5	125	09.91 - 12.96	B5254F	5	0,8	BCPR6ES	2330	12	BCPR6EIX	5689
940i	2.0	82	09.90 - 07.94	B200E/B200F	4	0,8	BPR6ES	7822	2	BPR6EIX	6637
940i Turbo	2.0	105	01.91 - 07.94	B200FT	4	0,8	BPR6ES	7822	2	BPR6EIX	6637
940i	2.3	96	08.90 - 12.94	B230FB	5	0,8	BPR6ES	7822	2	BPR6EIX	6637
940i	2.3	96	09.90 - 12.94	B230F	5	0,8	BPR6ES	7822	2	BPR6EIX	6637
940	2.3	99	12.94 -	B230GK	5	0,8	BPR6ES	7822	2	BPR6EIX	6637
940i 16V	2.3	114	09.90 - 07.91	B234F	5	0,8	BPR6ES	7822	2	BPR6EIX	6637
940i Turbo Intercooler	2.3	121	08.90 - 07.94	B230FT	5	0,8	BPR6ES	7822	2	BPR6EIX	6637
940i	2.3	126	08.94 - 10.98	B230FT / FK	5	0,8	BPR6ES	7822	2	BPR6EIX	6637
940 TD	2.4	80	09.90 - 08.93	D 24 T	6	■	Y-918R	4182		D-POWER 2	6285
940 GL, GLE TD	2.4	85	09.90 -	D 24 TIC	6	■	Y-918R	4182		D-POWER 2	6285
940 TD Interc., Kombi	2.4	90	01.94 -	D 24 T	6	■	Y-918R	4182		D-POWER 2	6285
960i 16V Turbo Intercooler	2.0	140	09.90 -	B204FT	4	0,8	BPR6ES	7822	2	BPR6EIX	6637
960i Turbo Intercooler	2.3	121	09.90 -	B230FT / FK	5	0,8	BPR6ES	7822	2	BPR6EIX	6637
960 TD Interc.	2.4	85	09.91 -	D 24 TIC	6	■	Y-918R	4182		D-POWER 2	6285
960	2.5	125	09.94 - 12.96	B6254F/G/S	6	0,8	BCPR6ES	2330	12	BCPR6EIX	5689
960i	2.8	110	09.90 - 08.91	B280F	6	1,0	BPR6EFS	3623	7		
960i	2.8	125	09.90 -	B280E	6	0,6	BP7EFS	3526			
960i	2.9	150	09.90 - 07.94	B6304F	6	0,8	BCPR6ES	2330	12	BCPR6EIX	5689
960	3.0	135	09.94 -	B6304F	6	0,8	BCPR6ES	2330	12	BCPR6EIX	5689
960	3.0	150	09.94 -	B6304F/G	6	0,8	BCPR6ES	2330	12	BCPR6EIX	5689
C 30 1.6 D Turbo	1.6	80	11.06 -	D4164T	4	■	YE04	1101		D-POWER 40	1684
C 70	2.0	106	98 -	B5204S	5	0,8	BKR6ES	3783	28	BKR6EIX	6418
C 70 2.0 T	2.0	120	03.00 - 09.02	B5204T4	5	0,8	BKR6EVX	3539		BKR6EIX	6418
C 70	2.0	132	03.97 - 09.02	B5204T2	5	0,8	BCPR7ES	3330		BCPR7EIX	5690
C 70	2.0	166	01.97 - 09.02	B5204T3	5	0,8	BCPR7ES	3330		BCPR7EIX	5690
C 70 T5	2.3	176	97 -	B5234T	5	0,8	BKR7EVX	3544		BKR7EIX	2667
C 70 T5	2.3	176	03.97 - 09.02	B5234T3	5	0,8	BKR6EVX	3539		BKR6EIX	6418
C 70	2.4	125	03.00 -	B5244S	5	0,8	BKR6ES	3783	28	BKR6EIX	6418
C 70 2.4 T	2.4	142	08.99 - 07.02	B5244T	5	0,8	BKR6EVX	3539		BKR6EIX	6418
C 70	2.4	176	00 -	B5224T	5	0,8	BKR6EVX	3539		BKR6EIX	6418
C 70	2.5	121	03.99 - 09.02	B5254S	5	0,8	BKR6ES	3783	28	BKR6EIX	6418
C 70	2.5	142	03.97 - 09.02	B5254T	5	0,8	BKR6EVX	3539		BKR6EIX	6418
S 40 1.6	1.6	80	03.99 - 12.03	B4164S2	4	0,9	BCPR6ET	2197		BCPR6EIX	5689
S 40 1.9D	1.6	81	01.05 -	D4164T	4	■	YE04	1101		D-POWER 40	1684
S 40	1.8		04.98 - 12.03	B4184SM/SJ	4	0,8	IZFR6B	3116			
S 40 1.8	1.8	90	03.99 - 12.03	B4184S2	4	0,9	BCPR6ET	2197		BCPR6EIX	5689

<sup>1)</sup> Bic = Best in class



l kW

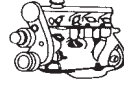

Cyl.

Order-  
No. No.Bic<sup>1)</sup> Order-  
D-Power No.**VOLVO**

S 40 1.8	1.8	92	04.04-	B4184S11	4	1,3	ITR6F-13	4477			
S 40 1.8 GDI	1.8	92	06.01 - 12.03	B4184SJ	4	0,6	IZFR6B	3116			
S 40 1.9D	1.9	66	05.96-	D4192T	4	■	Y-932R	4956		D-POWER 25	7947
S 40 1.9D	1.9	75	09.00-	D4192T4/Di	4	■	Y-515J	1019		D-POWER 18	6892
S 40 1.9D	1.9	85	07.00-	D4192T3/Di	4	■	Y-515J	1019		D-POWER 18	6892
S 40 T4	1.9	147	05.97 - 07.00	B4194T / T2	4	0,8	PFR6G	4793			
S 40 2.0	2.0	100	07.95 - 12.03	B4204S2	4	0,9	BCPR6ET	2197		BCPR6EIX	5689
S 40 2.0 T	2.0	120	10.97 - 12.03	B4204T3	4	0,8	BKR6EVX	3539		BKR6EIX	6418
S 40 T4	2.0	147	07.00 - 12.03	B4204T5	4	0,8	BKR6EVX	3539		BKR6EIX	6418
S 40 2.4	2.4	103	01.04-	B5244S5	5		LF6D	4704			
S 40 2.4i	2.4	125	01.04-	B5244S4	5		LF6D	4704			
S 60 2.0 T	2.0	132	09.01 -	B5204T5	5	0,8	BKR6EVX	3539		BKR6EIX	6418
S 60 2.3 T	2.3	147	00-	B5234T7	5	0,8	BKR6EVX	3539		BKR6EIX	6418
S 60 T5	2.3	184	11.00-	B5234T3	5	0,8	BKR6EVX	3539		BKR6EIX	6418
S 60	2.4		10.00-	B5244T	5	0,8	PFR6B	3500			
S 60 2.4	2.4	103	11.00-	B5244S2	5	0,8	BKR6ES	3783	28	BKR6EIX	6418
S 60 2.4D	2.4	120	07.01 -	D5244T	5	■	YE12	7794			
S 60 2.4	2.4	125	11.00-	B5244S	5	0,8	BKR6ES	3783	28	BKR6EIX	6418
S 60 2.4 T	2.4	147	11.00-	B5244T3	5	0,8	BKR6EVX	3539		BKR6EIX	6418
S 60 T5	2.4	191	04.04-	B5244T5	5	0,8	BKR6EVX	3539		BKR6EIX	6418
S 60 2.5T	2.5	154	02.04-	B5254T2	5	0,8	BKR6EVX	3539		BKR6EIX	6418
S 60 R 2.5T	2.5	220	03.03-	B5254T4	5	1,1	PLFR6A-11	7654			
S 70	2.0	93	01.97 - 11.00	B5202S	5	0,8	BKR6ES	3783	28	BKR6EIX	6418
S 70	2.0	105	01.97 - 11.00	B5204S	5	0,8	BKR6ES	3783	28	BKR6EIX	6418
S 70	2.0	120	01.97 - 11.00	B5204T4	5	0,8	BKR6EVX	3539		BKR6EIX	6418
S 70	2.0	132	01.97 - 11.00	B5204T2	5	0,8	BCPR7ES	3330		BCPR7EIX	5690
S 70	2.0	154	01.97 - 11.00	B5204T	5	0,8	BCPR7ES	3330		BCPR7EIX	5690
S 70	2.0	166	01.97 - 11.00	B5204T3	5	0,8	BCPR7ES	3330		BCPR7EIX	5690
S 70	2.3	120	99-	B5234S	5	0,8	BKR6ES	3783	28	BKR6EIX	6418
S 70	2.3	166	09.97 -	B5234T	5	0,8	BCPR7ES	3330		BCPR7EIX	5690
S 70	2.3	177	99-	B5234T5	5	0,8	BCPR7ES	3330		BCPR7EIX	5690
S 70	2.3	177	99-	B5234T6	5	0,8	BCPR7ES	3330		BCPR7EIX	5690
S 70	2.3	184	01.97 - 11.00	B5234T4	5	0,9	BKR7E	6097		BKR7EIX	2667
S 70	2.3	184	01.97 - 11.00	B5234T8	5	0,9	BKR7E	6097		BKR7EIX	2667
S 70	2.3	184	01.97 - 11.00	B5234T3	5	0,8	BKR7EVX	3544		BKR7EIX	2667
S 70	2.4	103	08.99 - 11.00	B5244S2	5	0,8	BKR6ES	3783	28	BKR6EIX	6418
S 70	2.4	125	99-	B5244S	5	0,8	BKR6ES	3783	28	BKR6EIX	6418
S 70 2.4 T	2.4	142	01.97 - 07.99	B5244T	5	0,8	BKR6EVX	3539		BKR6EIX	6418
S 70	2.4	195	99-	B5244T2	5	0,8	BCPR7ES	3330		BCPR7EIX	5690
S 70 TDi	2.5	103	01.97 -	D5252 (Audi)	5	■	Y-732U	2408		D-POWER 4	6001
S 70	2.5	103	01.97 -	D5252T	5	■	Y-732U	2408		D-POWER 4	6001
S 70 2.5 10V	2.5	106	01.97 - 11.00	B5252S	5	0,8	BKR6ES	3783	28	BKR6EIX	6418
S 70 2.5 20V	2.5	125	01.97 - 11.00	B5254S	5	0,8	BKR6ES	3783	28	BKR6EIX	6418
S 70 2.5 T	2.5	142	01.97 - 11.00	B5254T	5	0,8	BKR6EVX	3539		BKR6EIX	6418
S 80 2.0 T	2.0	132	12.99 -	B5204T5	5	0,8	BKR6EVX	3539		BKR6EIX	6418
S 80	2.0	166	06.98 -	B5204T3	5	0,8	BCPR7ES	3330		BCPR7EIX	5690
S 80 2.3 T	2.3	147	99-	B5234T7	5	0,8	BKR6EVX	3539		BKR6EIX	6418
S 80 2.4	2.4	103	01.99 -	B5244S2	5	0,8	BKR6ES	3783	28	BKR6EIX	6418
S 80 2.4D	2.4	120	08.01 -	D5244T	5	■	YE12	7794			
S 80 2.4	2.4	125	05.98 -	B5244S	5	0,8	BKR6ES	3783	28	BKR6EIX	6418
S 80 2.4	2.4	147	08.00 - 07.03	B5244T3	5	0,8	BKR6EVX	3539		BKR6EIX	6418
S 80 2.4 T	2.4	147	06.00 -	B5244T3	5	0,8	BKR6EVX	3539		BKR6EIX	6418

<sup>1)</sup> Bic = Best in class



ℓ kW

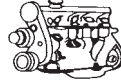

Cyl.

Order-  
No. No.Bic<sup>1)</sup> Order-  
D-Power No.**VOLVO**

S 80 2.5D	2.5	103	01.99 -	D5252T	5	■	Y-732U	2408		D-POWER 4	6001
S 80 2.5 T AWD	2.5	154	07.03 -	B5254T2	5	0,8	BKR6EVX	3539		BKR6EIX	6418
S 80 T6	2.8	200	06.98 -	B6284T2	6	0,8	BKR6EVX	3539		BKR6EIX	6418
S 80 2.8 T	2.8	200	05.98 -	B6284T	6	0,8	BKR6EVX	3539		BKR6EIX	6418
S 80 2.9	2.9	144	06.01 -	B6294S/S2	6	0,8	BKR6EKUB	3584			
S 80 T6	2.9	200	06.01 -	B6294T	6	0,8	BKR6EVX	3539		BKR6EIX	6418
S 80 3.0	3.0	147	05.98 -	B6304S3	6	0,8	BKR6ES	3783	28	BKR6EIX	6418
S 80	3.0	150	06.99 -	B6304S	6	0,8	BKR6ES	3783	28	BKR6EIX	6418
S 90	2.4	120	97 -	B6244F	6	0,8	BCPR6ES	2330	12	BCPR6EIX	5689
S 90	2.5	125	97 -	B6254F	6	0,8	BCPR6ES	2330	12	BCPR6EIX	5689
S 90	2.5	125	97 -	B6254G	6	0,8	BCPR6ES	2330	12	BCPR6EIX	5689
S 90 3.0	3.0	132	01.97 -05.98	B6304S	6	0,8	BKR6ES	3783	28	BKR6EIX	6418
S 90 3.0	3.0	150	01.97 -	B6304S	6	0,8	BKR6ES	3783	28	BKR6EIX	6418
S 90	3.0	150	01.97 -05.98	B6304G	6	0,8	BCPR6ES	2330	12	BCPR6EIX	5689
S 90	3.0	150	97 -	B6304F	6	0,8	BCPR6ES	2330	12	BCPR6EIX	5689
V 40 1.6	1.6	80	03.99 -	B4164S2	4	0,9	BCPR6ET	2197		BCPR6EIX	5689
V 40	1.8		04.98 -09.00	B4184SM/SJ	4	0,8	IZFR6B	3116			
V 40	1.8		96 -	B4184 S	4		BKR6EKUB	3584		BKR6EQUIP	3199
V 40 Bi-Fuel Holland	1.8	88		B4184S9	4	0,9	BCPR6ET	2197		BCPR6EIX	5689
V 40 1.8	1.8	90	03.99 -	B4184S2	4	0,9	BCPR6ET	2197		BCPR6EIX	5689
V 40 1.8 GDI	1.8	92	08.97 -04.04	B4184SJ	4	0,6	IZFR6B	3116			
V 40 1.9DCI	1.9		07.00 -	dCi Renault	4	■	Y-515J	1019		D-POWER 18	6892
V 40 1.9D	1.9	66	02.96 -	D4192T	4	■	Y-932R	4956		D-POWER 25	7947
V 40 1.9DI	1.9	70	03.99 -07.00	D4192T2	4	■	Y-740U	5104		D-POWER 22	4818
V 40 T4	1.9	147	05.97 -07.00	B4194T / T2	4	0,8	PFR6G	4793			
V 40 2.0	2.0	100	96 -	B4204 S 2	4	0,9	BCPR6ET	2197		BCPR6EIX	5689
V 40 2.0 T	2.0	120	06.00 -04.04	B4204T3	4	0,8	PFR6G	4793			
V 40 2.0 T	2.0	147	07.00 -04.04	B4204T5	4	0,8	PFR6G	4793			
V 50 1.6D	1.6	81	01.05 -	D4164T	4	■	YE04	1101		D-POWER 40	1684
V 50 1.8	1.8	92	04.04 -	B4184S11	4	1,3	ITR6F-13	4477			
V 50 2.4	2.4	103	04.04 -	B5244S5	5		LFR6D	4704			
V 50 2.4i	2.4	125	04.04 -	B5244S7	5		LFR6D	4704			
V 70 2.0	2.0	93	01.97 -03.00	B5202S	5	0,8	BKR6ES	3783	28	BKR6EIX	6418
V 70	2.0	105	01.97 -03.00	B5204S	5	0,8	BKR6ES	3783	28	BKR6EIX	6418
V 70 2.0 T	2.0	120	01.97 -03.00	B5204T4	5	0,8	BKR6EVX	3539		BKR6EIX	6418
V 70 2.0 T	2.0	132	07.01 -	B5204T5	5	0,8	BKR6EVX	3539		BKR6EIX	6418
V 70 2.0 T	2.0	132	01.97 -03.00	B5204T2	5	0,8	BKR6EVX	3539		BKR6EIX	6418
V 70	2.0	154	01.97 -03.00	B5204T	5	0,8	BCPR7ES	3330		BCPR7EIX	5690
V 70	2.0	166	01.97 -03.00	B5204T3	5	0,8	BCPR7ES	3330		BCPR7EIX	5690
V 70	2.3	120	01.99 -	B5234S	5	0,8	BKR6ES	3783	28	BKR6EIX	6418
V 70 2.3 T	2.3	147	00 -	B5234T7	5	0,8	BKR6EVX	3539		BKR6EIX	6418
V 70	2.3	166	09.97 -03.00	B5234T	5	0,8	BCPR7ES	3330		BCPR7EIX	5690
V 70	2.3	177	99 -	B5234T6	5	0,8	BCPR7ES	3330		BCPR7EIX	5690
V 70	2.3	177	99 -	B5234T5	5	0,8	BCPR7ES	3330		BCPR7EIX	5690
V 70	2.3	184	01.97 -03.00	B5234T8	5	0,9	BKR7E	6097		BKR7EIX	2667
V 70 T-5	2.3	184	01.97 -03.00	B5234T3	5	0,8	BKR7EVX	3544		BKR7EIX	2667
V 70	2.3	184	03.00 -	B5234T3	5	0,8	BKR6EVX	3539		BKR6EIX	6418
V 70	2.3	184	04.97 -03.00	B5234T4	5	0,9	BKR7E	6097		BKR7EIX	2667
V 70 2.4	2.4	103	08.99 -03.00	B5244S2	5	0,8	BKR6ES	3783	28	BKR6EIX	6418
V 70 2.4D	2.4	120	08.01 -	D5244T	5	■	YE12	7794			
V 70 2.4	2.4	125	03.00 -	B5244S	5	0,8	BKR6ES	3783	28	BKR6EIX	6418
V 70	2.4	142	01.97 -03.00	B5244T	5	0,8	BKR6EVX	3539		BKR6EIX	6418

<sup>1)</sup> Bic = Best in class



l kW

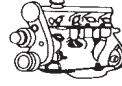

Cyl.

Order-  
No. No.Bic<sup>1)</sup> Order-  
D-Power No.**VOLVO**

V 70 2.4 T	2.4	147	03.00 -	B5244T3	5	0,8	BKR6EVX	3539		BKR6EIX	6418
V 70 T5	2.4	191	04.04 -	B5244T5	5	0,8	BKR6EVX	3539		BKR6EIX	6418
V 70	2.4	195	03.99 - 03.00	B5244T2	5	0,8	BCPR7ES	3330		BCPR7EIX	5690
V 70 2.5D	2.5	103	01.97 - 03.00	D5252T	5	█	Y-732U	2408		D-POWER 4	6001
V 70 2.5 10V	2.5	106	01.97 - 03.00	B5252S	5	0,8	BKR6ES	3783	28	BKR6EIX	6418
V 70 2.5 20V	2.5	125	01.97 - 03.00	B5254S	5	0,8	BKR6ES	3783	28	BKR6EIX	6418
V 70	2.5	142	01.97 - 03.00	B5254T	5	0,8	BKR6EVX	3539		BKR6EIX	6418
V 70	2.5	154	04.04 -	B5254T2	5	0,8	BKR6EVX	3539		BKR6EIX	6418
V 70 R	2.5	220	03.03 -	B5254T4	5	1,1	PLFR6A-11	7654			
V 90	2.4	120	97 -	B6244F	6	0,8	BCPR6ES	2330	12	BCPR6EIX	5689
V 90	2.5	125	97 -	B6254F	6	0,8	BCPR6ES	2330	12	BCPR6EIX	5689
V 90	2.5	125	97 -	B6254G	6	0,8	BCPR6ES	2330	12	BCPR6EIX	5689
V 90	2.9	150	97 -	B6304F	6	0,8	BCPR6ES	2330	12	BCPR6EIX	5689
V 90	2.9	150	97 -	B6304G	6	0,8	BCPR6ES	2330	12	BCPR6EIX	5689
V 90 3.0	3.0	132	01.97 -	B6304S2	6	0,8	BKR6ES	3783	28	BKR6EIX	6418
V 90 3.0	3.0	150	01.97 -	B6304S	6	0,8	BKR6ES	3783	28	BKR6EIX	6418
XC70 D5	2.4	120	09.02 -	D5244T	5	█	YE12	7794			
XC70 2.4T	2.4	147	09.00 - 09.02	B5244T3	5	0,8	BKR6EVX	3539		BKR6EIX	6418
XC70 2.5T	2.5	154	09.02 -	B5254T2	5	0,8	BKR6EVX	3539		BKR6EIX	6418
XC90 D5	2.4	120	02.03 -	D5244T	5	█	YE12	7794			
XC90 2.5T	2.5	154	10.02 -	B5254T2	5	0,8	BKR6EVX	3539		BKR6EIX	6418
XC90 T6 Biturbo	2.9	200	10.02 -	B6294T	6	0,8	BKR6EVX	3539		BKR6EIX	6418
XC90 V8	4.4	232	11.04 -	B8444S	8	1,1	IFR6B-11				

**VW**

Beetle	1.4	55	08.01 -	BCA	4	1,1	PZFR5D-11	7968	34		
Beetle	1.6	74	06.00 -	AYD	4	1,0	BKUR6ET-10	2397	24	PFR6Q	6458
Beetle	1.6	74	11.99 - 10.00	AWH	4	1,0	BKUR6ET-10	2397	24	PFR6Q	6458
Beetle	1.6	75	06.02 -	BFS	4	1,0	BKUR6ET-10	2397	24	PFR6Q	6458
Beetle	1.8	110	07.04 -	BKF	4	0,8	PFR6Q	6458			
Beetle	1.8	110	01.99 - 06.00	APH	4	0,8	PFR6Q	6458			
Beetle	1.8	110	07.99 - 10.00	AVC	4	0,8	PFR6Q	6458			
Beetle	1.8	110	01.98 - 06.00	AGU	4	0,8	PFR6Q	6458			
Beetle	1.8	110	10.00 -	AWU	4	0,8	PFR6Q	6458			
Beetle	1.8	110	06.00 - 06.04	AWV	4	0,8	PFR6Q	6458			
Beetle	1.8	132	06.02 - 06.04	AWP	4	0,8	PFR6Q	6458			
Beetle TDI	1.9	66	01.98 - 06.04	ALH	4	█	Y-732U	2408		D-POWER 4	6001
Beetle TDI	1.9	74	10.00 -	ATD	4	█	Y-741U	5065		D-POWER 20	6943
Beetle TDI	1.9	74	07.05 -	BEW	4	█	CZ101				
Beetle TDI	1.9	74	06.03 -	AXR	4	█	Y-741U	5065		D-POWER 20	6943
Beetle TDI	1.9	74	10.00 - 10.01	ATD	4	█	Y-732U	2408		D-POWER 4	6001
Beetle TDI	1.9	77	07.05 -	BSW	4	█	Y-741U	5065		D-POWER 20	6943
Beetle	2.0	85	07.04 -	BEV	4	1,1	PZFR5D-11	7968	34		
Beetle	2.0	85	07.07 -	CBPA	4	1,0	BKUR6ET-10	2397	24	PFR6Q	6458
Beetle	2.0	85	07.05 -	BHP	4	1,0	BKUR6ET-10	2397	24	PFR6Q	6458
Beetle	2.0	85	06.02 - 07.03	AZG	4	1,1	PZFR5D-11	7968	34		
Beetle	2.0	85	01.03 -	BER	4	1,1	PZFR5D-11	7968	34		
Beetle	2.0	85	03.00 -	APK	4	1,0	BKUR6ET-10	2397	24	PFR6Q	6458
Beetle	2.0	85	06.01 -	AZJ	4	1,1	PZFR5D-11	7968	34		
Beetle	2.0	85	08.98 -	AQY	4	1,0	BKUR6ET-10	2397	24	PFR6Q	6458
Beetle	2.0	85	01.98 - 05.01	AEG	4	1,0	BKUR6ET-10	2397	24	PFR6Q	6458
Beetle	2.3	125	10.00 -	AQN	5	1,1	PZFR5D-11	7968	34		

<sup>1)</sup> Bic = Best in class





ℓ kW

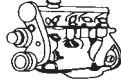

Cyl.

Order-  
No. No.Bic<sup>1)</sup> Order-  
D-Power No.**VW**

Beetle Fgst --> 1C-6-413 286*	2.5	110	07.05 -	BPS	5	1,1	PZFR5J-11	7743			
Beetle Fgst --> 1C-6-413 286*	2.5	110	07.05 -	BPR	5	1,1	PZFR5J-11	7743			
Beetle Fgst 1C-6-413 287 -->	2.5	110	07.05 -	BPR	5	1,1	PZFR5Q-11				
Beetle Fgst 1C-6-413 287 -->	2.5	110	07.05 -	BPS	5	1,1	PZFR5Q-11				
Beetle RSI	3.2	165	10.00 -05.01	AXJ	6	1,1	PZFR5D-11	7968	34		
Bora 16V	1.4	55	05.99 -05.00	APE	4	1,0	BKUR6ET-10	2397	24	PFR6Q	6458
Bora 16V	1.4	55	09.98 -05.00	AKQ	4	1,0	BKUR6ET-10	2397	24	PFR6Q	6458
Bora	1.4	55	05.00 -10.01	AXP	4	1,0	BKUR6ET-10	2397	24	PFR6Q	6458
Bora	1.4	55	10.98 -05.05	AHW	4	1,0	BKUR6ET-10	2397	24	PFR6Q	6458
Bora	1.4	55	10.01 -05.05	BCA	4	1,1	PZFR5D-11	7968	34		
Bora AUTOMATIC	1.4	55	05.00 -10.01	AXP	4	1,1	PZFR5D-11	7968	34		
Bora	1.6	74	09.98 -05.03	AKL	4	1,0	BKUR6ET-10	2397	24	PFR6Q	6458
Bora	1.6	74	05.99 -09.00	APF	4	1,0	BKUR6ET-10	2397	24	PFR6Q	6458
Bora	1.6	74	09.98 -06.02	AEH	4	1,0	BKUR6ET-10	2397	24	PFR6Q	6458
Bora	1.6	74	09.00 -04.02	AVU	4	1,0	BKUR6ET-10	2397	24	PFR6Q	6458
Bora	1.6	75	05.02 -05.05	BFQ	4	1,0	BKUR6ET-10	2397	24	PFR6Q	6458
Bora	1.6	77	11.99 -05.00	ATN	4	1,0	BKUR6ET-10	2397	24	PFR6Q	6458
Bora	1.6	77	11.01 -05.05	BCB	4	1,1	PZFR6J-11	3586			
Bora	1.6	77	05.00 -10.00	AUS	4	1,0	BKUR6ET-10	2397	24	PFR6Q	6458
Bora 16V	1.6	77	09.00 -11.01	AZD	4	1,1	PZFR6J-11	3586			
Bora FSI	1.6	81	08.01 -05.05	BAD	4		ZFR6S-Q	6449			
Bora	1.8	92	09.98 -10.00	AGN	4	1,0	BKUR6ET-10	2397	24	PFR6Q	6458
Bora	1.8	110	09.00 -05.05	AUM	4	0,8	PFR6Q	6458			
Bora	1.8	110	09.00 -04.01	ARX	4	0,8	PFR6Q	6458			
Bora	1.8	110	09.00 -05.03	AGU	4	0,8	PFR6Q	6458			
Bora	1.8	132	05.02 -05.05	AUQ	4	0,8	PFR6Q	6458			
Bora SDI	1.9	50	11.98 -05.05	AQM	4	█	Y-732U	2408		D-POWER 4	6001
Bora	1.9	50	05.00 -04.01	AGP	4	█	Y-732U	2408		D-POWER 4	6001
Bora TDI	1.9	66	09.98 -05.03	ALH	4	█	Y-732U	2408		D-POWER 4	6001
Bora	1.9	66	10.98 -09.02	AGR	4	█	Y-732U	2408		D-POWER 4	6001
Bora TDI Fgst 1J-2-600001 -->	1.9	74	05.00 -05.05	ATD	4	█	Y-741U	5065		D-POWER 20	6943
Bora TDI Fgst --> 1J-2-600000	1.9	74	05.00 -05.05	ATD	4	█	Y-732U	2408		D-POWER 4	6001
Bora TDI Fgst --> 1J-2-600000	1.9	74	05.01 -05.05	AXR	4	█	Y-732U	2408		D-POWER 4	6001
Bora TDI Fgst 1J-2-600001 -->	1.9	74	05.01 -05.05	AXR	4	█	Y-741U	5065		D-POWER 20	6943
Bora TDI	1.9	81	09.98 -05.05	AHF	4	█	Y-732U	2408		D-POWER 4	6001
Bora TDI	1.9	81	05.00 -05.05	ASV	4	█	Y-732U	2408		D-POWER 4	6001
Bora TDI	1.9	85	05.00 -07.01	AUY	4	█	Y-732U	2408		D-POWER 4	6001
Bora	1.9	85	11.98 -07.01	AJM	4	█	Y-732U	2408		D-POWER 4	6001
Bora TDI Fgst --> 1J-2-600000	1.9	96	04.01 -05.05	ASZ	4	█	Y-732U	2408		D-POWER 4	6001
Bora TDI Fgst 1J-2-600001 -->	1.9	96	04.01 -05.05	ASZ	4	█	Y-741U	5065		D-POWER 20	6943
Bora TDI Fgst 1J-2-600001 -->	1.9	110	09.00 -05.05	ARL	4	█	Y-741U	5065		D-POWER 20	6943
Bora TDI Fgst --> 1J-2-600000	1.9	110	09.00 -05.05	ARL	4	█	Y-732U	2408		D-POWER 4	6001
Bora	2.0	85	11.98 -05.05	APK	4	1,0	BKUR6ET-10	2397	24	PFR6Q	6458
Bora	2.0	85	05.01 -05.05	AZJ	4	1,1	PZFR5D-11	7968	34		
Bora	2.0	85	09.98 -05.05	AQY	4	1,0	BKUR6ET-10	2397	24	PFR6Q	6458
Bora	2.0	85	04.00 -06.01	AZH	4	1,0	BKUR6ET-10	2397	24	PFR6Q	6458
Bora	2.3	110	09.98 -02.01	AGZ	5	0,8	BKR5EKUP	2890			
Bora	2.3	125	09.00 -05.05	AQN	5	1,1	PZFR5D-11	7968	34		
Bora VR6	2.8	150	05.99 -05.00	AQP	6	1,1	PZFR5D-11	7968	34		
Bora VR6	2.8	150	05.00 -04.01	AUE	6	1,1	PZFR5D-11	7968	34		
Bora	2.8	150	05.01 -05.03	BDE	6	1,1	PZFR5D-11	7968	34		
Caddy	1.4	44	11.97 -09.00	AKV	4	0,8	BUR6ET	3172	1	PGR6D	6248

<sup>1)</sup> Bic = Best in class

Fgst = Chassis No.



ℓ kW

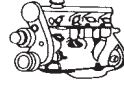

Cyl.

Order-  
No. No.Bic<sup>1)</sup> Order-  
D-Power No.

VW

Caddy	1.4	44	09.00 - 06.03	AUD	4	1,1	PZFR5D-11	7968	34		
Caddy	1.4	44	11.95 - 12.97	AEX	4	0,8	BUR6ET	3172	1	PGR6D	6248
Caddy	1.4	44	12.97 - 06.03	APQ	4	0,8	BUR6ET	3172	1	PGR6D	6248
Caddy	1.4	55	02.04 - 05.06	BCA	4	1,0	BKUR6ET-10	2397	24	PFR6Q	6458
Caddy	1.4	55	09.00 - 06.03	AUA	4	1,0	BKUR6ET-10	2397	24	PFR6Q	6458
Caddy	1.4	59	05.06 -	BUD	4	1,1	ZFR6T-11G	5960			
Caddy	1.6	40	08.90 - 07.92	ME	4	█	Y-918R	4182		D-POWER 2	6285
Caddy	1.6	40	10.82 - 07.90	JK	4	█	Y-918R	4182		D-POWER 2	6285
Caddy	1.6	55	11.95 - 05.97	1F	4	0,8	BUR5ET	3377	22	PGR6D	6248
Caddy	1.6	55	11.83 - 07.91	EW	4	0,7	BP6ES	7811	4	BPR6EIX	6637
Caddy Pickup	1.6	55	06.96 - 12.00	AEE	4	0,8	BUR6ET	3172	1	PGR6D	6248
Caddy	1.6	55	08.83 - 07.89	HN	4	0,7	BP6ES	7811	4	BPR6EIX	6637
Caddy	1.6	75	04.04 - 05.05	BGU	4	1,0	BKUR6ET-10	2397	24	PFR6Q	6458
Caddy	1.6	75	06.05 -	BSE	4	1,0	BKUR6ET-10	2397	24	PFR6Q	6458
Caddy	1.6	75	06.05 -	BSF	4	1,0	BKUR6ET-10	2397	24	PFR6Q	6458
Caddy	1.7	42	07.96 - 09.00	AHB	4	█	Y-918R	4182		D-POWER 2	6285
Caddy	1.8	70	08.85 - 07.92	JH	4	0,8	BUR6ET	3172	1	PGR6D	6248
Caddy	1.9	47	11.95 - 06.03	1Y	4	█	Y-918R	4182		D-POWER 2	6285
Caddy SDI	1.9	47	09.00 - 06.03	AYQ	4	█	Y-732U	2408		D-POWER 4	6001
Caddy	1.9	47	11.95 - 09.00	AEY	4	█	Y-732U	2408		D-POWER 4	6001
Caddy	1.9	47	06.96 - 12.00	AEF	4	█	Y-918R	4182		D-POWER 2	6285
Caddy TDI	1.9	55	09.05 -	BSU	4	█	Y-607AS	9776		D-POWER 50	
Caddy TDI	1.9	66	10.96 - 09.00	AHU	4	█	Y-732U	2408		D-POWER 4	6001
Caddy TDI	1.9	66	09.00 - 06.03	ALH	4	█	Y-732U	2408		D-POWER 4	6001
Caddy TDI	1.9	66	09.97 - 09.00	ALE	4	█	Y-732U	2408		D-POWER 4	6001
Caddy TDI	1.9	77	02.04 -	BJB	4	█	Y-607AS	9776		D-POWER 50	
Caddy TDI	1.9	77	06.05 -	BLS	4	█	Y-607AS	9776		D-POWER 50	
Caddy SDI	2.0	51	02.04 -	BDJ	4	█	Y-741U	5065		D-POWER 20	6943
Caddy SDI	2.0	52	06.05 -	BST	4	█	Y-741U	5065		D-POWER 20	6943
Caddy TDI	2.0	103	09.07 -	BMM	4	█	Y-607AS	9776		D-POWER 50	
Caddy	2.0	110	04.06 -	BSX	4	0,9	BKR6E	6962	28	BKR6EIX	6418
Corrado 16V	1.8	98	04.89 - 07.92	KR	4	0,8	BCP7ET	2078		BCPR7EIX	5690
Corrado G60	1.8	118	10.88 - 09.93	PG	4		---				
Corrado G60	1.8	118	09.88 - 07.93	PG	4		---				
Corrado	2.0	85	07.94 - 07.95	ADY	4	0,8	BUR6ET	3172	1	PGR6D	6248
Corrado	2.0	85	04.93 - 09.94	2E	4	0,8	BUR6ET	3172	1	PGR6D	6248
Corrado	2.0	100	08.91 - 07.95	9A	4	0,8	BKUR7ET	7873		PFR7Q	7963
Corrado VR6	2.8	128	08.91 - 01.96	AAA	6	0,8	BKR5EKUP	2890			
Corrado VR6	2.8	132	08.91 - 06.95	AAA	6	0,7	BKR5EKU	3964			
Corrado VR6	2.8	132	07.95 - 01.96	AAA	6	0,8	BKR5EKUP	2890			
Corrado VR6	2.9	140	08.91 - 07.95	ABV	6	0,7	BKR5EKU	3964			
Crafter	2.5	65	04.06 -	BJJ	5	█	CZ101				
Crafter TDI	2.5	80	04.06 -	BJK	5	█	CZ101				
Crafter TDI	2.5	100	04.06 -	BJL	5	█	CZ101				
Crafter TDI	2.5	120	04.06 -	BJM	5	█	CZ101				
Eos TFSI	1.4	85	11.07 -	CAXA	4	0,9	PZFR6R				
Eos TDI	2.0	103	05.06 -	BMM	4	█	Y-607AS	9776		D-POWER 50	
Eos FSI	2.0	110	05.06 -	BVY	4	1,1	PZFR5N-11T	7742			
Eos FSI	2.0	110	05.06 -	BVZ	4	0,9	BKR6E	6962	28	BKR6EIX	6418
Eos TFSI	2.0	147	05.06 - 05.08	BWA	4	0,8	PFR6Q	6458			
Eos V6	3.2	184	05.06 -	BUB	6	0,9	IZKR7B	7563			
Fox	1.2	40	09.05 -	BMD	3	0,9	ZFR5P-G	6893			

<sup>1)</sup> Bic = Best in class



ℓ kW

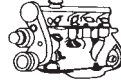

Cyl.

Order-  
No. No.Bic<sup>1)</sup> Order-  
D-Power No.**VW**

Fox TDI	1.4	51	09.05 -	BNM	3	■	Y-741U	5065		D-POWER 20	6943
Fox	1.4	55	09.05 -	BKR	4	1,1	PZFR5D-11	7968	34		
Golf 2/ Jetta	1.0	37	08.89 - 10.91	HZ	4	0,8	BUR6ET	3172	1	PGR6D	6248
Golf 2/ Jetta	1.0	37	05.85 - 08.88	HZ	4	0,8	BUR6ET	3172	1	PGR6D	6248
Golf 2/ Jetta	1.0	37	08.88 - 07.89	HZ	4	0,7	BP6ESZ	7639		PGR6D	6248
Golf 2/ Jetta	1.3	40	08.88 - 07.89	MH	4	0,7	BP6ESZ	7639		PGR6D	6248
Golf 2/ Jetta	1.3	40	08.85 - 08.88	MH	4	0,8	BUR6ET	3172	1	PGR6D	6248
Golf 2/ Jetta	1.3	40	08.89 - 08.91	MH	4	0,8	BUR6ET	3172	1	PGR6D	6248
Golf 2/ Jetta	1.3	40	08.89 - 07.92	NZ	4	0,8	BUR6ET	3172	1	PGR6D	6248
Golf 2/ Jetta	1.3	40	08.88 - 07.89	NZ	4	0,7	BP6ESZ	7639		PGR6D	6248
Golf 2/ Jetta	1.3	40	08.85 - 08.88	NZ	4	0,8	BUR6ET	3172	1	PGR6D	6248
Golf 2/ Jetta	1.3	40	01.89 - 07.92	2G	4	0,8	BUR6ET	3172	1	PGR6D	6248
Golf 2/ Jetta	1.3	44	08.85 - 08.88	2C	4	0,8	BUR6ET	3172	1	PGR6D	6248
Golf 2 D,TD	1.6	40	01.84 - 10.91		4	■	Y-918R	4182		D-POWER 2	6285
Golf 2/ Jetta	1.6	44	08.98 - 07.92	1V	4	■	Y-918R	4182		D-POWER 2	6285
Golf 2/ Jetta	1.6	51	08.85 - 07.92	PN	4	1,0	BUR5ET-10	7264	21	PGR6D	6248
Golf 2 / Jetta China	1.6	53	- 99	ACR	4	0,8	BUR6ET	3172	1	PGR6D	6248
Golf 2 / Jetta China	1.6	53		ANL	4	0,8	BUR6ET	3172	1	PGR6D	6248
Golf 2/ Jetta	1.6	53	08.86 - 10.91	RF	4	1,0	BUR5ET-10	7264	21	PGR6D	6248
Golf 2 / Jetta	1.6	53	07.91 - 07.92	ABX	4	1,0	BP5ET-10	5156			
Golf 2 / Jetta	1.6	53	04.86 - 07.90	RE	4	1,0	BUR5ET-10	7264	21	PGR6D	6248
Golf 2/ Jetta	1.6	55	08.86 - 07.92	ABN	4	1,0	BUR5ET-10	7264	21	PGR6D	6248
Golf 2/ Jetta	1.6	55	08.83 - 07.92	EW	4	1,0	BUR5ET-10	7264	21	PGR6D	6248
Golf 2/ Jetta	1.6	55	08.83 - 07.88	HM	4	1,0	BUR5ET-10	7264	21	PGR6D	6248
Golf 2/ Jetta	1.6	55	08.83 - 07.91	EZ	4	1,0	BUR5ET-10	7264	21	PGR6D	6248
Golf 2/ Jetta	1.6	59	08.89 - 10.91	SB	4	■	Y-918R	4182		D-POWER 2	6285
Golf 2 / Jetta China	1.6	74		AHP	4	0,8	BKR5E	7938	35	BKR5EIX	6341
Golf 2/ Jetta	1.8	62	08.89 - 07.90	RH	4	0,8	BUR6ET	3172	1	PGR6D	6248
Golf 2/ Jetta	1.8	62	08.87 - 07.89	RH	4	0,7	BP6ESZ	7639		PGR6D	6248
Golf 2/ Jetta	1.8	66	08.83 - 10.91	GU	4	0,8	BUR6ET	3172	1	PGR6D	6248
Golf 2/ Jetta	1.8	66	01.84 - 10.91	RP	4	0,8	BUR6ET	3172	1	PGR6D	6248
Golf 2/ Jetta	1.8	66	08.83 - 07.93	EX	4	0,8	BUR6ET	3172	1	PGR6D	6248
Golf 2	1.8	70	08.83 - 07.93	JH	4	0,8	BUR6ET	3172	1	PGR6D	6248
Golf 2/ Jetta	1.8	72	08.88 - 07.91	1P	4	0,8	BUR6ET	3172	1	PGR6D	6248
Golf 2/ Jetta	1.8	72	08.89 - 07.93	2H	4	0,8	BUR6ET	3172	1	PGR6D	6248
Golf 2/ Jetta	1.8	77	08.87 - 10.91	RV	4	0,8	BUR6ET	3172	1	PGR6D	6248
Golf 2/ Jetta	1.8	79	08.85 - 07.88	RG	4	0,8	BUR6ET	3172	1	PGR6D	6248
Golf 2/ Jetta	1.8	79	01.87 - 10.91	PF	4	0,8	BUR6ET	3172	1	PGR6D	6248
Golf 2/ Jetta	1.8	82	01.84 - 07.88	GZ	4	0,8	BUR6ET	3172	1	PGR6D	6248
Golf 2/ Jetta	1.8	82	01.87 - 10.91	PB	4	0,8	BUR6ET	3172	1	PGR6D	6248
Golf 2/ Jetta	1.8	82	08.83 - 07.89	KT	4	0,8	BUR6ET	3172	1	PGR6D	6248
Golf 2/ Jetta	1.8	95	02.86 - 10.91	PL	4	0,8	BKUR7ET	7873		PFR7Q	7963
Golf 2/ Jetta	1.8	102	02.86 - 10.91	KR	4	0,8	BKP7ET	2078		BCPR7EIX	5690
Golf 2/ G60	1.8	118	08.88 - 07.91	PG	4		---				
Golf 2 /G60	1.8	118	04.90 - 07.91	PG	4		---				
Golf 2/ Jetta (USA)	2.0	100	07.89 - 07.92	9A	4	0,8	BKUR7ET	7873		PFR7Q	7963
Golf 3/ Vento	1.4	44	11.91 - 07.95	ABD	4	0,8	BUR5ET	3377	22	PGR6D	6248
Golf 3/ Vento	1.4	44	07.95 - 12.97	AEX	4	0,8	BUR6ET	3172	1	PGR6D	6248
Golf 3/ Vento	1.6	55	08.92 - 09.94	ABU	4	0,8	BUR6ET	3172	1	PGR6D	6248
Golf 3/ Vento	1.6	55	07.95 - 12.97	AEE	4	0,8	BUR6ET	3172	1	PGR6D	6248
Golf 3/ Vento	1.6	55	10.94 - 07.95	AEA	4	0,8	BUR6ET	3172	1	PGR6D	6248
Golf 3/ Vento	1.6	74	04.97 - 10.00	AKS	4	0,9	BKUR5ET	2789	29	PFR6Q	6458

<sup>1)</sup> Bic = Best in class



ℓ kW

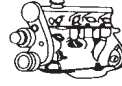

Cyl.

Order-  
No. No.Bic<sup>1)</sup> Order-  
D-Power No.**VW**

Golf 3/ Vento	1.6	74	01.96 - 10.00	AFT	4	1,0	BKUR6ET-10	2397	24	PFR6Q	6458
Golf 3/ Vento	1.6	74	10.94 - 12.95	AEK	4	0,9	BKUR5ET	2789	29	PFR6Q	6458
Golf 3/ Vento	1.8	55	12.97 - 10.00	ANN	4	0,8	BUR5ET	3377	22	PGR6D	6248
Golf 3/ Vento	1.8	55	07.91 - 10.00	AAM	4	0,8	BUR5ET	3377	22	PGR6D	6248
Golf 3/ Vento	1.8	66	11.91 - 07.95	ABS	4	0,8	BUR6ET	3172	1	PGR6D	6248
Golf 3/ Vento	1.8	66	10.94 - 10.00	ADZ	4	0,8	BUR6ET	3172	1	PGR6D	6248
Golf 3/ Vento	1.8	66	01.98 -	ADD	4	0,8	BUR6ET	3172	1	PGR6D	6248
Golf 3/ Vento	1.8	66	08.91 - 12.97	ACC	4	0,8	BUR6ET	3172	1	PGR6D	6248
Golf 3 only Cab.&Vari.	1.8	66	12.97 - 10.00	ANP	4	0,8	BUR6ET	3172	1	PGR6D	6248
Golf 3 SDI	1.9	47	11.91 - 08.98	1Y	4	█	Y-918R	4182		D-POWER 2	6285
Golf 3	1.9	47	07.95 - 02.99	AEY	4	█	Y-732U	2408		D-POWER 4	6001
Golf 3 TD	1.9	55	11.91 - 08.98	AAZ	4	█	Y-918R	4182		D-POWER 2	6285
Golf 3 TDI	1.9	66	07.93 - 07.96	1Z	4	█	Y-732U	2408		D-POWER 4	6001
Golf 3 TDI	1.9	66	07.96 - 06.00	AHU	4	█	Y-732U	2408		D-POWER 4	6001
Golf 3/ Vento TDI	1.9	66	05.96 - 12.01	ALE	4	█	Y-732U	2408		D-POWER 4	6001
Golf 3 TDI	1.9	81	02.96 - 08.99	AFN	4	█	Y-732U	2408		D-POWER 4	6001
Golf 3/ Vento (GUS)	2.0	79	01.95 - 12.97	AEP	4	0,8	BUR6ET	3172	1	PGR6D	6248
Golf 3/ Vento	2.0	85	11.91 - 09.94	2E	4	0,8	BUR6ET	3172	1	PGR6D	6248
Golf 3/ Vento	2.0	85	04.97 - 04.00	AKR	4	0,8	BUR6ET	3172	1	PGR6D	6248
Golf 3/ Vento	2.0	85	07.95 - 12.01	AGG	4	0,8	BUR6ET	3172	1	PGR6D	6248
Golf 3/ Vento	2.0	85	10.94 - 05.96	ADY	4	0,8	BUR6ET	3172	1	PGR6D	6248
Golf 3/ Jetta (USA)	2.0	85	03.92 - 07.95	ABA	4		BKR5EVX	2546		BKR5EIX	6341
Golf 3/ Vento (USA)	2.0	85	02.94 - 07.98	ADC	4		BKR5EVX	2546		BKR5EIX	6341
Golf 3/ Vento 16V	2.0	110	08.92 - 07.94	ABF	4	1,0	BKUR6ET-10	2397	24	PFR6Q	6458
Golf 3 Cabrio	2.3	125	04.00 -		5	1,1	PZFR5D-11	7968	34		
Golf 3/ Vento / VR6	2.8	128	01.92 - 06.95	AAA	6	0,7	BKR5EKU	3964			
Golf 3/ Vento / VR6	2.8	128	07.95 - 12.97	AAA	6	0,8	BKR5EKUP	2890			
Golf 3 Syncro / VR6	2.9	140	10.94 - 12.97	ABV	6	0,7	BKR5EKU	3964			
Golf 4	1.4	44	12.97 - 05.98	APQ	4	0,8	BUR6ET	3172	1	PGR6D	6248
Golf 4	1.4	55	10.97 - 05.00	AKQ	4	1,0	BKUR6ET-10	2397	24	PFR6Q	6458
Golf 4	1.4	55	05.99 - 05.00	APE	4	1,0	BKUR6ET-10	2397	24	PFR6Q	6458
Golf 4	1.4	55	10.97 - 06.06	AHW	4	1,0	BKUR6ET-10	2397	24	PFR6Q	6458
Golf 4 Automatic	1.4	55	05.00 - 10.01	AXP	4	1,1	PZFR5D-11	7968	34		
Golf 4 Schaltgetriebe / gearbox	1.4	55	05.00 - 10.01	AXP	4	1,0	BKUR6ET-10	2397	24	PFR6Q	6458
Golf 4	1.4	55	10.01 - 06.06	BCA	4	1,0	BKUR6ET-10	2397	24	PFR6Q	6458
Golf 4	1.6	74	09.00 - 04.02	AVU	4	1,0	BKUR6ET-10	2397	24	PFR6Q	6458
Golf 4	1.6	74	10.97 - 05.03	AKL	4	1,0	BKUR6ET-10	2397	24	PFR6Q	6458
Golf 4	1.6	74	01.98 - 05.04	AEH	4	1,0	BKUR6ET-10	2397	24	PFR6Q	6458
Golf 4	1.6	74	05.99 - 08.00	APF	4	1,0	BKUR6ET-10	2397	24	PFR6Q	6458
Golf 4	1.6	75	05.02 - 06.06	BFQ	4	1,0	BKUR6ET-10	2397	24	PFR6Q	6458
Golf 4	1.6	77	05.00 - 10.00	AUS	4	1,0	BKUR6ET-10	2397	24	PFR6Q	6458
Golf 4	1.6	77	11.99 - 05.00	ATN	4	1,0	BKUR6ET-10	2397	24	PFR6Q	6458
Golf 4	1.6	77	09.00 - 11.01	AZD	4	1,1	PZFR6J-11	3586			
Golf 4	1.6	77	11.01 - 06.06	BCB	4	1,1	PZFR6J-11	3586			
Golf 4 FSI	1.6	81	08.01 - 06.06	BAD	4		ZFR6S-Q	6449			
Golf 4 FSI	1.6	85	10.03 - 07.04	BAG	4		ZFR6S-Q	6449			
Golf 4	1.8	92	07.98 - 10.00	AGN	4	1,0	BKUR6ET-10	2397	24	PFR6Q	6458
Golf 4 USA	1.8	110	08.00 -	AWW	4	0,8	PFR6Q	6458			
Golf 4	1.8	110	05.99 - 04.01	ARZ	4	0,8	PFR6Q	6458			
Golf 4 USA	1.8	110	12.99 - 09.00	AWD	4	0,8	PFR6Q	6458			
Golf 4	1.8	110	09.00 - 05.06	AUM	4	0,8	PFR6Q	6458			
Golf 4 GTI	1.8	110	10.97 - 05.03	AGU	4	0,8	PFR6Q	6458			

<sup>1)</sup> Bic = Best in class



ℓ kW

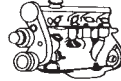

Cyl.

Order-  
No. No.Bic<sup>1)</sup> Order-  
D-Power No.**VW**

Golf 4 GTI	1.8	132	06.01 - 05.04	AUQ	4	0,8	PFR6Q	6458			
Golf 4 SDI	1.9	50	11.98 - 05.06	AQM	4	█	Y-732U	2408		D-POWER 4	6001
Golf 4 SDI	1.9	50	10.97 - 04.01	AGP	4	█	Y-732U	2408		D-POWER 4	6001
Golf 4 TDI	1.9	66	10.97 - 05.03	ALH	4	█	Y-732U	2408		D-POWER 4	6001
Golf 4	1.9	66	10.97 - 09.02	AGR	4	█	Y-732U	2408		D-POWER 4	6001
Golf 4 TDI Fgst 1J-2-600001 -->	1.9	74	02.00 - 06.06	ATD	4	█	Y-741U	5065		D-POWER 20	6943
Golf 4 TDI Fgst 1J-2-600001 -->	1.9	74	05.01 - 06.06	AXR	4	█	Y-741U	5065		D-POWER 20	6943
Golf 4 TDI Fgst --> 1J-2-600000	1.9	74	05.01 - 06.06	AXR	4	█	Y-732U	2408		D-POWER 4	6001
Golf 4 TDI Fgst --> 1J-2-600000	1.9	74	02.00 - 06.06	ATD	4	█	Y-732U	2408		D-POWER 4	6001
Golf 4 TDI	1.9	81	10.97 - 05.06	AHF	4	█	Y-732U	2408		D-POWER 4	6001
Golf 4 TDI	1.9	81	05.00 - 05.06	ASV	4	█	Y-732U	2408		D-POWER 4	6001
Golf 4 TDI	1.9	81	08.99 - 10.00	AVG	4	█	Y-732U	2408		D-POWER 4	6001
Golf 4	1.9	85	05.99 - 07.01	AJM	4	█	Y-732U	2408		D-POWER 4	6001
Golf 4 TDI	1.9	85	01.00 - 07.01	AUY	4	█	Y-732U	2408		D-POWER 4	6001
Golf 4 TDI Fgst 1J-2-600001 -->	1.9	96	04.01 - 05.06	ASZ	4	█	Y-741U	5065		D-POWER 20	6943
Golf 4 TDI Fgst --> 1J-2-600000	1.9	96	04.01 - 05.06	ASZ	4	█	Y-732U	2408		D-POWER 4	6001
Golf 4 TDI Fgst 1J-2-600001 -->	1.9	110	09.00 - 05.06	ARL	4	█	Y-741U	5065		D-POWER 20	6943
Golf 4 TDI Fgst --> 1J-2-600000	1.9	110	09.00 - 05.06	ARL	4	█	Y-732U	2408		D-POWER 4	6001
Golf 4	2.0	85	06.99 - 06.00	ATU	4	0,8	PFR6Q	6458			
Golf 4	2.0	85	05.01 - 04.02	AZG	4	1,1	PZFR5D-11	7968	34		
Golf 4 USA	2.0	85	06.98 -	AEG	4	1,0	BKUR6ET-10	2397	24	PFR6Q	6458
Golf 4 Cabrio	2.0	85	06.00 - 06.02	AWG	4	0,8	PFR6Q	6458			
Golf 4	2.0	85	04.00 - 06.01	AZH	4	1,0	BKUR6ET-10	2397	24	PFR6Q	6458
Golf 4	2.0	85	05.01 - 06.06	AZJ	4	1,1	PZFR5D-11	7968	34		
Golf 4	2.0	85	08.98 - 06.06	AQY	4	1,0	BKUR6ET-10	2397	24	PFR6Q	6458
Golf 4	2.0	85	08.98 - 05.03	APK	4	1,0	BKUR6ET-10	2397	24	PFR6Q	6458
Golf 4	2.0	85	05.02 - 06.06	BEH	4	1,1	PZFR5D-11	7968	34		
Golf 4 Cabrio	2.0	85	06.00 - 06.02	AWF	4	0,8	PFR6Q	6458			
Golf 4 V5	2.3	110	10.97 - 02.01	AGZ	5	0,8	BKR5EKUP	2890			
Golf 4	2.3	125	09.00 - 05.06	AQN	5	1,1	PZFR5D-11	7968	34		
Golf 4 USA	2.8	130	03.98 - 05.00	AFP	6	0,8	BKR5EKUP	2890			
Golf 4 VR6	2.8	150	01.00 - 04.01	AUE	6	1,1	PZFR5D-11	7968	34		
Golf 4 VR6	2.8	150	05.99 - 05.00	AQP	6	1,1	PZFR5D-11	7968	34		
Golf 4	2.8	150	05.01 - 06.05	BDE	6	1,1	PZFR5D-11	7968	34		
Golf 4 R32	3.2	177	11.03 - 06.06	BML	6	0,9	IZKR7B	7563			
Golf 4 R32	3.2	177	06.02 - 05.04	BFH	6	0,9	IZKR7B	7563			
Golf 5	1.4	55	01.05 - 05.06	BCA	4	1,0	BKUR6ET-10	2397	24	PFR6Q	6458
Golf 5	1.4	59	05.06 - 05.07	BUD	4	1,1	ZFR6T-11G	5960			
Golf 5 FSI	1.4	66	11.04 - 07.06	BLN	4		ZFR6S-Q	6449			
Golf 5 FSI	1.4	66	10.03 - 12.04	BKG	4		ZFR6S-Q	6449			
Golf 5 FSI	1.4	85	05.07 -	CAXA	4	0,9	PZFR6R				
Golf 5 FSI	1.4	103	05.06 - 05.07	BMV	4	0,9	PZFR6R				
Golf 5 GT TSI biturbo	1.4	125	11.05 - 05.07	BLG	4	0,9	PZFR6R				
Golf 5	1.6	75	05.05 - 05.07	BSE	4	1,0	BKUR6ET-10	2397	24	PFR6Q	6458
Golf 5	1.6	75	01.04 - 06.05	BGU	4	1,0	BKUR6ET-10	2397	24	PFR6Q	6458
Golf 5	1.6	75	05.05 - 05.07	BSF	4	1,0	BKUR6ET-10	2397	24	PFR6Q	6458
Golf 5 FSI	1.6	85	10.03 - 07.04	BAG	4		ZFR6S-Q	6449			
Golf 5 FSI	1.6	85	01.05 - 05.07	BLF	4		ZFR6S-Q	6449			
Golf 5 FSI	1.6	85	05.04 - 02.05	BLP	4		ZFR6S-Q	6449			
Golf 5 TDI	1.9	66	05.04 - 02.06	BRU	4	█	Y-607AS	9776		D-POWER 50	
Golf 5 TDI	1.9	66	05.07 -	BXJ	4	█	Y-607AS	9776		D-POWER 50	
Golf 5 TDI	1.9	66	02.06 - 05.07	BXF	4	█	Y-607AS	9776		D-POWER 50	

<sup>1)</sup> Bic = Best in class

Fgst = Chassis No.



l kW

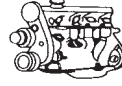

Cyl.

Order-  
No. No.Bic<sup>1)</sup> Order-  
D-Power No.

VW

Golf 5	1.9	77	10.03 - 05.06	BKC	4	☑	Y-607AS	9776			D-POWER 50	
Golf 5 TDI only with DPF	1.9	77	06.05 - 05.07	BLS	4	☑	CZ101					
Golf 5 TDI	1.9	77	02.06 - 05.07	BXE	4	☑	Y-607AS	9776			D-POWER 50	
Golf 5 SDI	2.0	55	01.04 - 05.07	BDK	4	☑	Y-607AS	9776			D-POWER 50	
Golf 5 TDI	2.0	96	06.07 -	BVB	4	☑	Y-607AS	9776			D-POWER 50	
Golf 5	2.0	100	10.03 - 05.07	AZV	4	☑	YE14	7768			D-POWER 48	7768
Golf 5 TDI	2.0	103	12.04 - 05.07	BMM	4	☑	Y-607AS	9776			D-POWER 50	
Golf 5 TDI	2.0	103	10.03 - 05.07	BKD	4	☑	YE14	7768			D-POWER 48	7768
Golf 5 FSI	2.0	110	05.04 - 11.05	BLY	4	0,9	BKR6E	6962	28		BKR6EIX	6418
Golf 5 FSI	2.0	110	01.05 - 11.05	BLR	4	1,1	PZFR5N-11T	7742				
Golf 5 FSI	2.0	110	10.03 - 05.04	AXW	4	1,1	PZFR5N-11T	7742				
Golf 5 FSI	2.0	110	05.04 - 11.05	BLX	4	1,1	PZFR5N-11T	7742				
Golf 5 FSI	2.0	110	06.05 - 05.07	BVY	4	1,1	PZFR5N-11T	7742				
Golf 5 FSI	2.0	110	11.05 - 05.07	BVZ	4	0,9	BKR6E	6962	28		BKR6EIX	6418
Golf 5 FSI	2.0	110	11.05 - 05.07	BVX	4	1,1	PZFR5N-11T	7742				
Golf 5 TDI	2.0	125	11.05 - 05.07	BMN	4	☑	CZ301					
Golf 5 FSI turbo	2.0	147	09.04 - 01.06	AXX	4	0,8	PFR6Q	6458				
Golf 5 GTI	2.0	147	11.05 - 05.07	BWA	4	0,8	PFR6Q	6458				
Golf 5 R32	3.2	184	11.05 - 05.07	BUB	6	0,9	IZKR7B	7563				
Ittis	1.7	55	01.79 - 12.88	WL	4	0,7	BP6ES	7811	4		BPR6EIX	6637
Ittis	1.7	55	01.79 - 12.88	YX	4	0,7	BP6ES	7811	4		BPR6EIX	6637
Jetta FSI (New)	1.4	103	07.06 -	BMY	4	0,9	PZFR6R					
Jetta FSI (New)	1.4	125	07.06 -	BLG	4	0,9	PZFR6R					
Jetta (New)	1.6	75	10.05 -	BSF	4	1,0	BKUR6ET-10	2397	24		PFR6Q	6458
Jetta (New)	1.6	75	08.05 -	BSE	4	1,0	BKUR6ET-10	2397	24		PFR6Q	6458
Jetta FSI (New)	1.6	85	09.05 -	BLF	4		ZFR6S-Q	6449				
Jetta TDI (New) USA	1.9	74	01.05 -	BRM	4	☑	CZ101					
Jetta TDI (New)	1.9	77	08.05 -	BKC	4	☑	Y-607AS	9776			D-POWER 50	
Jetta TDI (New)	1.9	77	09.05 -	BXE	4	☑	Y-607AS	9776			D-POWER 50	
Jetta TDI (New)	1.9	77	08.05 -	BLS	4	☑	CZ101					
Jetta TDI (New)	2.0	100	09.05 -	AZV	4	☑	YE14	7768			D-POWER 48	7768
Jetta TDI (New)	2.0	103	08.05 -	BKD	4	☑	YE14	7768			D-POWER 48	7768
Jetta TDI (New)	2.0	103	10.05 -	BMM	4	☑	Y-607AS	9776				
Jetta FSI (New)	2.0	110	10.05 - 11.05	BLY	4	0,9	BKR6E	6962	28		BKR6EIX	6418
Jetta FSI (New)	2.0	110	12.05 -	BVZ	4	0,9	BKR6E	6962	28		BKR6EIX	6418
Jetta FSI (New)	2.0	110	08.05 - 11.05	BLR	4	1,1	PZFR5N-11T	7742				
Jetta FSI (New)	2.0	110	12.05 -	BVY	4	1,1	PZFR5N-11T	7742				
Jetta TDI (New)	2.0	125	06.06 -	BMN	4	☑	CZ301					
Jetta (New)	2.0	136	09.05 -	BWA	4	0,8	PFR6Q	6458				
Jetta (New)	2.5	110	06.05 -	BTK	5	1,1	PZFR5Q-11					
Jetta (New)	2.5	125	07.07 -	CCCA	4	1,1	PZFR5Q-11					
Käfer (MEXICO IMPORT)	1.6	34	01.93 -	ACD	4	0,8	BP5ESA	2285				
LT	2.3	105	05.96 - 11.01	AGL	4	0,9	BKUR5ET	2789	29		PFR6Q	6458
LT	2.4	51	08.89 - 03.96		5	☑	Y-918R	4182			D-POWER 2	6285
LT	2.4	51	08.92 - 12.95	ACT	6	☑	Y-918R	4182			D-POWER 2	6285
LT TD	2.4	55	12.82 - 07.92	DW	6	☑	Y-918R	4182			D-POWER 2	6285
LT TD	2.4	55	08.78 - 03.96		5	☑	Y-918R	4182			D-POWER 2	6285
LT TD 4X4	2.4	55	09.85 - 03.96		5	☑	Y-918R	4182			D-POWER 2	6285
LT	2.4	55	08.78 - 03.96		5	☑	Y-918R	4182			D-POWER 2	6285
LT	2.4	66	08.82 - 07.92	DL	6	0,7	BP6ESZ	7639			PGR6D	6248
LT TD	2.4	68	12.82 - 03.96		5	☑	Y-918R	4182			D-POWER 2	6285
LT Td	2.4	68	08.88 - 07.91	1G	6	☑	Y-918R	4182			D-POWER 2	6285

<sup>1)</sup> Bic = Best in class



ℓ kW

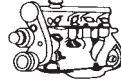

Cyl.

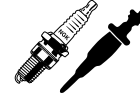
Order-  
No. No.Bic<sup>1)</sup> Order-  
D-Power No.**VW**

LT	2.4	70	08.88 - 12.95	1E	6	0,7	BP6ESZ	7639		PGR6D	6248
LT TD	2.4	70	08.91 - 12.95	ACL	6	█	Y-918R	4182		D-POWER 2	6285
LT TD	2.4	75	12.82 - 07.92	DV	6	█	Y-918R	4182		D-POWER 2	6285
LT TDI	2.5	61	04.01 - 07.06	BBE	5	█	Y-732U	2408		D-POWER 4	6001
LT	2.5	65	04.06 -	BJJ	5	█	CZ101				
LT TDI	2.5	66	05.99 - 04.01	APA	5	█	Y-732U	2408		D-POWER 4	6001
LT TDI	2.5	70	04.01 - 07.06	BBF	5	█	Y-732U	2408		D-POWER 4	6001
LT TDI	2.5	75	05.96 - 05.99	AHD	5	█	Y-732U	2408		D-POWER 4	6001
LT TD	2.5	75	08.95 - 04.96	ACV	5	█	Y-732U	2408		D-POWER 4	6001
LT TDI	2.5	80	04.06 -	BJK	5	█	CZ101				
LT TDI	2.5	80	12.02 - 07.06	AVR	5	█	Y-732U	2408		D-POWER 4	6001
LT TDI	2.5	80	05.99 - 07.06	ANJ	5	█	Y-732U	2408		D-POWER 4	6001
LT TDI	2.5	100	04.06 -	BJL	5	█	CZ101				
LT TDI	2.5	120	04.06 -	BJM	5	█	CZ101				
LT 28 D	2.4	51	08.88 - 12.95	1S	6	█	Y-918R	4182		D-POWER 2	6285
LT 28 D	2.4	55	08.78 -		6	█	Y-918R	4182		D-POWER 2	6285
LT 28 D TD	2.4	68	12.82 -		6	█	Y-918R	4182		D-POWER 2	6285
LT 28 SDI	2.5	55	05.96 -		5	█	Y-732U	2408		D-POWER 4	6001
LT 28 TDi	2.8	92	05.96 -		6	█	Y-732U	2408		D-POWER 4	6001
LT 31 D	2.4	51	08.88 - 12.95	1S	6	█	Y-918R	4182		D-POWER 2	6285
LT 31 D	2.4	55	08.78 -		6	█	Y-918R	4182		D-POWER 2	6285
LT 31 D TD	2.4	68	12.82 -		6	█	Y-918R	4182		D-POWER 2	6285
LT 35 SDI	2.5	55	05.96 - 04.01	AGX	5	█	Y-732U	2408		D-POWER 4	6001
LT 35 TDi	2.8	92	05.96 -		5	█	Y-732U	2408		D-POWER 4	6001
LT 40 D	2.4	51	08.88 - 12.95	1S	6	█	Y-918R	4182		D-POWER 2	6285
LT 40 D	2.4	55	08.78 -		6	█	Y-918R	4182		D-POWER 2	6285
LT 40 D / TD 4X4	2.4	55	09.85 -		4	█	Y-918R	4182		D-POWER 2	6285
LT 40 D TD	2.4	68	12.82 -		4	█	Y-918R	4182		D-POWER 2	6285
LT 45 D / TD 4X4	2.4	55	08.78 -		4	█	Y-918R	4182		D-POWER 2	6285
LT 45 D / TD	2.4	55	09.85 -		4	█	Y-918R	4182		D-POWER 2	6285
LT 50 D / TD	2.4	55	08.78 -		4	█	Y-918R	4182		D-POWER 2	6285
LT 55 D / TD	2.4	55	08.78 -		4	█	Y-918R	4182		D-POWER 2	6285
Lupo	1.0	37	05.99 - 05.00	ANV	4	0,9	ZFR5P-G	6893			
Lupo	1.0	37	01.99 - 05.00	AER	4	0,8	BUR6ET	3172	1	PGR6D	6248
Lupo	1.0	37	10.98 - 05.00	ALL	4	0,8	BUR6ET	3172	1	PGR6D	6248
Lupo	1.0	37	05.99 - 07.05	ALD	4	0,9	ZFR5P-G	6893			
Lupo	1.0	37	10.98 - 05.00	AHT	4	1,0	BKR6ETA-10	7998			
Lupo	1.0	37	05.00 - 07.05	AUC	4	0,9	ZFR5P-G	6893			
Lupo TDI >6x-2-005 000	1.2	45	11.00 - 07.05	AYZ	3	█	Y-732U	2408		D-POWER 4	6001
Lupo TDI	1.2	45	06.99 - 11.00	ANY	3	█	Y-732U	2408		D-POWER 4	6001
Lupo TDI 6x-2-005 001>	1.2	45	11.00 - 07.05	AYZ	3	█	Y-741U	5065		D-POWER 20	6943
Lupo	1.4	44	09.00 - 07.05	AUD	4	0,9	ZFR5P-G	6893			
Lupo TDI >6x-2-005 000	1.4	55	05.99 - 07.05	AMF	4	█	Y-732U	2408		D-POWER 4	6001
Lupo	1.4	55	05.00 - 04.02	AUA	4	1,0	BKUR6ET-10	2397	24	PFR6Q	6458
Lupo	1.4	55	07.98 - 05.99	AKQ	4	1,0	BKUR6ET-10	2397	24	PFR6Q	6458
Lupo	1.4	55	05.99 - 09.00	APE	4	1,0	BKUR6ET-10	2397	24	PFR6Q	6458
Lupo	1.4	55	04.02 - 07.05	BBY	4	1,0	BKUR6ET-10	2397	24	PFR6Q	6458
Lupo	1.4	55	01.99 - 07.05	AHW	4	1,0	BKUR6ET-10	2397	24	PFR6Q	6458
Lupo TDI 6x-2-005 001>	1.4	55	05.99 - 07.05	AMF	4	█	Y-741U	5065		D-POWER 20	6943
Lupo	1.4	74	05.99 - 05.00	AQQ	4	1,0	BKUR6ET-10	2397	24	PFR6Q	6458
Lupo	1.4	74	05.00 - 07.05	AUB	4	1,0	BKUR6ET-10	2397	24	PFR6Q	6458
Lupo	1.4	74	05.99 - 10.00	AFK	4	1,0	BKUR6ET-10	2397	24	PFR6Q	6458

<sup>1)</sup> Bic = Best in class



ℓ kW

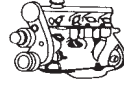

Cyl.

Order-  
No. No.Bic<sup>1)</sup> Order-  
D-Power No.

VW

Lupo	1.4	74	05.99 - 05.00	ANM	4	1,0	BKUR6ET-10	2397	24	PFR6Q	6458
Lupo FSI	1.4	77	09.00 - 11.03	ARR	4		ZFR6S-Q	6449			
Lupo GTI	1.6	92	06.00 - 07.05	AVY	4	1,0	BKUR6ET-10	2397	24	PFR6Q	6458
Lupo SDI	1.7	42	10.98 - 07.05	AKU	3	█	Y-732U	2408		D-POWER 4	6001
Passat 1 (Typ 32/33)	1.6	40	08.81 - 03.88	JK	4	█	Y-918R	4182		D-POWER 2	6285
Passat 2 (Typ 32B) TD	1.6	51	12.81 - 03.88	CY	4	█	Y-918R	4182		D-POWER 2	6285
Passat 2 (Typ 32B)	1.6	51	08.86 - 03.88	DTA	4	1,0	BUR5ET-10	7264	21	PGR6D	6248
Passat 2 (Typ 32B)	1.6	51	08.83 - 03.88	PP	4	1,0	BUR5ET-10	7264	21	PGR6D	6248
Passat 2 (Typ 32B)	1.6	53	08.83 - 03.88	RL	4	1,0	BUR5ET-10	7264	21	PGR6D	6248
Passat 2 (Typ 32B)	1.6	55	08.83 - 03.88	DT	4	1,0	BUR5ET-10	7264	21	PGR6D	6248
Passat 2 (Typ 32B)	1.8	64	09.82 - 03.88	RM	4	0,8	BUR6ET	3172	1	PGR6D	6248
Passat 2 (Typ 32B)	1.8	66	08.83 - 07.88	JN	4	0,8	BUR6ET	3172	1	PGR6D	6248
Passat 2 (Typ 32B)	1.8	66	01.83 - 07.88	DS	4	0,8	BUR6ET	3172	1	PGR6D	6248
Passat 2 (Typ 32B)	1.8	66	09.82 - 04.88	JV	4	0,8	BUR6ET	3172	1	PGR6D	6248
Passat 2 (Typ 32B)	1.8	79	01.83 - 07.90	PF	4	0,8	BUR6ET	3172	1	PGR6D	6248
Passat 2 (Typ 32B)	1.8	82	01.83 - 07.90	PB	4	0,8	BUR6ET	3172	1	PGR6D	6248
Passat 2 (Typ 32B)	2.0	85	08.83 - 03.88	JS	5	0,8	BUR6ET	3172	1	PGR6D	6248
Passat 2 (Typ 32B)	2.0	85	08.83 - 07.88	HP	4	0,8	BUR6ET	3172	1	PGR6D	6248
Passat 2 (Typ 32B)	2.2	85	08.85 - 03.88	KX	5	0,8	BUR6ET	3172	1	PGR6D	6248
Passat 2 (Typ 32B)	2.2	88	08.85 - 07.88	JT	5	0,8	BUR6ET	3172	1	PGR6D	6248
Passat 2 (Typ 32B)	2.2	100	01.85 - 03.88	KV	5	0,8	BUR6ET	3172	1	PGR6D	6248
Passat 2 (Typ 32B)	2.2	100	08.84 - 07.88	HY	5	0,8	BUR6ET	3172	1	PGR6D	6248
Passat 3 (Typ 35i)	1.6	53	04.88 - 07.91	RF	4	1,0	BUR5ET-10	7264	21	PGR6D	6248
Passat 3 (Typ 35i)	1.6	55	08.89 - 09.91	EZ	4	1,0	BUR5ET-10	7264	21	PGR6D	6248
Passat 3 (Typ 35i)	1.6	55	08.88 - 07.89	1F	4	0,8	BUR5ET	3377	22	PGR6D	6248
Passat 3 (Typ 35i)	1.6	55	08.89 - 07.92	ABN	4	1,0	BUR5ET-10	7264	21	PGR6D	6248
Passat 3 (Typ 35i)	1.6	55	04.88 - 07.89	EZ	4	0,8	BUR6ET	3172	1	PGR6D	6248
Passat 3 (Typ 35i) TD	1.6	59	08.89 - 10.93	SB	4	█	Y-918R	4182		D-POWER 2	6285
Passat 3 (Typ 35i)	1.6	74	12.95 - 12.96	AFT	4	1,0	BKUR6ET-10	2397	24	PFR6Q	6458
Passat 3 (Typ 35i)	1.6	74	10.94 - 12.95	AEK	4	0,9	BKUR5ET	2789	29	PFR6Q	6458
Passat 3 (Typ 35i)	1.8	55	08.90 - 12.96	AAM	4	0,8	BUR5ET	3377	22	PGR6D	6248
Passat 3 (Typ 35i)	1.8	66	04.88 - 07.91	RP	4	0,8	BUR6ET	3172	1	PGR6D	6248
Passat 3 (Typ 35i)	1.8	66	08.91 - 09.94	ABS	4	0,8	BUR6ET	3172	1	PGR6D	6248
Passat 3 (Typ 35i)	1.8	66	08.94 - 12.96	ADZ	4	0,8	BUR6ET	3172	1	PGR6D	6248
Passat 3 (Typ 35i) (GUS)	1.8	85	01.97 - 04.00	AFY	4	1,0	BKUR6ET-10	2397	24	PFR6Q	6458
Passat 3 (Typ 35i)	1.8	100	04.88 - 07.92	KR	4	0,8	BKP7ET	2078		BCPR7EIX	5690
Passat 3 (Typ 35i) G60	1.8	118	10.88 - 04.93	PG	4		---				
Passat 3 (Typ 35i) D,TD	1.9	47	05.89 - 10.93	1Y	4	█	Y-918R	4182		D-POWER 2	6285
Passat 3 (Typ 35i) TD	1.9	55	03.91 - 12.96	AAZ	4	█	Y-918R	4182		D-POWER 2	6285
Passat 3 (Typ 35i) TDI	1.9	66	08.96 - 08.00	AHU	4	█	Y-732U	2408		D-POWER 4	6001
Passat 3 (Typ 35i) TDI	1.9	66	08.89 - 12.96	1Z	4	█	Y-732U	2408		D-POWER 4	6001
Passat 3 (Typ 35i) TDI	1.9	81	03.96 - 08.99	AFN	4	█	Y-732U	2408		D-POWER 4	6001
Passat 3 (Typ 35i)	2.0	79	03.95 - 12.96	AEP	4	0,8	BUR6ET	3172	1	PGR6D	6248
Passat 3 (Typ 35i)	2.0	85	10.94 - 12.95	ADY	4	0,8	BUR6ET	3172	1	PGR6D	6248
Passat 3 (Typ 35i)	2.0	85	07.96 - 12.96	AGG	4	0,8	BUR6ET	3172	1	PGR6D	6248
Passat 3 (Typ 35i)	2.0	85	03.90 - 09.94	2E	4	0,8	BUR6ET	3172	1	PGR6D	6248
Passat 3 (Typ 35i)	2.0	85	06.93 - 12.94	ACX	4	0,8	BUR6ET	3172	1	PGR6D	6248
Passat 3 (Typ 35i)	2.0	100	04.88 - 10.93	9A	4	0,8	BKUR7ET	7873		PFR7Q	7963
Passat 3 (Typ 35i)	2.0	110	07.94 - 12.96	ABF	4	1,0	BKUR6ET-10	2397	24	PFR6Q	6458
Passat 3 (Typ 35i)	2.8	128	06.91 - 06.95	AAA	6	0,7	BKR5EKU	3964			
Passat 3 (Typ 35i)	2.8	128	07.95 - 12.96	AAA	6	0,8	BKR5EKUP	2890			
Passat 3 (Typ 35i) (US)	2.8	142	10.94 - 12.95	AHA	6	0,8	BKR6EKUB	3584			

<sup>1)</sup> Bic = Best in class





ℓ kW

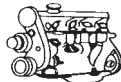

Cyl.

Order-  
No. No.Bic<sup>1)</sup> Order-  
D-Power No.**VW**

Passat 3 (Typ 35i)	2.9	135	07.94 - 06.95	ABV	6	0,7	BKR5EKU	3964			
Passat 3 (Typ 35i)	2.9	135	07.95 - 12.96	ABV	6	0,8	BKR5EKUP	2890			
Passat 4 (Typ 3B)	1.6	74	10.96 - 08.00	AHL	4	1,0	BKUR6ET-10	2397	24	PFR6Q	6458
Passat 4 (Typ 3B)	1.6	74	01.97 - 10.97	ADP	4	1,0	BKUR6ET-10	2397	24	PFR6Q	6458
Passat 4 (Typ 3B)	1.6	74	01.99 - 08.00	ARM	4	1,0	BKUR6ET-10	2397	24	PFR6Q	6458
Passat 4 (Typ 3B)	1.6	74	07.99 - 08.00	ANA	4	1,0	BKUR6ET-10	2397	24	PFR6Q	6458
Passat 4 (Typ 3B)	1.6	75	10.00 - 05.05	ALZ	4	1,0	BKUR6ET-10	2397	24	PFR6Q	6458
Passat 4 (Typ 3B) China	1.8	71		AJR	4	0,8	BKR5E	7938	35	BKR5EIX	6341
Passat 4 (Typ 3B) China	1.8	92		ANQ	4	1,0	BKUR6ET-10	2397	24	PFR6Q	6458
Passat 4 (Typ 3B)	1.8	92	12.96 - 01.99	ADR	4	1,0	BKUR6ET-10	2397	24	PFR6Q	6458
Passat 4 (Typ 3B)	1.8	92	02.99 - 08.00	ARG	4	1,0	BKUR6ET-10	2397	24	PFR6Q	6458
Passat 4 (Typ 3B)	1.8	92	01.99 - 08.00	APT	4	1,0	BKUR6ET-10	2397	24	PFR6Q	6458
Passat 4 (Typ 3B)	1.8	110	10.96 - 12.98	AEB	4	0,8	PFR6Q	6458			
Passat 4 (Typ 3B) USA	1.8	110	05.00 - 08.00	AUG	4	0,8	PFR6Q	6458			
Passat 4 (Typ 3B)	1.8	110	01.99 - 08.00	APU	4	0,8	PFR6Q	6458			
Passat 4 (Typ 3B)	1.8	110	01.99 - 08.00	ANB	4	0,8	PFR6Q	6458			
Passat 4 (Typ 3B) USA	1.8	110	08.99 - 05.00	ATW	4	0,8	PFR6Q	6458			
Passat 4 (Typ 3B)	1.8	110	10.00 - 05.05	AWT	4	0,8	PFR6Q	6458			
Passat 4 (Typ 3B) USA	1.8	125	02.01 - 05.05	AWM	4	0,8	PFR6Q	6458			
Passat 4 (Typ 3B) TDI	1.9	66	05.98 - 08.00	AHH	4	█	Y-732U	2408		D-POWER 4	6001
Passat 4 (Typ 3B) TDI	1.9	74	10.00 - 05.05	AVB	4	█	Y-732U	2408		D-POWER 4	6001
Fgst --> 3B-2-350-000											
Passat 4 (Typ 3B) TDI	1.9	74	10.00 - 05.05	AVB	4	█	Y-741U	5065		D-POWER 20	6943
Fgst 3B-2-350-001 -->											
Passat 4 (Typ 3B) TDI	1.9	81	08.99 - 08.00	AVG	4	█	Y-732U	2408		D-POWER 4	6001
Passat 4 (Typ 3B) TDI	1.9	85	01.00 - 08.00	ATJ	4	█	Y-732U	2408		D-POWER 4	6001
Passat 4 (Typ 3B) TDI	1.9	85	01.99 - 12.99	AJM	4	█	Y-732U	2408		D-POWER 4	6001
Passat 4 (Typ 3B) TDI	1.9	96	10.00 - 05.05	AWX	4	█	Y-732U	2408		D-POWER 4	6001
Fgst --> 3B-2-350-000											
Passat 4 (Typ 3B) TDI	1.9	96	10.00 - 05.05	AVF	4	█	Y-741U	5065		D-POWER 20	6943
Fgst 3B-2-350-001 -->											
Passat 4 (Typ 3B) TDI	1.9	96	10.00 - 05.05	AWX	4	█	Y-741U	5065		D-POWER 20	6943
Fgst 3B-2-350-001 -->											
Passat 4 (Typ 3B) TDI	1.9	96	10.00 - 05.05	AVF	4	█	Y-732U	2408		D-POWER 4	6001
Fgst --> 3B-2-350-000											
Passat 4 (Typ 3B)	2.0	85	10.00 - 05.05	AZM	4	1,0	BKUR6ET-10	2397	24	PFR6Q	6458
Passat 4 (Typ 3B)	2.0	96	11.01 - 05.05	ALT	4	1,0	BKUR5ET-10	7553			
Passat 4 (Typ 3B)	2.3	110	09.97 - 08.00	AGZ	5	0,8	BKR5EKUP	2890			
Passat 4 (Typ 3B)	2.3	125	01.01 - 05.05	AZX	5	1,1	PZFR5D-11	7968	34		
Passat 4 (Typ 3B) TDI V6	2.5	110	05.99 - 05.03	AKN	6	█	Y-501U	3786		D-POWER 31	4187
Passat 4 (Typ 3B) TDI V6	2.5	110	08.98 - 08.00	AFB	6	█	Y-501U	3786		D-POWER 31	4187
Passat 4 (Typ 3B) TDI	2.5	120	05.03 - 05.05	BDG	6	█	Y-501U	3786		D-POWER 31	4187
Passat 4 (Typ 3B) TDI	2.5	132	01.03 - 05.05	BDH	6	█	Y-501U	3786		D-POWER 31	4187
Passat 4 (Typ 3B) TDI	2.5	132	01.03 - 05.05	BAU	6	█	Y-501U	3786		D-POWER 31	4187
Passat 4 (Typ 3B) (GUS, CHINA)	2.8	132	09.97 - 09.99	AGE	6	0,8	BKR6EKUB	3584			
Passat 4 (Typ 3B)	2.8	140	09.99 - 08.00	ATX	6	0,8	BKR6EKUB	3584			
Passat 4 (Typ 3B)	2.8	140	10.00 - 05.05	BBG	6	0,8	BKR6EKUB	3584			
Passat 4 (Typ 3B)	2.8	142	10.00 - 05.05	AMX	6	0,8	BKR6EKUB	3584			
Passat 4 (Typ 3B)	2.8	142	08.97 - 12.98	ALG	6	0,8	BKR6EKUB	3584			
Passat 4 (Typ 3B)	2.8	142	01.99 - 08.00	AQD	6	0,8	BKR6EKUB	3584			
Passat 4 (Typ 3B)	2.8	142	10.00 - 05.05	ATQ	6	0,8	BKR6EKUB	3584			
Passat 4 (Typ 3B)	2.8	142	06.97 - 12.98	ACK	6	0,8	BKR6EKUB	3584			

<sup>1)</sup> Bic = Best in class

Fgst = Chassis No.



ℓ kW

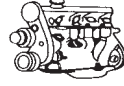

Cyl.

Order-  
No. No.Bic<sup>1)</sup> Order-  
D-Power No.

VW

Passat 4 (Typ 3B)	2.8	142	01.99-08.00	APR	6	0,8	BKR6EKUB	3584				
Passat 4 W8	4.0	202	05.02-09.04	BDP	8		BKR6EKUE	7892				
Passat 4 W8 4 MOTION	4.0	202	09.01-09.04	BDN	8		BKR6EKUE	7892				
Passat 5 (Typ 3C)	1.6	75	05.05-05.07	BSF	4	1,0	BKUR6ET-10	2397	24	PFR6Q	6458	
Passat 5 (Typ 3C)	1.6	75	05.05-05.07	BSE	4	1,0	BKUR6ET-10	2397	24	PFR6Q	6458	
Passat 5 FSI (Typ 3C)	1.6	85	03.05-05.07	BLF	4		ZFR6S-Q	6449				
Passat 5 TDI (Typ 3C)	1.9	77	02.06-05.07	BXE	4	█	Y-607AS	9776			D-POWER 50	
Passat 5 TDI (Typ 3C)	1.9	77	03.05-02.06	BKC	4	█	Y-607AS	9776			D-POWER 50	
Passat 5 TDI (Typ 3C)	1.9	77	06.05-05.07	BLS	4	█	CZ101					
Passat 5 TDI (Typ 3C)	2.0	88	11.05-05.07	BWV	4	█	CZ301					
Passat 5 TDI (Typ 3C)	2.0	90	06.05-	BVD	4	█	CZ101					
Passat 5 TDI (Typ 3C)	2.0	90	06.05-02.06	BVE	4	█	CZ301					
Passat 5 TDI (Typ 3C)	2.0	100	03.05-05.07	BMA	4	█	CZ301					
Passat 5 TDI (Typ 3C)	2.0	103	03.05-05.07	BMP	4	█	CZ101					
Passat 5 TDI (Typ 3C)	2.0	103	03.05-05.07	BKP	4	█	CZ301					
Passat 5 FSI (Typ 3C)	2.0	110	11.05-05.07	BVX	4	1,1	PZFR5N-11T	7742				
Passat 5 FSI (Typ 3C)	2.0	110	03.05-11.05	BLR	4	1,1	PZFR5N-11T	7742				
Passat 5 FSI (Typ 3C)	2.0	110	09.05-11.05	BLX	4	1,1	PZFR5N-11T	7742				
Passat 5 FSI (Typ 3C)	2.0	110	11.05-05.07	BVY	4	1,1	PZFR5N-11T	7742				
Passat 5 FSI (Typ 3C)	2.0	110	11.05-05.07	BVZ	4	0,9	BKR6E	6962	28	BKR6EIX	6418	
Passat 5 FSI (Typ 3C)	2.0	110	03.05-11.05	BLY	4	0,9	BKR6E	6962	28	BKR6EIX	6418	
Passat 5 TDI (Typ 3C)	2.0	120	10.05-05.07	BUZ	4	█	CZ301					
Passat 5 TDI (Typ 3C)	2.0	125	02.06-05.07	BMR	4	█	CZ301					
Passat 5 FSI (Typ 3C)	2.0	147	08.05-05.07	BPY	4	0,8	PFR6Q	6458				
Passat 5 FSI (Typ 3C)	2.0	147	11.05-11.07	BWA	4	0,8	PFR6Q	6458				
Passat 5 (Typ 3C)	2.0	147	07.05-11.05	AXX	4	0,8	PFR6Q	6458				
Passat 5 FSI (Typ 3C)	3.2	184	09.05-05.07	AXZ	6	0,9	ILZKR7A	1961				
Passat 5 FSI (Typ 3C)	3.6	206	09.05-05.07	BLV	6	0,9	ILZKR7A	1961				
Phaeton TDI	3.0	172	06.07-	CARA	6	█	Y-609AS	5849			D-POWER 49	5849
Phaeton	3.2	177	08.03-05.07	BKL	6	0,9	IZKR7B	7563				
Phaeton	3.2	177	05.04-05.07	BRK	6		ZKR7AP-Q					
Phaeton	3.2	177	05.02-05.05	AYT	6	0,9	IZKR7B	7563				
Phaeton	4.2	246	08.03-05.07	BGH	8		BKR6EQUA	6872				
Phaeton	4.2	246	05.03-07.03	BGJ	8		BKR6EQUA	6872				
Phaeton TDI	5.0	230	12.02-10.06	AJS	10	█	Y-741U	5065			D-POWER 20	6943
Phaeton	6.0	309	10.03-	BAP	12	1,1	PZFR6J-11	3586				
Phaeton	6.0	309	05.02-05.05	BAN	12	1,1	PZFR6J-11	3586				
Phaeton	6.0	331	05.05-05.07	BTT	12	1,1	PZFR6J-11	3586				
Phaeton	6.0	331	05.05-05.07	BRN	12	1,1	PZFR6J-11	3586				
Pointer /Gol (RUS)	1.0		05-		4	1,1	PZFR5D-11	7968	34			
Polo 2 (Typ 86C..)	1.0	33	08.89-01.92	HZ	4	0,8	BUR6ET	3172	1	PGR6D	6248	
Polo 2 (Typ 86C..)	1.0	33	08.89-12.92	ACM	4	0,8	BUR6ET	3172	1	PGR6D	6248	
Polo 2 (Typ 86C..)	1.0	33	08.88-07.89	HZ	4	0,7	BP6ESZ	7639		PGR6D	6248	
Polo 2 (Typ 86C..)	1.0	33	10.90-07.94	AAU	4	0,8	BUR5ET	3377	22	PGR6D	6248	
Polo 2 (Typ 86C..)	1.0	33	01.90-07.90	AAK	4	0,8	BUR6ET	3172	1	PGR6D	6248	
Polo 2 (Typ 86C..)	1.0	33	08.85-08.88	HZ	4	0,8	BUR6ET	3172	1	PGR6D	6248	
Polo 2 (Typ 86C..) D	1.3	33	08.85-07.90	MN	4	█	Y-918R	4182			D-POWER 2	6285
Polo 2 (Typ 86C..)	1.3	37	08.88-07.89	NU	4	0,7	BP6ESZ	7639		PGR6D	6248	
Polo 2 (Typ 86C..)	1.3	37	08.85-08.88	NU	4	0,8	BUR6ET	3172	1	PGR6D	6248	
Polo 2 (Typ 86C..)	1.3	40	08.88-07.89	NZ	4	0,7	BP6ESZ	7639		PGR6D	6248	
Polo 2 (Typ 86C..)	1.3	40	08.88-07.89	MH	4	0,7	BP6ESZ	7639		PGR6D	6248	
Polo 2 (Typ 86C..)	1.3	40	05.86-08.88	NZ	4	0,8	BUR6ET	3172	1	PGR6D	6248	

<sup>1)</sup> Bic = Best in class



ℓ kW

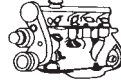

Cyl.

Order-  
No. No.Bic<sup>1)</sup> Order-  
D-Power No.**VW**

Polo 2 (Typ 86C..)	1.3	40	01.89 - 07.94	2G	4	0,8	BUR6ET	3172	1	PGR6D	6248
Polo 2 (Typ 86C..)	1.3	40	01.91 - 07.94	AAV	4	0,8	BUR5ET	3377	22	PGR6D	6248
Polo 2 (Typ 86C..)	1.3	40	08.89 - 08.91	MH	4	0,8	BUR6ET	3172	1	PGR6D	6248
Polo 2 (Typ 86C..)	1.3	40	08.89 - 12.92	NZ	4	0,8	BUR6ET	3172	1	PGR6D	6248
Polo 2 (Typ 86C..)	1.3	40	08.85 - 08.88	MH	4	0,8	BUR6ET	3172	1	PGR6D	6248
Polo 2 (Typ 86C..)	1.3	55	08.88 - 07.89	GK	4	0,8	BP7ES	2412		BPR7EIX	4055
Polo 2 (Typ 86C..)	1.3	55	08.89 - 07.90	GK	4	0,8	BUR6ET	3172	1	PGR6D	6248
Polo 2 (Typ 86C..)	1.3	55	07.82 - 08.88	GK	4	0,8	BUR6ET	3172	1	PGR6D	6248
Polo 2 (Typ 86C..)	1.3	55	01.90 - 07.94	3F	4	0,8	BUR6ET	3172	1	PGR6D	6248
Polo 2 (Typ 86C..) G40	1.3	82	10.90 - 07.94	PY	4		---				
Polo 2 (Typ 86C..) G40	1.3	82	08.86 - 09.90	PY	4		---				
Polo 2 (Typ 86C..) D	1.4	35	10.90 - 07.94	1W	4	█	Y-918R	4182		D-POWER 2	6285
Polo 3 (Typ 6..)	1.0	33	10.94 - 06.96	AEV	4	0,8	BUR6ET	3172	1	PGR6D	6248
Polo 3 (Typ 6..)	1.0	37	10.99 - 09.01	AUC	4	1,1	PZFR5D-11	7968	34		
Polo 3 (Typ 6..)	1.0	37	10.99 - 09.01	ALD	4	1,1	PZFR5D-11	7968	34		
Polo 3 (Typ 6..)	1.0	37	07.96 - 12.99	AER	4	0,8	BUR6ET	3172	1	PGR6D	6248
Polo 3 (Typ 6..)	1.0	37	08.97 - 12.99	ALL	4	0,8	BUR6ET	3172	1	PGR6D	6248
Polo 3 (Typ 6..)	1.3	40	10.94 - 04.97	ADX	4	0,8	BUR6ET	3172	1	PGR6D	6248
Polo 3 (Typ 6..)	1.4	40	10.99 - 09.01	AKP	4	1,1	PZFR5D-11	7968	34		
Polo 3 (Typ 6..)	1.4	44	07.95 - 12.97	AEX	4	0,8	BUR6ET	3172	1	PGR6D	6248
Polo 3 (Typ 6..)	1.4	44	10.99 - 09.01	AKK	4	1,1	PZFR5D-11	7968	34		
Polo 3 (Typ 6..)	1.4	44	11.97 - 12.99	APQ	4	0,8	BUR6ET	3172	1	PGR6D	6248
Polo 3 (Typ 6..)	1.4	44	10.99 - 08.00	ANW	4	1,1	PZFR5D-11	7968	34		
Polo 3 (Typ 6..)	1.4	44	01.98 - 12.99	ANX	4	0,8	BUR6ET	3172	1	PGR6D	6248
Polo 3 (Typ 6..)	1.4	44	05.97 - 12.99	AKV	4	0,8	BUR6ET	3172	1	PGR6D	6248
Polo 3 (Typ 6..)	1.4	44	10.99 - 09.01	AUD	4	1,1	PZFR5D-11	7968	34		
Polo 3 (Typ 6..)	1.4	55	10.99 - 06.00	APE	4	1,0	BKUR6ET-10	2397	24	PFR6Q	6458
Polo 3 (Typ 6..)	1.4	55	10.99 - 01.02	AUA	4	1,0	BKUR6ET-10	2397	24	PFR6Q	6458
Polo 3 (Typ 6..) TDI	1.4	55	10.99 - 05.05	AMF	3	█	Y-741U	5065		D-POWER 20	6943
Polo 3 (Typ 6..)	1.4	55	10.99 - 09.01	AHW	4	1,0	BKUR6ET-10	2397	24	PFR6Q	6458
Polo 3 (Typ 6..) TDI	1.4	66	01.00 - 04.00	ATL	3	█	Y-741U	5065		D-POWER 20	6943
Polo 3 (Typ 6..)	1.4	74	10.99 - 09.01	AFK	4	1,0	BKUR6ET-10	2397	24	PFR6Q	6458
Polo 3 (Typ 6..)	1.4	74	05.00 - 06.02	AUB	4	1,0	BKUR6ET-10	2397	24	PFR6Q	6458
Polo 3 (Typ 6..)	1.4	74	04.96 - 12.99	AFH	4	0,8	BKUR6ET-10	2397	27	PFR6Q	6458
Polo 3 (Typ 6..)	1.4	74	07.99 - 05.00	AQQ	4	1,0	BKUR6ET-10	2397	24	PFR6Q	6458
Polo 3 (Typ 6..)	1.6	55	10.94 - 09.97	1F	4	0,8	BUR5ET	3377	22	PGR6D	6248
Polo 3 (Typ 6..)	1.6	55	07.98 - 09.01	ALM	4	0,8	BUR6ET	3172	1	PGR6D	6248
Polo 3 (Typ 6..) (only Japan)	1.6	55	03.96 - 12.99	AHS	4	0,8	BPR5EKU	5685		PGR6D	6248
Polo 3 (Typ 6..)	1.6	55	07.95 - 12.99	AEE	4	0,8	BUR6ET	3172	1	PGR6D	6248
Polo 3 (Typ 6..)	1.6	55	10.94 - 07.95	AEA	4	0,8	BUR6ET	3172	1	PGR6D	6248
Polo 3 (Typ 6..)	1.6	74	10.99 - 09.01	AEH	4	1,0	BKUR6ET-10	2397	24	PFR6Q	6458
Polo 3 (Typ 6..) Variant	1.6	74	12.95 - 08.99	AFT	4	1,0	BKUR6ET-10	2397	24	PFR6Q	6458
Polo 3 (Typ 6..)	1.6	74	07.00 - 09.01	AUR	4	1,0	BKUR6ET-10	2397	24	PFR6Q	6458
Polo 3 (Typ 6..)	1.6	74	03.00 - 10.00	APF	4	1,0	BKUR6ET-10	2397	24	PFR6Q	6458
Polo 3 (Typ 6..)	1.6	74	10.99 - 09.01	AKL	4	1,0	BKUR6ET-10	2397	24	PFR6Q	6458
Polo 3 (Typ 6..) GTI	1.6	88	08.98 - 12.99	AJV	4	1,0	BKUR6ET-10	2397	24	PFR6Q	6458
Polo 3 (Typ 6..)	1.6	92	11.99 - 09.01	ARC	4	1,0	BKUR6ET-10	2397	24	PFR6Q	6458
Polo 3 (Typ 6..)	1.6	92	05.00 - 09.01	AVY	4	1,0	BKUR6ET-10	2397	24	PFR6Q	6458
Polo 3 (Typ 6..) SDI	1.7	42	04.97 - 12.99	AHG	4	█	Y-732U	2408		D-POWER 4	6001
Polo 3 (Typ 6..) SDI	1.7	42	08.97 - 04.00	AKU	3	█	Y-732U	2408		D-POWER 4	6001
Polo 3 (Typ 6..) SDI	1.7	44	11.97 - 08.99	AKW	4	█	Y-732U	2408		D-POWER 4	6001
Polo 3 (Typ 6..) Classic	1.8	66	03.98 - 09.01	ADD	4	0,8	BUR6ET	3172	1	PGR6D	6248

<sup>1)</sup> Bic = Best in class



l kW

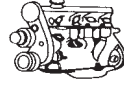

Cyl.

Order-  
No. No.Bic<sup>1)</sup> Order-  
D-Power No.

VW

Polo 3 (Typ 6...) SDI	1.9	47	07.96 - 09.01	AGD	4	☑	Y-732U	2408		D-POWER 4	6001
Polo 3 (Typ 6...) SDI	1.9	47	10.99 - 09.01	ASX	4	☑	Y-732U	2408		D-POWER 4	6001
Polo 3 (Typ 6...)	1.9	47	12.95 - 08.99	AEY	4	☑	Y-732U	2408		D-POWER 4	6001
Polo 3 (Typ 6...)	1.9	47	10.94 - 12.99	AEF	4	☑	Y-918R	4182		D-POWER 2	6285
Polo 3 (Typ 6...)	1.9	47	01.96 - 10.96	1Y	4	☑	Y-918R	4182		D-POWER 2	6285
Polo 3 (Typ 6...) SDI	1.9	50	10.99 - 09.01	AQM	4	☑	Y-732U	2408		D-POWER 4	6001
Polo 3 (Typ 6...) SDI	1.9	50	10.99 - 09.01	AGP	4	☑	Y-732U	2408		D-POWER 4	6001
Polo 3 (Typ 6...) TDI	1.9	66	10.99 - 09.01	ALH	4	☑	Y-732U	2408		D-POWER 4	6001
Polo 3 (Typ 6...) TDI	1.9	66	10.99 - 09.01	AGR	4	☑	Y-732U	2408		D-POWER 4	6001
Polo 3 (Typ 6...) TDI	1.9	66	01.97 - 08.99	AHU	4	☑	Y-732U	2408		D-POWER 4	6001
Polo 3 (Typ 6...) TDI	1.9	66	11.97 - 08.99	ALE	4	☑	Y-732U	2408		D-POWER 4	6001
Polo 3 (Typ 6...) TDI	1.9	81	06.98 - 08.99	AFN	4	☑	Y-732U	2408		D-POWER 4	6001
Polo 3 (Typ 6...) TDI	1.9	81	10.99 - 09.01	ASV	4	☑	Y-732U	2408		D-POWER 4	6001
Polo 3 (Typ 6...) (Mex)	2.0	85	08.99 - 09.01	ADC	4		BKR5EVX	2546		BKR5EIX	6341
Polo 4 (Typ 9N )	1.2	40	01.02 - 05.04	AWY	3	0,9	ZFR5P-G	6893			
Polo 4 (Typ 9N )	1.2	40	05.04 -	BMD	3	0,9	ZFR5P-G	6893			
Polo 4 (Typ 9N )	1.2	47	11.04 - 07.07	BME	3	0,9	ZFR5P-G	6893			
Polo 4 (Typ 9N ) 12V	1.2	47	11.01 - 05.04	AZQ	3	0,9	ZFR5P-G	6893			
Polo 4 (Typ 9N ) TDI	1.4	51	04.05 -	BNM	3	☑	Y-741U	5065		D-POWER 20	6943
Polo 4 (Typ 9N ) TDI	1.4	51	05.06 -	BWB	3	☑	CZ101				
Polo 4 (Typ 9N ) TDI	1.4	55	11.01 - 05.05	BAY	3	☑	Y-732U	2408		D-POWER 4	6001
Polo 4 (Typ 9N ) 16V Automatic	1.4	55	11.01 - 05.04	BBY	4	1,1	PZFR5D-11	7968	34		
Polo 4 (Typ 9N ) 16V	1.4	55	11.01 - 05.04	BBY	4	1,0	BKUR6ET-10	2397	24	PFR6Q	6458
Polo 4 (Typ 9N ) 16V	1.4	55	04.05 - 07.07	BKY	4	0,9	ZFR5P-G	6893			
Polo 4 (Typ 9N ) TDI	1.4	58	04.05 -	BNV	3	☑	Y-741U	5065		D-POWER 20	6943
Polo 4 (Typ 9N ) TDI	1.4	59	10.05 -	BMS	3	☑	CZ101				
Polo 4 (Typ 9N )	1.4	59	05.06 -	BUD	4	1,1	ZFR6T-11G	5960			
Polo 4 (Typ 9N ) FSI	1.4	63	02.02 - 07.06	AXU	4		ZFR6S-Q	6449			
Polo 4 (Typ 9N ) 16V	1.4	74	05.02 -	BBZ	4	1,0	BKUR6ET-10	2397	24	PFR6Q	6458
Polo 4 (Typ 9N )	1.6	77	05.06 -	BTS	4	1,1	ZFR6T-11G	5960			
Polo 4 (Typ 9N ) GTI	1.8	110	09.05 -	BJX	4	0,8	PFR6Q	6458			
Polo 4 (Typ 9N ) GTI	1.8	132	05.06 -	BBU	4	0,8	PFR6Q	6458			
Polo 4 (Typ 9N ) SDI	1.9	47	11.01 -	ASY	4	☑	Y-732U	2408		D-POWER 4	6001
Polo 4 (Typ 9N ) TDI	1.9	74	11.01 -	ATD	4	☑	Y-741U	5065		D-POWER 20	6943
Polo 4 (Typ 9N ) TDI	1.9	74	11.01 -	AXR	4	☑	Y-741U	5065		D-POWER 20	6943
Polo 4 (Typ 9N ) TDI	1.9	96	05.04 -	BLT	4	☑	Y-741U	5065		D-POWER 20	6943
Polo 4 (Typ 9N ) TDI	1.9	96	11.03 -	ASZ	4	☑	Y-741U	5065		D-POWER 20	6943
Scirocco	1.6	53	04.86 - 07.90	RE	4	1,0	BUR5ET-10	7264	21	PGR6D	6248
Scirocco	1.6	55	01.83 - 07.91	EW	4	1,0	BUR5ET-10	7264	21	PGR6D	6248
Scirocco	1.8	66	08.83 - 07.92	EX	4	0,8	BUR6ET	3172	1	PGR6D	6248
Scirocco	1.8	70	08.83 - 07.92	JH	4	0,8	BUR6ET	3172	1	PGR6D	6248
Scirocco	1.8	82	08.82 - 07.91	JJ	4	0,8	BUR6ET	3172	1	PGR6D	6248
Scirocco	1.8	82	08.83 - 07.91	KT	4	0,8	BUR6ET	3172	1	PGR6D	6248
Scirocco	1.8	82	08.82 - 07.92	DX	4	0,8	BUR6ET	3172	1	PGR6D	6248
Scirocco	1.8	95	02.86 - 07.92	PL	4	0,8	BKUR7ET	7873		PFR7Q	7963
Scirocco 16V	1.8	102	08.84 - 07.89	KR	4	0,8	BCP7ET	2078		BCPR7EIX	5690
Sharan turbo	1.8	110	11.97 - 02.00	AJH	4	0,8	PFR6Q	6458			
Sharan TDI	1.9	66	03.99 -	ANU	4	☑	Y-741U	5065		D-POWER 20	6943
Sharan TDI	1.9	66	09.95 - 07.96	1Z	4	☑	Y-732U	2408		D-POWER 4	6001
Sharan TDI	1.9	66	08.96 - 02.00	AHU	4	☑	Y-732U	2408		D-POWER 4	6001
Sharan TDI	1.9	81	02.96 - 07.99	AFN	4	☑	Y-732U	2408		D-POWER 4	6001
Sharan TDI	1.9	81	08.99 - 02.00	AVG	4	☑	Y-732U	2408		D-POWER 4	6001

<sup>1)</sup> Bic = Best in class



ℓ kW

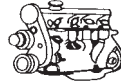

Cyl.

Order-  
No. No.Bic<sup>1)</sup> Order-  
D-Power No.**VW**

Sharan TDI	1.9	85	04.00 -	AUY	4	█	Y-741U	5065		D-POWER 20	6943
Sharan TDI	1.9	96	11.02 -	ASZ	4	█	Y-741U	5065		D-POWER 20	6943
Sharan	2.0	85	09.95 - 02.00	ADY	4	0,8	BKUR6ET-10	2397	27	PFR6Q	6458
Sharan VR6	2.8	128	09.95 - 03.98	AAA	6	0,8	BKR5EKUP	2890			
Sharan VR6	2.8	128	04.98 - 02.00	AMY	6	0,8	BKR5EKUP	2890			
Sharan / 2	1.8	110	04.00 - 05.05	AWC	4	0,8	PFR6Q	6458			
Sharan / 2 TDI	1.9	85	11.05 -	BVK	4	█	Y-741U	5065		D-POWER 20	6943
Sharan / 2	1.9	110	01.05 - 06.06	BTB	4	█	Y-741U	5065		D-POWER 20	6943
Sharan / 2	2.0	85	04.00 -	ATM	4	1,0	BKUR6ET-10	2397	24	PFR6Q	6458
Sharan / 2 TDI	2.0	100	11.05 -	BVH	4	█	CZ101				
Sharan / 2 TDI	2.0	103	11.05 -	BRT	4	█	CZ101				
Sharan VR6 / 2	2.8	150	04.00 -	AYL	6	1,1	PZFR5D-11	7968	34		
T 2 D	1.6	37	01.81 - 08.90	CS	4	█	Y-918R	4182		D-POWER 2	6285
T 2	1.7	42	10.86 - 08.90		4	█	Y-918R	4182		D-POWER 2	6285
T 3	1.7	31	10.86 - 07.92	KY	4	█	Y-918R	4182		D-POWER 2	6285
T 4 D	1.9	44	09.90 - 12.95	1X	4	█	Y-918R	4182		D-POWER 2	6285
T 4 TD	1.9	50	10.92 - 04.02	ABL	4	█	Y-918R	4182		D-POWER 2	6285
T 4	2.0	62	09.90 - 06.03	AAC	4	0,8	BUR5ET	3377	22	PGR6D	6248
T 4	2.4	55	04.97 - 06.03	AJA	5	█	Y-918R	4182		D-POWER 2	6285
T 4 D	2.4	57	09.90 - 04.98	AAB	5	█	Y-918R	4182		D-POWER 2	6285
T 4	2.5	65	10.01 - 09.03	AYY	5	█	Y-732U	2408		D-POWER 4	6001
T 4	2.5	65	05.98 - 09.03	AJT	5	█	Y-732U	2408		D-POWER 4	6001
T 4	2.5	75	04.01 - 09.03	AXL	5	█	Y-732U	2408		D-POWER 4	6001
T 4 TDI	2.5	75	09.95 - 06.03	ACV	5	█	Y-732U	2408		D-POWER 4	6001
T 4 TDI	2.5	75	04.01 - 09.03	AYC	5	█	Y-732U	2408		D-POWER 4	6001
T 4	2.5	75	11.99 - 09.03	AUF	5	█	Y-732U	2408		D-POWER 4	6001
T 4	2.5	81	05.95 - 12.95	AEN	5	0,8	BUR5ET	3377	22	PGR6D	6248
T 4	2.5	81	08.96 - 09.03	AET	5	0,8	BUR5ET	3377	22	PGR6D	6248
T 4 (China / GUS)	2.5	81	08.96 - 06.03	AEU	5	0,8	BUR5ET	3377	22	PGR6D	6248
T 4	2.5	81	09.90 - 12.93	AAF	5	0,8	BPR5EKU	5685		PGR6D	6248
T 4	2.5	81	08.93 - 10.96	ACU	5	0,8	BUR5ET	3377	22	PGR6D	6248
T 4	2.5	85	12.99 - 06.03	AVT	5	0,9	BKUR5ET	2789	29	PFR6Q	6458
T 4	2.5	85	05.99 - 12.99	APL	5	0,9	BKUR5ET	2789	29	PFR6Q	6458
T 4 TDI	2.5	111	09.00 - 09.03	AXG	5	█	Y-732U	2408		D-POWER 4	6001
T 4	2.5	111	07.99 - 09.00	AHY	5	█	Y-732U	2408		D-POWER 4	6001
T 4 VR6	2.8	103	01.96 - 05.00	AES	6	0,8	BKR5EKUP	2890			
T 5 TDI	1.9	62	01.06 - 05.07	BRR	4	█	Y-607AS	9776		D-POWER 50	
T 5 TDI	1.9	75	01.06 - 05.07	BRS	4	█	Y-607AS	9776		D-POWER 50	
T 5	2.3	125	00 -		5	1,1	PZFR5D-11	7968	34		
T 5 TDI	2.5	96	01.06 - 05.07	BNZ	5	█	CZ101				
T 5 TDI	2.5	128	04.03 - 05.07	AXE	5	█	Y-741U	5065		D-POWER 20	6943
T 5 TDI	2.5	128	01.06 - 05.07	BPC	5	█	CZ101				
T 5 VR6 ( USA )	2.8	150	05.00 - 06.03	AXK	6	1,1	PZFR5D-11	7968	34		
T 5	3.2	170	02.04 - 05.07	BDL	6	0,9	IZKR7B	7563			
T 5	3.2	173	02.04 - 05.07	BKK	6	0,9	IZKR7B	7563			
Taro	1.8	61	02.89 - 09.94	2Y	4	1,1	BPR5EY-11	3028		BPR5EIX-11	2115
Taro	2.2	69	06.89 - 07.94	4Y	4	1,1	BPR5EY-11	3028		BPR5EIX-11	2115
Touareg TDI	2.5	120	01.06 -	BPD	5	█	CZ101				
Touareg TDI	2.5	120	07.03 - 11.06	BLK	5	█	Y-741U	5065		D-POWER 20	6943
Touareg TDI	2.5	128	01.06 -	BPE	5	█	CZ101				
Touareg TDI	2.5	128	01.03 - 11.06	BAC	5	█	Y-741U	5065		D-POWER 20	6943
Touareg TDI	3.0	155	04.06 -	BUN	6	█	Y-609AS	5849		D-POWER 49	5849

<sup>1)</sup> Bic = Best in class



ℓ kW

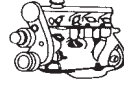

Cyl.

Order-  
No. No.Bic<sup>1)</sup> Order-  
D-Power No.

VW

Touareg TDI	3.0	165	11.04-	BKS	6	☑	Y-609AS	5849			D-POWER 49	5849
Touareg	3.2	162	05.04-11.06	BMV	6	0,9	IZKR7B	7563				
Touareg	3.2	162	05.04-11.06	BMX	6	0,9	IZKR7B	7563				
Touareg	3.2	162	11.02-05.04	AZZ	6	0,9	IZKR7B	7563				
Touareg USA	3.2	162	08.03-05.04	BAA	6	0,9	IZKR7B	7563				
Touareg	3.2	162	05.03-05.04	BKJ	6	0,9	IZKR7B	7563				
Touareg	3.2	162	05.04-05.06	BRJ	6		ZKR7AP-Q					
Touareg FSI	3.6	206	10.05-	BHK	6	0,9	ILZKR7A	1961				
Touareg	4.2	228	12.02-11.06	AXQ	8		BKR6EQUA	6872				
Touareg	4.2	258	12.06-	BAR	8	0,9	PFR6W-T					
Touareg TDI	4.9	230	11.04-	BLE	10	☑	CZ101					
Touareg TDI	5.0	230	11.02-11.06	AYH	10	☑	Y-741U	5065			D-POWER 20	6943
Touareg WR12	6.0	316	08.04-	BJN	12	1,1	PZFR6J-11	3586				
Touran FSI	1.4	103	02.06-	BMV	4	0,9	PZFR6R					
Touran FSI	1.4	125	11.06-	BLG	4	0,9	PZFR6R					
Touran	1.6	75	07.03-05.05	BGU	4	1,0	BKUR6ET-10	2397	24	PFR6Q		6458
Touran	1.6	75	06.05-	BSE	4	1,0	BKUR6ET-10	2397	24	PFR6Q		6458
Touran	1.6	75	06.05-	BSF	4	1,0	BKUR6ET-10	2397	24	PFR6Q		6458
Touran FSI	1.6	85	05.04-05.05	BLP	4		ZFR6S-Q	6449				
Touran FSI	1.6	85	02.03-05.04	BAG	4		ZFR6S-Q	6449				
Touran FSI	1.6	85	02.05-01.07	BLF	4		ZFR6S-Q	6449				
Touran TDI	1.9	66	06.06-	BXJ	4	☑	Y-607AS	9776			D-POWER 50	
Touran TDI	1.9	66	02.06-	BXF	4	☑	Y-607AS	9776			D-POWER 50	
Touran TDI	1.9	66	11.04-02.06	BRU	4	☑	Y-607AS	9776			D-POWER 50	
Touran TDI	1.9	74	02.03-05.04	AVQ	4	☑	Y-607AS	9776			D-POWER 50	
Touran TDI	1.9	77	08.03-02.06	BKC	4	☑	Y-607AS	9776			D-POWER 50	
Touran TDI	1.9	77	02.06-	BXE	4	☑	Y-607AS	9776			D-POWER 50	
Touran TDI	1.9	77	06.05-	BLS	4	☑	Y-607AS	9776			D-POWER 50	
Touran	2.0	80	02.06-	BSX	4	0,9	BKR6E	6962	28	BKR6EIX		6418
Touran TDI 16V	2.0	100	02.03-	AZV	4	☑	YE14	7768			D-POWER 48	7768
Touran TDI	2.0	103	08.03-	BKD	4	☑	YE14	7768			D-POWER 48	7768
Touran TDI	2.0	103	12.05-	BMM	4	☑	Y-607AS	9776			D-POWER 50	
Touran FSI	2.0	110	05.04-11.05	BLY	4	0,9	BKR6E	6962	28	BKR6EIX		6418
Touran FSI	2.0	110	11.05-01.07	BVY	4	1,1	PZFR5N-11T	7742				
Touran FSI	2.0	110	11.05-01.07	BVZ	4	0,9	BKR6E	6962	28	BKR6EIX		6418
Touran FSI	2.0	110	05.04-11.05	BLX	4	1,1	PZFR5N-11T	7742				
Touran FSI	2.0	110	10.03-05.04	AXW	4	1,1	PZFR5N-11T	7742				
Touran FSI	2.0	110	10.03-01.04	BHD	4	1,1	PZFR5N-11T	7742				
Touran FSI	2.0	110	02.05-11.05	BLR	4	1,1	PZFR5N-11T	7742				
Touran TDI	2.0	125	12.05-	BMN	4	☑	CZ301					
Transporter	1.8	49	09.90-07.92	PD	4	0,8	BUR6ET	3172	1	PGR6D		6248
Transporter 2 (MEXICO)	1.8	63	01.93-	ACB	4	0,8	BP5ES	6511	8	BPR5EIX		6597
Transporter	1.9	44	08.87-07.89	DF	4	0,7	BP6ESZ	7639			PGR6D	6248
Transporter	1.9	44	08.89-07.92	DF	4	0,8	BUR6ET	3172	1	PGR6D		6248
Transporter	1.9	54	08.87-07.89	SP	4	0,7	BP6ESZ	7639			PGR6D	6248
Transporter TDI	1.9	63	04.03-05.07	AXC	4	☑	Y-741U	5065			D-POWER 20	6943
Transporter TDI	1.9	77	04.03-05.07	AXB	4	☑	Y-741U	5065			D-POWER 20	6943
Transporter	2.0	85	11.03-05.07	AXA	4	1,0	BKUR6ET-10	2397	24	PFR6Q		6458
Transporter	2.1	64	08.86-07.92	SR	4	0,7	B6ES	7310				
Transporter	2.1	68	08.85-07.92	SS	4	0,7	B6ES	7310				
Transporter	2.1	70	08.85-07.92	MV	4	0,7	B6ES	7310				
Transporter	2.1	82	08.84-07.92	DJ	4	0,8	BUR6ET	3172	1	PGR6D		6248

<sup>1)</sup> Bic = Best in class



ℓ kW

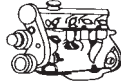

Cyl.

Order-  
No. No.Bic<sup>1)</sup> Order-  
D-Power No.**VW**

Transporter TDI	2.5	96	04.03 - 05.07	AXD	5	█	Y-741U	5065		D-POWER 20	6943
Transporter	2.5	120	11.03 - 05.07	BLJ	5	█	Y-741U	5065		D-POWER 20	6943
Transporter	2.8	150	05.00 - 09.03	AMV	6	1,1	PZFR5D-11	7968	34		
Vento SDI	1.9	47	07.95 - 12.97	AEY	4	█	Y-732U	2408		D-POWER 4	6001
Vento D	1.9	47	01.92 - 12.97	1Y	4	█	Y-918R	4182		D-POWER 2	6285
Vento TD	1.9	55	01.92 - 12.97	AAZ	4	█	Y-918R	4182		D-POWER 2	6285
Vento TDI	1.9	66	08.96 - 12.97	AHU	4	█	Y-732U	2408		D-POWER 4	6001
Vento TDI	1.9	66	07.93 - 07.96	1Z	4	█	Y-732U	2408		D-POWER 4	6001
Vento TDI	1.9	81	02.96 - 12.97	AFN	4	█	Y-732U	2408		D-POWER 4	6001

**WARSZAWA**

14mm					4	0,6	B6L	3212			
18mm					4	0,6	A7	1110			

**WARTBURG AWE**

1.3	1.3	43	09.88 - 05.91	VW	4	0,7	BP6ES	7811	4	BPR6EIX	6637
353	1.0	37	01.78 - 12.90		4	0,6	B6HS	4510		BR6HIX	3419
Alle Modelle 14mm	1.0		71 -		4	0,6	B6HS	4510		BR6HIX	3419
Alle Modelle 18mm	1.0	37	07.71 - 09.89		4	0,6	A7	1110			

**WIESMANN**

Coupè GT	4.8	270	09.05 -	N62 B48	8	1,1	IZFR6H11	4294			
Roadster MF28	2.8	142	95 -	M52 B28	6	0,8	BKR6EK	2288	20	BKR6EQUIP	3199
Roadster MF3	3.2	236	95 -	S50 B32	6	0,7	PKR7A	3641			

**YALTA**

3A3	1.0				4	0,6	B6HS	4510		BR6HIX	3419
Saporodshe					4	0,6	B6L	3212			

**YUGO**

101 1.1, 1.3					4	0,6	BP6ES	7811	4	BPR6EIX	6637
311 / 313					4	0,7	BP6ES	7811	4	BPR6EIX	6637
411 / 413					4	0,7	BP6ES	7811	4	BPR6EIX	6637
511 / 513					4	0,7	BP6ES	7811	4	BPR6EIX	6637
Florida 1.4, 1.5, 1.6			- 12.93		4	0,6	BPR6ES	7822	2	BPR6EIX	6637
Sana					4	0,8	BPR6ES	7822	2	BPR6EIX	6637
Tempo					4	0,8	BPR6ES	7822	2	BPR6EIX	6637
Yugo 45,55,65,Florida			80 -		4	0,7	BP6ES	7811	4	BPR6EIX	6637

**Z.A.Z.**

1102 Tawrija	1.1	37	06.90 -		4	0,7	BP6ES	7811	4	BPR6EIX	6637
1102 Tawrija	1.3	44	06.90 -		4	0,7	BP6ES	7811	4	BPR6EIX	6637
Megane kombi	1.1	37	06.90 -		4	0,7	BP6ES	7811	4	BPR6EIX	6637

**ZASTAVA**

45			01.82 -		4	0,7	BP6ES	7811	4	BPR6EIX	6637
55			82 -		4	0,7	BP6ES	7811	4	BPR6EIX	6637
60			82 -		4	0,7	BP6ES	7811	4	BPR6EIX	6637
65			82 -		4	0,7	BP6ES	7811	4	BPR6EIX	6637
65 EFI	1.3		89 -		4	0,8	BPR6ES	7822	2	BPR6EIX	6637
65 Skala			72 -		4	0,7	BP6ES	7811	4	BPR6EIX	6637
311					4	0,7	BP6ES	7811	4	BPR6EIX	6637

<sup>1)</sup> Bic = Best in class



l kW

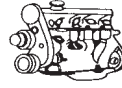

Cyl.

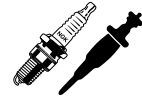

Order-  
No. No.



Bic<sup>1)</sup> Order-  
D-Power No.

**ZASTAVA**

313					4	0,7	BP6ES	7811	4	BPR6EIX	6637
411					4	0,7	BP6ES	7811	4	BPR6EIX	6637
413					4	0,7	BP6ES	7811	4	BPR6EIX	6637
511					4	0,7	BP6ES	7811	4	BPR6EIX	6637
513					4	0,7	BP6ES	7811	4	BPR6EIX	6637
750			78-		4	0,6	BP6HS	4511	18	BPR6HIX	4085
850			78-		4	0,6	BP6HS	4511	18	BPR6HIX	4085
Florida	1.4	48	07.89 - 12.93		4	0,8	BPR6ES	7822	2	BPR6EIX	6637
Florida	1.6	62	07.89 - 12.93		4	0,8	BPR6ES	7822	2	BPR6EIX	6637
Florida EFI	1.4	53	10.88 - 12.93		4	0,8	BPR6ES	7822	2	BPR6EIX	6637
Sana	1.4	53	89-		4	0,8	BPR6ES	7822	2	BPR6EIX	6637

**ZUK**

Transport	2.4	51		C90	4	☑	Y-403T	7494			
Transport	2.4	68		CT90	4	☑	Y-403T	7494			

<sup>1)</sup> Bic = Best in class



Order  
No.Platin  
Gold-  
Palla-  
diumOrder Quick  
No. No.

Iridium

Order  
No.**ACCOSSATO**

Enduro Unitrac	50	03.74 -	B6ES	7310	0,7	B6EVX	5136			
CR 80 Cross/Enduro	80				0,5	B9EGV	5827			

**ADLER**

Junior MR 100	100		B8HS	5510	0,5	B8HVX	2634	205	BR8HIX	7001
M 100	100		B8HS	5510	0,5	B8HVX	2634	205	BR8HIX	7001
M 125	125		B8HS	5510	0,5	B8HVX	2634	205	BR8HIX	7001
MB 150	150		B8HS	5510	0,5	B8HVX	2634	205	BR8HIX	7001
MB 200	200		B7HS	5110	0,5	B7HVX	7836	204	BR7HIX	7067
MB 201	200		B7HS	5110	0,5	B7HVX	7836	204	BR7HIX	7067
MB 250	250		B7HS	5110	0,5	B7HVX	7836	204	BR7HIX	7067
MB 250 Favorit	250		B8HS	5510	0,5	B8HVX	2634	205	BR8HIX	7001

**AJP**

Enduro 125	125	03 -	DR8ES	5423	0,8	DR8EVX	6354	217	DR8EIX	6681
Super-Moto 125	125	03 -	DR8ES	5423	0,8	DR8EVX	6354	217	DR8EIX	6681
Enduro 200	200	03 -	DR8ES	5423	0,8	DR8EVX	6354	217	DR8EIX	6681
Super-Moto 200	200	03 -	DR8ES	5423	0,8	DR8EVX	6354	217	DR8EIX	6681
P 250 Cross	250	04 -	CR8EB	7784	0,6	CR8EVX	6487		CR8EIX	4218

**ALFER**

GR 30, TX 30	50		BR8HS	4322	0,6	BR8HVX	6265	212	BR8HIX	7001
MC 80	80				0,5	B9EGV	5827			
GR125 ISDE	125				0,5	B8EGV	5627			
MC 125	125				0,5	B9EGV	5827			
VRE 125 (4T)	125		CR9E	6263	0,7	CR9EVX	5943	227	CR9EIX	3521
VRE 125 no limit (4T)	125		CR9E	6263	0,7	CR9EVX	5943	227	CR9EIX	3521
EGR 250 Agua / Air	250		B8ES	2411	0,5	B8EGV	5627	201	BR8EIX	5044
MC 250	250				0,5	B9EGV	5827			
VR 250 (2T)	250		BR8ES	5422	0,8	BR8EVX	1262	207	BR8EIX	5044
VR 250 no limit Supermoto (2T)	250		BR8ES	5422	0,8	BR8EVX	1262	207	BR8EIX	5044
AR-1	300		B8ES	2411	0,5	B8EVX	7051	201	BR8EIX	5044
GR 300 Agua	300		B8ES	2411	0,5	B8EGV	5627	201	BR8EIX	5044
TX-300	300		B8ES	2411	0,5	B8EGV	5627	201	BR8EIX	5044
MC 500	490				0,5	B9EGV	5827			

**AMERICAN IRON HORSE**

Bandit ST	1573	99 - 02	BPR5ES-11	3524	1,0	BCPR5EVX-11	2372		BCPR5EIX-11	3306
Classic SX	1573	99 - 02	BPR5ES-11	3524	1,0	BCPR5EVX-11	2372		BCPR5EIX-11	3306
Legend SC	1573	99 - 02	BPR5ES-11	3524	1,0	BCPR5EVX-11	2372		BCPR5EIX-11	3306
Outlaw SY	1573	99 - 02	BPR5ES-11	3524	1,0	BCPR5EVX-11	2372		BCPR5EIX-11	3306
Slammer SZ	1573	99 - 02	BPR5ES-11	3524	1,0	BCPR5EVX-11	2372		BCPR5EIX-11	3306
Stalker SR	1573	99 - 02	BPR5ES-11	3524	1,0	BCPR5EVX-11	2372		BCPR5EIX-11	3306
Thunder SW	1573	99 - 02	BPR5ES-11	3524	1,0	BCPR5EVX-11	2372		BCPR5EIX-11	3306
Bandit ST	1753	99 - 03	BPR5ES-11	3524	1,0	BCPR5EVX-11	2372		BCPR5EIX-11	3306
Classic SX	1753	99 - 03	BPR5ES-11	3524	1,0	BCPR5EVX-11	2372		BCPR5EIX-11	3306
Legend SC	1753	99 - 03	BPR5ES-11	3524	1,0	BCPR5EVX-11	2372		BCPR5EIX-11	3306
Outlaw SY	1753	99 - 03	BPR5ES-11	3524	1,0	BCPR5EVX-11	2372		BCPR5EIX-11	3306
Slammer SZ	1753	99 - 03	BPR5ES-11	3524	1,0	BCPR5EVX-11	2372		BCPR5EIX-11	3306
Stalker SR	1753	99 - 03	BPR5ES-11	3524	1,0	BCPR5EVX-11	2372		BCPR5EIX-11	3306
Thunder SW	1753	99 - 03	BPR5ES-11	3524	1,0	BCPR5EVX-11	2372		BCPR5EIX-11	3306
Legend SC	1819	04 -	DCPR7E	3932	1,0	DCPR7EVX	1179		DCPR7EIX	6046

Order  
No.Platin  
Gold-  
Palla-  
diumOrder Quick  
No. No.Order  
No.**AMERICAN IRON HORSE**

LSC	1819	04 -	DCPR7E	3932	1,0	DCPR7EVX	1179		DCPR7EIX	6046
Outlaw SY	1819	04 -	DCPR7E	3932	1,0	DCPR7EVX	1179		DCPR7EIX	6046
Slammer SZ	1819	04 -	DCPR7E	3932	1,0	DCPR7EVX	1179		DCPR7EIX	6046
Stalker SR	1819	04 -	DCPR7E	3932	1,0	DCPR7EVX	1179		DCPR7EIX	6046
Tejas SJ	1819	04 -	DCPR7E	3932	1,0	DCPR7EVX	1179		DCPR7EIX	6046
Texas Chopper SX	1819	04 -	DCPR7E	3932	1,0	DCPR7EVX	1179		DCPR7EIX	6046
Bandit ST	1852	99 - 03	BPR5ES-11	3524	1,0	BCPR5EVX-11	2372		BCPR5EIX-11	3306
Classic SX	1852	99 - 03	BPR5ES-11	3524	1,0	BCPR5EVX-11	2372		BCPR5EIX-11	3306
Legend SC	1852	99 - 03	BPR5ES-11	3524	1,0	BCPR5EVX-11	2372		BCPR5EIX-11	3306
Outlaw SY	1852	99 - 03	BPR5ES-11	3524	1,0	BCPR5EVX-11	2372		BCPR5EIX-11	3306
Slammer SZ	1852	99 - 03	BPR5ES-11	3524	1,0	BCPR5EVX-11	2372		BCPR5EIX-11	3306
Stalker SR	1852	99 - 03	BPR5ES-11	3524	1,0	BCPR5EVX-11	2372		BCPR5EIX-11	3306
Thunder SW	1852	99 - 03	BPR5ES-11	3524	1,0	BCPR5EVX-11	2372		BCPR5EIX-11	3306
Legend SC	1918	04 -	DCPR7E	3932	1,0	DCPR7EVX	1179		DCPR7EIX	6046
Outlaw SY	1918	04 -	DCPR7E	3932	1,0	DCPR7EVX	1179		DCPR7EIX	6046
Slammer SZ	1918	04 -	DCPR7E	3932	1,0	DCPR7EVX	1179		DCPR7EIX	6046
Stalker SR	1918	04 -	DCPR7E	3932	1,0	DCPR7EVX	1179		DCPR7EIX	6046
Tejas SJ	1918	04 -	DCPR7E	3932	1,0	DCPR7EVX	1179		DCPR7EIX	6046
Texas Chopper SX	1918	04 -	DCPR7E	3932	1,0	DCPR7EVX	1179		DCPR7EIX	6046
Legend SC	2033	03 - 04	DCPR7E	3932	1,0	DCPR7EVX	1179		DCPR7EIX	6046
Outlaw SY	2033	03 - 04	DCPR7E	3932	1,0	DCPR7EVX	1179		DCPR7EIX	6046
Ranger T SG	2033	03 -	DCPR7E	3932	1,0	DCPR7EVX	1179		DCPR7EIX	6046
Slammer SZ	2033	03 - 04	DCPR7E	3932	1,0	DCPR7EVX	1179		DCPR7EIX	6046
Stalker SR	2033	03 - 04	DCPR7E	3932	1,0	DCPR7EVX	1179		DCPR7EIX	6046
Tejas SJ	2033	03 - 04	DCPR7E	3932	1,0	DCPR7EVX	1179		DCPR7EIX	6046
Texas Chopper SX	2033	03 - 04	DCPR7E	3932	1,0	DCPR7EVX	1179		DCPR7EIX	6046

**APRILIA**

AF1 50	50	01.86 -	B9ES	2611	0,5	B9EVX	7254	202	BR9EIX	3981
Classic 50 (Gl)	50	99 -	BR8ES	5422	0,8	BR8EVX	1262	207	BR8EIX	5044
ET 50 AE,-Fire	50	01.87 -	B9ES	2611	0,5	B9EVX	7254	202	BR9EIX	3981
GL 50	50	02.93 -	B9ES	2611	0,5	B9EVX	7254	202	BR9EIX	3981
LX 50	50	02.93 -	B9ES	2611	0,5	B9EVX	7254	202	BR9EIX	3981
MX 50 (RX50) (ST)	50	03 -	BR8ES	5422	0,8	BR8EVX	1262	207	BR8EIX	5044
RC 50	50	01.79-12.82	B6ES	7310	0,6	B6EVX	5136			
Red Rose 50	50	06.87 -	B9ES	2611	0,5	B9EVX	7254	202	BR9EIX	3981
RS 50 (SE)	50	01.97 -	BR8ES	5422	0,8	BR8EVX	1262	207	BR8EIX	5044
RS 50 (PG)	50	01.97 -	BR8ES	5422	0,8	BR8EVX	1262	207	BR8EIX	5044
RS 50 Extrema / Replica	50	01.93 -	B8ES	2411	0,5	B8EGV	5627	201	BR8EIX	5044
RX 50	50	09.90 -	B9ES	2611	0,5	B9EVX	7254	202	BR9EIX	3981
Tuareg 50	50	01.87 -	B9ES	2611	0,5	B9EVX	7254	202	BR9EIX	3981
AF 1 Futura	125	06.90 -	B10EG	3630	0,5	B10EGV	5927			
AF 1 Sport	125	06.90 -	B10EG	3630	0,5	B10EGV	5927			
AF1 125 Replica 89	125	03.87 -	B10EG	3630	0,6	B10EGV	5927			
AF1 125, RR, Sintesi	125	06.88 -	B10EG	3630	0,5	B10EGV	5927			
AS 125 R	125	01.91 -	B9ES	2611	0,5	B9EVX	7254	202	BR9EIX	3981
Classic 125	125	97 - 98			0,6	BR10EG	3830			
Classic 125 (MF)	125	99 -	BR8ES	5422	0,8	BR8EVX	1262	207	BR8EIX	5044
ETX 125 (PH)	125	99 -	BR8ES	5422	0,8	BR8EVX	1262	207	BR8EIX	5044
ETX 125	125	01.84 - 98	B9ES	2611	0,5	B9EVX	7254	202	BR9EIX	3981
Europa 125	125	06.90 -	B10EG	3630	0,5	B10EGV	5927			
MX 125 (TZ) 18kW	125		BR10EG	3830	0,6					

Order  
No.Platin  
Gold-  
Palla-  
diumOrder Quick  
No. No.

Iridium

Order  
No.**APRILIA**

MX 125 (TZ) 80km/h-11kW	125		BR8ES	5422	0,8	BR8EVX	1262	207	BR8EIX	5044
Pegaso 125	125	01.92 -	B10EG	3630	0,5	B10EGV	5927			
Red Rose 125	125	01.97 -	BR8ES	5422	0,8	BR8EVX	1262	207	BR8EIX	5044
Red Rose 125	125	01.88 -	B10EG	3630	0,5	B10EGV	5927			
RS 125 (MP/SF/PY) (11kW) (80km/h)	125	96 -	BR8ES	5422	0,8	BR8EVX	1262	207	BR8EIX	5044
RS 125 ( MP/MP/PY) (22kW)	125	99 -	BR10EG	3830	0,5					
RS 125 (MP/SF/PY) (18kW)	125	96 -	BR10EG	3830	0,5					
RS 125 Extrema/Repli. 20kW	125	- 93	BR10EG	3830	0,5					
RS 125 Extrema/Repli. 23kW	125	- 93	BR10EG	3830	0,5					
RX 125	125	01.90 -	B10EG	3630	0,5	B10EGV	5927			
ST 125	125	01.82 -	B9EG	3530	0,5	B9EGV	5827		BR9EIX	3981
STX 125	125	01.82 -	B9EG	3530	0,5	B9EGV	5827		BR9EIX	3981
Tuareg	125	01.86 -	B9ES	2611	0,5	B9EVX	7254	202	BR9EIX	3981
Tuareg Rallye	125	06.89 -	B10EG	3630	0,5	B10EGV	5927			
Tuareg Wind 125	125	07.88 -	B9ES	2611	0,6	B9EVX	7254	202	BR9EIX	3981
250 GP (I)	250		B10EG	3630	0,5	B10EGV	5927			
RS 250 ((LD)	250	95 -	BR9ECM	3252	0,5	BR9ECMVX	2434			
RX 250	250	01.85 -04.86	B10EG	3630	0,5	B10EGV	5927			
Tuareg Rally	250	01.85 -	B10EG	3630	0,5	B10EGV	5927			
Climber	276	01.89 -	BP5ES	6511	0,7	BP5EVX	5470		BPR5EIX	6597
TX 300	276	- 84	BP5ES	6511	0,7	BP5EVX	5470		BPR5EIX	6597
TX 311 M	276	- 84	BP5ES	6511	0,7	BP5EVX	5470		BPR5EIX	6597
TXR 312 M	276	- 86	BP5ES	6511	0,5	BP5EVX	5470		BPR5EIX	6597
TL 320	320	- 86	BP5ES	6511	0,5	BP5EVX	5470		BPR5EIX	6597
EXT 350	349	01.85 -	D8EA	2120	0,5	D8EVX	2850	216	DR8EIX	6681
Tuareg 350	349	01.87 - 91	D8EA	2120	0,5	D8EVX	2850	216	DR8EIX	6681
Wind	349	01.87 -	D8EA	2120	0,5	D8EVX	2850	216	DR8EIX	6681
RXV 450 Enduro (VP)	450	06 -	CR8EB	7784	0,6	CR8EVX	6487		CR8EIX	4218
RXV 450 Supermoto (VP)	450	06 -	CR8EB	7784	0,6	CR8EVX	6487		CR8EIX	4218
SXV 450 Supermoto (VS)	450	06 -	CR8EB	7784	0,6	CR8EVX	6487		CR8EIX	4218
RXV 550 Enduro (VP)	550	06 -	CR8EB	7784	0,6	CR8EVX	6487		CR8EIX	4218
RXV 550 Supermoto (VP)	550	06 -	CR8EB	7784	0,6	CR8EVX	6487		CR8EIX	4218
SXV 550 van den Bosch Replica	550	07 -	CR8EB	7784	0,6	CR8EVX	6487		CR8EIX	4218
SXV 550 Supermoto (VS)	550	06 -	CR8EB	7784	0,6	CR8EVX	6487		CR8EIX	4218
Tuareg 600 Wind	562	01.88 - 93	D8EA	2120	0,6	D8EVX	2850	216	DR8EIX	6681
Pegaso 600	600	03.90 - 94	D8EA	2120	0,6	D8EVX	2850	216	DR8EIX	6681
Moto 6.5 (MH)	650	95 -	D8EA	2120	0,6	D8EVX	2850	216	DR8EIX	6681
Pegaso 650(3) (ML) Kat.	650	97 - 00	DR8EA	7162	0,7	DR8EVX	6354		DR8EIX	6681
Pegaso 650 (MX)	650	96 - 00	DR8EA	7162	0,7	DR8EVX	6354		DR8EIX	6681
Pegaso 650 (GA)	650	04.92 - 95	DR8EA	7162	0,7	DR8EVX	6354		DR8EIX	6681
Pegaso 650 Trail (VD)	650	06 -	CR7E	4578	0,6			225	CR7EIX	7385
Pegaso Cube 650	650	97 -	DR8EA	7162	0,7	DR8EVX	6354		DR8EIX	6681
Pegaso 650 i.e. (RW)	650	01 - 03	DR8EB	4855	0,7				DR8EIX	6681
Pegaso 650 Strada (VD)	660	05 -	CR7E	4578	0,6			225	CR7EIX	7385
SL 1000 Falco (PA)	998	99 -	DCPR9E	2641	0,7	DCPR9EVX	6436		DCPR9EIX	2316
ETV 1000 Capo Nord (PS)	1000	01 -	DCPR9E	2641	0,7	DCPR9EVX	6436		DCPR9EIX	2316
RST Futura (PW)	1000	01 -	DCPR9E	2641	0,7	DCPR9EVX	6436		DCPR9EIX	2316
RSV 1000 (MEA/ME)	1000	98 -	DCPR9E	2641	0,7	DCPR9EVX	6436		DCPR9EIX	2316
RSV 1000 SP (MED)	1000	99 -	R0045J-10	7400						
RSV 1000 01 (RP)	1000	01 -	DCPR9E	2641	0,7	DCPR9EVX	6436		DCPR9EIX	2316
RSV 1000 R (RR)	1000		DCPR9E	2641	0,7	DCPR9EVX	6436		DCPR9EIX	2316
RSV 1000 Tuono (RR)	1000	04 -	DCPR9E	2641	0,7	DCPR9EVX	6436		DCPR9EIX	2316

Order  
No.Platin  
Gold-  
Palla-  
diumOrder Quick  
No. No.Order  
No.**APRILIA**

RSV 1000 R Factory (RR)	1000	03 -	DCPR9E	2641	0,7	DCPR9EVX	6436		DCPR9EIX	2316
SL 1000 (PA)	1000	99 -	DCPR9E	2641	0,7	DCPR9EVX	6436		DCPR9EIX	2316
Tuono Fighter 1000	1000	03 -	DCPR9E	2641	0,7	DCPR9EVX	6436		DCPR9EIX	2316
Tuono Fighter R 1000	1000	03 -	DCPR9E	2641	0,7	DCPR9EVX	6436		DCPR9EIX	2316
Tuono (RP)	1000	06 -	DCPR9E	2641	0,7	DCPR9EVX	6436		DCPR9EIX	2316

**ARM**

125 Velocidad Enduro	125				0,5	B10EGV	5927			
125 Cross	125				0,5	B11EGV	5831			
250 Velocidad Enduro/Cross	250				0,5	B9EGV	5827			
365 Enduro	350				0,5	B9EGV	5827			

**AT MOTO**

S 3800 (Velo Solex)	50		B6HS	4510	0,6	B6HVX	7435	203	BR6HIX	3419
---------------------	----	--	------	------	-----	-------	------	-----	--------	------

**ATK**

50 MX	50	99 - 03	B7HS	5110	0,5	B7HVX	7836	204	BR7HIX	7067
50 Mini Cross	50	99 - 01	B7HS	5110	0,5	B7HVX	7836	204	BR7HIX	7067
125 Enduro (Wassergekühlt / Liquid Cooled)	125	03 -	D8EA	2120	0,7	D8EVX	2850	216	DR8EIX	6681
125 (Wassergekühlt / Liquid Cooled)	125	99 - 03	B10ES	7928	0,5	B10EVX	7335		BR10EIX	6801
250 (Luftgekühlt / Air Cooled)	250	88 - 96	B8ES	2411	0,5	B8EVX	7051	201	BR8EIX	5044
250 (Wassergekühlt / Liquid Cooled)	250	95 - 03	B8ES	2411	0,5	B8EVX	7051	201	BR8EIX	5044
260 (Wassergekühlt / Liquid Cooled)	260	95 - 02	B8ES	2411	0,5	B8EVX	7051	201	BR8EIX	5044
350 Enduro 4 Ventil / 4 Stroke SOHC	350	91 - 00	D8EA	2120	0,5	D8EVX	2850	216	DR8EIX	6681
350 Cross Country	350	91 - 99	D8EA	2120	0,7	D8EVX	2850	216	DR8EIX	6681
350 Enduro	350	91 - 02	D8EA	2120	0,7	D8EVX	2850	216	DR8EIX	6681
350 Cross 4 Ventil / 4 Stroke SOHC	350	91 -	D8EA	2120	0,5	D8EVX	2850	216	DR8EIX	6681
406	400	96 - 99	B8ES	2411	0,5	B8EVX	7051	201	BR8EIX	5044
406	400	88 - 96	B8ES	2411	0,5	B8EVX	7051	201	BR8EIX	5044
450 (Luftgekühlt / Air Cooled)	450	03 -	B8ES	2411	0,5	B8EVX	7051	201	BR8EIX	5044
500 DT 4 Ventil / 4 Stroke SOHC	490	99 -	D8EA	2120	0,5	D8EVX	2850	216	DR8EIX	6681
Supermot 4 Ventil / 4 Stroke SOHC	500	01 -	D8EA	2120	0,5	D8EVX	2850	216	DR8EIX	6681
Supermotard	500	01 - 02	D8EA	2120	0,7	D8EVX	2850	216	DR8EIX	6681
500 Enduro	500	98 - 03	D8EA	2120	0,7	D8EVX	2850	216	DR8EIX	6681
500 Dirt Track	500	99 - 03	D8EA	2120	0,7	D8EVX	2850	216	DR8EIX	6681
604 4 Ventil / 4 Stroke SOHC	560	93 -	D8EA	2120	0,5	D8EVX	2850	216	DR8EIX	6681
604	560	88 - 92	D8EA	2120	0,7	D8EVX	2850	216	DR8EIX	6681
600 Dirt Track (Luftgekühlt / Air Cooled)	600	98 - 03	D8EA	2120	0,7	D8EVX	2850	216	DR8EIX	6681
605 Cross 4 Ventil / 4 Stroke SOHC	600	93 -	D8EA	2120	0,5	D8EVX	2850	216	DR8EIX	6681
605 Enduro 4 Ventil / 4 Stroke SOHC	600	93 - 00	D8EA	2120	0,5	D8EVX	2850	216	DR8EIX	6681
605 DT 4 Ventil / 4 Stroke SOHC	600	98 -	D8EA	2120	0,5	D8EVX	2850	216	DR8EIX	6681
Supermot 4 Ventil / 4 Stroke SOHC	600	01 -	D8EA	2120	0,5	D8EVX	2850	216	DR8EIX	6681
605 Cross Country	600	93 - 00	D8EA	2120	0,7	D8EVX	2850	216	DR8EIX	6681
605 Enduro (Luftgekühlt / Air Cooled)	600	93 - 03	D8EA	2120	0,7	D8EVX	2850	216	DR8EIX	6681
Supermotard	600	01 - 02	D8EA	2120	0,7	D8EVX	2850	216	DR8EIX	6681
Supermotard	600	03 -	CR9EK	4548	0,8			230	CR9EIX	3521

**AVIAN**

RM 125 (Tau Motor)	125				0,5	B10EGV	5927			
RM 250 (Tau Motor)	250				0,5	B8EGV	5627			

Order  
No.Platin  
Gold-  
Palla-  
diumOrder Quick  
No. No.

Iridium

Order  
No.**AWO**

425 T	425	56 -	B7HS	5110	0,5	B7HVX	7836	204	BR7HIX	7067
-------	-----	------	------	------	-----	-------	------	-----	--------	------

**B.S.A**

Tracker	125		B8ES	2411	0,5	B8EVX	7051	201	BR8EIX	5044
Bantam 175, Bushman	175		B7ES	1111	0,5	B7EVX	6934			
Bantam D10, 14, 14/4, 14/5	175		B7ES	1111	0,5	B7EVX	6934			
Tracker	175		B8ES	2411	0,5	B8EVX	7051	201	BR8EIX	5044
B25 R / SS Gold Star	250		B8ES	2411	0,5	B8EVX	7051	201	BR8EIX	5044
B25 Starfire, B25T Victor	250		B8ES	2411	0,5	B8EVX	7051	201	BR8EIX	5044
B40 SS90	350		B7ES	1111	0,5	B7EVX	6934			
A50W, B50MX, Victor MC	500		B8ES	2411	0,5	B8EVX	7051	201	BR8EIX	5044
B50SS, Gold Star, B50T Vict.	500		B7ES	1111	0,5	B7EVX	6934			
A75 Rocket 3	750		B8ES	2411	0,6	B8EVX	7051	201	BR8EIX	5044

**BATAVUS**

G50, Mosquito, M40, TS49	50		B6HS	4510	0,5	B6HVX	7435	203	BR6HIX	3419
Go-Go2,-V,-S	50		B6HS	4510	0,5	B6HVX	7435	203	BR6HIX	3419
TS 49 S	50		B8HS	5510	0,5	B8HVX	2634	205	BR8HIX	7001

**BELGARDA**

DT / TDR / TZR (Yamaha)	125		B9ES	2611	0,5	B9EVX	7254	202	BR9EIX	3981
TZR 125 R S/P (Yamaha)	125				0,5	B10EGV	5927			

**BENELLI**

G2, Elle, Pedali	50	01.83 -06.89	B6HS	4510	0,5	B6HVX	7435	203	BR6HIX	3419
Gentleman, Magnum 5V	50		B5ES	6410	0,5					
Laser	50	01.84 -06.89	B6HS	4510	0,5	B6HVX	7435	203	BR6HIX	3419
Magnum 3V	50		B7ES	1111	0,5	B7EVX	6934			
S50	50	04.81 -06.89	B6HS	4510	0,5	B6HVX	7435	203	BR6HIX	3419
Spring 50	50		B8ES	2411	0,5	B8EVX	7051	201	BR8EIX	5044
125	125		B6HS	4510	0,5	B6HVX	7435	203	BR6HIX	3419
125-2C Twin	125		B7ES	1111	0,5	B7EVX	6934			
Jarno	125		B8ES	2411	0,5	B8EVX	7051	201	BR8EIX	5044
Scooter S-125	125		B7HS	5110	0,5	B7HVX	7836	204	BR7HIX	7067
304	230	09.82 -	B7HS	5110	0,6	B7HVX	7836	204	BR7HIX	7067
250	250		B6ES	7310	0,5	B6EVX	5136			
250 Quattro	250	10.77 -06.80	B7HS	5110	0,6	B7HVX	7836	204	BR7HIX	7067
254	250	01.80 -07.82	B7HS	5110	0,6	B7HVX	7836	204	BR7HIX	7067
2C, 2CE, Sport Speciale	250		B7ES	1111	0,5	B7EVX	6934			
500 LS, Quattro, 504 / Sport	500		D8EA	2120	0,5	D8EVX	2850	216	DR8EIX	6681
654 / Sport / 4C	650		D8EA	2120	0,5	D8EVX	2850	216	DR8EIX	6681
Tornado 650/S/SV	650		B8ES	2411	0,5	B8EVX	7051	201	BR8EIX	5044
750 Sei	750		D8EA	2120	0,5	D8EVX	2850	216	DR8EIX	6681
900 Sei VT/NT	900		D8EA	2120	0,5	D8EVX	2850	216	DR8EIX	6681
Tornado RS / LE	900	05 -	C7E	5096	0,6				CR7EIX	7385
Tornado TRE	900	05 -	C7E	5096	0,6				CR7EIX	7385
Toronado 900	900	00 -	CR9E	6263	0,7	CR9EVX	5943	227	CR9EIX	3521
TNT 1130	1130	05 -	CR9E	6263	0,7	CR9EVX	5943	227	CR9EIX	3521
TNT 1130 Sport Evo	1130	05.06 -	CR9E	6263	0,7	CR9EVX	5943	227	CR9EIX	3521
TNT 1130 Cafe Racer	1130	06 -	CR9E	6263	0,7	CR9EVX	5943	227	CR9EIX	3521
TNT 1130	1130	05.04 -	CR9E	6263	0,7	CR9EVX	5943	227	CR9EIX	3521
Stilo / AI	50		B6HS	4510	0,5	B6HVX	7435	203	BR6HIX	3419

Order  
No.Platin  
Gold-  
Palla-  
diumOrder  
No.Quick  
No.

Iridium

Order  
No.**BETA**

ALP 50	50	93 -	B8ES	2411	0,5	B8EVX	7051	201	BR8EIX	5044
Bad	50		B9ES	2611	0,5	B9EVX	7254	202	BR9EIX	3981
KR-50	50		B6ES	7310	0,5	B6EVX	5136			
Minicross 12/15	50	00 -	B7HS	5110	0,5	B7HVX	7836	204	BR7HIX	7067
Minicross 10/10	50	00 -	B7HS	5110	0,5	B7HVX	7836	204	BR7HIX	7067
Minitrail	50	00 -	B7HS	5110	0,5	B7HVX	7836	204	BR7HIX	7067
Motard 50 Euro2	50		BR9ES	5722	0,6	BR9EVX	1265	208	BR9EIX	3981
Motard 50 Racing Euro2	50		BR9ES	5722	0,6	BR9EVX	1265	208	BR9EIX	3981
Motard 50 Alu Euro2	50		BR9ES	5722	0,6	BR9EVX	1265	208	BR9EIX	3981
MX 50	50	93 -	B9ES	2611	0,5	B9EVX	7254	202	BR9EIX	3981
REV 50	50	04 -	B9ES	2611	0,5	B9EVX	7254	202	BR9EIX	3981
RK 6-50	50		B8ES	2411	0,5	B8EVX	7051	201	BR8EIX	5044
RR 50 Enduro Alu Euro2	50		BR9ES	5722	0,6	BR9EVX	1265	208	BR9EIX	3981
RR 50 Enduro Euro2	50		BR9ES	5722	0,6	BR9EVX	1265	208	BR9EIX	3981
RR 50 Enduro Racing Euro2	50		BR9ES	5722	0,6	BR9EVX	1265	208	BR9EIX	3981
RR Enduro	50		B10ES	7928	0,5	B10EVX	7335		BR10EIX	6801
Super Trail	50		B8ES	2411	0,5	B8EVX	7051	201	BR8EIX	5044
Supermotard 50	50		B10ES	7928	0,5	B10EVX	7335		BR10EIX	6801
Tempo / Crono	50		BR7HS	4122	0,5			211	BR7HIX	7067
Tempo 50	50		BR7HS	4122	0,5			211	BR7HIX	7067
Tempo Crono	50		BR7HS	4122	0,5			211	BR7HIX	7067
TR-50	50		B6ES	7310	0,5	B6EVX	5136			
Zero 50	50		B9ES	2611	0,5	B9EVX	7254	202	BR9EIX	3981
M4 4-T	80		CR9EK	4548	0,8			230	CR9EIX	3521
REV 80	80	04 -	B9ES	2611	0,5	B9EVX	7254	202	BR9EIX	3981
Dougie Lampkin Replica	124		B8ES	2411	0,5	B8EVX	7051	201	BR8EIX	5044
Alp 125	125		CR7HSA	4549	0,8				CR7HIX	7544
Alp 4T	125	00 -	DR8EA	7162	0,7	DR8EVX	6354		DR8EIX	6681
REV 3	125	00 -	BP6ES	7811	0,6	BP6EVX	5832		BPR6EIX	6637
RR 125 Enduro Euro2	125		CR7HSA	4549	0,8				CR7HIX	7544
RR 125 Motard Euro2	125		CR7HSA	4549	0,8				CR7HIX	7544
Techno 125	125		BP7ES	2412	0,6	BP7EVX	7270	206	BPR7EIX	4055
TR-34	125		B8ES	2411	0,5	B8EVX	7051	201	BR8EIX	5044
Zero 125	125		B8ES	2411	0,5	B8EVX	7051	201	BR8EIX	5044
Alp 4-T	200	00 -	DR8EA	7162	0,7	DR8EVX	6354		DR8EIX	6681
Alp	200		DR8EA	7162	0,7	DR8EVX	6354		DR8EIX	6681
REV 3	200		BP6ES	7811	0,6	BP6EVX	5832		BPR6EIX	6637
TR-33	240		B6ES	7310	0,5	B6EVX	5136			
Dougie Lampkin Replica	247		BP7ES	2412	0,5	BP7EVX	7270	206	BPR7EIX	4055
Alp 250	250		B8ES	2411	0,5	B8EVX	7051	201	BR8EIX	5044
REV 3	250	00 -	BP6ES	7811	0,6	BP6EVX	5832		BPR6EIX	6637
RR 250M 4-T	250		DCPR8E	4339	0,9	DCPR8EVX	2265		DCPR8EIX	6546
Super Trail 250	250		B8ES	2411	0,5	B8EVX	7051	201	BR8EIX	5044
Techno	250		BCP7ES	5030	0,5	BCP7EV	3733		BCPR7EIX	5690
Alp	260		B8ES	2411	0,5	B8EVX	7051	201	BR8EIX	5044
Super Trail	260		B8ES	2411	0,5	B8EVX	7051	201	BR8EIX	5044
Synt 260	260		B8ES	2411	0,5	B8EVX	7051	201	BR8EIX	5044
TR-34/Campionato	260		B8ES	2411	0,5	B8EVX	7051	201	BR8EIX	5044
Zero	260		B8ES	2411	0,5	B8EVX	7051	201	BR8EIX	5044
REV 3 270	275		BP6ES	7811	0,6	BP6EVX	5832		BPR6EIX	6637
Alp 4.0 4-T	350	03 -	CR9EK	4548	0,7			230	CR9EIX	3521
Euro 350	350		CR9EK	4548	0,7			230	CR9EIX	3521

Order  
No.Gold-  
Palla-  
diumOrder  
No.Quick  
No.

Iridium

Order  
No.**BETA**

Jonathan 350	350		CR9EK	4548	0,7			230	CR9EIX	3521
Motard 4.0 4-T	350	03 -	CR9EK	4548	0,7			230	CR9EIX	3521
RR 400 4-T	400		DCPR8E	4339	0,9	DCPR8EVX	2265		DCPR8EIX	6546
RR 450 4-T	450		DCPR8E	4339	0,9	DCPR8EVX	2265		DCPR8EIX	6546
RR 525 4-T	525		DCPR8E	4339	0,9	DCPR8EVX	2265		DCPR8EIX	6546

**BIG DOG**

all models	1310		BPR5ES-11	4424	1,1	BPR5EVX-11	2738		BPR5EIX-11	2115
88 cu in	1440		BPR5ES-11	4424	1,1	BPR5EVX-11	2738		BPR5EIX-11	2115
all models	1507		BPR5ES-11	4424	1,1	BPR5EVX-11	2738		BPR5EIX-11	2115
Total Performance Eng.	1750		DCPR7E	3932	0,8	DCPR7EVX	1179		DCPR7EIX	6046
S&S Engine 107 cu in	1750		BPR5ES-11	4424	1,1	BPR5EVX-11	2738		BPR5EIX-11	2115
S&S Engine 117 cu in	1918		DCPR7E	3932	0,8	DCPR7EVX	1179		DCPR7EIX	6046

**BIMOTA**

YB-9 Bellaria	600		CR9E	6263	0,7	CR9EVX	5943	227	CR9EIX	3521
YB-9 SR	600	95 -	CR9E	6263	0,7	CR9EVX	5943	227	CR9EIX	3521
BB 1 Supermono / Biposto	650	95 -	D8EA	2120	0,7	D8EVX	2850	216	DR8EIX	6681
DB-1/S	750		BP7HS	5111	0,5	BP7HVX	7468		BPR7HIX	5944
SB 7	750		CR9EK	4548	0,7			230	CR9EIX	3521
YB-4	750		DR8EA	7162	0,7	DR8EVX	6354		DR8EIX	6681
Tesi 1	851	92 -			0,6	D9EVX	2834		DR9EIX	4772
DB-2	900	92 -	DPR8EA-9	4929	0,9	DPR8EVX-9	2872	221	DPR8EIX-9	2202
DB-2 SR	900		DPR8EA-9	4929	0,9	DPR8EVX-9	2872	221	DPR8EIX-9	2202
DB-3 Mantra	904	95 -	DPR8EA-9	4929	0,9	DPR8EVX-9	2872	221	DPR8EIX-9	2202
SB 8 R	1000	99 -	CR9EK	4548	0,7			230	CR9EIX	3521
YB-6	1000		DR8ESL	2923	0,7	DR8EVX	6354	218	DR8EIX	6681
YB-8 EXUP	1000	95 -	DR8ESL	2923	0,7	DR8EVX	6354	218	DR8EIX	6681
YB 11	1002	96 -	DR8EA	7162	0,7	DR8EVX	6354		DR8EIX	6681
SB 6	1100		CR9E	6263	0,7	CR9EVX	5943	227	CR9EIX	3521
SB 6 R	1100	97 -	CR9E	6263	0,7	CR9EVX	5943	227	CR9EIX	3521
SB-5/S	1150		DPR9EA-9	5329	0,9	DPR9EVX-9	3854	222	DPR9EIX-9	5545
YB-5	1200		DPR8EA-9	4929	0,9	DPR8EVX-9	2872	221	DPR8EIX-9	2202

**BLATA**

Elite 13 R	40				0,5	B9EGV	5827			
Elite 13	40		B9ES	2611	0,5	B9EVX	7254	202	BR9EIX	3981
Elite 13 W	40		B9ES	2611	0,5	B9EVX	7254	202	BR9EIX	3981
Elite 13 / 13W	40		B9ES	2611	0,8	B9EVX	7254	202	BR9EIX	3981
Elite 13 W R	40				0,5	B9EGV	5827			
Elite 13 W R S	40				0,5	B9EGV	5827			
Elite 13S / 13WR / 13WRS	40				0,5	B9EGV	5827			

**BMW**

R 20 (220/1)	192	37 - 38	B6HS	4510	0,7	B6HVX	7435	203	BR6HIX	3419
R 23 (223/1)	192	38 - 40	B6HS	4510	0,7	B6HVX	7435	203	BR6HIX	3419
R 24	250	48 - 50	B8HS	5510	0,6	B8HVX	2634	205	BR8HIX	7001
R 25	250	50 - 51	B8HS	5510	0,6	B8HVX	2634	205	BR8HIX	7001
R 25/2	250	51 - 53	B8HS	5510	0,6	B8HVX	2634	205	BR8HIX	7001
R 25/3	250	53 - 56	B8HS	5510	0,6	B8HVX	2634	205	BR8HIX	7001
R 26	250	56 - 60	B8HS	5510	0,6	B8HVX	2634	205	BR8HIX	7001
R 27	250	60 - 67	B8HS	5510	0,6	B8HVX	2634	205	BR8HIX	7001

Order  
No.Platin  
Gold-  
Palla-  
diumOrder Quick  
No. No.Order  
No.**BMW**

R 51/2	250	50 - 51	B8HS	5510	0,6	B8HVX	2634	205	BR8HIX	7001
R 51/3	250	51 - 54	B8HS	5510	0,6	B8HVX	2634	205	BR8HIX	7001
R 3 (203/1)	305	36 - 36	B6HS	4510	0,7	B6HVX	7435	203	BR6HIX	3419
R 45 20kW	475	06.78-07.85	BP6ES	7811	0,6	BP6EVX	5832		BPR6EIX	6637
R 45 26kW	475	06.78-06.83	BP7ES	2412	0,6	BP7EVX	7270	206	BPR7EIX	4055
R 5 (254)	494	36 - 37	B7HS	5110	0,7	B7HVX	7836	204	BR7HIX	7067
R 50	500	55 - 69	B8HS	5510	0,6	B8HVX	2634	205	BR8HIX	7001
R 50/5	500		BP7ES	2412	0,6	BP7EVX	7270	206	BPR7EIX	4055
R 50S	500	60 - 62	B8HS	5510	0,6	B8HVX	2634	205	BR8HIX	7001
R 52	500	28 - 29	B6HS	4510	0,6	B6HVX	7435	203	BR6HIX	3419
R 6 (261)	600	37 - 37	B6HS	4510	0,7	B6HVX	7435	203	BR6HIX	3419
R 60	600	56 - 69	B8HS	5510	0,6	B8HVX	2634	205	BR8HIX	7001
R 60/5, /6, /7	600	-06.78	BP7ES	2412	0,6	BP7EVX	7270	206	BPR7EIX	4055
R 67	600	51 -	B8HS	5510	0,6	B8HVX	2634	205	BR8HIX	7001
R 67/2	600	52 - 54	B8HS	5510	0,6	B8HVX	2634	205	BR8HIX	7001
R 68	600	52 - 54	B8HS	5510	0,6	B8HVX	2634	205	BR8HIX	7001
R 69	600	55 - 60	B8HS	5510	0,6	B8HVX	2634	205	BR8HIX	7001
R 69S	600	60 - 69	B9ES	2611	0,6	B9EVX	7254		BR9EIX	3981
F 650 TwinSpark (BMS-C II)	650	09.04 -	DR8EB	4855	0,6				DR8EIX	6681
F 650 25kW	650	93 - 99	D8EA	2120	0,7	D8EVX	2850	216	DR8EIX	6681
F 650 35kW	650	93 - 99	D8EA	2120	0,7	D8EVX	2850	216	DR8EIX	6681
F 650 ST 35kW	650	97 - 99	D8EA	2120	0,6	D8EVX	2850	216	DR8EIX	6681
F 650 GS 25kW	650	00-08.03	D8EA	2120	0,6	D8EVX	2850	216	DR8EIX	6681
F 650 GS 37kW	650	00-08.03	D8EA	2120	0,6	D8EVX	2850	216	DR8EIX	6681
F 650 CS	650	02-08.03	DR8EB	4855	0,6				DR8EIX	6681
G 650 Xmoto	650	07 -	DR8EB	4855	0,6				DR8EIX	6681
G 650 Xchallenge	650	07 -	DR8EB	4855	0,6				DR8EIX	6681
G 650 Xcountry	650	07 -	DR8EB	4855	0,6				DR8EIX	6681
R 65	650	06.78 -	BP7ES	2412	0,6	BP7EVX	7270	206	BPR7EIX	4055
R 16 Serie 1-5	736	29 - 35	B6HS	4510	0,7	B6HVX	7435	203	BR6HIX	3419
R 17 (M60)	736	35 - 37	A6	1010	0,7					
R 11 Serie 1-5	745	29 - 34	B6HS	4510	0,7	B6HVX	7435	203	BR6HIX	3419
R 12 2-Vergaser (M56S6&212)	745	35 - 42	B6HS	4510	0,7	B6HVX	7435	203	BR6HIX	3419
K 75	750	06.85 - 96	D7EA	7912	0,6	D7EVX	2734			
K 75 RT	750	- 96	D7EA	7912	0,6	D7EVX	2734			
K 75 S	750	- 96	D7EA	7912	0,6	D7EVX	2734			
R 71 (271/1)	750	38 - 41	B6HS	4510	0,6	B6HVX	7435	203	BR6HIX	3419
R 75/5, /6, /7	750		BP6ES	7811	0,6	BP6EVX	5832		BPR6EIX	6637
F 800 GS	800	10.06 -	DCPR8E	4339	0,9	DCPR8EVX	2265		DCPR8EIX	6546
F 800 S	800	06 -	DCPR8E	4339	0,9	DCPR8EVX	2265		DCPR8EIX	6546
F 800 ST	800	06 -	DCPR8E	4339	0,9	DCPR8EVX	2265		DCPR8EIX	6546
R 80 R	800	80 -	BP6ES	7811	0,7	BP6EVX	5832		BPR6EIX	6637
R 80 GS	800	08.82 - 94	BP6ES	7811	0,7	BP6EVX	5832		BPR6EIX	6637
R 80 RT	800	08.82 - 95	BP6ES	7811	0,7	BP6EVX	5832		BPR6EIX	6637
R 80 ST	800	08.82 - 95	BP6ES	7811	0,7	BP6EVX	5832		BPR6EIX	6637
R 80	800	08.82 - 95	BP6ES	7811	0,7	BP6EVX	5832		BPR6EIX	6637
R 80/7N /7S	800	09.77 -08.80	BP6ES	7811	0,7	BP6EVX	5832		BPR6EIX	6637
R 850 GS	850	98 -	BKR7EKC	7354					BKR7EIX	2667
R 850 R 52kW	850	10.94 -	BKR7EKC	7354					BKR7EIX	2667
R 850 RT	850	99 -	BKR7EKC	7354					BKR7EIX	2667
R 90/6	900		BP6ES	7811	0,6	BP6EVX	5832		BPR6EIX	6637
R 90/S	900		BP7ES	2412	0,6	BP7EVX	7270	206	BPR7EIX	4055



Order  
No.Platin  
Gold-  
Palla-  
diumOrder Quick  
No. No.

Iridium

Order  
No.**BMW**

K 100 LT / RT 65kW	1000	09.83 - 11.91	D7EA	7912	0,5	D7EVX	2734			
K 100 RS 4V	1000		DR7EA	7839	0,6					
K 100 RS 65kW	1000	09.83 - 12.89	D7EA	7912	0,6	D7EVX	2734			
K 100 RS 72-74kW	1000	01.90 - 93	D7EA	7912	0,6	D7EVX	2734			
K 1 72-74kW	1000	05.89 - 93	DR7EA	7839	0,6					
R 100 R	1000	94 -	BP6ES	7811	0,6	BP6EVX	5832		BPR6EIX	6637
R 100	1000		BP7ES	2412	0,6	BP7EVX	7270	206	BPR7EIX	4055
R 100 RS	1000	09.86 -	BP6ES	7811	0,6	BP6EVX	5832		BPR6EIX	6637
R 100/7	1000		BP6ES	7811	0,6	BP6EVX	5832		BPR6EIX	6637
R 100/CS /RT	1000		BP7ES	2412	0,6	BP7EVX	7270	206	BPR7EIX	4055
R 100/RS	1000	08.86	BP7ES	2412	0,6	BP7EVX	7270	206	BPR7EIX	4055
R 100 GS	1000	09.86 -	BP6ES	7811	0,6	BP6EVX	5832		BPR6EIX	6637
R 100/S /T	1000	09.76 - 08.80	BP7ES	2412	0,6	BP7EVX	7270	206	BPR7EIX	4055
K 1100 LT 72-74kW	1100	01.92 - 98	DR7EA	7839	0,6					
K 1100 RS 72-74kW	1100	01.92 - 96	DR7EA	7839	0,6					
R 1100 S all models twinspark	1100	01.03 -	BKR7EKC + DCPR8EKC	7354+ 7168					BKR7EIX + DCPR8EIX	2667+ 6546
R 1100 GS 59kW	1100	08.93 - 99	BCP7ET	2078	0,8				BCPR7EIX	5690
R 1100 R 59kW	1100	10.94 - 01	BCP7ET	2078	0,8				BCPR7EIX	5690
R 1100 RS 66kW	1100	11.92 - 01	BCP7ET	2078	0,8				BCPR7EIX	5690
R 1100 RT 66kW	1100	09.95 - 01	BCP7ET	2078	0,8				BCPR7EIX	5690
R 1100 S Boxer Cup not twinspark	1100	02 - 03	BKR7EKC	7354					BKR7EIX	2667
R 1100 S 72kW not twinspark	1100	98 - 03	BKR7EKC	7354					BKR7EIX	2667
R 1150 all models twinspark	1150	01.03 -	BKR7EKC + DCPR8EKC	7354+ 7168					BKR7EIX + DCPR8EIX	2667+ 6546
R 1150 GS not twinspark	1150	99 - 03	BKR7EKC	7354					BKR7EIX	2667
R 1150 GS Adventure not twinspark	1150	02 - 03	BKR7EKC	7354					BKR7EIX	2667
R 1150 R not twinspark	1150	01 - 03	BKR7EKC	7354					BKR7EIX	2667
R 1150 RT not twinspark	1150	01 - 03	BKR7EKC	7354					BKR7EIX	2667
HP2 77kW twinspark	1200	05 -	BKR7EKC + DCPR8EKC	7354+ 7168					BKR7EIX + DCPR8EIX	2667+ 6546
K 1200 RS 72kW	1200	97 -	DCPR7E	3932	0,8	DCPR7EVX	1179		DCPR7EIX	6046
K 1200 RS 96kW	1200	97 -	DCPR7E	3932	0,8	DCPR7EVX	1179		DCPR7EIX	6046
K 1200 S	1200	10.04 -	KR9CI							
K 1200 LT 85kW	1200	04 -	DCPR7E	3932	0,8	DCPR7EVX	1179		DCPR7EIX	6046
K 1200 R Sport	1200	07 -	KR9CI							
K 1200 LT	1200	98 -	DCPR7E	3932	0,8	DCPR7EVX	1179		DCPR7EIX	6046
K 1200 GT	1200	06 -	KR9CI							
K 1200 R	1200	05 -	KR9CI							
K 1200 LT 72kW	1200	97 -	DCPR7E	3932	0,8	DCPR7EVX	1179		DCPR7EIX	6046
K 1200 GT	1200	03 - 05	DCPR7E	3932	0,8	DCPR7EVX	1179		DCPR7EIX	6046
R 1200 ST twinspark	1200	05 -	DCPR8EKC	7168					DCPR8EIX	6546
R 1200 GS twinspark	1200	04 -	DCPR8EKC	7168					DCPR8EIX	6546
R 1200 RT twinspark	1200	05 -	DCPR8EKC	7168					DCPR8EIX	6546
R 1200 R twinspark	1200	07 -	DCPR8EKC	7168					DCPR8EIX	6546
R 1200 C twinspark	1200	03.03 -	BKR7EKC + DCPR8EKC	7354+ 7168					BKR7EIX + DCPR8EIX	2667+ 6546
R 1200 CL	1200	03 -	BKR7EKC	7354					BKR7EIX	2667
R 1200 C	1200	05.03	BKR7EKC	7354					BKR7EIX	2667
R 1200 S twinspark	1200	06 -	DCPR8EKC	7168					DCPR8EIX	6546

Order  
No.Platin  
Gold-  
Palla-  
diumOrder  
No.Quick  
No.

Iridium

Order  
No.**BOOM TRIKE**

Classic Trike Chopper VW (Vergaser mit Leistungssteigerung)	1600		<b>B7HS</b>	<b>5110</b>	0,6	<b>B7HVX</b>	<b>7836</b>	<b>204</b>	<b>BR7HIX</b>	<b>7067</b>
Classic Trike Chopper VW (Einspritzer ohne Leistungssteigerung)	1600		<b>BP5ESA</b>	<b>2285</b>	0,8				<b>BPR5EIX</b>	<b>6597</b>
Classic Trike Chopper VW (Vergaser ohne Leistungssteigerung)	1600		<b>B6HS</b>	<b>4510</b>	0,6	<b>B6HVX</b>	<b>7435</b>	<b>203</b>	<b>BR6HIX</b>	<b>3419</b>
Classic Trike Family VW (Vergaser mit Leistungssteigerung)	1600		<b>B7HS</b>	<b>5110</b>	0,6	<b>B7HVX</b>	<b>7836</b>	<b>204</b>	<b>BR7HIX</b>	<b>7067</b>
Classic Trike Family VW (Vergaser ohne Leistungssteigerung)	1600		<b>B6HS</b>	<b>4510</b>	0,6	<b>B6HVX</b>	<b>7435</b>	<b>203</b>	<b>BR6HIX</b>	<b>3419</b>
Classic Trike Family VW (Einspritzer ohne Leistungssteigerung)	1600		<b>BP5ESA</b>	<b>2285</b>	0,8				<b>BPR5EIX</b>	<b>6597</b>
Classic Trike Low Rider VW (Vergaser ohne Leistungssteigerung)	1600		<b>B6HS</b>	<b>4510</b>	0,6	<b>B6HVX</b>	<b>7435</b>	<b>203</b>	<b>BR6HIX</b>	<b>3419</b>
Classic Trike Low Rider VW (Einspritzer ohne Leistungssteigerung)	1600		<b>BP5ESA</b>	<b>2285</b>	0,8				<b>BPR5EIX</b>	<b>6597</b>
Classic Trike Low Rider VW (Vergaser mit Leistungssteigerung)	1600		<b>B7HS</b>	<b>5110</b>	0,6	<b>B7HVX</b>	<b>7836</b>	<b>204</b>	<b>BR7HIX</b>	<b>7067</b>
Fighter Automatik FORD Motor	1600		<b>PTR5A-13</b>	<b>2467</b>	1,3					
Fighter Automatik FORD Motor	2000		<b>PTR5A-13</b>	<b>2467</b>	1,3					

**BOSS**

HOSS	8226		<b>BPR4ES</b>	<b>7222</b>	0,7	<b>BPR4EVX</b>	<b>3436</b>			
------	------	--	---------------	-------------	-----	----------------	-------------	--	--	--

**BSA**

A 7	500	47 - 62	<b>B7HCS</b>	<b>2421</b>	0,7					
-----	-----	---------	--------------	-------------	-----	--	--	--	--	--

**BSM**

City	50	99 - 01	<b>BPR7HS</b>	<b>6422</b>	0,6	<b>BPR7HVX</b>	<b>2938</b>	<b>215</b>	<b>BPR7HIX</b>	<b>5944</b>
Off Road	50	99 - 01	<b>BPR7HS</b>	<b>6422</b>	0,6	<b>BPR7HVX</b>	<b>2938</b>	<b>215</b>	<b>BPR7HIX</b>	<b>5944</b>
Thunderbike	50	99 -	<b>BPR7HS</b>	<b>6422</b>	0,6	<b>BPR7HVX</b>	<b>2938</b>	<b>215</b>	<b>BPR7HIX</b>	<b>5944</b>
Winner	50	99 -	<b>BPR7HS</b>	<b>6422</b>	0,6	<b>BPR7HVX</b>	<b>2938</b>	<b>215</b>	<b>BPR7HIX</b>	<b>5944</b>
Thunderbike 2	100	99 -	<b>BPR7HS</b>	<b>6422</b>	0,6	<b>BPR7HVX</b>	<b>2938</b>	<b>215</b>	<b>BPR7HIX</b>	<b>5944</b>
125	125	99 -	<b>DR8EA</b>	<b>7162</b>	0,7	<b>DR8EVX</b>	<b>6354</b>		<b>DR8EIX</b>	<b>6681</b>
Thunderbike 4	125	99 -	<b>CR7HSA</b>	<b>4549</b>	0,7				<b>CR7HIX</b>	<b>7544</b>

**BUELL**

RR 1000	1000	87 - 88	<b>DCPR7E</b>	<b>3932</b>	1,0	<b>DCPR7EVX</b>	<b>1179</b>		<b>DCPR7EIX</b>	<b>6046</b>
XB9R	1000	01 -	<b>DCPR9E</b>	<b>2641</b>	0,9	<b>DCPR9EVX</b>	<b>6436</b>		<b>DCPR9EIX</b>	<b>2316</b>
XB9S	1000	03 -	<b>DCPR9E</b>	<b>2641</b>	0,9	<b>DCPR9EVX</b>	<b>6436</b>		<b>DCPR9EIX</b>	<b>2316</b>
XB9S	1000	05 -	<b>DCPR9E</b>	<b>2641</b>	0,9	<b>DCPR9EVX</b>	<b>6436</b>		<b>DCPR9EIX</b>	<b>2316</b>
XB9SX	1000	05 -	<b>DCPR9E</b>	<b>2641</b>	0,9	<b>DCPR9EVX</b>	<b>6436</b>		<b>DCPR9EIX</b>	<b>2316</b>
M2 Cyclone	1200	97 - 98	<b>DCPR7E</b>	<b>3932</b>	1,0	<b>DCPR7EVX</b>	<b>1179</b>		<b>DCPR7EIX</b>	<b>6046</b>
RSS 1200/ RS/ RR	1200	89 - 94	<b>DCPR7E</b>	<b>3932</b>	1,0	<b>DCPR7EVX</b>	<b>1179</b>		<b>DCPR7EIX</b>	<b>6046</b>
S1 Lightning	1200	96 - 97	<b>DCPR7E</b>	<b>3932</b>	1,0	<b>DCPR7EVX</b>	<b>1179</b>		<b>DCPR7EIX</b>	<b>6046</b>
S1 White Lightning	1200	98 -	<b>DCPR7E</b>	<b>3932</b>	1,0	<b>DCPR7EVX</b>	<b>1179</b>		<b>DCPR7EIX</b>	<b>6046</b>
S2 Thunderbolt	1200	95 - 96	<b>DCPR7E</b>	<b>3932</b>	1,0	<b>DCPR7EVX</b>	<b>1179</b>		<b>DCPR7EIX</b>	<b>6046</b>
S3 Thunderbolt	1200	97 -	<b>DCPR7E</b>	<b>3932</b>	1,0	<b>DCPR7EVX</b>	<b>1179</b>		<b>DCPR7EIX</b>	<b>6046</b>
X1 Lightning	1200	99 -	<b>DCPR7E</b>	<b>3932</b>	1,0	<b>DCPR7EVX</b>	<b>1179</b>		<b>DCPR7EIX</b>	<b>6046</b>
XB 12 R	1200	07 -	<b>DCPR9E</b>	<b>2641</b>	0,9	<b>DCPR9EVX</b>	<b>6436</b>		<b>DCPR9EIX</b>	<b>2316</b>
XB 12 S	1200	04 -	<b>DCPR9E</b>	<b>2641</b>	0,9	<b>DCPR9EVX</b>	<b>6436</b>		<b>DCPR9EIX</b>	<b>2316</b>
XB 12 Scg	1200	07 -	<b>DCPR9E</b>	<b>2641</b>	0,9	<b>DCPR9EVX</b>	<b>6436</b>		<b>DCPR9EIX</b>	<b>2316</b>

Order  
No.Platin  
Gold-  
Palla-  
diumOrder Quick  
No. No.

Iridium

Order  
No.**BUELL**

XB 12 Ss	1200	06 -	DCPR9E	2641	0,9	DCPR9EVX	6436		DCPR9EIX	2316
XB 12 X	1200	06 -	DCPR9E	2641	0,9	DCPR9EVX	6436		DCPR9EIX	2316
XB 12S TT	1200	07 -	DCPR9E	2641	0,9	DCPR9EVX	6436		DCPR9EIX	2316

**BULTACO**

49/GT	50		B5HS	4210	0,5					
Astro	50	98 -	B9ES	2611	0,5	B9EVX	7254	202	BR9EIX	3981
Chispa	50		B5HS	4210	0,5					
Lobito	50	98 -	B9ES	2611	0,5	B9EVX	7254	202	BR9EIX	3981
Tiron	50		B5HS	4210	0,5					
Brinco	75		B7HS	5110	0,5	B7HVX	7836	204	BR7HIX	7067
Frontera	75		B8HS	5510	0,5	B8HVX	2634	205	BR8HIX	7001
Junior GT2	75		B7HS	5110	0,5	B7HVX	7836	204	BR7HIX	7067
Lobito	75		B6HS	4510	0,5	B6HVX	7435	203	BR6HIX	3419
Sherpa T	75		B6HS	4510	0,5	B6HVX	7435	203	BR6HIX	3419
Streaker	75		B6HS	4510	0,5	B6HVX	7435	203	BR6HIX	3419
Junior	100		B6HS	4510	0,5	B6HVX	7435	203	BR6HIX	3419
Lobito	100		B6HS	4510	0,5	B6HVX	7435	203	BR6HIX	3419
Lobito K	100		B9HS	5810	0,5	B9HVX	2254			
Sherpa S	100		B9HS	5810	0,5	B9HVX	2254			
Tiron	100		B6HS	4510	0,5	B6HVX	7435	203	BR6HIX	3419
Alpina	125		BP5ES	6511	0,5	BP5EVX	5470		BPR5EIX	6597
Frontera	125		B6HS	4510	0,5	B6HVX	7435	203	BR6HIX	3419
Junior	125		B6HS	4510	0,5	B6HVX	7435	203	BR6HIX	3419
Lobito MK3/MK6	125		BP5ES	6511	0,5	BP5EVX	5470		BPR5EIX	6597
Lobito MK7	125		B6HS	4510	0,5	B6HVX	7435	203	BR6HIX	3419
Mercurio	125		B6HS	4510	0,5	B6HVX	7435	203	BR6HIX	3419
Pursang MK5	125		B10EG	3630	0,5	B10EGV	5927			
Pursang MK6	125		B9EG	3530	0,5	B9EGV	5827		BR9EIX	3981
Sherco	125	00 -	BPR5ES	7422	0,6	BPR5EVX	4875		BPR5EIX	6597
Sherpa S	125		B9EG	3530	0,5	B9EGV	5827		BR9EIX	3981
Sherpa T	125		B6HS	4510	0,5	B6HVX	7435	203	BR6HIX	3419
Streaker	125		B6HS	4510	0,5	B6HVX	7435	203	BR6HIX	3419
Tralla	125		B6HS	4510	0,5	B6HVX	7435	203	BR6HIX	3419
Campera	150		B6HS	4510	0,5	B6HVX	7435	203	BR6HIX	3419
Mercurio/GT/150	150		B6HS	4510	0,5	B6HVX	7435	203	BR6HIX	3419
Tralla	150		B6HS	4510	0,5	B6HVX	7435	203	BR6HIX	3419
Alpina	175		BP5ES	6511	0,5	BP5EVX	5470		BPR5EIX	6597
Campera MK2	175		B5ES	6410	0,5					
Lobito MK6	175		BP5ES	6511	0,5	BP5EVX	5470		BPR5EIX	6597
Lobito MK7	175		B5ES	6410	0,5					
Mercurio	175		B6HS	4510	0,5	B6HVX	7435	203	BR6HIX	3419
Mercurio GT	175		BP5ES	6511	0,5	BP5EVX	5470		BPR5EIX	6597
Pursang MK5	175		B9EG	3530	0,5	B9EGV	5827		BR9EIX	3981
Sherpa MK3	175		B9EG	3530	0,5	B9EGV	5827		BR9EIX	3981
El Tigre	200		B8ES	2411	0,5	B8EVX	7051	201	BR8EIX	5044
Go Kart	200		B9EG	3530	0,5	B9EGV	5827		BR9EIX	3981
Mercurio	200		B8ES	2411	0,5	B8EVX	7051	201	BR8EIX	5044
Metise	200		B8ES	2411	0,5	B8EVX	7051	201	BR8EIX	5044
Pursang MK5	200		B9EG	3530	0,5	B9EGV	5827		BR9EIX	3981
Senior	200		B8ES	2411	0,5	B8EVX	7051	201	BR8EIX	5044
Sherco	200	00 -	BPR5ES	7422	0,6	BPR5EVX	4875		BPR5EIX	6597

Order  
No.Platin  
Gold-  
Palla-  
diumOrder Quick  
No. No.Order  
No.**BULTACO**

Sherpa MK3	200		B9EG	3530	0,5	B9EGV	5827		BR9EIX	3981
Sherpa S	200		B7ES	1111	0,5	B7EVX	6934			
Alpina	250		BP5ES	6511	0,5	BP5EVX	5470		BPR5EIX	6597
Astro	250		B9EG	3530	0,5	B9EGV	5827		BR9EIX	3981
Frontera	250		B8ES	2411	0,5	B8EVX	7051	201	BR8EIX	5044
Matador 250/SD	250		BP5ES	6511	0,5	BP5EVX	5470		BPR5EIX	6597
Matador MK2/MK3	250		B8ES	2411	0,5	B8EVX	7051	201	BR8EIX	5044
Matador MK4	250		BP6ES	7811	0,5	BP6EVX	5832		BPR6EIX	6637
Metralia GT/MK2/MK250	250		B8ES	2411	0,5	B8EVX	7051	201	BR8EIX	5044
Metralia GTS	250		BP5ES	6511	0,5	BP5EVX	5470		BPR5EIX	6597
Pursang MK4/MK5 lado admis	250		B8ES	2411	0,5	B8EVX	7051	201	BR8EIX	5044
Pursang MK4/MK5 lado escap	250		B9EG	3530	0,5	B9EVX	7254		BR9EIX	3981
Pursang MK6/MK7 lado admis	250		B8ES	2411	0,5	B8EVX	7051	201	BR8EIX	5044
Pursang MK6/MK7 lado escap	250		B9EG	3530	0,5	B9EGV	5827		BR9EIX	3981
Sherco	250	99 -	BPR5ES	7422	0,6	BPR5EVX	4875		BPR5EIX	6597
Sherpa S	250		B9EG	3530	0,5	B9EGV	5827		BR9EIX	3981
Sherpa T	250		BP5ES	6511	0,5	BP5EVX	5470		BPR5EIX	6597
Sherco	290	00 -	BPR5ES	7422	0,6	BPR5EVX	4875		BPR5EIX	6597
Alpina	350		BP5ES	6511	0,5	BP5EVX	5470		BPR5EIX	6597
Matador MK9/MK10	350		BP5ES	6511	0,5	BP5EVX	5470		BPR5EIX	6597
Pursang MK5/MK6 lado admis	350		B8ES	2411	0,5	B8EVX	7051	201	BR8EIX	5044
Pursang MK5/MK6 lado escap	350		B9EG	3530	0,5	B9EGV	5827		BR9EIX	3981
Sherpa T	350		BP5ES	6511	0,5	BP5EVX	5470		BPR5EIX	6597
Astro lado admision	360		B8ES	2411	0,5	B8EVX	7051	201	BR8EIX	5044
Astro lado escape	360		B9EG	3530	0,5	B9EGV	5827		BR9EIX	3981
El Bandito MK2 lado admis.	360		B8ES	2411	0,5	B8EVX	7051	201	BR8EIX	5044
El Bandito MK2 lado escape	360		B9EG	3530	0,5	B9EGV	5827		BR9EIX	3981
Frontera	360		B8ES	2411	0,5	B8EVX	7051	201	BR8EIX	5044
Pursang lado admision	360		B8ES	2411	0,5	B8EVX	7051	201	BR8EIX	5044
Pursang lado escape	360		B9EG	3530	0,5	B9EGV	5827		BR9EIX	3981
Frontera MK11	370		B8ES	2411	0,5	B8EVX	7051	201	BR8EIX	5044
Pursang lado admision	370		B8ES	2411	0,5	B8EVX	7051	201	BR8EIX	5044
Pursang lado escape	370		B9EG	3530	0,5	B9EGV	5827		BR9EIX	3981
Pursang MK15	450		B8ES	2411	0,5	B8EVX	7051	201	BR8EIX	5044

**CAGIVA**

City	50	98 -	BR8HSA	5539	0,5	BR8HVX	6265		BR8HIX	7001
Cocis	50		B8ES	2411	0,5	B8EVX	7051	201	BR8EIX	5044
K3	50		B8ES	2411	0,5	B8EVX	7051	201	BR8EIX	5044
Prima	50		B8ES	2411	0,5	B8EVX	7051	201	BR8EIX	5044
Supercity	50		B8ES	2411	0,5	B8EVX	7051	201	BR8EIX	5044
W4	50		B8ES	2411	0,5	B8EVX	7051	201	BR8EIX	5044
Cocis	75		B8ES	2411	0,5	B8EVX	7051	201	BR8EIX	5044
125 Elefant 2	125		B9EG	3530	0,5	B9EGV	5827		BR9EIX	3981
Aletta Electra, Oro	125	84 -	B9ES	2611	0,5	B9EVX	7254	202	BR9EIX	3981
Aletta Oro 125/S1	125	07.85 -12.85	B9EG	3530	0,5	B9EGV	5827		BR9EIX	3981
Aletta Oro 125/S2	125	01.86 -	B9ES	2611	0,6	B9EVX	7254	202	BR9EIX	3981
Aletta,Low Rider	125	01.82 -	B8ES	2411	0,5	B8EVX	7051	201	BR8EIX	5044
Blues,C10,Cruiser	125	10.87 -	B9ES	2611	0,5	B9EVX	7254	202	BR9EIX	3981
Elefant 3	125	01.87 -	B9ES	2611	0,5	B9EVX	7254	202	BR9EIX	3981
Freccia C 9 (D)	125	06.87 -	B9ES	2611	0,6	B9EVX	7254	202	BR9EIX	3981
Freccia C10 (D)	125		B9ES	2611	0,6	B9EVX	7254	202	BR9EIX	3981

Order  
No.Platin  
Gold-  
Palla-  
diumOrder Quick  
No. No.

Iridium

Order  
No.**CAGIVA**

Freccia C12 (D)	125	06.87 -	B9ES	2611	0,6	B9EVX	7254	202	BR9EIX	3981
K7	125				0,5	B95EGV	2145			
Mito	125	95 - 98			0,5	B95EGV	2145			
Mito	125	99 -	BR9EG	3230	0,5	BR9EVX	1265		BR9EIX	3981
Mito 1 (D)	125				0,5	B95EGV	2145			
Mito 2 (D)	125				0,5	B95EGV	2145			
Mito EV 125	125		BR10EG	3830	0,6					
Mito Racing (D)	125				0,5	B95EGV	2145			
N 90	125	03.90 -	B9ES	2611	0,5	B9EVX	7254	202	BR9EIX	3981
Planet	125	99 - 03	BR9EG	3230	0,5	BR9EVX	1265		BR9EIX	3981
Raptor 125	125	04 -	BR9EG	3230	0,5	BR9EVX	1265		BR9EIX	3981
RL, SS, SX	125		B8ES	2411	0,5	B8EVX	7051	201	BR8EIX	5044
Roadster	125	98 -	BR9ES	5722	0,6	BR9EVX	1265	208	BR9EIX	3981
Aletta Rossa / Dakar	125		B9EG	3530	0,5	B9EGV	5827		BR9EIX	3981
RX 125 Rally	125	01.81 -12.81	B9EG	3530	0,5	B9EGV	5827		BR9EIX	3981
RX,WRX,WSXT	125	01.82 -12.83	B9EG	3530	0,5	B9EGV	5827		BR9EIX	3981
ST,SXT	125	01.82 -12.82	B9ES	2611	0,5	B9EVX	7254	202	BR9EIX	3981
Supercity	125	99 -	BR9EG	3230	0,5	BR9EVX	1265		BR9EIX	3981
Supercity (D)	125				0,5	B95EGV	2145			
Tamanaco 125	125	01.88 -	B9ES	2611	0,6	B9EVX	7254	202	BR9EIX	3981
W 8 11kW	125	96 - 97	B9ES	2611	0,5	B9EVX	7254	202	BR9EIX	3981
W 8	125	98 -	BR9ES	5722	0,6	BR9EVX	1265	208	BR9EIX	3981
W 8 (only D)	125	91 -			0,5	B95EGV	2145			
WMX 125/84	125				0,5	B9EVX	7254		BR9EIX	3981
WMX 125/85	125				0,5	B10EGV	5927			
WMX 125/88	125				0,5	B10EGV	5927			
WR 125	125	02 -	BR9EG	3230	0,5	BR9EVX	1265		BR9EIX	3981
WRE 125	125	02 -	BR9EG	3230	0,5	BR9EVX	1265		BR9EIX	3981
All	175		B8ES	2411	0,5	B8EVX	7051	201	BR8EIX	5044
All	200		B9ES	2611	0,5	B9EVX	7254	202	BR9EIX	3981
MX,MXR,RR,RX,WMX	250		B9ES	2611	0,5	B9EVX	7254	202	BR9EIX	3981
NC,RL,SS,SST	250	01.83 -	B8ES	2411	0,5	B8EVX	7051	201	BR8EIX	5044
RX 250 Rally	250	01.79 -11.83	B9EG	3530	0,5	B9EGV	5827		BR9EIX	3981
SX, SXT	250	01.83 -12.84	B8ES	2411	0,5	B8EVX	7051	201	BR8EIX	5044
Ala Blu 350	350		B8ES	2411	0,5	B8EVX	7051	201	BR8EIX	5044
Ala Rossa 350/4T	350	01.83 -	B8ES	2411	0,5	B8EVX	7051	201	BR8EIX	5044
Ala Verde 350	350		B8ES	2411	0,5	B8EVX	7051	201	BR8EIX	5044
Alazzurra 350 (D)	350	01.84 -	BP7HS	5111	0,5	BP7HVX	7468		BPR7HIX	5944
Elefant 350 (D)	350		BP7HS	5111	0,5	BP7HVX	7468		BPR7HIX	5944
Lucky 350	350		DP8EA-9	5829	0,9	DPR8EVX-9	2872		DPR8EIX-9	2202
SST 350	350		B8ES	2411	0,5	B8EVX	7051	201	BR8EIX	5044
SX 350	350	11.81 -12.82	B8ES	2411	0,5	B8EVX	7051	201	BR8EIX	5044
T4 350 E, R (D)	350	10.86 -	DP8EA-9	5829	0,9	DPR8EVX-9	2872		DPR8EIX-9	2202
Trial 350	350	01.82 -	BP5ES	6511	0,6	BP5EVX	5470		BPR5EIX	6597
W12	350	94 -	DP8EA-9	5829	0,9	DPR8EVX-9	2872		DPR8EIX-9	2202
T4 500 E, R (D)	450		DP8EA-9	5829	0,9	DPR8EVX-9	2872		DPR8EIX-9	2202
Canyon 500	500	98 -	BPR8ES	3923	0,7	BPR8EVX	5573	213		
MXR 500	500				0,5	B95EGV	2145			
Canyon 600	600	98 -	BCP7ES	5030	0,8	BCP7EV	3733		BCPR7EIX	5690
Canyon 600	600	96 - 97			0,7	BKR7EVX	3544			
River 600	600	95 -			0,7	BKR7EVX	3544			
Super City	600	95 -			0,7	BKR7EVX	3544			

Order  
No.Platin  
Gold-  
Palla-  
diumOrder Quick  
No. No.Order  
No.**CAGIVA**

W16	600	94 -			0,7	BKR7EVX	3544			
Alazzurra 650 (D)	650	01.84 -	BP7HS	5111	0,6	BP7HVX	7468		BPR7HIX	5944
Elefant 650 (D)	650	01.85 -12.88	BP7HS	5111	0,6	BP7HVX	7468		BPR7HIX	5944
Raptor	650	00 -	CR8E	1275	0,7	CR8EVX	6487	226	CR8EIX	4218
V-Raptor	650	00 -	CR8E	1275	0,7	CR8EVX	6487	226	CR8EIX	4218
Elefant 750	750	94 -	DPR8EA-9	4929	0,9	DPR8EVX-9	2872	221	DPR8EIX-9	2202
Elefant 750 Lucky (D)	750	02.87 -	DPR8EA-9	4929	0,9	DPR8EVX-9	2872	221	DPR8EIX-9	2202
Elefant 900 AC (D)	900	93 -	DPR9EA-9	5329	0,9	DPR9EVX-9	3854	222	DPR9EIX-9	5545
Elefant 900 ie/GT (D)	900	92 -	DPR9EA-9	5329	0,9	DPR9EVX-9	3854	222	DPR9EIX-9	5545
Grand Canyon 900	900	98 -	DPR8EA-9	4929	0,9	DPR8EVX-9	2872	221	DPR8EIX-9	2202
Navigator 1000	1000	99 -	CR8EK	3478	0,7				CR8EIX	4218
Raptor	1000	99 -	CR8EK	3478	0,7				CR8EIX	4218
V-Raptor	1000	03.00 -	CR8EK	3478	0,7				CR8EIX	4218
X-tra Raptor 1000	1000	03 -	CR8EK	3478	0,7				CR8EIX	4218

**CAN-AM**

Spyder Roadster	1000	08 -	DCPR9E	2641	0,7	DCPR9EVX	6436		DCPR9EIX	2316
-----------------	------	------	--------	------	-----	----------	------	--	----------	------

**CANNONDALE**

EX 400	432	01 -	CR9EK	4548	0,7			230	CR9EIX	3521
MX 400	432	00 -	CR9EK	4548	0,7			230	CR9EIX	3521
XC 400	432	01 -	CR9EK	4548	0,7			230	CR9EIX	3521

**CARABELA**

Carrera	50		BP5HS	4111	0,5					
Super SP / de Luxe	50		BP5HS	4111	0,5					
Ciclo Motor Ciao	60		B6HS	4510	0,5	B6HVX	7435	203	BR6HIX	3419
Merida, Mototic, Moto pony	60		B6HS	4510	0,5	B6HVX	7435	203	BR6HIX	3419
Coyote Enduro	100		B6ES	7310	0,5	B6EVX	5136			
Coyote MX	100		B7ES	1111	0,6	B7EVX	6934			
Enduro , MX	100		B6HS	4510	0,5	B6HVX	7435	203	BR6HIX	3419
Marquesa MX	100		B8ES	2411	0,6	B8EVX	7051	201	BR8EIX	5044
Marquesa Enduro	100		B7ES	1111	0,6	B7EVX	6934			
Marquesa Mini Enduro	100		B6ES	7310	0,5	B6EVX	5136			
Marquesa Mini MX	100		B7ES	1111	0,6	B7EVX	6934			
Mini Moto	100		B6ES	7310	0,5	B6EVX	5136			
Motorcarro 100	100		B6ES	7310	0,5	B6EVX	5136			
Panthera	100		B6HS	4510	0,5	B6HVX	7435	203	BR6HIX	3419
Panthera100,Sprint 100, TS-3 100	100		B6ES	7310	0,5	B6EVX	5136			
Rally Enduro	100		B6ES	7310	0,5	B6EVX	5136			
Torero Flat Track	100		B8ES	2411	0,6	B8EVX	7051	201	BR8EIX	5044
Coyote Enduro	125		B6ES	7310	0,5	B6EVX	5136			
Coyote MX	125		B7ES	1111	0,6	B7EVX	6934			
De Luxe	125		B6ES	7310	0,5	B6EVX	5136			
Marquesa MX 111	125		B8ES	2411	0,6	B8EVX	7051	201	BR8EIX	5044
Marquesa MXV	125		B8ES	2411	0,6	B8EVX	7051	201	BR8EIX	5044
Mini Enduro	125		B6ES	7310	0,5	B6EVX	5136			
Rally Enduro	125		B6ES	7310	0,5	B6EVX	5136			
Torero Flat Track	125		B8ES	2411	0,6	B8EVX	7051	201	BR8EIX	5044
Marquesa Enduro	175		B8ES	2411	0,6	B8EVX	7051	201	BR8EIX	5044
Marquesa MK-II	175		B8ES	2411	0,6	B8EVX	7051	201	BR8EIX	5044
Rally Enduro	175		B6ES	7310	0,5	B6EVX	5136			

Order  
No.Platin  
Gold-  
Palla-  
diumOrder Quick  
No. No.

Iridium

Order  
No.

## CARABELA

Strada	175		B6ES	7310	0,5	B6EVX	5136			
Torero Flat Track	175		B8ES	2411	0,6	B8EVX	7051	201	BR8EIX	5044
Enduro	200		B6ES	7310	0,5	B6EVX	5136			
Moto Cross	200		B8ES	2411	0,6	B8EVX	7051	201	BR8EIX	5044
Motocarro Ariete	200		B6ES	7310	0,5	B6EVX	5136			
Super Turismo	200		B6ES	7310	0,5	B6EVX	5136			
Centauro Enduro	250		B8ES	2411	0,6	B8EVX	7051	201	BR8EIX	5044
Centauro MX-II, MX-III, MX-IV	250		B8ES	2411	0,6	B8EVX	7051	201	BR8EIX	5044
Torero Flat Track	250		B8ES	2411	0,6	B8EVX	7051	201	BR8EIX	5044
Centauro MX-III	360		B8ES	2411	0,6	B8EVX	7051	201	BR8EIX	5044
Enduro	400		B6ES	7310	0,5	B6EVX	5136			
MX	400		B8ES	2411	0,6	B8EVX	7051	201	BR8EIX	5044
Centauro MX-II	450		B8ES	2411	0,6	B8EVX	7051	201	BR8EIX	5044
Enduro	450		B6ES	7310	0,5	B6EVX	5136			
Torero Flat Track	450		B7ES	1111	0,6	B7EVX	6934			

## CARREFOUR

Web / Gap	50	00 -	B7HS	5110	0,5	B7HVX	7836	204	BR7HIX	7067
PFM	125	00 -	DR8EA	7162	0,7	DR8EVX	6354		DR8EIX	6681

## CASAL

M 105 Six Speed (RZ,Mag.)	50	92 -	B9HS	5810	0,6	B9HVX	2254			
M 109 Four Speed	50	91 -	B8HS	5510	0,6	B8HVX	2634	205	BR8HIX	7001
M 140 Automatic	50	82 -	B7HS	5110	0,6	B7HVX	7836	204	BR7HIX	7067
M 147 Two Speed	50	91 -	B7HS	5110	0,6	B7HVX	7836	204	BR7HIX	7067
M 233 Six Speed	50	90 -	B8ES	2411	0,6	B8EVX	7051	201	BR8EIX	5044
Super Boss RE	50	10.99 -	B9HS	5810	0,5	B9HVX	2254			
Super Boss K 168-8	50	91 -	B8HS	5510	0,6	B8HVX	2634	205	BR8HIX	7001

## CCM

CMX 125 L / C	125	83 - 85	B9EG	3530	0,5	B9EGV	5827		BR9EIX	3981
Moto X Hiro	125	79 - 80	B10EG	3630	0,5	B10EGV	5927			
240 CMT Trails	240		BP5ES	6511	0,7	BP5EVX	5470		BPR5EIX	6597
250 CMX	250	82 -	B8ES	2411	0,5	B8EVX	7051	201	BR8EIX	5044
250 CMX I / C	250	83 - 85	B9EG	3530	0,5	B9EGV	5827		BR9EIX	3981
250 Moto Hiro	250	79 - 81	B9EG	3530	0,5	B9EGV	5827		BR9EIX	3981
250 CMT Trails	250		BP5ES	6511	0,7	BP5EVX	5470		BPR5EIX	6597
310 CMT Trails	310		BP5ES	6511	0,7	BP5EVX	5470		BPR5EIX	6597
320 CMT Trails	320		BP5ES	6511	0,7	BP5EVX	5470		BPR5EIX	6597
350 Trails	350	78 -	B6ES	7310	0,7	B6EVX	5136			
350 CMT Trails	350		BP5ES	6511	0,7	BP5EVX	5470		BPR5EIX	6597
CM 36 Road Racer	350	78 -			0,5	B9EVX	7254		BR9EIX	3981
CMX	450	82 -			0,5	B8EVX	7051		BR8EIX	5044
490 CMX	490		B9EG	3530	0,5	B9EGV	5827		BR9EIX	3981
500 MTT	500		DR8EA	7162	0,7	DR8EVX	6354		DR8EIX	6681
CMX 500	500	82 -	DR8EA	7162	0,7	DR8EVX	6354		DR8EIX	6681
Moto X 4Ventil	500	79 - 81	R017-8	3943	0,5				CR8EIX	4218
Moto X 2Ventil	500	72 - 79	B9EG	3530	0,5	B9EGV	5827		BR9EIX	3981
560 CCM 4Takt	560		DR8EA	7162	0,7	DR8EVX	6354		DR8EIX	6681
560 CCM 2Takt	560		DR8EA	7162	0,7	DR8EVX	6354		DR8EIX	6681
604 R / RS / R30	600		DR8EA	7162	0,7	DR8EVX	6354		DR8EIX	6681
604 Supermoto dual Sport	600	01 -	DR8EA	7162	0,7	DR8EVX	6354		DR8EIX	6681

Order  
No.Platin  
Gold-  
Palla-  
diumOrder Quick  
No. No.Order  
No.**CCM**

604 Trail dual Sport	600	01 -	DR8EA	7162	0,7	DR8EVX	6354		DR8EIX	6681
604 Roadster RS	600	01 -	DR8EA	7162	0,7	DR8EVX	6354		DR8EIX	6681
640 RS	640		DR8EA	7162	0,7	DR8EVX	6354		DR8EIX	6681
644	650	02 -	CR10EK	2360	0,7				CR10EIX	6482
R30 Supermotard	650	02 -	CR9EK	4548	0,7			230	CR9EIX	3521

**CLIPIC**

Trial	50	00 -	B7HS	5110	0,5	B7HVX	7836	204	BR7HIX	7067
Trial E	50	00 -	B10ES	7928	0,5	B10EVX	7335		BR10EIX	6801
Trial R	80	00 -	B9ES	2611	0,5	B9EVX	7254	202	BR9EIX	3981

**COSSACK**

Jupiter 350	350		BR6HS	3922	0,5			209	BR6HIX	3419
Planeta 350	350		BR6HS	3922	0,5			209	BR6HIX	3419
Dnepr 650	650		BR6HS	3922	0,5			209	BR6HIX	3419
Ural 650, Ural MT10	650		B6HS	4510	0,5	B6HVX	7435	203	BR6HIX	3419

**CPI**

Supercross 50	50	03 -	BR7ES	5122	0,8	BR7EVX	4556			
Supermoto 50	50	03 -	BR7ES	5122	0,8	BR7EVX	4556			
Supermoto SMX	50	06 -	BR8ES	5422	0,8	BR8EVX	1262	207	BR8EIX	5044

**CR & S**

Vun	650	07 -	DR8EB	4855	0,6				DR8EIX	6681
-----	-----	------	-------	------	-----	--	--	--	--------	------

**CRAZY-VEHICLE**

Crazy Buggy	125	03 -	CR7HSA	4549	0,7				CR7HIX	7544
-------------	-----	------	--------	------	-----	--	--	--	--------	------

**CZ**

488	125		B6HS	4510	0,6	B6HVX	7435	203	BR6HIX	3419
487	175		B6HS	4510	0,6	B6HVX	7435	203	BR6HIX	3419
485	250		B6HS	4510	0,6	B6HVX	7435	203	BR6HIX	3419
472	350		B6HS	4510	0,6	B6HVX	7435	203	BR6HIX	3419

**DAELIM**

125 Daystar	125	01.00 -	C8EH-9	7473	0,9	C8EHVX-9	4450		CR8EHIX-9	3797
Altino 125 ES	125	02 -	C8EH-9	7473	0,9	C8EHVX-9	4450		CR8EHIX-9	3797
Evolution VS	125	02 -	C8EH-9	7473	0,9	C8EHVX-9	4450		CR8EHIX-9	3797
VC 125 Advance	125	95 -	C8EH-9	7473	0,9	C8EHVX-9	4450		CR8EHIX-9	3797
VJ 125 Roadwin	125	03 - 04	CR8EH-9	5666	0,9	CR8EHVX-9	4546	228	CR8EHIX-9	3797
VL 125	125	00 -	CR8EH-9	5666	0,9	CR8EHVX-9	4546	228	CR8EHIX-9	3797
VL 125 Daystar	125	02 -	C8EH-9	7473	0,9	C8EHVX-9	4450		CR8EHIX-9	3797
VL 125 L Daystar	125	02 -	C8EH-9	7473	0,9	C8EHVX-9	4450		CR8EHIX-9	3797
VS 125	125	97 - 98	CR8EH-9	5666	0,9	CR8EHVX-9	4546	228	CR8EHIX-9	3797
VS 125 EVO	125	99 -	CR8EH-9	5666	0,9	CR8EHVX-9	4546	228	CR8EHIX-9	3797
VT 125 EVO	125	00 -	CR8EH-9	5666	0,9	CR8EHVX-9	4546	228	CR8EHIX-9	3797
VT 125 Evolution	125	03.98 -	C8EH-9	7473	0,9	C8EHVX-9	4450		CR8EHIX-9	3797

**DERBI**

Antorcha, Coppa, Diablo	50	- 91	B7HS	5110	0,6	B7HVX	7836	204	BR7HIX	7067
Aventura	50	95 -	B8HS	5510	0,6	B8HVX	2634	205	BR8HIX	7001
Aventura	50	95 -	B8HS	5510	0,6	B8HVX	2634	205	BR8HIX	7001



Order  
No.Platin  
Gold-  
Palla-  
diumOrder Quick  
No. No.

Iridium

Order  
No.**DERBI**

Dirt Boy 10/10	50	03 -	CR9E	6263	0,7	CR9EVX	5943	227	CR9EIX	3521
Dirt Kid 10/12	50	03 -	CR9E	6263	0,7	CR9EVX	5943	227	CR9EIX	3521
FDS, GTS, RD-2	50	- 91	B7HS	5110	0,6	B7HVX	7836	204	BR7HIX	7067
Fenix, FDS Super, Start DS	50	92 -	B8HS	5510	0,6	B8HVX	2634	205	BR8HIX	7001
Furax	50	95 -	B8HS	5510	0,6	B8HVX	2634	205	BR8HIX	7001
GPR Nude 50	50		B8ES	2411	0,5	B8EVX	7051	201	BR8EIX	5044
GPR Replica	50	03 -	B8ES	2411	0,5	B8EVX	7051	201	BR8EIX	5044
GPR Racing	50	02 -	B8ES	2411	0,5	B8EVX	7051	201	BR8EIX	5044
GPR 50 R	50	02 -	B8ES	2411	0,5	B8EVX	7051	201	BR8EIX	5044
Hunter (D+A)	50	95 -	BP7HS	5111	0,6	BP7HVX	7468		BPR7HIX	5944
Hunter (Spain)	50	95 -	B8HS	5510	0,6	B8HVX	2634	205	BR8HIX	7001
Naked	50	04 -	B8ES	2411	0,5	B8EVX	7051	201	BR8EIX	5044
Olimpica, Savannah, Start	50	- 91	B7HS	5110	0,6	B7HVX	7836	204	BR7HIX	7067
R DRD	50	02 -	B8ES	2411	0,5	B8EVX	7051	201	BR8EIX	5044
R Racer	50	02 -	B8ES	2411	0,5	B8EVX	7051	201	BR8EIX	5044
R X-treme	50	02 -	B8ES	2411	0,5	B8EVX	7051	201	BR8EIX	5044
RD-2 Country	50	92 -	B8HS	5510	0,6	B8HVX	2634	205	BR8HIX	7001
Senda (Wasserkühlung)	50		B8ES	2411	0,5	B8EVX	7051	201	BR8EIX	5044
Sendra-R	50	95 -	B9ES	2611	0,6	B9EVX	7254	202	BR9EIX	3981
SM Black Edition	50	02 -	B8ES	2411	0,5	B8EVX	7051	201	BR8EIX	5044
SM DRD	50		B9ES	2611	0,6	B9EVX	7254	202	BR9EIX	3981
SM Racer	50	02 -	B9ES	2611	0,6	B9EVX	7254	202	BR9EIX	3981
SM X-treme	50	02 -	B9ES	2611	0,6	B9EVX	7254	202	BR9EIX	3981
Sport, Variant, Yumbo	50	- 91	B7HS	5110	0,6	B7HVX	7836	204	BR7HIX	7067
Urban	50	95 -	B8HS	5510	0,6	B8HVX	2634	205	BR8HIX	7001
Vamos	50		BR8HS	4322	0,6	BR8HVX	6265	212	BR8HIX	7001
Variant Box/Sport R / Top	50	92 -	B8HS	5510	0,6	B8HVX	2634	205	BR8HIX	7001
Variant AIR	50	05.03 -	B8HS	5510	0,5	B8HVX	2634	205	BR8HIX	7001
X Race 50	50		B8ES	2411	0,5	B8EVX	7051	201	BR8EIX	5044
X Race R 50	50		B8ES	2411	0,5	B8EVX	7051	201	BR8EIX	5044
X Treme 50	50		B8ES	2411	0,5	B8EVX	7051	201	BR8EIX	5044
1001,Extra Sport Coppa	75		B8ES	2411	0,5	B8EVX	7051	201	BR8EIX	5044
CR 74	75				0,5	B10EGV	5927			
Europa RD15, Scoot 74	75		B8ES	2411	0,5	B8EVX	7051	201	BR8EIX	5044
GPR-75, Sport-75	75		B10ES	7928	0,5	B10EGV	5927		BR10EIX	6801
Gran Prix 74	75		B6HS	4510	0,5	B6HVX	7435	203	BR6HIX	3419
Vivo-75	75		BP5HS	4111	0,6					
BI 3	80	95 -	B8ES	2411	0,6	B8EVX	7051	201	BR8EIX	5044
CRS, RC	125				0,5	B10EGV	5927			
Enduro, RS125TT, Karmathan	125				0,5	B9EGV	5827			
Nude GPR	125	10.04 -	BR8ES	5422	0,8	BR8EVX	1262	207	BR8EIX	5044
Racing GPR	125	10.04 -	BR8ES	5422	0,8	BR8EVX	1262	207	BR8EIX	5044
Senda R 125	125	02 -	DPR8EA-9	4929	0,9	DPR8EVX-9	2872	221	DPR8EIX-9	2202
Senda SM 125	125	02 -	DPR8EA-9	4929	0,9	DPR8EVX-9	2872	221	DPR8EIX-9	2202
Sport Coppa, TTS9	125		B9ES	2611	0,5	B9EVX	7254	202	BR9EIX	3981
2002, Gran Prix, 6V	200		B9ES	2611	0,5	B9EVX	7254	202	BR9EIX	3981
CRX, RC, Enduro	250				0,5	B10EGV	5927			
Turismo 250	250		B9ES	2611	0,5	B9EVX	7254	202	BR9EIX	3981
Mulhacén 659	660	05 -	CR7E	4578	0,6			225	CR7EIX	7385

**DKW**

Hummel Standard 2 Typ 113 2,0PS	48	01.59 -12.63	B7HS	5110	0,5	B7HVX	7836	204	BR7HIX	7067
---------------------------------	----	--------------	------	------	-----	-------	------	-----	--------	------

Order  
No.Platin  
Gold-  
Palla-  
diumOrder  
No.Quick  
No.

Iridium

Order  
No.**DKW**

Hummel Typ 115 2,0PS	48	01.60 -12.63	<b>B7HS</b>	<b>5110</b>	0,5	<b>B7HVX</b>	<b>7836</b>	<b>204</b>	<b>BR7HIX</b>	<b>7067</b>
Hummel Super Typ 116 2,0PS	48	01.59 -12.63	<b>B7HS</b>	<b>5110</b>	0,5	<b>B7HVX</b>	<b>7836</b>	<b>204</b>	<b>BR7HIX</b>	<b>7067</b>
Hummel Super Typ 126 2,0PS	48	01.60 -12.63	<b>B7HS</b>	<b>5110</b>	0,5	<b>B7HVX</b>	<b>7836</b>	<b>204</b>	<b>BR7HIX</b>	<b>7067</b>
Hummel Super Typ 156 3,1+4,2PS	48	01.60 -12.63	<b>B8HS</b>	<b>5510</b>	0,5	<b>B8HVX</b>	<b>2634</b>	<b>205</b>	<b>BR8HIX</b>	<b>7001</b>
Kavalier Typ 155 3,1+4,2PS	48	01.62 -12.63	<b>B8HS</b>	<b>5510</b>	0,5	<b>B8HVX</b>	<b>2634</b>	<b>205</b>	<b>BR8HIX</b>	<b>7001</b>
Violetta Typ 128 2,0PS	48	01.60 -12.63	<b>B7HS</b>	<b>5110</b>	0,5	<b>B7HVX</b>	<b>7836</b>	<b>204</b>	<b>BR7HIX</b>	<b>7067</b>
Violetta Sport Typ 158 3,1+4,2PS	48	01.60 -12.63	<b>B8HS</b>	<b>5510</b>	0,5	<b>B8HVX</b>	<b>2634</b>	<b>205</b>	<b>BR8HIX</b>	<b>7001</b>
Hummel Standard 1 Typ 113 2,0PS	48	01.59 -12.63	<b>B7HS</b>	<b>5110</b>	0,5	<b>B7HVX</b>	<b>7836</b>	<b>204</b>	<b>BR7HIX</b>	<b>7067</b>
Kavalier Typ 115 2,0PS	48	01.62 -12.63	<b>B7HS</b>	<b>5110</b>	0,5	<b>B7HVX</b>	<b>7836</b>	<b>204</b>	<b>BR7HIX</b>	<b>7067</b>
139 M F&S 501/4 BKF	50	10.72 -08.76	<b>B7HS</b>	<b>5110</b>	0,5	<b>B7HVX</b>	<b>7836</b>	<b>204</b>	<b>BR7HIX</b>	<b>7067</b>
159 ES F&S 50 SA	50	10.72 -08.76	<b>B6HS</b>	<b>4510</b>	0,5	<b>B6HVX</b>	<b>7435</b>	<b>203</b>	<b>BR6HIX</b>	<b>3419</b>
504 M F&S 504/1B	50	10.72 -08.76	<b>B6HS</b>	<b>4510</b>	0,5	<b>B6HVX</b>	<b>7435</b>	<b>203</b>	<b>BR6HIX</b>	<b>3419</b>
505 P F&S 504/1A	50	10.72 -08.76	<b>B6HS</b>	<b>4510</b>	0,5	<b>B6HVX</b>	<b>7435</b>	<b>203</b>	<b>BR6HIX</b>	<b>3419</b>
506 M F&S 504/1B	50	10.72 -08.76	<b>B6HS</b>	<b>4510</b>	0,5	<b>B6HVX</b>	<b>7435</b>	<b>203</b>	<b>BR6HIX</b>	<b>3419</b>
510 F&S 504/1B	50	10.72 -08.76	<b>B6HS</b>	<b>4510</b>	0,5	<b>B6HVX</b>	<b>7435</b>	<b>203</b>	<b>BR6HIX</b>	<b>3419</b>
530 F&S 504/1B	50	09.76 -12.83	<b>B6HS</b>	<b>4510</b>	0,5	<b>B6HVX</b>	<b>7435</b>	<b>203</b>	<b>BR6HIX</b>	<b>3419</b>
532 F&S 505/1B	50	09.76 -12.83	<b>B6HS</b>	<b>4510</b>	0,5	<b>B6HVX</b>	<b>7435</b>	<b>203</b>	<b>BR6HIX</b>	<b>3419</b>
533 F&S 505/2B	50	09.76 -12.83	<b>B6HS</b>	<b>4510</b>	0,5	<b>B6HVX</b>	<b>7435</b>	<b>203</b>	<b>BR6HIX</b>	<b>3419</b>
534 F&S 505/1B	50	09.76 -12.83	<b>B6HS</b>	<b>4510</b>	0,5	<b>B6HVX</b>	<b>7435</b>	<b>203</b>	<b>BR6HIX</b>	<b>3419</b>
535 F&S 505/2B	50	09.76 -12.83	<b>B6HS</b>	<b>4510</b>	0,5	<b>B6HVX</b>	<b>7435</b>	<b>203</b>	<b>BR6HIX</b>	<b>3419</b>
630 F&S 50/2MB	50	10.72 -08.76	<b>B7HS</b>	<b>5110</b>	0,5	<b>B7HVX</b>	<b>7836</b>	<b>204</b>	<b>BR7HIX</b>	<b>7067</b>
632 F&S 50/2MB	50	10.72 -08.76	<b>B7HS</b>	<b>5110</b>	0,5	<b>B7HVX</b>	<b>7836</b>	<b>204</b>	<b>BR7HIX</b>	<b>7067</b>
Aero 166 5,3PS	50	01.64 -12.65	<b>B8HS</b>	<b>5510</b>	0,5	<b>B8HVX</b>	<b>2634</b>	<b>205</b>	<b>BR8HIX</b>	<b>7001</b>
Aero 136 2,6PS	50	01.64 -12.65	<b>B7HS</b>	<b>5110</b>	0,5	<b>B7HVX</b>	<b>7836</b>	<b>204</b>	<b>BR7HIX</b>	<b>7067</b>
Hummel Super Typ 136 2,6PS	50	01.64 -12.65	<b>B7HS</b>	<b>5110</b>	0,5	<b>B7HVX</b>	<b>7836</b>	<b>204</b>	<b>BR7HIX</b>	<b>7067</b>
Hummel Typ 155 4,2PS	50	01.64 -12.65	<b>B8HS</b>	<b>5510</b>	0,5	<b>B8HVX</b>	<b>2634</b>	<b>205</b>	<b>BR8HIX</b>	<b>7001</b>
Hummel Standard 2 Typ 113 2,0PS	50	01.64 -12.65	<b>B7HS</b>	<b>5110</b>	0,5	<b>B7HVX</b>	<b>7836</b>	<b>204</b>	<b>BR7HIX</b>	<b>7067</b>
Hummel Typ 166 5,3PS	50	01.64 -12.65	<b>B8HS</b>	<b>5510</b>	0,5	<b>B8HVX</b>	<b>2634</b>	<b>205</b>	<b>BR8HIX</b>	<b>7001</b>
Violetta MK 128 2,0PS	50	01.64 -12.65	<b>B7HS</b>	<b>5110</b>	0,5	<b>B7HVX</b>	<b>7836</b>	<b>204</b>	<b>BR7HIX</b>	<b>7067</b>
Hummel Standard 1 Typ 113 2,0PS	50	01.64 -12.65	<b>B7HS</b>	<b>5110</b>	0,5	<b>B7HVX</b>	<b>7836</b>	<b>204</b>	<b>BR7HIX</b>	<b>7067</b>
Hummel Typ 115 2,6PS	50	01.64 -12.65	<b>B7HS</b>	<b>5110</b>	0,5	<b>B7HVX</b>	<b>7836</b>	<b>204</b>	<b>BR7HIX</b>	<b>7067</b>
Jet F&S 50s	50	10.72 -08.76	<b>B6HS</b>	<b>4510</b>	0,5	<b>B6HVX</b>	<b>7435</b>	<b>203</b>	<b>BR6HIX</b>	<b>3419</b>
Sportmofa F&S 505/2B	50	09.80 -12.83	<b>B6HS</b>	<b>4510</b>	0,5	<b>B6HVX</b>	<b>7435</b>	<b>203</b>	<b>BR6HIX</b>	<b>3419</b>
125 E F&S 1251/6C	125	10.72 -08.76	<b>B8HS</b>	<b>5510</b>	0,5	<b>B8HVX</b>	<b>2634</b>	<b>205</b>	<b>BR8HIX</b>	<b>7001</b>
RT 125 7 2	125	54 -	<b>B6HS</b>	<b>4510</b>	0,5	<b>B6HVX</b>	<b>7435</b>	<b>203</b>	<b>BR6HIX</b>	<b>3419</b>
RT 175	175	59 -	<b>B7HS</b>	<b>5110</b>	0,5	<b>B7HVX</b>	<b>7836</b>	<b>204</b>	<b>BR7HIX</b>	<b>7067</b>
RT 250	175	59 -	<b>B7HS</b>	<b>5110</b>	0,5	<b>B7HVX</b>	<b>7836</b>	<b>204</b>	<b>BR7HIX</b>	<b>7067</b>
RT 200 H	200	52 -	<b>B6HS</b>	<b>4510</b>	0,6	<b>B6HVX</b>	<b>7435</b>	<b>203</b>	<b>BR6HIX</b>	<b>3419</b>

**DNEPR**

Dnepr -300	649	97 -	<b>BP5HS</b>	<b>4111</b>	0,6					
11 J Gespann 28Kw	650		<b>BP6HS</b>	<b>4511</b>	0,6	<b>BP6HVX</b>	<b>4635</b>		<b>BPR6HIX</b>	<b>4085</b>
16 J Gespann 28Kw	650		<b>BP6HS</b>	<b>4511</b>	0,6	<b>BP6HVX</b>	<b>4635</b>		<b>BPR6HIX</b>	<b>4085</b>
KM3-8.157	650		<b>BP6ES</b>	<b>7811</b>	0,7	<b>BP6EVX</b>	<b>5832</b>		<b>BPR6EIX</b>	<b>6637</b>
KM3-8.157-022	650		<b>BP6ES</b>	<b>7811</b>	0,7	<b>BP6EVX</b>	<b>5832</b>		<b>BPR6EIX</b>	<b>6637</b>
MT 11 20KW	650		<b>BP6HS</b>	<b>4511</b>	0,6	<b>BP6HVX</b>	<b>4635</b>		<b>BPR6HIX</b>	<b>4085</b>
MT 16 20KW	650		<b>BP6HS</b>	<b>4511</b>	0,6	<b>BP6HVX</b>	<b>4635</b>		<b>BPR6HIX</b>	<b>4085</b>
K 750	750		<b>B6HS</b>	<b>4510</b>	0,6	<b>B6HVX</b>	<b>7435</b>	<b>203</b>	<b>BR6HIX</b>	<b>3419</b>

**DUCATI**

100 Sport	100	58 - 60	<b>B7HS</b>	<b>5110</b>	0,6	<b>B7HVX</b>	<b>7836</b>	<b>204</b>	<b>BR7HIX</b>	<b>7067</b>
125 Scrambler	125	71 -	<b>B8HS</b>	<b>5510</b>	0,5	<b>B8HVX</b>	<b>2634</b>	<b>205</b>	<b>BR8HIX</b>	<b>7001</b>

Order  
No.Platin  
Gold-  
Palla-  
diumOrder Quick  
No. No.

Iridium

Order  
No.**DUCATI**

125 Sport	125	58 - 65	B7HS	5110	0,6	B7HVX	7836	204	BR7HIX	7067
125 TS	125	59 - 65	B6HS	4510	0,5	B6HVX	7435	203	BR6HIX	3419
160 Monza	160		B7HS	5110	0,6	B7HVX	7836	204	BR7HIX	7067
175 Sport	175	58 - 61	B7HS	5110	0,6	B7HVX	7836	204	BR7HIX	7067
175 TS	175	58 - 60	B6HS	4510	0,5	B6HVX	7435	203	BR6HIX	3419
200 Elite	200	59 - 65	B7HS	5110	0,6	B7HVX	7836	204	BR7HIX	7067
250 Mach 1	250	64 - 66	B7HS	5110	0,6	B7HVX	7836	204	BR7HIX	7067
250 Monza	250	68 -	B7HS	5110	0,6	B7HVX	7836	204	BR7HIX	7067
250 SCR	250	68 - 74	B7HS	5110	0,6	B7HVX	7836	204	BR7HIX	7067
250 SCR-MC	250	62 - 67	B7HS	5110	0,6	B7HVX	7836	204	BR7HIX	7067
350 Desmo	350	70 - 76	B6HS	4510	0,5	B6HVX	7435	203	BR6HIX	3419
350 F3	350	86 - 87	B6HS	4510	0,5	B6HVX	7435	203	BR6HIX	3419
350 F3 Desmo	350		BP7HS	5111	0,5	BP7HVX	7468		BPR7HIX	5944
350 Forza	350		B6HS	4510	0,5	B6HVX	7435	203	BR6HIX	3419
350 GTL	350	79 -	B6HS	4510	0,5	B6HVX	7435	203	BR6HIX	3419
350 Indiana	350	86 -	BR7HS	4122	0,5			211	BR7HIX	7067
350 Junior	350	92 -	BP7HS	5111	0,6	BP7HVX	7468		BPR7HIX	5944
350 MK III	350	70 - 76	B6HS	4510	0,5	B6HVX	7435	203	BR6HIX	3419
350 MK III D	350		B6HS	4510	0,5	B6HVX	7435	203	BR6HIX	3419
350 Sebring	350	65 - 68	B7HS	5110	0,6	B7HVX	7836	204	BR7HIX	7067
350 Sport	350	92 -	BP5ES	6511	0,7	BP5EVX	5470		BPR5EIX	6597
350 Sport Desmo	350		BR7HS	4122	0,5			211	BR7HIX	7067
350 Vento	350	80 -	B6HS	4510	0,5	B6HVX	7435	203	BR6HIX	3419
XL 350	350		BPR7HS	6422	0,6	BPR7HVX	2938	215	BPR7HIX	5944
400 Supersport Junior (D)	400	91 -	BPR7HS	6422	0,6	BPR7HVX	2938	215	BPR7HIX	5944
Monster 400	400	03 -	DCPR8E	4339	0,9	DCPR8EVX	2265		DCPR8EIX	6546
450 /Scrambler (D)	450	70 - 76	B6HS	4510	0,5	B6HVX	7435	203	BR6HIX	3419
450 Desmo Sport	450	71 - 74	BR7HS	4122	0,5			211	BR7HIX	7067
450 Mark 3D	450	69 - 71	BR7HS	4122	0,5			211	BR7HIX	7067
450 R/T	450	71 - 72	BR7HS	4122	0,5			211	BR7HIX	7067
450 SCR	450	69 - 74	B7HS	5110	0,6	B7HVX	7836	204	BR7HIX	7067
450 T/S	450	71 - 73	BR7HS	4122	0,5			211	BR7HIX	7067
500 GTL	500	74 - 79	B7HS	5110	0,5	B7HVX	7836	204	BR7HIX	7067
500 Pantah (D)	500	80 -	B7HS	5110	0,5	B7HVX	7836	204	BR7HIX	7067
500 SL Pantah (D)	500		BPR7HS	6422	0,6	BPR7HVX	2938	215	BPR7HIX	5944
500 Sport Desmo	500	79 - 83	B6HS	4510	0,5	B6HVX	7435	203	BR6HIX	3419
500 Sport Twin	500	78 -	B7HS	5110	0,5	B7HVX	7836	204	BR7HIX	7067
600 Monster	600	94 - 96	DCPR8E	4339	0,9	DCPR8EVX	2265		DCPR8EIX	6546
600 Pantah SL/TL (D)	600	81 -	BPR7HS	6422	0,6	BPR7HVX	2938	215	BPR7HIX	5944
600 SS	600	94 -	DCPR8E	4339	0,9	DCPR8EVX	2265		DCPR8EIX	6546
M 600 Monster all models	600	97 -	DCPR8E	4339	0,9	DCPR8EVX	2265		DCPR8EIX	6546
620 i.e. Dark	620	02 -	DPR8EA-9	4929	0,9	DPR8EVX-9	2872	221	DPR8EIX-9	2202
Multistrada	620	05 -	DCPR8E	4339	0,9	DCPR8EVX	2265		DCPR8EIX	6546
M 620 i.e	620	01 -	DPR8EA-9	4929	0,9	DPR8EVX-9	2872	221	DPR8EIX-9	2202
620 S i.e.	620	02 -	DPR8EA-9	4929	0,9	DPR8EVX-9	2872	221	DPR8EIX-9	2202
620 Sport	620	03 -	DCPR8E	4339	0,9	DCPR8EVX	2265		DCPR8EIX	6546
620 i.e.	620	02 -	DPR8EA-9	4929	0,9	DPR8EVX-9	2872	221	DPR8EIX-9	2202
M 620S i.e	620	01 -	DPR8EA-9	4929	0,9	DPR8EVX-9	2872	221	DPR8EIX-9	2202
650 Indiana	650	87 -	BP7HS	5111	0,6	BP7HVX	7468		BPR7HIX	5944
748 / SP/ SPS	748	95 -			0,6	DCPR9EVX	6436		DCPR9EIX	2316
748 / Biposto	748	99 -			0,6	DCPR9EVX	6436		DCPR9EIX	2316
748 R	748		R2270-9	4319						

Order  
No.Platin  
Gold-  
Palla-  
diumOrder  
No.Quick  
No.

Iridium

Order  
No.**DUCATI**

748 S	748				0,6	DCPR9EVX	6436				
749 S 76kW	748	03 -	MAR10A-J	4706		---				---	
749 R	750	04 -	---			---				---	
750 SS Königswelle	750	72 - 83	BPR7HS	6422	0,6	BPR7HVX	2938	215	BPR7HIX	5944	
750 GT	750	74 - 76	BPR7HS	6422	0,6	BPR7HVX	2938	215	BPR7HIX	5944	
750 F1 Desmo	750	88 -	DCPR8E	4339	0,9	DCPR8EVX	2265		DCPR8EIX	6546	
750 Monster	750	96 - 97	DCPR8E	4339	0,9	DCPR8EVX	2265		DCPR8EIX	6546	
750 Indiana (D)	750	87 -	BPR7HS	6422	0,6	BPR7HVX	2938	215	BPR7HIX	5944	
750 SS	750	91 -			0,6	DCPR9EVX	6436		DCPR9EIX	2316	
750 Paso (D)	750	86 -	DCPR8E	4339	0,9	DCPR8EVX	2265		DCPR8EIX	6546	
750 F1/LS (D)	750	85 -	DCPR8E	4339	0,9	DCPR8EVX	2265		DCPR8EIX	6546	
750 Sport (D)	750	88 - 90	BPR7HS	6422	0,6	BPR7HVX	2938	215	BPR7HIX	5944	
750 SS i.e.	750	99 -	DPR8EA-9	4929	0,9	DPR8EVX-9	2872	221	DPR8EIX-9	2202	
M 750 Monster all models	750	97 -	DCPR8E	4339	0,6	DCPR8EVX	2265		DCPR8EIX	6546	
SS 750 HF I.E.	750				0,6	DCPR9EVX	6436		DCPR9EIX	2316	
SS 750 I.E.	750				0,6	DCPR9EVX	6436		DCPR9EIX	2316	
800 SuperSport	800	03 -	DCPR8E	4339	0,9	DCPR8EVX	2265		DCPR8EIX	6546	
Monster 800 i.e.	800	03 -	DCPR8E	4339	0,9	DCPR8EVX	2265		DCPR8EIX	6546	
800 Sport	800	03 -	DCPR8E	4339	0,9	DCPR8EVX	2265		DCPR8EIX	6546	
Monster S2R	803	05 -	DCPR8E	4339	0,9	DCPR8EVX	2265		DCPR8EIX	6546	
851 S1 (D)	851	88 - 88			0,6	D9EVX	2834		DR9EIX	4772	
851 S3 (D)	851	89 - 92			0,6	D9EVX	2834		DR9EIX	4772	
860 GT,GTS,S (D)	860	75 -	B6HS	4510	0,5	B6HVX	7435	203	BR6HIX	3419	
860 Desmo SS (D)	860		B6HS	4510	0,5	B6HVX	7435	203	BR6HIX	3419	
888 Strada	888	93 -			0,6	DCPR9EVX	6436				
888 SP5	888	93 -	R2270-9	4319	0,5						
851 S.P.,II,III,IV	888				0,6	D9EVX	2834		DR9EIX	4772	
900 Super Sport (D)	900	88 - 90	DCPR8E	4339	0,9	DCPR8EVX	2265				
900 S,SS,GTS,SD,S2,HR (D)	900	80 - 87	BP7HS	5111	0,6	BP7HVX	7468		BPR7HIX	5944	
907 I.E.	900	91 -	DCPR8E	4339	0,9	DCPR8EVX	2265				
M 900 Monster all models	900	97 -	DCPR8E	4339	0,9	DCPR8EVX	2265				
Super Sport 900	900	91 - 92	DCPR8E	4339	0,9	DCPR8EVX	2265				
Darmah 900 (D)	900		B6HS	4510	0,6	B6HVX	7435	203	BR6HIX	3419	
Paso 906	900	88 - 90	DCPR8E	4339	0,9	DCPR8EVX	2265				
900 SS / SL	900	91 - 98	DCPR8E	4339	0,9	DCPR8EVX	2265				
Monster 900 Spezial (57kW)	900	00 -	DPR8EA-9	4929	0,9	DPR8EVX-9	2872	221	DPR8EIX-9	2202	
900 SS final edition	900	99 - 03	DPR8EA-9	4929	0,9	DPR8EVX-9	2872	221	DPR8EIX-9	2202	
M 900 I.E.	900	99 -	DCPR8E	4339	0,9	DCPR8EVX	2265				
MH 900 EVOLUZIONE (75PS)	900	00 -	DPR8EA-9	4929	0,9	DPR8EVX-9	2872	221	DPR8EIX-9	2202	
900 SS I.E.	904	91 - 98	DCPR8E	4339	0,9	DCPR8EVX	2265				
916 (non SP model)	916	94 -				---					
S 4	916	01 -				---					
S T 4	916	98 -				---					
S T 2	944	97 -	DCPR8E	4339	0,9	DCPR8EVX	2265		DCPR8EIX	6546	
Mille (D)	972		BP7HS	5111	0,6	BP7HVX	7468		BPR7HIX	5944	
916 SP / SPS	996	98 -	R2349-9	4418	0,5						
996 Biposto	996	99 -			0,6	DCPR9EVX	6436		DCPR9EIX	2316	
996 SP / SPS	996	98 -	R2349-9	4418	0,5						
S 4 R Monster	996	04 -	MAR10A-J	4706	0,6						
S T 4 s	996		MAR10A-J	4706	0,6						
996 R 99kW (H2)	998		---			---			---		
999 S 100kW	998	03 -	MAR10A-J	4706		---			---		

Order  
No.Platin  
Gold-  
Palla-  
diumOrder Quick  
No. No.

Iridium

Order  
No.

## DUCATI

999	998	05 -			0,6	DCPR9EVX	6436		DCPR9EIX	2316
1000 S2,HR	1000	85 -	BPR7HS	6422	0,6	BPR7HVX	2938	215	BPR7HIX	5944
Multistrada 1000	1000	02 -	DPR8EA-9	4929	0,9	DPR8EVX-9	2872	221	DPR8EIX-9	2202
1000 DS	1000	03 -	DCPR8E	4339	0,9	DCPR8EVX	2265		DCPR8EIX	6546
Paul Smart 1000	1000	06 -	DCPR8E	4339	0,9	DCPR8EVX	2265		DCPR8EIX	6546
Multistrada 1000 / S / DS	1000	05 -	DPR8EA-9	4929	0,9	DPR8EVX-9	2872	221	DPR8EIX-9	2202
ST 3	1000	04 -			0,6	CR9EVX	5943		CR9EIX	3521
Monster 1000 i.e.	1000	03 -	DCPR8E	4339	0,9	DCPR8EVX	2265		DCPR8EIX	6546
1000 SuperSport	1000	03 -	DCPR8E	4339	0,9	DCPR8EVX	2265		DCPR8EIX	6546
S2R 1000 Monster	1000	06 -	DCPR8E	4339	0,9	DCPR8EVX	2265		DCPR8EIX	6546
Classic Sport 1000	1000	06 -	DCPR8E	4339	0,9	DCPR8EVX	2265		DCPR8EIX	6546
Hypermotard (S)	1100	07 -	DCPR8E	4339	0,9	DCPR8EVX	2265		DCPR8EIX	6546
Multistrada 1100	1100	07 -	DCPR8E	4339	0,9	DCPR8EVX	2265		DCPR8EIX	6546

## DUCSON

Automatic 49	50		B6HS	4510	0,5	B6HVX	7435	203	BR6HIX	3419
S21TT,S30TT,XL50 Mercury	50		B6HS	4510	0,5	B6HVX	7435	203	BR6HIX	3419
S9,S15,S16,S20TT	50		B6HS	4510	0,5	B6HVX	7435	203	BR6HIX	3419

## DÜRRKOPP

Diana			B7HS	5110	0,5	B7HVX	7836	204	BR7HIX	7067
Moped 47	47		B6HS	4510	0,5	B6HVX	7435	203	BR6HIX	3419
MD 150	150		B7HS	5110	0,5	B7HVX	7836	204	BR7HIX	7067
Diana TS	175		B8HS	5510	0,5	B8HVX	2634	205	BR8HIX	7001
MD 175	175		B7HS	5110	0,5	B7HVX	7836	204	BR7HIX	7067
MD 201	200		B7HS	5110	0,5	B7HVX	7836	204	BR7HIX	7067
MD 200	200		B7HS	5110	0,5	B7HVX	7836	204	BR7HIX	7067

## EATV

Evolution 510	510		DCPR8E	4179	0,6	DCPR8EVX	2265		DCPR8EIX	6546
Explorer 625	625		DPR8EA-9	4929	0,9	DPR8EVX-9	2872	221	DPR8EIX-9	2202
Extreme 950	950		CR8EK	3478	0,7				CR8EIX	4218
Energie 992	1000		DCPR8E	4179	0,6	DCPR8EVX	2265		DCPR8EIX	6546

## EMW

R 35/3	350	53 - 55	B6HS	4510	0,6	B6HVX	7435	203	BR6HIX	3419
--------	-----	---------	------	------	-----	-------	------	-----	--------	------

## ERING

AT 50 pt 2	50		B6HS	4510	0,6	B6HVX	7435	203	BR6HIX	3419
RT 50	50		B6HS	4510	0,6	B6HVX	7435	203	BR6HIX	3419

## FANTIC

Issimo Convert/Kick	50		B5HS	4210	0,5					
Junior,Tender To	50		B5HS	4210	0,5					
Trial 50	50		B7HS	5110	0,5	B7HVX	7836	204	BR7HIX	7067
Caballero 80	75		B9HS	5810	0,5	B9HVX	2254			
Trial 75	75		B8HS	5510	0,5	B8HVX	2634	205	BR8HIX	7001
Caballero	80		B8EG	3430	0,5	B8EGV	5627			
Enduro	80		B8EG	3430	0,5	B8EGV	5627			
RSX 80	80		B8EG	3430	0,5	B8EGV	5627			
Caballero	125		B9EG	3530	0,5	B9EGV	5827		BR9EIX	3981
Cross	125		B9EG	3530	0,5	B9EGV	5827		BR9EIX	3981



Order No.



Platin Gold-Palladium

Order Quick No.

Iridium



Order No.

**FANTIC**

Professional	125		B6HS	4510	0,5	B6HVX	7435	203	BR6HIX	3419
RSX 125	125		B9EG	3530	0,5	B9EGV	5827		BR9EIX	3981
Trial 125	125		B6HS	4510	0,5	B6HVX	7435	203	BR6HIX	3419
Trial / Competicion	125		B7HS	5110	0,5	B7HVX	7836	204	BR7HIX	7067
Trial 200	160		BP7HS	5111	0,5	BP7HVX	7468		BPR7HIX	5944
TX 160	160		B8EG	3430	0,5	B8EGV	5627			
Enduro	175		B8EG	3430	0,5	B8EGV	5627			
Trial 200	200		B6HS	4510	0,5	B6HVX	7435	203	BR6HIX	3419
Trial 240	240		B6HS	4510	0,5	B6HVX	7435	203	BR6HIX	3419
Section	250	95 - 97	BCP7ES	5030	0,5	BCP7EV	3733		BCPR7EIX	5690
Trial 301 Competicion	250		BP5ES	6511	0,5	BP5EVX	5470		BPR5EIX	6597
Trial 301/305/307	250		B8ES	2411	0,5	B8EVX	7051	201	BR8EIX	5044
Trial Coach	250		B8ES	2411	0,5	B8EVX	7051	201	BR8EIX	5044
Trial K-Roo	250		B8ES	2411	0,5	B8EVX	7051	201	BR8EIX	5044
TX 250	250		B8EG	3430	0,5	B8EGV	5627			
TX 260	260		B8EG	3430	0,5	B8EGV	5627			
Professional	300		B8EG	3430	0,5	B8EGV	5627			
TX 330	330		B8EG	3430	0,5	B8EGV	5627			

**FITE (LEM)**

Champion H-Y, Sandy 4M	50		B8HS	5510	0,6	B8HVX	2634	205	BR8HIX	7001
Cross CR-2, Safari BX	50		B8HS	5510	0,6	B8HVX	2634	205	BR8HIX	7001
Cross CR-3,Small,Safari BX	50		B6HS	4510	0,6	B6HVX	7435	203	BR6HIX	3419

**G.A.C. Mobyte.**

87//89/188/188E/188TC	50	- 87	B6HS	4510	0,5	B6HVX	7435	203	BR6HIX	3419
AV49R/51/69/70/70E/72/83R	50		B6HS	4510	0,5	B6HVX	7435	203	BR6HIX	3419
AV87,AV90,D55,	50	88 -	B7HS	5110	0,5	B7HVX	7836	204	BR7HIX	7067
Cady/E14,Campera	50	- 87	B6HS	4510	0,5	B6HVX	7435	203	BR6HIX	3419
Canpera,Coma First	50	88 -	B7HS	5110	0,5	B7HVX	7836	204	BR7HIX	7067
D55/E/77/Cross,SP50	50	- 87	B6HS	4510	0,5	B6HVX	7435	203	BR6HIX	3419
D55NTT,SP95R,Cady	50	88 -	B7HS	5110	0,5	B7HVX	7836	204	BR7HIX	7067
Hawar,Chopper,Cross NTT,	50		B7HS	5110	0,5	B7HVX	7836	204	BR7HIX	7067
Kanowey,Onix,	50	88 -	B7HS	5110	0,5	B7HVX	7836	204	BR7HIX	7067
Liberty,Moby Cross,	50		B6HS	4510	0,5	B6HVX	7435	203	BR6HIX	3419
MTR Top Racing,Winner	50		B8ES	2411	0,5	B8EVX	7051	201	BR8EIX	5044
Onix 2/City/Coma,Rural	50		B7HS	5110	0,5	B7HVX	7836	204	BR7HIX	7067
Onix ,Stylo GT,	50	- 87	B6HS	4510	0,5	B6HVX	7435	203	BR6HIX	3419
SP90/90R/94/95R /96	50	- 87	B6HS	4510	0,5	B6HVX	7435	203	BR6HIX	3419
Transport ,University	50	- 87	B6HS	4510	0,5	B6HVX	7435	203	BR6HIX	3419
Transporter ,Zarpa NTT	50	88 -	B7HS	5110	0,5	B7HVX	7836	204	BR7HIX	7067

**G+G**

Cruso	1200	03 -	BKR7EKC	7354					BKR7EIX	2667
Cruso S	1200	03 -	BKR7EKC	7354					BKR7EIX	2667

**GARELLI**

Bonanza	25		B6HS	4510	0,6	B6HVX	7435	203	BR6HIX	3419
Bimatic,ES,Gary Uno	50		B6HS	4510	0,5	B6HVX	7435	203	BR6HIX	3419
Formuno,Noi Matic,TL,2V	50		B6HS	4510	0,5	B6HVX	7435	203	BR6HIX	3419
Noi Bimatic,TL,ES,Team Mat	50		B6HS	4510	0,5	B6HVX	7435	203	BR6HIX	3419
Sahel 80	75		B9ES	2611	0,5	B9EVX	7254	202	BR9EIX	3981

Order  
No.Platin  
Gold-  
Palla-  
diumOrder Quick  
No. No.

Iridium

Order  
No.**GARELLI**

GTA 125/ES	125		B10ES	7928	0,5	B10EGV	5927		BR10EIX	6801
Tiger 125 XLE	125		B10ES	7928	0,5	B10EGV	5927		BR10EIX	6801
323 Trail	320		BP5ES	6511	0,5	BP5EVX	5470		BPR5EIX	6597

**GAS GAS**

Contact, Enducross	50		B8HS	5510	0,6	B8HVX	2634	205	BR8HIX	7001
ec boy 50	50	00 -	B8HS	5510	0,5	B8HVX	2634	205	BR8HIX	7001
ec rookie 50	50	00 -	BR9ES	5722	0,6	BR9EVX	1265	208	BR9EIX	3981
Endurocross BOY	50		BPR5ES	7422	0,6	BPR5EVX	4875		BPR5EIX	6597
TXT BOY	50		BPR5ES	7422	0,6	BPR5EVX	4875		BPR5EIX	6597
TXT boy 50 (Alukopf)(aluhead)	50	04 -	BR8ECM	3035	0,6	BR8ECMVX	5567			
Contact T 12	125	94 -	BP5ES	6511	0,5	BP5EVX	5470		BPR5EIX	6597
Cross TT 125	125				0,5	B10EGV	5927			
ec 125	125	97 -	B9EG	3530	0,6	B9EGV	5827		BR9EIX	3981
Enducross TT 125	125				0,5	B10EGV	5927			
125 Enduro	125	02 -	BR8EG	3130	0,6					
Pampera 125	125		BPR6ES	7822	0,8	BPR6EVX	6764		BPR6EIX	6637
Trial 125	125		BP5ES	6511	0,5	BP5EVX	5470		BPR5EIX	6597
TT 125	125		BR8EG	3130	0,6					
TXT 125	125	99 -	BPR5ES	7422	0,6	BPR5EVX	4875		BPR5EIX	6597
Contact T 16	143	94 -	BP5ES	6511	0,5	BP5EVX	5470		BPR5EIX	6597
ec 200	200	99 -	B10EGV	5927	0,6	B10EVX	7335			
200 Enduro	200	02 -	BR8EG	3130	0,6					
Pampera 200	200		BPR6ES	7822	0,8	BPR6EVX	6764		BPR6EIX	6637
TT 200	200		BR8EG	3130	0,6					
TXT 200	200	99 -	BPR5ES	7422	0,6	BPR5EVX	4875		BPR5EIX	6597
Contact JT 25	238	94 -	BP5ES	6511	0,5	BP5EVX	5470		BPR5EIX	6597
TXT 249	249	99 -	BPR5ES	7422	0,6	BPR5EVX	4875		BPR5EIX	6597
250 MC	250	04 -	BR8EG	3130	0,6					
Cross 250	250		BR8EG	3130	0,6					
Delta 25 GT	250		BP5ES	6511	0,5	BP5EVX	5470		BPR5EIX	6597
ec 250	250	97 -	B8EG	3430	0,5	B8EGV	5627			
Enducross 250	250				0,5	B10EGV	5927			
250 Enduro	250	02 -	BR8EG	3130	0,6					
Pampera 250	250		BPR6ES	7822	0,8	BPR6EVX	6764		BPR6EIX	6637
Piri-A 6 Magnum	250		BP5ES	6511	0,5	BP5EVX	5470		BPR5EIX	6597
Trial 250 (water + air)	250		BP5ES	6511	0,5	BP5EVX	5470		BPR5EIX	6597
TT 250	250		BR8EG	3130	0,6					
TXT 250	250		BPR5ES	7422	0,6	BPR5EVX	4875		BPR5EIX	6597
TXT 280	272	00 -	BP5ES	6511	0,5	BP5EVX	5470		BPR5EIX	6597
TXT 280	280		BPR5ES	7422	0,6	BPR5EVX	4875		BPR5EIX	6597
ec 300	300	99 -	B10EGV	5927	0,6	B10EVX	7335			
300 Enduro	300	02 -	BR8EG	3130	0,6					
TT 300	300		BR8EG	3130	0,6					
Pampera 320	320		BPR6ES	7822	0,8	BPR6EVX	6764		BPR6EIX	6637
TXT 321	321	99 -	BPR5ES	7422	0,6	BPR5EVX	4875		BPR5EIX	6597
Delta 32 GT	330		BP5ES	6511	0,5	BP5EVX	5470		BPR5EIX	6597
Trial 327	330		BP5ES	6511	0,5	BP5EVX	5470		BPR5EIX	6597
Trial Halley PXC 325	330		B9ES	2611	0,5	B9EVX	7254	202	BR9EIX	3981
FSE 400	400	02 -	CR8E	1275	0,7	CR8EVX	6487	226	CR8EIX	4218
Normada 500	500		D8EA	2120	0,5	D8EVX	2850	216	DR8EIX	6681

Order  
No.Platin  
Gold-  
Palla-  
diumOrder  
No.Quick  
No.

Iridium

Order  
No.**GILERA**

50 TS	50	01.79 -12.82	B7ES	1111	0,5	B7EVX	6934			
CB1 4V	50		B6ES	7310	0,5	B6EVX	5136			
CBA, SS, SSV	50		B6HS	4510	0,5	B6HVX	7435	203	BR6HIX	3419
DNA 50	50	01 -	BR9ES	5722	0,6	BR9EVX	1265	208	BR9EIX	3981
Eaglet	50		B9ES	2611	0,5	B9EVX	7254	202	BR9EIX	3981
EC 1	50	92 -	B5HS	4210	0,5					
ECO	50	01.79 -	B6HS	4510	0,5	B6HVX	7435	203	BR6HIX	3419
GR 2	50	01.77 -12.82	B6ES	7310	0,5	B6EVX	5136			
GR 2 (Export)	50		B7ES	1111	0,5	B7EVX	6934			
Grande	50		B6HS	4510	0,5	B6HVX	7435	203	BR6HIX	3419
GSA	50	03.82 -	B6HS	4510	0,5	B6HVX	7435	203	BR6HIX	3419
GSM	50	01 -	BR9ES	5722	0,6	BR9EVX	1265	208	BR9EIX	3981
RS	50	01.75 -07.80	B6ES	7310	0,5	B6EVX	5136			
Storm	50	94 -	B9ES	2611	0,5	B9EVX	7254	202	BR9EIX	3981
Super RE, RL	50		B6ES	7310	0,5	B6EVX	5136			
Touring	50	01.73 -12.81	B7ES	1111	0,5	B7EVX	6934			
Trend 50	50		B5HS	4210	0,6					
Trial	50		B7ES	1111	0,5	B7EVX	6934			
TS	50	01.79 -12.82	B6ES	7310	0,5	B6EVX	5136			
80 TG 2, 3	80	03.82 -12.82	B9ES	2611	0,5	B9EVX	7254	202	BR9EIX	3981
Jubilee	90		B7ES	1111	0,5	B7EVX	6934			
Giubileo 4 T, SS	98		B8ES	2411	0,5	B8EVX	7051	201	BR8EIX	5044
125 5V Regolarità	125				0,5	B10EGV	5927			
125 Arcore, Export	125	01.72 -06.80	B8ES	2411	0,5	B8EVX	7051	201	BR8EIX	5044
125 C1	125				0,5	B10SEGV	2171			
125 C3	125				0,5	B10EGV	5927			
125 Cross Competition	125				0,5	B10SEGV	2171			
125 E1	125				0,5	B10SEGV	2171			
125 Endurance	125		B9ES	2611	0,5	B9EVX	7254	202	BR9EIX	3981
125 Enduro	125				0,5	B10SEGV	2171			
125 ER	125	12.87 -03.88	B9ES	2611	0,5	B9EVX	7254	202	BR9EIX	3981
125 GR1	125	01.76 -03.81	B7ES	1111	0,5	B7EVX	6934			
125 Hawk	125	11.85 -12.86	B9ES	2611	0,5	B9EVX	7254	202	BR9EIX	3981
125 RTT Nebraska	125	02.86 -03.88	B9ES	2611	0,5	B9EVX	7254	202	BR9EIX	3981
125 SV Regolarità	125				0,5	B9SEGV	2145			
125 TG1	125	01.76 -12.81	B7ES	1111	0,5	B7EVX	6934			
125 TG2	125	12.81 -12.83	B8ES	2411	0,5	B8EVX	7051	201	BR8EIX	5044
125 TG3	125	12.81 -12.83	B8ES	2411	0,5	B8EVX	7051	201	BR8EIX	5044
Arizona	125		B9EG	3530	0,5	B9EGV	5827		BR9EIX	3981
Coguar	125		DPR8EA-9	4929	0,9	DPR8EVX-9	2872	221	DPR8EIX-9	2202
DNA 125	125	01 -	CR9EB	6955	0,6				CR9EIX	3521
E1 Competition	125				0,5	B10SEGV	2171			
Fast Bike 125	125	02.87 -12.88	B9ES	2611	0,5	B9EVX	7254	202	BR9EIX	3981
HX 125	125				0,5	B10EGV	5927			
KK 125	125	09.86 -12.87	B9ES	2611	0,5	B9EVX	7254	202	BR9EIX	3981
KZ 125	125	03.86 -12.89	B9ES	2611	0,5	B9EVX	7254	202	BR9EIX	3981
R1 S	125	09.89 -	B9EG	3530	0,5	B9EGV	5827		BR9EIX	3981
RC 125 Rally	125		B9ES	2611	0,5	B9EVX	7254	202	BR9EIX	3981
RTX	125	02.86 -12.86	B9EG	3530	0,5	B9EGV	5827		BR9EIX	3981
RV 125	125	05.84 -12.86	B9EG	3530	0,5	B9EGV	5827		BR9EIX	3981
RX 125	125	01.84 -06.85	B9EG	3530	0,5	B9EGV	5827		BR9EIX	3981
Top Rally RC	125	09.90 -	B10EG	3630	0,5	B10EGV	5927			



Order  
No.Platin  
Gold-  
Palla-  
diumOrder Quick  
No. No.

Iridium

Order  
No.**GILERA**

XR 2	125	01.89 -	B9EG	3530	0,5	B9EGV	5827		BR9EIX	3981
XRI 125	125		B9EG	3530	0,5	B9EGV	5827		BR9EIX	3981
150 Arcore, Export	150	01.72 -06.80	B8ES	2411	0,5	B8EVX	7051	201	BR8EIX	5044
DNA 180	180	01 -	CR9EB	6955	0,6				CR9EIX	3521
200 T4	200	09.82 -06.84	B8ES	2411	0,5	B8EVX	7051	201	BR8EIX	5044
Arizona	200	11.85 -12.86	B9EG	3530	0,5	B9EGV	5827		BR9EIX	3981
RTX	200	02.86 -12.86	B9EG	3530	0,5	B9EGV	5827		BR9EIX	3981
RV 200 LC	200	01.85 -12.86	B9EG	3530	0,5	B9EGV	5827		BR9EIX	3981
RX 200 LC	200	01.85 -12.86	B9EG	3530	0,5	B9EGV	5827		BR9EIX	3981
250 Arizona Rally	250	11.85 -12.86	B9ES	2611	0,5	B9EVX	7254	202	BR9EIX	3981
250 C3	250				0,5	B105EGV	2171			
250 KK, KZ	250		B9ES	2611	0,5	B9EVX	7254	202	BR9EIX	3981
250 NGR	250	05.85 -12.86	B9ES	2611	0,5	B9EVX	7254	202	BR9EIX	3981
HX 250	250				0,5	B105EGV	2171			
NX 250 LC	250				0,5	B105EGV	2171			
RV 250 NGR	250		B9ES	2611	0,5	B9EVX	7254	202	BR9EIX	3981
Dakota 350	350		DP9EA-9	6629	0,9	DP9EVX-9	3331		DPR9EIX-9	5545
Dakota 350 ER	350		DP9EA-9	6629	0,9	DP9EVX-9	3331		DPR9EIX-9	5545
XRT 350	350	05.88 -	DP9EA-9	6629	0,9	DP9EVX-9	3331		DPR9EIX-9	5545
Dakota 500	500	04.87 -	DP9EA-9	6629	0,9	DP9EVX-9	3331		DPR9EIX-9	5545
Saturno 500	500	04.88 - 92	DP9EA-9	6629	0,9	DP9EVX-9	3331		DPR9EIX-9	5545
XRT 600	550	05.88 - 92	DP9EA-9	6629	0,9	DP9EVX-9	3331		DPR9EIX-9	5545
600 FB (Nordcape)	600	92 -	D8EA	2120	0,5	D8EVX	2850	216	DR8EIX	6681
Nordwest 600	600		DCPR9E	2641	0,7	DCPR9EVX	6436		DCPR9EIX	2316
RC 600	600	- 92	D8EA	2120	0,5	D8EVX	2850	216	DR8EIX	6681
RC 600 C	600	92 -	D8EA	2120	0,5	D8EVX	2850	216	DR8EIX	6681

**GIMSON**

Cantigo TT,Cross,Jumper	50		B5HS	4210	0,5					
Elite Sport/Super/E2/E87,	50		B5HS	4210	0,5					
Nevada/AL,Maxi Automatico	50		B5HS	4210	0,5					
Polaris,Shipper Trial,	50		B5HS	4210	0,5					
Variomatic,LSA,LSA-RA	50		B5HS	4210	0,5					

**GOERIKE**

300 Ilo MM525	50	10.70 -01.73	A7	1110						
301 AM / B F&S 50/AMB, 50/2MB	50	12.66 -12.75	B7HS	5110	0,5	B7HVX	7836	204	BR7HIX	7067

**HARLEY-DAVIDSON**

M50	50		B8ES	2411	0,5	B8EVX	7051	201	BR8EIX	5044
M50S	50		B8ES	2411	0,5	B8EVX	7051	201	BR8EIX	5044
M65	65		BP5ES	6511	0,6	BP5EVX	5470		BPR5EIX	6597
M65S	65		BP5ES	6511	0,6	BP5EVX	5470		BPR5EIX	6597
MC65	65		BP5ES	6511	0,6	BP5EVX	5470		BPR5EIX	6597
80DS	80		B7HS	5110	0,6	B7HVX	7836	204	BR7HIX	7067
X 90	90		BP5ES	6511	0,6	BP5EVX	5470		BPR5EIX	6597
XZ 90	90		BP5ES	6511	0,6	BP5EVX	5470		BPR5EIX	6597
Baja MSR	100		B8ES	2411	0,5	B8EVX	7051	201	BR8EIX	5044
SR 100	100		B8ES	2411	0,5	B8EVX	7051	201	BR8EIX	5044
M 125	125		BP5ES	6511	0,6	BP5EVX	5470		BPR5EIX	6597
ML 125	125		BP5ES	6511	0,6	BP5EVX	5470		BPR5EIX	6597
MLS 125	125		BP5ES	6511	0,6	BP5EVX	5470		BPR5EIX	6597

Order  
No.Platin  
Gold-  
Palla-  
diumOrder Quick  
No. No.Order  
No.**HARLEY-DAVIDSON**

Rapido	125		BP5ES	6511	0,6	BP5EVX	5470		BPR5EIX	6597
SS 125	125		B9ES	2611	0,5	B9EVX	7254	202	BR9EIX	3981
SX 125	125		B7ES	1111	0,5	B7EVX	6934			
SXT 125	125		B9ES	2611	0,5	B9EVX	7254	202	BR9EIX	3981
SS 175	175		B9ES	2611	0,5	B9EVX	7254	202	BR9EIX	3981
SX 175	175		B9ES	2611	0,5	B9EVX	7254	202	BR9EIX	3981
MX 250	250				0,6	B10EVX	7335		BR10EIX	6801
SS 250	250		B9ES	2611	0,5	B9EVX	7254	202	BR9EIX	3981
SX 250	250		B9ES	2611	0,5	B9EVX	7254	202	BR9EIX	3981
all models / Alle Modelle	350	73 - 74	B8ES	2411	0,5	B8EVX	7051	201	BR8EIX	5044
All 883 models	883	85 -	DPR7EA-9	5129	0,9	DPR7EVX-9	7682	220	DPR7EIX-9	7803
XL 53 C/ Custom 53	883	03.98 -	DPR7EA-9	5129	0,9	DPR7EVX-9	7682	220	DPR7EIX-9	7803
XL-Modelle	900									
XL	1000	71 - 78	B6L	3212	1,0					
XL	1000	79 - 85	BPR6HS-10	2633	1,0					
XL	1100	86 - 87	DCPR7E	3932	1,0				DCPR7EIX	6046
XR	1100	83 - 85	BPR6ES-11	7822	1,0				BPR6EIX-11	3903
V-Rod VRSC	1130	02 -	DCPR8E	4339	1,0				DCPR8EIX	6546
V-Rod VRSCSE	1130	01 -	DCPR8E	4339	1,0				DCPR8EIX	6546
FL Shovel Head	1200	66 - 74	XR5	5953	0,7				XR5IX	7355
FL Shovel Head	1200	75 - 81	BPR5ES-11	4424	1,0				BPR5EIX-11	2115
FL Panhead	1200	48 - 65	XR5	5953	0,7				XR5IX	7355
FX Panhead	1200	48 - 65	XR5	5953	0,7				XR5IX	7355
FX Shovel Head	1200	75 - 81	BPR5ES-11	4424	1,0				BPR5EIX-11	2115
FX Shovel Head	1200	66 - 74	XR5	5953	0,7				XR5IX	7355
XL V-2 Evolution	1200	86 -	DCPR7E	3932	1,0				DCPR7EIX	6046
XL 1200R Sportster Evolution	1200	04 -	DCPR7E	3932	1,0				DCPR7EIX	6046
FL V-2 Evolution	1340	84 - 00	BPR5ES-11	4424	1,0				BPR5EIX-11	2115
FL Shovel Head	1340	82 - 84	BPR5ES-11	4424	1,0				BPR5EIX-11	2115
FL Shovel Head	1340	78 - 81	BPR5ES-11	4424	1,0				BPR5EIX-11	2115
FX Shovel Head	1340	82 - 84	BPR5ES-11	4424	1,0				BPR5EIX-11	2115
FX Shovel Head	1340	78 - 81	BPR5ES-11	4424	1,0				BPR5EIX-11	2115
FX V-2 Evolution	1340	84 - 00	BPR5ES-11	4424	1,0				BPR5EIX-11	2115
FL TC 88	1450	98 -	DCPR7E	3932	1,0				DCPR7EIX	6046
FX TC 88	1450	98 -	DCPR7E	3932	1,0				DCPR7EIX	6046

**HEINKEL**

Perle Moped			B8HS	5510	0,5	B8HVX	2634	205	BR8HIX	7001
-------------	--	--	------	------	-----	-------	------	-----	--------	------

**HERCULES**

Saxonette	30	01.87 -	BP4	2911	0,5					
City Bike C1	50	10.72-08.78	B6HS	4510	0,7	B6HVX	7435	203	BR6HIX	3419
City Bike C2	50	10.72-08.78	B6HS	4510	0,7	B6HVX	7435	203	BR6HIX	3419
City Bike C3	50	09.74-08.78	B6HS	4510	0,7	B6HVX	7435	203	BR6HIX	3419
Hobby Rider HR 1	50	10.72-12.87	B6HS	4510	0,7	B6HVX	7435	203	BR6HIX	3419
Hobby Rider HR 2	50	10.72-12.87	B6HS	4510	0,7	B6HVX	7435	203	BR6HIX	3419
Jogging	50		B6HS	4510	0,5	B6HVX	7435	203	BR6HIX	3419
K 50	50	-08.78	B8HS	5510	0,7	B8HVX	2634	205	BR8HIX	7001
K 50 Ultra	50	-08.78	B8HS	5510	0,7	B8HVX	2634	205	BR8HIX	7001
K 50 Ultra II	50	-08.78	B8HS	5510	0,5	B8HVX	2634	205	BR8HIX	7001
K 50 Ultra LC	50	-08.78	B9ES	2611	0,5	B9EVX	7254	202	BR9EIX	3981
K 50 Ultra LC II	50	-08.78	B9ES	2611	0,5	B9EVX	7254	202	BR9EIX	3981

Order  
No.Platin  
Gold-  
Palla-  
diumOrder  
No.Quick  
No.

Iridium

Order  
No.**HERCULES**

K 50 Ultra LC III	50	-08.78	B9ES	2611	0,5	B9EVX	7254	202	BR9EIX	3981
KX 5	50	01.86 -	BP7HS	5111	0,5	BP7HVX	7468		BPR7HIX	5944
Lastboy	50		B7HS	5110	0,5	B7HVX	7836	204	BR7HIX	7067
M1	50	10.72 -12.77	B6HS	4510	0,5	B6HVX	7435	203	BR6HIX	3419
M2	50	10.72 -12.77	B6HS	4510	0,5	B6HVX	7435	203	BR6HIX	3419
M4	50	09.74 -12.78	B6HS	4510	0,5	B6HVX	7435	203	BR6HIX	3419
M5	50	09.74 -12.78	B6HS	4510	0,5	B6HVX	7435	203	BR6HIX	3419
MK 1S	50	01.78 -08.80	B6HS	4510	0,5	B6HVX	7435	203	BR6HIX	3419
MK 2S	50	01.78 -08.80	B6HS	4510	0,5	B6HVX	7435	203	BR6HIX	3419
MP 2	50	10.72 -12.77	B6HS	4510	0,5	B6HVX	7435	203	BR6HIX	3419
MP 4	50	10.72 -12.77	B6HS	4510	0,5	B6HVX	7435	203	BR6HIX	3419
MX 1	50		B6HS	4510	0,5	B6HVX	7435	203	BR6HIX	3419
MX 1	50	01.89 -	B5HS	4210	0,5					
Optima 3	50	01.78 -	B6HS	4510	0,5	B6HVX	7435	203	BR6HIX	3419
Optima 50	50		BR8HS	4322	0,5	BR8HVX	6265	212	BR8HIX	7001
Prima 2	50		B6HS	4510	0,5	B6HVX	7435	203	BR6HIX	3419
Prima 2S	50	01.89 -	B5HS	4210	0,5					
Prima 3	50		B6HS	4510	0,5	B6HVX	7435	203	BR6HIX	3419
Prima 3S	50	01.89 -	B5HS	4210	0,5					
Prima 4	50		B6HS	4510	0,5	B6HVX	7435	203	BR6HIX	3419
Prima 4LN,5LN	50		B6HS	4510	0,5	B6HVX	7435	203	BR6HIX	3419
Prima 5	50		B6HS	4510	0,5	B6HVX	7435	203	BR6HIX	3419
Prima 5,5S,5SE	50	01.89 -	B5HS	4210	0,5					
Prima 6	50		B6HS	4510	0,5	B6HVX	7435	203	BR6HIX	3419
Prima G3	50		B6HS	4510	0,5	B6HVX	7435	203	BR6HIX	3419
Prima GT	50	01.89 -	B5HS	4210	0,5					
Prima GT,GX	50		B6HS	4510	0,5	B6HVX	7435	203	BR6HIX	3419
Prima Presto	50		B6HS	4510	0,5	B6HVX	7435	203	BR6HIX	3419
Prima Pronto	50		B6HS	4510	0,5	B6HVX	7435	203	BR6HIX	3419
Prima S	50		B6HS	4510	0,5	B6HVX	7435	203	BR6HIX	3419
Prima SL	50		B6HS	4510	0,5	B6HVX	7435	203	BR6HIX	3419
Prima SX	50		B6HS	4510	0,5	B6HVX	7435	203	BR6HIX	3419
Sport Bike SB1	50	10.72 -08.74	B8HS	5510	0,5	B8HVX	2634	205	BR8HIX	7001
Sport Bike SB2	50	10.72 -08.79	B6HS	4510	0,5	B6HVX	7435	203	BR6HIX	3419
Sport Bike SB3	50	09.74 -08.79	B6HS	4510	0,5	B6HVX	7435	203	BR6HIX	3419
Sport Bike SB5	50	09.74 -08.76	B8HS	5510	0,5	B8HVX	2634	205	BR8HIX	7001
Supra 2D,3D	50	06.80 -	B6HS	4510	0,5	B6HVX	7435	203	BR6HIX	3419
Supra 4	50	06.78 -	B7HS	5110	0,5	B7HVX	7836	204	BR7HIX	7067
Supra 4GP	50	01.80 -	B6HS	4510	0,5	B6HVX	7435	203	BR6HIX	3419
Supra Enduro	50	03.80 -	B6HS	4510	0,5	B6HVX	7435	203	BR6HIX	3419
Ultra 50	50		B9ES	2611	0,5	B9EVX	7254	202	BR9EIX	3981
XE 5	50	01.86 -	BP7HS	5111	0,5	BP7HVX	7468		BPR7HIX	5944
ZX 1	50		B7ES	1111	0,5	B7EVX	6934			
RX 9	80		B8HS	5510	0,5	B8HVX	2634	205	BR8HIX	7001
Ultra 80 LC	80		B8HS	5510	0,5	B8HVX	2634	205	BR8HIX	7001
Ultra 80 AC	80	01.82 -	B7HS	5110	0,5	B7HVX	7836	204	BR7HIX	7067
XE 9	80	01.82 -	B8HS	5510	0,5	B8HVX	2634	205	BR8HIX	7001
K 100 X	100		B8HS	5510	0,5	B8HVX	2634	205	BR8HIX	7001
K 125 BW Military	125	09.74 -	B8HS	5510	0,5	B8HVX	2634	205	BR8HIX	7001
K 125 GS	125		B9ES	2611	0,5	B9EVX	7254	202	BR9EIX	3981
K 125 MC	125		B9ES	2611	0,5	B9EVX	7254	202	BR9EIX	3981
K 125 S	125	10.72 -08.79			0,5	B9EVX	7254		BR9EIX	3981

Order  
No.Platin  
Gold-  
Palla-  
diumOrder Quick  
No. No.Order  
No.**HERCULES**

K 125 T	125	10.72 -08.79			0,5	B9EVX	7254		BR9EIX	3981
K 125 X	125		B8HS	5510	0,5	B8HVX	2634	205	BR8HIX	7001
175 GS	175		B9ES	2611	0,5	B9EVX	7254	202	BR9EIX	3981
250 GS	250		B9ES	2611	0,5	B9EVX	7254	202	BR9EIX	3981
W 2000 (Wankel)	294		BR8ES	5422	0,5	BR8EVX	1262	207	BR8EIX	5044
350 GS	350				0,5	B9EVX	7254		BR9EIX	3981

**HESKETH**

V 1000	1000		DR8ES	5423	0,7	DR8EVX	6354	217	DR8EIX	6681
--------	------	--	-------	------	-----	--------	------	-----	--------	------

**HIGHLAND**

450MX	450		CR8E	1275	0,6	CR8EVX	6487	226	CR8EIX	4218
Allroad	450		CR8E	1275	0,6	CR8EVX	6487	226	CR8EIX	4218
Outback	450		CR8E	1275	0,6	CR8EVX	6487	226	CR8EIX	4218
Super Motard	450		CR8E	1275	0,6	CR8EVX	6487	226	CR8EIX	4218
Dirt Trac	750		CR8E	1275	0,6	CR8EVX	6487	226	CR8EIX	4218
Dessert Strom	950		CR8E	1275	0,6	CR8EVX	6487	226	CR8EIX	4218

**HM RACING**

Baja SX	50	98 -	B8ES	2411	0,5	B8EVX	7051	201	BR8EIX	5044
CRX Junior & Senior	50	01 -	B8HS	5510	0,5	B8HVX	2634	205	BR8HIX	7001
CRX Racing Junior & Senior	50	01 -	B8HS	5510	0,5	B8HVX	2634	205	BR8HIX	7001
Derapage	50	98 -	B8ES	2411	0,5	B8EVX	7051	201	BR8EIX	5044
MX Junior & Senior	50	01 -	B8HS	5510	0,5	B8HVX	2634	205	BR8HIX	7001
Six	50	98 -	B8ES	2411	0,5	B8EVX	7051	201	BR8EIX	5044

**HMZ**

Cruise 125	125	96 -	D8EA	2120	0,6	D8EVX	2850	216	DR8EIX	6681
------------	-----	------	------	------	-----	-------	------	-----	--------	------

**HONDA**

Camino PA 50	50	01.75 -12.87	BPR6HS	7022	0,7	BPR6HVX	2740	214	BPR6HIX	4085
CB 50	50		CR6HS	7023	0,7			223	CR6HIX	7274
CB 50 Y	50	01.73 -01.83	CR6HS	7023	0,7			223	CR6HIX	7274
CY 50	50	01.81 -	CR6HS	7023	0,7			223	CR6HIX	7274
Elite 50/S	50		BPR6HSA	4632	0,7	BPR6HVX	2740		BPR6HIX	4085
MB 50 F (AC01)	50		BR8HS	4322	0,8	BR8HVX	6265	212	BR8HIX	7001
MB 50 S (AC01)	50		BR7HS	4122	0,8			211	BR7HIX	7067
MBX 50 M (AC05)	50		BR9ES	5722	0,8	BR9EVX	1265	208	BR9EIX	3981
MBX 50 S (AC05)	50		BR9ES	5722	0,7	BR9EVX	1265	208	BR9EIX	3981
MBX 50 SD (AC05)	50		BR6ES	4922	0,7					
MR 50	50		BR6HS	3922	0,7			209	BR6HIX	3419
MT 50 F (AD04)	50		BR8HS	4322	0,7	BR8HVX	6265	212	BR8HIX	7001
MT 50 S (AD04)	50		BR6ES	4922	0,7					
MTX 50 R	50		BR8ES	5422	0,7	BR8EVX	1262	207	BR8EIX	5044
MTX 50 S	50	86 -	BR7HS	4122	0,7			211	BR7HIX	7067
NC 50	50		BPR4HS	7823	0,7					
NE 50	50		BPR6HSA	4632	0,7	BPR6HVX	2740		BPR6HIX	4085
NE 50 Vision	50	90 -	BR6HSA	4296	0,7			210	BR6HIX	3419
NSR 50	50	89 -	BR5ES	4722	0,8					
NT 50	50		BPR6HSA	4632	0,7	BPR6HVX	2740		BPR6HIX	4085
NX 50	50		BPR5HS	6222	0,7					
NX 50 M	50		BPR5HS	6222	0,7					

Order  
No.Platin  
Gold-  
Palla-  
diumOrder Quick  
No. No.

Iridium

Order  
No.**HONDA**

PA 50	50	84 -	BP6HS	4511	0,7	BP6HVX	4635		BPR6HIX	4085
PF 50	50		BR6HS	3922	0,7			209	BR6HIX	3419
PK 50 DX (AB25)	50	95 -	BR6HSA	4296	0,7			210	BR6HIX	3419
PK 50 Wallaroo	50	90 -	BR6HSA	4296	0,7			210	BR6HIX	3419
PM 50	50		BR6HS	3922	0,7			209	BR6HIX	3419
PX 50	50	84 -	BPR5HS	6222	0,7					
PX 50 E	50	80 -	BPR5HS	6222	0,7					
PX 50 R	50	85 -	BPR5HS	6222	0,7					
PZ 50	50		BR6HS	3922	0,7			209	BR6HIX	3419
SA 50 (AF29)	50		BR6HSA	4296	0,7			210	BR6HIX	3419
SE 50	50		BPR6HSA	4632	0,7	BPR6HVX	2740		BPR6HIX	4085
SFX 50	50	96 -	BR6HSA	4296	0,6			210	BR6HIX	3419
SH 50	50	01.84 -	BR8HS	4322	0,7	BR8HVX	6265	212	BR8HIX	7001
SH 50 T (AF40)	50	97 -	BR6HSA	4296	0,7			210	BR6HIX	3419
SJ 50 Bali	50		BR6HSA	4296	0,6			210	BR6HIX	3419
SS 50 (Z)	50		C7HSA	4629	0,6	C7HVX	4533		CR7HIX	7544
ST 50 C (AB23) Dax	50		CR6HSA	2983	0,7				CR6HIX	7274
TLM 50	50		BR8ES	5422	0,8	BR8EVX	1262	207	BR8EIX	5044
XL 50	50	01.80 -	CR6HS	7023	0,7			223	CR6HIX	7274
XR 50	50	93 - 02	CR6HSA	2983	0,7				CR6HIX	7274
XR 50 R	50	03 -	CR6HSA	2983	0,7				CR6HIX	7274
Z 50 GZ (Monkey)	50	01.80-12.84	CR6HS	7023	0,7			223	CR6HIX	7274
Z 50 J (Monkey)	50		CR6HS	7023	0,7			223	CR6HIX	7274
Z 50 R (Monkey)	50	94 -	CR6HSA	2983	0,7				CR6HIX	7274
ZB 50 P (AB22)(Monkey)	50	88 -	CR6HSA	2983	0,7				CR6HIX	7274
CT 70	70	92 -	CR6HSA	2983	0,7				CR6HIX	7274
ST 70	70	94 -	CR6HSA	2983	0,7				CR6HIX	7274
NS-1	75	96 -	BR8ECS	3972	0,7					
CR 80 R	80	86 -	BR10EG	3830	0,6					
CR 80 R	80	- 85	BR9ES	5722	0,8	BR9EVX	1265	208	BR9EIX	3981
CY 80	80		CR7HS	7223	0,7				CR7HIX	7544
MB 80 (HC01)	80	01.80 -	BR8HS	4322	0,7	BR8HVX	6265	212	BR8HIX	7001
MBX 80 SWD/SW2D (HC04)	80	87 -	BR9ES	5722	0,8	BR9EVX	1265	208	BR9EIX	3981
MCX 80 (HC05)	80	01.80 -	BR9ES	5722	0,8	BR9EVX	1265	208	BR9EIX	3981
MT 80 F	80		BR9HS	4522	0,7					
MT 80 S (HD02)	80		BR8HS	4322	0,7	BR8HVX	6265	212	BR8HIX	7001
MTX 80 C	80	82 -	BR9HS	4522	0,7					
MTX 80 R (D) (HD08)	80		BR9ES	5722	0,7	BR9EVX	1265	208	BR9EIX	3981
MTX 80 R (F) (HD08)	80		BR8ES	5422	0,7	BR8EVX	1262	207	BR8EIX	5044
MTX 80 R II (HD09)	80	87 -	BR9ES	5722	0,8	BR9EVX	1265	208	BR9EIX	3981
MTX 80 RS (HD08)	80	83 - 85	BR9ES	5722	0,8	BR9EVX	1265	208	BR9EIX	3981
NSR 80	80		BR8ES	5422	0,8	BR8EVX	1262	207	BR8EIX	5044
SH 80 E Scoopy	80	84 -	BPR6HS	7022	0,7	BPR6HVX	2740	214	BPR6HIX	4085
XR 80R	80	92 -	CR7HSA	4549	0,7				CR7HIX	7544
CR 85 R	85	03 -	BR10EG	3830	0,6					
CR 85 R 2	85	03 -	BR10EG	3830	0,6					
EZ 90	90	93 -	BR7HS	4122	0,7			211	BR7HIX	7067
NH 90 M	90	93 -	BPR6HSA	4632	0,7	BPR6HVX	2740		BPR6HIX	4085
NH 90 Yupy	90	90 -	BPR6HSA	4632	0,7	BPR6HVX	2740		BPR6HIX	4085
XR 100R	100	92 -	CR7HSA	4549	0,7				CR7HIX	7544
CG 110	110		DR8ESL	2923	0,7	DR8EVX	6354	218	DR8EIX	6681
CA 125 Rebel (JC24)	125	95 -	CR6HSA	2983	0,7				CR6HIX	7274

Order  
No.Gold-  
PalladiumOrder Quick  
No. No.Platin  
IridiumOrder  
No.**HONDA**

CA 125 C Rebel (JC26)	125	97 -	CR6HSA	2983	0,7					CR6HIX	7274
CB 125	125		DR8ES	5423	0,7	DR8EVX	6354	217		DR8EIX	6681
CB 125 K	125		D8HA	7012	0,7						
CB 125 T	125		CR8HS	7423	0,7	CR8HVX	7236			CR8HIX	7669
CB 125 Y	125		CR8HS	7423	0,7	CR8HVX	7236			CR8HIX	7669
CBR 125 R	125	04 - 06	CR9E	6263	0,7	CR9EVX	5943	227		CR9EIX	3521
CBR 125 R	125	07 -	CR8E	1275	0,7	CR8EVX	6487	226		CR8EIX	4218
CG 125 (JC27)	125	98 -	DPR8EA-9	4929	0,9	DPR8EVX-9	2872	221		DPR8EIX-9	2202
CG 125	125		DR8ESL	2923	0,6	DR8EVX	6354	218		DR8EIX	6681
CH 125	125		DPR7EA-9	5129	0,9	DPR7EVX-9	7682	220		DPR7EIX-9	7803
CLR 125 Cityfly (JD18A/B)	125	98 -	DPR8EA-9	4929	0,9	DPR8EVX-9	2872	221		DPR8EIX-9	2202
CM 125 (JC05)	125		CR7HS	7223	0,7					CR7HIX	7544
CM 125 C Custum	125	94 -	CR7HSA	4549	0,7					CR7HIX	7544
CR 125 R	125		BR9EG	3230	0,6	BR9EVX	1265			BR9EIX	3981
CR 125 R	125	03 -	BR9EG	3230	0,6	BR9EVX	1265			BR9EIX	3981
Italia 125 (I)	125		DR8ESL	2923	0,6	DR8EVX	6354	218		DR8EIX	6681
Lead 125 (JF01)	125		BPR6HS	7022	0,7	BPR6HVX	2740	214		BPR6HIX	4085
MBX 125 F	125		BR9ES	5722	0,7	BR9EVX	1265	208		BR9EIX	3981
MTX 125	125		BR9ES	5722	0,7	BR9EVX	1265	208		BR9EIX	3981
MTX 125 R (I)	125		BR8ES	5422	0,7	BR8EVX	1262	207		BR8EIX	5044
MTX 125 R2 (I)	125		BR9ES	5722	0,7	BR9EVX	1265	208		BR9EIX	3981
NS 125 F (I)	125		BR9ES	5722	0,6	BR9EVX	1265	208		BR9EIX	3981
NS 125 R (I)	125		BR9ES	5722	0,6	BR9EVX	1265	208		BR9EIX	3981
NSR 125 F	125		BR9ECS	3570	0,8						
NSR 125 R (JC22)	125		BR9ECS	3570	0,8						
NX 125	125		DR8ESL	2923	0,7	DR8EVX	6354	218		DR8EIX	6681
TL 125	125		DR8ESL	2923	0,6	DR8EVX	6354	218		DR8EIX	6681
Varadero 125	125	01 -	CR8EH-9	5666	0,9	CR8EHVX-9	4546	228		CR8EHIX-9	3797
VT 125 C Shadow (G-Type)	125		CR8EH-9	5666	0,9	CR8EHVX-9	4546	228		CR8EHIX-9	3797
XL 125 (I)	125		DR8ESL	2923	0,6	DR8EVX	6354	218		DR8EIX	6681
XL 125 R	125		DR8ESL	2923	0,7	DR8EVX	6354	218		DR8EIX	6681
XL 125 S	125		DR8ESL	2923	0,7	DR8EVX	6354	218		DR8EIX	6681
XL 125 V	125	07 -	CR8EH-9	5666	0,9	CR8EHVX-9	4546	228		CR8EHIX-9	3797
XLR 125 R	125	98 -	DPR8EA-9	4929	0,9	DPR8EVX-9	2872	221		DPR8EIX-9	2202
XR 125	125		DR8ESL	2923	0,7	DR8EVX	6354	218		DR8EIX	6681
XR 125 L	125	03 -	DPR9EA-9	5329	0,9	DPR9EVX-9	3854	222		DPR9EIX-9	5545
XR 125 L (ED)	125	03 -	DPR8EA-9	4929	0,9	DPR8EVX-9	2872	221		DPR8EIX-9	2202
CD 185 T	185		CR7HS	7223	0,7					CR7HIX	7544
CM 185 T	185	01.78 -	CR7HS	7223	0,7					CR7HIX	7544
XL 185 S	185	01.79 -	DR8ESL	2923	0,6	DR8EVX	6354	218		DR8EIX	6681
CD 200 T	200		CR7HS	7223	0,7					CR7HIX	7544
CM 200 T	200		CR7HS	7223	0,7					CR7HIX	7544
MTX 200 RW (MD07)	200	83 - 85	BR9ES	5722	0,7	BR9EVX	1265	208		BR9EIX	3981
TR 200	200		DR8ESL	2923	0,6	DR8EVX	6354	218		DR8EIX	6681
XL 200 R	200	01.83 -	DR8EA	7162	0,7	DR8EVX	6354			DR8EIX	6681
XR 200	200	- 83	DR8ESL	2923	0,6	DR8EVX	6354	218		DR8EIX	6681
XR 200	200	84 - 86	DPR9Z	4830	0,7						
XR 200	200	87 -	DR8ESL	2923	0,7	DR8EVX	6354	218		DR8EIX	6681
XR 200 R	200	- 83	DR8ESL	2923	0,7	DR8EVX	6354	218		DR8EIX	6681
XR 200 R	200	84 - 84	DPR9Z	4830	0,7						
XR 200 R	200	94 -	DR8ESL	2923	0,6	DR8EVX	6354	218		DR8EIX	6681
250 Spacy (I)	250		DPR6EA-9	5531	0,9						

Order  
No.Platin  
Gold-  
Palla-  
diumOrder Quick  
No. No.

Iridium

Order  
No.**HONDA**

CB 250 (MC26)	250	96 -	CR6HSA	2983	0,7				CR6HIX	7274
CB 250 N	250	01.80 -	DR8ES	5423	0,7	DR8EVX	6354	217	DR8EIX	6681
CB 250 Nighthawk	250	92 -	CR6HSA	2983	0,7				CR6HIX	7274
CB 250 RS (MC02)	250	01.80 -	DR8ES	5423	0,7	DR8EVX	6354	217	DR8EIX	6681
CB 250 T	250		DR8ESL	2923	0,7	DR8EVX	6354	218	DR8EIX	6681
CBF 250	250	04 - 05	CR8EH-9S	7750	0,9					
CBF 250	250	06 -	CR8EH-9	5666	0,9	CR8EHVX-9	4546	228	CR8EHIX-9	3797
CBX 250	250		DPR8EA-9	4929	0,9	DPR8EVX-9	2872	221	DPR8EIX-9	2202
CD 250 U	250		CR6HSA	2983	0,7				CR6HIX	7274
CH 250	250		DPR6EA-9	5531	0,9					
CJ 250 T	250	78 -	B8ES	2411	0,5	B8EVX	7051	201	BR8EIX	5044
CM 250 C (MC06)	250	01.82 -	CR7HS	7223	0,7				CR7HIX	7544
CM 250 T	250		DR8ES	5423	0,7	DR8EVX	6354	217	DR8EIX	6681
CMX 250 CT (MC13)	250	96 -	CR6HSA	2983	0,7				CR6HIX	7274
CMX 250 C (MC32B)	250	97 -	CR6HSA	2983	0,7				CR6HIX	7274
CR 250	250	87 -	BR9EG	3230	0,6	BR9EVX	1265		BR9EIX	3981
CR 250 R	250	82 - 02	BR8EG	3130	0,6					
CR 250 R	250	- 81			0,6	BR9EVX	1265		BR9EIX	3981
CR 250 R	250	03 -	BR8EG	3130	0,6					
CR 250 R	250	05 -	BR9EG-N8	2689	0,8					
CRF 250 R	250	04 - 04			0,9				IMR9C-9H	6777
CRF 250 R	250	05 -	R0409B-8		0,7					
EX 250	250		CR7HS	7223	0,7				CR7HIX	7544
NSR 250	250	93 - 96	BR9ECM	3252	0,6	BR9ECMVX	2434			
NX 250 J (MD21)	250	88 -	CR9EH-9	7502	0,9	CR9EHVX-9	3872	229	CR9EHIX-9	6216
NX 250 K (MD21)	250	89 -	CR9EH-9	7502	0,9	CR9EHVX-9	3872	229	CR9EHIX-9	6216
NX 250 L (MD25)	250	91 -	CR9EH-9	7502	0,9	CR9EHVX-9	3872	229	CR9EHIX-9	6216
TLR 250	250		DPR6EA-9	5531	0,9					
VT 250 F2	250		DPR8EA-9	4929	0,9	DPR8EVX-9	2872	221	DPR8EIX-9	2202
XL 250 R (MD11)	250	- 83	DR8ESL	2923	0,7	DR8EVX	6354	218	DR8EIX	6681
XL 250 R (MD11)	250	86 -	DPR9Z	4830	0,7					
XL 250 R (MD11)	250	84 - 85	DPR9Z	4830	0,8					
XL 250 S (MD11)	250	01.73 - 12.83	DR8ESL	2923	0,6	DR8EVX	6354	218	DR8EIX	6681
XR 250 L	250	92 -	DPR8Z	4730	0,7					
XR 250 R	250	- 83	DR8ESL	2923	0,6	DR8EVX	6354	218	DR8EIX	6681
XR 250 R / RN	250	84 -	DPR9Z	4830	0,7					
SH 280	280	11.06 -	LMAR8A-9	4313	0,9					
XL 350 R (ND03)	350	85 - 87	DPR8EA-9	4929	0,9	DPR8EVX-9	2872	221	DPR8EIX-9	2202
XR 350 R	350		DPR8EA-9	4929	0,9	DPR8EVX-9	2872	221	DPR8EIX-9	2202
400 Hawk (I)	400		DR8ES	5423	0,7	DR8EVX	6354	217	DR8EIX	6681
CB 400 A	400	01.79 -	DR8ES	5423	0,7	DR8EVX	6354	217	DR8EIX	6681
CB 400 N	400	01.78 - 12.84	DR8ES	5423	0,7	DR8EVX	6354	217	DR8EIX	6681
CB 400 T	400		DR8ES	5423	0,7	DR8EVX	6354	217	DR8EIX	6681
CB-1 (NC27)	400	91 -	CR8EH-9	5666	0,9	CR8EHVX-9	4546	228	CR8EHIX-9	3797
CBX 400 F	400		DPR9Z	4830	0,7					
CBX 400 F2	400		DPR9Z	4830	0,7					
CBX 400 SS (I)	400		DPR9Z	4830	0,7					
CM 400 T	400	01.80 - 12.84	DR8ES	5423	0,7	DR8EVX	6354	217	DR8EIX	6681
CX 400 C	400		DR8ESL	2923	0,7	DR8EVX	6354	218	DR8EIX	6681
CX 400 F2	400		DR8ESL	2923	0,7	DR8EVX	6354	218	DR8EIX	6681
NS 400	400		BR9ES	5722	0,8	BR9EVX	1265	208	BR9EIX	3981
NS 400 R (NC19)	400	85 -	BR9ES	5722	0,8	BR9EVX	1265	208	BR9EIX	3981

Order  
No.Platin  
Gold-  
Palla-  
diumOrder Quick  
No. No.Order  
No.**HONDA**

RVF 400 (NC35)	400		ER9EH	5869	0,6						
VF 400 F	400	01.85 -	DPR8EA-9	4929	0,9	DPR8EVX-9	2872	221	DPR8EIX-9	2202	
VFR 400 R (NC24)	400	87 -	C8EH-9	7473	0,7	C8EHVX-9	4450		CR8EHIX-9	3797	
VFR 400 R (NC30)	400	91 -	ER9EH	5869	0,7						
XL 400	400	01.84 -	DR8EA	7162	0,7	DR8EVX	6354		DR8EIX	6681	
XR 400 R	400	96 -	DPR8Z	4730	0,7						
CB 450 N (PC14)	450	85 -	DR8ES	5423	0,7	DR8EVX	6354	217	DR8EIX	6681	
CB 450 S (PC17)(D)	450	86 - 88	DR8ESL	2923	0,7	DR8EVX	6354	218	DR8EIX	6681	
CB 450 S (PC17)(I)	450		DR8ES	5423	0,7	DR8EVX	6354	217	DR8EIX	6681	
CMX 450 C	450		DPR8EA-9	4929	0,9	DPR8EVX-9	2872	221	DPR8EIX-9	2202	
CRF 450 R 4T	450	02 -			1,1				IFR8H-11	5068	
CRS R2 / R3	450	02 -			1,1				IFR9H-11	6588	
CR 480 R	480		BR8EG	3130	0,5						
CB 500 (PC26)	500	94 -	CR9EH-9	7502	0,9	CR9EHVX-9	3872	229	CR9EHIX-9	6216	
CB 500 (K1)	500	- 75			0,6	D7EVX	2734				
CB 500 (K3)	500	- 75	DR7ES	3123	0,6						
CB 500 (PC32)	500	96 -	CR8EH-9	5666	0,9	CR8EHVX-9	4546	228	CR8EHIX-9	3797	
CB 500 R	500		BR8EG	3130	0,5						
CB 500 / S (PC32)	500	98 -	CR8EH-9	5666	0,9	CR8EHVX-9	4546	228	CR8EHIX-9	3797	
CBF 500	500	04 -	CR8EH-9S	7750	0,9						
CBR 500 F	500		DPR8EA-9	4929	0,9	DPR8EVX-9	2872	221	DPR8EIX-9	2202	
CR 500	500		BR8EG	3130	0,5						
CX 500	500		DR8ESL	2923	0,7	DR8EVX	6354	218	DR8EIX	6681	
CX 500 C (PC01)	500	01.79 -12.84	DR8ESL	2923	0,7	DR8EVX	6354	218	DR8EIX	6681	
CX 500 E (PC06)	500	01.79 -12.84	DR8ESL	2923	0,6	DR8EVX	6354	218	DR8EIX	6681	
CX 500 Turbo (PC03)	500	01.83 -			0,9	DPR8EVX-9	2872		DPR8EIX-9	2202	
FT 500 (PC07)	500	01.82 -12.85	DR8EA	7162	0,7	DR8EVX	6354		DR8EIX	6681	
GB 500 (PC16)	500	92 -	DPR8EA-9	4929	0,9	DPR8EVX-9	2872	221	DPR8EIX-9	2202	
GL 500 (PC02)	500	01.79 -12.84	DR8ESL	2923	0,6	DR8EVX	6354	218	DR8EIX	6681	
NX 500	500		DPR8EA-9	4929	0,9	DPR8EVX-9	2872	221	DPR8EIX-9	2202	
VF 500 F (PC12)	500	84 -	DPR8EA-9	4929	0,9	DPR8EVX-9	2872	221	DPR8EIX-9	2202	
VF 500 F2 (PC12)	500	- 84	DPR8EA-9	4929	0,9	DPR8EVX-9	2872	221	DPR8EIX-9	2202	
VF 500 F2 (PC12)	500	85 -	DPR9EA-9	5329	0,9	DPR9EVX-9	3854	222	DPR9EIX-9	5545	
VT 500 C (PC08)	500	83 -	DPR8EA-9	4929	0,9	DPR8EVX-9	2872	221	DPR8EIX-9	2202	
VT 500 E (PC11)	500	83 - 85	DPR8EA-9	4929	0,9	DPR8EVX-9	2872	221	DPR8EIX-9	2202	
XBR 500 (PC15)	500	85 - 87	DPR8EA-9	4929	0,9	DPR8EVX-9	2872	221	DPR8EIX-9	2202	
XBR 500 S (PC15)	500	88 -	DPR8EA-9	4929	0,9	DPR8EVX-9	2872	221	DPR8EIX-9	2202	
XL 500 (I)	500		DR8ESL	2923	0,7	DR8EVX	6354	218	DR8EIX	6681	
XL 500 R (PD02)	500	86 -	DR8ES	5423	0,7	DR8EVX	6354	217	DR8EIX	6681	
XL 500 R (PD02)	500	- 85	DR8ESL	2923	0,7	DR8EVX	6354	218	DR8EIX	6681	
XL 500 S (PD01)	500	01.79 -12.81	DR8ESL	2923	0,7	DR8EVX	6354	218	DR8EIX	6681	
XR 500	500		DR8ESL	2923	0,7	DR8EVX	6354	218	DR8EIX	6681	
XR 500 R	500		DPR8EA-9	4929	0,9	DPR8EVX-9	2872	221	DPR8EIX-9	2202	
CB 550	550	06.71 -12.87	DR7ES	3123	0,7						
CB 550 (F1/F2)	550	76 -			0,6	D7EVX	2734				
CB 550 (K3/4)	550	76 -	DR7ES	3123	0,6						
CB 550 F	550	06.71 -12.87	DR7ES	3123	0,7						
CBX 550 F (PC04)	550		DR8ES	5423	0,7	DR8EVX	6354	217	DR8EIX	6681	
CBX 550 F2 (PC04)	550		DR8ES	5423	0,7	DR8EVX	6354	217	DR8EIX	6681	
600 V Transalp (PD06)	600	87 -	DPR8EA-9	4929	0,9	DPR8EVX-9	2872	221	DPR8EIX-9	2202	
CB 600 F W (PC34A/B/D) Hornet	600	98 -	CR9EH-9	7502	0,9	CR9EHVX-9	3872	229	CR9EHIX-9	6216	
CB 600 F W (PC34A/B/D)	600	98 -	CR9EH-9	7502	0,9	CR9EHVX-9	3872	229	CR9EHIX-9	6216	



Order  
No.Platin  
Gold-  
Palla-  
diumOrder Quick  
No. No.

Iridium

Order  
No.**HONDA**

CB 600 F / FA Hornet	600	07 -	CR9EH-9	7502	0,9	CR9EHVX-9	3872	229	CR9EHIX-9	6216
CBF 600 (ED) Hornet	600	04 -	CR9EH-9	7502	0,9	CR9EHVX-9	3872	227	CR9EHIX-9	6216
CBF 600 F (ED) Hornet	600	04 -	CR9EH-9	7502	0,9	CR9EHVX-9	3872	227	CR9EHIX-9	6216
CBR 600 F3 (PC31)	600	95 - 98	CR9EH-9	7502	0,9	CR9EHVX-9	3872	229	CR9EHIX-9	6216
CBR 600 F2 (PC25)	600	93 - 94	CR9EH-9	7502	0,9	CR9EHVX-9	3872	229	CR9EHIX-9	6216
CBR 600 F (PC25)	600	91 - 94	CR9EH-9	7502	0,9	CR9EHVX-9	3872	229	CR9EHIX-9	6216
CBR 600 F (PC19)	600	87 - 88	DPR8EA-9	4929	0,9	DPR8EVX-9	2872	221	DPR8EIX-9	2202
CBR 600 F (PC23)	600	89 - 90	DPR9EA-9	5329	0,9	DPR9EVX-9	3854	222	DPR9EIX-9	5545
CBR 600 FS (PC35)	600	01 - 02			0,9				IMR9C-9H	6777
CBR 600 F (PC35)	600	01 -			0,9				IMR9C-9H	6777
CBR 600 F X (PC35)	600	99 - 01	CR9EH-9	7502	0,9	CR9EHVX-9	3872	229	CR9EHIX-9	6216
CBR 600 RR (PC37)(G)	600	03 - 04			0,9				IMR9C-9H	6777
CBR 600 RR (PC37)	600	05 - 06			0,9				IMR9C-9HES	5766
CBR 600 RR Movistar	600	06 -			0,9				IMR9C-9H	6777
CBR 600 RR (PC40)	600	07 -			0,9				IMR9C-9H	6777
CBX 600 E	600	01.83 - 12.87	DPR8EA-9	4929	0,9	DPR8EVX-9	2872	221	DPR8EIX-9	2202
NTV 600	600		DPR8EA-9	4929	0,9	DPR8EVX-9	2872	221	DPR8EIX-9	2202
NX 600	600		DPR8EA-9	4929	0,9	DPR8EVX-9	2872	221	DPR8EIX-9	2202
VT 600 / D	600	93 - 00	DPR8EA-9	4929	0,9	DPR8EVX-9	2872	221	DPR8EIX-9	2202
VT 600 C (PC21)	600	88 - 93	DPR8EA-9	4929	0,9	DPR8EVX-9	2872	221	DPR8EIX-9	2202
VT 600 C Shadow (I)	600	01.88 - 93	DPR8EA-9	4929	0,9	DPR8EVX-9	2872	221	DPR8EIX-9	2202
XL 600 L	600		DPR8EA-9	4929	0,9	DPR8EVX-9	2872	221	DPR8EIX-9	2202
XL 600 LM (PD04)	600	85 - 87	DPR8EA-9	4929	0,9	DPR8EVX-9	2872	221	DPR8EIX-9	2202
XL 600 R (PD03)	600	83 - 87	DPR8EA-9	4929	0,9	DPR8EVX-9	2872	221	DPR8EIX-9	2202
XL 600 RM (I)	600		DPR8EA-9	4929	0,9	DPR8EVX-9	2872	221	DPR8EIX-9	2202
XL 600 RM (PD04)	600	86 -	DPR8EA-9	4929	0,9	DPR8EVX-9	2872	221	DPR8EIX-9	2202
XL 600 V / VN	600	87 -	DPR8EA-9	4929	0,9	DPR8EVX-9	2872	221	DPR8EIX-9	2202
XR 600 / V	600		DPR8EA-9	4929	0,9	DPR8EVX-9	2872	221	DPR8EIX-9	2202
XR 600 R / L	600	01.87 -	DPR8EA-9	4929	0,9	DPR8EVX-9	2872	221	DPR8EIX-9	2202
FX 650 (RD09) Vigor	650	99 -	DPR8EA-9	4929	0,9	DPR8EVX-9	2872	221	DPR8EIX-9	2202
CB 650 (RC03)	650	01.80 -	DR8ESL	2923	0,7	DR8EVX	6354	218	DR8EIX	6681
CB 650 C (RC05)	650		DR8ESL	2923	0,7	DR8EVX	6354	218	DR8EIX	6681
CB 650 SC (RC08)	650	01.80 -	DPR8EA-9	4929	0,9	DPR8EVX-9	2872	221	DPR8EIX-9	2202
CB 650 Z	650		DR8ESL	2923	0,7	DR8EVX	6354	218	DR8EIX	6681
CBX 650 E (RC13)	650	83 -	DPR9EA-9	5329	0,9	DPR9EVX-9	3854	222	DPR9EIX-9	5545
CBX 650 Night Hawk(I)	650		DPR9EA-9	5329	0,9	DPR9EVX-9	3854	222	DPR9EIX-9	5545
CX 650 C (RC11)	650	01.83 -	DPR8EA-9	4929	0,9	DPR8EVX-9	2872	221	DPR8EIX-9	2202
CX 650 E (RC13)	650	01.83 -	DPR8EA-9	4929	0,9	DPR8EVX-9	2872	221	DPR8EIX-9	2202
CX 650 Turbo (RC16)	650	01.82 -			0,9	DPR8EVX-9	2872		DPR8EIX-9	2202
Deauville NT 650 V (RC47) (647cc)	650	98 -	DPR8EA-9	4929	0,9	DPR8EVX-9	2872	221	DPR8EIX-9	2202
FMX 650	650	05 -	DPR8EA-9	4929	0,9	DPR8EVX-9	2872	221	DPR8EIX-9	2202
GL 650 (RC10)	650	01.83 -	DPR8EA-9	4929	0,9	DPR8EVX-9	2872	221	DPR8EIX-9	2202
NTV 650 (RC33)	650	88 -	DPR8EA-9	4929	0,9	DPR8EVX-9	2872	221	DPR8EIX-9	2202
NTV 650 Revere (I)	650	01.88 -	DPR8EA-9	4929	0,9	DPR8EVX-9	2872	221	DPR8EIX-9	2202
NX 650 (RD02)/Dominator	650	88 -	DPR8EA-9	4929	0,9	DPR8EVX-9	2872	221	DPR8EIX-9	2202
NX 650 Dominator (RD08)(I)	650	01.88 -	DPR8EA-9	4929	0,9	DPR8EVX-9	2872	221	DPR8EIX-9	2202
SLR 650 (RD09)	650	97 -	DPR8EA-9	4929	0,9	DPR8EVX-9	2872	221	DPR8EIX-9	2202
XL 650L	650	94 -	DPR8EA-9	4929	0,9	DPR8EVX-9	2872	221	DPR8EIX-9	2202
Transalp XL 650	650	94 -	DPR8EA-9	4929	0,9	DPR8EVX-9	2872	221	DPR8EIX-9	2202
XR 650 R (R1)	650	00 -	BKR8E-11	6587	1,1					
XRV 650 (RD03)	650	88 -	DPR8EA-9	4929	0,9	DPR8EVX-9	2872	221	DPR8EIX-9	2202
Deauville (680cc) 3Ventil	700	05 - 06	DPR8EA-9	4929	0,9	DPR8EVX-9	2872	221	DPR8EIX-9	2202

Order  
No.Platin  
Gold-  
Palla-  
diumOrder  
No.Quick  
No.

Iridium

Order  
No.**HONDA**

Deauville (680cc) 4Ventil RC52	700	06 -	CPR8EA-9	2306	0,9						
VT 700 C	700		DPR7EA-9	5129	0,9	DPR7EVX-9	7682	220	DPR7EIX-9	7803	
CB 750 (RC42)	750	92 -	DPR8EA-9	4929	0,9	DPR8EVX-9	2872	221	DPR8EIX-9	2202	
CB 750 (RC04)	750	01.82 -12.83	DR8EA	7162	0,7	DR8EVX	6354		DR8EIX	6681	
CB 750 C (RC06)	750	01.80 -	DR8ES	5423	0,7	DR8EVX	6354	217	DR8EIX	6681	
CB 750 F	750	- 91	DR8ES	5423	0,7	DR8EVX	6354	217	DR8EIX	6681	
CB 750 F2	750		DR8ES	5423	0,7	DR8EVX	6354	217	DR8EIX	6681	
CB 750 F2N / FI	750	91 -	DPR8EA-9	4929	0,9	DPR8EVX-9	2872	221	DPR8EIX-9	2202	
CB 750 FA (I)	750		DR8ES	5423	0,7	DR8EVX	6354	217	DR8EIX	6681	
CB 750 Four (I)	750		DR8ESL	2923	0,7	DR8EVX	6354	218	DR8EIX	6681	
CB 750 FZ	750		DR8ESL	2923	0,7	DR8EVX	6354	218	DR8EIX	6681	
CB 750 K	750	01.82 -12.83	DR8ES	5423	0,7	DR8EVX	6354	217	DR8EIX	6681	
CB 750 KZ	750		DR8ESL	2923	0,9	DR8EVX	6354	218	DR8EIX	6681	
CB Seven Fifty	750		DPR8EA-9	4929	0,9	DPR8EVX-9	2872	221	DPR8EIX-9	2202	
CBX 750 F (RC17)	750	84 - 86	DPR8EA-9	4929	0,9	DPR8EVX-9	2872	221	DPR8EIX-9	2202	
CBX 750 F2	750		DPR9EA-9	5329	0,9	DPR9EVX-9	3854	222	DPR9EIX-9	5545	
NR 750 (RC40)	750	93 -	CR9EH-9	7502	0,9	CR9EHVX-9	3872	229	CR9EHIX-9	6216	
RVF (RC45)	750	94 -			0,9	CR9EHVX-9	3872		CR9EHIX-9	6216	
Shadow 750	750	04 -	DPR8EA-9	4929	0,9	DPR8EVX-9	2872	221	DPR8EIX-9	2202	
VF 750 C	750	95 - 00	CR8EH-9	5666	0,9	CR8EHVX-9	4546	228	CR8EHIX-9	3797	
VF 750 C Magna	750	94 - 95	CR8EH-9	5666	0,9	CR8EHVX-9	4546	228	CR8EHIX-9	3797	
VF 750 C (RC09)	750	82 - 84	DPR8EA-9	4929	0,9	DPR8EVX-9	2872	221	DPR8EIX-9	2202	
VF 750 C (RC09)	750	86 - 94	DPR9EA-9	5329	0,9	DPR9EVX-9	3854	222	DPR9EIX-9	5545	
VF 750 C (RC44)	750	97 - 00	DPR9EA-9	5329	0,9	DPR9EVX-9	3854	222	DPR9EIX-9	5545	
VF 750 F (RC15)	750	83 - 84	DPR8EA-9	4929	0,9	DPR8EVX-9	2872	221	DPR8EIX-9	2202	
VF 750 S (RC07)	750	82 - 83	DPR8EA-9	4929	0,9	DPR8EVX-9	2872	221	DPR8EIX-9	2202	
VFR 750 F	750	94 -	CR8EH-9	5666	0,9	CR8EHVX-9	4546	228	CR8EHIX-9	3797	
VFR 750 F (I)	750		DPR9EA-9	5329	0,9	DPR9EVX-9	3854	222	DPR9EIX-9	5545	
VFR 750 F (RC24)	750	86 - 87	DPR8EA-9	4929	0,9	DPR8EVX-9	2872	221	DPR8EIX-9	2202	
VFR 750 F (RC24)	750	88 - 89	DPR9EA-9	5329	0,9	DPR9EVX-9	3854	222	DPR9EIX-9	5545	
VFR 750 F (RC36)	750	90 - 94	CR8EH-9	5666	0,9	CR8EHVX-9	4546	228	CR8EHIX-9	3797	
VFR 750 FJ (I)	750		DPR9EA-9	5329	0,9	DPR9EVX-9	3854	222	DPR9EIX-9	5545	
VFR 750 R (RC30)	750	88 -	CR9EH-9	7502	0,9	CR9EHVX-9	3872	229	CR9EHIX-9	6216	
VT 750 Black Widow (RC48)	750	00 -	DPR8EA-9	4929	0,9	DPR8EVX-9	2872	221	DPR8EIX-9	2202	
VT 750 C (RC29)	750	87 -	DPR8EA-9	4929	0,9	DPR8EVX-9	2872	221	DPR8EIX-9	2202	
VT 750 C/C2V (RC44)	750	97 -	DPR8EA-9	4929	0,9	DPR8EVX-9	2872	221	DPR8EIX-9	2202	
VT 750 C (RC53A) Schadow Spirit	750	06 -	DPR7EA-9	5129	0,9	DPR7EVX-9	7682	220	DPR7EIX-9	7803	
XLV 750 R (RD01)	750	83 -	DPR8EA-9	4929	0,9	DPR8EVX-9	2872	221	DPR8EIX-9	2202	
XRV 750 (RD04)	750	90 - 92	DPR8EA-9	4929	0,9	DPR8EVX-9	2872	221	DPR8EIX-9	2202	
XRV 750 (RD07)	750	93 -	DPR8EA-9	4929	0,9	DPR8EVX-9	2872	221	DPR8EIX-9	2202	
PC 800 Pacific Coast	800	98 -	DPR7EA-9	5129	0,9	DPR7EVX-9	7682	220	DPR7EIX-9	7803	
VFR / VFR ABS	800	02 -			0,9				IMR9B-9H	4888	
VFR 800 FI W (RC46)	800	98 -	CR9EH-9	7502	0,9	CR9EHVX-9	3872	229	CR9EHIX-9	6216	
CB 900 F	900	01.79 -	DR8ES	5423	0,7	DR8EVX	6354	217	DR8EIX	6681	
CB 900 F2	900	01.79 -12.83	DR8ES	5423	0,7	DR8EVX	6354	217	DR8EIX	6681	
CBR 900 RR (SC33)	900	96 -	CR9EH-9	7502	0,9	CR9EHVX-9	3872	229	CR9EHIX-9	6216	
CBR 900 RR (SC28)	900	91 -	CR9EH-9	7502	0,9	CR9EHVX-9	3872	229	CR9EHIX-9	6216	
CBR 900 RRY (Fireblade)(SC44)	900	00 -			0,9				CR9EHI-9	6419	
Hornet 900	900	02 -	CR8EH-9	5666	0,9	CR8EHVX-9	4546	228	CR8EHIX-9	3797	
CBR 900 RR Fireblade 2002 (SC50)	950	02 -			0,9				IMR9C-9H	6777	
CB 1000 F (SC30)	1000	93 - 00	DPR9EA-9	5329	0,9	DPR9EVX-9	3854	222	DPR9EIX-9	5545	
CBF 1000	1000	06 -	CR8EH-9	5666	0,9	CR8EHVX-9	4546	228	CR8EHIX-9	3797	

Order  
No.Platin  
Gold-  
Palla-  
diumOrder Quick  
No. No.

Iridium

Order  
No.**HONDA**

CBR 1000 RR Fireblade	1000	04 -			0,9				IMR9C-9HES	5766
CBR 1000 F (SC24)	1000	95 - 00	DPR9EA-9	5329	0,9	DPR9EVX-9	3854	222	DPR9EIX-9	5545
CBR 1000 F (SC21)	1000	87 - 88	DPR9EA-9	5329	0,9	DPR9EVX-9	3854	222	DPR9EIX-9	5545
CBR 1000 F (SC24)	1000	89 - 92	DPR9EA-9	5329	0,9	DPR9EVX-9	3854	222	DPR9EIX-9	5545
CBR 1000 Fireblade Repsol	1000	07 -			0,9				IMR9C-9HES	5766
CBR 1000 Fireblade (G)	1000	04 -			0,9				IMR9C-9HES	5766
CBR 1000 K (I)	1000		DPR9EA-9	5329	0,9	DPR9EVX-9	3854	222	DPR9EIX-9	5545
GL 1000 (GL1)	1000		DR8ESL	2923	0,7	DR8EVX	6354	218	DR8EIX	6681
Varadero 1000 (SD02)	1000	03 -			0,9				IJR8B-9	4873
Varadero XL 1000 V X (SD01)	1000	99 -			0,9	DPR8EVX-9	2872		DPR8EIX-9	2202
Varadero XL 1000 V (G)(SD02) 69kW	1000	03 -			0,9				IJR8B-9	4873
VF 1000 Bol D'Dor(I)	1000		DPR9EA-9	5329	0,9	DPR9EVX-9	3854	222	DPR9EIX-9	5545
VF 1000 F	1000	- 86	DPR9EA-9	5329	0,9	DPR9EVX-9	3854	222	DPR9EIX-9	5545
VF 1000 F (SC15)	1000	87 -	DPR8EA-9	4929	0,9	DPR8EVX-9	2872	221	DPR8EIX-9	2202
VF 1000 F2 (SC15)	1000	85 -	DPR9EA-9	5329	0,9	DPR9EVX-9	3854	222	DPR9EIX-9	5545
VF 1000 R (SC16)	1000	84 - 86	DPR8EA-9	4929	0,9	DPR8EVX-9	2872	221	DPR8EIX-9	2202
VTR 1000 F (SC36)	1000	97 -			0,9	DPR9EVX-9	3854		DPR9EIX-9	5545
VTR1000 SP-1	1000	00 - 01			1,1				FR9BI-11	4709
VTR1000 SP-2	1000	02 -			1,1				IFR9H-11	6588
CBX 1000 (CB1)	1050		DR8ESL	2923	0,7	DR8EVX	6354	218	DR8EIX	6681
CB 1100 F (SC11)	1100		DR8ES	5423	0,7	DR8EVX	6354	217	DR8EIX	6681
CB 1100 R (SC08)	1100		DR8ES	5423	0,7	DR8EVX	6354	217	DR8EIX	6681
CBR 1100 XX Super Blackbird	1100	01 -			0,9				IMR9C-9H	6777
CBR 1100 XX (SC35)	1100	97 - 00			0,9	CR9EHVX-9	3872		CR9EHIX-9	6216
GL 1100 (SC02)	1100	82 -	DPR8EA-9	4929	0,9	DPR8EVX-9	2872	221	DPR8EIX-9	2202
GL 1100 (SC02)	1100	- 81	DR8ESL	2923	0,7	DR8EVX	6354	218	DR8EIX	6681
GL 1100 DX (SC02)	1100	82 -	DPR8EA-9	4929	0,9	DPR8EVX-9	2872	221	DPR8EIX-9	2202
GL 1100 DX (SC02)	1100	- 81	DR8ESL	2923	0,7	DR8EVX	6354	218	DR8EIX	6681
GL 1100 R	1100		DR8ES	5423	0,7	DR8EVX	6354	217	DR8EIX	6681
ST 1100 CBS	1100	96 -	CR8EH-9	5666	0,8	CR8EHVX-9	4546	228	CR8EHIX-9	3797
ST 1100 (SC26)	1100	90 -	CR8EH-9	5666	0,9	CR8EHVX-9	4546	228	CR8EHIX-9	3797
ST 1100 AN (SC26)	1100	92 -	CR8EH-9	5666	0,9	CR8EHVX-9	4546	228	CR8EHIX-9	3797
VF 1100 C (SC12)	1100	83 -	DPR8EA-9	4929	0,9	DPR8EVX-9	2872	221	DPR8EIX-9	2202
VT 1100 C3 W Shadow Aero(SC39A/E/C)	1100	98 - 00	DPR7EA-9	5129	0,9	DPR7EVX-9	7682	220	DPR7EIX-9	7803
VT 1100 C	1100	95 - 00	DPR7EA-9	5129	0,9	DPR7EVX-9	7682	220	DPR7EIX-9	7803
VT 1100 C (SC23)	1100	88 - 95	DPR7EA-9	5129	0,9	DPR7EVX-9	7682	220	DPR7EIX-9	7803
VT 1100 C (SC23)	1100	94 - 95	DPR8EA-9	4929	0,9	DPR8EVX-9	2872	221	DPR8EIX-9	2202
VT 1100 C2 (SC32)	1100	95 -	DPR7EA-9	5129	0,9	DPR7EVX-9	7682	220	DPR7EIX-9	7803
X-Eleven	1100	00 -			0,9	CR8EHVX-9	4546		CR8EHIX-9	3797
GL 1200 (SC14)	1200	84 - 87	DPR8EA-9	4929	0,9	DPR8EVX-9	2872	221	DPR8EIX-9	2202
CB 1300	1300	03 -	DPR9EA-9	5329	0,9	DPR9EVX-9	3854	222	DPR9EIX-9	5545
CB 1300 S	1300	05 -	DPR8EA-9	4929	0,9	DPR8EVX-9	2872	221	DPR8EIX-9	2202
Pan European (SC51)	1300	02 -	CR8EH-9	5666	0,9	CR8EHVX-9	4546	228	CR8EHIX-9	3797
VTX 1300	1300	03 -	DCPR6E	3481	0,8					
VTX 1300S	1300	03 -	DCPR6E	3481	0,8					
X 4	1300	97 -	DPR9EA-9	5329	0,9	DPR9EVX-9	3854	222	DPR9EIX-9	5545
F 6 C	1500	11.96 -	DPR7EA-9	5129	0,9	DPR7EVX-9	7682	220	DPR7EIX-9	7803
GL 1500 (SC22)	1500	89 - 93	DPR7EA-9	5129	0,9	DPR7EVX-9	7682	220	DPR7EIX-9	7803
GL 1500 C F6C (SC34)	1500	97 -	DPR7EA-9	5129	0,9	DPR7EVX-9	7682	220	DPR7EIX-9	7803
GL 1500 C (SC34)	1500	97 -	DPR7EA-9	5129	0,9	DPR7EVX-9	7682	220	DPR7EIX-9	7803
GL 1500 SE.A	1500	95 -	DPR7EA-9	5129	0,9	DPR7EVX-9	7682	220	DPR7EIX-9	7803
GL 1500A/SE	1500	94 - 94	DPR6EA-9	5531	0,9					

Order  
No.Platin  
Gold-  
Palla-  
diumOrder Quick  
No. No.Order  
No.**HONDA**

VTX 1500 (Twinspark)	1500	03 -			1,1					IFR6L11	3687
Gold Wing (GL1800)	1800	01 -	BKR6E-11	2756	1,1	BKR6EVX-11	3540			BKR6EIX-11	3764
VTX 1800	1800	01 -			1,1					IFR6L-11	3678

**HOREX**

Regina 400 ( Alukopf)	400	53 - 56	BR8ES	5422	0,6	BR8EVX	1262	207		BR8EIX	5044
-----------------------	-----	---------	-------	------	-----	--------	------	-----	--	--------	------

**HRD**

Slide Sonic Supermotorrad	50	98 -	BR8ES	5422	0,6	BR8EVX	1262	207		BR8EIX	5044
GS Enduro	50	98 - 99	BR8ES	5422	0,6	BR8EVX	1262	207		BR8EIX	5044
Sonic 2 SM	50	99 -	BR8ES	5422	0,6	BR8EVX	1262	207		BR8EIX	5044
Sonic 2 Trail	50	99 -	BR8ES	5422	0,6	BR8EVX	1262	207		BR8EIX	5044
Super Mot. Cabr.	125	99 -	CR9EB	6955	0,7					CR9EIX	3521
Trail Cabr.	125	99 -	CR9EB	6955	0,7					CR9EIX	3521

**HUSABERG**

FE 350	350	91 - 99	C8E	7471	0,7	CR8EVX	6487			CR8EIX	4218
MC 350	350		99	C8E	7471	0,7	CR8EVX	6487		CR8EIX	4218
400	400	03 -			0,6	DCPR8EVX	2265				
FC 400	400	97 - 99	C8E	7471	0,7	CR8EVX	6487			CR8EIX	4218
FE 400	400	97 - 99	C8E	7471	0,7	CR8EVX	6487			CR8EIX	4218
FE 400 e	400	00 - 02	DCPR8E	4179	0,6	DCPR8EVX	2265			DCPR8EIX	6546
FS 400 c	400	00 - 02	DCPR8E	4179	0,6	DCPR8EVX	2265			DCPR8EIX	6546
FS 400 e	400	00 - 02	DCPR8E	4179	0,6	DCPR8EVX	2265			DCPR8EIX	6546
450	450	03 -			0,6	DCPR8EVX	2265				
FE 450 e	450	00 -	DCPR8E	4179	0,6	DCPR8EVX	2265			DCPR8EIX	6546
FC 470/6	470	00 - 02	DCPR8E	4179	0,6	DCPR8EVX	2265			DCPR8EIX	6546
FX 470 e	470	00 - 02	DCPR8E	4179	0,6	DCPR8EVX	2265			DCPR8EIX	6546
FC 499MX	499	95 - 99	C8E	7471	0,7	CR8EVX	6487			CR8EIX	4218
FE 500	500	91 - 94	C8E	7471	0,7	CR8EVX	6487			CR8EIX	4218
FE 500	500	91 - 99	C8E	7471	0,7	CR8EVX	6487			CR8EIX	4218
FE 501 e	500	00 -	DCPR8E	4179	0,6	DCPR8EVX	2265			DCPR8EIX	6546
MC 501	500	- 99	C8E	7471	0,7	CR8EVX	6487			CR8EIX	4218
501	501	03 -			0,6	DCPR8EVX	2265				
FC 501	501	95 - 99	C8E	7471	0,7	CR8EVX	6487			CR8EIX	4218
FE 501 E	501	93 - 99	C8E	7471	0,7	CR8EVX	6487			CR8EIX	4218
FE 501	501	93 - 99	C8E	7471	0,7	CR8EVX	6487			CR8EIX	4218
FX 501	501	97 - 99	C8E	7471	0,7	CR8EVX	6487			CR8EIX	4218
FX 501	501	97 - 99	C8E	7471	0,7	CR8EVX	6487			CR8EIX	4218
550	550	03 -			0,6	DCPR8EVX	2265				
FC 550/4	550	00 -	DCPR8E	4179	0,6	DCPR8EVX	2265			DCPR8EIX	6546
FC 550/6	550	00 -	DCPR8E	4179	0,6	DCPR8EVX	2265			DCPR8EIX	6546
FE 550 e	550	00 -	DCPR8E	4179	0,6	DCPR8EVX	2265			DCPR8EIX	6546
FS 550 e	550	00 -	DCPR8E	4179	0,6	DCPR8EVX	2265			DCPR8EIX	6546
FC 600	600	92 - 99	C8E	7471	0,7	CR8EVX	6487			CR8EIX	4218
FE 600	600	92 - 99	C8E	7471	0,7	CR8EVX	6487			CR8EIX	4218
FES 600 E	600	98 - 99	C8E	7471	0,7	CR8EVX	6487			CR8EIX	4218
FX 600	600	97 - 99	C8E	7471	0,7	CR8EVX	6487			CR8EIX	4218
FX 600	600	97 - 99	C8E	7471	0,7	CR8EVX	6487			CR8EIX	4218
FX 600 E	600	97 - 99	C8E	7471	0,7	CR8EVX	6487			CR8EIX	4218
MC 600	600	- 99	C8E	7471	0,7	CR8EVX	6487			CR8EIX	4218
650	650	03 -			0,6	DCPR8EVX	2265				

Order  
No.Platin  
Gold-  
Palla-  
diumOrder Quick  
No. No.

Iridium

Order  
No.**HUSABERG**

FE 650 e	650	00 -	DCPR8E	4179	0,6	DCPR8EVX	2265		DCPR8EIX	6546
FS 650 c	650	00 -	DCPR8E	4179	0,6	DCPR8EVX	2265		DCPR8EIX	6546
FS 650 e	650	00 -	DCPR8E	4179	0,6	DCPR8EVX	2265		DCPR8EIX	6546
FS 650 c	650	00 -	DCPR8E	4179	0,6	DCPR8EVX	2265		DCPR8EIX	6546
FS 650 e	650	00 -	DCPR8E	4179	0,6	DCPR8EVX	2265		DCPR8EIX	6546
FX 650 e	650	00 -	DCPR8E	4179	0,6	DCPR8EVX	2265		DCPR8EIX	6546

**HUSQVARNA**

Husky boy basic	50	01 -	B8HS	5510	0,5	B8HVX	2634	205	BR8HIX	7001
Husky boy junior	50	01 -	B6HS	4510	0,5	B6HVX	7435	203	BR6HIX	3419
Husky boy senior	50	01 -	B6HS	4510	0,5	B6HVX	7435	203	BR6HIX	3419
Husky boy racing	50	01 -	B6HS	4510	0,5	B6HVX	7435	203	BR6HIX	3419
SM 50	50	02 -	BR9ES	5722	0,6	BR9EVX	1265	208	BR9EIX	3981
WRE 50	50	02 -	BR9ES	5722	0,6	BR9EVX	1265	208	BR9EIX	3981
125 CR	125	92 - 94			0,5	B10EGV	5927			
125 CR	125	90 - 91			0,6	B10EGV	5927			
125 CR	125	97 -			0,5	B10EGV	5927			
CR 125	125	01 -			0,5	BR9EG	3230			
125 CR	125	99 - 00			0,5	BR9EG	3230			
125 NWR	125	99 -			0,5	B95EGV	2145			
125 SM	125	99 -	BR9EG	3230	0,5	BR9EVX	1265		BR9EIX	3981
125 WER	125	99 -	BR9EG	3230	0,5	BR9EVX	1265		BR9EIX	3981
125 WR	125	93 - 94			0,5	B9EGV	5827			
125 WR	125	95 - 00			0,5	B10EGV	5927			
125 WR	125	90 - 92			0,5	B95EGV	2145			
125 WRE	125	98 - 01	B9EG	3530	0,7	B9EGV	5827		BR9EIX	3981
SM 125 / S	125	02 -			0,5	BR9EG	3230			
TC 125	125		BR9EG	3230	0,5	BR9EVX	1265		BR9EIX	3981
WR 125	125	01 -			0,5	BR9EG	3230			
WRE 125	125	02 -	B9EG	3530	0,7	B9EGV	5827		BR9EIX	3981
250 CR	250	90 -			0,5	B9EGV	5827			
250 CR	250	95 - 00			0,5	B9EGV	5827			
250 CR	250	92 - 92			0,5	B9EGV	5827			
250 CR	250	93 - 94			0,6	B10EGV	5927			
250 CR	250	01 -	BR8EG	3130	0,8					
250 WR	250	92 - 95			0,5	B9EGV	5827			
250 WR (5A00)	250	96 - 99			0,6	B9EGV	5827			
250 WR	250	99 -	B8EG	3430	0,5	B8EGV	5627			
260 WR	250	90 -			0,5	B9EGV	5827			
CR 250	250	01 -	BR8EG	3130	0,6					
TC 250	250	01 -	CR8EB	7784	0,6	CR8EVX	6487		CR8EIX	4218
TE 250 / R	250	01 -	CR8EB	7784	0,6	CR8EVX	6487		CR8EIX	4218
WR 250	250	01 -	B8EG	3430	0,5	B8EGV	5627			
350 TE	350	90 -	C7E	5096	0,7				CR7EIX	7385
350 TE	350	95 -	C7E	5096	0,7				CR7EIX	7385
360 CR	360	91 -			0,5	B8EGV	5627			
360 WR	360	91 - 97			0,5	B8EGV	5627			
360 WR	360	98 - 00	B8EG	3430	0,5	B8EGV	5627			
360 WXC	360	98 -	B8EG	3430	0,5	B8EGV	5627			
WR 360	360	01 -	B8EG	3430	0,5	B8EGV	5627			
390 MX	390		B9ES	2611	0,5	B9EVX	7254	202	BR9EIX	3981
400 MX	400		B9ES	2611	0,5	B9EVX	7254	202	BR9EIX	3981

Order  
No.Platin  
Gold-  
Palla-  
diumOrder Quick  
No. No.Order  
No.**HUSQVARNA**

410 TE (2AA)	400	96 - 00	C7E	5096	0,6				CR7EIX	7385
SM / R 400 R	400	01 -	CR8EB	7784	0,6	CR8EVX	6487		CR8EIX	4218
TE 400 R	400	01 -	CR8EB	7784	0,6	CR8EVX	6487		CR8EIX	4218
TE 410	400	01 -	C7E	5096	0,6				CR7EIX	7385
410 TE	410	95 - 96	C7E	5096	0,7				CR7EIX	7385
430 CR	430		B9ES	2611	0,5	B9EVX	7254	202	BR9EIX	3981
450 SMR	450	04 -	CR8EB	7784	0,6	CR8EVX	6487		CR8EIX	4218
SM 450 R	450	03 -	CR8EB	7784	0,6	CR8EVX	6487		CR8EIX	4218
SMR 450	450	03 -	CR7EB	4663	0,6					
TC 450	450	01 -	CR8EB	7784	0,6	CR8EVX	6487		CR8EIX	4218
TE 450	450	03 -	CR8EB	7784	0,6	CR8EVX	6487		CR8EIX	4218
TE 510	450	03 -	CR8EB	7784	0,6	CR8EVX	6487		CR8EIX	4218
510 TE/AC	510		DP8EA-9	5829	0,9	DPR8EVX-9	2872		DPR8EIX-9	2202
510 TE/TC	510	87 - 90	C7E	5096	0,7				CR7EIX	7385
SM 510 R	510		CR8EB	7784	0,6	CR8EVX	6487		CR8EIX	4218
TC 510	510		CR8EB	7784	0,6	CR8EVX	6487		CR8EIX	4218
TE 510 Centennial	510		CR8EB	7784	0,6	CR8EVX	6487		CR8EIX	4218
SM 570 R	570	01 -	C7E	5096	0,7				CR7EIX	7385
SMR 570	570	03 -	CR7EB	4663	0,6					
SMR 570 NOX	570	02 -	R0045J-10	7400						
SM / R 570	576	07.01 -	CR7EB	4663	0,6					
TC 570	576	07.01 -	CR7EB	4663	0,7					
TE 570	576	07.01 -	CR7EB	4663	0,7					
610 e TE/TC	610	98 -	C7E	5096	0,7				CR7EIX	7385
610 TE/TC	610	91 -	C7E	5096	0,7				CR7EIX	7385
SM 610	610	06 -	CPR8E	7411	0,7					
SM 610 e	610	98 -	C7E	5096	0,7				CR7EIX	7385
SM 610 S	610	03 -	C7E	5096	0,7				CR7EIX	7385
TE 610	610		CPR8E	7411	0,7					
SMR 630	630	04 -	R0045J-10	7400						

**HYOSUNG**

Aquila (GV125)	125	00 -	CR8E	1275	0,6	CR8EVX	6487	226	CR8EIX	4218
Cruise 125 I (GA125)	125	97 -	DR8EA	7162	0,6	DR8EVX	6354		DR8EIX	6681
Cruise 125 II (GA125F)	125	97 -	CR8EH-9	5666	0,7	CR8EHVX-9	4546	228	CR8EHIX-9	3797
Cruise 125 I (GA125)	125	96 - 96	D8EA	2120	0,6	D8EVX	2850	216	DR8EIX	6681
Cruise 125 II Classic (GA125F-CLS)	125	99 -	CR8EH-9	5666	0,7	CR8EHVX-9	4546	228	CR8EHIX-9	3797
GF 125 (GF125)	125	98 -	CR8EH-9	5666	0,8	CR8EHVX-9	4546	228	CR8EHIX-9	3797
GS 125 (GS125)	125	97 -	DR8EA	7162	0,6	DR8EVX	6354		DR8EIX	6681
GT 125 R (GF125)	125	05 -	CR8EH-9	5666	0,8	CR8EHVX-9	4546	228	CR8EHIX-9	3797
GT 125 (GF125)	125	05 -	CR8EH-9	5666	0,8	CR8EHVX-9	4546	228	CR8EHIX-9	3797
Hyper 125 (GPS125)	125	98 -	DR8EA	7162	0,6	DR8EVX	6354		DR8EIX	6681
Karion 125	125	02 -	CR8EH-9	5666	0,8	CR8EHVX-9	4546	228	CR8EHIX-9	3797
Naked 125	125	01 -	CR8E	1275	0,6	CR8EVX	6487	226	CR8EIX	4218
XRX 125 (RX125)	125	99 -	CR8EH-9	5666	0,8	CR8EHVX-9	4546	228	CR8EHIX-9	3797
Aquila (GV250) 8V	250	00 -	CR8E	1275	0,6	CR8EVX	6487	226	CR8EIX	4218
GT 250	250	05 -	CR8E	1275	0,7	CR8EVX	6487	226	CR8EIX	4218
650 Naked	650	04 -	CR8E	1275	0,6	CR8EVX	6487	226	CR8EIX	4218
GT 650	650	05 -	CR8E	1275	0,7	CR8EVX	6487	226	CR8EIX	4218
GT 650 R	650	05 -	CR8E	1275	0,7	CR8EVX	6487	226	CR8EIX	4218
GT 650 S	650	05 -	CR8E	1275	0,7	CR8EVX	6487	226	CR8EIX	4218
GV 650	650	06 -	CR8E	1275	0,7	CR8EVX	6487	226	CR8EIX	4218

Order  
No.Platin  
Gold-  
Palla-  
diumOrder Quick  
No. No.

Iridium

Order  
No.**INDIAN**

all models / Alle Modelle V-Twin		36 - 53	B7HS	5110	0,6	B7HVX	7836	204	BR7HIX	7067
Chief	1450	99 - 01	BPR5ES-11	4424	1,1	BPR5EVX-11	2738		BPR5EIX-11	2115
Scout	1450	01 -	BPR5ES-11	4424	1,1	BPR5EVX-11	2738		BPR5EIX-11	2115
Spirit	1450	01 -	BPR5ES-11	4424	1,1	BPR5EVX-11	2738		BPR5EIX-11	2115
Chief	1650	02 -	BPR5ES-11	4424	1,1	BPR5EVX-11	2738		BPR5EIX-11	2115

**ISCH**

Jupiter	20,6kW	346	BP6HS	4511	0,7	BP6HVX	4635		BPR6HIX	4085
Jupiter	13,2kW	346	BP6HS	4511	0,7	BP6HVX	4635		BPR6HIX	4085
6.113.6.114	17,7kW	347	BP6HS	4511	0,7	BP6HVX	4635		BPR6HIX	4085
6.113-01	17,7kW	347	BP6HS	4511	0,7	BP6HVX	4635		BPR6HIX	4085
7.107	16,2kW	347	BP7HS	5111	0,7	BP7HVX	7468		BPR7HIX	5944
Planeta	13,2kW	347	BP7HS	5111	0,7	BP7HVX	7468		BPR7HIX	5944
Planeta	14,7kW	347	BP7HS	5111	0,7	BP7HVX	7468		BPR7HIX	5944

**ITALJET**

Pirana, Pulce	50		B6HS	4510	0,5	B6HVX	7435	203	BR6HIX	3419
Tiffany, Winner	50		B5HS	4210	0,5					
Super Range	125		B7HS	5110	0,5	B7HVX	7836	204	BR7HIX	7067

**JAWA**

05	50		B6HS	4510	0,6	B6HVX	7435	203	BR6HIX	3419
20	50		B6HS	4510	0,6	B6HVX	7435	203	BR6HIX	3419
21 Sport	50		B6HS	4510	0,6	B6HVX	7435	203	BR6HIX	3419
23 Mustang	50		B6HS	4510	0,6	B6HVX	7435	203	BR6HIX	3419
207 Babetta	50		B4H	4110	0,6					
210	50	01.85 -	B6HS	4510	0,5	B6HVX	7435	203	BR6HIX	3419
210 Babetta	50		B5HS	4210	0,6					
215	50	01.86 -	B6HS	4510	0,5	B6HVX	7435	203	BR6HIX	3419
Betcar 50	50	06 -	C7HSA	4629	0,6	C7HVX	4533	216	CR7HIX	7544
Moped	50		B8HS	5510	0,5	B8HVX	2634	205	BR8HIX	7001
CZ 125	125	84 -	B8HS	5510	0,5	B8HVX	2634	205	BR8HIX	7001
CZ 125 De Luxe	125	- 84	B8HS	5510	0,5	B8HVX	2634	205	BR8HIX	7001
Dakar 125	125	03 -	D8EA	2120	0,7	D8EVX	2850	216	DR8EIX	6681
Dandy 125	125		DR8ES	5423	0,8	DR8EVX	6354	217	DR8EIX	6681
Dandy 125	125	99 -	D8EA	2120	0,7	D8EVX	2850	216	DR8EIX	6681
Sport 125	125	03 -	D8EA	2120	0,7	D8EVX	2850	216	DR8EIX	6681
CZ 175	175	84 -	B8HS	5510	0,5	B8HVX	2634	205	BR8HIX	7001
CZ 175 De Luxe	175	- 84	B8HS	5510	0,5	B8HVX	2634	205	BR8HIX	7001
CZ 250	250	84 -	B8HS	5510	0,5	B8HVX	2634	205	BR8HIX	7001
CZ 250 Single/De Luxe	250	- 84	B8HS	5510	0,5	B8HVX	2634	205	BR8HIX	7001
350 Gespann	350	01.87 -	B6HS	4510	0,5	B6HVX	7435	203	BR6HIX	3419
350/640 Black Style	350	93 -	B8HS	5510	0,5	B8HVX	2634	205	BR8HIX	7001
634	350		B6HS	4510	0,6	B6HVX	7435	203	BR6HIX	3419
638	350		B6HS	4510	0,6	B6HVX	7435	203	BR6HIX	3419
638.5 Gespann	350	01.85 -	B6HS	4510	0,5	B6HVX	7435	203	BR6HIX	3419
639	350		B6HS	4510	0,6	B6HVX	7435	203	BR6HIX	3419
640	350		B6HS	4510	0,6	B6HVX	7435	203	BR6HIX	3419
Chopper 350	350		B8HS	5510	0,5	B8HVX	2634	205	BR8HIX	7001
CZ 350	350	84 -	B8HS	5510	0,5	B8HVX	2634	205	BR8HIX	7001
CZ 350 De Luxe	350	- 84	B8HS	5510	0,5	B8HVX	2634	205	BR8HIX	7001
Sabater 350	350		B8HS	5510	0,5	B8HVX	2634	205	BR8HIX	7001

Order  
No.Platin  
Gold-  
Palla-  
diumOrder Quick  
No. No.Order  
No.**JAWA**

Style 350	350		B8HS	5510	0,5	B8HVX	2634	205	BR8HIX	7001
TS 350	350	09.86 -	B6HS	4510	0,5	B6HVX	7435	203	BR6HIX	3419
Twin Sport	350		B8HS	5510	0,5	B8HVX	2634	205	BR8HIX	7001
GS 360	360	01.74 -12.85	B9HS	5810	0,7	B9HVX	2254			
500 DT Speedway	500				0,5	B9EVX	7254		BR9EIX	3981
500 R	500		D8EA	2120	0,5	D8EVX	2850	216	DR8EIX	6681
500 R Spezial	500				0,5	D8EVX	2850		DR8EIX	6681
Classic 650	650	04 -	DR8EA	7162	0,7	DR8EVX	6354		DR8EIX	6681
Dakar 650	650	06 -	DR8EA	7162	0,7	DR8EVX	6354		DR8EIX	6681
Style 650	650	04 -	DR8EA	7162	0,7	DR8EVX	6354		DR8EIX	6681

**JCM**

125 Trail	125		BP6ES	7811	0,7	BP6EVX	5832		BPR6EIX	6637
240 Trail	240		BP7ES	2412	0,5	BP7EVX	7270	206	BPR7EIX	4055
333 Trail	333		BP7ES	2412	0,5	BP7EVX	7270	206	BPR7EIX	4055

**KAWASAKI**

AE 50	50	83 -	B8ES	2411	0,8	B8EVX	7051	201	BR8EIX	5044
AE 50	50	- 82	B6ES	7310	0,8	B6EVX	5136			
AR 50	50	93 -	BR8ES	5422	0,8	BR8EVX	1262	207	BR8EIX	5044
AR 50	50	- 82	B6ES	7310	0,8	B6EVX	5136			
AR 50	50	83 - 92	B8ES	2411	0,8	B8EVX	7051	201	BR8EIX	5044
AV 50	50	- 83	D8EA	2120	0,7	D8EVX	2850	216	DR8EIX	6681
AV 50	50	84 -	C6HSA	3228	0,7				CR6HIX	7274
KH 50	50		B6ES	7310	0,8	B6EVX	5136			
KMX 50 (KSR-I)	50	93 -	BR8ES	5422	0,8	BR8EVX	1262	207	BR8EIX	5044
KX 60	60	- 92	B9EG	3530	0,6	B9EGV	5827		BR9EIX	3981
KX 60	60	93 -	BR9EG	3230	0,7	BR9EVX	1265		BR9EIX	3981
KX 65	65		BR10EG	3830	0,6					
AE 80	80	- 82	BP7ES	2412	0,8	BP7EVX	7270	206	BPR7EIX	4055
AE 80	80	83 -	BPR8ES	3923	0,8	BPR8EVX	5573	213		
AN 80	80		C6HSA	3228	0,7				CR6HIX	7274
AR 80	80	83 -	BPR8ES	3923	0,8	BPR8EVX	5573	213		
AR 80	80	- 82	BP7ES	2412	0,8	BP7EVX	7270	206	BPR7EIX	4055
DX 80	80		B8ES	2411	0,8	B8EVX	7051	201	BR8EIX	5044
KD 80	80		B7ES	1111	0,7	B7EVX	6934			
KDX 80	80		B8ES	2411	0,8	B8EVX	7051	201	BR8EIX	5044
KH 80	80		B7ES	1111	0,8	B7EVX	6934			
KMX 80 (KSR-2)	80	93 -	BR8ES	5422	0,8	BR8EVX	1262	207	BR8EIX	5044
KX 80	80	- 80	B8ES	2411	0,8	B8EVX	7051	201	BR8EIX	5044
KX 80	80	81 - 82	B9ES	2611	0,6	B9EVX	7254	202	BR9EIX	3981
KX 80	80	83 - 91	B9EG	3530	0,6	B9EGV	5827		BR9EIX	3981
KX 80 (KX80S7)	80	97 -	R6252K-105	2741	0,6					
KX 80 (KX80V7)	80	97 -	R6252K-105	2741	0,6					
KX 80 /80-2	80	92 -	R6252K-105	2741	0,6					
KX 85	85	01 -	R6252K-105	2741	0,8					
KX 85-II	85	01 -	R6252K-105	2741	0,8					
KC 90	90		B8ES	2411	0,8	B8EVX	7051	201	BR8EIX	5044
KC 90 A	90		B8ES	2411	0,8	B8EVX	7051	201	BR8EIX	5044
KC 90 C	90		B8HS	5510	0,7	B8HVX	2634	205	BR8HIX	7001
KC 90 D	90		B8HS	5510	0,7	B8HVX	2634	205	BR8HIX	7001
KE 90	90		B8ES	2411	0,8	B8EVX	7051	201	BR8EIX	5044





Order No.



Gold-Palladium



Order Quick No. No.

Iridium



Order No.

**KAWASAKI**

KH 90	90		B8ES	2411	0,8	B8EVX	7051	201	BR8EIX	5044
KM 90	90		B7HS	5110	0,7	B7HVX	7836	204	BR7HIX	7067
KC 100	100	80 -	B8ES	2411	0,8	B8EVX	7051	201	BR8EIX	5044
KD 100	100		B7HS	5110	0,7	B7HVX	7836	204	BR7HIX	7067
KE 100	100	93 -	BR8ES	5422	0,8	BR8EVX	1262	207	BR8EIX	5044
KE 100	100	01.76 - 12.79	B8ES	2411	0,8	B8EVX	7051	201	BR8EIX	5044
KH 100	100		B8ES	2411	0,8	B8EVX	7051	201	BR8EIX	5044
KM 100	100	01.79 - 12.81	B7HS	5110	0,7	B7HVX	7836	204	BR7HIX	7067
KV 100	100		B7HS	5110	0,7	B7HVX	7836	204	BR7HIX	7067
KX 100	100	92 -	R6252K-105	2741	0,6					
KAZE 110	110	95 -	C6HSA	3228	0,7				CR6HIX	7274
AR 125	125	01.82 -	BR8ES	5422	0,8	BR8EVX	1262	207	BR8EIX	5044
BN125A Eliminator	125	97 -	CR8E	1275	0,6	CR8EVX	6487	226	CR8EIX	4218
DX 125	125				0,6	B9EVX	7254		BR9EIX	3981
KC 125	125		B6HS	4510	0,7	B6HVX	7435	203	BR6HIX	3419
KD 125	125		B8HS	5510	0,7	B8HVX	2634	205	BR8HIX	7001
KDX 125 SR	125		BR8ES	5422	0,8	BR8EVX	1262	207	BR8EIX	5044
KE 125	125	01.76 - 12.83	B8HS	5510	0,8	B8HVX	2634	205	BR8HIX	7001
KH 125	125	93 -	BR8ES	5422	0,8	BR8EVX	1262	207	BR8EIX	5044
KH 125	125	01.77 - 12.81	BR8ES	5422	0,8	BR8EVX	1262	207	BR8EIX	5044
KMX 125	125	01.86 -	BR8ES	5422	0,7	BR8EVX	1262	207	BR8EIX	5044
KS 125	125	01.73 - 12.76	B8HS	5510	0,7	B8HVX	2634	205	BR8HIX	7001
KX 125	125	91 - 99	R6252K-105	2741	0,6					
KX 125	125	90 - 91	R6254E-105	3949	0,6					
KX 125	125	85 - 90			0,6	B10EVX	7335		BR10EIX	6801
KX 125	125	82 - 84			0,6	B9EVX	7254		BR9EIX	3981
KX 125	125	00 - 02			0,8	BR9EVX	1265		BR9EIX	3981
KX 125	125	04 - 05	R6918B-9	2954	0,7					
KX 125	125	03 - 03							BR9EIX	3981
KX 125 (KX125K4)	125	97 - 00			0,6	BR9EVX	1265		BR9EIX	3981
KD 175	175		B9HS	5810	0,7	B9HVX	2254			
KDX 175	175	01.80 - 12.84			0,6	BR9EVX	1265		BR9EIX	3981
KE 175	175	- 80	B9HS	5810	0,7	B9HVX	2254			
KE 175	175	81 -	B7ES	1111	0,8	B7EVX	6934			
KE 175 B	175		B9HS	5810	0,7	B9HVX	2254			
KE 175 D	175		B7ES	1111	0,8	B7EVX	6934			
KDX 200 H	200	95 -	BR8ES	5422	0,8	BR8EVX	1262	207	BR8EIX	5044
KDX 200	200	93 - 94	BR9ES	5722	0,8	BR9EVX	1265	208	BR9EIX	3981
KMX 200	200	01.88 - 92	BR8ES	5422	0,8	BR8EVX	1262	207	BR8EIX	5044
Z 200	200	01.77 - 12.79	B8ES	2411	0,8	B8EVX	7051	201	BR8EIX	5044
BJ 250A (Estrella)	250	93 - 96	DR8ES	5423	0,7	DR8EVX	6354	217	DR8EIX	6681
BJ 250 C(Estrella)	250	97 -	DR9EA	3437	0,7	DR9EVX	6361	219	DR9EIX	4772
EL 250/E/F/Eliminator LX/SE	250	89 -	CR8HSA	2086	0,7	CR8HVX	7236		CR8HIX	7669
EX 250 F (GPX 250 R)	250	93 -	C8HA	2168	0,7	C8HVX	2672		CR8HIX	7669
EX 250 H (ZZ-R 250)	250	93 -	CR8HSA	2086	0,7	CR8HVX	7236		CR8HIX	7669
GPX 250 R	250		CR8HSA	2086	0,7	CR8HVX	7236		CR8HIX	7669
GPZ 250 Belt Drive	250		DPR8EA-9	4929	0,9	DPR8EVX-9	2872	221	DPR8EIX-9	2202
GPZ 250 R	250		CR8HS	7423	0,7	CR8HVX	7236		CR8HIX	7669
KE 250	250		B8ES	2411	0,8	B8EVX	7051	201	BR8EIX	5044
KH 250	250	01.73 - 12.79	B9HS	5810	0,7	B9HVX	2254			
KL 250 (A)	250	01.79 - 12.83	BR7ES	5122	0,8	BR7EVX	4556			
KL 250 (KLR 250)	250	01.83 - 91	DPR9EA-9	5329	0,9	DPR9EVX-9	3854	222	DPR9EIX-9	5545

Order  
No.Platin  
Gold-  
Palla-  
diumOrder Quick  
No. No.Order  
No.**KAWASAKI**

KLX 250	250	01.80 -12.84	B7ES	1111	0,8	B7EVX	6934			
KLX 250 (KLX250E)	250	93 -	CR8E	1275	0,8	CR8EVX	6487	226	CR8EIX	4218
KR-1R	250		BR10ES	4832	0,8	BR10EVX	3788		BR10EIX	6801
KR-1S	250		BR10ES	4832	0,8	BR10EVX	3788		BR10EIX	6801
KSF 250 A (SQ)	250	87 -	DPR8EA-9	4929	0,9	DPR8EVX-9	2872	221	DPR8EIX-9	2202
KT 250	250		B7HS	5110	0,7	B7HVX	7836	204	BR7HIX	7067
KX 250	250	92 -	R6252E-9	4741	0,9					
KX 250	250	- 91	B9EG	3530	0,6	B9EGV	5827		BR9EIX	3981
KX 250 F (KX250T6F)	250	04 -	CR8E	1275	0,8	CR8EVX	6487	226	CR8EIX	4218
KX 250	250	03 -							BR8EIX	5044
KX 250 (KX250K4)	250	97 -				BR8EVX	1262		BR8EIX	5044
KX 250 F	250	04 - 05	CR8EB	7784	0,6	CR8EVX	6487		CR8EIX	4218
KX 250R	250	05 -			0,8	BR8ECMVX	5567			
LTD 250 Belt Drive	250		DR8ES	5423	0,7	DR8EVX	6354	217	DR8EIX	6681
LX 250	250		BR7ES	5122	0,8	BR7EVX	4556			
Z 250	250		BR7ES	5122	0,8	BR7EVX	4556			
Z 250 A	250	01.80 -	DR8ES	5423	0,7	DR8EVX	6354	217	DR8EIX	6681
Z 250 B	250		DR8ES	5423	0,7	DR8EVX	6354	217	DR8EIX	6681
Z 250 Belt Drive	250		DPR8EA-9	4929	0,9	DPR8EVX-9	2872	221	DPR8EIX-9	2202
Z 250 C	250	01.80 -	B7ES	1111	0,8	B7EVX	6934			
Z 250 D	250		B7ES	1111	0,8	B7EVX	6934			
Z 250 G	250		B7ES	1111	0,8	B7EVX	6934			
Z 250 J	250		DR8ES	5423	0,7	DR8EVX	6354	217	DR8EIX	6681
Z 250 LTD	250	01.81 -	BR8ES	5422	0,8	BR8EVX	1262	207	BR8EIX	5044
Z 250 T	250		DPR9EA-9	5329	0,9	DPR9EVX-9	3854	222	DPR9EIX-9	5545
ZR 250 (Balius)	250	93 -	CR9E	6263	0,8	CR9EVX	5943	227	CR9EIX	3521
ZX 250 (ZXR 250)	250	93 -	CR9E	6263	0,8	CR9EVX	5943	227	CR9EIX	3521
KLX 300 R (LX300B5)	300	01 -	CR9E	6263	0,6	CR9EVX	5943	227	CR9EIX	3521
KVF 300 A&B	300	99 - 02	DR8EA	7162	0,7	DR8EVX	6354		DR8EIX	6681
MULE 500/ KAF 300 A&B (UV)	300	92 - 96	BPR5ES	7422	0,8	BPR5EVX	4875		BPR5EIX	6597
GPZ 305 Belt Drive	305	01.83 -	DPR9EA-9	5329	0,9	DPR9EVX-9	3854	222	DPR9EIX-9	5545
Z 305	305		D8EA	2120	0,7	D8EVX	2850	216	DR8EIX	6681
EN 400 A	400		DR8ES	5423	0,7	DR8EVX	6354	217	DR8EIX	6681
GPZ 400	400		DPR9EA-9	5329	0,9	DPR9EVX-9	3854	222	DPR9EIX-9	5545
GPZ 400 F	400		DPR9EA-9	5329	0,9	DPR9EVX-9	3854	222	DPR9EIX-9	5545
GPZ 400 F II	400		DPR9EA-9	5329	0,9	DPR9EVX-9	3854	222	DPR9EIX-9	5545
KH 400	400		B8HS	5510	0,7	B8HVX	2634	205	BR8HIX	7001
KLE 400	400	93 -	DR8EA	7162	0,7	DR8EVX	6354		DR8EIX	6681
KX 400	400				0,6	B9EVX	7254		BR9EIX	3981
LTD 400	400		DR8ES	5423	0,7	DR8EVX	6354	217	DR8EIX	6681
Z 400	400	01.76 -12.81	BR7ES	5122	0,8	BR7EVX	4556			
Z 400 A/B/C/D/G/H	400		B7ES	1111	0,8	B7EVX	6934			
Z 400 F	400		DPR9EA-9	5329	0,9	DPR9EVX-9	3854	222	DPR9EIX-9	5545
Z 400 F	400	83 -	DR8ES	5423	0,7	DR8EVX	6354	217	DR8EIX	6681
Z 400 F-II	400		DPR9EA-9	5329	0,9	DPR9EVX-9	3854	222	DPR9EIX-9	5545
Z 400 J	400		DR8EA	7162	0,7	DR8EVX	6354		DR8EIX	6681
Z 400 J (I)	400		D8EA	2120	0,7	D8EVX	2850	216	DR8EIX	6681
Z 400 K	400		DR7ES	3123	0,7					
Z 400 LTD	400		BR7ES	5122	0,8	BR7EVX	4556			
Z 400 M	400		DR8EA	7162	0,7	DR8EVX	6354		DR8EIX	6681
ZL 400 (Eliminator 400SE)	400	93 -	DR8ES	5423	0,7	DR8EVX	6354	217	DR8EIX	6681
ZR 400	400	- 83	DR7ES	3123	0,7					

Order  
No.Gold-  
Palla-  
diumOrder  
No.Quick  
No.

Iridium

Order  
No.**KAWASAKI**

ZR 400	400	84 -	DR8ESL	2923	0,7	DR8EVX	6354	218	DR8EIX	6681
ZR 400-C (Zephyr 400)	400	93 -	DPR9EA-9	5329	0,9	DPR9EVX-9	3854	222	DPR9EIX-9	5545
ZR 400-D (Xanthus)	400	93 -	CR9EK	4548	0,8			230	CR9EIX	3521
ZX 400 (Z 400-F2)	400	93 -	DPR9EA-9	5329	0,9	DPR9EVX-9	3854	222	DPR9EIX-9	5545
ZX 400 (ZXR400R,ZZR400)	400	93 -	CR9EK	4548	0,8			230	CR9EIX	3521
ZXR 400	400		CR9EK	4548	0,8			230	CR9EIX	3521
Z 440	440	01.80 -12.85	BR7ES	5122	0,8	BR7EVX	4556			
Z 440 H (I)	440		BR7ES	5122	0,8	BR7EVX	4556			
EN 450 A (I)	450		DR8ES	5423	0,7	DR8EVX	6354	217	DR8EIX	6681
KX 450 F (KX450T6F)	450	06 -	CPR8EB-9	6607	0,9					
LTD 450	450	01.85 -	DR8ES	5423	0,7	DR8EVX	6354	217	DR8EIX	6681
EN 500	500	90 -	DR9EA	3437	0,7	DR9EVX	6361	219	DR9EIX	4772
ER-5 (ER500A1)(ER500C1)	500	97 -	DR9EA	3437	0,7	DR9EVX	6361	219	DR9EIX	4772
ER-5 (ER500B1)(ER500D1)	500	97 -	DR9EA	3437	0,7	DR9EVX	6361	219	DR9EIX	4772
EX 500 (GPZ 500S EN 500)	500	93 -	DR8ES	5423	0,7	DR8EVX	6354	217	DR8EIX	6681
GPX 500 R	500	01.89 -	DR8ES	5423	0,7	DR8EVX	6354	217	DR8EIX	6681
GPZ 500 R	500		DR8ES	5423	0,7	DR8EVX	6354	217	DR8EIX	6681
GPZ 500 S	500		DR8ES	5423	0,7	DR8EVX	6354	217	DR8EIX	6681
GPZ 500 S (EX500E4)	500	97 -	DR9EA	3437	0,7	DR9EVX	6361	219	DR9EIX	4772
GPZ 500 S (EX500D)	500	94 -	DR9EA	3437	0,7	DR9EVX	6361	219	DR9EIX	4772
GPZ 500 S (I)	500		D9EA	2420	0,7	D9EVX	2834		DR9EIX	4772
GRZ 500 S (EX500E)	500		D9EA	2420	0,7	D9EVX	2834		DR9EIX	4772
KH 500	500		B9HS-10	3626	1,0					
KLE 500	500	90 - 04	DR9EA	3437	0,7	DR9EVX	6361	219	DR9EIX	4772
KLE 500	500	05 -	DR9EA	3437	0,7	DR9EVX	6361	219	DR9EIX	4772
KLR 500	500		DPR8EA-9	4929	0,9	DPR8EVX-9	2872	221	DPR8EIX-9	2202
KX 500	500	93 -	BR8EG	3130	0,6					
LE 500 A	500		DR9EA	3437	0,8	DR9EVX	6361	219	DR9EIX	4772
Z 500	500		DR8EA	7162	0,7	DR8EVX	6354		DR8EIX	6681
ZL 500	500		DR8ES	5423	0,7	DR8EVX	6354	217	DR8EIX	6681
ZR 500	500		DR8ESL	2923	0,7	DR8EVX	6354	218	DR8EIX	6681
ZZ-R 500	500		CR9E	6263	0,8	CR9EVX	5943	227	CR9EIX	3521
GPZ 550	550		DPR9EA-9	5329	0,9	DPR9EVX-9	3854	222	DPR9EIX-9	5545
GPZ 550 Unitrack (I)	550		D8EA	2120	0,7	D8EVX	2850	216	DR8EIX	6681
GT 550	550	01.83 -	DR8ES	5423	0,7	DR8EVX	6354	217	DR8EIX	6681
KZ 550	550		D8EA	2120	0,7	D8EVX	2850	216	DR8EIX	6681
LTD 550	550	01.80 -12.85	DR8ES	5423	0,7	DR8EVX	6354	217	DR8EIX	6681
Z 550	550		DR8ES	5423	0,7	DR8EVX	6354	217	DR8EIX	6681
Zephyr (ZR550B8)	550	97 -	DR9EA	3437	0,7	DR9EVX	6361	219	DR9EIX	4772
ZR 550 B Zephyr	550	91 -	DR9EA	3437	0,8	DR9EVX	6361	219	DR9EIX	4772
ZX 550 A1	550		DPR9EA-9	5329	0,9	DPR9EVX-9	3854	222	DPR9EIX-9	5545
Eliminator 600 (ZL600B)	600	95 -	DR9EA	3437	0,7	DR9EVX	6361	219	DR9EIX	4772
GPX 600	600		DR8ES	5423	0,8	DR8EVX	6354	217	DR8EIX	6681
GPZ 600	600		DR8ES	5423	0,7	DR8EVX	6354	217	DR8EIX	6681
GPZ 600 R (I)	600		D9EA	2420	0,7	D9EVX	2834		DR9EIX	4772
KL 600	600		DPR8EA-9	4929	0,9	DPR8EVX-9	2872	221	DPR8EIX-9	2202
KL 600 R-AI (I)	600		D8EA	2120	0,7	D8EVX	2850	216	DR8EIX	6681
KLR 600	600	- 84	DR8ES	5423	0,7	DR8EVX	6354	217	DR8EIX	6681
KLR 600	600	85 -	DPR8EA-9	4929	0,9	DPR8EVX-9	2872	221	DPR8EIX-9	2202
KLR 600 EL (I)	600		DP9EA-9	6629	0,9	DP9EVX-9	3331		DPR9EIX-9	5545
ZL 600	600	01.86 -	DR8ES	5423	0,7	DR8EVX	6354	217	DR8EIX	6681
ZL 600 (ZL600B/B1)	600	95 -	DR9EA	3437	0,7	DR9EVX	6361	219	DR9EIX	4772

Order  
No.Platin  
Gold-  
Palla-  
diumOrder Quick  
No. No.Order  
No.**KAWASAKI**

ZX 600 A (I)	600		D9EA	2420	0,7	D9EVX	2834		DR9EIX	4772
ZX-6R Ninja (ZX600F1/F3)	600	95 -	CR9E	6263	0,8	CR9EVX	5943	227	CR9EIX	3521
ZX-6R Ninja (ZX 600 G)	600	98 -	CR9E	6263	0,7	CR9EVX	5943	227	CR9EIX	3521
ZX-6R Ninja (ZX 600 H Kat)	600	98 -	CR9E	6263	0,7	CR9EVX	5943	227	CR9EIX	3521
ZX-6R Ninja (Kat.) (Zx600J1H)	600	00 -	CR9E	6263	0,8	CR9EVX	5943	227	CR9EIX	3521
ZX-6R Ninja (Kat.)	600	03 -	CR9E	6263	0,8	CR9EVX	5943	227	CR9EIX	3521
ZX-6RR	600	04 -	CR9E	6263	0,8	CR9EVX	5943	227	CR9EIX	3521
ZZ-R 600	600	90 -	CR9E	6263	0,8	CR9EVX	5943	227	CR9EIX	3521
ZZ-R 600 (ZX600E9)	600	01 -	CR9E	6263	0,7	CR9EVX	5943	227	CR9EIX	3521
ZZ-R 600 (ZX600E/E5)	600	93 -	CR9E	6263	0,8	CR9EVX	5943	227	CR9EIX	3521
ZX-6R	636	05 -	CR9E	6263	0,8	CR9EVX	5943	227	CR9EIX	3521
Ninja ZX-6R (ZX636A)	636		CR9E	6263	0,8	CR9EVX	5943	227	CR9EIX	3521
Ninja ZX-6R (ZX636B)	636	03 -	CR9E	6263	0,8	CR9EVX	5943	227	CR9EIX	3521
ZX-6RR	636	05 -	CR9E	6263	0,8	CR9EVX	5943	227	CR9EIX	3521
Ninja ZX-6RR (ZX600K)	636	03 -	CR9E	6263	0,8	CR9EVX	5943	227	CR9EIX	3521
ER-6f (EX650A6F / B6F)	650	06 -			0,9				CR9EIA-9	6289
ER-6n (ER650A6S / B6F)	650	06 -			0,9				CR9EIA-9	6289
KL 650 (KLR 650/Tengai)	650	93 -	DPR8EA-9	4929	0,9	DPR8EVX-9	2872	221	DPR8EIX-9	2202
KLR 650	650	09.86 - 94	DPR8EA-9	4929	0,9	DPR8EVX-9	2872	221	DPR8EIX-9	2202
KLR 650 (KL650C1/C3)	650	95 -	DPR8EA-9	4929	0,9	DPR8EVX-9	2872	221	DPR8EIX-9	2202
KLX 650 (KLX650C)	650	93 -	DPR8EA-9	4929	0,9	DPR8EVX-9	2872	221	DPR8EIX-9	2202
KLX 650 R	650	98 -	DPR8EA-9	4929	0,9	DPR8EVX-9	2872	221	DPR8EIX-9	2202
KLX 650 R (KLX650A)	650	93 - 96	DPR8EA-9	4929	0,9	DPR8EVX-9	2872	221	DPR8EIX-9	2202
Versys 650	650	06 -			0,9				CR9EIA-9	6289
W 650 (EJ650A1)	650	99 -	CR9E	6263	0,8	CR9EVX	5943	227	CR9EIX	3521
Z 650	650		BR7ES	5122	0,8	BR7EVX	4556			
Z 650 F-B	650		B8ES	2411	0,7	B8EVX	7051	201	BR8EIX	5044
LTD 700	700		BR8ES	5422	0,8	BR8EVX	1262	207	BR8EIX	5044
Z 700	700		BR8ES	5422	0,8	BR8EVX	1262	207	BR8EIX	5044
750 Turbo	750	01.73 -12.86			0,6	BR9EVX	1265		BR9EIX	3981
GPX 750 R	750	01.87 -	DR8ES	5423	0,7	DR8EVX	6354	217	DR8EIX	6681
GPX 750 R (I)	750		DR8ESL	2923	0,7	DR8EVX	6354	218	DR8EIX	6681
GPZ 750	750	01.82 -	BR9ES	5722	0,8	BR9EVX	1265	208	BR9EIX	3981
GPZ 750 R	750	01.85 -	DR8ES	5423	0,7	DR8EVX	6354	217	DR8EIX	6681
GT 750	750	01.82 -12.87	BR8ES	5422	0,8	BR8EVX	1262	207	BR8EIX	5044
LTD 750 4 Cyl.	750	01.82 -12.87	BR8ES	5422	0,8	BR8EVX	1262	207	BR8EIX	5044
VN 750 Twin	750		DPR7EA-9	5129	0,9	DPR7EVX-9	7682	220	DPR7EIX-9	7803
VN 750 Vulcan	750		DPR7EA-9	5129	0,9	DPR7EVX-9	7682	220	DPR7EIX-9	7803
Z 2	750		B8ES	2411	0,8	B8EVX	7051	201	BR8EIX	5044
Z 750	750		BR8ES	5422	0,8	BR8EVX	1262	207	BR8EIX	5044
Z 750	750	04 -	CR9EK	4548	0,7			230	CR9EIX	3521
Z 750 (GT750)	750	93 -	DR8ES	5423	0,7	DR8EVX	6354	217	DR8EIX	6681
Z 750 B	750		BR8ES	5422	0,8	BR8EVX	1262	207	BR8EIX	5044
Z 750 D	750		B8ES	2411	0,8	B8EVX	7051	201	BR8EIX	5044
Z 750 E	750		BR8ES	5422	0,8	BR8EVX	1262	207	BR8EIX	5044
Z 750 GP	750		BR8ES	5422	0,8	BR8EVX	1262	207	BR8EIX	5044
Z 750 H	750		BR8ES	5422	0,8	BR8EVX	1262	207	BR8EIX	5044
Z 750 L	750		BR8ES	5422	0,8	BR8EVX	1262	207	BR8EIX	5044
Z 750 LTD	750		BR8ES	5422	0,8	BR8EVX	1262	207	BR8EIX	5044
Z 750 LTD Belt Drive	750		BPR6ES	7822	0,8	BPR6EVX	6764		BPR6EIX	6637
Z 750 LTD Twin.	750		BPR6ES	7822	0,8	BPR6EVX	6764		BPR6EIX	6637
Z 750 M	750		BR6ES	4922	0,8					

Order  
No.Platin  
Gold-  
Palla-  
diumOrder Quick  
No. No.

Iridium

Order  
No.**KAWASAKI**

Z 750 S	750		BR6ES	4922	0,8						
ZR-7 (ZR750F1)	750	99 -	DR9EA	3437	0,7	DR9EVX	6361	219	DR9EIX	4772	
ZR 750 C Zephyr	750	91 - 00	DR8ES	5423	0,7	DR8EVX	6354	217	DR8EIX	6681	
ZR 750 S	750	05 -	CR9EK	4548	0,7			230	CR9EIX	3521	
ZR 750 D1/2 Zephyr	750	96 - 00	DR9EA	3437	0,7	DR9EVX	6361	219	DR9EIX	4772	
ZR-7S (ZR750F1)(ZR750-H1)	750	99 -	DR9EA	3437	0,7	DR9EVX	6361	219	DR9EIX	4772	
ZX 750 J	750		CR9E	6263	0,8	CR9EVX	5943	227	CR9EIX	3521	
ZX 750 N1 Ninja ZX-7RR	750	96 -	CR9E	6263	0,8	CR9EVX	5943	227	CR9EIX	3521	
ZX 750 P1/P2 Ninja ZX-7R	750	96 -	CR9E	6263	0,8	CR9EVX	5943	227	CR9EIX	3521	
ZX-7R Ninja (ZX750P6)	750	00 -	CR9E	6263	0,7	CR9EVX	5943	227	CR9EIX	3521	
ZXR 750	750	09.88 -	CR9E	6263	0,8	CR9EVX	5943	227	CR9EIX	3521	
ZXR 750 R	750	90 -	CR9E	6263	0,8	CR9EVX	5943	227	CR9EIX	3521	
ZXR 750 R (ZX750L/M)	750	93 -	CR9E	6263	0,8	CR9EVX	5943	227	CR9EIX	3521	
VN 800 Drifter (VN800E1)	800	01 -	CR7E	4578	0,8			225	CR7EIX	7385	
VN 800 Drifter (VN800C1)	800	99 - 00	CR8E	1275	0,8	CR8EVX	6487	226	CR8EIX	4218	
VN 800 (VN800A)	800	95 -	CR8E	1275	0,8	CR8EVX	6487	226	CR8EIX	4218	
VN 800 (VN800A3)	800	97 -	CR8E	1275	0,8	CR8EVX	6487	226	CR8EIX	4218	
VN 800 B1/B2	800	96 -	CR8E	1275	0,8	CR8EVX	6487	226	CR8EIX	4218	
Vulcan 800	800	95 -	CR8E	1275	0,8	CR8EVX	6487	226	CR8EIX	4218	
GPZ 900 R	900		DR8ES	5423	0,7	DR8EVX	6354	217	DR8EIX	6681	
GPZ 900 R (I)	900		D9EA	2420	0,6	D9EVX	2834		DR9EIX	4772	
Ninja ZX-9R	900	98 -	CR9EK	4548	0,7			230	CR9EIX	3521	
VN 900 / Classic	900	06 -	CPR7EA-9		0,9						
Z 1	900		B8ES	2411	0,8	B8EVX	7051	201	BR8EIX	5044	
Z 900	900	01.73 - 12.76	B8ES	2411	0,8	B8EVX	7051	201	BR8EIX	5044	
ZX 900 C (Ninja ZX-9R)	900	98 - 99	CR9EK	4548	0,7			230	CR9EIX	3521	
ZX 900 B/B4 (Ninja ZX-9R)	900	94 - 97	CR9EK	4548	0,7			230	CR9EIX	3521	
ZX 900 D (Kat) (Ninja ZX-9R)	900	98 - 99	CR9EK	4548	0,7			230	CR9EIX	3521	
ZX-9R	900	03 -	CR9EK	4548	0,7			230	CR9EIX	3521	
ZX 900 E1H (Kat.) (Ninja ZX-9R)	900	00 -	CR9EK	4548	0,7			230	CR9EIX	3521	
1000 GTR	1000		DR8ES	5423	0,7	DR8EVX	6354	217	DR8EIX	6681	
1000 GTR (ZG1000A12)	1000	97 -	DR9EA	3437	0,7	DR9EVX	6361	219	DR9EIX	4772	
1000 GTR (ZGT00A)	1000	94 -	DR9EA	3437	0,7	DR9EVX	6361	219	DR9EIX	4772	
1000 GTR (I)	1000		D9EA	2420	0,7	D9EVX	2834		DR9EIX	4772	
A 1000 R1	1000		BR8ES	5422	0,8	BR8EVX	1262	207	BR8EIX	5044	
GPZ 1000 AZ (I)	1000		B8ES	2411	0,7	B8EVX	7051	201	BR8EIX	5044	
GPZ 1000 R (I)	1000		D9EA	2420	0,7	D9EVX	2834		DR9EIX	4772	
GPZ 1000 RX	1000		DR8ES	5423	0,7	DR8EVX	6354	217	DR8EIX	6681	
GPZ 1000 RX (I)	1000		D9EA	2420	0,7	D9EVX	2834		DR9EIX	4772	
KLV 1000	1000	04 -	CR8EK	3478	0,7				CR8EIX	4218	
KZ 1000 Police	1000	93 -	BR8ES	5422	0,8	BR8EVX	1262	207	BR8EIX	5044	
ST 1000 (I)	1000		B8ES	2411	0,7	B8EVX	7051	201	BR8EIX	5044	
Z 1000	1000	- 80	B8ES	2411	0,8	B8EVX	7051	201	BR8EIX	5044	
Z 1000	1000	81 -	BR8ES	5422	0,8	BR8EVX	1262	207	BR8EIX	5044	
Z 1000	1000	03 - 06	CR9EK	4548	0,8			230	CR9EIX	3521	
Z 1000 ES (I)	1000		B8ES	2411	0,8	B8EVX	7051	201	BR8EIX	5044	
Z 1000 J (I)	1000		BR8ES	5422	0,8	BR8EVX	1262	207	BR8EIX	5044	
Z1R 1000 (I)	1000		B8ES	2411	0,7	B8EVX	7051	201	BR8EIX	5044	
ZL 1000	1000	09.86 -	DR8ES	5423	0,7	DR8EVX	6354	217	DR8EIX	6681	
ZX 10	1000	87 - 90	CR9E	6263	0,8	CR9EVX	5943	227	CR9EIX	3521	
ZX-10 R Ninja	1000	04 -			0,9				CR9EIA-9	6289	
ZX-10 R Ninja (ZX100D6F)	1000	06 -			0,9				CR9EIA-9	6289	

Order  
No.Platin  
Gold-  
Palla-  
diumOrder Quick  
No. No.Order  
No.**KAWASAKI**

ZZR 1100 Kat (ZX1100G)	1052	98 -	CR9E	6263	0,7	CR9EVX	5943	227	CR9EIX	3521
GPZ 1100	1100		BR8ES	5422	0,8	BR8EVX	1262	207	BR8EIX	5044
GPZ 1100 (ZX1100E1E1H)	1100	95 -	CR9EK	4548	0,8			230	CR9EIX	3521
GPZ 1100 ABS (ZX1100F1)	1100	97 -	CR9EK	4548	0,8			230	CR9EIX	3521
LTD 1100	1100		BR8ES	5422	0,8	BR8EVX	1262	207	BR8EIX	5044
Z 1100	1100		BR8ES	5422	0,8	BR8EVX	1262	207	BR8EIX	5044
Zephyr 1100 (ZR1100A)	1100		CR9E	6263	0,8	CR9EVX	5943	227	CR9EIX	3521
Zephyr 1100 (ZRT10A)	1100	92 -	CR9E	6263	0,8	CR9EVX	5943	227	CR9EIX	3521
ZRX 1100 (ZR1100C1)(ZRT10C)	1100	97 - 00	CR9EK	4548	0,8			230	CR9EIX	3521
Zephyr (ZR 1100 B1)	1100	96 -	CR9E	6263	0,8	CR9EVX	5943	227	CR9EIX	3521
ZX 1100 F1	1100	96 -	CR9EK	4548	0,8			230	CR9EIX	3521
ZZR 1100 (ZXT10C)	1100	90 - 92	CR9E	6263	0,8	CR9EVX	5943	227	CR9EIX	3521
ZZR 1100 (ZX1100D5)	1100	97 -	CR9E	6263	0,8	CR9EVX	5943	227	CR9EIX	3521
ZZR 1100 (ZXT10D)	1100	93 - 96	CR9E	6263	0,8	CR9EVX	5943	227	CR9EIX	3521
ZG 1200 (Voyager XII)	1200	93 -	DPR8EA-9	4929	0,9	DPR8EVX-9	2872	221	DPR8EIX-9	2202
ZRX 1200 (ZR1200C1P)	1200	01 -	CR9EK	4548	0,7			230	CR9EIX	3521
ZRX 1200 R (ZR1200C1P)	1200	01 -	CR9EK	4548	0,7			230	CR9EIX	3521
ZRX 1200 S (ZR1200C1P)	1200	01 -	CR9EK	4548	0,7			230	CR9EIX	3521
ZX-12R Ninja (Kat.) (ZX1200A1H)	1200	00 -	CR9EKPA	7785	0,7					
ZZ-R 1200 (ZX1200C1)	1200	02 -	CR9E	6263	0,7	CR9EVX	5943	227	CR9EIX	3521
Z 1300	1300	79 -	B8ES	2411	0,8	B8EVX	7051	201	BR8EIX	5044
Z 1300	1300	80 -	BPR6ES	7822	0,8	BPR6EVX	6764		BPR6EIX	6637
GTR 1400	1400	07 -			0,9				CR9EIA-9	6289
ZZR 1400	1400	06 -			0,9				CR9EIA-9	6289
VN 1500F Classic	1471	98 - 00	DPR5EA-9	2887	0,9					
VN 1500 Mean Streak (P1)	1500	02 -	DPR6EA-9	5531	0,9					
VN 1500 Drifter (VN1500R1)	1500	01 -	DPR6EA-9	5531	0,9					
VN 1500 Drifter (VN1500J1)	1500	99 - 00	DPR5EA-9	2887	0,9					
VN-15 A/B (VN-1500/SE/C/D2)	1500		DPR7EA-9	5129	0,9	DPR7EVX-9	7682	220	DPR7EIX-9	7803
VN 1600 Classic	1600	03 -	DPR6EA-9	5531	0,9					
VN 1600 Classic Tourer	1600	05 -	DPR6EA-9	5531	0,9					
VN 1600 Mean Streak	1600	04 -	DPR6EA-9	5531	0,9					
VN 2000	2053	04 -	IZFR6F-11	4095	1,1					

**KEEWAY**

Superbike 150	150		D7EA	7912	0,6	D7EVX	2734			
---------------	-----	--	------	------	-----	-------	------	--	--	--

**KRAMER**

250	250		B9ES	2611	0,6	B9EVX	7254	202	BR9EIX	3981
-----	-----	--	------	------	-----	-------	------	-----	--------	------

**KREIDLER**

Flory 1Zyl.4Takt	50	05 -	C7HSA	4629	0,6	C7HVX	4533		CR7HIX	7544
J 50 Junior	50		B6HS	4510	0,6	B6HVX	7435	203	BR6HIX	3419
J 51 Junior	50		B6HS	4510	0,6	B6HVX	7435	203	BR6HIX	3419
K 50	50		B7HS	5110	0,6	B7HVX	7836	204	BR7HIX	7067
K 51	50		B7HS	5110	0,6	B7HVX	7836	204	BR7HIX	7067
K 52 Amazone	50		B7HS	5110	0,6	B7HVX	7836	204	BR7HIX	7067
K 52/2 Amazone	50		B7HS	5110	0,6	B7HVX	7836	204	BR7HIX	7067
K 53 Florett Motorrad	50		B7HS	5110	0,6	B7HVX	7836	204	BR7HIX	7067
K 53/1 Florett Mokick	50		B6HS	4510	0,6	B6HVX	7435	203	BR6HIX	3419
K 54 Florett Motorrad	50		B7HS	5110	0,6	B7HVX	7836	204	BR7HIX	7067
K 54/0(M) Florett Mokick	50		B6HS	4510	0,6	B6HVX	7435	203	BR6HIX	3419

Order  
No.Platin  
Gold-  
Palla-  
diumOrder Quick  
No. No.Order  
No.**KREIDLER**

K 54/319 Florett LF	50		B6HS	4510	0,5	B6HVX	7435	203	BR6HIX	3419
K 54/32 D-A(B) Florett LF/LH	50		B6HS	4510	0,6	B6HVX	7435	203	BR6HIX	3419
K 54/404 Florett RMC	50		B6HS	4510	0,5	B6HVX	7435	203	BR6HIX	3419
K 54/410 Florett RMC	50		B6HS	4510	0,6	B6HVX	7435	203	BR6HIX	3419
K 54/42 D Florett RM	50		B6HS	4510	0,5	B6HVX	7435	203	BR6HIX	3419
K 54/421 Florett RMC	50		B6HS	4510	0,6	B6HVX	7435	203	BR6HIX	3419
K 54/540 Florett RMC/S	50		B6HS	4510	0,5	B6HVX	7435	203	BR6HIX	3419
K54/2(A) Florett Super 4	50		B8HS	5510	0,6	B8HVX	2634	205	BR8HIX	7001
K54/2(B) Florett Motorrad	50		B8HS	5510	0,6	B8HVX	2634	205	BR8HIX	7001
K54/2(C) Florett Motorrad	50		B8HS	5510	0,6	B8HVX	2634	205	BR8HIX	7001
K54/3 Florett Motorrad	50		B8HS	5510	0,6	B8HVX	2634	205	BR8HIX	7001
K54/3 Florett RS	50		B8HS	5510	0,6	B8HVX	2634	205	BR8HIX	7001
K54/4 Florett Motorrad	50		B8HS	5510	0,6	B8HVX	2634	205	BR8HIX	7001
K54/5 Florett Super 5/TS	50		B8HS	5510	0,6	B8HVX	2634	205	BR8HIX	7001
K54/503 Florett RS L	50		B8HS	5510	0,6	B8HVX	2634	205	BR8HIX	7001
K54/511 Florett RS	50		B8HS	5510	0,6	B8HVX	2634	205	BR8HIX	7001
K54/512 Mustang / Cross	50		B8HS	5510	0,6	B8HVX	2634	205	BR8HIX	7001
K54/52 Florett GT	50		B8HS	5510	0,6	B8HVX	2634	205	BR8HIX	7001
K54/53 (B) Florett RS	50		B8HS	5510	0,6	B8HVX	2634	205	BR8HIX	7001
K54/54 Florett TM	50		B8HS	5510	0,6	B8HVX	2634	205	BR8HIX	7001
LF 50	50		B6HS	4510	0,6	B6HVX	7435	203	BR6HIX	3419
R 50	50		B7HS	5110	0,6	B7HVX	7836	204	BR7HIX	7067
Enduro	125	00 -	DP7EA-9	5629	0,9	DPR7EVX-9	7682		DPR7EIX-9	7803
Mustang	125		DR8EA	7162	0,7	DR8EVX	6354		DR8EIX	6681

**KTM**

50 GP	50	10.81 -	B7HS	5110	0,6	B7HVX	7836	204	BR7HIX	7067
50 GXE	50		B9EG	3530	0,6	B9EGV	5827		BR9EIX	3981
50 GXR	50				0,6	B9EVX	7254		BR9EIX	3981
50 SX Pro Junior LC Beta Engine	50	03 -	BR8ECM	3035	0,6	BR8ECMVX	5567			
50 Junior Adventure	50	02 -	BR8HS	4322	0,6	BR8HVX	6265	212	BR8HIX	7001
50 ME	50	10.81 -	B7HS	5110	0,6	B7HVX	7836	204	BR7HIX	7067
50 Mini Adventure	50	02 -	BR8HS	4322	0,6	BR8HVX	6265	212	BR8HIX	7001
50 Mini Adventure GS getrennte Schmierung	50	02 -	BR8HS	4322	0,6	BR8HVX	6265	212	BR8HIX	7001
50 Mini Adventure	50	01 - 01	B8HS	5510	0,6	B8HVX	2634	205	BR8HIX	7001
50 MLS	50		B6HS	4510	0,6	B6HVX	7435	203	BR6HIX	3419
50 MMS	50		B7HS	5110	0,6	B7HVX	7836	204	BR7HIX	7067
50 MS	50	10.81 -	B6HS	4510	0,6	B6HVX	7435	203	BR6HIX	3419
50 RSL	50		B7HS	5110	0,6	B7HVX	7836	204	BR7HIX	7067
50 Senior	50	03 -	BR8ECM	3035	0,6	BR8ECMVX	5567			
50 SX Pro Senior LC	50	03 -	BR8ECM	3035	0,6	BR8ECMVX	5567			
50 Senior Adventure	50	02 - 02	BR8HS	4322	0,6	BR8HVX	6265	212	BR8HIX	7001
50 SX Junior	50	01 - 01	B8HS	5510	0,6	B8HVX	2634	205	BR8HIX	7001
50 SX Senior	50	01 - 01	B8HS	5510	0,6	B8HVX	2634	205	BR8HIX	7001
50 SX Junior LC	50	02 - 02	BR10EG	3830	0,6					
50 SX Senior LC	50	02 - 02	BR10EG	3830	0,6					
50 SXR Adventure	50	98 - 01	B8HS	5510	0,6	B8HVX	2634	205	BR8HIX	7001
50 SXR Pro Senior	50	98 - 01	B8HS	5510	0,6	B8HVX	2634	205	BR8HIX	7001
50 XR Pro Junior	50	98 - 01	B8HS	5510	0,6	B8HVX	2634	205	BR8HIX	7001
Bora 25	50	10.81 -	BP6HS	4511	0,6	BP6HVX	4635		BPR6HIX	4085
Bora 50	50		B6HS	4510	0,6	B6HVX	7435	203	BR6HIX	3419
Comet	50	09.76 -	B6HS	4510	0,6	B6HVX	7435	203	BR6HIX	3419

Order  
No.Platin  
Gold-  
Palla-  
diumOrder Quick  
No. No.Order  
No.**KTM**

Crazy (CH)	50		BP5HS	4111	0,6					
Foxi	50		B5HS	4210	0,6					
Foxi (DK)	50		B7HS	5110	0,6	B7HVX	7836	204	BR7HIX	7067
Hobby	50	10.81 -	BP6ES	7811	0,6	BP6EVX	5832		BPR6EIX	6637
Pony	50	10.81 -	B5HS	4210	0,6					
Pony (CH)	50	10.81 -	B7HS	5110	0,6	B7HVX	7836	204	BR7HIX	7067
Postmofa	50		BP6ES	7811	0,6	BP6EVX	5832		BPR6EIX	6637
S5-E	50	99 -	B8HS	5510	0,6	B8HVX	2634	205	BR8HIX	7001
S5-GS Pro Junior	50	99 -	B8HS	5510	0,6	B8HVX	2634	205	BR8HIX	7001
S5-GS Pro Senior	50	99 -	B8HS	5510	0,6	B8HVX	2634	205	BR8HIX	7001
SM 25	50		BP6HS	4511	0,6	BP6HVX	4635		BPR6HIX	4085
Squadra	50		BP6ES	7811	0,6	BP6EVX	5832		BPR6EIX	6637
60 SX	60	98 -	R7234-10	5558	0,6					
65 SX	65	98 - 00	R7234-10	5558	0,6					
65 SX Beta Engine	65	03 -	BR8ECM	3035	0,6	BR8ECMVX	5567			
65 SX	65	01 - 02			0,6	BR10EG	4832			
80 Chopper	80		B9HS	5810	0,6	B9HVX	2254			
80 Enduro	80		B10EG	3630	0,6	B10EGV	5927			
80 IGS	80				0,6	B10EGV	5927			
80 IMX	80				0,6	B10EGV	5927			
80 PL	80	06.83 -12.84	B8HS	5510	0,6	B8HVX	2634	205	BR8HIX	7001
80 RL	80	10.81 -	B8HS	5510	0,6	B8HVX	2634	205	BR8HIX	7001
80 RLS	80	10.81 -	B9HS	5810	0,6	B9HVX	2254			
80 RLW	80	10.81 -	B9HS	5810	0,6	B9HVX	2254			
80 RS	80	10.81 -	B8HS	5510	0,6	B8HVX	2634	205	BR8HIX	7001
Bora 80	80	10.81 -	B8HS	5510	0,6	B8HVX	2634	205	BR8HIX	7001
85 IGS	85				0,6	B10EGV	5927			
85 IMX	85				0,6	B10EGV	5927			
85 SX	85	04 -			0,6	BR10ECMVX	2457			
GS 100	100	08.73 -08.76	B9HCS	2721	0,6					
MC 100	100	08.73 -08.76	B9HCS	2721	0,6					
105 SX	105	04 -			0,7	BR10ECMVX	2457			
125 EGS	125	93 -			0,6	B10EGV	5927			
125 EGS	125	98 -	R6918B-8	4492	0,6					
125 EGS	125	99 -	R6918B-8	4492	0,6					
125 Enduro	125		B10EG	3630	0,6	B10EGV	5927			
125 EXC	125	98 - 99	R6918B-8	4492	0,6					
125 EXC	125	08.97 - 98	R6918B-8	4492	0,6					
125 EXC	125	93 - 95			0,6	B10EGV	5927			
125 EXC	125	96 -08.97			0,6	B10EGV	5927			
125 EXC	125	01 -			0,6	BR9EVX	1265		BR9EIX	3981
125 EXC	125	99 - 00	R6918B-8	4492	0,6					
125 EXE	125	99 -	BR8HS	4322	0,6	BR8HVX	6265	212	BR8HIX	7001
125 LC 2 (Langgewinde)	125	96 - 00	BR9ES	5722	0,6	BR9EVX	1265	208	BR9EIX	3981
125 LC2 (Kurzgewinde)	125	00 -	BR8HS	4322	0,6	BR8HVX	6265	212	BR8HIX	7001
125 MX	125				0,6	B10EGV	5927			
125 Sting	125	98 -	BR8ES	5422	0,7	BR8EVX	1262	207	BR8EIX	5044
125 Supermoto	125	99 -	BR8HS	4322	0,6	BR8HVX	6265	212	BR8HIX	7001
125 SX	125	96 -08.97	BR10EG	3830	0,6					
125 SX (98er)	125	08.97 - 98	R6918B-8	4492	0,6					
125 SX	125	93 - 95			0,6	B10EGV	5927			
125 SX	125	02 -			0,6	BR9EVX	1265		BR9EIX	3981



Order  
No.Gold-  
Palla-  
dium

Platin

Order  
No.Quick  
No.

Iridium

Order  
No.

<b>KTM</b>										
125 SX	125	99 - 00	R6918B-8	4492	0,6					
125 SX	125	01 - 01			0,7	BR8EVX	1262		BR8EIX	5044
125 TXC	125				0,6	B10EGV	5927			
GS 125 12,7 mm	125		B8HS	5510	0,6	B8HVX	2634	205	BR8HIX	7001
GS 125 19,0 mm	125				0,6	B10EGV	5927			
MC 125 12,7 mm	125		B8HS	5510	0,6	B8HVX	2634	205	BR8HIX	7001
MC 125 19,0 mm	125		B9EG	3530	0,6	B9EGV	5827		BR9EIX	3981
MC 125 GP	125		B10HS	2399	0,6	B10HVX	2940			
GS 175	175		B8HS	5510	0,6	B8HVX	2634	205	BR8HIX	7001
MC 175	175		B8HS	5510	0,6	B8HVX	2634	205	BR8HIX	7001
200 EGS	200	98 -	BR8EG	3130	0,6					
200 EGS	200	99 -	BR8EG	3130	0,6					
200 EXC	200	98 - 99	BR8EG	3130	0,6					
200 EXC	200	02 -	BR8EG	3130	0,6					
200 EXC	200	99 - 01	BR9EG	3230	0,6	BR9EVX	1265		BR9EIX	3981
200 MXC	200	99 -	BR8EG	3130	0,6					
200 SX	200	03 -			0,6	BR9EVX	1265		BR9EIX	3981
250 DXC	250				0,6	B9EGV	5827			
250 EGS	250	97 -	BR8ECM	3035	0,6	BR8ECMVX	5567			
250 EGS	250	98 -	BR8ECM	3035	0,6	BR8ECMVX	5567			
250 EGS	250	93 - 95			0,6	B9EGV	5827			
250 EGS	250	99 -	BR8ECM	3035	0,6	BR8ECMVX	5567			
250 Enduro	250		B10EG	3630	0,6	B10EGV	5927			
250 EXC	250	97 - 98	BR8ECM	3035	0,6	BR8ECMVX	5567			
250 EXC / Sixt Days	250	98 - 01	BR8ECM	3035	0,8	BR8ECMVX	5567			
250 EXC	250	96 - 96			0,6	B8EGV	5627			
250 EXC	250	93 - 95			0,6	B9EGV	5827			
250 EXC Enduro Competition	250	03 -	BR7ES	5122	0,6	BR7EVX	4556			
250 EXC Racing GS	250	03 -	DCPR8E	4179	0,6	DCPR8EVX	2265		DCPR8EIX	6546
250 EXC Racing	250	03 -	DCPR8E	4179	0,6	DCPR8EVX	2265		DCPR8EIX	6546
250 EXC Racing / Sixt Days	250	02 - 02	CR8EK	3478	0,6				CR8EIX	4218
250 EXC Racing	250	02 - 02	CR8EK	3478	0,6				CR8EIX	4218
250 EXC-F	250	07 -	CR9EKB	2305	0,7				CR9EIX	3521
250 MX	250				0,6	B9EGV	5827			
250 SX	250	98 - 99	BR8ECM	3035	0,8	BR8ECMVX	5567			
250 SX	250	93 - 95			0,6	B9EGV	5827			
250 SX	250	96 -	BR8EG	3130	0,6					
250 SX	250	97 - 98	BR8ECM	3035	0,6	BR8ECMVX	5567			
250 SX	250	99 -	BR8ECM	3035	0,6	BR8ECMVX	5567			
250 SX 4Takt	250	05 -	CR9EKB	2305	0,7				CR9EIX	3521
250 SXC	250	99 -	BR8ECM	3035	0,6	BR8ECMVX	5567			
250 SXF	250	05 -	CR9EKB	2305	0,7				CR9EIX	3521
250 TXC	250				0,6	B9EGV	5827			
GS 250 12,7 mm	250		B9HS	5810	0,6	B9HVX	2254			
GS 250 19,0 mm	250				0,6	B9EGV	5827			
MC 250 12,7 mm	250		B9HS	5810	0,6	B9HVX	2254			
MC 250 19,0 mm	250		B9EG	3530	0,6	B9EGV	5827		BR9EIX	3981
MC 250 GP 12,7 mm	250		B9HS	5810	0,6	B9HVX	2254			
MC 250 GP 19,0 mm	250		B9EG	3530	0,6	B9EGV	5827		BR9EIX	3981
300 DXC	300	90 - 95			0,6	B9EGV	5827			
300 EGS	300	97 -	BR8ECM	3035	0,6	BR8ECMVX	5567			
300 EGS	300	93 - 95			0,6	B9EGV	5827			

Order  
No.Platin  
Gold-  
Palla-  
diumOrder Quick  
No. No.Order  
No.**KTM**

300 EGS	300	99 -	BR8ECM	3035	0,6	BR8ECMVX	5567			
300 EXC	300	93 - 95			0,6	B9EGV	5827			
300 EXC	300	97 - 98	BR8ECM	3035	0,6	BR8ECMVX	5567			
300 EXC	300	96 - 96			0,6	B8EGV	5627			
300 EXC / Sixt Days	300	99 -	BR8ECM	3035	0,6	BR8ECMVX	5567			
300 EXC Enduro Competition	300	03 -	BR7ES	5122	0,6	BR7EVX	4556			
300 GS	300	90 - 95			0,6	B9EGV	5827			
300 LC (I)	300		B10EG	3630	0,6	B10EGV	5927			
300 MX	300	- 95			0,6	B9EGV	5827			
300 MXC	300	97 - 02	BR8ECM	3035	0,6	BR8ECMVX	5567			
300 MXC	300	03 -	BR7ES	5122	0,6	BR7EVX	4556			
300 SX	300	93 - 95			0,6	B9EGV	5827			
300 SX	300	99 -	BR8ECM	3035	0,6	BR8ECMVX	5567			
300 TXC	300	- 95			0,6	B9EGV	5827			
350 GS	350				0,6	B9EVX	7254		BR9EIX	3981
350 MX	350				0,6	B9EVX	7254		BR9EIX	3981
LC4 18kW	350	- 93	D8EA	2120	0,6	D8EVX	2850	216	DR8EIX	6681
LC4 30kW	350	- 93	D8EA	2120	0,6	D8EVX	2850	216	DR8EIX	6681
LC4 350 EGS	350	93 -	D8EA	2120	0,6	D8EVX	2850	216	DR8EIX	6681
LC4 350 EXC	350	93 -	D8EA	2120	0,6	D8EVX	2850	216	DR8EIX	6681
360 EGS	360	97 -	BR8ECM	3035	0,6	BR8ECMVX	5567			
360 EXC	360	97 -	BR8ECM	3035	0,6	BR8ECMVX	5567			
360 MXC	360	97 -	BR8ECM	3035	0,6	BR8ECMVX	5567			
360 SX	360	96 -	BR8EG	3130	0,6					
360 SX	360	97 -	BR8ECM	3035	0,6	BR8ECMVX	5567			
380 Enduro	380	98 -	BR8ECM	3035	0,6	BR8ECMVX	5567			
380 EGS	380	98 -	BR8ECM	3035	0,8	BR8ECMVX	5567			
380 EGS	380	99 -	BR8ECM	3035	0,6	BR8ECMVX	5567			
380 EXC	380	98 -	BR8ECM	3035	0,8	BR8ECMVX	5567			
380 SX	380	99 -	BR8ECM	3035	0,6	BR8ECMVX	5567			
390	390		B9EG	3530	0,6	B9EGV	5827		BR9EIX	3981
400 Enduro-E	400	98 -	D8EA	2120	0,6	D8EVX	2850	216	DR8EIX	6681
400 EGS	400	97 -	D8EA	2120	0,6	D8EVX	2850	216	DR8EIX	6681
400 EGS-E	400	97 -	DR8EA	7162	0,6	DR8EVX	6354		DR8EIX	6681
400 EXC Racing	400	03 -	DCPR8E	4179	0,6	DCPR8EVX	2265		DCPR8EIX	6546
400 EXC Racing	400	99-04.02	CR8EK	3478	0,7				CR8EIX	4218
400 EXC Racing	400	05.02 -	DCPR8E	4179	0,6	DCPR8EVX	2265		DCPR8EIX	6546
400 LC4-E	400	99-04.02	DR8EA	7162	0,7	DR8EVX	6354		DR8EIX	6681
400 LC4	400	99-04.02	DR8EA	7162	0,7	DR8EVX	6354		DR8EIX	6681
400 LS-E	400	97-04.02	DR8EA	7162	0,6	DR8EVX	6354		DR8EIX	6681
400 SC	400	96 -	D8EA	2120	0,6	D8EVX	2850	216	DR8EIX	6681
400 SC	400	98 -	D8EA	2120	0,6	D8EVX	2850	216	DR8EIX	6681
400 Supercompetition	400	97 -	D8EA	2120	0,6	D8EVX	2850	216	DR8EIX	6681
400 SX	400	98-04.02	D8EA	2120	0,6	D8EVX	2850	216	DR8EIX	6681
400 SX Racing / Six Days	400	99-04.02	CR8EK	3478	0,7				CR8EIX	4218
400 SX Racing	400	05.02 -	DCPR8E	4179	0,6	DCPR8EVX	2265		DCPR8EIX	6546
400 SXC	400	98-04.02	D8EA	2120	0,6	D8EVX	2850	216	DR8EIX	6681
400 SXC	400	99-04.02	D8EA	2120	0,6	D8EVX	2850	216	DR8EIX	6681
400 SXC 20kW	400	99-04.02	D8EA	2120	0,6	D8EVX	2850	216	DR8EIX	6681
GS 400	400		B9HS	5810	0,6	B9HVX	2254			
LC4- E 400 Enduro	400	01 -	DR8EA	7162	0,7	DR8EVX	6354		DR8EIX	6681
LC4 400	400	98 -	DR8EA	7162	0,7	DR8EVX	6354		DR8EIX	6681

Order  
No.Gold-  
Palla-  
diumOrder Quick  
No. No.

Iridium

Order  
No.

<b>KTM</b>										
LC4 400 EGS	400	93 -	D8EA	2120	0,6	D8EVX	2850	216	DR8EIX	6681
LC4 400 EXC	400	93 -	D8EA	2120	0,6	D8EVX	2850	216	DR8EIX	6681
LC4 Competition	400	98 -	DR8EA	7162	0,7	DR8EVX	6354		DR8EIX	6681
LC4-E	400	05.02 -	DCPR8E	4179	0,6	DCPR8EVX	2265		DCPR8EIX	6546
MC 400	400		B9HS	5810	0,6	B9HVX	2254			
MC 400 GP	400		B9HS	5810	0,6	B9HVX	2254			
420	420		B9EG	3530	0,6	B9EGV	5827		BR9EIX	3981
440 EXC	440	94 -			0,6	B85EGV	7498			
440 SX	440	94 -			0,6	B85EGV	7498			
450 EXC Racing GS	450	03 -	DCPR8E	4179	0,6	DCPR8EVX	2265		DCPR8EIX	6546
450 EXC Racing	450	03 -	DCPR8E	4179	0,6	DCPR8EVX	2265		DCPR8EIX	6546
450 EXC	450	08 -	LKAR8A-9	4786	0,9					
450 EXC- R	450	07 -	LKAR8A-9	4786	0,9					
450 MXC GS	450	03 -	DCPR8E	4179	0,6	DCPR8EVX	2265		DCPR8EIX	6546
450 MXC Dessert	450	03 -	DCPR8E	4179	0,6	DCPR8EVX	2265		DCPR8EIX	6546
450 SMR	450	05 -	DCPR8E	4179	0,6	DCPR8EVX	2265		DCPR8EIX	6546
450 SX Racing	450	03 -	DCPR8E	4179	0,6	DCPR8EVX	2265		DCPR8EIX	6546
450 SX-F	450	07 -	CR9EKB	2305	0,7				CR9EIX	3521
505 SX-F	477	07 -	CR9EKB	2305	0,7				CR9EIX	3521
495	495		B9EG	3530	0,6	B9EGV	5827		BR9EIX	3981
500 4 TGS	500		DP9EA-9	6629	0,9	DP9EVX-9	3331		DPR9EIX-9	5545
500 4 TXC	500		DP9EA-9	6629	0,9	DP9EVX-9	3331		DPR9EIX-9	5545
500 DXC	500		B9ES	2611	0,6	B9EVX	7254	202	BR9EIX	3981
500 EXC	500		B9ES	2611	0,6	B9EVX	7254	202	BR9EIX	3981
500 MX	500				0,6	B9EVX	7254		BR9EIX	3981
500 SX	500	93 -	B10ES	7928	0,6	B10EVX	7335		BR10EIX	6801
GS 500 2Stroke	500		B10EG	3630	0,6	B10EGV	5927			
GS 500 4Stroke	500		D8EA	2120	0,6	D8EVX	2850	216	DR8EIX	6681
MC 500 2Stroke	500		B10EG	3630	0,6	B10EGV	5927			
MC 500 4Stroke	500		D8EA	2120	0,6	D8EVX	2850	216	DR8EIX	6681
525 XC Desert Racing	510	07 - 07	DCPR8E	4179	0,6	DCPR8EVX	2265		DCPR8EIX	6546
520 EXC Racing / Six Days	520	99-04.02	CR8EK	3478	0,7				CR8EIX	4218
520 EXC Racing	520	05.02 -	DCPR8E	4179	0,6	DCPR8EVX	2265		DCPR8EIX	6546
520 SX Racing	520	99-04.02	CR8EK	3478	0,7				CR8EIX	4218
520 SX Racing	520	05.02 -	DCPR8E	4179	0,6	DCPR8EVX	2265		DCPR8EIX	6546
525 EXC Racing	525	03 -	DCPR8E	4179	0,6	DCPR8EVX	2265		DCPR8EIX	6546
525 EXC Racing GS	525	03 -	DCPR8E	4179	0,6	DCPR8EVX	2265		DCPR8EIX	6546
525 MXC	525	03 -	DCPR8E	4179	0,6	DCPR8EVX	2265		DCPR8EIX	6546
525 MXC Desert Racing	525	05 -	DCPR8E	4179	0,6	DCPR8EVX	2265		DCPR8EIX	6546
525 SMR	525	05 -	DCPR8E	4179	0,6	DCPR8EVX	2265		DCPR8EIX	6546
525 SX Racing	525	03 -	DCPR8E	4179	0,6	DCPR8EVX	2265		DCPR8EIX	6546
530 EXC	530	08 -	LKAR8A-9	4786	0,9					
540 DXC	540				0,6	B10EGV	5927			
540 MX	540		B9ES	2611	0,6	B9EVX	7254	202	BR9EIX	3981
540 SXC	540	98 -	D8EA	2120	0,6	D8EVX	2850	216	DR8EIX	6681
540 SXC	540	99 -	D8EA	2120	0,6	D8EVX	2850	216	DR8EIX	6681
540 SXC 20kW	540	99 -	D8EA	2120	0,6	D8EVX	2850	216	DR8EIX	6681
540 SXS Racing	540	02 -	CR8EK	3478	0,7				CR8EIX	4218
560 SMR	565	07 -	DCPR8E	4179	0,6	DCPR8EVX	2265		DCPR8EIX	6546
600 4 TGS	600		DP9EA-9	6629	0,9	DP9EVX-9	3331		DPR9EIX-9	5545
600 4 TMX	600		DP9EA-9	6629	0,9	DP9EVX-9	3331		DPR9EIX-9	5545
600 4 TXC	600		DP9EA-9	6629	0,9	DP9EVX-9	3331		DPR9EIX-9	5545

Order  
No.Platin  
Gold-  
Palla-  
diumOrder Quick  
No. No.Iridium  
Order  
No.**KTM**

600 Country	600		D8EA	2120	0,6	D8EVX	2850	216	DR8EIX	6681
600 Enduro	600		D8EA	2120	0,6	D8EVX	2850	216	DR8EIX	6681
600 MX	600		D8EA	2120	0,6	D8EVX	2850	216	DR8EIX	6681
LC4 Enduro 17kW	600	- 87	D8EA	2120	0,6	D8EVX	2850	216	DR8EIX	6681
LC4 Enduro 36kW	600	- 87	D8EA	2120	0,6	D8EVX	2850	216	DR8EIX	6681
LC4 600 EGS	600	93 -	D8EA	2120	0,6	D8EVX	2850	216	DR8EIX	6681
LC4 600 EXC	600	93 -	D8EA	2120	0,6	D8EVX	2850	216	DR8EIX	6681
620 Duke	609	94 -	D8EA	2120	0,6	D8EVX	2850	216	DR8EIX	6681
LC4 620 Supercompetition	609	01 -04.02	DR8EA	7162	0,7	DR8EVX	6354		DR8EIX	6681
LC4 620 SC Supermoto	609	01 -04.02	DR8EA	7162	0,7	DR8EVX	6354		DR8EIX	6681
LC4 612 EGS	612	93 -	D8EA	2120	0,6	D8EVX	2850	216	DR8EIX	6681
LC4 612 EXC	612	93 -	D8EA	2120	0,6	D8EVX	2850	216	DR8EIX	6681
620 Duke-E	620	97 -	DR8EA	7162	0,6	DR8EVX	6354		DR8EIX	6681
620 EGS	620	97 -	D8EA	2120	0,6	D8EVX	2850	216	DR8EIX	6681
620 EGS-E	620	97 -	DR8EA	7162	0,6	DR8EVX	6354		DR8EIX	6681
620 LS4 Rally	620	97 -	D8EA	2120	0,6	D8EVX	2850	216	DR8EIX	6681
620 LS-E	620	97 -	DR8EA	7162	0,6	DR8EVX	6354		DR8EIX	6681
620 SC	620	96 -	D8EA	2120	0,6	D8EVX	2850	216	DR8EIX	6681
620 SC	620	98 -	D8EA	2120	0,6	D8EVX	2850	216	DR8EIX	6681
620 Supercompetition	620	97 -04.02	D8EA	2120	0,6	D8EVX	2850	216	DR8EIX	6681
620 SX	620	96 -	D8EA	2120	0,6	D8EVX	2850	216	DR8EIX	6681
620 SX	620	99 -	D8EA	2120	0,6	D8EVX	2850	216	DR8EIX	6681
LC4 620 EGS	620	94 -	D8EA	2120	0,6	D8EVX	2850	216	DR8EIX	6681
LC4 620 EXC	620	94 -	D8EA	2120	0,6	D8EVX	2850	216	DR8EIX	6681
LC4 620 SX	620	94 -	D8EA	2120	0,6	D8EVX	2850	216	DR8EIX	6681
LC 4 Supercopetition Supermoto	620	05.02 -	DCPR8E	4179	0,6	DCPR8EVX	2265		DCPR8EIX	6546
LC4 Super Competition	620	00 -04.02	DPR8EA-9	4929	0,9	DPR8EVX-9	2872	221	DPR8EIX-9	2202
Supermoto Competition 620	620	98 - 00	D8EA	2120	0,6	D8EVX	2850	216	DR8EIX	6681
625 SC	625	02 -	DPR8EA-9	4929	0,9	DPR8EVX-9	2872	221	DPR8EIX-9	2202
625 SMC	625	05 -	DCPR8E	4179	0,6	DCPR8EVX	2265		DCPR8EIX	6546
625 SXC Hard Enduro	625	03 -	DCPR8E	4179	0,6	DCPR8EVX	2265		DCPR8EIX	6546
625 SXC Super Moto	625	02 -	DCPR8E	4179	0,6	DCPR8EVX	2265		DCPR8EIX	6546
640 Duke	625	05 -	DCPR8E	4179	0,6	DCPR8EVX	2265		DCPR8EIX	6546
640 Duke 2	625	02 -04.02	DPR8EA-9	4929	0,9	DPR8EVX-9	2872	221	DPR8EIX-9	2202
640 LC4 SM	625	05 -	DCPR8E	4179	0,6	DCPR8EVX	2265		DCPR8EIX	6546
640 Supermoto Spezial Edition	625	03 -	DCPR8E	4179	0,6	DCPR8EVX	2265		DCPR8EIX	6546
Adventure R 640	625	98 - 01	DR8EA	7162	0,7	DR8EVX	6354		DR8EIX	6681
Duke 2	625	00 -04.02	DPR8EA-9	4929	0,9	DPR8EVX-9	2872	221	DPR8EIX-9	2202
Duke 640	625	98 - 01	DR8EA	7162	0,7	DR8EVX	6354		DR8EIX	6681
Duke II	625	05.02 -	DCPR8E	4179	0,6	DCPR8EVX	2265		DCPR8EIX	6546
Duke II	625	99 - 01	DR8EA	7162	0,7	DR8EVX	6354		DR8EIX	6681
LC 4 E Supermoto	625	05.02 - 02	DCPR8E	4179	0,6	DCPR8EVX	2265		DCPR8EIX	6546
LC4 640	625	98 - 00	DR8EA	7162	0,7	DR8EVX	6354		DR8EIX	6681
640 LC4 Adventure	625	02 -04.02	DPR8EA-9	4929	0,9	DPR8EVX-9	2872	221	DPR8EIX-9	2202
640 LC4-E Six Days	625	02 -04.02	DPR8EA-9	4929	0,9	DPR8EVX-9	2872	221	DPR8EIX-9	2202
640 LC4	625	02 -04.02	DPR8EA-9	4929	0,9	DPR8EVX-9	2872	221	DPR8EIX-9	2202
LC 4 Adventure R	625	05.02 -	DCPR8E	4179	0,6	DCPR8EVX	2265		DCPR8EIX	6546
LC4- E Supermoto	625	00 - 00	DPR8EA-9	4929	0,9	DPR8EVX-9	2872	221	DPR8EIX-9	2202
640 LC4	625	99 - 01	DR8EA	7162	0,7	DR8EVX	6354		DR8EIX	6681
LC 4 E	625	05.02 -	DCPR8E	4179	0,6	DCPR8EVX	2265		DCPR8EIX	6546
640 LC4 Super Moto	625	02 -04.02	DPR8EA-9	4929	0,9	DPR8EVX-9	2872	221	DPR8EIX-9	2202
LC4- E 640 Supermoto	625	01 - 01	DR8EA	7162	0,7	DR8EVX	6354		DR8EIX	6681

Order  
No.Gold-  
Palla-  
dium

Platin

Order  
No.Quick  
No.

Iridium

Order  
No.**KTM**

LC4- E 640 Enduro	625	01 - 01	DR8EA	7162	0,7	DR8EVX	6354		DR8EIX	6681
LC4-640 Hard Enduro	625	03 -	DCPR8E	4179	0,6	DCPR8EVX	2265		DCPR8EIX	6546
640 LC4-E SM Prestige	625	02 -04.02	DPR8EA-9	4929	0,9	DPR8EVX-9	2872	221	DPR8EIX-9	2202
LC4- E	625	00 - 00	DPR8EA-9	4929	0,9	DPR8EVX-9	2872	221	DPR8EIX-9	2202
LC4 Prestige Supermoto	625	03 -	DCPR8E	4179	0,6	DCPR8EVX	2265		DCPR8EIX	6546
LC4 Adventure	625	00 - 00	DPR8EA-9	4929	0,9	DPR8EVX-9	2872	221	DPR8EIX-9	2202
LC4 640 Duke II	625	03 -	DCPR8E	4179	0,6	DCPR8EVX	2265		DCPR8EIX	6546
LC4- 640 Adverture	625	01 -04.02	DR8EA	7162	0,7	DR8EVX	6354		DR8EIX	6681
660 Rallye	650	02 -04.02	DR9EA	3437	0,6	DR9EVX	6361	219	DR9EIX	4772
660 Super Moto Factory Replica	650	02 -	DR9EA	3437	0,6	DR9EVX	6361	219	DR9EIX	4772
LC4 660	650	03 -	DR9EA	3437	0,6	DR9EVX	6361	219	DR9EIX	4772
660 LC4 Rallye	650	99 - 01	DR8EA	7162	0,6	DR8EVX	6354		DR8EIX	6681
Rallye	650	00 - 01	DPR8EA-9	4929	0,9	DPR8EVX-9	2872	221	DPR8EIX-9	2202
Rallye	650	05.02 - 02	DCPR8E	4179	0,6	DCPR8EVX	2265		DCPR8EIX	6546
660 SMC	660	05 -	DCPR8E	4179	0,6	DCPR8EVX	2265		DCPR8EIX	6546
950 Super Enduro R	950	06 -	CR8EK	3478	0,7				CR8EIX	4218
950 Adventure	950	03 -	CR8EK	3478	0,7				CR8EIX	4218
950 Supermoto	950	05 -	CR8EK	3478	0,7				CR8EIX	4218
950 Adventure S	950	03 -	CR8EK	3478	0,7				CR8EIX	4218
950 Supermoto R	950	07 -	CR8EK	3478	0,7				CR8EIX	4218
LC8 950 Rally	950	03 -	CR8EK	3478	0,7				CR8EIX	4218
990 Superduke	1000	05 -	DCPR8E	4179	0,6	DCPR8EVX	2265			
990 Adventure / S	1000	06 -	DCPR8E	4179	0,6	DCPR8EVX	2265			
990 Duke	1000	09.04 -	DCPR8E	4179	0,6	DCPR8EVX	2265			
Super Duke 990 RC8 v2 88kW	1000	07 -							KR8DI	4742

**KUANG YANG**

GS7E - Movie	50		BP6HSA	1046	0,6				BPR6HIX	4085
KA 50	50		BP6HSA	1046	0,6				BPR6HIX	4085
KA 50G	50		BP6HSA	1046	0,6				BPR6HIX	4085

**KYMCO**

Tomos TX 50	50	01 -	B6HS	4510	0,6	B6HVX	7435	203	BR6HIX	3419
CK 125	125	04 -	DR8EA	7162	0,7	DR8EVX	6354		DR8EIX	6681
Hipster 125 4Takt/4Ventil	125	01 -	CR8E	1275	0,6	CR8EVX	6487	226	CR8EIX	4218
Hipster 125 2Ventil	125		DR8EA	7162	0,7	DR8EVX	6354		DR8EIX	6681
Pulsar 125 4Takt	125	01 -	DR8EA	7162	0,7	DR8EVX	6354		DR8EIX	6681
Stryker 125	125	99 -	DR8EA	7162	0,7	DR8EVX	6354		DR8EIX	6681
Stryker 125 II	125	02 -	DR8EA	7162	0,7	DR8EVX	6354		DR8EIX	6681
Zing 125	125	99 -	DR8EA	7162	0,7	DR8EVX	6354		DR8EIX	6681
Venox 250 4Takt	250	01 -	DPR7EA-9	5129	0,9	DPR7EVX-9	7682	220	DPR7EIX-9	7803

**LAMBRETTA**

3V77/4V/5V	50		B6HS	4510	0,5	B6HVX	7435	203	BR6HIX	3419
Puma Cross,Trial	50		B6HS	4510	0,5	B6HVX	7435	203	BR6HIX	3419
125,Lince,Linea,SX	125		B7ES	1111	0,5	B7EVX	6934			
150 GP	150		B7ES	1111	0,5	B7EVX	6934			
Spezial 150	150		B7ES	1111	0,5	B7EVX	6934			
200 GP	200		B7ES	1111	0,5	B7EVX	6934			
200,Jet,Lince,Mensa-Expres	200		B7ES	1111	0,5	B7EVX	6934			
Pony,SX	200		B7ES	1111	0,5	B7EVX	6934			

Order  
No.Platin  
Gold-  
PalladiumOrder Quick  
No. No.Order  
No.**LAVERDA**

CU125 Ride, GS125 Lesmo	125		B8ES	2411	0,5	B8EVX	7051	201	BR8EIX	5044
Custom, Strada	125		B9ES	2611	0,5	B9EVX	7254	202	BR9EIX	3981
LB125 Uno	125		B8ES	2411	0,5	B8EVX	7051	201	BR8EIX	5044
350 Alpino	350		D9EA	2420	0,5	D9EVX	2834		DR9EIX	4772
500 Alpino/Montjuich	500		D9EA	2420	0,5	D9EVX	2834		DR9EIX	4772
OR600 Atlas	600		D8EA	2120	0,6	D8EVX	2850	216	DR8EIX	6681
650 Ghost	668	96 -	DCPR9E	2641	0,6	DCPR9EVX	6436		DCPR9EIX	2316
650 Ghost Strike	668	96 -	DCPR9E	2641	0,6	DCPR9EVX	6436		DCPR9EIX	2316
650 Ghost Legend	668	96 -	DCPR9E	2641	0,6	DCPR9EVX	6436		DCPR9EIX	2316
650 Sport	668	95 -	DCPR9E	2641	0,6	DCPR9EVX	6436		DCPR9EIX	2316
668	668	96 -	DCPR9E	2641	0,6	DCPR9EVX	6436		DCPR9EIX	2316
668	668	97 -	DCPR9E	2641	0,6	DCPR9EVX	6436		DCPR9EIX	2316
668	668		DCPR9E	2641	0,6	DCPR9EVX	6436		DCPR9EIX	2316
750 S Formula	750	98 -	DCPR9E	2641	0,6	DCPR9EVX	6436		DCPR9EIX	2316
750/GS/GT/S/SFC/SF-2D	750		BP8ES	2912	0,5	BP8EVX	2671			
770 GTL	750		BP7ES	2412	0,5	BP7EVX	7270	206	BPR7EIX	4055
SF,SF Competizione/SS	750		B10EGV	5927	0,5	B10EVX	7335			
SF2-10, SF3	750		B8ES	2411	0,5	B8EVX	7051	201	BR8EIX	5044
1000 RGS	1000		B8ES	2411	0,6	B8EVX	7051	201	BR8EIX	5044
1000/Jarama/Jota/SC/CE/CL	1000		B8ES	2411	0,6	B8EVX	7051	201	BR8EIX	5044
SFC 1000	1000	04 -	B9ES	2611	0,5	B9EVX	7254	202	BR9EIX	3981
1200/Mirage/TS	1200		B8ES	2411	0,6	B8EVX	7051	201	BR8EIX	5044

**LEM**

2001 Bay	50		BP6ES	7811	0,5	BP6EVX	5832		BPR6EIX	6637
2001 Matic	50		BP6ES	7811	0,5	BP6EVX	5832		BPR6EIX	6637
2001 Variant	50		BP6ES	7811	0,5	BP6EVX	5832		BPR6EIX	6637
Cayman	50		B7HS	5110	0,5	B7HVX	7836	204	BR7HIX	7067
Cayman LC	50		B7HS	5110	0,5	B7HVX	7836	204	BR7HIX	7067
Chembol Form	50		B6ES	7310	0,5	B6EVX	5136			
Chembol Raid	50		B6ES	7310	0,5	B6EVX	5136			
Cinno Corsa 8 / 10	50		B6HS	4510	0,5	B6HVX	7435	203	BR6HIX	3419
Condor	50		B7HS	5110	0,5	B7HVX	7836	204	BR7HIX	7067
Convert	50		B5HS	4210	0,5					
CR 3	50	97 -	B7HS	5110	0,5	B7HVX	7836	204	BR7HIX	7067
L 2	50		B7HS	5110	0,5	B7HVX	7836	204	BR7HIX	7067
LX 1	50		B8HS	5510	0,6	B8HVX	2634	205	BR8HIX	7001
LX 2	50	97 -	B7HS	5110	0,5	B7HVX	7836	204	BR7HIX	7067
LX 2-S Sport	50	97 -	B7HS	5110	0,5	B7HVX	7836	204	BR7HIX	7067
LX 2-SR	50		B7HS	5110	0,5	B7HVX	7836	204	BR7HIX	7067
LX 4 New	50		B9ES	2611	0,6	B9EVX	7254	202	BR9EIX	3981
Piesse	50		B5HS	4210	0,5					
Pizeta	50		B5HS	4210	0,5					
Pratikal Kit SL	50		B5HS	4210	0,5					
R 2 Air	50					B10EGV	5927			
R 3 Air	50					B10EGV	5927			
R 3 Usa	50					B10EGV	5927			
SK 6	50		B7HS	5110	0,5	B7HVX	7836	204	BR7HIX	7067
SM 2	50		B7HS	5110	0,5	B7HVX	7836	204	BR7HIX	7067
SM 3	50					B10EGV	5927			
Stratos	50		B6ES	7310	0,5	B6EVX	5136			
Stratos Matic	50		B5HS	4210	0,5					

Order  
No.Platin  
Gold-  
Palla-  
diumOrder Quick  
No. No.

Iridium

Order  
No.**MAGNI**

Sfida	1000		BP6ES	7811	0,6	BP6EVX	5832		BPR6EIX	6637
-------	------	--	-------	------	-----	--------	------	--	---------	------

**MAICO**

MC 125-360		- 70			0,7	B9HVX	2264			
GS 125-360		- 70			0,7	B9HVX	2264			
GS 125-490		71 - 97			0,6	B9EVX	7254		BR9EIX	3981
MC 125-490		71 - 97			0,6	B9EVX	7254		br9eix	3981
MD 50	50				0,7	B9HVX	2264			
Mofa	50				0,7	B6HVX	7435		BR6HIX	3419
Wiesel	50				0,7	B6HVX	7435		BR6HIX	3419
MD 125	125				0,7	B9HVX	2264			
M 125 / 126	125				0,7	B6HVX	7435		BR6HIX	3419
GS 125	125		B9ES	2611	0,5	B9EVX	7254	202	BR9EIX	3981
MC 125	125		B9ES	2611	0,5	B9EVX	7254	202	BR9EIX	3981
SG 125	125		B9ES	2611	0,5	B9EVX	7254	202	BR9EIX	3981
Macomobil MB 150	150				0,7	B7HVX	7736		BR7HIX	7067
M 150 / 151	150				0,7	B6HVX	7435		BR6HIX	3419
Maicoletta 175	175				0,7	B8HVX	2634		BR8HIX	7001
M 175	175				0,7	B7HVX	7736		BR7HIX	7067
M 175 SS	175				0,7	B9HVX	2264			
M 200	200				0,7	B7HVX	7736		BR7HIX	7067
Macomobil MB 2000	200				0,7	B7HVX	7736		BR7HIX	7067
MD 250 wk	250				0,6	B9EVX	7254		BR9EIX	3981
M 250 S / 1 Blizzard	250				0,7	B7HVX	7736		BR7HIX	7067
M 250	250				0,7	B8HVX	2634		BR8HIX	7001
M 250 SS	250				0,7	B9HVX	2264			
M 250 B (Behördenausführung)	250				0,7	B8HVX	2634		BR8HIX	7001
M 250 M Military	250				0,6	B9EVX	7254		BR9EIX	3981
M 250 S / 2 Blizzard	250				0,7	B8HVX	2634		BR8HIX	7001
Maicoletta 250	250				0,7	B8HVX	2634		BR8HIX	7001
MD 250	250				0,6	B9EVX	7254		BR9EIX	3981
250	250	94 -	B9ES	2611	0,5	B9EVX	7254	202	BR9EIX	3981
GM Star 250	250		B9ES	2611	0,5	B9EVX	7254	202	BR9EIX	3981
GM Star E 250	250		B9ES	2611	0,5	B9EVX	7254	202	BR9EIX	3981
GS 250	250		B9ES	2611	0,5	B9EVX	7254	202	BR9EIX	3981
GSE 250	250	- 05.83	B9ES	2611	0,5	B9EVX	7254	202	BR9EIX	3981
MC 250	250		B9ES	2611	0,5	B9EVX	7254	202	BR9EIX	3981
M 277	277				0,7	B8HVX	2634		BR8HIX	7001
Maicoletta 277	277				0,7	B8HVX	2634		BR8HIX	7001
320	320	94 -	B9ES	2611	0,6	B9EVX	7254	202	BR9EIX	3981
Taifun 350	350				0,7	B8HVX	2634		BR8HIX	7001
Taifun 400	400				0,7	B8HVX	2634		BR8HIX	7001
GS 400	400	01.74 - 05.83	B9ES	2611	0,5	B9EVX	7254	202	BR9EIX	3981
MC 400	400		B9ES	2611	0,5	B9EVX	7254	202	BR9EIX	3981
440	440	94 -	B9ES	2611	0,6	B9EVX	7254	202	BR9EIX	3981
GSE 490	490	-05.83	B9ES	2611	0,5	B9EVX	7254	202	BR9EIX	3981
MC 490	490	-05.83	B9ES	2611	0,5	B9EVX	7254	202	BR9EIX	3981
500	500	94 -	B9ES	2611	0,5	B9EVX	7254	202	BR9EIX	3981
GS 500	500		B9ES	2611	0,5	B9EVX	7254	202	BR9EIX	3981
GS Star 500	500		B9ES	2611	0,5	B9EVX	7254	202	BR9EIX	3981
GS Star E 500	500		B9ES	2611	0,5	B9EVX	7254	202	BR9EIX	3981
MC 500	500		B9ES	2611	0,5	B9EVX	7254	202	BR9EIX	3981

Order  
No.Platin  
Gold-  
Palla-  
diumOrder Quick  
No. No.Order  
No.**MAICO**

685 Gespann	685	94 -			0,6	B10EVX	7335			
-------------	-----	------	--	--	-----	--------	------	--	--	--

**MALAGUTI**

Custon Fox	50		B6HS	4510	0,5	B6HVX	7435	203	BR6HIX	3419
Fifty Top	50		B9ES	2611	0,5	B9EVX	7254	202	BR9EIX	3981
Grizzly RCW4/RCW50/RCX10	50		B6HS	4510	0,5	B6HVX	7435	203	BR6HIX	3419
Grizzly RCX50,Ranocchio	50		B6HS	4510	0,5	B6HVX	7435	203	BR6HIX	3419
RCX 4	50		B8HS	5510	0,5	B8HVX	2634	205	BR8HIX	7001
RCX 10 Automatic	50		B6HS	4510	0,5	B6HVX	7435	203	BR6HIX	3419
RCX 12 Automatic	50		B8HS	5510	0,5	B8HVX	2634	205	BR8HIX	7001
Dune Enduro 75	75		B7ES	1111	0,5	B7EVX	6934			
RST 75 Turismo	75		B7ES	1111	0,5	B7EVX	6934			
Runner 125 Rally	125		B9ES	2611	0,5	B9EVX	7254	202	BR9EIX	3981
Runner 125 YLC	125		B8ES	2411	0,5	B8EVX	7051	201	BR8EIX	5044

**MARS**

M 25	25		B5HS	4210	0,8					
Enduro Dakarino	50		B8HCS	2621	0,6					
M 25 Mini Califo	50		B5HS	4210	0,8					
M 50	50		B5HS	4210	0,8					
MK 50	50		BPR6HSA	4632	0,6	BPR6HVX	2740		BPR6HIX	4085

**MBK**

41	49		B6HS	4510	0,5	B6HVX	7435	203	BR6HIX	3419
50 EV	49		B6HS	4510	0,5	B6HVX	7435	203	BR6HIX	3419
50 EW	49		B6HS	4510	0,5	B6HVX	7435	203	BR6HIX	3419
50 L	49		B6HS	4510	0,5	B6HVX	7435	203	BR6HIX	3419
50 S	49		B6HS	4510	0,5	B6HVX	7435	203	BR6HIX	3419
50 VL	49		B6HS	4510	0,5	B6HVX	7435	203	BR6HIX	3419
50 VS	49		B6HS	4510	0,5	B6HVX	7435	203	BR6HIX	3419
51 New West	49		B6HS	4510	0,5	B6HVX	7435	203	BR6HIX	3419
51 S	49		B6HS	4510	0,5	B6HVX	7435	203	BR6HIX	3419
51 SL	49		B6HS	4510	0,5	B6HVX	7435	203	BR6HIX	3419
51 Super	49		B6HS	4510	0,5	B6HVX	7435	203	BR6HIX	3419
51 Super Special	49		B6HS	4510	0,5	B6HVX	7435	203	BR6HIX	3419
51 V	49		B6HS	4510	0,5	B6HVX	7435	203	BR6HIX	3419
51 VL	49		B6HS	4510	0,5	B6HVX	7435	203	BR6HIX	3419
88	49		B6HS	4510	0,5	B6HVX	7435	203	BR6HIX	3419
88 IP	49		B6HS	4510	0,5	B6HVX	7435	203	BR6HIX	3419
88 IU	49		B6HS	4510	0,5	B6HVX	7435	203	BR6HIX	3419
89	49		B6HS	4510	0,5	B6HVX	7435	203	BR6HIX	3419
Active	49		BPR7HS	6422	0,7	BPR7HVX	2938	215	BPR7HIX	5944
AV 40	49		B6HS	4510	0,5	B6HVX	7435	203	BR6HIX	3419
AV 42	49		B6HS	4510	0,5	B6HVX	7435	203	BR6HIX	3419
AV 44	49		B6HS	4510	0,5	B6HVX	7435	203	BR6HIX	3419
AV 46	49		B6HS	4510	0,5	B6HVX	7435	203	BR6HIX	3419
AV 48	49		B6HS	4510	0,5	B6HVX	7435	203	BR6HIX	3419
AV 56	49		B6HS	4510	0,5	B6HVX	7435	203	BR6HIX	3419
AV 59	49		B6HS	4510	0,5	B6HVX	7435	203	BR6HIX	3419
AV 65	49		B6HS	4510	0,5	B6HVX	7435	203	BR6HIX	3419
AV 68	49		B6HS	4510	0,5	B6HVX	7435	203	BR6HIX	3419
AV 76	49		B6HS	4510	0,5	B6HVX	7435	203	BR6HIX	3419



Order  
No.Gold-  
Palla-  
dium

Platin

Order  
No.Quick  
No.

Iridium

Order  
No.

<b>MBK</b>										
AV 79	49		B6HS	4510	0,5	B6HVX	7435	203	BR6HIX	3419
AV 85	49		B6HS	4510	0,5	B6HVX	7435	203	BR6HIX	3419
AV 88	49		B6HS	4510	0,5	B6HVX	7435	203	BR6HIX	3419
AV 89	49		B6HS	4510	0,5	B6HVX	7435	203	BR6HIX	3419
AV 92	49		B6HS	4510	0,5	B6HVX	7435	203	BR6HIX	3419
AV 98	49		B6HS	4510	0,5	B6HVX	7435	203	BR6HIX	3419
Cady	49		B6HS	4510	0,5	B6HVX	7435	203	BR6HIX	3419
CF	49		B6HS	4510	0,5	B6HVX	7435	203	BR6HIX	3419
Champ	49		B6HS	4510	0,5	B6HVX	7435	203	BR6HIX	3419
Daytona Beach	49		B6HS	4510	0,5	B6HVX	7435	203	BR6HIX	3419
Daytona Cruiser	49		B6HS	4510	0,5	B6HVX	7435	203	BR6HIX	3419
FXK	49		B8ES	2411	0,5	B8EVX	7051	201	BR8EIX	5044
G 40	49		B6HS	4510	0,5	B6HVX	7435	203	BR6HIX	3419
G 50	49		B6HS	4510	0,5	B6HVX	7435	203	BR6HIX	3419
Hobby IV	49		BP6ES	7811	0,5	BP6EVX	5832		BPR6EIX	6637
KW Magnum	49		B6HS	4510	0,5	B6HVX	7435	203	BR6HIX	3419
M 1	49		B6HS	4510	0,5	B6HVX	7435	203	BR6HIX	3419
M 1L	49		B6HS	4510	0,5	B6HVX	7435	203	BR6HIX	3419
M 1P	49		B6HS	4510	0,5	B6HVX	7435	203	BR6HIX	3419
M 1PR	49		B6HS	4510	0,5	B6HVX	7435	203	BR6HIX	3419
M 1PRT	49		B6HS	4510	0,5	B6HVX	7435	203	BR6HIX	3419
M 1PRTS	49		B6HS	4510	0,5	B6HVX	7435	203	BR6HIX	3419
Mobylett	49		B6HS	4510	0,5	B6HVX	7435	203	BR6HIX	3419
N 40	49		B6HS	4510	0,5	B6HVX	7435	203	BR6HIX	3419
N 50	49		B6HS	4510	0,5	B6HVX	7435	203	BR6HIX	3419
Rock	49		B6HS	4510	0,5	B6HVX	7435	203	BR6HIX	3419
SP 50	49		B6HS	4510	0,5	B6HVX	7435	203	BR6HIX	3419
SP 92	49		B6HS	4510	0,5	B6HVX	7435	203	BR6HIX	3419
SP 93	49		B6HS	4510	0,5	B6HVX	7435	203	BR6HIX	3419
SP 94	49		B6HS	4510	0,5	B6HVX	7435	203	BR6HIX	3419
SP 98	49		B6HS	4510	0,5	B6HVX	7435	203	BR6HIX	3419
SP 99	49		B6HS	4510	0,5	B6HVX	7435	203	BR6HIX	3419
Weeky	49		B7HS	5110	0,5	B7HVX	7836	204	BR7HIX	7067
X 1	49		B6HS	4510	0,5	B6HVX	7435	203	BR6HIX	3419
X 1L	49		B6HS	4510	0,5	B6HVX	7435	203	BR6HIX	3419
X 7L	49		B6HS	4510	0,5	B6HVX	7435	203	BR6HIX	3419
X 7S	49		B6HS	4510	0,5	B6HVX	7435	203	BR6HIX	3419
X 7VL	49		B6HS	4510	0,5	B6HVX	7435	203	BR6HIX	3419
X 7VS	49		B6HS	4510	0,5	B6HVX	7435	203	BR6HIX	3419
ZX	49		BR7HS	4122	0,5			211	BR7HIX	7067
151 L	50	01.79 -07.83	B6HS	4510	0,5	B6HVX	7435	203	BR6HIX	3419
151 LB	50	01.79 -07.83	B6HS	4510	0,5	B6HVX	7435	203	BR6HIX	3419
151 LC	50	01.79 -07.83	B6HS	4510	0,5	B6HVX	7435	203	BR6HIX	3419
50 R	50		B7HS	5110	0,5	B7HVX	7836	204	BR7HIX	7067
50 VL	50	01.71 -12.80	B6HS	4510	0,5	B6HVX	7435	203	BR6HIX	3419
50 VLC	50	01.71 -12.80	B6HS	4510	0,5	B6HVX	7435	203	BR6HIX	3419
51 SU	50	01.81 -07.83	B6HS	4510	0,5	B6HVX	7435	203	BR6HIX	3419
89	50	-07.83	B7HS	5110	0,5	B7HVX	7836	204	BR7HIX	7067
93	50		B7HS	5110	0,5	B7HVX	7836	204	BR7HIX	7067
98	50	-07.83	B7HS	5110	0,5	B7HVX	7836	204	BR7HIX	7067
99	50		B7HS	5110	0,5	B7HVX	7836	204	BR7HIX	7067
D50	50		B7HS	5110	0,5	B7HVX	7836	204	BR7HIX	7067

Order  
No.Platin  
Gold-  
Palla-  
diumOrder Quick  
No. No.

Iridium

Order  
No.**MBK**

Monty MB3V	50	01.77 -07.83	BP6ES	7811	0,5	BP6EVX	5832		BPR5EIX	6597
Monty SP3V	50	12.81 -	B6HS	4510	0,5	B6HVX	7435	203	BR6HIX	3419
Monty SP3V	50	-11.81	BP6ES	7811	0,6	BP6EVX	5832		BPR6EIX	6637
SP 94 TT	50		B7HS	5110	0,5	B7HVX	7836	204	BR7HIX	7067
X power	50	03 -	BR9ES	5722	0,8	BR9EVX	1265	208	BR9EIX	3981
D75	75		B8HS	5510	0,5	B8HVX	2634	205	BR8HIX	7001
125 12,7 mm	125		B8HS	5510	0,5	B8HVX	2634	205	BR8HIX	7001
125 19,0 mm	125		B8ES	2411	0,5	B8EVX	7051	201	BR8EIX	5044
250	250		B8ES	2411	0,5	B8EVX	7051	201	BR8EIX	5044
350	350	04.73 -04.79	B8ES	2411	0,5	B8EVX	7051	201	BR8EIX	5044
350 E	350		B8ES	2411	0,5	B8EVX	7051	201	BR8EIX	5044
350 Injection	350		B8ES	2411	0,5	B8EVX	7051	201	BR8EIX	5044

**MECATECNO**

Chic,Funny/2,Cuc	50		B6HS	4510	0,5	B6HVX	7435	203	BR6HIX	3419
Dragon Fly School Boy	50		B6HS	4510	0,5	B6HVX	7435	203	BR6HIX	3419
Grac,Hobby,Huracan	50		B6HS	4510	0,5	B6HVX	7435	203	BR6HIX	3419
Micro GP,Mini 4	50		B6HS	4510	0,5	B6HVX	7435	203	BR6HIX	3419
Racing CR-7	50		B9ES	2611	0,5	B9EVX	7254	202	BR9EIX	3981
Tanga	50		BP6ES	7811	0,5	BP6EVX	5832		BPR6EIX	6637
Dragon Fly,Sky Walker	330		BP5ES	6511	0,5	BP5EVX	5470		BPR5EIX	6597
MR 326 Trial	330		BP5ES	6511	0,5	BP5EVX	5470		BPR5EIX	6597

**MERLIN**

DG1,DG2/T	50		B5HS	4210	0,5					
DG7	125		BP5ES	6511	0,5	BP5EVX	5470		BPR5EIX	6597
DG3 350/Cresta/Trial/GR	350		BP5ES	6511	0,5	BP5EVX	5470		BPR5EIX	6597
DG3 350/FIUS	350		BP5ES	6511	0,5	BP5EVX	5470		BPR5EIX	6597
Nomada 500	500		D8EA	2120	0,5	D8EVX	2850	216	DR8EIX	6681

**METEORIT / A . T . U**

Cruiser 125	125		DR8EA	7162	0,7	DR8EVX	6354		DR8EIX	6681
-------------	-----	--	-------	------	-----	--------	------	--	--------	------

**MIDWEST**

JC50Q-9	50	00 -	CR6HSA	2983	0,7				CR6HIX	7274
JC70Y	70	00 -	CR6HSA	2983	0,7				CR6HIX	7274
JS70Y	70	00 -	CR6HSA	2983	0,7				CR6HIX	7274
JS90Y	90	00 -	CR6HSA	2983	0,7				CR6HIX	7274
JC150Y	150	00 -	DR7EA	7839	0,7					
JS200Y	200	00 -	DR7EA	7839	0,7					

**MINARELLI**

50 Cross	50				0,5	B105EGV	2171			
50 Trial	50				0,5	B95EGV	2145			
C2,E2,G1,V2,C3PK 12,7mm	50		B6HS	4510	0,5	B6HVX	7435	203	BR6HIX	3419
C2,E2,G1,V2,C3PK 19,0mm	50		B6ES	7310	0,5	B6EVX	5136			
C3KS	50		B6ES	7310	0,5	B6EVX	5136			
H3,P4E	50		B6HS	4510	0,5	B6HVX	7435	203	BR6HIX	3419
P 6 Competizione	50				0,5	B95EGV	2145			
P 6 Super	50		B8HS	5510	0,5	B8HVX	2634	205	BR8HIX	7001
P3N,P3A,P3S	50		B6HS	4510	0,5	B6HVX	7435	203	BR6HIX	3419
P4, A, P6, E	50		B6HS	4510	0,5	B6HVX	7435	203	BR6HIX	3419

Order  
No.Platin  
Gold-  
Palla-  
diumOrder Quick  
No. No.

Iridium

Order  
No.**MINARELLI**

P4CS, CSA, P4R	50		B7ES	1111	0,5	B7EVX	6934			
P6CS, CSA, P6R	50		B7ES	1111	0,5	B7EVX	6934			
RV4, A	50		B7ES	1111	0,5	B7EVX	6934			
V1,V1A,V1KS,VIP 12,7mm	50		B6HS	4510	0,5	B6HVX	7435	203	BR6HIX	3419
V1,V1A,V1KS,VIP 19,0mm	50		B6ES	7310	0,5	B6EVX	5136			
V1H,V1HLE,V1L	50		B6HS	4510	0,5	B6HVX	7435	203	BR6HIX	3419
W3 QM	60		B6HS	4510	0,5	B6HVX	7435	203	BR6HIX	3419
Trial	75		B9EG	3530	0,5	B9EGV	5827		BR9EIX	3981
MR 6/80	80				0,5	B11EGV	5831			
P 680	80		B6HS	4510	0,5	B6HVX	7435	203	BR6HIX	3419
125 Cross	125				0,5	B95EGV	2145			
125 Regolarità	125				0,5	B95EGV	2145			
125 YPVS (Yamaha)	125		B8ES	2411	0,5	B8EVX	7051	201	BR8EIX	5044
125/5	125		B8ES	2411	0,5	B8EVX	7051	201	BR8EIX	5044
125/5 Cross	125				0,5	B10EGV	5927			
125/5 Regolarità	125				0,5	B10EGV	5927			

**MINSK**

MMB3-3.112	7,3kW	125		BP7HS	5111	0,7	BP7HVX	7468		BPR7HIX	5944
MMB3-3.113	7,3kW	125		BP7HS	5111	0,7	BP7HVX	7468		BPR7HIX	5944
MMB3-3.1131	7,3kW	125		BP7HS	5111	0,7	BP7HVX	7468		BPR7HIX	5944
MMB3-3.11311	7,3kW	125		BP7HS	5111	0,7	BP7HVX	7468		BPR7HIX	5944
Mototeleschka C-3.901	7,3kW	125		BP7HS	5111	0,7	BP7HVX	7468		BPR7HIX	5944

**MONDIAL**

Cross Spezial		50		B7HS	5110	0,5	B7HVX	7836	204	BR7HIX	7067
Mondialino		50		B7HS	5110	0,5	B7HVX	7836	204	BR7HIX	7067
Radial		50		B8HS	5510	0,5	B8HVX	2634	205	BR8HIX	7001
Regolarita		50		B8HS	5510	0,5	B8HVX	2634	205	BR8HIX	7001
Spezial V4 Record		50		B7ES	1111	0,5	B7EVX	6934			
Touring		50		B8HS	5510	0,5	B8HVX	2634	205	BR8HIX	7001
Tourismo		50		B7HS	5110	0,5	B7HVX	7836	204	BR7HIX	7067
Cross Radial v6		125		B7HS	5110	0,5	B7HVX	7836	204	BR7HIX	7067
175 SS		175		B9HS	5810	0,5	B9HVX	2254			
Piega VTR 1000 SP		1000	03 -							FR9BI-11	4709

**MONTESA**

Brio,Cirlo,Fura,Mini Cota		50		B7HS	5110	0,5	B7HVX	7836	204	BR7HIX	7067
Cota 25A/25C/49,Mini Mont.		50		B7HS	5110	0,5	B7HVX	7836	204	BR7HIX	7067
Scorpion 50R		50		B7HS	5110	0,5	B7HVX	7836	204	BR7HIX	7067
Cota 74 /74T /80		75		B7ES	1111	0,5	B7EVX	6934			
Crono 75		75		B7ES	1111	0,5	B7EVX	6934			
Enduro 75 H6 /H7/ L		75		B7ES	1111	0,5	B7EVX	6934			
Cota 123/C/T, Cota 125		123		B8ES	2411	0,5	B8EVX	7051	201	BR8EIX	5044
MH 123		123		BPR7ES	2023	0,6	BPR7EVX	5565		BPR7EIX	4055
Cappra 125 MX		125		B8HS	5510	0,5	B8HVX	2634	205	BR8HIX	7001
Cappra 125 VA/VB/VE/VF		125		B10ES	7928	0,5	B10EVX	7335		BR10EIX	6801
Crono 125D		125		B8ES	2411	0,5	B8EVX	7051	201	BR8EIX	5044
Enduro 125 H6/H7/L		125		B8ES	2411	0,5	B8EVX	7051	201	BR8EIX	5044
Cota 172/200		175		B7ES	1111	0,5	B7EVX	6934			
Impala /2/Sport		175		B7HS	5110	0,5	B7HVX	7836	204	BR7HIX	7067
Impala 175 Comando/Turismo		175		B6HS	4510	0,5	B6HVX	7435	203	BR6HIX	3419

Order  
No.Platin  
Gold-  
Palla-  
diumOrder Quick  
No. No.Order  
No.**MONTESA**

Kenya 175, Texas 175	175		B6HS	4510	0,5	B6HVX	7435	203	BR6HIX	3419
MH 200	200		BPR7ES	2023	0,6	BPR7EVX	5565		BPR7EIX	4055
Cappra VA/B/E/F/G/R	250		B9ES	2611	0,5	B9EVX	7254	202	BR9EIX	3981
Cappra MX	250		B8HS	5510	0,6	B8HVX	2634	205	BR8HIX	7001
Cappra 250 /GP/MX	250		B8HS	5510	0,5	B8HVX	2634	205	BR8HIX	7001
Cappra 250 CA/VB/VE	250		B9ES	2611	0,5	B9EVX	7254	202	BR9EIX	3981
Cappra 250 VF/VG/VR	250		B9ES	2611	0,5	B9EVX	7254	202	BR9EIX	3981
Cota 242 /304 /307	250		BP7ES	2412	0,5	BP7EVX	7270	206	BPR7EIX	4055
Cota 247 /C/T	250		B8HS	5510	0,5	B8HVX	2634	205	BR8HIX	7001
Cota 248	250		BP5ES	6511	0,5	BP5EVX	5470		BPR5EIX	6597
Cota 4RT	250	05 -	CR6EH-9	2688	0,6					
Enduro 250 H6	250		B8ES	2411	0,5	B8EVX	7051	201	BR8EIX	5044
Enduro 250 H7	250		B10EG	3630	0,5	B10EGV	5927			
Impala	250		B8HS	5510	0,6	B8HVX	2634	205	BR8HIX	7001
Impala 250 King	250		B8HS	5510	0,5	B8HVX	2634	205	BR8HIX	7001
Impala 250 Scorpion/Sport	250		B8HS	5510	0,5	B8HVX	2634	205	BR8HIX	7001
K.Scorpion	250		B8HS	5510	0,6	B8HVX	2634	205	BR8HIX	7001
Enduro Rapita 250 Automix	250		B8ES	2411	0,5	B8EVX	7051	201	BR8EIX	5044
Cota 309	260		BPR7ES	2023	0,6	BPR7EVX	5565		BPR7EIX	4055
Cota 310/Evasion	260		BPR7ES	2023	0,6	BPR7EVX	5565		BPR7EIX	4055
Cota 311	260		BPR5ES	7422	0,6	BPR5EVX	4875		BPR5EIX	6597
Cota 348,Trial	310		BP5ES	6511	0,5	BP5EVX	5470		BPR5EIX	6597
315R	315	97 -	BR6ES	4922	0,8					
Cota 330,Trial	330		BP5ES	6511	0,5	BP5EVX	5470		BPR5EIX	6597
MH 349	349		BPR5ES	7422	0,6	BPR5EVX	4875		BPR5EIX	6597
Cota 335/335E/349/349T/350	350		BP5ES	6511	0,5	BP5EVX	5470		BPR5EIX	6597
Crono 350	350		B7ES	1111	0,5	B7EVX	6934			
Enduro 360 H6/H7/H7S/L	350		B7ES	1111	0,5	B7EVX	6934			
Cappra GP,Cappra 360VA/VB	360		B8ES	2411	0,5	B8EVX	7051	201	BR8EIX	5044
Cappra 414VE/VF/VG	410		B8ES	2411	0,5	B8EVX	7051	201	BR8EIX	5044

**MOTO GEROSA**

Cross Corsa Minarelli	50		B10ES	7928	0,5	B10EVX	7335		BR10EIX	6801
Mini Pieghevole	50		B6HS	4510	0,6	B6HVX	7435	203	BR6HIX	3419
Monotrave L 4M	50		B6ES	7310	0,7	B6EVX	5136			
Motocarro	50		B6HS	4510	0,6	B6HVX	7435	203	BR6HIX	3419
Pulce Bimbo	50		B6HS	4510	0,6	B6HVX	7435	203	BR6HIX	3419
Pulce Junior 4M	50		B6ES	7310	0,7	B6EVX	5136			
Regolarita Corsa Zündapp / 6M	50		B8ES	2411	0,5	B8EVX	7051	201	BR8EIX	5044
V1 Export	50		B6HS	4510	0,6	B6HVX	7435	203	BR6HIX	3419
V1 Monotrave	50		B6HS	4510	0,6	B6HVX	7435	203	BR6HIX	3419
V110	50		B6HS	4510	0,6	B6HVX	7435	203	BR6HIX	3419

**MOTO GUZZI**

Cross 50	50		B5HS	4210	0,5					
Dingo 3M	50		B6HS	4510	0,5	B6HVX	7435	203	BR6HIX	3419
Dingo MM	50		B6HS	4510	0,5	B6HVX	7435	203	BR6HIX	3419
Furghino	50		B6HS	4510	0,5	B6HVX	7435	203	BR6HIX	3419
Magnum	50		B6ES	7310	0,5	B6EVX	5136			
Nibbio	50		B7ES	1111	0,5	B7EVX	6934			
Trotter	50	10.70 -12.73	B6HS	4510	0,5	B6HVX	7435	203	BR6HIX	3419
125 2C4T	125	10.79 -12.83	C8HSA	6821	0,5	C8HVX	2672		CR8HIX	7669

Order  
No.Platin  
Gold-  
Palla-  
diumOrder Quick  
No. No.

Iridium

Order  
No.**MOTO GUZZI**

125 TT	125	07.85 -12.87	B9ES	2611	0,5	B9EVX	7254	202	BR9EIX	3981
125 Custom	125	01.86 -	B9ES	2611	0,5	B9EVX	7254	202	BR9EIX	3981
Turismo	125	01.74 -12.79	B8ES	2411	0,5	B8EVX	7051	201	BR8EIX	5044
250 FD	250	74 - 76	D8EA	2120	0,5	D8EVX	2850	216	DR8EIX	6681
250 TS	250	01.74 -07.80	B8ES	2411	0,5	B8EVX	7051	201	BR8EIX	5044
254	250	78 - 80	C8HSA	6821	0,5	C8HVX	2672		CR8HIX	7669
350 GTS	350	04.74 -07.80	D8EA	2120	0,5	D8EVX	2850	216	DR8EIX	6681
350 NTX	350	10.86 -	BP8ES	2912	0,6	BP8EVX	2671			
V 35	350	06.77 -	BP7ES	2412	0,6	BP7EVX	7270	206	BPR7EIX	4055
V 35 Florida	350	05.86 -	BP8ES	2912	0,6	BP8EVX	2671			
V 35 II	350	12.80 -01.87	B7ES	1111	0,5	B7EVX	6934			
V 35 III	350	07.85 -	BP8ES	2912	0,5	BP8EVX	2671			
V 35 Imola	350	11.79 -01.87	B7ES	1111	0,5	B7EVX	6934			
V 35 Imola II	350	79 - 86	C8HSA	6821	0,5	C8HVX	2672		CR8HIX	7669
V 35 TT	350	06.84 -12.87	BPR7ES	2023	0,5	BPR7EVX	5565		BPR7EIX	4055
V 350 Nevada	350	92 -	B8ES	2411	0,6	B8EVX	7051	201	BR8EIX	5044
400 GTS	400	05.75 -07.80	DP8EA-9	5829	0,9	DPR8EVX-9	2202		DPR8EIX-9	2202
V 40 Imola	400		BP8ES	2912	0,6	BP8EVX	2671			
Monza 500	500	01.81 -01.87	BP8ES	2912	0,6	BP8EVX	2671			
V 50	500	06.77 -	BP7ES	2412	0,6	BP7EVX	7270	206	BPR7EIX	4055
V 50 Custom	500	78 - 80	BP7ES	2412	0,6	BP7EVX	7270	206	BPR7EIX	4055
V 50 II	500	11.79 -12.81	BP7ES	2412	0,5	BP7EVX	7270	206	BPR7EIX	4055
V 50 III	500	01.81 -01.87	BP8ES	2912	0,5	BP8EVX	2671			
V 50 Monza II	500	06.84 -12.87	C8HSA	6821	0,5	C8HVX	2672		CR8HIX	7669
V 65	650	87 -	BCPR6ES	2330	0,5					
V 65	650	- 86	BP8ES	2912	0,6	BP8EVX	2671			
V 65 Florida	650	92 -	B8ES	2411	0,6	B8EVX	7051	201	BR8EIX	5044
V 65 Florida	650	- 86	BP8ES	2912	0,6	BP8EVX	2671			
V 65 Lario	650	- 86	C8HSA	6821	0,5	C8HVX	2672		CR8HIX	7669
V 65 NTX	650	- 89	BP8ES	2912	0,6	BP8EVX	2671			
V 65 NTX	650	90 - 92	B8ES	2411	0,6	B8EVX	7051	201	BR8EIX	5044
V 65 Polizia NT	650		B8ES	2411	0,6	B8EVX	7051	201	BR8EIX	5044
V 65 SP	650	- 86	BP8ES	2912	0,6	BP8EVX	2671			
V 65 TT	650	- 86	BP8ES	2912	0,6	BP8EVX	2671			
V 7 Sport / Spezial	700		BP6ES	7811	0,5	BP6EVX	5832		BPR6EIX	6637
750 S	750	- 74	BP6ES	7811	0,5	BP6EVX	5832		BPR6EIX	6637
750 SP	750	92 -	B8ES	2411	0,6	B8EVX	7051	201	BR8EIX	5044
750 Targa	750	92 -	B8ES	2411	0,6	B8EVX	7051	201	BR8EIX	5044
Breva Naked	750	03 -	BR8ES	5422	0,6	BR8EVX	1262	207	BR8EIX	5044
Breva Touring	750	06 -	BR8ES	5422	0,6	BR8EVX	1262	207	BR8EIX	5044
Nevada Classic 750 ie	750	04 -	BR8ES	5422	0,6	BR8EVX	1262	207	BR8EIX	5044
V 75 Nevada	750	92 -	B8ES	2411	0,6	B8EVX	7051	201	BR8EIX	5044
V 75, Duna	750		C8HSA	6821	0,5	C8HVX	2672		CR8HIX	7669
V 750 NTX	750	92 -	B8ES	2411	0,6	B8EVX	7051	201	BR8EIX	5044
V 750 Polizia NT	750	92 -	B8ES	2411	0,6	B8EVX	7051	201	BR8EIX	5044
850 California	850	12.75 -12.81	BP6ES	7811	0,6	BP6EVX	5832		BPR6EIX	6637
850 Le Mans II / III	850	01.78 -12.81	BP6ES	7811	0,6	BP6EVX	5832		BPR6EIX	6637
850 T4	850	07.80 -12.83	BP6ES	7811	0,6	BP6EVX	5832		BPR6EIX	6637
850 T5	850	06.83 -12.87	BP6ES	7811	0,6	BP6EVX	5832		BPR6EIX	6637
850 TS 5	850	82 - 84	BP6ES	7811	0,6	BP6EVX	5832		BPR6EIX	6637
Breva 850	877	06 -	BPR6ES+	7822+	0,6					
(Twin Spark) BPR6ES out, PMR8B in)			PMR8B	6378						

Order  
No.Platin  
Gold-  
Palla-  
diumOrder  
No.Quick  
No.

Iridium

Order  
No.**MOTO GUZZI**

Griso 850 (Twin Spark) BPR6ES out, PMR8B in)	877	06 -	BPR6ES+ PMR8B	7822+ 6378	0,6					
1000	1000		BP6ES	7811	0,6	BP6EVX	5832		BPR6EIX	6637
1000 GT	1000	88 -	BP6ES	7811	0,6	BP6EVX	5832		BPR6EIX	6637
1000 Le Mans	1000	90 -	BP7ES	2412	0,6	BP7EVX	7270	206	BPR7EIX	4055
1000 Le Mans IV	1000	01.85 - 89	BP8ES	2912	0,6	BP8EVX	2671			
1000 S	1000	89 -	BP7ES	2412	0,6	BP7EVX	7270	206	BPR7EIX	4055
1000 SP III	1000	88 - 92	BP6ES	7811	0,6	BP6EVX	5832		BPR6EIX	6637
California I.E.	1000	91 -	BP7ES	2412	0,6	BP7EVX	7270	206	BPR7EIX	4055
California III	1000	88 -	BP6ES	7811	0,6	BP6EVX	5832		BPR6EIX	6637
Daytona 1000	1000	92 -	D9EA	2420	0,6	D9EVX	2834		DR9EIX	4772
Quota 1000	1000	92 -	BP7ES	2412	0,6	BP7EVX	7270	206	BPR7EIX	4055
T 5 Polizia	1000	92 -	BP6ES	7811	0,6	BP6EVX	5832		BPR6EIX	6637
V 10 Centauro	1000	96 -	DR9EA	3437	0,7	DR9EVX	6361	219	DR9EIX	4772
Breva 1100 (Twin Spark) BPR6ES out, PMR8B in)	1100	06 -	BPR6ES+ PMR8B	7822+ 6378	0,6					
California 1100 KC	1100	94 -	BPR6ES	7822	0,6	BPR6EVX	6764		BPR6EIX	6637
California 1100 KD	1100	94 -	BPR6ES	7822	0,6	BPR6EVX	6764		BPR6EIX	6637
California Aluminium	1100	03 -	BPR6ES	7822	0,6	BPR6EVX	6764		BPR6EIX	6637
California EV (KD)	1100	97 -	BPR6ES	7822	0,6	BPR6EVX	6764		BPR6EIX	6637
California Jackal (KD)	1100	99 -	BPR6ES	7822	0,6	BPR6EVX	6764		BPR6EIX	6637
California Special	1100	02 -	BPR6ES	7822	0,6	BPR6EVX	6764		BPR6EIX	6637
California Special Sport (KD) 54kW	1100	02 -	BPR6ES	7822	0,6	BPR6EVX	6764		BPR6EIX	6637
California Stone (KD) 54kW	1100		BPR6ES	7822	0,6	BPR6EVX	6764		BPR6EIX	6637
California Titanium	1100	03 -	BPR6ES	7822	0,6	BPR6EVX	6764		BPR6EIX	6637
Daytona RS (KL)	1100	96 -	DR8EA	7162	0,7	DR8EVX	6354		DR8EIX	6681
Griso 1100 (Twin Spark) BPR6ES out, PMR8B in)	1100	05 -	BPR6ES+ PMR8B	7822+ 6378	0,6					
Quota 1100 (KM)	1100	06.98 -	BPR6ES	7822	0,6	BPR6EVX	6764		BPR6EIX	6637
Sport 1100i	1100	96 -	BPR6ES	7822	0,6	BPR6EVX	6764		BPR6EIX	6637
1100 Sport (KF) (Injec.)(Iniezione)	1100	96 -	BPR6ES	7822	0,6	BPR6EVX	6764		BPR6EIX	6637
Sport	1100	95 -	BPR6ES	7822	0,6	BPR6EVX	6764		BPR6EIX	6637
Stone Touring	1100	03 -	BPR6ES	7822	0,6	BPR6EVX	6764		BPR6EIX	6637
V 11 Scura	1100	03 -	BPR6ES	7822	0,6	BPR6EVX	6764		BPR6EIX	6637
V 11 Le Mans Nero Corsa ( 67kW)	1100	04 -	BPR6ES	7822	0,6	BPR6EVX	6764		BPR6EIX	6637
V 11 Sport ( KS)	1100	99 -	BPR6ES	7822	0,6	BPR6EVX	6764		BPR6EIX	6637
V 11 Naked	1100	03 -	BPR6ES	7822	0,6	BPR6EVX	6764		BPR6EIX	6637
V 11 Le Mans ( KS)	1100		BPR6ES	7822	0,6	BPR6EVX	6764		BPR6EIX	6637
V 11 Rosso Mandello ( KR)	1100	99 -	BPR6ES	7822	0,6	BPR6EVX	6764		BPR6EIX	6637
GT TwinSpark BPR6ES out, PMR8B in)	1200	06 -	BPR6ES+ PMR8B	7822+ 6378	0,6					
Norge 1200 (Twin Spark) BPR6ES out, PMR8B in)	1200	06 -	BPR6ES+ PMR8B	7822+ 6378	0,6					
MGS 01	1250	04 -							DCPR9EIX	2316

**MOTO KOSMOS**

RV100	100		B9ES	2611	0,5	B9EVX	7254	202	BR9EIX	3981
CV125	125		B8ES	2411	0,5	B8EVX	7051	201	BR8EIX	5044
CVA125	125		B9ES	2611	0,5	B9EVX	7254	202	BR9EIX	3981
KSR125	125		B9ES	2611	0,5	B9EVX	7254	202	BR9EIX	3981
RV125	125		B8ES	2411	0,5	B8EVX	7051	201	BR8EIX	5044
CV250	250		B8ES	2411	0,5	B8EVX	7051	201	BR8EIX	5044

Order  
No.Platin  
Gold-  
Palla-  
diumOrder Quick  
No. No.

Iridium

Order  
No.**MOTO KOSMOS**

KSR250	250		B9ES	2611	0,5	B9EVX	7254	202	BR9EIX	3981
RV250	250		B8ES	2411	0,5	B8EVX	7051	201	BR8EIX	5044
RV350	350		B8ES	2411	0,5	B8EVX	7051	201	BR8EIX	5044
CV500	500		B8ES	2411	0,5	B8EVX	7051	201	BR8EIX	5044

**MOTO MORINI**

350 Excalibur	350	92 -	BP7ES	2412	0,5	BP7EVX	7270	206	BPR7EIX	4055
400 Dart	400	91 -	BP8ES	2912	0,5	BP8EVX	2671			
501 Excalibur	500	91 -	BP8ES	2912	0,5	BP8EVX	2671			
501 Excalibur	501	92 -	BP7ES	2412	0,5	BP7EVX	7270	206	BPR7EIX	4055
Corsaro 1200	1200	05 -	CR9E	6263	0,7	CR9EVX	5943	227	CR9EIX	3521

**MOTOR HISPANIA**

Cangurito Cross, MH	50		B6HS	4510	0,5	B6HVX	7435	203	BR6HIX	3419
Cross/MH/MH49,Sport 49	50		B6HS	4510	0,5	B6HVX	7435	203	BR6HIX	3419
Feria,Jabato,50SL	50		B6ES	7310	0,5	B6EVX	5136			
Furia 4v	50		BR9ES	5722	0,8	BR9EVX	1265	208	BR9EIX	3981
Furia 6v Cross / Super.	50		BR9ES	5722	0,8	BR9EVX	1265	208	BR9EIX	3981
GT 81, MH 80	50		B6HS	4510	0,5	B6HVX	7435	203	BR6HIX	3419
M 80 Automatico	50		B6ES	7310	0,5	B6EVX	5136			
Minicross	50		B7HS	5110	0,5	B7HVX	7836	204	BR7HIX	7067
Racing RX	50		BR9ES	5722	0,8	BR9EVX	1265	208	BR9EIX	3981
Style	50		B7HS	5110	0,5	B7HVX	7836	204	BR7HIX	7067

**MOTOR TEK**

MT 50	50	05 -	BR8HSA	5539	0,5	BR8HVX	6265		BR8HIX	7001
-------	----	------	--------	------	-----	--------	------	--	--------	------

**MOTO-SPEZIAL**

Bassa-Lunga	1100	99 -	BP6ES	7811	0,8	BP6EVX	5832		BPR6EIX	6637
Sportiva 1100i	1100	99 -	BP6ES	7811	0,8	BP6EVX	5832		BPR6EIX	6637

**MOTOTECHNIKA**

Motovelosiped	45	89 -	BP6HS	4511	0,7	BP6HVX	4635		BPR6HIX	4085
Karpati	50		BP6HS	4511	0,6	BP6HVX	4635		BPR6HIX	4085
Mokick	50		BP7HS	5111	0,7	BP7HVX	7468		BPR7HIX	5944
Riga	50		BP6HS	4511	0,6	BP6HVX	4635		BPR6HIX	4085
Tricycle "ZID-50"	50	98 -	BP7HS	5111	0,6	BP7HVX	7468		BPR7HIX	5944
Turist	50		BP6HS	4511	0,6	BP6HVX	4635		BPR6HIX	4085
Veachowina	50		BP6HS	4511	0,6	BP6HVX	4635		BPR6HIX	4085
Veterok	50		BP6HS	4511	0,6	BP6HVX	4635		BPR6HIX	4085

**MTV**

50 Cross/ Sport	50		BP5ES	6511	0,5	BP5EVX	5470		BPR5EIX	6597
-----------------	----	--	-------	------	-----	--------	------	--	---------	------

**MÜNCH**

Mammut 1000 TTS	1000	-12.82	BP8ES	2912	0,5	BP8EVX	2671			
4-1200 TS/TTS-E	1200	-12.82	BP8ES	2912	0,5	BP8EVX	2671			
Mammut 1200 TS	1200	-12.82	BP8ES	2912	0,5	BP8EVX	2671			

**MV AGUSTA**

350 B GT/S/Scrambler	350		B8ES	2411	0,5	B8EVX	7051	201	BR8EIX	5044
350 BE GT(216)	350		B8ES	2411	0,5	B8EVX	7051	201	BR8EIX	5044

Order  
No.Platin  
Gold-  
Palla-  
diumOrder Quick  
No. No.Order  
No.**MV AGUSTA**

350 BE GT/S/Scrambler	350		B8ES	2411	0,5	B8EVX	7051	201	BR8EIX	5044
350 BES (216)	350		B8ES	2411	0,5	B8EVX	7051	201	BR8EIX	5044
350 Sport	350	-12.80	B8ES	2411	0,5	B8EVX	7051	201	BR8EIX	5044
GT Electronique	350		B8ES	2411	0,5	B8EVX	7051	201	BR8EIX	5044
S Electronique	350		B8ES	2411	0,5	B8EVX	7051	201	BR8EIX	5044
Scrambler Electronique	350		B8ES	2411	0,5	B8EVX	7051	201	BR8EIX	5044
199,4C6	600		B8ES	2411	0,5	B8EVX	7051	201	BR8EIX	5044
4C75S/GT, 750GT/S/SS	750		B8ES	2411	0,5	B8EVX	7051	201	BR8EIX	5044
750 S American	750		B7ES	1111	0,5	B7EVX	6934			
F4 Brutale (oro) 93kW	750	99 -	CR9EKB	2305	0,7				CR9EIX	3521
F4 Brutale S	750	02 -	CR9EKB	2305	0,7				CR9EIX	3521
F4 Senna 103KW	750	99 -	CR9EKB	2305	0,7				CR9EIX	3521
F4 Oro --> Fgst.300	750	99 -	CR9EKB	2305	0,7				CR9EIX	3521
F4 S SPR 103KW	750	99 -	CR9EKB	2305	0,7				CR9EIX	3521
800 S	800	-06.80	B8ES	2411	0,5	B8EVX	7051	201	BR8EIX	5044
900 S	900	-06.80	B8ES	2411	0,5	B8EVX	7051	201	BR8EIX	5044
F4 Brutale 910 R	910	06 -	CR9EB	6955	0,7				CR9EIX	3521
F4 Brutale 910	910	05 -	CR9EB	6955	0,7				CR9EIX	3521
F4 1000 S	1000	04 -	R0045j-10	7400	0,7					
F4 1000 Tamburini	1000	04 -	R0045J-10	7400						
F 4 1000 Senna	1000	06 -	R0045J-10	7400						

**MZ**

125 Fun X	125	01 -	CR8E	1275	0,7	CR8EVX	6487	226	CR8EIX	4218
125 Fun X	125	03 -	CR8E	1275	0,6	CR8EVX	6487	226	CR8EIX	4218
125 SM	125	01 -	CR8E	1275	0,7	CR8EVX	6487	226	CR8EIX	4218
125 SX	125	01 -	CR8E	1275	0,7	CR8EVX	6487	226	CR8EIX	4218
125 Younster Cup	125	03 -	CR8E	1275	0,6	CR8EVX	6487	226	CR8EIX	4218
Cup Replica 125 SM	125	05 -	CR8E	1275	0,6	CR8EVX	6487	226	CR8EIX	4218
Gangata 125 SM	125	05 -	CR8E	1275	0,6	CR8EVX	6487	226	CR8EIX	4218
RT 125	125	00 -	CR8E	1275	0,6	CR8EVX	6487	226	CR8EIX	4218
RT 125 Classic	125	03 -	CR8E	1275	0,6	CR8EVX	6487	226	CR8EIX	4218
RT 125 SM	125	00 -	CR8E	1275	0,6	CR8EVX	6487	226	CR8EIX	4218
Saxon Roadstar 7kW	125		B8HS	5510	0,6	B8HVX	2634	205	BR8HIX	7001
Saxon Sportstar 7/11kW	125		B8HS	5510	0,6	B8HVX	2634	205	BR8HIX	7001
Striker 125 RT	125	05 -	CR8E	1275	0,6	CR8EVX	6487	226	CR8EIX	4218
Supermoto 125	125	05 -	CR8E	1275	0,6	CR8EVX	6487	226	CR8EIX	4218
Twin Colour 125 SM	125	06 -	CR8E	1275	0,6	CR8EVX	6487	226	CR8EIX	4218
Saxon Roadstar 9kW	150		B8HS	5510	0,6	B8HVX	2634	205	BR8HIX	7001
Saxon Sportstar 9kW	150		B8HS	5510	0,6	B8HVX	2634	205	BR8HIX	7001
ETZ Classic 13/15kW	251		B8HS	5510	0,6	B8HVX	2634	205	BR8HIX	7001
Saxon 251 Fun 13/15kW	251		B8HS	5510	0,6	B8HVX	2634	205	BR8HIX	7001
Saxon 251 Tour 13/15kW	251		B8HS	5510	0,6	B8HVX	2634	205	BR8HIX	7001
ETZ 301 Classic 17kW	301		B8HS	5510	0,6	B8HVX	2634	205	BR8HIX	7001
Saxon 301 Fun 17kW	301		B8HS	5510	0,6	B8HVX	2634	205	BR8HIX	7001
Saxon 301 Tour 17kW	301		B8HS	5510	0,6	B8HVX	2634	205	BR8HIX	7001
Saxon 500 Country 25kW	500		D8EA	2120	0,7	D8EVX	2850	216	DR8EIX	6681
Saxon 500 Fun 20/25kW	500		D8EA	2120	0,7	D8EVX	2850	216	DR8EIX	6681
Saxon 500 Funkkrad 20/25kW	500		D8EA	2120	0,7	D8EVX	2850	216	DR8EIX	6681
Saxon 500 Tour 20/25kW	500		D8EA	2120	0,7	D8EVX	2850	216	DR8EIX	6681
Saxon 500 Voyager 20/25kW	500		D8EA	2120	0,7	D8EVX	2850	216	DR8EIX	6681
Silver Star Classic 500 20kW	500		D8EA	2120	0,7	D8EVX	2850	216	DR8EIX	6681



Order  
No.Platin  
Gold-  
Palla-  
diumOrder Quick  
No. No.

Iridium

Order  
No.**MZ**

Silver Star Classic 500 25kW	500		D8EA	2120	0,7	D8EVX	2850	216	DR8EIX	6681
Silver Star Gespann 500 25kW	500	95 -	D8EA	2120	0,7	D8EVX	2850	216	DR8EIX	6681
Baghira	660	97 -	DPR9EA-9	5329	0,9	DPR9EVX-9	3854	222	DPR9EIX-9	5545
Baghira Black Panther (4NN)	660	99 -	DPR9EA-9	5329	0,9	DPR9EVX-9	3854	222	DPR9EIX-9	5545
Baghira Black Panther HR	660	00 -	DPR9EA-9	5329	0,9	DPR9EVX-9	3854	222	DPR9EIX-9	5545
Baghira Forest	660	99 -	DPR9EA-9	5329	0,9	DPR9EVX-9	3854	222	DPR9EIX-9	5545
Baghira HR	660	99 -	DPR9EA-9	5329	0,9	DPR9EVX-9	3854	222	DPR9EIX-9	5545
Baghira Street Moto (4NN)	660	99 -	DPR9EA-9	5329	0,9	DPR9EVX-9	3854	222	DPR9EIX-9	5545
Baghira Street Moto HR	660	00 -	DPR9EA-9	5329	0,9	DPR9EVX-9	3854	222	DPR9EIX-9	5545
Mastiff	660	97 -	DPR9EA-9	5329	0,9	DPR9EVX-9	3854	222	DPR9EIX-9	5545
Replica 660	660	02.95 -	DPR9EA-9	5329	0,9	DPR9EVX-9	3854	222	DPR9EIX-9	5545
Skorpion Cup (4NN)	660	96 -	DPR9EA-9	5329	0,9	DPR9EVX-9	3854	222	DPR9EIX-9	5545
Skorpion Replica	660	02.95 -	DPR9EA-9	5329	0,9	DPR9EVX-9	3854	222	DPR9EIX-9	5545
Skorpion Sport	660	94 -	DPR9EA-9	5329	0,9	DPR9EVX-9	3854	222	DPR9EIX-9	5545
Skorpion Tour	660	94 -	DPR9EA-9	5329	0,9	DPR9EVX-9	3854	222	DPR9EIX-9	5545
Skorpion Traveller	660	96 -	DPR9EA-9	5329	0,9	DPR9EVX-9	3854	222	DPR9EIX-9	5545
Supermoto 660	660	05 -	DPR9EA-9	5329	0,9	DPR9EVX-9	3854	222	DPR9EIX-9	5545
1000 S	1000	04 -	BCPR6ET	2197	0,8					
1000 SF	1000	05 -	BCPR6ET	2197	0,8					
1000 ST	1000	05 -	BCPR6ET	2197	0,8					

**MZ (TR)**

ETZ Standard OR	125	01.91 -	B8HS	5510	0,6	B8HVX	2634	205	BR8HIX	7001
ETZ Standard	125	01.91 -	B8HS	5510	0,6	B8HVX	2634	205	BR8HIX	7001
Saxon Tour 251	125	01.91 -	B8HS	5510	0,6	B8HVX	2634	205	BR8HIX	7001
TS 125	125	01.75 -12.85	B8HS	5510	0,6	B8HVX	2634	205	BR8HIX	7001
ETZ 150	150	01.84 -12.90	B8HS	5510	0,6	B8HVX	2634	205	BR8HIX	7001
TS 150	150	01.75 -12.85	B8HS	5510	0,6	B8HVX	2634	205	BR8HIX	7001
TS 250	250	01.75 -12.85	B8HS	5510	0,6	B8HVX	2634	205	BR8HIX	7001

**NORTON**

Atlas			BP8ES	2912	0,6	BP8EVX	2671			
Commander			C8E	7471	0,6	CR8EVX	6487		CR8EIX	4218
Commando			BP7ES	2412	0,6	BP7EVX	7270	206	BPR7EIX	4055
F 1			C8E	7471	0,6	CR8EVX	6487		CR8EIX	4218
C 652 SM engine F650	650	99 -	D8EA	2120	0,6	D8EVX	2850	216	DR8EIX	6681

**NSU**

Konsul 1			B7HS	5110	0,5	B7HVX	7836	204	BR7HIX	7067
Konsul 2			B7HS	5110	0,5	B7HVX	7836	204	BR7HIX	7067
Quick 50 4,3PS	50	04.62 -	B6HS	4510	0,5	B6HVX	7435	203	BR6HIX	3419
Quickly S 23 1,2+1,7PS	50	01.62 -	B6HS	4510	0,5	B6HVX	7435	203	BR6HIX	3419
Quickly N / N23 1,2+1,7PS	50	01.63 -	B6HS	4510	0,5	B6HVX	7435	203	BR6HIX	3419
Quickly S 1,2+1,7PS	50	-12.63	B6HS	4510	0,5	B6HVX	7435	203	BR6HIX	3419
Quickly T 1,2+1,7PS	50	-12.64	B6HS	4510	0,5	B6HVX	7435	203	BR6HIX	3419
Quickly F23 1,2+1,7PS	50	01.63 -	B6HS	4510	0,5	B6HVX	7435	203	BR6HIX	3419
Quickly S / 2 1,2+1,7PS	50	01.62 -	B6HS	4510	0,5	B6HVX	7435	203	BR6HIX	3419
Quickly TTK 1,2+1,7PS	50	01.62 -	B6HS	4510	0,5	B6HVX	7435	203	BR6HIX	3419
Quickly TT 1,2+1,7PS	50	-12.61	B6HS	4510	0,5	B6HVX	7435	203	BR6HIX	3419
125 ZDB	125		B7HS	5110	0,5	B7HVX	7836	204	BR7HIX	7067
Fox 2Takt	125		B8HS	5510	0,5	B8HVX	2634	205	BR8HIX	7001
Fox 4Takt	125		B7HS	5110	0,5	B7HVX	7836	204	BR7HIX	7067

Order  
No.Platin  
Gold-  
Palla-  
diumOrder  
No.Quick  
No.

Iridium

Order  
No.**NSU**

Super Fox	125		B8HS	5510	0,5	B8HVX	2634	205	BR8HIX	7001
Prima 3 7,4PS	150	01.58 -12.61	B6HS	4510	0,5	B6HVX	7435	203	BR6HIX	3419
Prima 3K 7,4PS	150	01.58 -12.61	B6HS	4510	0,5	B6HVX	7435	203	BR6HIX	3419
Prima 3KL 7,4PS	150	01.58 -12.61	B6HS	4510	0,5	B6HVX	7435	203	BR6HIX	3419
Maxi 12,5PS	175	01.57 -12.61	B6HS	4510	0,5	B6HVX	7435	203	BR6HIX	3419
Prima 5 9,5PS	175	01.57 -12.61	B6HS	4510	0,5	B6HVX	7435	203	BR6HIX	3419
Lux	200		B7HS	5110	0,5	B7HVX	7836	204	BR7HIX	7067
Super Lux	200		B8HS	5510	0,5	B8HVX	2634	205	BR8HIX	7001
Max 17PS	250	01.55 -12.58	B8HS	5510	0,5	B8HVX	2634	205	BR8HIX	7001
Super Max 18PS	250	01.59 -12.61	B6HS	4510	0,5	B6HVX	7435	203	BR6HIX	3419
Supermax	250	56 -	B8HS	5510	0,5	B8HVX	2634	205	BR8HIX	7001
Konsul Sport	500		B8HS	5510	0,5	B8HVX	2634	205	BR8HIX	7001

**OMER**

Cross Mini	50		B6HS	4510	0,6	B6HVX	7435	203	BR6HIX	3419
Daytona 8 Mini	50		B6HS	4510	0,6	B6HVX	7435	203	BR6HIX	3419
Maggiolino	50		B5HS	4210	0,5					
Maggiolione	50		B5HS	4210	0,5					
Tanga / Noleggiato	50		B6HS	4510	0,6	B6HVX	7435	203	BR6HIX	3419
Vallelunga 10	50		B6HS	4510	0,6	B6HVX	7435	203	BR6HIX	3419
Vivo	50		BP6ES	7811	0,6	BP6EVX	5832		BPR6EIX	6637

**OSSA**

Ossita 50	50		B5HS	4210	0,5					
125 Enduro/Super Pioneer	125		B8ES	2411	0,5	B8EVX	7051	201	BR8EIX	5044
125 Moto Cross/Phantom	125		B9ES	2611	0,5	B9EVX	7254	202	BR9EIX	3981
150 Phantom	150		B8ES	2411	0,5	B8EVX	7051	201	BR8EIX	5044
160 GT-T2	160		B7ES	1111	0,5	B7EVX	6934			
175 American/Enduro/Sport	175		B8ES	2411	0,5	B8EVX	7051	201	BR8EIX	5044
175 Moto Cross/Phantom	175		B9ES	2611	0,5	B9EVX	7254	202	BR9EIX	3981
175 Super Pioneer/ 6 Dias	175		B8ES	2411	0,5	B8EVX	7051	201	BR8EIX	5044
230 Explorer/Trial	230		BP5ES	6511	0,5	BP5EVX	5470		BPR5EIX	6597
230 Super Pioneer	230		B8ES	2411	0,5	B8EVX	7051	201	BR8EIX	5044
250 American Enduro/Copa	250		B9ES	2611	0,5	B9EVX	7254	202	BR9EIX	3981
Copa F3	250				0,5	B9EVX	7254		BR9EIX	3981
Desert, Phantom, S.Pioneer	250		B9ES	2611	0,5	B9EVX	7254	202	BR9EIX	3981
Desert/Enduro/Moto Cross	250		B9ES	2611	0,5	B9EVX	7254	202	BR9EIX	3981
M.A.R. Explorer / Trial	250		BP5ES	6511	0,5	BP5EVX	5470		BPR5EIX	6597
Sport/Super Pioneer,TE 250	250		B9ES	2611	0,5	B9EVX	7254	202	BR9EIX	3981
T, Copa,F3	250		B9ES	2611	0,5	B9EVX	7254	202	BR9EIX	3981
TR 80,250 Exp./Trial/Tu-yo	250		BP5ES	6511	0,5	BP5EVX	5470		BPR5EIX	6597
Urbe Phanton,Trofeo 250 E7	250		B9ES	2611	0,5	B9EVX	7254	202	BR9EIX	3981
303 Trial,TR 80,	350		BP5ES	6511	0,5	BP5EVX	5470		BPR5EIX	6597
350 Desert/Super Pionner	350		B8ES	2411	0,5	B8EVX	7051	201	BR8EIX	5044
350 Explorer/Tu-yo , Trail	350		BP5ES	6511	0,5	BP5EVX	5470		BPR5EIX	6597
500 S, Yankee	500		B8ES	2411	0,5	B8EVX	7051	201	BR8EIX	5044

**PEUGEOT**

101	50	04.75 -	B5HS	4210	0,5					
102	50	04.75 -	B5HS	4210	0,5					
103	50	04.75 -	B5HS	4210	0,5					
103 CRX	50		B8HS	5510	0,5	B8HVX	2634	205	BR8HIX	7001

Order  
No.Platin  
Gold-  
Palla-  
diumOrder Quick  
No. No.

Iridium

Order  
No.**PEUGEOT**

103 LC	50		B8ES	2411	0,5	B8EVX	7051	201	BR8EIX	5044
103 LSM-D	50	06.82 -	B6HS	4510	0,5	B6HVX	7435	203	BR6HIX	3419
103 MP/MR	50		B8HS	5510	0,5	B8HVX	2634	205	BR8HIX	7001
103 Racen	50		B8HS	5510	0,5	B8HVX	2634	205	BR8HIX	7001
103 SP	50	86 -	B8HS	5510	0,5	B8HVX	2634	205	BR8HIX	7001
103 SPM-D	50	04.75 -	B6HS	4510	0,5	B6HVX	7435	203	BR6HIX	3419
103 T16	50		B8HS	5510	0,5	B8HVX	2634	205	BR8HIX	7001
103 TXLC, TXR	50		B8ES	2411	0,5	B8EVX	7051	201	BR8EIX	5044
103 Vogue	50		B8HS	5510	0,5	B8HVX	2634	205	BR8HIX	7001
103 XP, XPLC	50	01.86 -	B8ES	2411	0,5	B8EVX	7051	201	BR8EIX	5044
104	50		B5HS	4210	0,5					
105	50		B5HS	4210	0,5					
BB3K	50		B6HS	4510	0,5	B6HVX	7435	203	BR6HIX	3419
BB3L	50		B6HS	4510	0,5	B6HVX	7435	203	BR6HIX	3419
BB3SP	50		B6HS	4510	0,5	B6HVX	7435	203	BR6HIX	3419
C 50	50		B5HS	4210	0,5					
GL 10	50	01.79 -	B6HS	4510	0,5	B6HVX	7435	203	BR6HIX	3419
GT 10	50		B6HS	4510	0,5	B6HVX	7435	203	BR6HIX	3419
P 80	50		B8HS	5510	0,5	B8HVX	2634	205	BR8HIX	7001
RS	50		B5HS	4210	0,5					
RT	50		B5HS	4210	0,5					
S 157	50		B5HS	4210	0,5					
S 55	50		B5HS	4210	0,5					
SC 50	50		B6HS	4510	0,5	B6HVX	7435	203	BR6HIX	3419
SC 50 L (I)	50		BPR6HS	7022	0,6	BPR6HVX	2740	214	BPR6HIX	4085
SC 50L	50		B6HS	4510	0,5	B6HVX	7435	203	BR6HIX	3419
Scoper V50	50		B6HS	4510	0,5	B6HVX	7435	203	BR6HIX	3419
ST, STL 2, Rapido	50		BR6HSA	4296	0,6			210	BR6HIX	3419
SX5	50		B5HS	4210	0,5					
TLX 50	50		B6HS	4510	0,5	B6HVX	7435	203	BR6HIX	3419
TSA	50		B6HS	4510	0,5	B6HVX	7435	203	BR6HIX	3419
Velo a moteur Count.	50		B8HS	5510	0,5	B8HVX	2634	205	BR8HIX	7001
X 125 LC	50		B10ES	7928	0,5	B10EVX	7335		BR10EIX	6801
SC80L	80	06.82 -	BPR6HS	7022	0,7	BPR6HVX	2740	214	BPR6HIX	4085
SX8T	80	02.78 - 12.82	B7HS	5110	0,5	B7HVX	7836	204	BR7HIX	7067
P51-53	100		B6S	3510	0,5					
55 C	125		B6HS	4510	0,5	B6HVX	7435	203	BR6HIX	3419
55 D	125		B6HS	4510	0,5	B6HVX	7435	203	BR6HIX	3419
550	125		B6HS	4510	0,5	B6HVX	7435	203	BR6HIX	3419
P 150	150		B6HS	4510	0,5	B6HVX	7435	203	BR6HIX	3419
P 155	155		B6HS	4510	0,5	B6HVX	7435	203	BR6HIX	3419
P 156	155		B6HS	4510	0,5	B6HVX	7435	203	BR6HIX	3419
176	175		B6HS	4510	0,5	B6HVX	7435	203	BR6HIX	3419
176 BB	175		B6HS	4510	0,5	B6HVX	7435	203	BR6HIX	3419
176 Grand Sport	175		B8ES	2411	0,5	B8EVX	7051	201	BR8EIX	5044
176 TC	175		B6HS	4510	0,5	B6HVX	7435	203	BR6HIX	3419
256	250		B7HS	5110	0,5	B7HVX	7836	204	BR7HIX	7067

**PIAGGIO / VESPA**

--&gt; Scooter/Roller

Order  
No.Platin  
Gold-  
Palla-  
diumOrder Quick  
No. No.Order  
No.**POLINI**

Steel 910	50		B6HS	4510	0,6	B6HVX	7435	203	BR6HIX	3419
Steel 910 LC	50		B6HS	4510	0,6	B6HVX	7435	203	BR6HIX	3419
Steel 910 LC Race	50				0,6	B7HVX	7836		BR7HIX	7067
Steel 910 Race	50				0,6	B7HVX	7836		BR7HIX	7067

**PUCH**

DS 50	50		B6HS	4510	0,5	B6HVX	7435	203	BR6HIX	3419
DS 50 K	50		B6HS	4510	0,5	B6HVX	7435	203	BR6HIX	3419
DS 50 KXN	50		B6HS	4510	0,5	B6HVX	7435	203	BR6HIX	3419
DS 50 RN	50		B6HS	4510	0,5	B6HVX	7435	203	BR6HIX	3419
DS 60 C	50		B6HS	4510	0,5	B6HVX	7435	203	BR6HIX	3419
DS 60 CN	50		B6HS	4510	0,5	B6HVX	7435	203	BR6HIX	3419
DS 60 R	50		B6HS	4510	0,5	B6HVX	7435	203	BR6HIX	3419
DS 60 RN	50		B6HS	4510	0,5	B6HVX	7435	203	BR6HIX	3419
GS 50	50		B9HCS	2721	0,5					
GT 50	50		B9HS	5810	0,5	B9HVX	2254			
GTL 50	50		B9HS	5810	0,5	B9HVX	2254			
M 50 Jet	50		B8HS	5510	0,5	B8HVX	2634	205	BR8HIX	7001
M 50 Racing	50		B6HS	4510	0,5	B6HVX	7435	203	BR6HIX	3419
M 50 SE	50		B6HS	4510	0,5	B6HVX	7435	203	BR6HIX	3419
Maxi	50		B4H	4110	0,5					
Maxi 2 Gang	50		B5HS	4210	0,5					
Maxi II	50		B5HS	4210	0,5					
Maxi II-25	50		B4H	4110	0,5					
Maxi N	50		B5HS	4210	0,5					
Maxi S	50		B4H	4110	0,5					
MC 60 Scrambler	50		B8HS	5510	0,5	B8HVX	2634	205	BR8HIX	7001
MS 25	50		B6HS	4510	0,5	B6HVX	7435	203	BR6HIX	3419
MS 50 De Luxe Sears	50		B6HS	4510	0,5	B6HVX	7435	203	BR6HIX	3419
MS 50 Standard Sears	50		B6HS	4510	0,5	B6HVX	7435	203	BR6HIX	3419
MS 50 STD.California	50		B6HS	4510	0,5	B6HVX	7435	203	BR6HIX	3419
MS 50 V	50		B6HS	4510	0,5	B6HVX	7435	203	BR6HIX	3419
MS 50 V-Autolec	50		B6HS	4510	0,5	B6HVX	7435	203	BR6HIX	3419
P 1 L	50		B4H	4110	0,5					
P 1 XL	50		B4H	4110	0,5					
R 50	50		B6HS	4510	0,5	B6HVX	7435	203	BR6HIX	3419
R 50 K	50		B6HS	4510	0,5	B6HVX	7435	203	BR6HIX	3419
R 50 M	50		B8HS	5510	0,5	B8HVX	2634	205	BR8HIX	7001
R 50 V	50		B6HS	4510	0,5	B6HVX	7435	203	BR6HIX	3419
R 60 R	50		B6HS	4510	0,5	B6HVX	7435	203	BR6HIX	3419
VS 50 D	50		B6HS	4510	0,5	B6HVX	7435	203	BR6HIX	3419
VS 50 DK	50		B6HS	4510	0,5	B6HVX	7435	203	BR6HIX	3419
VS 50 DS	50		B6HS	4510	0,5	B6HVX	7435	203	BR6HIX	3419
VS 50 L	50		B6HS	4510	0,5	B6HVX	7435	203	BR6HIX	3419
VS 50 L-Autolec	50		B6HS	4510	0,5	B6HVX	7435	203	BR6HIX	3419
VS 60 R	50		B6HS	4510	0,5	B6HVX	7435	203	BR6HIX	3419
VZ 50 K	50		B6HS	4510	0,5	B6HVX	7435	203	BR6HIX	3419
VZ 50 M	50		B8HS	5510	0,5	B8HVX	2634	205	BR8HIX	7001
VZ 50 R	50		B6HS	4510	0,5	B6HVX	7435	203	BR6HIX	3419
VZ 50 V	50		B6HS	4510	0,5	B6HVX	7435	203	BR6HIX	3419
VZ 60 R	50		B6HS	4510	0,5	B6HVX	7435	203	BR6HIX	3419
X 30	50		B6HS	4510	0,5	B6HVX	7435	203	BR6HIX	3419

Order  
No.Platin  
Gold-  
Palla-  
diumOrder Quick  
No. No.

Iridium

Order  
No.**PUCH**

X 50-3	50		B7HS	5110	0,5	B7HVX	7836	204	BR7HIX	7067
Cobra 12,9 mm	80	81 -	B9HS	5810	0,5	B9HVX	2254			
Cobra 19,0 mm	80	81 -	B9ES	2611	0,5	B9EVX	7254	202	BR9EIX	3981
MC 125	125		B9ES	2611	0,5	B9EVX	7254	202	BR9EIX	3981
MC 175	175		B8ES	2411	0,5	B8EVX	7051	201	BR8EIX	5044
GS 250	250		B8ES	2411	0,5	B8EVX	7051	201	BR8EIX	5044
MC 250	250		B9ES	2611	0,5	B9EVX	7254	202	BR9EIX	3981
GS 350	350		B10EG	3630	0,6	B10EGV	5927			
GS 366	366		B8ES	2411	0,5	B8EVX	7051	201	BR8EIX	5044
GS 500	500		DP9EA-9	6629	0,9	DP9EVX-9	3331		DPR9EIX-9	5545
MC 500	500				0,6	B10EGV	5927			
GS 560	560		DP9EA-9	6629	0,9	DP9EVX-9	3331		DPR9EIX-9	5545

**REGENT**

Roadster,Tourer,RT 125	125		B7HS	5110	0,6	B7HVX	7836	204	BR7HIX	7067
Roadster,Tourer,RT 150	150		B7HS	5110	0,6	B7HVX	7836	204	BR7HIX	7067
Roadster,Tourer,RT 175	175		B7HS	5110	0,6	B7HVX	7836	204	BR7HIX	7067

**REX**

Chopper 125	125		DR8EA	7162	0,7	DR8EVX	6354		DR8EIX	6681
Cruiser 125	125		DR8EA	7162	0,7	DR8EVX	6354		DR8EIX	6681
Fun Bike	125	00 -	DP7EA-9	5629	0,9	DPR7EVX-9	7682		DPR7EIX-9	7803

**RIEJU**

Confort 402/403,Pony 50	50		B5HS	4210	0,5					
Confort 501,Helios,Varimat	50		B5HS	4210	0,5					
Drac 50(Air),Marathon 50	50		B6ES	7310	0,5	B6EVX	5136			
Drac/Water),RS-1,RV 50	50		B7ES	1111	0,5	B7EVX	6934			
MRX 50	50	03 -	BR8ES	5422	0,7	BR8EVX	1262	207	BR8EIX	5044
MX 50 (Child's)	50		B6HS	4510	0,5	B6HVX	7435	203	BR6HIX	3419
NKD 50 RS 2 Naked	50	03 -	BR8ES	5422	0,7	BR8EVX	1262	207	BR8EIX	5044
RR 50 AM6	50		BR8ES	5422	0,7	BR8EVX	1262	207	BR8EIX	5044
RR 50 Spezial Edition	50	03 -	BR8ES	5422	0,7	BR8EVX	1262	207	BR8EIX	5044
RS 2	50	03 -	BR8ES	5422	0,7	BR8EVX	1262	207	BR8EIX	5044
RS 1	50		BR8ES	5422	0,7	BR8EVX	1262	207	BR8EIX	5044
SMX 50	50	03 -	BR8ES	5422	0,7	BR8EVX	1262	207	BR8EIX	5044
Spike 50	50	03 -	BR8ES	5422	0,7	BR8EVX	1262	207	BR8EIX	5044
Sprint,Autom.Kick Starter	50		B5HS	4210	0,5					
Strada GT 49/GT Sport	50		B6ES	7310	0,5	B6EVX	5136			
Super Marathon 50/FDN/MT	50		B6ES	7310	0,5	B6EVX	5136			
Marathon 74 TT/Enduro	75		B6ES	7310	0,5	B6EVX	5136			
Marathon 75 Cross(Competi)	75				0,5	B10EGV	5927			
Marathon 75 Enduro	75				0,5	B10EGV	5927			
MR 74E,MR 75E,Strada GT75	75		B6ES	7310	0,5	B6EVX	5136			
TT 406	75		B6HS	4510	0,5	B6HVX	7435	203	BR6HIX	3419
MR 80 Enduro/Cross(Compet)	80				0,5	B10EGV	5927			
MR 80E, RST-80	80		B6ES	7310	0,5	B6EVX	5136			
MRX 125	125	03 -	BR8ES	5422	0,8	BR8EVX	1262	207	BR8EIX	5044
SMX 125	125	03 -	BR8ES	5422	0,8	BR8EVX	1262	207	BR8EIX	5044

**RIERA**

Windy	50		BR7HS	4122	0,5			211	BR7HIX	7067
-------	----	--	-------	------	-----	--	--	-----	--------	------

Order  
No.Platin  
Gold-  
PalladiumOrder Quick  
No. No.Order  
No.**RIXE**

Champion FT / FTH	50		B6HS	4510	0,6	B6HVX	7435	203	BR6HIX	3419
Derby B	50		B7HS	5110	0,5	B7HVX	7836	204	BR7HIX	7067
Derby D	50		B8HS	5510	0,5	B8HVX	2634	205	BR8HIX	7001
Geschäftsmoped	50		B7HS	5110	0,5	B7HVX	7836	204	BR7HIX	7067
Hight Sport	50		B6HS	4510	0,6	B6HVX	7435	203	BR6HIX	3419
Libelle E21	50		B4H	4110	0,5					
Libelle E23	50		B4H	4110	0,5					
Libelle FT/FTH/GTH	50		B6HS	4510	0,6	B6HVX	7435	203	BR6HIX	3419
Libelle Hight Sport Super	50		B4H	4110	0,5					
R503	50		B6HS	4510	0,6	B6HVX	7435	203	BR6HIX	3419
R504	50		B7HS	5110	0,5	B7HVX	7836	204	BR7HIX	7067
RS50 B3/ B4	50		B6HS	4510	0,6	B6HVX	7435	203	BR6HIX	3419
RS50S	50		B8HS	5510	0,5	B8HVX	2634	205	BR8HIX	7001
Standard 7 h	50		B7HS	5110	0,5	B7HVX	7836	204	BR7HIX	7067
Turismo 4	50		B7HS	5110	0,5	B7HVX	7836	204	BR7HIX	7067
Turismo E21	50		B6HS	4510	0,6	B6HVX	7435	203	BR6HIX	3419
Turismo ELS	50		B6HS	4510	0,6	B6HVX	7435	203	BR6HIX	3419
Turismo SL40	50		B6HS	4510	0,6	B6HVX	7435	203	BR6HIX	3419

**RIZZATO**

Califfo K	50		B5HS	4210	0,5					
Califfo 121 matic	50		B6HS	4510	0,6	B6HVX	7435	203	BR6HIX	3419
Califfo 80	50		B5HS	4210	0,5					
Califfo engine 119	50		B5HS	4210	0,5					
Califfo Mini	50		B5HS	4210	0,5					
Califfo Monomarcia Super	50		B6HS	4510	0,6	B6HVX	7435	203	BR6HIX	3419
Califfone 4 M	50		B5HS	4210	0,5					
Cross Satan 71	50		B6HS	4510	0,6	B6HVX	7435	203	BR6HIX	3419
Gio	50		B5HS	4210	0,5					
Mirage P4 Daytona	50		B6HS	4510	0,6	B6HVX	7435	203	BR6HIX	3419
Piu	50		B5HS	4210	0,5					
Ringo	50		B6HS	4510	0,6	B6HVX	7435	203	BR6HIX	3419
Satan	50		B6HS	4510	0,6	B6HVX	7435	203	BR6HIX	3419
Super Luxe 73	50		B6HS	4510	0,6	B6HVX	7435	203	BR6HIX	3419
Super Sprint Mirage	50		B6HS	4510	0,6	B6HVX	7435	203	BR6HIX	3419
Turismo Monomarcia	50		B6HS	4510	0,6	B6HVX	7435	203	BR6HIX	3419
Zum 3	50		B6HS	4510	0,6	B6HVX	7435	203	BR6HIX	3419
Cross Coguaro	125		B8ES	2411	0,5	B8EVX	7051	201	BR8EIX	5044
Tourismo	125		B8ES	2411	0,5	B8EVX	7051	201	BR8EIX	5044

**ROYAL ENFIELD**

Bonny	50		B6HS	4510	0,5	B6HVX	7435	203	BR6HIX	3419
Sunny	50		B6HS	4510	0,5	B6HVX	7435	203	BR6HIX	3419
KB 100	100		B8ES	2411	0,5	B8EVX	7051	201	BR8EIX	5044
Bullet Strada 12,7 mm	350		BR6HS	3922	0,6			209	BR6HIX	3419
Bullet Strada 19,0 mm	350		BR6ES	4922	0,6					
De Luxe,Super Star 12,7 mm	350		BR6HS	3922	0,6			209	BR6HIX	3419
De Luxe,Super Star 19,0 mm	350		BR6ES	4922	0,6					
India	350		B7HS	5110	0,5	B7HVX	7836	204	BR7HIX	7067
Bullet Electra	500		B9ES	2611	0,5	B9EVX	7254	202	BR9EIX	3981
Bullet 500 de Luxe	500		BR8ES	5422	0,7	BR8EVX	1262	207	BR8EIX	5044
Bullet Sixty 5	500		BR8ES	5422	0,7	BR8EVX	1262	207	BR8EIX	5044

Order  
No.Platin  
Gold-  
Palla-  
diumOrder Quick  
No. No.

Iridium

Order  
No.**ROYAL ENFIELD**

Bullet 500 Standard	500		BR8ES	5422	0,7	BR8EVX	1262	207	BR8EIX	5044
India	500		B8ES	2411	0,5	B8EVX	7051	201	BR8EIX	5044

**S.I.S.**

4 Cyclone	50		B8HS	5510	0,5	B8HVX	2634	205	BR8HIX	7001
Almirante 4/5	50		B8HS	5510	0,5	B8HVX	2634	205	BR8HIX	7001
Asa d'Ouro	50		B6HS	4510	0,6	B6HVX	7435	203	BR6HIX	3419
Brass	50		B6HS	4510	0,6	B6HVX	7435	203	BR6HIX	3419
EKO 70	50		B7HS	5110	0,5	B7HVX	7836	204	BR7HIX	7067
Felino	50		B7HS	5110	0,5	B7HVX	7836	204	BR7HIX	7067
Lebre / V4	50		B8HS	5510	0,5	B8HVX	2634	205	BR8HIX	7001
Mini Sport	50		B7HS	5110	0,5	B7HVX	7836	204	BR7HIX	7067
Mini Turismo	50		B7HS	5110	0,5	B7HVX	7836	204	BR7HIX	7067
Minor GT	50		B6HS	4510	0,6	B6HVX	7435	203	BR6HIX	3419
V5 Sport	50		B8HS	5510	0,5	B8HVX	2634	205	BR8HIX	7001
V5 Super Sport	50		B8HS	5510	0,5	B8HVX	2634	205	BR8HIX	7001
V5 Turismo	50		B8HS	5510	0,5	B8HVX	2634	205	BR8HIX	7001

**SACHS**

Saxonette Classic	30		BP4	2911	0,5					
Saxonette	30	01.87 -	BPR4S	4427	0,5					
City Bike C1	50	10.72 -08.78	B6HS	4510	0,7	B6HVX	7435	203	BR6HIX	3419
City Bike C2	50	10.72 -08.78	B6HS	4510	0,7	B6HVX	7435	203	BR6HIX	3419
City Bike C3	50	09.74 -08.78	B6HS	4510	0,7	B6HVX	7435	203	BR6HIX	3419
Dirty Devil 50	50		BP5HS	4111	0,5					
Enduro ZX 50	50		BR8ES	5422	0,5	BR8EVX	1262	207	BR8EIX	5044
Hobby Rider HR 1	50	10.72 -12.87	B6HS	4510	0,7	B6HVX	7435	203	BR6HIX	3419
Hobby Rider HR 2	50	10.72 -12.87	B6HS	4510	0,7	B6HVX	7435	203	BR6HIX	3419
Jogging	50		B6HS	4510	0,5	B6HVX	7435	203	BR6HIX	3419
K 50	50	-08.78	B8HS	5510	0,7	B8HVX	2634	205	BR8HIX	7001
K 50 Ultra	50	-08.78	B8HS	5510	0,7	B8HVX	2634	205	BR8HIX	7001
K 50 Ultra II	50	-08.78	B8HS	5510	0,5	B8HVX	2634	205	BR8HIX	7001
K 50 Ultra LC	50	-08.78	B9ES	2611	0,5	B9EVX	7254	202	BR9EIX	3981
K 50 Ultra LC II	50	-08.78	B9ES	2611	0,5	B9EVX	7254	202	BR9EIX	3981
K 50 Ultra LC III	50	-08.78	B9ES	2611	0,5	B9EVX	7254	202	BR9EIX	3981
KX 5	50	01.86 -	BP7HS	5111	0,5	BP7HVX	7468		BPR7HIX	5944
KX 50	50		B6HS	4510	0,5	B6HVX	7435	203	BR6HIX	3419
Lastboy	50		B7HS	5110	0,5	B7HVX	7836	204	BR7HIX	7067
M1	50	10.72 -12.77	B6HS	4510	0,5	B6HVX	7435	203	BR6HIX	3419
M2	50	10.72 -12.77	B6HS	4510	0,5	B6HVX	7435	203	BR6HIX	3419
M4	50	09.74 -12.78	B6HS	4510	0,5	B6HVX	7435	203	BR6HIX	3419
M5	50	09.74 -12.78	B6HS	4510	0,5	B6HVX	7435	203	BR6HIX	3419
MadAss 50	50		CR7HSA	4549	0,8				CR7HIX	7544
MK 1S	50	01.78 -08.80	B6HS	4510	0,5	B6HVX	7435	203	BR6HIX	3419
MK 2S	50	01.78 -08.80	B6HS	4510	0,5	B6HVX	7435	203	BR6HIX	3419
MP 2	50	10.72 -12.77	B6HS	4510	0,5	B6HVX	7435	203	BR6HIX	3419
MP 4	50	10.72 -12.77	B6HS	4510	0,5	B6HVX	7435	203	BR6HIX	3419
MX 1	50	01.89 -	B5HS	4210	0,5					
MX 1	50		B6HS	4510	0,5	B6HVX	7435	203	BR6HIX	3419
Optima 3	50	01.78 -	B6HS	4510	0,5	B6HVX	7435	203	BR6HIX	3419
Optima 50	50		BR8HS	4322	0,5	BR8HVX	6265	212	BR8HIX	7001
Prima 2	50		BR5HS	3722	0,5					

Order  
No.Platin  
Gold-  
Palla-  
diumOrder  
No.Quick  
No.

Iridium

Order  
No.**SACHS**

Prima 2S	50	01.89 -	B5HS	4210	0,5					
Prima 3	50		B6HS	4510	0,5	B6HVX	7435	203	BR6HIX	3419
Prima 3S	50	01.89 -	B5HS	4210	0,5					
Prima 4	50		B6HS	4510	0,5	B6HVX	7435	203	BR6HIX	3419
Prima 4LN,5LN	50		B6HS	4510	0,5	B6HVX	7435	203	BR6HIX	3419
Prima 5	50		B6HS	4510	0,5	B6HVX	7435	203	BR6HIX	3419
Prima 5,5S	50	01.89 -	BR5HS	3722	0,5					
Prima 6	50		B6HS	4510	0,5	B6HVX	7435	203	BR6HIX	3419
Prima G3	50		B6HS	4510	0,5	B6HVX	7435	203	BR6HIX	3419
Prima GT	50	01.89 -	B5HS	4210	0,5					
Prima GT,GX	50		B6HS	4510	0,5	B6HVX	7435	203	BR6HIX	3419
Prima Presto	50		B6HS	4510	0,5	B6HVX	7435	203	BR6HIX	3419
Prima Pronto	50		B6HS	4510	0,5	B6HVX	7435	203	BR6HIX	3419
Prima S	50		B6HS	4510	0,5	B6HVX	7435	203	BR6HIX	3419
Prima SL	50		B6HS	4510	0,5	B6HVX	7435	203	BR6HIX	3419
Prima SX	50		B6HS	4510	0,5	B6HVX	7435	203	BR6HIX	3419
Sport Bike SB1	50	10.72 -08.74	B8HS	5510	0,5	B8HVX	2634	205	BR8HIX	7001
Sport Bike SB2	50	10.72 -08.79	B6HS	4510	0,5	B6HVX	7435	203	BR6HIX	3419
Sport Bike SB3	50	09.74 -08.79	B6HS	4510	0,5	B6HVX	7435	203	BR6HIX	3419
Sport Bike SB5	50	09.74 -08.76	B8HS	5510	0,5	B8HVX	2634	205	BR8HIX	7001
Supra 2D,3D	50	06.80 -	B6HS	4510	0,5	B6HVX	7435	203	BR6HIX	3419
Supra 4	50	06.78 -	B7HS	5110	0,5	B7HVX	7836	204	BR7HIX	7067
Supra 4GP	50	01.80 -	B6HS	4510	0,5	B6HVX	7435	203	BR6HIX	3419
Supra Enduro	50	03.80 -	B6HS	4510	0,5	B6HVX	7435	203	BR6HIX	3419
Ultra 50	50		B9ES	2611	0,5	B9EVX	7254	202	BR9EIX	3981
XE 5	50	01.86 -	BP7HS	5111	0,5	BP7HVX	7468		BPR7HIX	5944
ZX 1	50		B7ES	1111	0,5	B7EVX	6934			
RX 9	80		B8HS	5510	0,5	B8HVX	2634	205	BR8HIX	7001
Ultra 80 LC	80		B8HS	5510	0,5	B8HVX	2634	205	BR8HIX	7001
Ultra 80 AC	80	01.82 -	B7HS	5110	0,5	B7HVX	7836	204	BR7HIX	7067
XE 9	80	01.82 -	B8HS	5510	0,5	B8HVX	2634	205	BR8HIX	7001
K 100 X	100		B8HS	5510	0,5	B8HVX	2634	205	BR8HIX	7001
Dirty Devil 110	110		C7HSA	4629	0,6	C7HVX	4533		CR7HIX	7544
K 125 BW Military	125	09.74 -	B8HS	5510	0,5	B8HVX	2634	205	BR8HIX	7001
K 125 GS	125		B9ES	2611	0,5	B9EVX	7254	202	BR9EIX	3981
K 125 MC	125		B9ES	2611	0,5	B9EVX	7254	202	BR9EIX	3981
K 125 S	125	10.72 -08.79			0,5	B9EVX	7254		BR9EIX	3981
K 125 T	125	10.72 -08.79			0,5	B9EVX	7254		BR9EIX	3981
K 125 X	125		B8HS	5510	0,5	B8HVX	2634	205	BR8HIX	7001
MadAss 125	125		CR7HSA	4549	0,8				CR7HIX	7544
Roadster 125 V2	125	98 -	CR6HSA	2983	0,8				CR6HIX	7274
RS 125	125	97 -	BR8ES	5422	0,7	BR8EVX	1262	207	BR8EIX	5044
X-Road 125	125		CR8E	1275	0,6			226	CR8EIX	4218
XTC 125 V2 11kW	125	98 -	BR9ES	5722	0,8	BR9EVX	1265	208	BR9EIX	3981
XTC-N 125 V2 7,8kW	125	98 -	BR8ES	5422	0,8	BR8EVX	1262	207	BR8EIX	5044
ZX 125 15PS	125	97 -	BR9ES	5722	0,6	BR9EVX	1265	208	BR9EIX	3981
ZX 125 11PS	125	97 -	BR8ES	5422	0,6	BR8EVX	1262	207	BR8EIX	5044
ZX 125	125	97 -	BR8ES	5422	0,7	BR8EVX	1262	207	BR8EIX	5044
ZZ 125 Typ B	125	01 -	BR8ES	5422	0,8	BR8EVX	1262	207	BR8EIX	5044
ZZ 125 Typ A >10kW	125	01 -	BR9ES	5722	0,8	BR9EVX	1265	208	BR9EIX	3981
175 GS	175		B9ES	2611	0,5	B9EVX	7254	202	BR9EIX	3981
250 GS	250		B9ES	2611	0,5	B9EVX	7254	202	BR9EIX	3981



Order  
No.Platin  
Gold-  
Palla-  
diumOrder Quick  
No. No.

Iridium

Order  
No.**SACHS**

W 2000	294		BR7ES	5122	0,5	BR7EVX	4556			
350 GS	350				0,5	B9EVX	7254		BR9EIX	3981
Roadster 650	650	99 -	CR9E	6263	0,8	CR9EVX	5943	227	CR9EIX	3521
Roadster 800	800	01 -	DPR8EA-9	4929	0,9	DPR8EVX-9	2872	221	DPR8EIX-9	2202

**SAN YANG**

Bullet 50 (G5A,B)	50		BR8HSA	5539	0,6	BR8HVX	6265		BR8HIX	7001
DIO (F5A,B,E)	50		BR8HSA	5539	0,6	BR8HVX	6265		BR8HIX	7001

**SANGLAS**

350	350		BP6ES	7811	0,5	BP6EVX	5832		BPR6EIX	6637
400 E	400		BP6ES	7811	0,5	BP6EVX	5832		BPR6EIX	6637
400 Y (Motor Yamaha)	400		BP7ES	2412	0,7	BP7EVX	7270	206	BPR7EIX	4055
500 S/ S2-V5	500		BP6ES	7811	0,5	BP6EVX	5832		BPR6EIX	6637

**SCORPA**

Easy Trail	250	94 -	BP5ES	6511	0,7	BP5EVX	5470		BPR5EIX	6597
SY 2001 (engine YamahaTY250Z)	250	01 -			0,6	BCP6EVX	6323			
Easy Trail	280	94 -	BP5ES	6511	0,7	BP5EVX	5470		BPR5EIX	6597

**SHERCO**

Trial Kid	50	02 -							BR9EIX	3981
City Corp 125	125	05 -	BP5ES	6511	0,7	BP5EVX	5470		BPR5EIX	6597
Trail 1,2	125	00 -	BP5ES	6511	0,5	BP5EVX	5470		BPR5EIX	6597
Scottish Six Days Winner	250	00 -	BP5ES	6511	0,5	BP5EVX	5470		BPR5EIX	6597
Trail 2,5	250	00 -	BP5ES	6511	0,5	BP5EVX	5470		BPR5EIX	6597
Trail 2,9	250	00 -	BP5ES	6511	0,5	BP5EVX	5470		BPR5EIX	6597
4.5 4T	450	05 -	CR8EK	3478	0,7				CR8EIX	4218

**SHERCO- HRD**

Enduro	50	02 -	BR8ES	5422	0,5	BR8EVX	1262	207	BR8EIX	5044
Super Motard	50	02 -	BR8ES	5422	0,5	BR8EVX	1262	207	BR8EIX	5044

**SIAMOTO**

Birdie 25 Mofa	25	99 -	BPR6HS	7022	0,6	BPR6HVX	2740	214	BPR6HIX	4085
Birdie 50 Mokick	50	99 -	BPR6HS	7022	0,6	BPR6HVX	2740	214	BPR6HIX	4085

**SIMONINI IMEA**

Competizione Sachs	50		B10EGV	5927	0,5	B10EVX	7335			
Indian	50		B6HS	4510	0,6	B6HVX	7435	203	BR6HIX	3419
Indian	50		B8HS	5510	0,5	B8HVX	2634	205	BR8HIX	7001
Masetti Racing	50		B10EGV	5927	0,5	B10EVX	7335			
Masetti Strada	50		B10EGV	5927	0,5	B10EVX	7335			
Mustang Rino Baby	50		B8HS	5510	0,5	B8HVX	2634	205	BR8HIX	7001
SF 150	50		B10EGV	5927	0,5	B10EVX	7335			
Speedy 2 Morini	50		B7HS	5110	0,5	B7HVX	7836	204	BR7HIX	7067
Mustang Regolarita 125	125		B10EGV	5927	0,5	B10EVX	7335			
Diamond Sachs	250		B10EGV	5927	0,5	B10EVX	7335			
Hard Racer	250		B10EGV	5927	0,5	B10EVX	7335			
Mustang 250A	250		B10EGV	5927	0,5	B10EVX	7335			
Mustang 250H20	250		B10EGV	5927	0,5	B10EVX	7335			
Mustang Cross SA	250		B10EGV	5927	0,5	B10EVX	7335			

Order  
No.Platin  
Gold-  
Palla-  
diumOrder Quick  
No. No.Order  
No.**SIMONINI IMEA**

Mustang Cross SSH20	250		B10EGV	5927	0,5	B10EVX	7335			
Shadow 250	250		B10EGV	5927	0,5	B10EVX	7335			

**SIMSON**

Albatros	50		B8HS	5510	0,4	B8HVX	2634	205	BR8HIX	7001
AT 50	50	09.90 -	B8HS	5510	0,6	B8HVX	2634	205	BR8HIX	7001
Bunny 50	50	01.87 -12.90	B8HS	5510	0,6	B8HVX	2634	205	BR8HIX	7001
Habicht 25	50		B8HS	5510	0,4	B8HVX	2634	205	BR8HIX	7001
Habicht 50	50		B8HS	5510	0,4	B8HVX	2634	205	BR8HIX	7001
Habicht 50 Basic	50		B8HS	5510	0,4	B8HVX	2634	205	BR8HIX	7001
Habicht 50 s	50		B8HS	5510	0,4	B8HVX	2634	205	BR8HIX	7001
Kleinkraftrad	50		B8HS	5510	0,4	B8HVX	2634	205	BR8HIX	7001
S 50 B1	50	01.75 -12.80	B8HS	5510	0,6	B8HVX	2634	205	BR8HIX	7001
S 51 Enduro	50	01.81 -12.90	B8HS	5510	0,6	B8HVX	2634	205	BR8HIX	7001
S 51 B2-4	50	01.82 -12.90	B8HS	5510	0,6	B8HVX	2634	205	BR8HIX	7001
S 53	50	09.90 -	B8HS	5510	0,6	B8HVX	2634	205	BR8HIX	7001
Sperber 50 Basic	50		B8HS	5510	0,4	B8HVX	2634	205	BR8HIX	7001
SR 50 , 1B ,C,CE	50	09.90 -	B8HS	5510	0,6	B8HVX	2634	205	BR8HIX	7001
SR 50 CC , CCE	50	01.93 -	B8HS	5510	0,6	B8HVX	2634	205	BR8HIX	7001
SR 50	50	01.85 -12.90	B8HS	5510	0,6	B8HVX	2634	205	BR8HIX	7001
SR 50 XC , XCE , XG	50	06.93 -	B8HS	5510	0,6	B8HVX	2634	205	BR8HIX	7001
Star 25	50	96 -	B8HS	5510	0,4	B8HVX	2634	205	BR8HIX	7001
Star 25 Base E	50	96 -	B8HS	5510	0,4	B8HVX	2634	205	BR8HIX	7001
Star Classic 50	50	96 -	B8HS	5510	0,4	B8HVX	2634	205	BR8HIX	7001
Star Classic 50 Hot Summer	50	96 -	B8HS	5510	0,4	B8HVX	2634	205	BR8HIX	7001
Trucky SD 50 CT	50		B8HS	5510	0,4	B8HVX	2634	205	BR8HIX	7001
GS 75/1	70	01.75 -12.90	B8HS	5510	0,6	B8HVX	2634	205	BR8HIX	7001
Leichtkraftrad	70		B8HS	5510	0,4	B8HVX	2634	205	BR8HIX	7001
S 70 C,C,E/2	70	01.80 -12.90	B8HS	5510	0,6	B8HVX	2634	205	BR8HIX	7001
Habicht 80	80		B8HS	5510	0,4	B8HVX	2634	205	BR8HIX	7001
Habicht 80 Basic	80		B8HS	5510	0,4	B8HVX	2634	205	BR8HIX	7001
Habicht 80 s	80		B8HS	5510	0,4	B8HVX	2634	205	BR8HIX	7001
Hot Summer 80	80	96 -	B8HS	5510	0,4	B8HVX	2634	205	BR8HIX	7001
Sperber 80 Basic	80		B8HS	5510	0,4	B8HVX	2634	205	BR8HIX	7001
Star Classic 80	80	96 -	B8HS	5510	0,4	B8HVX	2634	205	BR8HIX	7001

**SOLO**

712 Mofa	48		BR6HS	3922	0,7			209	BR6HIX	3419
713 Moped	48		BR7HS	4122	0,7			211	BR7HIX	7067
722 Mofa	48		BR6HS	3922	0,7			209	BR6HIX	3419
723 Moped	48		BR7HS	4122	0,7			211	BR7HIX	7067

**SPARTA**

Buddy	50		B6HS	4510	0,6	B6HVX	7435	203	BR6HIX	3419
Happy	50		B6HS	4510	0,6	B6HVX	7435	203	BR6HIX	3419
Lucky	50		B6HS	4510	0,6	B6HVX	7435	203	BR6HIX	3419
Sport 2V	50		B6HS	4510	0,6	B6HVX	7435	203	BR6HIX	3419
Sport 3V	50		B6HS	4510	0,6	B6HVX	7435	203	BR6HIX	3419
Tour Automatica	50		B6HS	4510	0,6	B6HVX	7435	203	BR6HIX	3419

**STARFLITE**

25 (Laura M48-15B)	50		B6HS	4510	0,6	B6HVX	7435	203	BR6HIX	3419
--------------------	----	--	------	------	-----	-------	------	-----	--------	------

Order  
No.Gold-  
Palla-  
dium

Platin

Order  
No.Quick  
No.

Iridium

Order  
No.**STARFLITE**

40 (Laura M48-11B)	50		B6HS	4510	0,6	B6HVX	7435	203	BR6HIX	3419
Bronco	50		B6HS	4510	0,6	B6HVX	7435	203	BR6HIX	3419
City Laura M48-15B	50		B6HS	4510	0,6	B6HVX	7435	203	BR6HIX	3419
GTM (F&S 501 BKF)	50		B6HS	4510	0,6	B6HVX	7435	203	BR6HIX	3419
GTS (F&S 50SA)	50		B8HS	5510	0,5	B8HVX	2634	205	BR8HIX	7001
Tramp (Laura M48-15)	50		B6HS	4510	0,6	B6HVX	7435	203	BR6HIX	3419

**SUNDIRO**

Phönix XDZ 125 TN	125	96 -	DR8EA	7162	0,6	DR8EVX	6354		DR8EIX	6681
-------------------	-----	------	-------	------	-----	--------	------	--	--------	------

**SUZUKI**

A 50 K	50		BR8HS	4322	0,7	BR8HVX	6265	212	BR8HIX	7001
A 50 P	50		BR7HS	4122	0,7			211	BR7HIX	7067
AE 50	50	93 -	BPR6HS	7022	0,7	BPR6HVX	2740	214	BPR6HIX	4085
AJ 50	50	95 -	BPR7HS	6422	0,6	BPR7HVX	2938	215	BPR7HIX	5944
AJ 50 ZZ	50	95 -	BPR7HS	6422	0,6	BPR7HVX	2938	215	BPR7HIX	5944
AP 50 (CA1JA)	50	95 -	BPR6HS	7022	0,7	BPR6HVX	2740	214	BPR6HIX	4085
CL 50 D0	50		BP4HS	3611	0,7					
CP 50 (CA14C/E)	50		BPR6HS	7022	0,7	BPR6HVX	2740	214	BPR6HIX	4085
CP 50 H-J,L/M/N	50		BPR6HS	7022	0,7	BPR6HVX	2740	214	BPR6HIX	4085
CS 50	50		BPR4HS	7823	0,7					
CX 50	50		BPR6HS	7022	0,7	BPR6HVX	2740	214	BPR6HIX	4085
CY 50	50		BPR6HS	7022	0,7	BPR6HVX	2740	214	BPR6HIX	4085
DM 50	50		BP6HS	4511	0,7	BP6HVX	4635		BPR6HIX	4085
DR Big 50	50	89 -	BR7HS	4122	0,7			211	BR7HIX	7067
DV 50	50		BP6ES	7811	0,7	BP6EVX	5832		BPR6EIX	6637
FA 50	50		BPR4HS	7823	0,7					
FR 50	50		BPR4HS	7823	0,7					
FS 50	50		BP4HA	3511	0,7					
FZ 50	50		BPR4HS	7823	0,7					
GT 50	50		BP6HS	4511	0,7	BP6HVX	4635		BPR6HIX	4085
JR 50	50	95 -	BPR4HS	7823	0,6					
JR 50	50	93 - 94	BP4H	3310	0,7					
JR 50 (JA143)	50		BPR4HS	7823	0,7					
K 50	50		BP7HS	5111	0,7	BP7HVX	7468		BPR7HIX	5944
Katana AY50 aircooled	50	97 -	BPR6HS	7022	0,7	BPR6HVX	2740	214	BPR6HIX	4085
Katana AY50 water (Spain)	50	97 -	BPR7HS	6422	0,7	BPR7HVX	2938	215	BPR7HIX	5944
Katana AY50 watercooled	50	97 -	BPR6HS	7022	0,7	BPR6HVX	2740	214	BPR6HIX	4085
Maxi 50	50		B7HS	5110	0,6	B7HVX	7836	204	BR7HIX	7067
OR 50	50		BP6HS	4511	0,7	BP6HVX	4635		BPR6HIX	4085
RB 50 GAG	50	88 - 88	CR6HS	7023	0,7			223	CR6HIX	7274
RG 50 KE	50		BP8ES	2912	0,7	BP8EVX	2671			
RG 50 W	50		BPR8ES	3923	0,8	BPR8EVX	5573	213		
RM 50	50	90 -	BR7HS	4122	0,7			211	BR7HIX	7067
RM 50	50	- 89	B7HS	5110	0,7	B7HVX	7836	204	BR7HIX	7067
RV 50	50		BP6HS	4511	0,7	BP6HVX	4635		BPR6HIX	4085
Suzy	50	95 -	BPR6HS	7022	0,7	BPR6HVX	2740	214	BPR6HIX	4085
TR 50	50		BP4H	3310	0,7					
TR 50 S Magic	50	98 -	BPR6HS	7022	0,7	BPR6HVX	2740	214	BPR6HIX	4085
TS 50 12,7mm	50		BP6HS	4511	0,7	BP6HVX	4635		BPR6HIX	4085
TS 50 19,0mm	50		BP6ES	7811	0,8	BP6EVX	5832		BPR6EIX	6637
TS 50 ER	50		BP6HS	4511	0,7	BP6HVX	4635		BPR6HIX	4085

Order  
No.Platin  
Gold-  
PalladiumOrder Quick  
No. No.Order  
No.**SUZUKI**

TS 50 XK (SA11C)	50		BP6ES	7811	0,7	BP6EVX	5832		BPR6EIX	6637
ZR 50	50		BP6ES	7811	0,8	BP6EVX	5832		BPR6EIX	6637
RM 65	65	04 -	BR10EG	3830	0,6					
CS 80	80		BPR6HS	7022	0,7	BPR6HVX	2740	214	BPR6HIX	4085
DS 80	80	93 - 94	B7ES	1111	0,7	B7EVX	6934			
DS 80	80	95 -	BP7ES	2412	0,6	BP7EVX	7270	206	BPR7EIX	4055
FR 80	80		BPR6HS	7022	0,7	BPR6HVX	2740	214	BPR6HIX	4085
GT 80 EX/LX	80		B8ES	2411	0,7	B8EVX	7051	201	BR8EIX	5044
JR 80 (K2)	80	02 -	BR7ES	5122	0,8	BR7EVX	4556			
RG 80 G (D) (NC11A)	80		BP7ES	2412	0,8	BP7EVX	7270	206	BPR7EIX	4055
RG 80 Gamma	80		BP7ES	2412	0,8	BP7EVX	7270	206	BPR7EIX	4055
RG 80 WF	80		BPR7ES	2023	0,8	BPR7EVX	5565		BPR7EIX	4055
RM 80	80	93 -	B10ES	7928	0,8	B10EVX	7335		BR10EIX	6801
RM 80 H	80		BR9ES	5722	0,8	BR9EVX	1265	208	BR9EIX	3981
RM 80 X	80	- 90	BR9ES	5722	0,8	BR9EVX	1265	208	BR9EIX	3981
RM 80 X	80	91 -	BR10ES	4832	0,7	BR10EVX	3788		BR10EIX	6801
TS 80 ERX	80		B7ES	1111	0,8	B7EVX	6934			
TS 80 X (SA11A)	80		BP7ES	2412	0,7	BP7EVX	7270	206	BPR7EIX	4055
TS 80 XE-H	80		BP8ES	2912	0,8	BP8EVX	2671			
RM 85 (K2)(K3)(K4)	85	02 -	BR10ES	4832	0,8	BR10EVX	3788		BR10EIX	6801
FM 90	90		BPR6HS	7022	0,7	BPR6HVX	2740	214	BPR6HIX	4085
RV 90	90		BP6HS	4511	0,6	BP6HVX	4635		BPR6HIX	4085
A 100	100	95 -	BP6HS	4511	0,6	BP6HVX	4635		BPR6HIX	4085
FB 100 / D	100	95 -	D8EA	2120	0,6	D8EVX	2850	216	DR8EIX	6681
GP 100	100		B8HS	5510	0,7	B8HVX	2634	205	BR8HIX	7001
RM 100	100				0,6	B9EGV	5827			
RM 100 X	100				0,6	B9EGV	5827			
TS 100 X	100	78 -	B8ES	2411	0,7	B8EVX	7051	201	BR8EIX	5044
TS 100 X	100	- 77	B8HS	5510	0,7	B8HVX	2634	205	BR8HIX	7001
DR-Z 110 (LX110A)	111	03 -	CR6HSA	2983	0,7				CR6HIX	7274
125 Van Van	125	03 -	CR8E	1275	0,6	CR8EVX	6487	226	CR8EIX	4218
CS 125	125		DR8ESL	2923	0,7	DR8EVX	6354	218	DR8EIX	6681
DR 125 S/L-N	125	91 -	DR8ESL	2923	0,7	DR8EVX	6354	218	DR8EIX	6681
DR 125 SE (SF44A)	125	95 -	DR8EA	7162	0,6	DR8EVX	6354		DR8EIX	6681
DR 125 SJ (SF43B)	125		DR8ESL	2923	0,7	DR8EVX	6354	218	DR8EIX	6681
GN 125 V (NF41A)	125	97 -	DR8EA	7162	0,7	DR8EVX	6354		DR8EIX	6681
GN 125	125	91 -	DR8ESL	2923	0,7	DR8EVX	6354	218	DR8EIX	6681
GP 125	125		B8HS	5510	0,7	B8HVX	2634	205	BR8HIX	7001
GS 125 S	125		DR8ESL	2923	0,9	DR8EVX	6354	218	DR8EIX	6681
GS 125 S	125	99 -	DR8EA	7162	0,7	DR8EVX	6354		DR8EIX	6681
GT 125,-E	125		B8HS	5510	0,7	B8HVX	2634	205	BR8HIX	7001
GZ 125 / U (AP) Marauder	125	99 -	DR8EA	7162	0,7	DR8EVX	6354		DR8EIX	6681
RG 125	125	01.85 -	BR9ES	5722	0,7	BR9EVX	1265	208	BR9EIX	3981
RM 125	125	86			0,6	B9EGV	5827			
RM 125	125	87 - 92			0,6	BR9EVX	1265		BR9EIX	3981
RM 125	125	96 - 97	R6918B-8	4492	0,6					
RM 125	125	93 - 95	R4118S-9	3245	0,6					
RC 125	125		B7HS	5110	0,6	B7HVX	7836	204	BR7HIX	7067
RV 125	125		B7HS	5110	0,6	B7HVX	7836	204	BR7HIX	7067
RV 125 (K7)	125	07 -	CR8E	1275	0,6	CR8EVX	6487	226	CR8EIX	4218
TS 125 ER N	125	79 - 79	BP8ES	2912	0,8	BP8EVX	2671			
TS 125 R	125		BR9ES	5722	0,8	BR9EVX	1265	208	BR9EIX	3981



Order No.



Gold-Palladium



Order Quick No. No.

Iridium



Order No.

**SUZUKI**

TS 125 X	125		BR8ES	5422	0,8	BR8EVX	1262	207	BR8EIX	5044
TS 125 ER T, X	125	80 - 83	B8ES	2411	0,8	B8EVX	7051	201	BR8EIX	5044
TS 125 C,C2	125	01.78 - 78	BR8ES	5422	0,8	BR8EVX	1262	207	BR8EIX	5044
TS 125 N	125	79 - 79	B8ES	2411	0,8	B8EVX	7051	201	BR8EIX	5044
TS 125 X E	125	84 -	B8ES	2411	0,8	B8EVX	7051	201	BR8EIX	5044
TS 125 K, L, M	125	73 - 75	B7HS	5110	0,8	B7HVX	7836	204	BR7HIX	7067
TS 125 A / B	125	76-12.77	B8HS	5510	0,5	B8HVX	2634	205	BR8HIX	7001
TU 125 XT (AZ)	125	99 -	DR8EA	7162	0,7	DR8EVX	6354		DR8EIX	6681
UE 125 C (WVBH)	125	01 -	CR7E	4578	0,6			225	CR7EIX	7385
VL 125 LC Intruder	125	00 -	CR8E	1275	0,6	CR8EVX	6487	226	CR8EIX	4218
PE 175	175	79 -			0,6	B10EGV	5927			
PE 175	175	78 - 78			0,6	B8EGV	5627			
GT 185	185		B7HS	5110	0,7	B7HVX	7836	204	BR7HIX	7067
TS 185 ER	185	93 -	BP7ES	2412	0,8	BP7EVX	7270	206	BPR7EIX	4055
DR 200 SZ	200	95 -	DR8EA	7162	0,6	DR8EVX	6354		DR8EIX	6681
GT 200	200		B8ES	2411	0,8	B8EVX	7051	201	BR8EIX	5044
TS 200	200		BR9ES	5722	0,8	BR9EVX	1265	208	BR9EIX	3981
DR 250	250	91 -	DPR9EA-9	5329	0,9	DPR9EVX-9	3854	222	DPR9EIX-9	5545
DR 250 S	250	90 -	DPR9EA-9	5329	0,9	DPR9EVX-9	3854	222	DPR9EIX-9	5545
DR 250 S (SJ42A)	250		DR8ESL	2923	0,7	DR8EVX	6354	218	DR8EIX	6681
DR 250 SZ	250	95 -	DPR9EA-9	5329	0,8	DPR9EVX-9	3854	222	DPR9EIX-9	5545
DR 250 SZ-H	250		DR8ESL	2923	0,7	DR8EVX	6354	218	DR8EIX	6681
GN 250 EZ-J	250		DR8ESL	2923	0,7	DR8EVX	6354	218	DR8EIX	6681
GN 250 L-N (NJ42A)	250	- 97	DR8ESL	2923	0,7	DR8EVX	6354	218	DR8EIX	6681
GN 250 (NJ42A)	250	98 -	DR8EA	7162	0,7	DR8EVX	6354		DR8EIX	6681
GNX 250	250	01.82-12.84	DR8ESL	2923	0,7	DR8EVX	6354	218	DR8EIX	6681
GSX 250 EZ (GJ53B)	250		DR8ES	5423	0,7	DR8EVX	6354	217	DR8EIX	6681
GSX 250 L	250		DR8ES	5423	0,7	DR8EVX	6354	217	DR8EIX	6681
GSX 250 T/ET 1	250		DR8ES	5423	0,7	DR8EVX	6354	217	DR8EIX	6681
GZ 250 ( JS1AR)	250	99 -	DR8EA	7162	0,7	DR8EVX	6354		DR8EIX	6681
PE 250	250	- 78			0,6	B8EGV	5627			
PE 250	250	80 -			0,6	B10EGV	5927			
PE 250	250	79 - 79			0,6	B9EGV	5827			
RG 250 CH/FCH (GJ21D)	250		BR9ES	5722	0,7	BR9EVX	1265	208	BR9EIX	3981
RG 250 G-CH	250		BR9ES	5722	0,8	BR9EVX	1265	208	BR9EIX	3981
RG 250 WE (GJ21A)	250		BR9ES	5722	0,8	BR9EVX	1265	208	BR9EIX	3981
RGV 250 L (VJ21A)	250	90 - 90	BR9ES	5722	0,8	BR9EVX	1265	208	BR9EIX	3981
RGV 250 M-N (VJ22B)	250	91 -	BR9ECM	3252	0,8	BR9ECMVX	2434			
RM 250	250	82 - 92			0,6	B8EGV	5627			
RM 250	250	- 81			0,6	B9EGV	5827			
RM 250	250	93 - 00	R4118S-8	3236	0,6					
RM 250 (JS1RJ18A)(K2,K3,K4)	250	01 - 03	BR8EG	3130	0,6					
RMX 250	250				0,6	B9EGV	5827			
RM-Z 250	250	04 -	CR8EB	7784	0,6	CR8EVX	6487		CR8EIX	4218
RM-Z 250	250	07 -			1,0				CR8EIA-10	4708
TS 250 X G-K (SJ11D)	250		BR9ES	5722	0,8	BR9EVX	1265	208	BR9EIX	3981
350 Goose	350	93 -	CR9EK	4548	0,7			230	CR9EIX	3521
DR 350	350	95 -	CR9EK	4548	0,6			230	CR9EIX	3521
DR 350 S/L-P (SK42B)	350	91 -	DPR9EA-9	5329	0,9	DPR9EVX-9	3854	222	DPR9EIX-9	5545
DR 350 SH/N/S	350	90 -	DPR9EA-9	5329	0,9	DPR9EVX-9	3854	222	DPR9EIX-9	5545
DR 350 SZ	350	95 -	CR9EK	4548	0,6			230	CR9EIX	3521
DR 400 S	400	01.80-12.83	DR8ESL	2923	0,7	DR8EVX	6354	218	DR8EIX	6681

Order  
No.Platin  
Gold-  
Palla-  
diumOrder Quick  
No. No.Order  
No.**SUZUKI**

DR-Z 400 (WVBC)	400	00 -	CR8E	1275	0,6	CR8EVX	6487	226	CR8EIX	4218
DR-Z 400 S (WVBC)	400	00 -	CR8E	1275	0,6	CR8EVX	6487	226	CR8EIX	4218
DR-Z 400 SM K5 (WVB8)	400	05 -	CR8E	1275	0,6	CR8EVX	6487	226	CR8EIX	4218
GN 400 TD-X	400		DR8ESL	2923	0,7	DR8EVX	6354	218	DR8EIX	6681
GS 400 R/C/EC/N/EN	400		B8ES	2411	0,7	B8EVX	7051	201	BR8EIX	5044
GS 400 TX	400		B8ES	2411	0,7	B8EVX	7051	201	BR8EIX	5044
GSF 400 (BANDIT GK75B)	400	92 -	CR9EK	4548	0,7			230	CR9EIX	3521
GSF 400 (BANDIT GK75B)	400	- 92	CR8EK	3478	0,7				CR8EIX	4218
GSX 400 E (GS40X)	400	01.83 -	DR8ESL	2923	0,7	DR8EVX	6354	218	DR8EIX	6681
GSX 400 FW	400		CR8HS	7423	0,7	CR8HVX	7236		CR8HIX	7669
GSX 400 FX	400		DR8ESL	2923	0,6	DR8EVX	6354	218	DR8EIX	6681
GSX 400 LX	400		DR8ESL	2923	0,7	DR8EVX	6354	218	DR8EIX	6681
GSX 400 S	400		DR8ESL	2923	0,6	DR8EVX	6354	218	DR8EIX	6681
GSX 400 SE/EF (GK53C)	400		DR8ESL	2923	0,7	DR8EVX	6354	218	DR8EIX	6681
GSX-R400	400		CR8EK	3478	0,7				CR8EIX	4218
GSX-R400	400	93 -	CR9EK	4548	0,7			230	CR9EIX	3521
VS 400	400	95 -	DPR8EA-9	4929	0,8	DPR8EVX-9	2872	221	DPR8EIX-9	2202
GS 450 E/ES (GS450)	450		B8ES	2411	0,7	B8EVX	7051	201	BR8EIX	5044
GS 450 L (GL51D)	450		B8ES	2411	0,7	B8EVX	7051	201	BR8EIX	5044
GS 450 LT/X (GS450)	450		B8ES	2411	0,7	B8EVX	7051	201	BR8EIX	5044
GS 450 SF	450		BR8ES	5422	0,7	BR8EVX	1262	207	BR8EIX	5044
GS 450 TX	450		B8ES	2411	0,7	B8EVX	7051	201	BR8EIX	5044
RM-Z 450	450	08 -			1,0				DIMR8A10	
RM-Z 450 K5 (RL41A)	450	05 -			1,0				CR8EIB-10	4948
RM 495	495				0,5	B8EGV	5627			
DR 500 S (D)	500		DR8ESL	2923	0,7	DR8EVX	6354	218	DR8EIX	6681
DR 500 S (I)	500		D8EA	2120	0,7	D8EVX	2850	216	DR8EIX	6681
DR 500 SX-Z	500		DR8ESL	2923	0,7	DR8EVX	6354	218	DR8EIX	6681
GS 500 E	500	- 00	B8ES	2411	0,7	B8EVX	7051	201	BR8EIX	5044
GS 500 E (GM51B)	500	93 - 00	DPR8EA-9	4929	0,9	DPR8EVX-9	2872	221	DPR8EIX-9	2202
GS 500 F	500	04 -	DPR8EA-9	4929	0,9	DPR8EVX-9	2872	221	DPR8EIX-9	2202
RG 500	500	87 - 87	BR9ES	5722	0,8	BR9EVX	1265	208	BR9EIX	3981
RM 500	500				0,5	B8EGV	5627			
GS 550 MX/LN/T	550		B8ES	2411	0,7	B8EVX	7051	201	BR8EIX	5044
GSX 550 (GN71D)	550		DR8ES	5423	0,7	DR8EVX	6354	217	DR8EIX	6681
GSX 550 EF (I)	550		DP9EA-9	6629	0,9	DP9EVX-9	3331		DPR9EIX-9	5545
GT 550	550	01.73 -12.77	B8ES	2411	0,7	B8EVX	7051	201	BR8EIX	5044
DR 600	600		DPR9EA-9	5329	0,9	DPR9EVX-9	3854	222	DPR9EIX-9	5545
DR 600 R Djebel (I)	600		DPR9EA-9	5329	0,9	DPR9EVX-9	3854	222	DPR9EIX-9	5545
DR 600 S (SN41A)	600		DPR9EA-9	5329	0,9	DPR9EVX-9	3854	222	DPR9EIX-9	5545
GSF 600 Y (WVA8)	600	00 -	CR9EK	4548	0,6			230	CR9EIX	3521
GSF 600 (GN77B)	600	95 -	CR9EK	4548	0,7			230	CR9EIX	3521
GSF 600 (K2)	600	02 -	CR9EK	4548	0,6			230	CR9EIX	3521
GSF 600 S (K2)	600	02 -	CR9EK	4548	0,6			230	CR9EIX	3521
GSR 600 (K6)	600	06 -	CR9E	6263	0,7	CR9EVX	5943	227	CR9EIX	3521
GSX 600 F (W)	600	98 -	CR9EK	4548	0,7			230	CR9EIX	3521
GSX 600 F/FU/FU2 (GN72B)	600		DR8ES	5423	0,7	DR8EVX	6354	217	DR8EIX	6681
GSX-R 600 (K6)	600	06 -	CR9E	6263	0,7	CR9EVX	5943	227	CR9EIX	3521
GSX-R 600 (WVB2)	600	04 -	CR9E	6263	0,7	CR9EVX	5943	227	CR9EIX	3521
GSX-R 600 (JS1AD)	600	97 - 00	CR9E	6263	0,7	CR9EVX	5943	227	CR9EIX	3521
GSX-R 600 (W) (JS1BG)(WVBG)	600	98 -	CR9E	6263	0,7	CR9EVX	5943	227	CR9EIX	3521
RF 600 R / RU (GN76B)	600	93 -	CR9E	6263	0,7	CR9EVX	5943	227	CR9EIX	3521

Order  
No.Platin  
Gold-  
Palla-  
diumOrder Quick  
No. No.

Iridium

Order  
No.**SUZUKI**

VS 600 (VN51B)	600	95 -	DPR8EA-9	4929	0,9	DPR8EVX-9	2872	221	DPR8EIX-9	2202
DL 650 V-strom K7) Twinspark	650	06 -	CR8E	1275	0,8	CR8EVX	6487	226	CR8EIX	4218
DL 650 V-strom ( K4-K6)	650	04 - 06	CR8E	1275	0,8	CR8EVX	6487	226	CR8EIX	4218
DR 650 R/RU (SP41B)	650		DPR9EA-9	5329	0,9	DPR9EVX-9	3854	222	DPR9EIX-9	5545
DR 650 R/RU (SP44B)	650		DPR9EA-9	5329	0,9	DPR9EVX-9	3854	222	DPR9EIX-9	5545
DR 650 RE (SP45B)	650	94 -	DPR9EA-9	5329	0,9	DPR9EVX-9	3854	222	DPR9EIX-9	5545
DR 650 RS/RSU (SP42B)	650	91 -	DPR9EA-9	5329	0,9	DPR9EVX-9	3854	222	DPR9EIX-9	5545
DR 650 RSE/RSEU (SP43B)	650	90 -	DPR9EA-9	5329	0,9	DPR9EVX-9	3854	222	DPR9EIX-9	5545
DR 650 SET	650	96 - 00	CR9E	6263	0,6	CR9EVX	5943	227	CR9EIX	3521
GR 650 D/XD/XF (GP51A)	650		DR8ESL	2923	0,6	DR8EVX	6354	218	DR8EIX	6681
GS 650 G	650		DR8ESL	2923	0,6	DR8EVX	6354	218	DR8EIX	6681
GSF 650 (K7)	650	07 -	CR9E	6263	0,7	CR9EVX	5943	227	CR9EIX	3521
GSF 650 / S K5 (WVB5)	650	05 - 06	CR8EK	3478	0,6				CR8EIX	4218
LS 650 (NP41B)	650	- 00	DPR8EA-9	4929	0,9	DPR8EVX-9	2872	221	DPR8EIX-9	2202
SV 650 (K3-K7)	650	03 -	CR8E	1275	0,7	CR8EVX	6487	226	CR8EIX	4218
SV 650 S (AV)	650	99 -	CR9E	6263	0,6	CR9EVX	5943	227	CR9EIX	3521
SV 650 S (K3-K7)	650	03 -	CR8E	1275	0,7	CR8EVX	6487	226	CR8EIX	4218
SV 650 SU (AV)	650	99 -	CR9E	6263	0,6	CR9EVX	5943	227	CR9EIX	3521
XF 650 (JS1AC) Freewind	650	97 -	CR9EK	4548	0,7			230	CR9EIX	3521
DR 750 S (DR BIG SR41B)	750		DPR9EA-9	5329	0,9	DPR9EVX-9	3854	222	DPR9EIX-9	5545
GS 750 D/E/L	750		B8ES	2411	0,7	B8EVX	7051	201	BR8EIX	5044
GSX 750 E	750		DR8ESL	2923	0,6	DR8EVX	6354	218	DR8EIX	6681
GSX 750 E (I)	750		D8EA	2120	0,7	D8EVX	2850	216	DR8EIX	6681
GSX 750 EF	750	- 85	DR8ESL	2923	0,7	DR8EVX	6354	218	DR8EIX	6681
GSX 750 ES (I)	750		D8EA	2120	0,7	D8EVX	2850	216	DR8EIX	6681
GSX 750 F (GR78A)	750	89 -	JR9C	6193	0,7				DR9EIX	4772
GSX 750 S	750		DR8ESL	2923	0,6	DR8EVX	6354	218	DR8EIX	6681
GSX 750 S Katana (I)	750		DR8EA	7162	0,7	DR8EVX	6354		DR8EIX	6681
GSX 750 T	750		DR8ESL	2923	0,6	DR8EVX	6354	218	DR8EIX	6681
GSX 750 (W)(AK / AE )	750	98 -	CR9EK	4548	0,7			230	CR9EIX	3521
GSX R 750 (GR75A)	750	- 87	DR8ES	5423	0,7	DR8EVX	6354	217	DR8EIX	6681
GSX R 750 (GR77B)	750	88 -	JR9C	6193	0,7				DR9EIX	4772
GSX-R 750 Y (WVBD)	750	00 -	CR9E	6263	0,7	CR9EVX	5943	227	CR9EIX	3521
GSX-R 750 (K6)	750	06 -	CR9E	6263	0,7	CR9EVX	5943	227	CR9EIX	3521
GSX-R 750 (WVB3)	750	04 -	CR9E	6263	0,7	CR9EVX	5943	227	CR9EIX	3521
GSX-R 750 (GR7AB)	750	91 -	CR10EK	2360	0,7				CR10EIX	6482
GSX-R 750 J-K	750		JR9B	3188	0,7			224	DR9EIX	4772
GSX-R 750 R	750	89 -	CR10EK	2360	0,7				CR10EIX	6482
GSX-R 750 RG (GR75A)(GR79B)	750		DR8ES	5423	0,7	DR8EVX	6354	217	DR8EIX	6681
GSX-R 750 T	750	96 -	CR9E	6263	0,6	CR9EVX	5943	227	CR9EIX	3521
GSX-R 750 (W)	750	98 -	CR9E	6263	0,7	CR9EVX	5943	227	CR9EIX	3521
GSX-R 750 W	750	95 -	CR9E	6263	0,6	CR9EVX	5943	227	CR9EIX	3521
GSX-R 750 W (GR7BB)	750	- 93	CR9EK	4548	0,7			230	CR9EIX	3521
GT 750	750		B7ES	1111	0,5	B7EVX	6934			
VS 750 GL/H/J-K	750		DPR9EA-9	5329	0,9	DPR9EVX-9	3854	222	DPR9EIX-9	5545
DR 800 S/SU L (SR42B)	773	90 -	DPR9EA-9	5329	0,9	DPR9EVX-9	3854	222	DPR9EIX-9	5545
DR 800 S/SU M-N (SR43B)	800		DPR9EA-9	5329	0,9	DPR9EVX-9	3854	222	DPR9EIX-9	5545
VL 800 (K2;K5) (WVBM) Intruder C800	800	01 -	DPR7EA-9	5129	0,9	DPR7EVX-9	7682	220	DPR7EIX-9	7803
VS 800 N-P (VS52B)	800	92 - 00	DPR8EA-9	4929	0,9	DPR8EVX-9	2872	221	DPR8EIX-9	2202
VX 800/U (VS51B)	800		DPR8EA-9	4929	0,9	DPR8EVX-9	2872	221	DPR8EIX-9	2202
VZ 800 (JS1AF)Marauder	800	97 -	DPR8EA-9	4929	0,9	DPR8EVX-9	2872	221	DPR8EIX-9	2202
VZ 800/ U K5 Intruder M800 (WVB4)	800	05 -	DPR7EA-9	5129	0,9	DPR7EVX-9	7682	220	DPR7EIX-9	7803



Order No.



Platin Gold-Palladium

Order Quick No.

Iridium



Order No.

**SUZUKI**

GS 850 G (GS72A)	850		B8ES	2411	0,7	B8EVX	7051	201	BR8EIX	5044
GS 850 GL	850		B8ES	2411	0,7	B8EVX	7051	201	BR8EIX	5044
GS 850 GT E-G (GS72A)	850		B9ES	2611	0,7	B9EVX	7254	202	BR9EIX	3981
RF 900 R (GT73B)	900	94 -	CR9E	6263	0,7	CR9EVX	5943	227	CR9EIX	3521
GS 1000 D/E/H/S-1980/GL/GX	1000		B8ES	2411	0,7	B8EVX	7051	201	BR8EIX	5044
GSX 1000 E	1000	86 -	DPR9EA-9	5329	0,9	DPR9EVX-9	3854	222	DPR9EIX-9	5545
GSX-R 1000	1000	- 99	JR9B	3188	0,7			224	DR9EIX	4772
GSX-R 1000 (WVBL) Fuel Injection	1000	01 -	CR9E	6263	0,7	CR9EVX	5943	227	CR9EIX	3521
GSX-R 1000 (K3) (WVBZ)	1000	03 -	CR9E	6263	0,7	CR9EVX	5943	227	CR9EIX	3521
GSX-R 1000	1000	05 -	CR9E	6263	0,7	CR9EVX	5943	227	CR9EIX	3521
GSX-R1000 (K7)	1000	07 -							CR9EIA-9	6289
SV 1000 (WVBX)	1000	03 -	CR8EK	3478	0,7				CR8EIX	4218
SV 1000 S (WVBX)	1000	03 -	CR8EK	3478	0,7				CR8EIX	4218
TL 1000 R (W)	1000	98 -	CR9EK	4548	0,7			230	CR9EIX	3521
TL 1000 S (JS1AG)	1000	97 - 00	CR8EK	3478	0,7				CR8EIX	4218
V-Strom 1000	1000	02 -	CR8EK	3478	0,7				CR8EIX	4218
GS 1100 E,GSX 1100 E	1100		DR8ESL	2923	0,6	DR8EVX	6354	218	DR8EIX	6681
GS 1100 G /GG (GU71A)	1100		B8ES	2411	0,8	B8EVX	7051	201	BR8EIX	5044
GS 1100 GT	1100		B8ES	2411	0,7	B8EVX	7051	201	BR8EIX	5044
GSX 1100 EFE (I)	1100		D8EA	2120	0,7	D8EVX	2850	216	DR8EIX	6681
GSX 1100 EFG/ESG/EG(GV71C)	1100		DR8ES	5423	0,7	DR8EVX	6354	217	DR8EIX	6681
GSX 1100 EZ/ESD (GU71B)	1100		DR8ESL	2923	0,6	DR8EVX	6354	218	DR8EIX	6681
GSX 1100 F (GV72C)72-100kW	1100		JR9B	3188	0,7			224	DR9EIX	4772
GSX 1100 G L-N (GV74A)	1100		JR9B	3188	0,7			224	DR9EIX	4772
GSX 1100 S/SZ Kata.(GS110XS)	1100		D8EA	2120	0,7	D8EVX	2850	216	DR8EIX	6681
GSX-K 1100 (I)	1100		JR9B	3188	0,7			224	DR9EIX	4772
GSX R-1100 W (GU75C)	1100	93 -	CR9E	6263	0,7	CR9EVX	5943	227	CR9EIX	3521
GSX-R 1100 (GU74C,GV73C)	1100		JR9B	3188	0,7			224	DR9EIX	4772
GS 1150 EF (NL,I)	1150		D9EA	2420	0,7	D9EVX	2834		DR9EIX	4772
GS 1150 ES (NL,I)	1150		D9EA	2420	0,7	D9EVX	2834		DR9EIX	4772
GSX 1150 E	1150	86 -	DPR9EA-9	5329	0,9	DPR9EVX-9	3854	222	DPR9EIX-9	5545
GSX 1150 E	1150	- 85	DR8ES	5423	0,7	DR8EVX	6354	217	DR8EIX	6681
GSX 1150 EF	1150		DR8ES	5423	0,7	DR8EVX	6354	217	DR8EIX	6681
GSX 1150 ES	1150		DR8ES	5423	0,7	DR8EVX	6354	217	DR8EIX	6681
GSF 1200 / S (JS1A9..)(WVA9)	1200	01 -	JR9B	3188	0,7			224	DR9EIX	4772
GSF 1200 (K6)	1200	06 -	JR9B	3188	0,7			224	DR9EIX	4772
GSF 1200 /S/SA	1200	96 - 00	JR9B	3188	0,7			224	DR9EIX	4772
GSX 1200	1200		JR8B	7237	0,7				DR8EIX	6681
GV 1200 GL	1200	86 -	DR8ESL	2923	0,7	DR8EVX	6354	218	DR8EIX	6681
GSF 1250 Bandit	1250	07 -	CR7E	4578	0,6			225	CR7EIX	7385
GSX 1300 R Hayabusa (WV A1)	1300	99 -	CR9E	6263	0,7	CR9EVX	5943	227	CR9EIX	3521
GSX 1400	1400	01 -	CR8EK	3478	0,7				CR8EIX	4218
VS 1400 GLP H-J (VX51L)	1400	87 -	DPR8EA-9	4929	0,9	DPR8EVX-9	2872	221	DPR8EIX-9	2202
VL 1500 Intruder LC	1500	98 - 04	DPR7EA-9	5129	0,9	DPR7EVX-9	7682	220	DPR7EIX-9	7803
VL 1500 K5 (WVAL) Intruder C 1500	1500	05 -	DPR7EA-9	5129	0,9	DPR7EVX-9	7682	220	DPR7EIX-9	7803
VZ 1600 Marauder 1600	1600	04 -	DPR6EA-9	5531	0,9					
M 1800 R Intruder K6 (VZR1800)	1800	06 -	CR8EK	3478	0,7				CR8EIX	4218

**SV**

Dakar 2/3	35		BPM6A	7021	0,5					
Triciclo Mini-Dakar	35		BPM6A	7021	0,5					



Order  
No.Platin  
Gold-  
Palla-  
diumOrder Quick  
No. No.

Iridium

Order  
No.**SWM**

TLM 125	125		BP5ES	6511	0,4	BP5EVX	5470		BPR5EIX	6597
TL 200	200		BP5ES	6511	0,4	BP5EVX	5470		BPR5EIX	6597
TL 240	240		BP5ES	6511	0,4	BP5EVX	5470		BPR5EIX	6597
TLM 320	320		BP5ES	6511	0,4	BP5EVX	5470		BPR5EIX	6597
TL 350	350		BP5ES	6511	0,4	BP5EVX	5470		BPR5EIX	6597

**SYM**

Husky	125	97 -	DR8EA	7162	0,7	DR8EVX	6354		DR8EIX	6681
Wolf 125	125	05 -	DR8EA	7162	0,7	DR8EVX	6354		DR8EIX	6681

**TESTI**

Amico (Minarelli V1)	50		B5HS	4210	0,5					
Carabo CR (8.5PS)	50		B8HS	5510	0,5	B8HVX	2634	205	BR8HIX	7001
Carabo(Minarelli P4A)	50		B6HS	4510	0,6	B6HVX	7435	203	BR6HIX	3419
Carabo(Minarelli P6CS)	50		B6HS	4510	0,6	B6HVX	7435	203	BR6HIX	3419
Carabo(Minarelli P6RAD)	50		B6ES	7310	0,7	B6EVX	5136			
Champion Special(Minarelli P6CS)	50		B6HS	4510	0,6	B6HVX	7435	203	BR6HIX	3419
Champion Special(Minarelli P6RAD)	50		B6ES	7310	0,7	B6EVX	5136			
Champion(Minarelli P4/P6RAD)	50		B6ES	7310	0,7	B6EVX	5136			
Champion(Minarelli P4A/CS)	50		B6HS	4510	0,6	B6HVX	7435	203	BR6HIX	3419
Champion(Minarelli P6A/CS)	50		B6HS	4510	0,6	B6HVX	7435	203	BR6HIX	3419
Confort (Minarelli V1N)	50		B5HS	4210	0,5					
Confort(Minarelli P3NK)	50		B6HS	4510	0,6	B6HVX	7435	203	BR6HIX	3419
Corsa (8.5PS)	50		B8HS	5510	0,5	B8HVX	2634	205	BR8HIX	7001
Criket (Minarelli V1AK/NK)	50		B5HS	4210	0,5					
Criket(Minarelli P4A)	50		B6HS	4510	0,6	B6HVX	7435	203	BR6HIX	3419
Criket(Minarelli P4CS/RAD)	50		B6ES	7310	0,7	B6EVX	5136			
Gran Prix(Minarelli P4A)	50		B6HS	4510	0,6	B6HVX	7435	203	BR6HIX	3419
IO (Minarelli V1AKS)	50		B5HS	4210	0,5					
Jeans(Minarelli P4/P6 RAD)	50		B6ES	7310	0,7	B6EVX	5136			
Mini Criket (Minarelli V1N/AK)	50		B5HS	4210	0,5					
O.K.C. (Minarelli C2)	50		B5HS	4210	0,5					
O.K.S. (Minarelli V1N)	50		B5HS	4210	0,5					
Pull (Minarelli V1NK)	50		B5HS	4210	0,5					
Grand Touring (Minarelli)	80		B8HS	5510	0,5	B8HVX	2634	205	BR8HIX	7001
2000 Special	125		B8ES	2411	0,5	B8EVX	7051	201	BR8EIX	5044
Corsa	125		B8ES	2411	0,5	B8EVX	7051	201	BR8EIX	5044
Corsa Easy Rider	125		B8ES	2411	0,5	B8EVX	7051	201	BR8EIX	5044

**TGB**

202T big wvvels	50	98 -	BPR7HS	6422	0,8	BPR7HVX	2938	215	BPR7HIX	5944
Ergon	50	98 -	BPR7HS	6422	0,8	BPR7HVX	2938	215	BPR7HIX	5944
202T Palio	125	98 -	C7HSA	4629	0,7	C7HVX	4533		CR7HIX	7544

**TITAN**

Coyote	1573	97 - 03	BPR5ES	7422	0,7	BPR5EVX	4875		BPR5EIX	6597
Fat Bobber S&S engine	1573		BPR5ES-11	4424	1,1	BPR5EVX-11	2738		BPR5EIX-11	2115
Gecko	1573	97 - 03	BPR5ES	7422	0,7	BPR5EVX	4875		BPR5EIX	6597
Roadrunner	1573	97 - 03	BPR5ES	7422	0,7	BPR5EVX	4875		BPR5EIX	6597
Scorpion	1573	97 - 03	BPR5ES	7422	0,7	BPR5EVX	4875		BPR5EIX	6597
Sidewinder	1573	97 - 03	BPR5ES	7422	0,7	BPR5EVX	4875		BPR5EIX	6597
Custom Pro Street S&S engine	1753		BPR5ES-11	4424	1,1	BPR5EVX-11	2738		BPR5EIX-11	2115

Order  
No.Platin  
Gold-  
Palla-  
diumOrder Quick  
No. No.Order  
No.**TITAN**

Custom Rubber Mount Chopper S&S engine	1852		BPR5ES-11	4424	1,1	BPR5EVX-11	2738		BPR5EIX-11	2115
Custom Softtail Chopper S&S engine	1852		BPR5ES-11	4424	1,1	BPR5EVX-11	2738		BPR5EIX-11	2115
Radical Rigid S&S engine	1852		BPR5ES-11	4424	1,1	BPR5EVX-11	2738		BPR5EIX-11	2115
Custom Rubber Mount Chopper S&S engine	2003		DCPR7E	3932	0,8	DCPR7EVX	1179		DCPR7EIX	6046
Custom Softtail Chopper S&S engine	2003		DCPR7E	3932	0,8	DCPR7EVX	1179		DCPR7EIX	6046
Radical Rigid S&S engine	2003		DCPR7E	3932	0,8	DCPR7EVX	1179		DCPR7EIX	6046

**TM**

Cross, Enduro	80	94 -	B9EG	3530	0,6	B9EGV	5827		BR9EIX	3981
125 EN	125	03 -	BR9EG	3230	0,6	BR9EVX	1265		BR9EIX	3981
Cross, Enduro	125	94 -	B10EG	3630	0,6	B10EGV	5927			
250 EN	250	03 -	BR8EG	3130	0,5					
250 EN-F	250	04 -	CR8E	1275	0,7	CR8EVX	6487	226	CR8EIX	4218
Cross, Enduro	250	94 -	B9EG	3530	0,6	B9EGV	5827		BR9EIX	3981
300 EN	300	03 -	BR8EG	3130	0,5					
Cross, Enduro	300		B9EG	3530	0,6	B9EGV	5827		BR9EIX	3981
450 EN-F	450	04 -	CR8E	1275	0,7	CR8EVX	6487	226	CR8EIX	4218

**TOKAIDO**

RC 25	25		B5HS	4210	0,8					
-------	----	--	------	------	-----	--	--	--	--	--

**TOMOS**

Forza	49		BPR8HS	3725	0,6				BPR8HIX	6742
Quadro 25	49		B6HS	4510	0,6	B6HVX	7435	203	BR6HIX	3419
Tomos	50		B7HS	5110	0,5	B7HVX	7836	204	BR7HIX	7067
Tomos Cross	50		B8HS	5510	0,5	B8HVX	2634	205	BR8HIX	7001
Tomos	80		B7HS	5110	0,5	B7HVX	7836	204	BR7HIX	7067

**TORPADO**

Derby Automatic	50		B6HS	4510	0,6	B6HVX	7435	203	BR6HIX	3419
Derby Deluxe	50		B5HS	4210	0,5					
Golf Deluxe	50		B5HS	4210	0,5					
Green	50		B5HS	4210	0,5					
Green Deluxe	50		B5HS	4210	0,5					
Squirrel Cross	50		B7HS	5110	0,5	B7HVX	7836	204	BR7HIX	7067

**TORROT**

Ciclomatic/ 2VL	50		B7HS	5110	0,5	B7HVX	7836	204	BR7HIX	7067
City CX/N/SL/X	50		B7HS	5110	0,5	B7HVX	7836	204	BR7HIX	7067
City/L/2V/2V-TT	50		B6HS	4510	0,5	B6HVX	7435	203	BR6HIX	3419
Cycloscooter S50/HL	50		B6HS	4510	0,5	B6HVX	7435	203	BR6HIX	3419
Gran Cross,Maxi,Mini	50		B5HS	4210	0,5					
Mustang,Panther,Tiburon	50		B5HS	4210	0,5					
Sport Sachs TX50, TT50	50		B7HS	5110	0,5	B7HVX	7836	204	BR7HIX	7067
Super Cross/Rally Sachs	50		B7HS	5110	0,5	B7HVX	7836	204	BR7HIX	7067
Trial,Turismo	50		B5HS	4210	0,5					

**TRIUMPH**

Daytona 600	600	03 -	CR9EK	4548	0,7			230	CR9EIX	3521
Speed Four	600	02 -	CR9EK	4548	0,7			230	CR9EIX	3521
Speed Triple S	600	02 -	CR9EK	4548	0,7			230	CR9EIX	3521
Supersport	600	01 -	CR9EK	4548	0,7			230	CR9EIX	3521



Order No.



Gold-Palladium



Order No.

Quick No.

Iridium



Order No.

**TRIUMPH**

TT 600 (806AD)	600	00 -	CR9EK	4548	0,7			230	CR9EIX	3521
Bonneville T120, R, V	650		B8ES	2411	0,5	B8EVX	7051	201	BR8EIX	5044
Daytona 650	650	05 -	CR9EK	4548	0,7			230	CR9EIX	3521
Tiger, Trophy Sport TR6C	650		B8ES	2411	0,5	B8EVX	7051	201	BR8EIX	5044
Trophy TR6 --> Nr.029363	650		B7HS	5110	0,5	B7HVX	7836	204	BR7HIX	7067
Trophy TR6 Nr.029364 -->	650		B7ES	1111	0,5	B7EVX	6934			
Daytona 675	675	06 -	CR9EK	4548	0,7			230	CR9EIX	3521
Daytona 675 RR	675	06 -	CR9EK	4548	0,7			230	CR9EIX	3521
Speed Triple 675	675	07 -	CR9EK	4548	0,7			230	CR9EIX	3521
Bonneville T140D/E	750		B6ES	7310	0,5	B6EVX	5136			
Bonneville T140V	750		B8ES	2411	0,5	B8EVX	7051	201	BR8EIX	5044
Daytona 750	750	91 -	DPR8EA-9	4929	0,9	DPR8EVX-9	2872	221	DPR8EIX-9	2202
Hurricane TRX75	750		B8ES	2411	0,5	B8EVX	7051	201	BR8EIX	5044
Speed Triple 750	750	97 -	DPR8EA-9	4929	0,9	DPR8EVX-9	2872	221	DPR8EIX-9	2202
Sprint RS	750	99 -	DPR8EA-9	4929	0,9	DPR8EVX-9	2872	221	DPR8EIX-9	2202
Tiger TR7RV, TR7V	750		B8ES	2411	0,5	B8EVX	7051	201	BR8EIX	5044
Trident T150V, T160	750		B8ES	2411	0,5	B8EVX	7051	201	BR8EIX	5044
Trident 750	750	91 -	DPR8EA-9	4929	0,9	DPR8EVX-9	2872	221	DPR8EIX-9	2202
America	790	05 -	DPR8EA-9	4929	0,9	DPR8EVX-9	2872	221	DPR8EIX-9	2202
Bonneville America(908M)	790	02 -	DPR8EA-9	4929	0,9	DPR8EVX-9	2872	221	DPR8EIX-9	2202
Bonneville T100	790	02 -	DPR8EA-9	4929	0,9	DPR8EVX-9	2872	221	DPR8EIX-9	2202
Bonneville (908MD)	790	00 -	DPR8EA-9	4929	0,9	DPR8EVX-9	2872	221	DPR8EIX-9	2202
Speedmaster	790	02 -	DPR8EA-9	4929	0,9	DPR8EVX-9	2872	221	DPR8EIX-9	2202
Scrambler 900	865	06 -	DPR8EA-9	4929	0,9	DPR8EVX-9	2872	221	DPR8EIX-9	2202
Thruxton 900	865	04 -	DPR8EA-9	4929	0,9	DPR8EVX-9	2872	221	DPR8EIX-9	2202
Adventurer	885	96 -	DPR8EA-9	4929	0,9	DPR8EVX-9	2872	221	DPR8EIX-9	2202
Daytona 900	885	93 - 96	DPR8EA-9	4929	0,9	DPR8EVX-9	2872	221	DPR8EIX-9	2202
Legend TT	885	98 -	DPR9EA-9	5329	0,9	DPR9EVX-9	3854	222	DPR9EIX-9	5545
Daytona Super III	885	94 -	DPR8EA-9	4929	0,9	DPR8EVX-9	2872	221	DPR8EIX-9	2202
Speed Triple	885	94 - 96	DPR8EA-9	4929	0,9	DPR8EVX-9	2872	221	DPR8EIX-9	2202
Speed Triple T509	885	97 -	DPR8EA-9	4929	0,9	DPR8EVX-9	2872	221	DPR8EIX-9	2202
Speedmaster America	885		DPR8EA-9	4929	0,9	DPR8EVX-9	2872	221	DPR8EIX-9	2202
Sport	885	98 -	DPR8EA-9	4929	0,9	DPR8EVX-9	2872	221	DPR8EIX-9	2202
Sport Sprint 900	885	97 -	DPR8EA-9	4929	0,9	DPR8EVX-9	2872	221	DPR8EIX-9	2202
Sprint	885	95 -	DPR8EA-9	4929	0,9	DPR8EVX-9	2872	221	DPR8EIX-9	2202
Sprint 900	885	93 -	DPR8EA-9	4929	0,9	DPR8EVX-9	2872	221	DPR8EIX-9	2202
Sprint Executive	885	98 -	DPR8EA-9	4929	0,9	DPR8EVX-9	2872	221	DPR8EIX-9	2202
Sprint ST	885	99 -	DPR8EA-9	4929	0,9	DPR8EVX-9	2872	221	DPR8EIX-9	2202
Thunderbird (T309RT)	885	95 -	DPR8EA-9	4929	0,9	DPR8EVX-9	2872	221	DPR8EIX-9	2202
Thunderbird Sport	885	98 - 00	DPR8EA-9	4929	0,9	DPR8EVX-9	2872	221	DPR8EIX-9	2202
Tiger 900 T400	885	93 - 98	DPR8EA-9	4929	0,9	DPR8EVX-9	2872	221	DPR8EIX-9	2202
Tiger	885	99 -	DPR8EA-9	4929	0,9	DPR8EVX-9	2872	221	DPR8EIX-9	2202
Trident 900	885	91 -	DPR8EA-9	4929	0,9	DPR8EVX-9	2872	221	DPR8EIX-9	2202
Trophy 900	885	96 -	DPR8EA-9	4929	0,9	DPR8EVX-9	2872	221	DPR8EIX-9	2202
Trophy 900	885	91 - 95	DPR8EA-9	4929	0,9	DPR8EVX-9	2872	221	DPR8EIX-9	2202
Daytona 955i 72Kw	955	99 - 00	DPR8EA-9	4929	0,9	DPR8EVX-9	2872	221	DPR8EIX-9	2202
Daytona 955i 94Kw	955	99 - 01	DPR8EA-9	4929	0,9	DPR8EVX-9	2872	221	DPR8EIX-9	2202
Daytona 955i (595N)	955	02 -	CR9EK	4548	0,6			230	CR9EIX	3521
Daytona Centennial Edition (595N)	955	02 -	CR9EK	4548	0,6			230	CR9EIX	3521
Speed Triple (595N)	955	02 -	CR9EK	4548	0,6			230	CR9EIX	3521
Sprint ST (695AB)	955	02 -	CR9EK	4548	0,6			230	CR9EIX	3521
Sprint RS (695AC)	955	02 -	CR9EK	4548	0,6			230	CR9EIX	3521



Order No.



Platin Gold-Palladium

Order Quick No.

Iridium



Order No.

**TRIUMPH**

Tiger 955i 72Kw (709EN)	955	01 -	DPR8EA-9	4929	0,9	DPR8EVX-9	2872	221	DPR8EIX-9	2202
Daytona T595	956	97 -	DPR8EA-9	4929	0,9	DPR8EVX-9	2872	221	DPR8EIX-9	2202
Speed Triple	956	99 - 01	DPR8EA-9	4929	0,9	DPR8EVX-9	2872	221	DPR8EIX-9	2202
Sprint ST	956	99 - 01	DPR8EA-9	4929	0,9	DPR8EVX-9	2872	221	DPR8EIX-9	2202
Daytona 1000	1000	91 - 92	DPR8EA-9	4929	0,9	DPR8EVX-9	2872	221	DPR8EIX-9	2202
Speed Triple 1050	1050	05 -	CR9EK	4548	0,6			230	CR9EIX	3521
Sprint ST 1050	1050	05 -	CR9EK	4548	0,6			230	CR9EIX	3521
Tiger 1050	1050	06 -	CR9EK	4548	0,6			230	CR9EIX	3521
Trophy 1200 (T300E)	1180	96 -	DPR8EA-9	4929	0,9	DPR8EVX-9	2872	221	DPR8EIX-9	2202
Trophy 1200	1180	91 - 95	DPR8EA-9	4929	0,9	DPR8EVX-9	2872	221	DPR8EIX-9	2202
Daytona 1200	1200	93 -	DPR8EA-9	4929	0,9	DPR8EVX-9	2872	221	DPR8EIX-9	2202
Rocket III Classic Twinspark	2300	05.05 -	DPR8EA-9	4929	0,9	DPR8EVX-9	2872	221	DPR8EIX-9	2202
Rocket III Twinspark	2300	05.04 -	DPR8EA-9	4929	0,9	DPR8EVX-9	2872	221	DPR8EIX-9	2202

**URAL**

Deco Cruiser	648	98 -	BP4HS	3611	0,6					
Italia Cruiser	648	98 -	BP4HS	3611	0,6					
Solo Cruiser	648	98 -	BP4HS	3611	0,6					
Sportsman Classic	648	97 -	BP4HS	3611	0,6					
Tourist Classic	648	97 -	BP4HS	3611	0,6					
IMZ-10	650		BP4HS	3611	0,6					
IMZ-40	650		BP4HS	3611	0,6					
IMZ-50	650		BP4HS	3611	0,6					
Solo Single	650	94 - 96	BP4HS	3611	0,6					
Sportsman	650	94 - 96	BP4HS	3611	0,6					
Tourist Sidecar	650	94 - 96	BP4HS	3611	0,6					
Ural M3-8.103 23,6kW	650		BP5HS	4111	0,5					
Ural M3-8.123 26,5kW	650		BP6ES	7811	0,7	BP6EVX	5832		BPR6EIX	6637
Tourist	750		B7HS	5110	0,5	B7HVX	7836	204	BR7HIX	7067

**URAL AMERICA**

Bavarian Classic	650	99 -			0,7	BP8HVX	2855			
Deco Classic	650	99 -			0,7	BP8HVX	2855			
Deco Classic	650	97 - 98	BP7HS	5111	0,7	BP7HVX	7468		BPR7HIX	5944
Deco Cruiser	650	98 -	BP7HS	5111	0,7	BP7HVX	7468		BPR7HIX	5944
Italia Cruiser	650	94 - 97	BP7HS	5111	0,7	BP7HVX	7468		BPR7HIX	5944
Italia Cruiser II	650	98 -	BP7HS	5111	0,7	BP7HVX	7468		BPR7HIX	5944
Patrol Classic	650	99 -			0,7	BP8HVX	2855			
Solo Classic	650	99 -			0,7	BP8HVX	2855			
Solo Cruiser	650	98 -	BP7HS	5111	0,7	BP7HVX	7468		BPR7HIX	5944
Solo Single	650	94 - 97	BP7HS	5111	0,7	BP7HVX	7468		BPR7HIX	5944
Sportsman	650	94 - 96	BP7HS	5111	0,7	BP7HVX	7468		BPR7HIX	5944
Sportsman Classic	650	97 - 98	BP7HS	5111	0,7	BP7HVX	7468		BPR7HIX	5944
Tourist Classic	650	99 -			0,7	BP8HVX	2855			
Tourist Classic	650	97 - 98	BP7HS	5111	0,7	BP7HVX	7468		BPR7HIX	5944
Tourist Sidecar	650	94 - 97	BP7HS	5111	0,7	BP7HVX	7468		BPR7HIX	5944

**VALENTI**

CR 80W Cross (Yamaha/Valent)	80				0,5	B10EGV	5927			
------------------------------	----	--	--	--	-----	--------	------	--	--	--

**VELOSOLEX**

2200	50		B4H	4110	0,5					
------	----	--	-----	------	-----	--	--	--	--	--

Order  
No.Platin  
Gold-  
Palla-  
diumOrder Quick  
No. No.

Iridium

Order  
No.**VELOSOLEX**

3300 /3800	50		<b>B4H</b>	<b>4110</b>	0,5					
5000	50		<b>B4H</b>	<b>4110</b>	0,5					
6000	50		<b>B4H</b>	<b>4110</b>	0,5					
8000 / 8000 GS Ténor	50		<b>B6HS</b>	<b>4510</b>	0,6	<b>B6HVX</b>	<b>7435</b>	<b>203</b>	<b>BR6HIX</b>	<b>3419</b>
GL Ténor	50		<b>B6HS</b>	<b>4510</b>	0,6	<b>B6HVX</b>	<b>7435</b>	<b>203</b>	<b>BR6HIX</b>	<b>3419</b>
GR Ténor	50		<b>B6HS</b>	<b>4510</b>	0,6	<b>B6HVX</b>	<b>7435</b>	<b>203</b>	<b>BR6HIX</b>	<b>3419</b>
L / R / S Ténor	50		<b>B6ES</b>	<b>7310</b>	0,7	<b>B6EVX</b>	<b>5136</b>			
Micron	50		<b>B4H</b>	<b>4110</b>	0,5					
Pli-solex	50		<b>B4H</b>	<b>4110</b>	0,5					

**VERTEMATI**

E 450 E	503		<b>CR9EK</b>	<b>4548</b>	0,7			<b>230</b>	<b>CR9EIX</b>	<b>3521</b>
E 450	503		<b>CR9EK</b>	<b>4548</b>	0,7			<b>230</b>	<b>CR9EIX</b>	<b>3521</b>
E 501	503		<b>CR9EK</b>	<b>4548</b>	0,7			<b>230</b>	<b>CR9EIX</b>	<b>3521</b>
E 501 E	503		<b>CR9EK</b>	<b>4548</b>	0,7			<b>230</b>	<b>CR9EIX</b>	<b>3521</b>
E 570	503		<b>CR9EK</b>	<b>4548</b>	0,7			<b>230</b>	<b>CR9EIX</b>	<b>3521</b>
E 570 E	503		<b>CR9EK</b>	<b>4548</b>	0,7			<b>230</b>	<b>CR9EIX</b>	<b>3521</b>

**VICTORY**

8-Ball	1500	05 -	<b>CPR6EB-9</b>		0,9					
Classic Cruiser	1500	03 -	<b>CPR6EB-9</b>		0,9					
Cruiser	1500	02 -	<b>CPR6EB-9</b>		0,9					
Cruiser	1500	98 - 01	<b>DCPR6E</b>	<b>3481</b>	1,0					
Hammer	1500	05 -	<b>CPR6EB-9</b>		0,9					
Kingpin	1500	04 - 05	<b>CPR6EB-9</b>		0,9					
Kingpin Ness Signature	1500	05 -	<b>CPR6EB-9</b>		0,9					
Spezial Edition	1500	00 -	<b>DCPR6E</b>	<b>3481</b>	1,0					
Sport Cruiser	1500	00 - 01	<b>DCPR6E</b>	<b>3481</b>	1,0					
Standard Cruiser	1500	99 - 02	<b>DCPR6E</b>	<b>3481</b>	1,0					
Touring Cruiser	1500	00 - 01	<b>DCPR6E</b>	<b>3481</b>	1,0					
Touring Cruiser	1500	02 - 05	<b>CPR6EB-9</b>		0,9					
Vegas	1500	03 - 05	<b>CPR6EB-9</b>		0,9					
Vegas ANSS	1500	04 -	<b>CPR6EB-9</b>		0,9					
Vegas Ness Signature	1500	05 -	<b>CPR6EB-9</b>		0,9					
Hammer 100cu in Freedom	1634	06 -	<b>CPR6EB-9</b>		0,9					
Ness Signature Jackpot 100cu in Freedom	1634	06 -	<b>CPR6EB-9</b>		0,9					
Touring Cruiser 100cu in Freedom	1634	06 -	<b>CPR6EB-9</b>		0,9					
Vegas 100cu in Freedom	1634	06 -	<b>CPR6EB-9</b>		0,9					
Vegas 8-Ball 100cu in Freedom	1634	06 -	<b>CPR6EB-9</b>		0,9					
Vegas Jackpot 100cu in Freedom	1634	06 -	<b>CPR6EB-9</b>		0,9					

**VOR**

EN Enduro	400	00 -	<b>CR8EK</b>	<b>3478</b>	0,6				<b>CR8EIX</b>	<b>4218</b>
ENE	400	04 -	<b>CR8EK</b>	<b>3478</b>	0,6				<b>CR8EIX</b>	<b>4218</b>
EN-MAR	400	04 -	<b>CR8EK</b>	<b>3478</b>	0,6				<b>CR8EIX</b>	<b>4218</b>
MX Cross	400	00 -	<b>CR8EK</b>	<b>3478</b>	0,6				<b>CR8EIX</b>	<b>4218</b>
SM Super Moto	400	00 -	<b>CR8EK</b>	<b>3478</b>	0,6				<b>CR8EIX</b>	<b>4218</b>
SM Super Moto Competition	400	00 -	<b>CR8EK</b>	<b>3478</b>	0,6				<b>CR8EIX</b>	<b>4218</b>
EN Enduro	503	99 -	<b>CR8EK</b>	<b>3478</b>	0,6				<b>CR8EIX</b>	<b>4218</b>
MX Cross	503	99 -	<b>CR8EK</b>	<b>3478</b>	0,6				<b>CR8EIX</b>	<b>4218</b>
SM Super Moto	503	99 -	<b>CR8EK</b>	<b>3478</b>	0,6				<b>CR8EIX</b>	<b>4218</b>
SM Super Moto Competition	503	99 -	<b>CR8EK</b>	<b>3478</b>	0,6				<b>CR8EIX</b>	<b>4218</b>

Order  
No.Platin  
Gold-  
Palla-  
diumOrder Quick  
No. No.Order  
No.**VOR**

ENE	530	04 -	CR8EK	3478	0,6				CR8EIX	4218
EN-MAR	530	04 -	CR8EK	3478	0,6				CR8EIX	4218
Super Motard Com.	530	00 -	CR8EK	3478	0,6				CR8EIX	4218

**YAMAHA**

Golf Car G2A/G9A		92 -	B5ES	6410	0,7					
CA 50 (14T)	50	83 - 87	BPR6HS	7022	0,7	BPR6HVX	2740	214	BPR6HIX	4085
CE 50 E	50		BP6HS-10	6326	1,0					
CH 50	50		BPR7HS	6422	0,7	BPR7HVX	2938	215	BPR7HIX	5944
CR 50 Z/SS	50	93 -	BP7HS-10	7829	1,0					
CV 50	50		BPR6HS	7022	0,7	BPR6HVX	2740	214	BPR6HIX	4085
CW 50	50	91 - 93	BR7HS	4122	0,8			211	BR7HIX	7067
CW 50 (4BX)	50	94 -	BPR7HS	6422	0,7	BPR7HVX	2938	215	BPR7HIX	5944
CY 50	50	94 -	BP7HS	5111	0,7	BP7HVX	7468		BPR7HIX	5944
CY 50 E	50	93 -	BP7HS	5111	0,7	BP7HVX	7468		BPR7HIX	5944
CY 50 F	50	94 -	BPR7HS	6422	0,7	BPR7HVX	2938	215	BPR7HIX	5944
DT 50	50		B7HS	5110	0,8	B7HVX	7836	204	BR7HIX	7067
DT 50 / supermotard	50	03 -	BR9ES	5722	0,8	BR9EVX	1265	208	BR9EIX	3981
DT 50 A (F)	50		BR6HS	3922	0,7			209	BR6HIX	3419
DT 50 E	50	93 -	BR8ES	5422	0,7	BR8EVX	1262	207	BR8EIX	5044
DT 50 F	50	94 -	BR8ES	5422	0,8	BR8EVX	1262	207	BR8EIX	5044
DT 50 LC (3UN3/4/5/6/7)	50	93 -	BR8ES	5422	0,7	BR8EVX	1262	207	BR8EIX	5044
DT 50 M (2M4)	50	78 - 81	B6HS	4510	0,7	B6HVX	7435	203	BR6HIX	3419
DT 50 M (D)	50	86 -	BR7HS	4122	0,7			211	BR7HIX	7067
DT 50 M (NL)	50	86 -	B6HS	4510	0,7	B6HVX	7435	203	BR6HIX	3419
DT 50 M (S)	50	86 -	BR6HS	3922	0,7			209	BR6HIX	3419
DT 50 M (A) (B)	50	86 -	B8HS	5510	0,7	B8HVX	2634	205	BR8HIX	7001
DT 50 MX (1NN)	50	01.86-12.89	BR6HS	3922	0,7			209	BR6HIX	3419
DT 50 MX (4ER1)	50	92 -	BR7HS	4122	0,7			211	BR7HIX	7067
DT 50 MX (4ET1)	50	92 -	B6HS	4510	0,7	B6HVX	7435	203	BR6HIX	3419
DT 50 MX (3TG2)	50	92 -	BR6HS	3922	0,7			209	BR6HIX	3419
DT 50 R (3MN2)(3MN3)(3HL3)(4CT2) (4CT4)(4CT6)	50	91 -	BR7HS	4122	0,7			211	BR7HIX	7067
DT 50 R (5EC1)(5VB2)(5BK4)(5BK3)(5VB1)	50	97 -	CR8E	1275	0,7	CR8EVX	6487	226	CR8EIX	4218
DT 50 R (5BK1)(5BL1)	50	97 -	BR8ES	5422	0,8	BR8EVX	1262	207	BR8EIX	5044
DT 50 R (3MP2)(3MS2)(3MR2)(4AD2)(4JU1)	50	91 -	BR6HS	3922	0,7			209	BR6HIX	3419
DX 50 R (5BK2)	50	97 -	BR8ES	5422	0,8	BR8EVX	1262	207	BR8EIX	5044
DX 50 S (4CT3)(4CT5)(4CT7)	50	92 -	BR7HS	4122	0,7			211	BR7HIX	7067
ES 50	50		B8HS	5510	0,7	B8HVX	2634	205	BR8HIX	7001
Fizz (4RC)	50	95 -	BR8HS	4322	0,7	BR8HVX	6265	212	BR8HIX	7001
FS 1 DX (3F2)	50	79 - 80	BR6HS	3922	0,7			209	BR6HIX	3419
FS 1 E	50		B7HS	5110	0,6	B7HVX	7836	204	BR7HIX	7067
FS 3 M	50		B8HS	5510	0,7	B8HVX	2634	205	BR8HIX	7001
GT 50 B	50		B7HS	5110	0,7	B7HVX	7836	204	BR7HIX	7067
GT 50 D (FT1)	50	73 - 75	B7HS	5110	0,7	B7HVX	7836	204	BR7HIX	7067
Jog 50	50	90 -	BPR6HS	7022	0,7	BPR6HVX	2740	214	BPR6HIX	4085
LB 2	50		B7HS	5110	0,7	B7HVX	7836	204	BR7HIX	7067
LB 2 80	50	81 -	BP6HS	4511	0,7	BP6HVX	4635		BPR6HIX	4085
LB 2 80	50	80	B6HS	4510	0,7	B6HVX	7435	203	BR6HIX	3419
LB 2 M	50	81 -	BP6HS	4511	0,7	BP6HVX	4635		BPR6HIX	4085
LB 2 M (551)	50	75 - 80	B6HS	4510	0,7	B6HVX	7435	203	BR6HIX	3419
LB 3 80	50		B6HS	4510	0,7	B6HVX	7435	203	BR6HIX	3419

Order  
No.Platin  
Gold-  
Palla-  
diumOrder Quick  
No. No.

Iridium

Order  
No.**YAMAHA**

LB 3 M	50		BP6HS	4511	0,7	BP6HVX	4635		BPR6HIX	4085
LC 50	50		BP4HS	3611	0,7					
LC 50 H	50		BP4HS	3611	0,7					
LC 50 M	50		BP4HS	3611	0,7					
MA 50	50		BP4HS	3611	0,7					
MA 50 M	50		BP4HS	3611	0,7					
MBK Magnum	50	90 -	B8ES	2411	0,6	B8EVX	7051	201	BR8EIX	5044
MR 50	50		B7HS	5110	0,7	B7HVX	7836	204	BR7HIX	7067
MR 50 H	50		B7HS	5110	0,7	B7HVX	7836	204	BR7HIX	7067
PW 50 (3PT)	50	01.87 -	BP4HS	3611	0,6					
PW 50 E	50	93 -	BPR4HS	7823	0,8					
PW 50 H / F	50		BP4HS	3611	0,7					
QT 50	50		BP4HS	3611	0,7					
QT 50 H	50		BP4HS	3611	0,7					
RD 50 DX (353)	50	73 - 75	B8HS	5510	0,7	B8HVX	2634	205	BR8HIX	7001
RD 50 H	50		B7HS	5110	0,7	B7HVX	7836	204	BR7HIX	7067
RD 50 MX (2E0)	50	77 - 81	B6HS	4510	0,7	B6HVX	7435	203	BR6HIX	3419
SA 50	50		BP4HS	3611	0,7					
SA 50 H	50		BP4HS	3611	0,7					
SA 50 M	50		BP4HS	3611	0,7					
SG 50 (34N)	50	84 - 85	BPR6HS	7022	0,7	BPR6HVX	2740	214	BPR6HIX	4085
SH 50 / F	50		BPR6HS-10	2633	1,0					
SH 50 E / ED / MF	50	93 -	BP6HS-10	6326	1,0					
T 50	50		C6HSA	3228	0,7				CR6HIX	7274
TY 50 M (1G3)	50	77 - 80	B6HS	4510	0,7	B6HVX	7435	203	BR6HIX	3419
TZR 50	50	03 -	BR9ES	5722	0,8	BR9EVX	1265	208	BR9EIX	3981
V 50	50		B6HS	4510	0,6	B6HVX	7435	203	BR6HIX	3419
V 50 D	50	93 -	B7HS	5110	0,7	B7HVX	7836	204	BR7HIX	7067
V 50 E	50		B7HS	5110	0,7	B7HVX	7836	204	BR7HIX	7067
V 50 M	50	81 - 83	BP6HS	4511	0,7	BP6HVX	4635		BPR6HIX	4085
V 50 M	50	- 80	B6HS	4510	0,7	B6HVX	7435	203	BR6HIX	3419
V 50 M	50	84 -	BR6ES	4922	0,8					
YA 50 (5AK)	50	97 -	BR7HS	4122	0,7			211	BR7HIX	7067
YB 50 S	50		B7HS	5110	0,7	B7HVX	7836	204	BR7HIX	7067
YE 50	50	93 -	BR7HS	4122	0,7			211	BR7HIX	7067
YZ 50	50		B9ES	2611	0,8	B9EVX	7254	202	BR9EIX	3981
YZ 50 H	50		B9ES	2611	0,8	B9EVX	7254	202	BR9EIX	3981
RD 60 B	60		B7HS	5110	0,7	B7HVX	7836	204	BR7HIX	7067
YB 60	60		B7HS	5110	0,7	B7HVX	7836	204	BR7HIX	7067
YZ 60 H	60		B8ES	2411	0,8	B8EVX	7051	201	BR8EIX	5044
CW 65	65	94 -	BR7HS	4122	0,7			211	BR7HIX	7067
Active 80	80	90 -	BPR7HS	6422	0,7	BPR7HVX	2938	215	BPR7HIX	5944
CH 80	80		BR7HS	4122	0,7			211	BR7HIX	7067
CV 80	80		BPR7HS	6422	0,7	BPR7HVX	2938	215	BPR7HIX	5944
DT 80 LC-I (37A)	80	83 - 86	BR8ES	5422	0,8	BR8EVX	1262	207	BR8EIX	5044
DT 80 LC-II (53V)	80	84 -	BR9ES	5722	0,8	BR9EVX	1265	208	BR9EIX	3981
DT 80 MX (5J1)	80	81 - 84	B8HS	5510	0,7	B8HVX	2634	205	BR8HIX	7001
DT 80 MX-S (5T8)	80	83 - 86	BR8HS	4322	0,7	BR8HVX	6265	212	BR8HIX	7001
FS 80	80		B7HS	5110	0,7	B7HVX	7836	204	BR7HIX	7067
FS 80 SE (5A7)	80	81 - 82	B7HS	5110	0,7	B7HVX	7836	204	BR7HIX	7067
GT 80 (477)	80	74 - 75	B7HS	5110	0,7	B7HVX	7836	204	BR7HIX	7067
GT 80 D	80		B7HS	5110	0,7	B7HVX	7836	204	BR7HIX	7067

Order  
No.Platin  
Gold-  
Palla-  
diumOrder Quick  
No. No.Order  
No.**YAMAHA**

GT 80 E	80		B7HS	5110	0,7	B7HVX	7836	204	BR7HIX	7067
LB 80	80		BP6HS	4511	0,7	BP6HVX	4635		BPR6HIX	4085
LB 80 2A	80		B6HS	4510	0,7	B6HVX	7435	203	BR6HIX	3419
LB 80 2AC	80		B6HS	4510	0,7	B6HVX	7435	203	BR6HIX	3419
LB 80 2AD	80		B6HS	4510	0,7	B6HVX	7435	203	BR6HIX	3419
LB 80 2H	80		B6HS	4510	0,7	B6HVX	7435	203	BR6HIX	3419
LB 80 2HD	80		B7HS	5110	0,7	B7HVX	7836	204	BR7HIX	7067
LB 80 3 (1M9)	80	78 - 79	B6HS	4510	0,7	B6HVX	7435	203	BR6HIX	3419
LB 80 3D	80		B6HS	4510	0,7	B6HVX	7435	203	BR6HIX	3419
MX 80	80		B7HS	5110	0,7	B7HVX	7836	204	BR7HIX	7067
MX 80 H	80		B7HS	5110	0,7	B7HVX	7836	204	BR7HIX	7067
PW 80 (21W)	80	83 - 90	BPR6HS	7022	0,7	BPR6HVX	2740	214	BPR6HIX	4085
PW 80 E / F (4BC..)	80	93 -	BP6HS	4511	0,7	BP6HVX	4635		BPR6HIX	4085
RD 80 LC-II (30W)	80	83 - 87	BR8ES	5422	0,8	BR8EVX	1262	207	BR8EIX	5044
RD 80 MX (5G1)	80	81 - 82	B8HS	5510	0,7	B8HVX	2634	205	BR8HIX	7001
RX 80 SE (12N)	80	82 - 83	B8HS	5510	0,7	B8HVX	2634	205	BR8HIX	7001
T 80	80		CR7HS	7223	0,7				CR7HIX	7544
TY 80	80		B7HS	5110	0,7	B7HVX	7836	204	BR7HIX	7067
V 80	80		BP6HS	4511	0,7	BP6HVX	4635		BPR6HIX	4085
V 80 H / D	80		BP6HS	4511	0,7	BP6HVX	4635		BPR6HIX	4085
Y 80	80		BP6HS	4511	0,7	BP6HVX	4635		BPR6HIX	4085
Y 80 E	80		BP6HS	4511	0,7	BP6HVX	4635		BPR6HIX	4085
YB 80	80		B7HS	5110	0,7	B7HVX	7836	204	BR7HIX	7067
YE 80 (4MU)	80	94 -	BR7HS	4122	0,7			211	BR7HIX	7067
YZ 80	80	84 - 85	B9EG	3530	0,6	B9EGV	5827		BR9EIX	3981
YZ 80 (4GT)	80	95 -	B10EG	3630	0,7	B10EGV	5927			
YZ 80 (1LR)	80	86 -	BR9EG	3230	0,6	BR9EVX	1265		BR9EIX	3981
YZ 80 B	80		B8HS	5510	0,7	B8HVX	2634	205	BR8HIX	7001
YZ 80 C	80		B8ES	2411	0,8	B8EVX	7051	201	BR8EIX	5044
YZ 80 D	80		B8ES	2411	0,8	B8EVX	7051	201	BR8EIX	5044
YZ 80 E	80	- 92	B8ES	2411	0,8	B8EVX	7051	201	BR8EIX	5044
YZ 80 E / F/LW(4LB)/ LWF	80	93 -	B10EG	3630	0,6	B10EGV	5927			
YZ 80 H	80	- 83	B8ES	2411	0,8	B8EVX	7051	201	BR8EIX	5044
YZ 80 H.R.	80		B7HS	5110	0,7	B7HVX	7836	204	BR7HIX	7067
YZ 80 L.R.	80		B8ES	2411	0,8	B8EVX	7051	201	BR8EIX	5044
YA 90 E / F	90	93 -	BR7HS	4122	0,7			211	BR7HIX	7067
AG 100	100		B7HS	5110	0,7	B7HVX	7836	204	BR7HIX	7067
AG 100 H / E / F	100		B7ES	1111	0,8	B7EVX	6934			
DT 100	100		B7ES	1111	0,8	B7EVX	6934			
DT 100 B	100		B8HS	5510	0,7	B8HVX	2634	205	BR8HIX	7001
DT 100 C	100		B7ES	1111	0,8	B7EVX	6934			
DT 100 D	100		B8ES	2411	0,8	B8EVX	7051	201	BR8EIX	5044
DT 100 E	100		B8ES	2411	0,8	B8EVX	7051	201	BR8EIX	5044
DT 100 H	100		B8ES	2411	0,8	B8EVX	7051	201	BR8EIX	5044
DT 100 SD	100		B8ES	2411	0,8	B8EVX	7051	201	BR8EIX	5044
DT 100 X	100		B7ES	1111	0,8	B7EVX	6934			
DX 100	100		B7HS	5110	0,7	B7HVX	7836	204	BR7HIX	7067
DX 100 H	100		B7HS	5110	0,7	B7HVX	7836	204	BR7HIX	7067
MX 100	100	79 -	B7ES	1111	0,8	B7EVX	6934			
MX 100 B	100				0,6	B8EVX	7051		BR8EIX	5044
MX 100 H	100		B7ES	1111	0,8	B7EVX	6934			
RS 100 B	100		B8HS	5510	0,7	B8HVX	2634	205	BR8HIX	7001



Order  
No.Gold-  
Palla-  
dium

Platin

Order  
No.Quick  
No.

Iridium

Order  
No.**YAMAHA**

RS 100 DX (1Y8)	100	76 - 81	B8HS	5510	0,7	B8HVX	2634	205	BR8HIX	7001
RS 100 P	100		BP6HS	4511	0,7	BP6HVX	4635		BPR6HIX	4085
RS 100 S	100		B8HS	5510	0,7	B8HVX	2634	205	BR8HIX	7001
RS 100 X	100		B8HS	5510	0,7	B8HVX	2634	205	BR8HIX	7001
RT 100 E / F	100	93 -	B7ES	1111	0,8	B7EVX	6934			
RX 100 12,7mm	100		B8HS	5510	0,7	B8HVX	2634	205	BR8HIX	7001
RX 100 19,0mm	100		B8ES	2411	0,8	B8EVX	7051	201	BR8EIX	5044
RXS 100	100		BR8HS	4322	0,7	BR8HVX	6265	212	BR8HIX	7001
RX-ZD	100	93 -	BP8ES	2912	0,8	BP8EVX	2671			
V 100/E/S/SH	100	93 -	BP7HS-10	7829	1,0					
YB 100	100	94 -	BP6HS	4511	0,7	BP6HVX	4635		BPR6HIX	4085
YB 100 M	100		B8HS	5510	0,7	B8HVX	2634	205	BR8HIX	7001
YB 100 P	100		B7HS	5110	0,7	B7HVX	7836	204	BR7HIX	7067
YZ 100	100	- 83	B10EG	3630	0,6	B10EGV	5927			
YZ 100 E	100		B10EG	3630	0,6	B10EGV	5927			
YZ 100 H	100		B10EG	3630	0,6	B10EGV	5927			
V 110 E	110	93 -	BP7HS-10	7829	1,0					
RX 115	115	93 -	BP8HS	2630	0,7				BPR8HIX	6742
V 120 JR / ZR	120	94 -	BP8ES	2912	0,8	BP8EVX	2671			
BL 125 (50W)	125	85 - 89	BPR8HS	3725	0,7				BPR8HIX	6742
DT 125	125	94 -	B8ES	2411	0,8	B8EVX	7051	201	BR8EIX	5044
DT 125 RE	125	04 -	BR8ES	5422	0,8	BR8EVX	1262	207	BR8EIX	5044
DT 125 E (1G0)	125	77 - 79	BR9ES	5722	0,8	BR9EVX	1265	208	BR9EIX	3981
DT 125 E (AT2)	125	73 - 76	B8ES	2411	0,8	B8EVX	7051	201	BR8EIX	5044
DT 125 ED	125		B8ES	2411	0,8	B8EVX	7051	201	BR8EIX	5044
DT 125 F	125		B8ES	2411	0,8	B8EVX	7051	201	BR8EIX	5044
DT 125 H	125		B8ES	2411	0,8	B8EVX	7051	201	BR8EIX	5044
DT 125 LC	125	86 -	BR9ES	5722	0,8	BR9EVX	1265	208	BR9EIX	3981
DT 125 LC (10V)	125	82 - 85	BR8ES	5422	0,8	BR8EVX	1262	207	BR8EIX	5044
DT 125 MX	125		B8ES	2411	0,8	B8EVX	7051	201	BR8EIX	5044
DT 125 R (4BL) / RE (3RM)	125	91 -	BR9ES	5722	0,8	BR9EVX	1265	208	BR9EIX	3981
DT 125 Tenere (I)	125		B9ES	2611	0,8	B9EVX	7254	202	BR9EIX	3981
DT 125 X	125	05 -	BR8ES	5422	0,5	BR8EVX	1262	207	BR8EIX	5044
IT 125	125		B9EG	3530	0,6	B9EGV	5827		BR9EIX	3981
IT 125 H	125		B9EG	3530	0,6	B9EGV	5827		BR9EIX	3981
MX 125	125				0,6	B9EVX	7254		BR9EIX	3981
R 125 SE	125		BP7HS	5111	0,7	BP7HVX	7468		BPR7HIX	5944
RD 125 12,7mm	125		B8HS	5510	0,7	B8HVX	2634	205	BR8HIX	7001
RD 125 19,0mm	125		B8ES	2411	0,8	B8EVX	7051	201	BR8EIX	5044
RD 125 C	125		B8ES	2411	0,8	B8EVX	7051	201	BR8EIX	5044
RD 125 C-DX	125		B8ES	2411	0,8	B8EVX	7051	201	BR8EIX	5044
RD 125 D	125		B8ES	2411	0,8	B8EVX	7051	201	BR8EIX	5044
RD 125 D-DX (AS3)	125	73 - 75	B8HS	5510	0,7	B8HVX	2634	205	BR8HIX	7001
RD 125 LC	125	84 -	BR8ES	5422	0,8	BR8EVX	1262	207	BR8EIX	5044
RD 125 LC (10W)	125	82 - 83	BR9ES	5722	0,8	BR9EVX	1265	208	BR9EIX	3981
RS 125 DX	125		B8HS	5510	0,7	B8HVX	2634	205	BR8HIX	7001
RS 125 E	125		B7HS	5110	0,7	B7HVX	7836	204	BR7HIX	7067
RS 125 P	125		BP7HS	5111	0,7	BP7HVX	7468		BPR7HIX	5944
RS 125 Z	125		B8HS	5510	0,7	B8HVX	2634	205	BR8HIX	7001
RX 125 12,7mm	125		B8HS	5510	0,7	B8HVX	2634	205	BR8HIX	7001
RX 125 19,0mm	125		B8ES	2411	0,8	B8EVX	7051	201	BR8EIX	5044
RX 125 H	125		B7HS	5110	0,7	B7HVX	7836	204	BR7HIX	7067

Order  
No.Platin  
Gold-  
Palla-  
diumOrder  
No.Quick  
No.

Iridium

Order  
No.**YAMAHA**

SR 125	125		D8EA	2120	0,7	D8EVX	2850	216	DR8EIX	6681
SR 125 (10F)	125	97 -	DR8EA	7162	0,7	DR8EVX	6354		DR8EIX	6681
SR 125 Z	125	93 -	DR8EA	7162	0,7	DR8EVX	6354		DR8EIX	6681
TA 125 (400)	125	73 - 75	B10EG	3630	0,6	B10EGV	5927			
TA 125 A	125		B10EG	3630	0,6	B10EGV	5927			
TDR 125 (4GW)	125	92 -	BR9ES	5722	0,9	BR9EVX	1265	208	BR9EIX	3981
TDR 125 (5AN)	125	97 -	BR8ES	5422	0,8	BR8EVX	1262	207	BR8EIX	5044
TW 125 (DE011/012)	125	99 -	DR8EA	7162	0,6	DR8EVX	6354		DR8EIX	6681
TY 125 (1K6)	125	77 - 81	B7ES	1111	0,7	B7EVX	6934			
TZ 125 (4JT)	125	95 -	R7376-10	4457	0,6					
TZ 125 (3V3)	125	80 -			0,6	B10EVX	7335		BR10EIX	6801
TZ 125 / F	125	94 -	R7376-10	4457	0,6					
TZ 125 H	125				0,6	B10EVX	7335		BR10EIX	6801
TZR 125	125	- 92	BR9ES	5722	0,8	BR9EVX	1265	208	BR9EIX	3981
TZR 125	125	93 -	BR9ECM	3252	0,8	BR9ECMVX	2434			
XT 125	125		D8EA	2120	0,7	D8EVX	2850	216	DR8EIX	6681
XT 125 R	125	05 -	CR7HSA	4549	0,8				CR7HIX	7544
XT 125 X	125	05 -	CR7HSA	4549	0,8				CR7HIX	7544
XV 125 (5AJ)	125	97 -	CR6HSA	2983	0,6				CR6HIX	7274
XV 125 S Virago( 5AJ)	125	99 -	CR6HSA	2983	0,6				CR6HIX	7274
XVS 125 (VP05)	125	00 -	CR7HSA	4549	0,6				CR7HIX	7544
YB 125	125		B7HS	5110	0,7	B7HVX	7836	204	BR7HIX	7067
YBR 125	125	05 - 06	CR6HSA	2983	0,7				CR6HIX	7274
YBR 125 Einspritzer / Injection	125	07 -	CR6HSA	2983	0,7				CR6HIX	7274
YS 125	125				0,6	B9EVX	7254		BR9EIX	3981
YZ 125	125		B9EG	3530	0,6	B9EGV	5827		BR9EIX	3981
YZ 125 B	125		B9EG	3530	0,6	B9EGV	5827		BR9EIX	3981
YZ 125 C	125		B9EG	3530	0,6	B9EGV	5827		BR9EIX	3981
YZ 125 E	125		B9EG	3530	0,6	B9EGV	5827		BR9EIX	3981
YZ 125 E / E1 / F	125	93 -	BR9EG	3230	0,6	BR9EVX	1265		BR9EIX	3981
YZ 125 H	125		B9EG	3530	0,6	B9EGV	5827		BR9EIX	3981
YZ 125 X	125		B9EG	3530	0,6	B9EGV	5827		BR9EIX	3981
FZ 150	150	94 -	C7HSA	4629	0,7	C7HVX	4533		CR7HIX	7544
FZR 150	150	94 -	C7HSA	4629	0,7	C7HVX	4533		CR7HIX	7544
RX 150	150	93 -	BP8ES	2912	0,8	BP8EVX	2671			
SR 150	150	93 -	D8EA	2120	0,7	D8EVX	2850	216	DR8EIX	6681
DT 165 R	165	91 -	BR8ES	5422	0,8	BR8EVX	1262	207	BR8EIX	5044
AG 175	175		B8ES	2411	0,8	B8EVX	7051	201	BR8EIX	5044
AG 175 H	175		B7ES	1111	0,8	B7EVX	6934			
DT 175 (CT1)	175	74 - 75	B8ES	2411	0,8	B8EVX	7051	201	BR8EIX	5044
DT 175 E / F	175		B8ES	2411	0,8	B8EVX	7051	201	BR8EIX	5044
DT 175 H	175		B9ES	2611	0,8	B9EVX	7254	202	BR9EIX	3981
DT 175 MX (2K4)	175	09.78 -12.81	B8ES	2411	0,8	B8EVX	7051	201	BR8EIX	5044
IT 175 (5Y0)	175	83 - 84	B9EG	3530	0,6	B9EGV	5827		BR9EIX	3981
IT 175 E	175				0,6	B10EVX	7335		BR10EIX	6801
IT 175 H	175		B9EG	3530	0,6	B9EGV	5827		BR9EIX	3981
MX 175	175		B8ES	2411	0,8	B8EVX	7051	201	BR8EIX	5044
MX 175 B	175				0,6	B8EVX	7051		BR8EIX	5044
MX 175 H	175		B8ES	2411	0,8	B8EVX	7051	201	BR8EIX	5044
TY 175	175		B7ES	1111	0,8	B7EVX	6934			
TY 175 E	175		B7ES	1111	0,8	B7EVX	6934			
TY 175 J	175		B7ES	1111	0,8	B7EVX	6934			

Order  
No.Gold-  
Palla-  
dium

Platin

Order  
No.Quick  
No.

Iridium

Order  
No.**YAMAHA**

YZ 175	175				0,6	B10EVX	7335		BR10EIX	6801
RT 180 E	180	93 -	B8ES	2411	0,8	B8EVX	7051	201	BR8EIX	5044
XC 180 (32H)	180	83 - 84	DPR8EA-9	4929	0,9	DPR8EVX-9	2872	221	DPR8EIX-9	2202
SH 185 H	185		D7EA	7912	0,7	D7EVX	2734			
RS 195	195		B7ES	1111	0,8	B7EVX	6934			
AG 200 E / F	200	93 -	D8EA	2120	0,7	D8EVX	2850	216	DR8EIX	6681
BW 200	200		D8EA	2120	0,7	D8EVX	2850	216	DR8EIX	6681
DT 200 LC / RE / RF	200	93 -	BR9ES	5722	0,8	BR9EVX	1265	208	BR9EIX	3981
DT 200 R	200		BR9ES	5722	0,8	BR9EVX	1265	208	BR9EIX	3981
IT 200 S	200		BR9EG	3230	0,6	BR9EVX	1265		BR9EIX	3981
NR 200	200		B7ES	1111	0,8	B7EVX	6934			
RD 200 12,7mm	200		B7HS	5110	0,7	B7HVX	7836	204	BR7HIX	7067
RD 200 19,0mm (397)	200		B7ES	1111	0,7	B7EVX	6934			
RD 200 C	200		B8ES	2411	0,8	B8EVX	7051	201	BR8EIX	5044
RD 200 C-DX	200		B8ES	2411	0,8	B8EVX	7051	201	BR8EIX	5044
RD 200 D	200		B8ES	2411	0,8	B8EVX	7051	201	BR8EIX	5044
RD 200 D-DX (1E8)	200	77 - 80	B8ES	2411	0,8	B8EVX	7051	201	BR8EIX	5044
RS 200	200		B8ES	2411	0,8	B8EVX	7051	201	BR8EIX	5044
TW 200	200	01.87 -	DR8EA	7162	0,7	DR8EVX	6354		DR8EIX	6681
TW 200 E / EC / F	200	93 -	DR8EA	7162	0,7	DR8EVX	6354		DR8EIX	6681
TW 200 FC	200	94 -	D8EA	2120	0,7	D8EVX	2850	216	DR8EIX	6681
WR 200 R / RE / RF	200	93 -	BR9ES	5722	0,8	BR9EVX	1265	208	BR9EIX	3981
XT 225 E / EC / F / FC	225	93 -	DR8EA	7162	0,7	DR8EVX	6354		DR8EIX	6681
TDR 240	240		BR9ES	5722	0,8	BR9EVX	1265	208	BR9EIX	3981
XV 240	240		CR6HS	7023	0,7			223	CR6HIX	7274
DT 250 (512)	250	75 - 76	B8ES	2411	0,8	B8EVX	7051	201	BR8EIX	5044
DT 250 E	250		B8ES	2411	0,8	B8EVX	7051	201	BR8EIX	5044
DT 250 H	250		B8ES	2411	0,8	B8EVX	7051	201	BR8EIX	5044
DT 250 MX (1R7)	250	77 - 81	B8ES	2411	0,8	B8EVX	7051	201	BR8EIX	5044
IT 250 (45J)	250	85 -	B9EG	3530	0,6	B9EGV	5827		BR9EIX	3981
IT 250 (4V5)	250	81 -	B8EG	3430	0,6	B8EGV	5627			
IT 250 J	250		B9EG	3530	0,6	B9EGV	5827		BR9EIX	3981
IT 250 K	250		B9EG	3530	0,6	B9EGV	5827		BR9EIX	3981
IT 250 N	250		BR9EG	3230	0,6	BR9EVX	1265		BR9EIX	3981
MX 250	250				0,6	B8EVX	7051		BR8EIX	5044
R1-Z	250	93 -	BR9ES	5722	0,8	BR9EVX	1265	208	BR9EIX	3981
RD 250 (522)	250	75 -	B8ES	2411	0,8	B8EVX	7051	201	BR8EIX	5044
RD 250 D	250		B8ES	2411	0,8	B8EVX	7051	201	BR8EIX	5044
RD 250 LC (4L1)	250	80 - 83	B8ES	2411	0,8	B8EVX	7051	201	BR8EIX	5044
SE 250 (I)	250		BPR7ES	2023	0,8	BPR7EVX	5565		BPR7EIX	4055
SR 250 (I)	250		BPR7ES	2023	0,8	BPR7EVX	5565		BPR7EIX	4055
SR 250 H / F	250		BP7ES	2412	0,8	BP7EVX	7270	206	BPR7EIX	4055
SR 250 SE (3Y8)	250	80 - 82	BP7ES	2412	0,8	BP7EVX	7270	206	BPR7EIX	4055
SR 250 TH	250		BP7ES	2412	0,8	BP7EVX	7270	206	BPR7EIX	4055
TDR 250 (3CK)	250	88 - 89	BR9ES	5722	0,8	BR9EVX	1265	208	BR9EIX	3981
TRD 250 (I)	250		BR9ES	5722	0,7	BR9EVX	1265	208	BR9EIX	3981
Tricker XG 250	250	05 -	DR7EA	7839	0,7					
TT 250	250		D8EA	2120	0,7	D8EVX	2850	216	DR8EIX	6681
TT 250 R / RF	250	94 -	CR9E	6263	0,7	CR9EVX	5943	227	CR9EIX	3521
TY 250 (38V)	250	84 - 87	BR6ES	4922	0,8					
TY 250 (3BA)	250	88 - 90	B7ES	1111	0,8	B7EVX	6934			
TY 250 (S16)	250	75 - 79	B7ES	1111	0,8	B7EVX	6934			

Order  
No.Platin  
Gold-  
Palla-  
diumOrder Quick  
No. No.Order  
No.**YAMAHA**

TY 250 Z (4GG)	250	94 - 96			0,6	BP6EVX	5832		BPR6EIX	6637
TZ 250	250	84 -	B10EG	3630	0,5	B10EGV	5927			
TZ 250	250	83			0,6	B10EVX	7335		BR10EIX	6801
TZ 250 (4DP)	250	95 -	R6179A-105P	2697	0,6					
TZ 250 / F	250	94 -	R6179A-105P	2697	0,6					
TZ 250 E	250	83			0,6	B10EVX	7335		BR10EIX	6801
TZ 250 E/E1	250	93 -	R5184-105	3334	0,6					
TZ 250 H	250	83			0,6	B10EVX	7335		BR10EIX	6801
TZR 250 " V2"	250	91 - 95	BR9ECM	3252	0,6	BR9ECMVX	2434			
TZR 250 (2MA)	250	87 - 89	BR9ES	5722	0,8	BR9EVX	1265	208	BR9EIX	3981
TZR 250R/RS/RSP	250	93 -	BR9ECM	3252	0,8	BR9ECMVX	2434			
WR 250 F	250	01 -	CR8E	1275	0,7	CR8EVX	6487	226	CR8EIX	4218
WR 250 F	250	03 -	CR8E	1275	0,7	CR8EVX	6487	226	CR8EIX	4218
WR 250 Z / ZE / ZF (4JW)	250	93 -	B8EG	3430	0,6	B8EGV	5627			
XS 250 (1V5)	250	78 - 79	BP7ES	2412	0,8	BP7EVX	7270	206	BPR7EIX	4055
XS 250 C	250		BP7ES	2412	0,8	BP7EVX	7270	206	BPR7EIX	4055
XS 250 H	250		BP7ES	2412	0,8	BP7EVX	7270	206	BPR7EIX	4055
XS 250 RH	250	- 83	BP7ES	2412	0,8	BP7EVX	7270	206	BPR7EIX	4055
XS 250 SE	250		BP7ES	2412	0,8	BP7EVX	7270	206	BPR7EIX	4055
XS 250 SH	250		BP7ES	2412	0,8	BP7EVX	7270	206	BPR7EIX	4055
XT 250 (3Y3)	250	80 - 82	DR8ESL	2923	0,6	DR8EVX	6354	218	DR8EIX	6681
XT 250 H	250	- 84	BP7ES	2412	0,8	BP7EVX	7270	206	BPR7EIX	4055
XV 250	250	94 -	CR6HSA	2983	0,7				CR6HIX	7274
XV 250 (3LS,3LW)	250	89 -	CR6HS	7023	0,7			223	CR6HIX	7274
XV 250 F	250	94 -	C6HSA	3228	0,7				CR6HIX	7274
XV 250 S (3LW)	250	95 -	CR6HS	7023	0,8			223	CR6HIX	7274
XVS 250 (VG031)	250	01 -	CR6HS	7023	0,7			223	CR6HIX	7274
YZ 250 (4MX)	250	95 -	B8EG	3430	0,7	B8EGV	5627			
YZ 250 (2VM,3JE,3SP,3XK)	250	88 - 91	B8EG	3430	0,6	B8EGV	5627			
YZ 250 (39X,56A,1LU,2HH)	250	84 - 87	B8EG	3430	0,6	B8EGV	5627			
YZ 250 (4DA,4EW)	250	92 -	B8EG	3430	0,6	B8EGV	5627			
YZ 250 (5X5,24Y)	250	82 - 83	B9EG	3530	0,6	B9EGV	5827		BR9EIX	3981
YZ 250 F	250	94 -	B8EG	3430	0,6	B8EGV	5627			
YZ 250 F (CG10C)	250	01 -	CR8E	1275	0,7	CR8EVX	6487	226	CR8EIX	4218
XVZ 13 (3JS)	300	89 - 92	DPR8EA-9	4929	0,9	DPR8EVX-9	2872	221	DPR8EIX-9	2202
BW 350	350		DR8ESL	2923	0,9	DR8EVX	6354	218	DR8EIX	6681
RD 350	350	87 -	BR9ES	5722	0,8	BR9EVX	1265	208	BR9EIX	3981
RD 350 12,7mm	350		B8HS	5510	0,7	B8HVX	2634	205	BR8HIX	7001
RD 350 19,0mm	350		B8ES	2411	0,8	B8EVX	7051	201	BR8EIX	5044
RD 350 C	350		B8ES	2411	0,8	B8EVX	7051	201	BR8EIX	5044
RD 350 H 12,7mm (351)	350	73 - 74	B8HS	5510	0,7	B8HVX	2634	205	BR8HIX	7001
RD 350 H 19,0mm (521)	350	75 -	B8ES	2411	0,8	B8EVX	7051	201	BR8EIX	5044
RD 350 J	350		B8ES	2411	0,8	B8EVX	7051	201	BR8EIX	5044
RD 350 LC	350	- 85	BR8ES	5422	0,8	BR8EVX	1262	207	BR8EIX	5044
RD 350 LC (1WX,1WW)	350	86 - 89	BR9ES	5722	0,8	BR9EVX	1265	208	BR9EIX	3981
RD 350 LCF	350	86 -	BR9ES	5722	0,8	BR9EVX	1265	208	BR9EIX	3981
TT 350 (1TJ)	350	86 - 89	D8EA	2120	0,7	D8EVX	2850	216	DR8EIX	6681
TT 350 E / F	350	93 -	D8EA	2120	0,7	D8EVX	2850	216	DR8EIX	6681
TZ 350 B	350		B10EG	3630	0,6	B10EGV	5927			
TZ 350 H	350		B10EG	3630	0,6	B10EGV	5927			
XT 350 (3YT)	350	91 -	DR8ESL	2923	0,6	DR8EVX	6354	218	DR8EIX	6681
XT 350 (55V)	350	85 - 90	DR8ESL	2923	0,7	DR8EVX	6354	218	DR8EIX	6681

Order  
No.Platin  
Gold-  
Palla-  
diumOrder Quick  
No. No.

Iridium

Order  
No.**YAMAHA**

XT 350 E / F	350	93 -	D8EA	2120	0,7	D8EVX	2850	216	DR8EIX	6681
DT 360 (RT2)	360	01.73 -12.75	B9ES	2611	0,8	B9EVX	7254	202	BR9EIX	3981
MX 360	360				0,6	B8EVX	7051		BR8EIX	5044
XS 360 (1V4)	360	01.77 -12.78	BP6ES	7811	0,8	BP6EVX	5832		BPR6EIX	6637
YZ 360	360				0,6	B8EVX	7051		BR8EIX	5044
DT 400 (513)	400	11.75 -12.76	B8ES	2411	0,8	B8EVX	7051	201	BR8EIX	5044
DT 400 E	400		B9ES	2611	0,8	B9EVX	7254	202	BR9EIX	3981
DT 400 H	400		B8ES	2411	0,8	B8EVX	7051	201	BR8EIX	5044
DT 400 MX (1R6)	400	77 - 80	B8ES	2411	0,8	B8EVX	7051	201	BR8EIX	5044
FZR 400	400	04.87 -	CR8E	1275	0,7	CR8EVX	6487	226	CR8EIX	4218
IT 400	400		B8ES	2411	0,8	B8EVX	7051	201	BR8EIX	5044
IT 400 E	400				0,6	B8EVX	7051		BR8EIX	5044
MX 400	400				0,6	B8EVX	7051		BR8EIX	5044
RD 400 (1A3)	400	76 - 79	B8ES	2411	0,8	B8EVX	7051	201	BR8EIX	5044
RD 400 E	400		B8ES	2411	0,8	B8EVX	7051	201	BR8EIX	5044
SR 400	400		BP7ES	2412	0,8	BP7EVX	7270	206	BPR7EIX	4055
TT 400 C	400				0,6	B8EVX	7051		BR8EIX	5044
WR 400 F	400	98 -	CR8E	1275	0,7	CR8EVX	6487	226	CR8EIX	4218
XJ 400	400		D8EA	2120	0,7	D8EVX	2850	216	DR8EIX	6681
XS 400 (12E)	400	82 - 89	DR8ESL	2923	0,7	DR8EVX	6354	218	DR8EIX	6681
XS 400 (2A2)	400	78 - 82	BP7ES	2412	0,8	BP7EVX	7270	206	BPR7EIX	4055
XS 400 SE (465)	400	80 - 82	BP7ES	2412	0,8	BP7EVX	7270	206	BPR7EIX	4055
XT 400	400	84 -	DR7ES	3123	0,7					
XT 400	400	- 83	BP7ES	2412	0,8	BP7EVX	7270	206	BPR7EIX	4055
XV 400 SE	400		BPR7ES	2023	0,8	BPR7EVX	5565		BPR7EIX	4055
YP 400 Majesty	400	05 -	CR7E	4578	0,6			225	CR7EIX	7385
YZ 400	400				0,6	B8EVX	7051		BR8EIX	5044
YZ 400 C	400				0,6	B8EVX	7051		BR8EIX	5044
YZ 400 E	400				0,6	B8EVX	7051		BR8EIX	5044
YZ 400 F	400	12.97 -	CR8E	1275	0,7	CR8EVX	6487	226	CR8EIX	4218
IT 425	425		B8ES	2411	0,8	B8EVX	7051	201	BR8EIX	5044
WR 426 F (CJ02W)	426	01 -	CR8E	1275	0,7	CR8EVX	6487	226	CR8EIX	4218
YZF 426 F	426	01 -	CR8E	1275	0,6	CR8EVX	6487	226	CR8EIX	4218
WR 450 F (5TJ6)	450	03 -	CR8E	1275	0,7	CR8EVX	6487	226	CR8EIX	4218
YZ 450 F	450	03 -	CR8E	1275	0,7	CR8EVX	6487	226	CR8EIX	4218
IT 465 (4V6)	465	81 -	B8ES	2411	0,8	B8EVX	7051	201	BR8EIX	5044
IT 465 H	465		B8ES	2411	0,8	B8EVX	7051	201	BR8EIX	5044
YZ 465	465		B8ES	2411	0,8	B8EVX	7051	201	BR8EIX	5044
YZ 465 H	465		B8ES	2411	0,8	B8EVX	7051	201	BR8EIX	5044
IT 490 (29W)	490	83 - 85	BR8ES	5422	0,6	BR8EVX	1262	207	BR8EIX	5044
YZ 490	490		BR9EG	3230	0,6	BR9EVX	1265		BR9EIX	3981
IT 500	500		BP7ES	2412	0,7	BP7EVX	7270	206	BPR7EIX	4055
MX 500	500				0,6	B8EVX	7051		BR8EIX	5044
RD 500 LC (1GE)	500	85 - 86	BR9HS	4522	0,7					
RD 500 LC (47X)	500	84	BR9HS	4522	0,7					
SR 500 (3EB)	500	95 -	BPR7ES	2023	0,6	BPR7EVX	5565		BPR7EIX	4055
SR 500 (2J4,48T)	500	01.79 - 96	BP7ES	2412	0,8	BP7EVX	7270	206	BPR7EIX	4055
SR 500 (48T)	500	97 -	BPR7ES	2023	0,8	BPR7EVX	5565		BPR7EIX	4055
SR 500 E	500		BP7ES	2412	0,8	BP7EVX	7270	206	BPR7EIX	4055
SR 500 H	500		BP7ES	2412	0,8	BP7EVX	7270	206	BPR7EIX	4055
TT 500 (1T1)	500	78 - 79	BP7ES	2412	0,8	BP7EVX	7270	206	BPR7EIX	4055
TT 500 C	500		BP7ES	2412	0,8	BP7EVX	7270	206	BPR7EIX	4055

Order  
No.Platin  
Gold-  
Palla-  
diumOrder  
No.Quick  
No.

Iridium

Order  
No.**YAMAHA**

TT 500 E	500		BP7ES	2412	0,8	BP7EVX	7270	206	BPR7EIX	4055
TT 500 H	500		BP7ES	2412	0,8	BP7EVX	7270	206	BPR7EIX	4055
TZ 500	500				0,6	B10EVX	7335		BR10EIX	6801
TZ 500 H	500				0,6	B10EVX	7335		BR10EIX	6801
XJ 500	500		D8EA	2120	0,7	D8EVX	2850	216	DR8EIX	6681
XS 500 (1H2)	500	77 - 79	D8EA	2120	0,7	D8EVX	2850	216	DR8EIX	6681
XS 500 E	500		D8EA	2120	0,7	D8EVX	2850	216	DR8EIX	6681
XT 500 (1E6,1V6)	500	76 - 89	BP7ES	2412	0,8	BP7EVX	7270	206	BPR7EIX	4055
XT 500 C	500		BP7ES	2412	0,8	BP7EVX	7270	206	BPR7EIX	4055
XT 500 E	500	93 -	DPR8EA-9	4929	0,9	DPR8EVX-9	2872	221	DPR8EIX-9	2202
XT 500 E	500	- 92	BP7ES	2412	0,8	BP7EVX	7270	206	BPR7EIX	4055
XT 500 H	500		BP7ES	2412	0,8	BP7EVX	7270	206	BPR7EIX	4055
XT 500 T	500		DPR8EA-9	4929	0,9	DPR8EVX-9	2872	221	DPR8EIX-9	2202
XT 500 Z	500		DPR8EA-9	4929	0,9	DPR8EVX-9	2872	221	DPR8EIX-9	2202
XV 500 (I)	500		BPR7ES	2023	0,8	BPR7EVX	5565		BPR7EIX	4055
XV 500 SE (26R)	500	83 - 87	BPR7ES	2023	0,8	BPR7EVX	5565		BPR7EIX	4055
YP 500 Tmax ABS	500	05 -	CR7E	4578	0,6			225	CR7EIX	7385
XV 535 DX (H) VJ011 32kW	535	00 -	BPR6ES	7822	0,8	BPR6EVX	6764		BPR6EIX	6637
XV 535 DX (N) VJ012 25kW	535	00 -	BPR6ES	7822	0,8	BPR6EVX	6764		BPR6EIX	6637
XV 535 (2YL,3BR)	535	88 - 96	BPR7ES	2023	0,8	BPR7EVX	5565		BPR7EIX	4055
XV 535 (4KU / 4MC)	535	95 -	BPR7ES	2023	0,8	BPR7EVX	5565		BPR7EIX	4055
XV 535 S / SP (2YL,3BR)	535	93 - 96	BPR7ES	2023	0,8	BPR7EVX	5565		BPR7EIX	4055
XV 535 /S(h) (2YL)	535	97 - 99	BPR6ES	7822	0,8	BPR6EVX	6764		BPR6EIX	6637
XV 535 /S(n) (3BR)	535	97 - 99	BPR6ES	7822	0,8	BPR6EVX	6764		BPR6EIX	6637
YV 535 FC	535	94 -	BP7ES	2412	0,8	BP7EVX	7270	206	BPR7EIX	4055
XJ 550 (4V8)	550	81 - 83	D8EA	2120	0,6	D8EVX	2850	216	DR8EIX	6681
XJ 550 H	550		D8EA	2120	0,6	D8EVX	2850	216	DR8EIX	6681
XJ 550 RH	550		D8EA	2120	0,6	D8EVX	2850	216	DR8EIX	6681
XT 550 (5Y3)	550	82 - 83	DR7ES	3123	0,6					
XZ 550 (11V)	550	82 - 84	DR8ESL	2923	0,6	DR8EVX	6354	218	DR8EIX	6681
XZ 550 S (11V)	550	83 - 84	DR8ESL	2923	0,7	DR8EVX	6354	218	DR8EIX	6681
FZ 6 Fazer / -S2	600	04 -	CR9EK	4548	0,7			230	CR9EIX	3521
FZ 600,-U	600		DR8ESL	2923	0,7	DR8EVX	6354	218	DR8EIX	6681
FZR 600 (3HE,3RG,3RH)	600	89 - 93	CR9E	6263	0,7	CR9EVX	5943	227	CR9EIX	3521
FZR 600 F / R / RF / RFC	600	94 -	CR9E	6263	0,7	CR9EVX	5943	227	CR9EIX	3521
FZR 600 R (4JH) 72kW	600	94 -	CR9E	6263	0,7	CR9EVX	5943	227	CR9EIX	3521
FZR 600 R (4MH) 25kW	600	94 -	CR9E	6263	0,7	CR9EVX	5943	227	CR9EIX	3521
FZS 600 Fazer (RJ021)(5DM)	600	98 - 02	CR9E	6263	0,7	CR9EVX	5943	227	CR9EIX	3521
FZS 600 Fazer (RJ022)	600	98 - 02	CR8E	1275	0,7	CR8EVX	6487	226	CR8EIX	4218
FZS 600 Fazer	600	03 - 04	CR9EK	4548	0,7			230	CR9EIX	3521
SRX 600 (1XM,1XN)	600	86 - 89	DPR7EA-9	5129	0,9	DPR7EVX-9	7682	220	DPR7EIX-9	7803
TT 600	600	86 -	DPR7EA-9	5129	0,9	DPR7EVX-9	7682	220	DPR7EIX-9	7803
TT 600 RE (DJ012)	600	03 -	DPR8EA-9	4929	0,9	DPR8EVX-9	2872	221	DPR8EIX-9	2202
TT 600 (36A)	600	83 - 85	D7EA	7912	0,6	D7EVX	2734			
TT 600 E (4LW)	600	93 -	DPR8EA-9	4929	0,9	DPR8EVX-9	2872	221	DPR8EIX-9	2202
TT 600 R (DJ011)	600	98 -	DPR9EA-9	5329	0,9	DPR9EVX-9	3854	222	DPR9EIX-9	5545
TT 600 S (4LW)	600	93 -	DPR8EA-9	4929	0,9	DPR8EVX-9	2872	221	DPR8EIX-9	2202
TT 600 S (59X) (I)	600	85 - 89	DPR7EA-9	5129	0,9	DPR7EVX-9	7682	220	DPR7EIX-9	7803
XJ 600 (51J,3KM,3KN)	600	84 - 90	DR8ESL	2923	0,7	DR8EVX	6354	218	DR8EIX	6681
XJ 600 N (4KA)	600	95 -	CR8E	1275	0,6	CR8EVX	6487	226	CR8EIX	4218
XJ 600 N (4MB)	600	95 -	CR8E	1275	0,6	CR8EVX	6487	226	CR8EIX	4218
XJ 600 N (h) (4BR)	600	97 -	CR8E	1275	0,6	CR8EVX	6487	226	CR8EIX	4218

Order  
No.Platin  
Gold-  
Palla-  
diumOrder  
No.Quick  
No.

Iridium

Order  
No.**YAMAHA**

XJ 600 N (n) (4LX)	600	97 -	CR7E	4578	0,6			225	CR7EIX	7385
XJ 600 S (4EB / 4LX)	600	95 - 96	CR8E	1275	0,6	CR8EVX	6487	226	CR8EIX	4218
XJ 600 S (4BR,4BRA,4BRB)	600	91 - 96	CR8E	1275	0,7	CR8EVX	6487	226	CR8EIX	4218
XJ 600 S (h) (4BR)(1R..)	600	97 -	CR8E	1275	0,6	CR8EVX	6487	226	CR8EIX	4218
XJ 600 S (n) (4LX)	600	97 -	CR7E	4578	0,7			225	CR7EIX	7385
XJ 600 S / N (4LX)	600	94 - 96	CR9E	6263	0,7	CR9EVX	5943	227	CR9EIX	3521
XT 600 (2KF,2NF)	600	87 - 90	DPR8EA-9	4929	0,9	DPR8EVX-9	2872	221	DPR8EIX-9	2202
XT 600 (43F)	600	84 - 87	DR7ES	3123	0,6					
XT 600 E (4PT / 4SK)	600	95 -	DPR8EA-9	4929	0,9	DPR8EVX-9	2872	221	DPR8EIX-9	2202
XT 600 E / EF / EFC	600	94 -	DPR8EA-9	4929	0,9	DPR8EVX-9	2872	221	DPR8EIX-9	2202
XT 600 E(h) (3TB)	600	97 -	DPR8EA-9	4929	0,9	DPR8EVX-9	2872	221	DPR8EIX-9	2202
XT 600 E(n) (3UW)	600	97 -	DPR8EA-9	4929	0,9	DPR8EVX-9	2872	221	DPR8EIX-9	2202
XT 600 E/K (3TB/3UW)	600	90 - 94	DPR8EA-9	4929	0,9	DPR8EVX-9	2872	221	DPR8EIX-9	2202
XT 600 S	600	86 - 86	DPR8EA-9	4929	0,9	DPR8EVX-9	2872	221	DPR8EIX-9	2202
XT 600 Z (34L,55W)	600	83 - 85	DR7ES	3123	0,6					
XT 600 Z Tenere (1VJ,3AJ)	600	86 -	DPR7EA-9	5129	0,9	DPR7EVX-9	7682	220	DPR7EIX-9	7803
YX 600	600		DR8ESL	2923	0,7	DR8EVX	6354	218	DR8EIX	6681
YZF 600 R (4WD)	600	96 -	CR9E	6263	0,8	CR9EVX	5943	227	CR9EIX	3521
YZF 600 R (4TV)	600	96 -	CR9E	6263	0,8	CR9EVX	5943	227	CR9EIX	3521
YZF-R6	600	06 -	CR10EK	2360	0,6				CR10EIX	6482
YZF-R6 (RJ031/032)	600	99 -	CR10EK	2360	0,6				CR10EIX	6482
YZF-R6 / S	600	03 - 05	CR10EK	2360	0,6				CR10EIX	6482
Drag Star (4VR/4XR)	650	97 -	DPR7EA-9	5129	0,9	DPR7EVX-9	7682	220	DPR7EIX-9	7803
TS 650	650		B8ES	2411	0,6	B8EVX	7051	201	BR8EIX	5044
XJ 650 (4K0)	650	80 - 83	BP7ES	2412	0,7	BP7EVX	7270	206	BPR7EIX	4055
XJ 650 H	650		BP7ES	2412	0,7	BP7EVX	7270	206	BPR7EIX	4055
XJ 650 LH	650		BP7ES	2412	0,7	BP7EVX	7270	206	BPR7EIX	4055
XJ 650 SH	650		BP7ES	2412	0,7	BP7EVX	7270	206	BPR7EIX	4055
XJ 650 T (Turbo) (11T)	650	82 -	BPR8ES	3923	0,7	BPR8EVX	5573	213		
XS 650 (447)	650	76 - 83	BP8ES	2912	0,7	BP8EVX	2671			
XS 650 (I)	650		BP7ES	2412	0,7	BP7EVX	7270	206	BPR7EIX	4055
XS 650 E	650		BP7ES	2412	0,7	BP7EVX	7270	206	BPR7EIX	4055
XS 650 H	650		BP7ES	2412	0,7	BP7EVX	7270	206	BPR7EIX	4055
XS 650 II	650		BP7ES	2412	0,7	BP7EVX	7270	206	BPR7EIX	4055
XS 650 S	650		BP7ES	2412	0,7	BP7EVX	7270	206	BPR7EIX	4055
XS 650 SE (3L1)	650	79 - 81	BP7ES	2412	0,7	BP7EVX	7270	206	BPR7EIX	4055
XS 650 SH	650		BP7ES	2412	0,7	BP7EVX	7270	206	BPR7EIX	4055
XVS 650 (4VR)	650	97 -	DPR7EA-9	5129	0,9	DPR7EVX-9	7682	220	DPR7EIX-9	7803
XVS 650 Drag Star Classic (VM022)	650	98 -	DPR7EA-9	5129	0,9	DPR7EVX-9	7682	220	DPR7EIX-9	7803
XVS 650 Drag Star Classic (VM025)	650	98 -	DPR7EA-9	5129	0,9	DPR7EVX-9	7682	220	DPR7EIX-9	7803
XVS 650 (4XR)	650	97 -	DPR7EA-9	5129	0,9	DPR7EVX-9	7682	220	DPR7EIX-9	7803
MT 03	660	06 -	CR7E	4578	0,6			225	CR7EIX	7385
SZR 660 (4SU)	660	96 - 96	DPR9EA-9	5329	0,9	DPR9EVX-9	3854	222	DPR9EIX-9	5545
SZR 660 (4SU)	660	97 -	DPR8EA-9	4929	0,9	DPR8EVX-9	2872	221	DPR8EIX-9	2202
XT 660 R	660	04 -	CR7E	4578	0,6			225	CR7EIX	7385
XT 660 X	660	04 -	CR7E	4578	0,6			225	CR7EIX	7385
XTZ 660 (4MD)	660	94 -	DR8EA	7162	0,9	DR8EVX	6354		DR8EIX	6681
XTZ 660 (3YF)	660	97 -	DPR8EA-9	4929	0,9	DPR8EVX-9	2872	221	DPR8EIX-9	2202
XTZ 660 (3YF)	660	91 - 93	DPR9EA-9	5329	0,9	DPR9EVX-9	3854	222	DPR9EIX-9	5545
750 Laguna Seca (11M)	750	82 -	BP7ES	2412	0,7	BP7EVX	7270	206	BPR7EIX	4055
FZ 750 (1FN)	750	85 - 86	DR8ESL	2923	0,7	DR8EVX	6354	218	DR8EIX	6681
FZ 750 (3KT)	750	91 -	DR8ESL	2923	0,6	DR8EVX	6354	218	DR8EIX	6681

Order  
No.Platin  
Gold-  
Palla-  
diumOrder Quick  
No. No.Order  
No.**YAMAHA**

FZ 750 Genesis (2KK)	750	87 - 90	DR8ESL	2923	0,6	DR8EVX	6354	218	DR8EIX	6681
FZR 750 R (3PJ,3CV)	750	88 - 92	DR8EA	7162	0,7	DR8EVX	6354		DR8EIX	6681
FZX 750 (2JE)	750	87 - 89	DR8ESL	2923	0,6	DR8EVX	6354	218	DR8EIX	6681
FZX 750 Phaser (I)	750		DR8ESL	2923	0,7	DR8EVX	6354	218	DR8EIX	6681
TZ 750	750		B10EG	3630	0,5	B10EGV	5927			
TZ 750 D	750				0,6	B10EVX	7335		BR10EIX	6801
XJ 750	750	- 83	B7ES	1111	0,7	B7EVX	6934			
XJ 750 (41Y)	750	84 - 85	BPR8ES	3923	0,7	BPR8EVX	5573	213		
XJ 750 RH	750		B7ES	1111	0,7	B7EVX	6934			
XS 750 (1T5)	750	77 - 79	B7ES	1111	0,7	B7EVX	6934			
XS 750 C	750		B7ES	1111	0,7	B7EVX	6934			
XS 750 D	750		B7ES	1111	0,7	B7EVX	6934			
XS 750 E	750		B7ES	1111	0,7	B7EVX	6934			
XS 750 S	750		B7ES	1111	0,7	B7EVX	6934			
XS 750 SE	750		B7ES	1111	0,7	B7EVX	6934			
XS 750 T	750		B7ES	1111	0,7	B7EVX	6934			
XTS 750 SE	750		B7ES	1111	0,7	B7EVX	6934			
XTZ 750 (3LD, 3WM)	750	89 -	DPR8EA-9	4929	0,9	DPR8EVX-9	2872	221	DPR8EIX-9	2202
XV 750	750	- 83	B7ES	1111	0,7	B7EVX	6934			
XV 750 (4PW)	750	95 -	BPR7ES	2023	0,8	BPR7EVX	5565		BPR7EIX	4055
XV 750 / F / FC	750	84 -	BPR7ES	2023	0,7	BPR7EVX	5565		BPR7EIX	4055
XV 750 SE (5G5)	750	81 - 82	B7ES	1111	0,7	B7EVX	6934			
XV 750 SE (I)	750		BP7ES	2412	0,7	BP7EVX	7270	206	BPR7EIX	4055
YZF 750 SP / SPF (4HT)	750	93 -	CR9E	6263	0,8	CR9EVX	5943	227	CR9EIX	3521
YZF-R7 (RM011)	750	01 -	R-0256R-10	7641	1,0					
TDM 850 (4TX)	850	96 - 96	DPR9EA-9	5329	0,9	DPR9EVX-9	3854	222	DPR9EIX-9	5545
TDM 850 (3VD)	850	97 -	DPR8EA-9	4929	0,9	DPR8EVX-9	2872	221	DPR8EIX-9	2202
TDM 850 (4TX)	850	97 -	DPR8EA-9	4929	0,9	DPR8EVX-9	2872	221	DPR8EIX-9	2202
TDM 850 / F (3VD)	850	91 - 95	DPR8EA-9	4929	0,9	DPR8EVX-9	2872	221	DPR8EIX-9	2202
TRX 850	850	95 - 95	DPR8EA-9	4929	0,9	DPR8EVX-9	2872	221	DPR8EIX-9	2202
TRX 850 (4UN)	850	96 - 96	DPR9EA-9	5329	0,9	DPR9EVX-9	3854	222	DPR9EIX-9	5545
TRX 850 (4UN)	850	97 -	DPR8EA-9	4929	0,9	DPR8EVX-9	2872	221	DPR8EIX-9	2202
XS 850 (4E2)	850	80 - 81	BP7ES	2412	0,7	BP7EVX	7270	206	BPR7EIX	4055
XS 850 H	850		BP7ES	2412	0,7	BP7EVX	7270	206	BPR7EIX	4055
XS 850 LH	850		BP7ES	2412	0,7	BP7EVX	7270	206	BPR7EIX	4055
XS 850 SH	850		BP7ES	2412	0,7	BP7EVX	7270	206	BPR7EIX	4055
TDM 900	900	02 -	DPR8EA-9	4929	0,9	DPR8EVX-9	2872	221	DPR8EIX-9	2202
XJ 900 (31A)	900	83 - 84	BPR8ES	3923	0,7	BPR8EVX	5573	213		
XJ 900 (4BB)	900	91 -	BPR8ES	3923	0,7	BPR8EVX	5573	213		
XJ 900 (58L)	900	85 - 90	BPR8ES	3923	0,7	BPR8EVX	5573	213		
XJ 900 S (4KM)	900	95 -	DPR8EA-9	4929	0,9	DPR8EVX-9	2872	221	DPR8EIX-9	2202
XV 920 RH	920		BP7ES	2412	0,7	BP7EVX	7270	206	BPR7EIX	4055
FZ 1	1000	06 -	CR9EK	4548	0,7			230	CR9EIX	3521
FZ 1 Fazer	1000	06 -	CR9EK	4548	0,7			230	CR9EIX	3521
FZR 1000 / FC (3LE)	1000	94 -	DR8EA	7162	0,7	DR8EVX	6354		DR8EIX	6681
FZR 1000 EXUP (I)	1000		DR8ESL	2923	0,7	DR8EVX	6354	218	DR8EIX	6681
FZR 1000 F	1000	94 -	DP8EA-9	5829	0,9	DPR8EVX-9	2872		DPR8EIX-9	2202
FZR 1000 / U	1000		DR8ESL	2923	0,7	DR8EVX	6354	218	DR8EIX	6681
FZS 1000 Fazer(RN064)	1000	01 -	CR9E	6263	0,7	CR9EVX	5943	227	CR9EIX	3521
GTS 1000 (4BH)	1000	92 -	DPR8EA-9	4929	0,9	DPR8EVX-9	2872	221	DPR8EIX-9	2202
GTS 1000 A / AF / AFC (4BH)	1000	92 -	DPR8EA-9	4929	0,9	DPR8EVX-9	2872	221	DPR8EIX-9	2202
TR1 (578)	1000	81 - 82	BPR7ES	2023	0,7	BPR7EVX	5565		BPR7EIX	4055



Order  
No.Platin  
Gold-  
Palla-  
diumOrder Quick  
No. No.

Iridium

Order  
No.**YAMAHA**

XV 1000 / F / FC	1000		BPR7ES	2023	0,7	BPR7EVX	5565		BPR7EIX	4055
XV 1000 SE (23W,2AE)	1000	83 - 88	BPR7ES	2023	0,7	BPR7EVX	5565		BPR7EIX	4055
XV 1000 SH	1000		BPR7ES	2023	0,7	BPR7EVX	5565		BPR7EIX	4055
YZF R1 (RN012)(RN04)	1000	98 - 01	CR9E	6263	0,7	CR9EVX	5943	227	CR9EIX	3521
YZF R1 (5PW1; 5PW2)	1000	02 - 03							CR9EIA-9	6289
YZF 1000 R (4VD)	1000	96 - 02	DR8EA	7162	0,7	DR8EVX	6354		DR8EIX	6681
YZF-R1 / SP	1000	04 -	CR9EK	4548	0,7			230	CR9EIX	3521
YZF-R1	1000	07 -	CR9EK	4548	0,7			230	CR9EIX	3521
BT 1100 Bulldog	1100	02 -	BPR7ES	2023	0,6	BPR7EVX	5565		BPR7EIX	4055
FJ 1100 (47E)	1100	84 - 85	DPR8EA-9	4929	0,9	DPR8EVX-9	2872	221	DPR8EIX-9	2202
XS 1100 (2H9)	1100	78 - 82	BP6ES	7811	0,7	BP6EVX	5832		BPR6EIX	6637
XS 1100 E	1100		BP6ES	7811	0,7	BP6EVX	5832		BPR6EIX	6637
XS 1100 H	1100		BP6ES	7811	0,7	BP6EVX	5832		BPR6EIX	6637
XS 1100 LH	1100		BP6ES	7811	0,7	BP6EVX	5832		BPR6EIX	6637
XS 1100 RH	1100		BP6ES	7811	0,7	BP6EVX	5832		BPR6EIX	6637
XS 1100 S (5K7)	1100	81 - 82	BP6ES	7811	0,7	BP6EVX	5832		BPR6EIX	6637
XS 1100 SH	1100		BP6ES	7811	0,7	BP6EVX	5832		BPR6EIX	6637
XV 1100 (3LP)	1100	95 -	BPR7ES	2023	0,8	BPR7EVX	5565		BPR7EIX	4055
XV 1100 SC	1100		BPR7ES	2023	0,8	BPR7EVX	5565		BPR7EIX	4055
XVS 1100 Drag Star (VP05)	1100	99 -	BPR7ES	2023	0,7	BPR7EVX	5565		BPR7EIX	4055
FJ 1200 (1XJ)	1200	86 - 87	DPR8EA-9	4929	0,9	DPR8EVX-9	2872	221	DPR8EIX-9	2202
FJ 1200 (3CW)	1200	88 - 90	DPR8EA-9	4929	0,9	DPR8EVX-9	2872	221	DPR8EIX-9	2202
FJ 1200 (3YA)	1200	91 -	DPR8EA-9	4929	0,9	DPR8EVX-9	2872	221	DPR8EIX-9	2202
FJ 1200 AE/ AEC / E / F	1200	93 -	DP8EA-9	5829	0,9	DPR8EVX-9	2872		DPR8EIX-9	2202
Vmax 1200 (2EN)	1200	97 -	DPR8EA-9	4929	0,9	DPR8EVX-9	2872	221	DPR8EIX-9	2202
Vmax 1200 / F / FC	1200		DPR8EA-9	4929	0,9	DPR8EVX-9	2872	221	DPR8EIX-9	2202
XJR 1200 (4PU)	1200	95 -	DPR8EA-9	4929	0,9	DPR8EVX-9	2872	221	DPR8EIX-9	2202
XJR 1200 (4PU)	1200	97 -	DPR8EA-9	4929	0,9	DPR8EVX-9	2872	221	DPR8EIX-9	2202
XVZ 1200 TD	1200		DPR8EA-9	4929	0,9	DPR8EVX-9	2872	221	DPR8EIX-9	2202
XVZ 12T (47G)	1200	84 - 87	DPR8EA-9	4929	0,9	DPR8EVX-9	2872	221	DPR8EIX-9	2202
FJR 1300	1300	01 -	CR8E	1275	0,7	CR8EVX	6487	226	CR8EIX	4218
FJR 1300 A	1300	03 -	CR8E	1275	0,7	CR8EVX	6487	226	CR8EIX	4218
Royal Star(4YP)	1300	97 -	DPR7EA-9	5129	0,9	DPR7EVX-9	7682	220	DPR7EIX-9	7803
XJR 1300	1300	98 -	DPR8EA-9	4929	0,9	DPR8EVX-9	2872	221	DPR8EIX-9	2202
XJR 1300 (RP022)	1300	99 -	DPR8EA-9	4929	0,9	DPR8EVX-9	2872	221	DPR8EIX-9	2202
XJR 1300 Einspritzer / Injection	1300	07 -	DPR8EA-9	4929	0,9	DPR8EVX-9	2872	221	DPR8EIX-9	2202
XJR 1300 SP (RP022)	1300	99 -	DPR8EA-9	4929	0,9	DPR8EVX-9	2872	221	DPR8EIX-9	2202
XVS 1300 A	1300	07 -	LMAR7A-9							
XVZ 13 A (4NK)	1300	97 -	DPR7EA-9	5129	0,9	DPR7EVX-9	7682	220	DPR7EIX-9	7803
XVZ 13 A (4YP)	1300	97 -	DPR7EA-9	5129	0,9	DPR7EVX-9	7682	220	DPR7EIX-9	7803
XVZ 13DE	1300	93 -	DPR8EA-9	4929	0,9	DPR8EVX-9	2872	221	DPR8EIX-9	2202
XV 1600 Wild Star (VP981)	1600	03.99 -	DPR7EA-9	5129	0,9	DPR7EVX-9	7682	220	DPR7EIX-9	7803
MT-01	1670	05 -	DPR7EA-9	5129	0,9	DPR7EVX-9	7682	220	DPR7EIX-9	7803
XU 1700 Road Star Warrior	1670	03 -	DPR7EA-9	5129	0,9	DPR7EVX-9	7682	220	DPR7EIX-9	7803
XV 1900	1900	06 -	DPR8EA-9	4929	0,9	DPR8EVX-9	2872	221	DPR8EIX-9	2202

**ZID**

Sova 175	175	93 -	BP7HS	5111	0,6	BP7HVX	7468		BPR7HIX	5944
Woshod 124.000-01-900 7,7kW	175		BP7HS	5111	0,7	BP7HVX	7468		BPR7HIX	5944
Woshod 144.000-01-900 9,9kW	175		BP7HS	5111	0,7	BP7HVX	7468		BPR7HIX	5944
Woshod 128.000-01-900 10,3kW	175		BP7HS	5111	0,7	BP7HVX	7468		BPR7HIX	5944
Zid-200 3Dk5.104 11,1kW	197		BP7HS	5111	0,7	BP7HVX	7468		BPR7HIX	5944

Order  
No.Platin  
Gold-  
Palla-  
diumOrder Quick  
No. No.Order  
No.**ZID**

Fermer	3DK5.904	9,6kW	197		BP7HS	5111	0,7	BP7HVX	7468		BPR7HIX	5944
Sova		11kW	200		BP7HS	5111	0,7	BP7HVX	7468		BPR7HIX	5944

**ZÜNDAPP**

Automatic Mofa			50		B5HS	4210	0,5					
Automatic Moped			50		B6HS	4510	0,6	B6HVX	7435	203	BR6HIX	3419
C 50 Sport			50		B6HS	4510	0,6	B6HVX	7435	203	BR6HIX	3419
C 50 Super			50		B6HS	4510	0,6	B6HVX	7435	203	BR6HIX	3419
Combinette			50		B6HS	4510	0,6	B6HVX	7435	203	BR6HIX	3419
CS 50			50		BP5ES	6511	0,7	BP5EVX	5470		BPR5EIX	6597
CS25			50		BP5ES	6511	0,7	BP5EVX	5470		BPR5EIX	6597
GTS 50 (5 Gang)			50		BP5ES	6511	0,7	BP5EVX	5470		BPR5EIX	6597
GTS 50 Super			50		B6HS	4510	0,6	B6HVX	7435	203	BR6HIX	3419
Hai 25			50		BP5ES	6511	0,7	BP5EVX	5470		BPR5EIX	6597
Hai 50			50		BP6ES	7811	0,6	BP6EVX	5832		BPR6EIX	6637
High Riser 44			50		BP5HS	4111	0,5					
KS 50 12.7 mm Gewindelänge			50		B7HS	5110	0,5	B7HVX	7836	204	BR7HIX	7067
KS 50 19.0 mm Gewindelänge			50		B7ES	1111	0,5	B7EVX	6934			
KS 50 Cross / Sport 517			50		B8HS	5510	0,5	B8HVX	2634	205	BR8HIX	7001
KS 50 Sport / Super Sport			50		B8HS	5510	0,5	B8HVX	2634	205	BR8HIX	7001
KS 50 TT/WK			50		B9ES	2611	0,5	B9EVX	7254	202	BR9EIX	3981
M 50, Moped-Automatic, Mofa 25			50		B5HS	4210	0,5					
R 50, Sport-Comb, Super Comb			50		B6HS	4510	0,6	B6HVX	7435	203	BR6HIX	3419
RS 50 Super			50		B7HS	5110	0,5	B7HVX	7836	204	BR7HIX	7067
ZA 25, ZB 22, ZD 10/20/25TS			50		B5HS	4210	0,5					
ZA 40, ZD 80/40, ZR 30			50		B6HS	4510	0,6	B6HVX	7435	203	BR6HIX	3419
ZD 50TS, ZR10/20, ZX25			50		B5HS	4210	0,5					
ZL 25			50		BP5ES	6511	0,7	BP5EVX	5470		BPR5EIX	6597
KS 75			75		B8HS	5510	0,5	B8HVX	2634	205	BR8HIX	7001
K 80			80		B8ES	2411	0,5	B8EVX	7051	201	BR8EIX	5044
KS 80			80		B8ES	2411	0,5	B8EVX	7051	201	BR8EIX	5044
KS 80 Super			80		B8ES	2411	0,5	B8EVX	7051	201	BR8EIX	5044
KS 80 Touring			80		B8ES	2411	0,5	B8EVX	7051	201	BR8EIX	5044
100 ISDT			100		B8HS	5510	0,5	B8HVX	2634	205	BR8HIX	7001
100 Scrambler			100		B8HS	5510	0,5	B8HVX	2634	205	BR8HIX	7001
KS 100			100		B8HS	5510	0,5	B8HVX	2634	205	BR8HIX	7001
KS 125			125		B8HS	5510	0,5	B8HVX	2634	205	BR8HIX	7001
KS 125 GS			125		B8HS	5510	0,5	B8HVX	2634	205	BR8HIX	7001
KS 125 MC			125		B8HS	5510	0,5	B8HVX	2634	205	BR8HIX	7001
KS 175			175		B8ES	2411	0,5	B8EVX	7051	201	BR8EIX	5044
KS 350			350		B8ES	2411	0,5	B8EVX	7051	201	BR8EIX	5044
KS 600			600	38 -	BP6HS	4511	0,6	BP6HVX	4635		BPR6HIX	4085
KS 601			600		BP7HS	5111	0,5	BP7HVX	7468		BPR7HIX	5944



Order No.



Gold-Palladium

Platin



Order No.

Quick No.

Iridium



Order No.

**APRILIA**

Amico 25 (MK)	25	96 -	BR7HS	4122	0,5			211	BR7HIX	7067
Amico GL (HV)	50		BR7HS	4122	0,5			211	BR7HIX	7067
Amico LX / LK /Sport	50		BR7HS	4122	0,5			211	BR7HIX	7067
Amico 50	50	01.90 - 95	BR7HS	4122	0,6			211	BR7HIX	7067
Amico 50 Clubmann	50	97 -	BR7HS	4122	0,5			211	BR7HIX	7067
Area 51 (MY)	50	99 -	BR8HS	4322	0,7	BR8HVX	6265	212	BR8HIX	7001
Gulliver 50	50	01.95 - 96	BR7HS	4122	0,6			211	BR7HIX	7067
Gulliver 50 H2O	50	01.96 -	BR8HS	4322	0,6	BR8HVX	6265	212	BR8HIX	7001
Gulliver 50 LC (LH)	50	96 -	BR8HS	4322	0,7	BR8HVX	6265	212	BR8HIX	7001
Gulliver AC (LH)	50		BR7HS	4122	0,5			211	BR7HIX	7067
Habana 50 / Custom (PK)	50	99 -	BPR8HS	3725	0,6				BPR8HIX	6742
Mojito Custom 50	50	99 -	BPR8HS	3725	0,6				BPR8HIX	6742
MX 50 (RX50)	50	03 -	BR9ES	5722	0,6	BR9EVX	1265	208	BR9EIX	3981
Rally 50 AC (MD)	50		BR7HS	4122	0,5			211	BR7HIX	7067
Rally 50	50	01.95 - 96	BR8HS	4322	0,6	BR8HVX	6265	212	BR8HIX	7001
Rally 50 LC / Fun (MZ)	50	96 -	BR8HS	4322	0,5	BR8HVX	6265	212	BR8HIX	7001
Rally 50 H2O	50	01.96 -	BR8HS	4322	0,6	BR8HVX	6265	212	BR8HIX	7001
Scarabeo 50	50	93 - 03	BR7HS	4122	0,5			211	BR7HIX	7067
Scarabeo De Luxe (PF)	50	98 - 03	BR7HS	4122	0,5			211	BR7HIX	7067
Scarabeo 50 (DiTech)	50	07.00 -	CPR8E	7411	0,6	ZMR7AP	6914			
Sonic 50 AC (PB)	50		BR7HS	4122	0,5			211	BR7HIX	7067
Sonic 50 G.P. / Spice	50	01.98 -	BR8HS	4322	0,6	BR8HVX	6265	212	BR8HIX	7001
Sonic 50 LC (PB)	50		BR8HS	4322	0,6	BR8HVX	6265	212	BR8HIX	7001
SR 50	50	01.92 - 96	BR7HS	4122	0,6			211	BR7HIX	7067
SR 50 LC (MZA)	50	93 -	BR8HS	4322	0,5	BR8HVX	6265	212	BR8HIX	7001
SR 50 R (VFD)	50	05 -	BR9ES	5722	0,6	BR9EVX	1265	208	BR9EIX	3981
SR 50 H2O (I)	50	01.96 - 04	BR8HS	4322	0,6	BR8HVX	6265	212	BR8HIX	7001
SR 50 WWW - Netscaper	50	01.97 -	BR8HS	4322	0,6	BR8HVX	6265	212	BR8HIX	7001
SR 50 i.e.LC (RLE) E2 (DiTech)	50	01 -	CPR8E	7411	0,6					
SR 50 i.e. LC (RLB) (DiTech)	50	07.00 -	CPR8E	7411	0,6					
SR 50 R Factory (VFB) (DiTech)(PIAGGIO Motor)	50	05 -	CPR8E	7411	0,6	ZMR7AP	6914			
SR 50 R (Vergaser)(PIAGGIO Motor)	50	05 -	BR9ES	5722	0,6	BR9EVX	1265	208	BR9EIX	3981
SR 50 i.e. (TE) (DiTech) (PIAGGIO Motor)	50	05 -	CPR8E	7411	0,6	ZMR7AP	6914			
SR 50 LC (TEA) Vergaser (PIAGGIO Motor)	50	05 -	BR9ES	5722	0,6	BR9EVX	1265	208	BR9EIX	3981
SR 50 H2O ( RLA)	50	00 -	BPR8HS	3725	0,6				BPR8HIX	6742
SR 50 AC (LY)	50	93 -	BR7HS	4122	0,5			211	BR7HIX	7067
SR 50 Street	50	05 -	BR9ES	5722	0,6	BR9EVX	1265	208	BR9EIX	3981
Scarabeo 100 (SA) 4T	100	00 -	CR7E	4578	0,7			225	CR7EIX	7385
Scarabeo 100 (RE) 2T	100	00 -	BR8HS	4322	0,7	BR8HVX	6265	212	BR8HIX	7001
Atlantic 125 (SP)	125	03 -	CR8EB	7784	0,6	CR8EVX	6487		CR8EIX	4218
Habana 125 (PM)	125	99 -	CR7E	4578	0,7			225	CR7EIX	7385
Leonardo 125 (TB)	125	01.95 -	CR8E	1275	0,7	CR8EVX	6487	226	CR8EIX	4218
Leonardo 125 (MBA)	125	01.95 -	CR8E	1275	0,7	CR8EVX	6487	226	CR8EIX	4218
Leonardo 125 (MB)	125	01.95 -	CR8E	1275	0,7	CR8EVX	6487	226	CR8EIX	4218
Mojito 125 (PM/RV)	125	05 -	CR7EB	4663	0,7			225	CR7EIX	7385
Scarabeo 125 (PCA)	125	99 -	CR8E	1275	0,6	CR8EVX	6487	226	CR8EIX	4218
Scarabeo 125 (PC)	125	99 -	CR8E	1275	0,6	CR8EVX	6487	226	CR8EIX	4218
Sportcity 125 (VB)	125		CR7EB	4663	0,7			225	CR7EIX	7385
SR 125 AC (PX)	125	99 -	BR8ES	5422	0,6	BR8EVX	1262	207	BR8EIX	5044
Leonardo 150 (TB)	150	01.97 - 00	CR8E	1275	0,7	CR8EVX	6487	226	CR8EIX	4218
Leonardo 150	150	02 -	DR8EA	7162	0,6	DR8EVX	6354		DR8EIX	6681
Leonardo 150 (MBA)	150	01.97 - 00	CR8E	1275	0,7	CR8EVX	6487	226	CR8EIX	4218

Order  
No.Platin  
Gold-  
Palla-  
diumOrder Quick  
No. No.Order  
No.**APRILIA**

Leonardo 150 (MB)	150	01.97 - 00	CR8E	1275	0,7	CR8EVX	6487	226	CR8EIX	4218
Mojito 150	150	03 -	CR7EB	4663	0,7			225	CR7EIX	7385
Scarabeo 150 (PC)	150	99 -	CR8E	1275	0,6	CR8EVX	6487	226	CR8EIX	4218
Scarabeo 150 (PCA)	150	99 -	CR8E	1275	0,6	CR8EVX	6487	226	CR8EIX	4218
SR 150	150		BR9ES	5722	0,6	BR9EVX	1265	208	BR9EIX	3981
Atlantic 200 (SP)	200	03 -	CR8EB	7784	0,6	CR8EVX	6487		CR8EIX	4218
Scarabeo	200	00 -			0,6	CR8EVX	6487		CR8EIX	4218
Sportcity 200 (VB)	200		CR7EB	4663	0,6				CR7EIX	7385
Atlantic 250 (SP)	250	04 -	CR8EB	7784	0,6	CR8EVX	6487		CR8EIX	4218
Leonardo 250 (SV)	250	98 - 00	DR7EA	7839	0,6					
Leonardo 250 (PD)	250	98 - 00	DR7EA	7839	0,6					
Scarabeo 250	250	04 -	CR8EB	7784	0,6	CR8EVX	6487		CR8EIX	4218
Sportcity 250 (VB)	250	06 -	PMR7A	4259	0,6					
Leonardo 300 (PD)	300	98 - 00	DR7EA	7839	0,6					
Leonardo 300 (SV)	300	98 - 00	DR7EA	7839	0,6					
Atlantic 500 Sprint (PT)	500	02 -	CR7EKB	4455	0,6					
Atlantic 500 Sprint (VL)	500		CR7EKB	4455	0,6					
Scarabeo 500	500	02 -	CR7EKB	4455	0,6					

**ATALA**

Byte	50		B7HS	5110	0,6	B7HVX	7836	204	BR7HIX	7067
Byte 25	50	96 -	BPR6HS	7022	0,6	BPR6HVX	2740	214	BPR6HIX	4085
Byte 50	50	96 -	BPR6HS	7022	0,6	BPR6HVX	2740	214	BPR6HIX	4085
Carosello	50		B7HS	5110	0,6	B7HVX	7836	204	BR7HIX	7067
Hacker - Hacker Racing	50		BPR6HS	7022	0,6	BPR6HVX	2740	214	BPR6HIX	4085
Hacker AT12	50	96 -	BPR6HS	7022	0,5	BPR6HVX	2740	214	BPR6HIX	4085
Hacker AT12 Racing	50	96 -	BPR6HS	7022	0,5	BPR6HVX	2740	214	BPR6HIX	4085
Hacker AT12 Racing LC	50	96 -	BPR6HS	7022	0,5	BPR6HVX	2740	214	BPR6HIX	4085
Master LF	50	96 -	B6HS	4510	0,5	B6HVX	7435	203	BR6HIX	3419
Racing	50	96 -	BPR6HS	7022	0,5	BPR6HVX	2740	214	BPR6HIX	4085
Skeggia	50	01.98 -	BPR6HS	7022	0,6	BPR6HVX	2740	214	BPR6HIX	4085

**BAJAJ**

Spirit	50	99 -	B6HS	4510	0,5	B6HVX	7435	203	BR6HIX	3419
Sunny 50	50	97 -	B6HS	4510	0,5	B6HVX	7435	203	BR6HIX	3419
Chetak	125		BP5HS	4111	0,6					
Chetak 125 Electr.	125		BP6HS	4511	0,6	BP6HVX	4635		BPR6HIX	4085
Chetak 125 electr.; D	125		BP6HS	4511	0,6	BP6HVX	4635		BPR6HIX	4085
Chetak 125 Electr.D	125		BP6HS	4511	0,6	BP6HVX	4635		BPR6HIX	4085
Chetak	150		BP5HS	4111	0,6					
Chetak 150 Classic	150		BPR5HS	6222	0,6					
Chetak 150 Classic Green	150		BPR5HS	6222	0,6					
Chetak 150 Classic Sidec	150		BPR5HS	6222	0,6					
Chetak 150 Electr.	150		BPR5HS	6222	0,6					
Chetak 150 electr.; D; Classic; Sidec; Green	150		BPR5HS	6222	0,6					
Chetak 150 Electr.D	150		BPR5HS	6222	0,6					

**BENELLI**

491 GP-SP	50	99 -	BR7HS	4122	0,7			211	BR7HIX	7067
491 GP-RR	50	99 -	BR7HS	4122	0,7			211	BR7HIX	7067
491 SBK	50	00 -	BR8HS	4322	0,7	BR8HVX	6265	212	BR8HIX	7001
491 only Italien	50		BR8ES	5422	0,6	BR8EVX	1262	207	BR8EIX	5044

Order  
No.Platin  
Gold-  
Palla-  
diumOrder Quick  
No. No.

Iridium

Order  
No.**BENELLI**

491 Superbike watercooler	50	99 -	BR7HS	4122	0,6			211	BR7HIX	7067
491 Rage ST	50	00 -	BR8HS	4322	0,7	BR8HVX	6265	212	BR8HIX	7001
491 ST GP	50	00 -	BR8HS	4322	0,7	BR8HVX	6265	212	BR8HIX	7001
491 Sport watercooler	50	97 -	BR7HS	4122	0,6			211	BR7HIX	7067
491 GT aircooler	50	97 -	BR7HS	4122	0,6			211	BR7HIX	7067
491 Racing watercooler	50	97 -	BR7HS	4122	0,6			211	BR7HIX	7067
K2 air cool	50		BR7HS	4122	0,6			211	BR7HIX	7067
K2 liquid cool/watercooler	50		BR7HS	4122	0,6			211	BR7HIX	7067
K2 Namur	50	00 -	BR8HS	4322	0,7	BR8HVX	6265	212	BR8HIX	7001
Laser 50	50		B6HS	4510	0,5	B6HVX	7435	203	BR6HIX	3419
Naked 50	50		BR8HS	4322	0,6	BR8HVX	6265	212	BR8HIX	7001
Pepe	50	99 -	BR7HS	4122	0,6			211	BR7HIX	7067
Pepe Kat	50	99 -	BR8HS	4322	0,6	BR8HVX	6265	212	BR8HIX	7001
S 50	50		B6HS	4510	0,5	B6HVX	7435	203	BR6HIX	3419
Scoothy 50	50		B6HS	4510	0,6	B6HVX	7435	203	BR6HIX	3419
K2 100	100	99 -	BR8HS	4322	0,7	BR8HVX	6265	212	BR8HIX	7001
Adiva 125	125		CR8EB	7784	0,6	CR8EVX	6487		CR8EIX	4218
Velvet Eco 125	125	99 -	CR8E	1275	0,6	CR8EVX	6487	226	CR8EIX	4218
Adiva 150	150		CR8EB	7784	0,6	CR8EVX	6487		CR8EIX	4218
Velvet Eco 150	150	99 -	CR8E	1275	0,6	CR8EVX	6487	226	CR8EIX	4218
Velvet Eco 250	250	00 -	DR8EA	7162	0,7	DR8EVX	6354		DR8EIX	6681
Dusk 400	400	05 -	CR9E	6263	0,7	CR9EVX	5943	227	CR9EIX	3521

**BETA**

Ark Limited LC	50		BR8HS	4322	0,6	BR8HVX	6265	212	BR8HIX	7001
Ark 50 K Serie	50		BR8HS	4322	0,6	BR8HVX	6265	212	BR8HIX	7001
Ark watercooler	50	97 -	BR8HS	4322	0,6	BR8HVX	6265	212	BR8HIX	7001
Ark 50 RR	50		BR8HS	4322	0,6	BR8HVX	6265	212	BR8HIX	7001
Ark LC	50		BR8HS	4322	0,6	BR8HVX	6265	212	BR8HIX	7001
Ark aircooler	50	97 -	BR7HS	4122	0,6			211	BR7HIX	7067
Ark X Type	50		BR8HS	4322	0,6	BR8HVX	6265	212	BR8HIX	7001
Chrono 50	50	95 -	BR7HS	4122	0,5			211	BR7HIX	7067
Chrono 502	50	95 -	BR7HS	4122	0,5			211	BR7HIX	7067
Eikon	50	98 -	BR8HS	4322	0,6	BR8HVX	6265	212	BR8HIX	7001
Quadra 50	50	95 -	BR7HS	4122	0,6			211	BR7HIX	7067
Tempo 50	50	94 -	BR7HS	4122	0,5			211	BR7HIX	7067
Tempo 50 13"	50	96 -	BR7HS	4122	0,5			211	BR7HIX	7067
Tempo 50 16"	50	96 -	BR7HS	4122	0,5			211	BR7HIX	7067
Alp 125	125		DR8EA	7162	0,6	DR8EVX	6354		DR8EIX	6681
Alp 4T 200	125		DR8EA	7162	0,6	DR8EVX	6354		DR8EIX	6681
Eikon 125	125	99 -	DR8EA	7162	0,6	DR8EVX	6354		DR8EIX	6681
Eikon 150	250	99 -	DPR7EA-9	5129	0,9	DPR7EVX-9	7682	220	DPR7EIX-9	7803
REV-3	250		BP7ES	2412	0,6	BP7EVX	7270	206	BPR7EIX	4055

**BMW**

C1 125 4T	125	04.00 - 03	CR8EB	7784	0,6	CR8EVX	6487		CR8EIX	4218
C1 200 4T	180	00 - 03	CR8EB	7784	0,6	CR8EVX	6487		CR8EIX	4218

**BS VILLA**

Giorno	50		BR8HSA	5539	0,6	BR8HVX	6265		BR8HIX	7001
GP Dio	50	90 -	BPR8HS	3725	0,6				BPR8HIX	6742
SP Dio	50		BPR7HS	6422	0,6	BPR7HVX	2938	215	BPR7HIX	5944

Order  
No.Platin  
Gold-  
Palla-  
diumOrder  
No.Quick  
No.

Iridium

Order  
No.**BS VILLA**

Z5	50	93 -	BR8HSA	5539	0,6	BR8HVX	6265		BR8HIX	7001
ZX	50	93 -	BR8HSA	5539	0,6	BR8HVX	6265		BR8HIX	7001

**BUFFALO**

CY 25	50	97 -	BR7HS	4122	0,6			211	BR7HIX	7067
CY 50	50	97 -	BR7HS	4122	0,6			211	BR7HIX	7067
CY 50 aircooled	50	96 -	BR7HS	4122	0,6			211	BR7HIX	7067
MK 50	50	96 -	BP7HS	5111	0,6	BP7HVX	7468		BPR7HIX	5944
MM 50	50	97 -	BR7HS	4122	0,6			211	BR7HIX	7067
MY 50 aircooled	50	96 -	BR7HS	4122	0,6			211	BR7HIX	7067
Silver watercooled	50	96 -	BR8ES	5422	0,5	BR8EVX	1262	207	BR8EIX	5044

**CAGIVA**

City	50	93 -	B7HS	5110	0,5	B7HVX	7836	204	BR7HIX	7067
City	50	94 - 97	BPR8HS	3725	0,6				BPR8HIX	6742
City	50	98 -	BR8HSA	5539	0,5	BR8HVX	6265		BR8HIX	7001
City L.E.	50	93 -	B7HS	5110	0,5	B7HVX	7836	204	BR7HIX	7067
City, City LE	50	01.93 -	B7HS	5110	0,6	B7HVX	7836	204	BR7HIX	7067
Cucciolo	50		B8HS	5510	0,6	B8HVX	2634	205	BR8HIX	7001
Mantis	50	99 -	B9ES	2611	0,6	B9EVX	7254	202	BR9EIX	3981
Passing	50		BP6HS	4511	0,6	BP6HVX	4635		BPR6HIX	4085
Progress 50	50		B8HS	5510	0,6	B8HVX	2634	205	BR8HIX	7001
Progress Corsa	50		B9ES	2611	0,6	B9EVX	7254	202	BR9EIX	3981
Scooter	50	93 -	BR8HSA	5539	0,7	BR8HVX	6265		BR8HIX	7001
Cucciolo	125	99 -	CR7E	4578	0,7			225	CR7EIX	7385
Nuvola	125		CR7E	4578	0,7			225	CR7EIX	7385
Passing	125	94 -	BP6HS	4511	0,6	BP6HVX	4635		BPR6HIX	4085
Passing	125	95 -	BP6HS	4511	0,6	BP6HVX	4635		BPR6HIX	4085

**CAPRI**

Roller 50	50		B7ES	1111	0,5	B7EVX	6934			
Roller 50S	50		B8ES	2411	0,5	B8EVX	7051	201	BR8EIX	5044
Roller 125	125		B8HS	5510	0,6	B8HVX	2634	205	BR8HIX	7001

**CCF**

Adly 50	50	96 -	BP7HS	5111	0,6	BP7HVX	7468		BPR7HIX	5944
Cat 50	50	97 -	BP7HS	5111	0,6	BP7HVX	7468		BPR7HIX	5944
Adly 100	100	96 -	BP7HS	5111	0,6	BP7HVX	7468		BPR7HIX	5944
Cat 125	125	98 -	CR7HSA	4549	0,6				CR7HIX	7544

**CPI**

Aragon 50	50	06.06 -	BR7ES	5122	0,8	BR7EVX	4556			
Aragon GP 50 Sport	50	06.06 -	BR7ES	5122	0,8	BR7EVX	4556			
Bingo FL	50	02 - 02	BR8HSA	5539	0,6	BR8HVX	6265		BR8HIX	7001
GTR 50	50	03 -	BR7ES	5122	0,8	BR7EVX	4556			
GTS 50	50	03 -	BR7ES	5122	0,8	BR7EVX	4556			
Hussar	50	01 - 01	BR8HSA	5539	0,6	BR8HVX	6265		BR8HIX	7001
Hussar Euro 2	50	03 -	BR7ES	5122	0,8	BR7EVX	4556			
Hussar FL	50	02 - 02	BR8HSA	5539	0,6	BR8HVX	6265		BR8HIX	7001
Hussar SL	50	02 - 02	BR8HSA	5539	0,6	BR8HVX	6265		BR8HIX	7001
Oliver Sport	50	06 -	BR7ES	5122	0,8	BR7EVX	4556			
Oliver City	50	06 -	BR7ES	5122	0,8	BR7EVX	4556			

Order  
No.Platin  
Gold-  
Palla-  
diumOrder Quick  
No. No.

Iridium

Order  
No.**CPI**

Oliver 50	50	03 -	BR7ES	5122	0,8	BR7EVX	4556			
Popcorn FL	50	02 - 02	BR8HSA	5539	0,6	BR8HVX	6265		BR8HIX	7001
Popcorn SL	50	02 - 02	BR8HSA	5539	0,6	BR8HVX	6265		BR8HIX	7001
Popcorn	50	00 - 01	BR8HSA	5539	0,6	BR8HVX	6265		BR8HIX	7001
Popcorn Euro 2	50	03 -	BR7ES	5122	0,8	BR7EVX	4556			
Tennessee	50	01 -	BR8HSA	5539	0,6	BR8HVX	6265		BR8HIX	7001
Aragon 125	125	06 -	CR7HSA	4549	0,6				CR7HIX	7544
GTS 125	125	03 -	BR7ES	5122	0,8	BR7EVX	4556			
X-Large 125	125	03 -	BR7ES	5122	0,8	BR7EVX	4556			
GTS 150	150	03 -	BR7ES	5122	0,8	BR7EVX	4556			
X-Large 150	150	03 -	BR7ES	5122	0,8	BR7EVX	4556			
GTS 200	200	03 -	BR7ES	5122	0,8	BR7EVX	4556			
X-Large 200	200	03 -	BR7ES	5122	0,8	BR7EVX	4556			

**DAELIM**

Cordi 50	50	04 -	BPR6HS	7022	0,6	BPR6HVX	2740	214	BPR6HIX	4085
E-Five	50	03 -	B8HS	5510	0,6	B8HVX	2634	205	BR8HIX	7001
Message	50	98 -	BR8HSA	5539	0,6	BR8HVX	6265		BR8HIX	7001
S-Five	50	02 -	B8HS	5510	0,6	B8HVX	2634	205	BR8HIX	7001
Tapo	50	98 -	BR8HSA	5539	0,6	BR8HVX	6265		BR8HIX	7001
Altino	100	98 -	CR8EH-9	5666	0,9	CR8EHVX-9	4546	228	CR8EHIX-9	3797
Delfino	100		BR8HS	4322	0,6	BR8HVX	6265	212	BR8HIX	7001
Citi Ace 110	110	03 -	C7HSA	4629	0,7	C7HVX	4533		CR7HIX	7544
Advance	125	97 -	CR8EH-9	5666	0,9	CR8EHVX-9	4546	228	CR8EHIX-9	3797
Classic	125	00 -	CR8EH-9	5666	0,9	CR8EHVX-9	4546	228	CR8EHIX-9	3797
Daystar	125	00 -	CR8EH-9	5666	0,9	CR8EHVX-9	4546	228	CR8EHIX-9	3797
Evolution	125	97 -	CR8EH-9	5666	0,9	CR8EHVX-9	4546	228	CR8EHIX-9	3797
Fellow	125	98 - 99	CR8EH-9	5666	0,9	CR8EHVX-9	4546	228	CR8EHIX-9	3797
Freewing 125	125	05 -	CR8EH-9	5666	0,9	CR8EHVX-9	4546	228	CR8EHIX-9	3797
NS 125	125	98 -	CR8EH-9	5666	0,9	CR8EHVX-9	4546	228	CR8EHIX-9	3797
Otello	125	04 -	CR8EH-9	5666	0,9	CR8EHVX-9	4546	228	CR8EHIX-9	3797
Othello	125	98 -	CR8EH-9	5666	0,9	CR8EHVX-9	4546	228	CR8EHIX-9	3797
S-2 (Freewing)	125	05 - 06	CR8EH-9	5666	0,9	CR8EHVX-9	4546	228	CR8EHIX-9	3797
SL History 125	125		CR8EH-9	5666	0,9	CR8EHVX-9	4546	228	CR8EHIX-9	3797
VC 125	125	97 -	CR8EH-9	5666	0,9	CR8EHVX-9	4546	228	CR8EHIX-9	3797
VS 125	125	97 -	CR8EH-9	5666	0,9	CR8EHVX-9	4546	228	CR8EHIX-9	3797

**DERBI**

Atlantis O2	50	99 -	B8HS	5510	0,6	B8HVX	2634	205	BR8HIX	7001
Atlantis LC	50		B9ES	2611	0,6	B9EVX	7254	202	BR9EIX	3981
Atlantis Air	50	03 -	BR9ES	5722	0,6	BR9EVX	1265	208	BR9EIX	3981
Atlantis City	50	03 -	BR9ES	5722	0,6	BR9EVX	1265	208	BR9EIX	3981
Aventura	50	95 -	B8HS	5510	0,6	B8HVX	2634	205	BR8HIX	7001
Bullet	50	03 -	BR9ES	5722	0,6	BR9EVX	1265	208	BR9EIX	3981
Furax 50	50	95 -	B8HS	5510	0,5	B8HVX	2634	205	BR8HIX	7001
GP Serie Air Cool	50		BR10ES	4832	0,6	BR10EVX	3788		BR10EIX	6801
GP1 Replica water Cool	50	03 -	BR10ES	4832	0,6	BR10EVX	3788		BR10EIX	6801
Hunter	50		B8HS	5510	0,6	B8HVX	2634	205	BR8HIX	7001
Manhattan	50		B8HS	5510	0,6	B8HVX	2634	205	BR8HIX	7001
Paddock LC	50		B9ES	2611	0,6	B9EVX	7254	202	BR9EIX	3981
Paddock 50 O2	50		B8HS	5510	0,6	B8HVX	2634	205	BR8HIX	7001
Predator LC	50	98 -	B9ES	2611	0,6	B9EVX	7254	202	BR9EIX	3981

Order  
No.Platin  
Gold-  
Palla-  
diumOrder Quick  
No. No.Order  
No.**DERBI**

Predator 02 (ES)	50		B8HS	5510	0,6	B8HVX	2634	205	BR8HIX	7001
Predator 02	50	98 -	B9ES	2611	0,6	B9EVX	7254	202	BR9EIX	3981
Racing Replica	50	02 -	BR9ES	5722	0,6	BR9EVX	1265	208	BR9EIX	3981
Rambla 50	50		BR9ES	5722	0,6	BR9EVX	1265	208	BR9EIX	3981
Red Bullet	50	03 -	BR9ES	5722	0,6	BR9EVX	1265	208	BR9EIX	3981
Vamos FL 50	50		BR8HS	4322	0,6	BR8HVX	6265	212	BR8HIX	7001
Vamos SE 50	50		BR8HS	4322	0,6	BR8HVX	6265	212	BR8HIX	7001
Vamos 50	50	93 -	B8HS	5510	0,5	B8HVX	2634	205	BR8HIX	7001
Variant Revolution	50	03 -	B8HS	5510	0,6	B8HVX	2634	205	BR8HIX	7001
Atlantis 100	100		B9ES	2611	0,6	B9EVX	7254	202	BR9EIX	3981
Boulevard 125 4T air cooler	125		CR9E	6263	0,7	CR9EVX	5943	227	CR9EIX	3521
Rambla 125	125		BR9ES	5722	0,6	BR9EVX	1265	208	BR9EIX	3981
Boulevard 150 4T	150		CR9E	6263	0,7	CR9EVX	5943	227	CR9EIX	3521

**DÜRRKOPP**

Diana			B7HS	5110	0,5	B7HVX	7836	204	BR7HIX	7067
Diana TS	175		B8HS	5510	0,5	B8HVX	2634	205	BR8HIX	7001

**ENDRESS**

EMR 50 DJ	50	97 -	BR8HSA	5539	0,6	BR8HVX	6265		BR8HIX	7001
EMR 50 Ergon	50	97 -	BP6HS	4511	0,6	BP6HVX	4635		BPR6HIX	4085

**ENDRESS EMR**

EMR 50	50		BR8HSA	5539	0,6	BR8HVX	6265		BR8HIX	7001
--------	----	--	--------	------	-----	--------	------	--	--------	------

**ENFIELD**

Scooter	125		B6HS	4510	0,5	B6HVX	7435	203	BR6HIX	3419
---------	-----	--	------	------	-----	-------	------	-----	--------	------

**ERING**

Cat 50	50		B6HS	4510	0,6	B6HVX	7435	203	BR6HIX	3419
Jet 50	50		B6HS	4510	0,6	B6HVX	7435	203	BR6HIX	3419
Rapido	50		B6HS	4510	0,6	B6HVX	7435	203	BR6HIX	3419
Silver Fox	50		B6HS	4510	0,6	B6HVX	7435	203	BR6HIX	3419
Sprint 50	50		C7HSA	4629	0,7	C7HVX	4533		CR7HIX	7544
Thunderbike 50	50		B6HS	4510	0,6	B6HVX	7435	203	BR6HIX	3419
Cat 125	125		CR7HSA	4549	0,6				CR7HIX	7544
Shining 125	125		CR7HSA	4549	0,6				CR7HIX	7544
Thunderbike 125	125		CR7HSA	4549	0,6				CR7HIX	7544

**FAMEL-ZÜNDAPP**

Yuppie, XF	50		B8ES	2411	0,6	B8EVX	7051	201	BR8EIX	5044
------------	----	--	------	------	-----	-------	------	-----	--------	------

**FANTIC**

Grinta	50		BP7HS	5111	0,6	BP7HVX	7468		BPR7HIX	5944
Queenie	50		BP7HS	5111	0,6	BP7HVX	7468		BPR7HIX	5944
Koala,Oasis	75		B8ES	2411	0,5	B8EVX	7051	201	BR8EIX	5044
Caballero RC80	80				0,6	B10EG	3630			

**GARELLI**

GS-1			BR8HSA	5539	0,6	BR8HVX	6265		BR8HIX	7001
XM-1			BR8HSA	5539	0,6	BR8HVX	6265		BR8HIX	7001
303 50	50		BPR7HS	6422	0,6	BPR7HVX	2938	215	BPR7HIX	5944



Order  
No.Platin  
Gold-  
Palla-  
diumOrder Quick  
No. No.

Iridium

Order  
No.**GARELLI**

Astro 50	50		BR9HS	4522	0,6					
Astro 50 2001	50	01 -	BR9HS	4522	0,6					
Big Whell	50	93 -	BPR7HS	6422	0,6	BPR7HVX	2938	215	BPR7HIX	5944
Flo 50	50		BPR7HS	6422	0,6	BPR7HVX	2938	215	BPR7HIX	5944
FX 50	50		BR9HS	4522	0,6					
Grinta 50	50	01.93 -	BP7HS	5111	0,6	BP7HVX	7468		BPR7HIX	5944
Hussar 50	50		BR8HSA	5539	0,6	BR8HVX	6265		BR8HIX	7001
KRC 50	50		BR9HS	4522	0,6					
KRS 50	50		BR9HS	4522	0,6					
M 901 50	50		BR9HS	4522	0,6					
Mars 50	50		BR9HS	4522	0,6					
Match 50	50		BR8HSA	5539	0,6	BR8HVX	6265		BR8HIX	7001
PMX Rally 50	50		BPR7HS	6422	0,6	BPR7HVX	2938	215	BPR7HIX	5944
PMX Sport 50	50		BPR7HS	6422	0,6	BPR7HVX	2938	215	BPR7HIX	5944
Pony 50	50		BP7HS	5111	0,6	BP7HVX	7468		BPR7HIX	5944
Queenie 50	50	01.92 -	BP7HS	5111	0,6	BP7HVX	7468		BPR7HIX	5944
Racing SR / Racing	50	- 93	BP7HS	5111	0,6	BP7HVX	7468		BPR7HIX	5944
Raider 50	50		BR9HS	4522	0,6					
Roadshow 50	50		BR9HS	4522	0,6					
RZ1 50	50		BR9HS	4522	0,6					
Shark 50	50		BR9HS	4522	0,6					
SR	50		BP7HS	5111	0,6	BP7HVX	7468		BPR7HIX	5944
Starter 50	50		BR9HS	4522	0,6					
PMX Sport	106		BR8HS	4322	0,6	BR8HVX	6265	212	BR8HIX	7001
PMX Sport 110	110		BPR6HS	7022	0,6	BPR6HVX	2740	214	BPR6HIX	4085
303 R 125	125		CR7HSA	4549	0,5				CR7HIX	7544
Blast 125	125		CR7HSA	4549	0,5				CR7HIX	7544
GTA 125 / ES	125		B10ES	7928	0,5	B10EGV	5927		BR10EIX	6801
Hussar 125	125		CR7HSA	4549	0,6				CR7HIX	7544
Hussar 125 2001	125	01 -	CR7HSA	4549	0,6				CR7HIX	7544
Joker 125	125	03 -	CR7HSA	4549	0,7				CR7HIX	7544
Tiger 125 XLE	125		B10ES	7928	0,5	B10EGV	5927		BR10EIX	6801
T-Rex 125	125		CR7HSA	4549	0,6				CR7HIX	7544
T-Rex 150 2001	125		CR7HSA	4549	0,5				CR7HIX	7544
Freeland 150	150		CR7HSA	4549	0,7				CR7HIX	7544
Joker 150	150		CR7HSA	4549	0,7				CR7HIX	7544
T-Rex 150	150		CR7HSA	4549	0,5				CR7HIX	7544
T-Rex 150 2001	150	01 -	CR7HSA	4549	0,6				CR7HIX	7544

**GILERA**

DNA 50	50	00 -	BR9ES	5722	0,6	BR9EVX	1265	208	BR9EIX	3981
Eaglet 50	50	01.93 -	B9ES	2611	0,6	B9EVX	7254	202	BR9EIX	3981
Easy Mooving	50	01.95 -	B9ES	2611	0,6	B9EVX	7254	202	BR9EIX	3981
GSM 50	50	00 -	BR9ES	5722	0,6	BR9EVX	1265	208	BR9EIX	3981
Ice	50	00 -	BR9ES	5722	0,6	BR9EVX	1265	208	BR9EIX	3981
Pure Jet 50	50	04 -	CPR8E	7411	0,6					
Runner (DiTech)(PIAGGIO Motor)	50	05 -	CPR8E	7411	0,6	ZMR7AP	6914			
Runner Racing Replica	50	04 -	BR9ES	5722	0,6	BR9EVX	1265	208	BR9EIX	3981
Runner	50	97 -	B9EG	3530	0,6	B9EGV	5827		BR9EIX	3981
Runner SP	50	00 -	BR9ES	5722	0,6	BR9EVX	1265	208	BR9EIX	3981
Runner 2P 2D	50	01.97 -	B9ES	2611	0,6	B9EVX	7254	202	BR9EIX	3981
Stalker	50	01.97 -	B9ES	2611	0,6	B9EVX	7254	202	BR9EIX	3981

Order  
No.Platin  
Gold-  
Palla-  
diumOrder  
No.Quick  
No.

Iridium

Order  
No.**GILERA**

Storm 50	50	94 -	B9ES	2611	0,5	B9EVX	7254	202	BR9EIX	3981
Typhoon 50	50	01.93 -	B9ES	2611	0,6	B9EVX	7254	202	BR9EIX	3981
Typhoon Benetton F1	50	01.96 -	B9ES	2611	0,6	B9EVX	7254	202	BR9EIX	3981
Typhoon 50 Martini Racing	50	01.95 -	B9ES	2611	0,6	B9EVX	7254	202	BR9EIX	3981
Cougar 125	125	00 -	DPR8EA-9	4929	0,9	DPR8EVX-9	2872	221	DPR8EIX-9	2202
DNA 125	125	00 -	CR8EB	7784	0,7	CR8EVX	6487		CR8EIX	4218
Runner VX 125	125	06 -	CR8EB	7784	0,7	CR8EVX	6487		CR8EIX	4218
Runner RST 125	125	05 -	CR8EB	7784	0,7	CR8EVX	6487		CR8EIX	4218
Runner FX 125	125	97 -	B9ES	2611	0,6	B9EVX	7254	202	BR9EIX	3981
Typhoon 125	125	01.95 -	B9ES	2611	0,6	B9EVX	7254	202	BR9EIX	3981
Runner	150	98 -	BR9ES	5722	0,6	BR9EVX	1265	208	BR9EIX	3981
DNA 180	180	00 -	CR8EB	7784	0,7	CR8EVX	6487		CR8EIX	4218
Runner FRX 180	180	98 -	B9ES	2611	0,6	B9EVX	7254	202	BR9EIX	3981
Runner VXR	180	01 -	CR9EB	6955	0,6				CR9EIX	3521
Nexus 500	500	06.03 -	CPR8E	7411	0,6					

**HEINKEL**

Tourist 150	150	01.62 -	A7	1110						
Tourist 175	175	09.60 -	B7HS	5110	0,5	B7HVX	7836	204	BR7HIX	7067

**HERKULES**

BT 50 (4Takt Baotian)	50	05 -	C7HSA	4629	0,7	C7HVX	4533		CR7HIX	7544
TB 50 Race	50	05 -	BPR7HS	6422	0,6	BPR7HVX	2938	215	BPR7HIX	5944

**HMZ**

Cab SB50	50	96 -	BP6HS	4511	0,6	BP6HVX	4635		BPR6HIX	4085
----------	----	------	-------	------	-----	--------	------	--	---------	------

**HONDA**

Various		02.04 -	CR7HSA	4549	0,9				CR7HIX	7544
DIO 50	50	04 -	ER8EH-N	5606	0,7					
Joker SRX50T	50	97 -	BR6HSA	4296	0,5			210	BR6HIX	3419
NB 50	50		BPR6HSA	4632	0,7	BPR6HVX	2740	214	BPR6HIX	4085
NB 50 M Melody (AB07)	50	.84 -	BPR6HS	7022	0,7	BPR6HVX	2740	214	BPR6HIX	4085
NH 50 Lead	50	01.87 - .88	BPR6HS	7022	0,6	BPR6HVX	2740	214	BPR6HIX	4085
NH 50 M	50	93 -	BPR6HS	7022	0,7	BPR6HVX	2740	214	BPR6HIX	4085
NH 50 MS Lead (AF01)	50	.85 - .87	BPR6HS	7022	0,7	BPR6HVX	2740	214	BPR6HIX	4085
PK 50 Wallaro	50	90 -	BR6HSA	4296	0,6			210	BR6HIX	3419
PX 50	50	.89 - 90	BPR5HS	6222	0,6					
SA 50 Vision	50	91 -	BPR6HSA	4632	0,6	BPR6HVX	2740	214	BPR6HIX	4085
SA 50 Vision	50	01.88 - 90	BPR6HSA	4632	0,6	BPR6HVX	2740	214	BPR6HIX	4085
SFX 50	50	95 -	BR6HSA	4296	0,6			210	BR6HIX	3419
SGX 50 Sky	50	97 -	BR6HSA	4296	0,6			210	BR6HIX	3419
SH 50 (I)	50	01.87 - 96	BPR6HS	7022	0,6	BPR6HVX	2740	214	BPR6HIX	4085
SH 50 New	50	01.97 -	BPR6HS	7022	0,6	BPR6HVX	2740	214	BPR6HIX	4085
SH 50 P	50	01.93 - 95	BPR6HSA	4632	0,6	BPR6HVX	2740	214	BPR6HIX	4085
SH 50 (AF40)	50	97 -	BR6HSA	4296	0,7			210	BR6HIX	3419
SH 50 T	50	96 -	BR6HSA	4296	0,6			210	BR6HIX	3419
Shadow 50	50	01.97 -	BR6HSA	4296	0,6			210	BR6HIX	3419
SJ 50 Bali	50		BR6HSA	4296	0,6			210	BR6HIX	3419
Sky 50 DX	50	01.96 -	BR6HSA	4296	0,6			210	BR6HIX	3419
SXR 50 W	50	98 -	BR6HSA	4296	0,6			210	BR6HIX	3419
SZX 50 X8R-S/X	50	98 -	BR6HSA	4296	0,6			210	BR6HIX	3419



Order No.



Gold-Palladium



Order No.

Quick No.

Iridium



Order No.

**HONDA**

X8R-S	50	01.98 -	BR6HSA	4296	0,6			210	BR6HIX	3419
X8R-X	50	01.98 -	BR6HSA	4296	0,6			210	BR6HIX	3419
Zoomer	50	04 -	ER8EH-N	5606	0,7					
NH 80 MS Lead (HD01)	80	.83 -	BPR6HS	7022	0,7	BPR6HVX	2740	214	BPR6HIX	4085
SRX 90 Shadow (JH2 HF09A)	90	98 -	BR6HSA	4296	0,7			210	BR6HIX	3419
SCV 100 Lead	100	03 -	CR6HSA	2983	0,7				CR6HIX	7274
SH 100 T	100	01.96 -	BR6HSA	4296	0,6			210	BR6HIX	3419
SJ 100 Bali	100	01.96 -	BR6HSA	4296	0,6			210	BR6HIX	3419
@ 125	125	00 -	CR8EH-9	5666	0,9	CR8EHVX-9	4546	228	CR8EHIX-9	3797
ANF 125 i Innova	125	07 -	CPR6EA-9	6899	0,9					
CH 125	125	01.86 - 95	DPR7EA-9	5129	0,9	DPR7EVX-9	7682	220	DPR7EIX-9	7803
CH 125 P	125	-01.93	DPR7EA-9	5129	0,9	DPR7EVX-9	7682	220	DPR7EIX-9	7803
Dylan 125	125	02 -	CR8EH-9	5666	0,9	CR8EHVX-9	4546	228	CR8EHIX-9	3797
FES 125 Pantheon 4Takt	125	03 -	CR8EH-9	5666	0,9	CR8EHVX-9	4546	228	CR8EHIX-9	3797
FES 125 Pantheon (JF05) 2Takt	125	98 -	BR8ES	5422	0,7	BR8EVX	1262	207	BR8EIX	5044
NH 125 D Lead	125	.83 -	BPR6HS	7022	0,7	BPR6HVX	2740	214	BPR6HIX	4085
Pantheon 125	125	01.98 -	BR8ES	5422	0,7	BR8EVX	1262	207	BR8EIX	5044
SH 125	125	01 -	CR8EH-9	5666	0,9	CR8EHVX-9	4546	228	CR8EHIX-9	3797
Spacy CH 125 (JS03)	125	97 -	DPR7EA-9	5129	0,9	DPR7EVX-9	7682	220	DPR7EIX-9	7803
s-Wing 125	125	07 -	CR8EH-9	5666	0,9	CR8EHVX-9	4546	228	CR8EHIX-9	3797
SH 150i	150	06 -	CR8EH-9	5666	0,9	CR8EHVX-9	4546	228	CR8EHIX-9	3797
s-Wing 150	150	07 -	CR8EH-9	5666	0,9	CR8EHVX-9	4546	228	CR8EHIX-9	3797
CN 250	250	01.86 -	DPR6EA-9	5531	0,9					
CN 250 Fusion	250		DPR8EA-9	4929	0,9	DPR8EVX-9	2872	221	DPR8EIX-9	2202
CN 250 Helix (MF02)	250	01.87 - 99	DPR6EA-9	5531	0,9					
FES 250 Foresight (MF04)	250	97 -	DPR7EA-9	5129	0,9	DPR7EVX-9	7682	220	DPR7EIX-9	7803
Foresight 250 (I)	250	01.98 -	DPR7EA-9	5129	0,9	DPR7EVX-9	7682	220	DPR7EIX-9	7803
Forza	250	05 -	DPR7EA-9	5129	0,9	DPR7EVX-9	7682	220	DPR7EIX-9	7803
SH 300 i (NF02)	300	07 -	LMAR8A-9	4313	0,9					
Silverwing 400	400	06 -	CR8EH-9	5666	0,9	CR8EHVX-9	4546	228	CR8EHIX-9	3797
Silver Wing ABS (G2)	600	03 -	CR8EH-9	5666	0,9	CR8EHVX-9	4546	228	CR8EHIX-9	3797
Silver Wing 600	600	01 -	CR8EH-9	5666	0,9	CR8EHVX-9	4546	228	CR8EHIX-9	3797

**HYOSUNG**

Avanti 50 (SD50)	50	99 -	BP6HS	4511	0,6	BP6HVX	4635		BPR6HIX	4085
Cab 50 (SB50G)	50	95 -	BP6HS	4511	0,6	BP6HVX	4635		BPR6HIX	4085
Gamma 50 (SB50G)	50	97 -	BP6HS	4511	0,6	BP6HVX	4635		BPR6HIX	4085
Prima	50		BR8HSA	5539	0,6	BR8HVX	6265		BR8HIX	7001
Sense	50		BP6HS	4511	0,6	BP6HVX	4635		BPR6HIX	4085
SF 50	50	99 -	BR8HSA	5539	0,6	BR8HVX	6265		BR8HIX	7001
SF Rally 50	50	04 -	BR8HSA	5539	0,6	BR8HVX	6265		BR8HIX	7001
Supercab (EZ100)	100	97 -	BP7HS	5111	0,6	BP7HVX	7468		BPR7HIX	5944
Boomer 125	125	02 -	DR8EA	7162	0,6	DR8EVX	6354		DR8EIX	6681
Grand Prix	125		DR8EA	7162	0,6	DR8EVX	6354		DR8EIX	6681
Plus 125	125		DR8EA	7162	0,6	DR8EVX	6354		DR8EIX	6681

**ITALJET**

Ascot 50	50		BP7HS	5111	0,6	BP7HVX	7468		BPR7HIX	5944
Bazooka - Bazooka II	50		BP7HS	5111	0,6	BP7HVX	7468		BPR7HIX	5944
Cruise	50		BP6HS	4511	0,6	BP6HVX	4635		BPR6HIX	4085
Dragster 50	50	97 - 98	BPR8HS	3725	0,6				BPR8HIX	6742
Dragster 50	50	98 -	BR8HS	4322	0,6	BR8HVX	6265	212	BR8HIX	7001

Order  
No.Platin  
Gold-  
Palla-  
diumOrder Quick  
No. No.Order  
No.**ITALJET**

Dragster	50	98 -	B7HS	5110	0,6	B7HVX	7836	204	BR7HIX	7067
Dragster 50	50	96 - 97	BPR8HS	3725	0,6				BPR8HIX	6742
Fastboy	50	98 -	BR7HS	4122	0,6			211	BR7HIX	7067
Formula 50 Mofa (aircool)	50	99 -	BR8HS	4322	0,6	BR8HVX	6265	212	BR8HIX	7001
Formula 50 aircool	50	98 -	BR7HS	4122	0,6			211	BR7HIX	7067
Formula 50 watercool	50	98 -	BR8HS	4322	0,6	BR8HVX	6265	212	BR8HIX	7001
Formula 50	50	01.95 -	BPR6HS	7022	0,6	BPR6HVX	2740	214	BPR6HIX	4085
Pista 50 ; Pista II	50		BP7HS	5111	0,6	BP7HVX	7468		BPR7HIX	5944
Reporter	50		BP7HS	5111	0,6	BP7HVX	7468		BPR7HIX	5944
Scoop 50	50		BP7HS	5111	0,6	BP7HVX	7468		BPR7HIX	5944
Sunny 50	50		BP6HS	4511	0,6	BP6HVX	4635		BPR6HIX	4085
Torpedo 2T	50		B7HS	5110	0,6	B7HVX	7836	204	BR7HIX	7067
Torpedo 50	50	98 -	BR7HS	4122	0,6			211	BR7HIX	7067
Torpedo 25	50	97 -	BPR8HS	3725	0,6				BPR8HIX	6742
Torpedo 4T	50		CR7E	4578	0,6			225	CR7EIX	7385
Velocifero "8", "10"	50	98 -	BR8HS	4322	0,6	BR8HVX	6265	212	BR8HIX	7001
Velocifero	50	- 97	BPR6HS	7022	0,7	BPR6HVX	2740	214	BPR6HIX	4085
Yankee 50	50		BP7HS	5111	0,6	BP7HVX	7468		BPR7HIX	5944
Millenium 100	100		BR7HS	4122	0,6			211	BR7HIX	7067
Dragster 125	125	97 - 97	B7HS	5110	0,6	B7HVX	7836	204	BR7HIX	7067
Dragster 125	125	98 -	BR9ES	5722	0,6	BR9EVX	1265	208	BR9EIX	3981
Formula 125 (I)	125		BR7HS	4122	0,6			211	BR7HIX	7067
Formula 125	125	98 -	BR8HS	4322	0,6	BR8HVX	6265	212	BR8HIX	7001
Formula 125	125	97 - 98	B7HS	5110	0,6	B7HVX	7836	204	BR7HIX	7067
Jet Set	125		CR7E	4578	0,6			225	CR7EIX	7385
Jupiter	125		CR8E	1275	0,7	CR8EVX	6487	226	CR8EIX	4218
Millenium	125	99 -	CR8E	1275	0,7	CR8EVX	6487	226	CR8EIX	4218
Torpedo 125 4T	125	98 -	CR7E	4578	0,7			225	CR7EIX	7385
Jet Set	150		CR7E	4578	0,6			225	CR7EIX	7385
Jupiter	150		CR8E	1275	0,7	CR8EVX	6487	226	CR8EIX	4218
Millenium	150		CR8E	1275	0,7	CR8EVX	6487	226	CR8EIX	4218
Dragster 180	180	98 -	BR9ES	5722	0,6	BR9EVX	1265	208	BR9EIX	3981
Jupiter	250		DR8EA	7162	0,6	DR8EVX	6354		DR8EIX	6681
Millenium	250	99 -	DR8EA	7162	0,6	DR8EVX	6354		DR8EIX	6681

**ITTECO**

Hornet	50		BP6HS	4511	0,6	BP6HVX	4635		BPR6HIX	4085
--------	----	--	-------	------	-----	--------	------	--	---------	------

**KINETIC**

Pride	50		BP7HS	5111	0,6	BP7HVX	7468		BPR7HIX	5944
Pride	80		BP7HS	5111	0,6	BP7HVX	7468		BPR7HIX	5944

**KREIDLER**

Florett RMC 50	50	05 -	BPR7HS	6422	0,6	BPR7HVX	2938	215	BPR7HIX	5944
Florett RMC 25	50	05 -	BPR7HS	6422	0,6	BPR7HVX	2938	215	BPR7HIX	5944
Florett XL 25	50		BPR7HS	6422	0,6	BPR7HVX	2938	215	BPR7HIX	5944
Florett 25	50	01.96 -	BPR7HS	6422	0,6	BPR7HVX	2938	215	BPR7HIX	5944
Florett 50	50	01.96 -	BPR7HS	6422	0,6	BPR7HVX	2938	215	BPR7HIX	5944
Florett XL 50	50		BPR7HS	6422	0,6	BPR7HVX	2938	215	BPR7HIX	5944
Flory 50	50	96 -	BPR7HS	6422	0,6	BPR7HVX	2938	215	BPR7HIX	5944
Flory 25	50	96 -	BPR7HS	6422	0,6	BPR7HVX	2938	215	BPR7HIX	5944
Flory RC 25	50	05 -	BPR7HS	6422	0,6	BPR7HVX	2938	215	BPR7HIX	5944

Order  
No.Platin  
Gold-  
Palla-  
diumOrder Quick  
No. No.

Iridium

Order  
No.**KREIDLER**

Flory RC 50	50	05 -	BPR7HS	6422	0,6	BPR7HVX	2938	215	BPR7HIX	5944
MK	50	96 -	BPR7HS	6422	0,6	BPR7HVX	2938	215	BPR7HIX	5944
Florett RMC 125	125	05 -	CR7HSA	4549	0,5				CR7HIX	7544
Flory 125 4Takt	125		CR7HSA	4549	0,5				CR7HIX	7544
Mustang	125	97 -	CR7HSA	4549	0,5				CR7HIX	7544

**KTM**

Chrono 50	50		BR7HS	4122	0,5			211	BR7HIX	7067
Go 50	50		BR7HS	4122	0,5			211	BR7HIX	7067
K 50 (I)	50		BR7HS	4122	0,5			211	BR7HIX	7067

**KYMCO**

Agility 50	50	05 -	CR7HSA	4549	0,5				CR7HIX	7544
Calypso 50	50	97 -	BR8HS	4322	0,6	BR8HVX	6265	212	BR8HIX	7001
Cobra Cross	50	97 -	BR8HSA	5539	0,6	BR8HVX	6265		BR8HIX	7001
Cobra Racer	50	97 -	BR8HSA	5539	0,6	BR8HVX	6265		BR8HIX	7001
CSX 50	50		BR8HSA	5539	0,6	BR8HVX	6265		BR8HIX	7001
Curio	50		BR8HSA	5539	0,6	BR8HVX	6265		BR8HIX	7001
CX 50; CX Super	50		BR8HSA	5539	0,6	BR8HVX	6265		BR8HIX	7001
Dink 50 LC /Bet&Win 50LC	50		BR6HSA	4296	0,6			210	BR6HIX	3419
Dink 50 2Takt (Italy)	50	99 -	CR7HSA	4549	0,5				CR7HIX	7544
DJ 50	50		BR8HSA	5539	0,6	BR8HVX	6265		BR8HIX	7001
DJW 50 ;W / X / Y	50	01.93 -	BR8HSA	5539	0,6	BR8HVX	6265		BR8HIX	7001
Fever ZX 50	50		BR8HSA	5539	0,6	BR8HVX	6265		BR8HIX	7001
Fever II ZX 50	50		BR8HSA	5539	0,6	BR8HVX	6265		BR8HIX	7001
Filly 50	50	98 -	C7HSA	4629	0,7	C7HVX	4533		CR7HIX	7544
Grand Dink 50 2Takt	50	05 -	BR8HSA	5539	0,6	BR8HVX	6265		BR8HIX	7001
Heroism 50	50		BR8HSA	5539	0,6	BR8HVX	6265		BR8HIX	7001
K 12 50	50		BR8HSA	5539	0,6	BR8HVX	6265		BR8HIX	7001
KB 50	50		BR8HSA	5539	0,6	BR8HVX	6265		BR8HIX	7001
People 50	50	99 -	BR8HSA	5539	0,6	BR8HVX	6265		BR8HIX	7001
Scout	50	97 -	BR8HSA	5539	0,6	BR8HVX	6265		BR8HIX	7001
Sniper 50	50	01.93 -	BR8HSA	5539	0,6	BR8HVX	6265		BR8HIX	7001
Snuper 50 DD	50		BR8HSA	5539	0,6	BR8HVX	6265		BR8HIX	7001
Spacer 50	50	99 -	BR8HSA	5539	0,6	BR8HVX	6265		BR8HIX	7001
Super 9 AC	50	01 -	BR8HSA	5539	0,6	BR8HVX	6265		BR8HIX	7001
Super 9 LC	50	01 -	BR8HSA	5539	0,6	BR8HVX	6265		BR8HIX	7001
Tomos Classic;Quadro;Flexer	50	01 -	B6HS	4510	0,6	B6HVX	7435	203	BR6HIX	3419
Top Boy 50	50	01 -	BR8HSA	5539	0,6	BR8HVX	6265		BR8HIX	7001
Vitality 50 4Takt	50	05 -	CR7HSA	4549	0,5				CR7HIX	7544
Vitality 50 2Takt	50	05 -	BR8HSA	5539	0,6	BR8HVX	6265		BR8HIX	7001
Yager 50 2Takt	50	01 -	BR8HSA	5539	0,6	BR8HVX	6265		BR8HIX	7001
YUP 50	50	00 -	BR8HSA	5539	0,6	BR8HVX	6265		BR8HIX	7001
Cobra Racer 100	100	99 -	BR8HSA	5539	0,6	BR8HVX	6265		BR8HIX	7001
Agility 125	125	05 -	CR7HSA	4549	0,7				CR7HIX	7544
Calypso 125	125	97 -	C7HSA	4629	0,6	C7HVX	4533		CR7HIX	7544
CK 125	125	05 -	DR8EA	7162	0,6	DR8EVX	6354		DR8EIX	6681
Dink 125 4Takt	125	99 -	DPR7EA-9	5129	0,9	DPR7EVX-9	7682	220	DPR7EIX-9	7803
Grand Dink 125 4Takt	125	99 -	DPR7EA-9	5129	0,9	DPR7EVX-9	7682	220	DPR7EIX-9	7803
Heroism 125	125		C7HSA	4629	0,7	C7HVX	4533		CR7HIX	7544
Hipster 125 2 Ventiler	125	01 -	DR8EA	7162	0,7	DR8EVX	6354		DR8EIX	6681
Hipster 125 4 Ventiler	125		CR8E	1275	0,7	CR8EVX	6487	226	CR8EIX	4218

Order  
No.Platin  
Gold-  
Palla-  
diumOrder Quick  
No. No.Order  
No.**KYMCO**

Movie 125 4Takt	125		C7HSA	4629	0,6	C7HVX	4533		CR7HIX	7544
People 125	125	05 -	C7HSA	4629	0,6	C7HVX	4533		CR7HIX	7544
Pulsar 125	125	01 -	DR8EA	7162	0,7	DR8EVX	6354		DR8EIX	6681
Spacer	125	97 -	DPR7EA-9	5129	0,6	DPR7EVX-9	7682	220	DPR7EIX-9	7803
Spacer 125	125		DPR7EA-9	5129	0,9	DPR7EVX-9	7682	220	DPR7EIX-9	7803
Yager 125 4Takt	125	01 -	DPR7EA-9	5129	0,9	DPR7EVX-9	7682	220	DPR7EIX-9	7803
Zing	125	97 -	DR8EA	7162	0,6	DR8EVX	6354		DR8EIX	6681
Heroism	150		C7HSA	4629	0,7	C7HVX	4533		CR7HIX	7544
Dink 250 4Takt	250	99 -	DPR7EA-9	5129	0,9	DPR7EVX-9	7682	220	DPR7EIX-9	7803
Grand Dink 250 4Takt	250	99 -	DPR7EA-9	5129	0,9	DPR7EVX-9	7682	220	DPR7EIX-9	7803
People 250	250	05 -	DPR7EA-9	5129	0,9	DPR7EVX-9	7682	220	DPR7EIX-9	7803
Xciting 250	250	05 -	DPR7EA-9	5129	0,9	DPR7EVX-9	7682	220	DPR7EIX-9	7803
Xciting 500	500	05 -	CR8E	1275	0,7	CR8EVX	6487	226	CR8EIX	4218

**K-ZWO**

Cat 50	50	97 -	BR7HS	4122	0,6			211	BR7HIX	7067
K-zwo VIVA 50/25	50		BR7HS	4122	0,5			211	BR7HIX	7067
Motron Sting	50		BR7HS	4122	0,5			211	BR7HIX	7067
Motron Thunder	50		BR7HS	4122	0,5			211	BR7HIX	7067
Siamoto Falkon	50		C7HSA	4629	0,6	C7HVX	4533		CR7HIX	7544
Siamoto Scross	50		C7HSA	4629	0,6	C7HVX	4533		CR7HIX	7544
K-Zwo Apache	125		D8EA	2120	0,6	D8EVX	2850	216	DR8EIX	6681
K-Zwo Royal 125	125	96 -	C7HSA	4629	0,6	C7HVX	4533		CR7HIX	7544
Royal 125	125	96 -	C7HSA	4629	0,6	C7HVX	4533		CR7HIX	7544

**LECSON**

LTS 50 BW	50		BP6HS	4511	0,6	BP6HVX	4635		BPR6HIX	4085
LTS 50 TR	50		BP6HS	4511	0,6	BP6HVX	4635		BPR6HIX	4085

**LEM**

Flash (I)	50		BR7HS	4122	0,6			211	BR7HIX	7067
Ghibli (I)	50		BR7HS	4122	0,6			211	BR7HIX	7067

**LML- VESPA**

NV 125 SPL	125		BP8ES	2912	0,6	BP8EVX	2671			
NV 150 SPL	150		BP8ES	2912	0,6	BP8EVX	2671			
NV 200 SPL	200		B5ES	6410	0,6					

**MACAL**

GTX	50	98 -	BR7HS	4122	0,6			211	BR7HIX	7067
MY 50	50	99 -	BR7HS	4122	0,6			211	BR7HIX	7067
New Star	50	98 -	BR7HS	4122	0,6			211	BR7HIX	7067
Star Flight	50	98 -	BR7HS	4122	0,6			211	BR7HIX	7067
Trophy	50	98 -	BR8ES	5422	0,6	BR8EVX	1262	207	BR8EIX	5044

**MALAGUTI**

Centro	50	00 -	BR8HS	4322	0,5	BR8HVX	6265	212	BR8HIX	7001
Centro SL 50	50		BR7HS	4122	0,6			211	BR7HIX	7067
Centro 50	50	01.92 -	BR7HS	4122	0,6			211	BR7HIX	7067
Centro SL	50	93 -	BR7HS	4122	0,5			211	BR7HIX	7067
Ciak	50		BR8HS	4322	0,5	BR8HVX	6265	212	BR8HIX	7001
CR 1	50	10.95 -	BPR6HS	7022	0,5	BPR6HVX	2740	214	BPR6HIX	4085



Order No.



Gold-Palladium



Order Quick No. No.

Iridium



Order No.

**MALAGUTI**

Crosser CR1 50	50		BPR6HS	7022	0,6	BPR6HVX	2740	214	BPR6HIX	4085
ET	50		B6HS	4510	0,6	B6HVX	7435	203	BR6HIX	3419
F-10 Jetline	50	00 -	BR8HS	4322	0,5	BR8HVX	6265	212	BR8HIX	7001
F-10	50	93 -	BR7HS	4122	0,5			211	BR7HIX	7067
F-10 Jet Line 50	50	01.92 -	BR7HS	4122	0,6			211	BR7HIX	7067
F-10 Jet Line Tigers 50	50		BR7HS	4122	0,6			211	BR7HIX	7067
F-10 Jetline WAP	50	03 -	BR7HS	4122	0,6			211	BR7HIX	7067
F-11	50		BR8HS	4322	0,5	BR8HVX	6265	212	BR8HIX	7001
F-12 Phantom 3 AC	50	03 -	BR7HS	4122	0,6			211	BR7HIX	7067
F-12 LC	50		BR7HS	4122	0,5			211	BR7HIX	7067
F-12 Phantom	50		BR7HS	4122	0,5			211	BR7HIX	7067
F-12 Phantom AC	50	00 -	BR8HS	4322	0,5	BR8HVX	6265	212	BR8HIX	7001
F-12 Phantom LC dd	50	00 -	BR8HS	4322	0,5	BR8HVX	6265	212	BR8HIX	7001
F-12 Phantom	50		BR7HS	4122	0,6			211	BR7HIX	7067
F-15	50	97 -	BR8HS	4322	0,5	BR8HVX	6265	212	BR8HIX	7001
F-15 Firefox 50	50	01.96 -	BR8HS	4322	0,6	BR8HVX	6265	212	BR8HIX	7001
Grizzly RXC 12	50		BR8HS	4322	0,5	BR8HVX	6265	212	BR8HIX	7001
Grizzly RXC 10	50		BR6HS	3922	0,5			209	BR6HIX	3419
Phantom LC Tiger 50	50	01.93 -	BR7HS	4122	0,6			211	BR7HIX	7067
Yesterday	50	97 -	BR8HS	4322	0,6	BR8HVX	6265	212	BR8HIX	7001
Ciak 125 4Takt	125		CR7HSA	4549	0,7				CR7HIX	7544
Madison 125	125		CR8E	1275	0,7	CR8EVX	6487	226	CR8EIX	4218
Ciak 150 4Takt	150		CR7HSA	4549	0,7				CR7HIX	7544
F-12 Phantom Max 200	200	04 -	CR8EB	7784	0,6	CR8EVX	6487		CR8EIX	4218
Madison S 200	200	03 -	CR8EB	7784	0,6	CR8EVX	6487		CR8EIX	4218
Madison S250	250		DR8EA	7162	0,7	DR8EVX	6354		DR8EIX	6681
Madison 400	400	03 -	CR9E	6263	0,7	CR9EVX	5943	227	CR9EIX	3521
Spidermax 500 GT	500	04 -	CR7EKB	4455	0,6					

**MARS**

MK 50/1	50		BP6HS	4511	0,6	BP6HVX	4635		BPR6HIX	4085
SM 50	50		BP7HS	5111	0,6	BP7HVX	7468		BPR7HIX	5944
SM 50/1	50		BP7HS	5111	0,6	BP7HVX	7468		BPR7HIX	5944

**MBK**

Active 50 (I)	50		BR7HS	4122	0,6			211	BR7HIX	7067
Booster 50 (I)	50	01.90 - 94	BPR7HS	6422	0,6	BPR7HVX	2938	215	BPR7HIX	5944
Booster N.G. 50 (I)	50		BR8HS	4322	0,6	BR8HVX	6265	212	BR8HIX	7001
Booster NG (CW50RS)	50	97 -	BR8HS	4322	0,6	BR8HVX	6265	212	BR8HIX	7001
Booster (4FG) (CH)	50		BR8HS	4322	0,5	BR8HVX	6265	212	BR8HIX	7001
Booster (3TX) (GB)	50		BPR7HS	6422	0,5	BPR7HVX	2938	215	BPR7HIX	5944
Booster	50	93 -	BR7HS	4122	0,5			211	BR7HIX	7067
Booster Track (CW50RSX)	50	97 -	BR8HS	4322	0,6	BR8HVX	6265	212	BR8HIX	7001
Booster Rocket (CW50RSP)	50	97 -	BR8HS	4322	0,6	BR8HVX	6265	212	BR8HIX	7001
Booster (CW50)	50	97 -	BR8HS	4322	0,6	BR8HVX	6265	212	BR8HIX	7001
Booster R 50 (I)	50		BR7HS	4122	0,6			211	BR7HIX	7067
Booster Spirit 50 (I)	50		BR8HS	4322	0,6	BR8HVX	6265	212	BR8HIX	7001
CT 50 S - CT 50 SS (I)	50		BP7HS-10	7829	0,6					
Dakota	50	05 -	BR7HS	4122	0,6			211	BR7HIX	7067
Evolis 50 (YE50)	50	97 -	BR8HS	4322	0,6	BR8HVX	6265	212	BR8HIX	7001
Evolis (4FW)	50	93 -	BR7HS	4122	0,5			211	BR7HIX	7067
Evolis (4HU) (NL)	50		BR6HS	3922	0,5			209	BR6HIX	3419

Order  
No.Platin  
Gold-  
Palla-  
diumOrder Quick  
No. No.Order  
No.**MBK**

Evolis 50 (I)	50	01.92 -	BR7HS	4122	0,6			211	BR7HIX	7067
Fizz (YM50)	50	97 -	BR8HS	4322	0,6	BR8HVX	6265	212	BR8HIX	7001
Fizz	50	- 96	BR8HS	4322	0,5	BR8HVX	6265	212	BR8HIX	7001
Fizz 50 (I)	50	01.94 -	BR7HS	4122	0,6			211	BR7HIX	7067
Flipper	50		BR8HS	4322	0,6	BR8HVX	6265	212	BR8HIX	7001
Forte (3UG)	50	96 -	BR8HS	4322	0,6	BR8HVX	6265	212	BR8HIX	7001
Forte (YA50R)	50	97 -	BR7HS	4122	0,5			211	BR7HIX	7067
Forte 50 (I)	50	01.94 -	BR7HS	4122	0,6			211	BR7HIX	7067
Kansas	50	05 -	BR7HS	4122	0,6			211	BR7HIX	7067
Mach G	50		BR8HS	4322	0,6	BR8HVX	6265	212	BR8HIX	7001
Mach G LC 50	50		BR8HS	4322	0,6	BR8HVX	6265	212	BR8HIX	7001
New Sorriso 50 (I)	50	01.95 -	BP7HS	5111	0,6	BP7HVX	7468		BPR7HIX	5944
Nitro	50	97 -	BR8HS	4322	0,6	BR8HVX	6265	212	BR8HIX	7001
Nitro F1 "Mac Laren"	50	00 -	BR8HS	4322	0,6	BR8HVX	6265	212	BR8HIX	7001
Ovetto	50	01.97 -	BR8HS	4322	0,6	BR8HVX	6265	212	BR8HIX	7001
Phönix	50	05 -	BR7HS	4122	0,6			211	BR7HIX	7067
Sorriso 50 (I)	50		BP7HS-10	7829	0,6					
Stunt 50	50	03 -	BR8HS	4322	0,6	BR8HVX	6265	212	BR8HIX	7001
Target 50 (I)	50		BP7HS	5111	0,6	BP7HVX	7468		BPR7HIX	5944
X-Limit	50	05 -	BR9ES	5722	0,7	BR9EVX	1265	208	BR9EIX	3981
Evolis (4MU)(YE80)	80	96 -	BR7HS	4122	0,7			211	BR7HIX	7067
Zest (4MU)	80		BR7HS	4122	0,7			211	BR7HIX	7067
Nitro 100	100		BR8HS	4322	0,6	BR8HVX	6265	212	BR8HIX	7001
Ovetto 100	100		BR8HS	4322	0,6	BR8HVX	6265	212	BR8HIX	7001
Doodo 4T	125		CR8E	1275	0,7	CR8EVX	6487	226	CR8EIX	4218
Flame (XC125T)	125		CR7E	4578	0,6			225	CR7EIX	7385
Flame (XC125R)	125		CR7E	4578	0,6			225	CR7EIX	7385
Flame (4NB)	125		CR7E	4578	0,6			225	CR7EIX	7385
Skycruiser 125	125	06 -	CPR9EA-9	2308						
Skyliner	125	98 -	CR8E	1275	0,7	CR8EVX	6487	226	CR8EIX	4218
Thunder 125 4T	125		CR8E	1275	0,7	CR8EVX	6487	226	CR8EIX	4218
XC 125 Flame (I)	125	01.95 -	CR7E	4578	0,7			225	CR7EIX	7385
XC 125 Flame (I)	125	- 94	CR6HSA	2983	0,7				CR6HIX	7274
Vertex 150 (I)	150		CR7E	4578	0,7			225	CR7EIX	7385
Kilibre 300	300	03 -	DR8EA	7162	0,9	DR8EVX	6354		DR8EIX	6681
Skyliner 400	400	04 -	CR7E	4578	0,7			225	CR7EIX	7385

**MOTOTECHNIKA**

Motoroller "Myravey"	200	.73 -	BP6HS	4511	0,7	BP6HVX	4635		BPR6HIX	4085
----------------------	-----	-------	-------	------	-----	--------	------	--	---------	------

**MOTRON**

Spike (I)	50		BR7HS	4122	0,6			211	BR7HIX	7067
Sting 50	50	96 -	BR7HS	4122	0,6			211	BR7HIX	7067
Sting 50 (I)	50		BR7HS	4122	0,6			211	BR7HIX	7067
Syncro (I)	50		BR7HS	4122	0,6			211	BR7HIX	7067
Thunder 50	50	96 -	BR7HS	4122	0,6			211	BR7HIX	7067
Thunder S 50 (I)	50		BR7HS	4122	0,6			211	BR7HIX	7067

**MSA**

MX	50		BR8HSA	5539	0,5	BR8HVX	6265		BR8HIX	7001
RC	50	99 -	BR8ES	5422	0,6	BR8EVX	1262	207	BR8EIX	5044
RC Trophy Yacco	50	00 -	BR8ES	5422	0,6	BR8EVX	1262	207	BR8EIX	5044



Order  
No.Platin  
Gold-  
Palla-  
diumOrder Quick  
No. No.

Iridium

Order  
No.**MSA**

RC SM	50	99 -	BR8ES	5422	0,6	BR8EVX	1262	207	BR8EIX	5044
RSE	50	99 -	BR8ES	5422	0,6	BR8EVX	1262	207	BR8EIX	5044
RTW	50	00 -	BR8ES	5422	0,6	BR8EVX	1262	207	BR8EIX	5044
SM	50	01 -	BR8ES	5422	0,6	BR8EVX	1262	207	BR8EIX	5044

**MZ**

Moskito FB 50	50	97 -	BR7HS	4122	0,6			211	BR7HIX	7067
Moskito 50RX (not EG Country)	50	02 -	BPR6HS	7022	0,6	BPR6HVX	2740	214	BPR6HIX	4085
Moskito 50 SX (CPI50C)	50	99 -	BR7HS	4122	0,6			211	BR7HIX	7067
Moskito 50 RX (EG Country)	50	02 -	BR8HSA	5539	0,6	BR8HVX	6265		BR8HIX	7001
Moskito 125	125	01 -	CR7HSA	4549	0,6				CR7HIX	7544

**NSU**

Lambretta	175		B7HS	5110	0,5	B7HVX	7836	204	BR7HIX	7067
-----------	-----	--	------	------	-----	-------	------	-----	--------	------

**OTTO**

Fashion 50	50	96 -	BR8HSA	5539	0,6	BR8HVX	6265		BR8HIX	7001
GTX 50	50	96 -	BR7HS	4122	0,6			211	BR7HIX	7067

**PEGASUS**

Corona 25	50		BPR7HS	6422	0,5	BPR7HVX	2938	215	BPR7HIX	5944
Corona 50	50		BPR7HS	6422	0,5	BPR7HVX	2938	215	BPR7HIX	5944
Skipper 25	50		BPR7HS	6422	0,5	BPR7HVX	2938	215	BPR7HIX	5944
Skipper 50	50		BPR7HS	6422	0,5	BPR7HVX	2938	215	BPR7HIX	5944
Sky 25	50		BPR7HS	6422	0,5	BPR7HVX	2938	215	BPR7HIX	5944
Sky 25 High Wheels	50		BPR7HS	6422	0,5	BPR7HVX	2938	215	BPR7HIX	5944
Sky 50	50		BPR7HS	6422	0,5	BPR7HVX	2938	215	BPR7HIX	5944
Sky 50 High Wheels	50		BPR7HS	6422	0,5	BPR7HVX	2938	215	BPR7HIX	5944
Solero 25	50		BPR7HS	6422	0,5	BPR7HVX	2938	215	BPR7HIX	5944
Solero 50	50		BPR7HS	6422	0,5	BPR7HVX	2938	215	BPR7HIX	5944
Corona 125 Sport Edition	125		CR7HSA	4549	0,6				CR7HIX	7544
Corona 125 Comfort Edition	125		CR7HSA	4549	0,6				CR7HIX	7544
Skipper 125	125		CR7HSA	4549	0,7				CR7HIX	7544
Sky 125	125		CR7HSA	4549	0,7				CR7HIX	7544

**PEUGEOT**

Buxi 50; Road	50		B7HS	5110	0,6	B7HVX	7836	204	BR7HIX	7067
Buxy	50		B7HS	5110	0,6	B7HVX	7836	204	BR7HIX	7067
Eliséo 50	50	98 -	BR7HS	4122	0,7			211	BR7HIX	7067
Elystar Advantage 50	50		BR7HS	4122	0,7			211	BR7HIX	7067
Elystar TSDI 50	50		CR7EKA	1462	0,6					
Jet Force 50 / TSDI	50	03.03 -	CR7EKA	1462	0,6					
Jet Force C-Tech 50	50	05 -	CR7EB	4663	0,6					
Looxor Vergaser	50	01 -	BR7HS	4122	0,6			211	BR7HIX	7067
Looxor 50 TSDI	50		CPR8E	7411	0,6					
Ludix Blaster	50	04 -	BR7HS	4122	0,7			211	BR7HIX	7067
Ludix Classic	50	04 -	BR7HS	4122	0,6			211	BR7HIX	7067
Ludix Elegance	50	04 -	BR7HS	4122	0,6			211	BR7HIX	7067
Ludix One	50	04 -	BR7HS	4122	0,7			211	BR7HIX	7067
Ludix Snake	50	04 -	BR7HS	4122	0,7			211	BR7HIX	7067
Ludix Tend	50	04 -	BR7HS	4122	0,7			211	BR7HIX	7067
Metal-X 50	50		BR7HS	4122	0,6			211	BR7HIX	7067

Order  
No.Platin  
Gold-  
PalladiumOrder Quick  
No. No.Order  
No.**PEUGEOT**

Rapido	50		BP6HS	4511	0,6	BP6HVX	4635		BPR6HIX	4085
Speedake	50		B7HS	5110	0,6	B7HVX	7836	204	BR7HIX	7067
Speedake 50	50		B7HS	5110	0,6	B7HVX	7836	204	BR7HIX	7067
Speedfight LC	50	96 -	BR7HS	4122	0,6			211	BR7HIX	7067
Speedfight	50		BR8HS	4322	0,6	BR8HVX	6265	212	BR8HIX	7001
Speedfight M	50	96 -	BR7HS	4122	0,6			211	BR7HIX	7067
Speedfight LC "Prost X Team" " Watercool"	50	98 -	BR7HS	4122	0,7			211	BR7HIX	7067
Speedfight AC Air	50	98 -	BR7HS	4122	0,7			211	BR7HIX	7067
Speedfight 2 50 AC / LC	50		BR7HS	4122	0,7			211	BR7HIX	7067
Squab	50	96 -	BR8HS	4322	0,5	BR8HVX	6265	212	BR8HIX	7001
Squab 50 (I)	50		BR8HS	4322	0,6	BR8HVX	6265	212	BR8HIX	7001
ST 50 (I)	50		B7HS	5110	0,5	B7HVX	7836	204	BR7HIX	7067
ST 50; Metropolis (I)	50		B7HS	5110	0,6	B7HVX	7836	204	BR7HIX	7067
SV 50	50	- 95	B8HS	5510	0,6	B8HVX	2634	205	BR8HIX	7001
SV 50	50	96 -	BR8HS	4322	0,6	BR8HVX	6265	212	BR8HIX	7001
SV 50 Geo (I)	50		B8HS	5510	0,6	B8HVX	2634	205	BR8HIX	7001
SV 50 Junior	50		B8HS	5510	0,6	B8HVX	2634	205	BR8HIX	7001
TKR Streetboard 50 / WRC	50	00 -	BR7HS	4122	0,6			211	BR7HIX	7067
Trekker (I)	50		BR8HS	4322	0,6	BR8HVX	6265	212	BR8HIX	7001
Trekker Road	50		BR7HS	4122	0,6			211	BR7HIX	7067
Trekker Off Road	50	98 -	BR7HS	4122	0,6			211	BR7HIX	7067
Vivacity 50	50	99 -	BR7HS	4122	0,7			211	BR7HIX	7067
Zenith 50 (I)	50		B7HS	5110	0,5	B7HVX	7836	204	BR7HIX	7067
Zenith 50; F.D. (I)	50		B7HS	5110	0,6	B7HVX	7836	204	BR7HIX	7067
Zenith F.D. 50 (I)	50		B7HS	5110	0,5	B7HVX	7836	204	BR7HIX	7067
Zenith LM2	50	96 -	BR8HS	4322	0,5	BR8HVX	6265	212	BR8HIX	7001
SV 80	80		B8HS	5510	0,6	B8HVX	2634	205	BR8HIX	7001
Eliséo 100	100	98 -	BR8ES	5422	0,7	BR8EVX	1262	207	BR8EIX	5044
Looxor 100	100	02.01 -	BR8ES	5422	0,6	BR8EVX	1262	207	BR8EIX	5044
Speedfight 100	100	96 - 03	BR8ES	5422	0,6	BR8EVX	1262	207	BR8EIX	5044
Speedfight 2 100	100	03 -	BR8ES	5422	0,6	BR8EVX	1262	207	BR8EIX	5044
SV 100	100	96 -	BR8ES	5422	0,6	BR8EVX	1262	207	BR8EIX	5044
TKR 100	100	00 -	BR8ES	5422	0,6	BR8EVX	1262	207	BR8EIX	5044
Trekker 100	100	98 -	BR8ES	5422	0,6	BR8EVX	1262	207	BR8EIX	5044
Vivacity 100	100	99 -	BR8ES	5422	0,7	BR8EVX	1262	207	BR8EIX	5044
Eliséo 125	125	98 -	CR8E	1275	0,7	CR8EVX	6487	226	CR8EIX	4218
Eliséo Advantage 125	125	04 -	CR8E	1275	0,7	CR8EVX	6487	226	CR8EIX	4218
Elystar ABS/PBS 125	125		CR7EB	4663	0,7	CR8EVX	6487	226	CR8EIX	4218
Elystar 125	125		CR7EB	4663	0,7	CR8EVX	6487	226	CR8EIX	4218
Geopolis 125	125	06 -	CR9EB	6955	0,6					
Jet Force 125	125	03.03 -	CR9EB	6955	0,6					
Jet Force 125 Compressor	125	05 -	CR8EKB	4374	0,7				CR8EIX	4218
Looxor 125	125		CR7EB	4663	0,6					
Ludix 125	125	04 -	CR9EB	6955	0,6					
Satelis 125	125	04 -	CR9EB	6955	0,6					
Satelis 125 Kompressor	125	06 -	CR9EB	6955	0,6					
SV 125	125		BP6HS	4511	0,6	BP6HVX	4635		BPR6HIX	4085
SV 125; Metropolis (I)	125		BP6HS	4511	0,6	BP6HVX	4635		BPR6HIX	4085
Elyseo 150	150	00 -	CR8E	1275	0,7	CR8EVX	6487	226	CR8EIX	4218
Elystar 150	150		CR7EB	4663	0,7			225	CR7EIX	7385
Looxor 150	150		CR7EB	4663	0,6					
Satelis 250	250	06 -	CR9EB	6955	0,6					



Order No.



Gold-Palladium

Platin



Order No.

Quick No.

Iridium



Order No.

**PEUGEOT**

SV 250	250	01 -	DPR7EA-9	5129	0,9	DPR7EVX-9	7682	220	DPR7EIX-9	7803
--------	-----	------	----------	------	-----	-----------	------	-----	-----------	------

**PGO**

Big Max 25/50	50		BPR7HS	6422	0,5	BPR7HVX	2938	215	BPR7HIX	5944
Big Max 50	50		BPR7HS	6422	0,5	BPR7HVX	2938	215	BPR7HIX	5944
Big Max Sport 50	50	96 -	BP7HS	5111	0,6	BP7HVX	7468		BPR7HIX	5944
Comet	50		BP7HS	5111	0,6	BP7HVX	7468		BPR7HIX	5944
Galaxy 25	50		BP7HS	5111	0,6	BP7HVX	7468		BPR7HIX	5944
Galaxy 50	50		BP7HS	5111	0,6	BP7HVX	7468		BPR7HIX	5944
G-Max	50	04 -	BPR7HS	6422	0,6	BPR7HVX	2938	215	BPR7HIX	5944
Mega 50	50	96 -	BPR7HS	6422	0,5	BPR7HVX	2938	215	BPR7HIX	5944
New Galaxy 50 (I)	50		BP6HS	4511	0,6	BP6HVX	4635		BPR6HIX	4085
PMS 50	50	99 -	BP7HS	5111	0,6	BP7HVX	7468		BPR7HIX	5944
PMX 50	50	99 -	BP7HS	5111	0,6	BP7HVX	7468		BPR7HIX	5944
Rodoshow	50	02.00 -	BP7HS	5111	0,6	BP7HVX	7468		BPR7HIX	5944
Star 2	50		BP7HS	5111	0,6	BP7HVX	7468		BPR7HIX	5944
Star 50	50		BP6HS	4511	0,6	BP6HVX	4635		BPR6HIX	4085
Super Comet 50 (I)	50		BP7HS	5111	0,6	BP7HVX	7468		BPR7HIX	5944
Tornado 50	50	97 -	BPR7HS	6422	0,5	BPR7HVX	2938	215	BPR7HIX	5944
T-REX 50	50	99 -	BP7HS	5111	0,6	BP7HVX	7468		BPR7HIX	5944
Star 80	80		BP6HS	4511	0,6	BP6HVX	4635		BPR6HIX	4085
Big Max 90	82	96 -	BPR7HS	6422	0,5	BPR7HVX	2938	215	BPR7HIX	5944
Galaxy 90	90		BPR7HS	6422	0,6	BPR7HVX	2938	215	BPR7HIX	5944
G-Max	125	05 -	C7HSA	4629	0,7	C7HVX	4533		CR7HIX	7544
Tornado 1.25	125	97 -	BPR7HS	6422	0,5	BPR7HVX	2938	215	BPR7HIX	5944
T-REX 125 2T	125	99 -	BP7HS	5111	0,6	BP7HVX	7468		BPR7HIX	5944
T-REX 125 4T	125	99 -	C7HSA	4629	0,6	C7HVX	4533		CR7HIX	7544
T-REX 150 4T	150	03 -	C7HSA	4629	0,6	C7HVX	4533		CR7HIX	7544

**PIAGGIO / VESPA**

Free 25 Mofa	25		BP8ES	2912	0,5	BP8EVX	2671			
Zip 25 Mofa	25		BPR8ES	3923	0,5	BPR8EVX	5573	213		
Zip Base 25 / Mofa	25		BPR8ES	3923	0,5	BPR8EVX	5573	213		
50 R, Special	50		B6HS	4510	0,5	B6HVX	7435	203	BR6HIX	3419
50 S	50		B6HS	4510	0,5	B6HVX	7435	203	BR6HIX	3419
APE 50	50		B6HS	4510	0,5	B6HVX	7435	203	BR6HIX	3419
Boss	50		B6HS	4510	0,6	B6HVX	7435	203	BR6HIX	3419
Boss	50		B6HS	4510	0,5	B6HVX	7435	203	BR6HIX	3419
Bravo PV	50		BR6HS	3922	0,7			209	BR6HIX	3419
Bravo - Si / Moped	50		B5HS	4210	0,5					
Bravo P	50		BR6HS	3922	0,7			209	BR6HIX	3419
Ciao M Kat	50		BR6HS	3922	0,7			209	BR6HIX	3419
Ciao Mix / Mix	50		B5HS	4210	0,5					
Ciao V Kat	50		BR6HS	3922	0,7			209	BR6HIX	3419
Ciao-Bravo SI / Mofa	50		B5HS	4210	0,5					
Diesis 50	50		BR9ES	5722	0,7	BR9EVX	1265	208	BR9EIX	3981
Eaglet	50		B9ES	2611	0,5	B9EVX	7254	202	BR9EIX	3981
ET2 (iniezione / Einspritzer)	50	98 -			0,6	DCPR9EVX	6436			
ET2 (carbureter/Vergaser)	50	98 -	BR9ES	5722	0,6	BR9EVX	1265	208	BR9EIX	3981
Fly 50 4T	50	06 -	PMR7A	4259		PMR7A	4259			
Fly 50 2T	50	06 -	BR9ES	5722	0,6	BR9EVX	1265	208	BR9EIX	3981
Free Kat	50		BR9ES	5722	0,7	BR9EVX	1265	208	BR9EIX	3981

Order  
No.Gold-  
Palla-  
dium

Platin

Order Quick  
No. No.

Iridium

Order  
No.**PIAGGIO / VESPA**

Free 50	50	93 -	B9ES	2611	0,5	B9EVX	7254	202	BR9EIX	3981
Free Business 50	50	01.96 -	B9ES	2611	0,6	B9EVX	7254	202	BR9EIX	3981
Grillo / Mofa	50		B5HS	4210	0,5					
Liberty	50	01.97 -	B9ES	2611	0,6	B9EVX	7254	202	BR9EIX	3981
Liberty Kat	50		BR9ES	5722	0,7	BR9EVX	1265	208	BR9EIX	3981
Liberty 4T	50	02 -	CR9EB	6955	0,8				CR9EIX	3521
NRG mc2 50	50	01.96 -	B9EG	3530	0,6	B9EGV	5827		BR9EIX	3981
NRG	50		B9ES	2611	0,5	B9EVX	7254	202	BR9EIX	3981
NRG Extreme	50		B9ES	2611	0,5	B9EVX	7254	202	BR9EIX	3981
NRG Extreme Kat	50		B9ES	2611	0,5	B9EVX	7254	202	BR9EIX	3981
NRG H_0 Kat	50		B9ES	2611	0,5	B9EVX	7254	202	BR9EIX	3981
NRG mc2 DT,DD	50		B9ES	2611	0,5	B9EVX	7254	202	BR9EIX	3981
NRG 50	50	01.94 -	B9ES	2611	0,6	B9EVX	7254	202	BR9EIX	3981
NRG mc3 Pure Jet	50	02 -	CPR8E	7411	0,6					
NRG Power DT Purejet	50	05 -	CPR8E	7411	0,6					
NSP 4T (Aria)	50	02 -	CR9EB	6955	0,8				CR9EIX	3521
NTT 50	50	01.95 -	B9ES	2611	0,6	B9EVX	7254	202	BR9EIX	3981
PK 50 S	50	09.82 -12.87	B6HS	4510	0,5	B6HVX	7435	203	BR6HIX	3419
PK 50 XL2 Auto	50		B8ES	2411	0,5	B8EVX	7051	201	BR8EIX	5044
PK 50 SS	50		B7HS	5110	0,5	B7HVX	7836	204	BR7HIX	7067
PK 50 S Auto	50		BR7ES	5122	0,5	BR7EVX	4556			
PK 50 XL 2	50		BR7HS	4122	0,6			211	BR7HIX	7067
PK 50	50	09.82 -12.87	B6HS	4510	0,5	B6HVX	7435	203	BR6HIX	3419
Plurimatic	50		B6HS	4510	0,5	B6HVX	7435	203	BR6HIX	3419
PX 50	50		B6HS	4510	0,5	B6HVX	7435	203	BR6HIX	3419
Quarz 50	50	01.92 -	B9ES	2611	0,6	B9EVX	7254	202	BR9EIX	3981
Quarz 50 Automatic	50	06.92 -	B9ES	2611	0,5	B9EVX	7254	202	BR9EIX	3981
Rush	50		BR7HS	4122	0,6			211	BR7HIX	7067
Sfera 50 Automatico	50	01.91 -	B9ES	2611	0,5	B9EVX	7254	202	BR9EIX	3981
Sfera 50	50	01.90 -	B9ES	2611	0,6	B9EVX	7254	202	BR9EIX	3981
Sfera 50 , FL, RL, RST	50		B9ES	2611	0,5	B9EVX	7254	202	BR9EIX	3981
Sfera RL 50	50		B9ES	2611	0,6	B9EVX	7254	202	BR9EIX	3981
Skipper	50		BR9ES	5722	0,6	BR9EVX	1265	208	BR9EIX	3981
Storm Automatic	50	94 -	B9ES	2611	0,5	B9EVX	7254	202	BR9EIX	3981
Super Bravo / Mofa	50		B5HS	4210	0,5					
Super Bravo 2 Gang / Mofa	50		B5HS	4210	0,5					
TPH	50	93 -	B9ES	2611	0,5	B9EVX	7254	202	BR9EIX	3981
Typhoon air / X 50	50	01.96 -	BR9ES	5722	0,7	BR9EVX	1265	208	BR9EIX	3981
Velofax 50	50	01.95 -	B8ES	2411	0,5	B8EVX	7051	201	BR8EIX	5044
Velofax 50 AE	50	01.95 -	B8ES	2411	0,5	B8EVX	7051	201	BR8EIX	5044
Velofax / Mofa	50		BP8ES	2912	0,6	BP8EVX	2671			
Vespa Elestart	50		B6HS	4510	0,5	B6HVX	7435	203	BR6HIX	3419
Vespa Vale Especial/Standard	50		B5HS	4210	0,5					
Vespa ET2 IE	50					DCPR9EVX	6436			
Vespa PK 50 XL 2 ,Automatic	50		B8ES	2411	0,5	B8EVX	7051	201	BR8EIX	5044
Vespa HP 4M	50		B6HS	4510	0,5	B6HVX	7435	203	BR6HIX	3419
Vespa LX 50 2T	50		BR9ES	5722	0,7	BR9EVX	1265	208	BR9EIX	3981
Vespa Delta,Puch Condor	50		B7HS	5110	0,5	B7HVX	7836	204	BR7HIX	7067
Vespa ET 4	50	02 -	CR9EB	6955	0,8				CR9EIX	3521
LX 50 2T	50	06 -	BR9ES	5722	0,7	BR9EVX	1265	208	BR9EIX	3981
Vespa ET3 Primavera	50		BR7HS	4122	0,6			211	BR7HIX	7067
Vespa LX 50 4T	50	06 -				PMR7A	4259			

Order  
No.Platin  
Gold-  
Palla-  
diumOrder Quick  
No. No.

Iridium

Order  
No.**PIAGGIO / VESPA**

Vespa 50 HP 4M	50	01.93 -	B7HS	5110	0,5	B7HVX	7836	204	BR7HIX	7067
Vespino NX/SC/T/TL/TN/TS	50		BR7HS	4122	0,6			211	BR7HIX	7067
Vespino	50		BR7HS	4122	0,6			211	BR7HIX	7067
Vespino TX/XE	50		BR7HS	4122	0,6			211	BR7HIX	7067
Zip Base 50	50		B9ES	2611	0,5	B9EVX	7254	202	BR9EIX	3981
Zip 50 SP	50				0,5	B9EG	3530			
Zip 50 RST	50		B9ES	2611	0,6	B9EVX	7254	202	BR9EIX	3981
Zip Kat	50		BPR8ES	3923	0,5	BPR8EVX	5573	213		
Zip 50	50	01.92 -	B9ES	2611	0,6	B9EVX	7254	202	BR9EIX	3981
Zip 50 Fast Rider	50	01.93 -	B9ES	2611	0,6	B9EVX	7254	202	BR9EIX	3981
Zip 50 SP	50	01.96 -	B9ES	2611	0,6	B9EVX	7254	202	BR9EIX	3981
Zip water	50	01.96 -	B10ES	7928	0,7	B10EVX	7335		BR10EIX	6801
Zip 4 4T	50		CR7E	4578	0,6			225	CR7EIX	7385
Zip air	50	01.96 -	BR9ES	5722	0,7	BR9EVX	1265	208	BR9EIX	3981
Zip & Zip (Hybrid)	50	94 -	B9ES	2611	0,5	B9EVX	7254	202	BR9EIX	3981
Zip & Zip 50 4 T Aria	50	02 -	CR9EB	6955	0,8				CR9EIX	3521
Zip & Zip 50	50	01.94 -	B9ES	2611	0,6	B9EVX	7254	202	BR9EIX	3981
SKR City	75		BR9ES	5722	0,6	BR9EVX	1265	208	BR9EIX	3981
Vespa PK 75S/Elestart/Junior	75		B7HS	5110	0,5	B7HVX	7836	204	BR7HIX	7067
Vespa PK 75XL/ Elestart	75		B9ES	2611	0,6	B9EVX	7254	202	BR9EIX	3981
Vespa PK 75S Primavera / T3 Prima.	75		B7HS	5110	0,5	B7HVX	7836	204	BR7HIX	7067
PK 80 S	80	09.82 -12.85	BR7HS	4122	0,6			211	BR7HIX	7067
PX 80 E Lusso	80		B6ES	7310	0,5	B6EVX	5136			
PX 80 E,P 80 X	80		B6ES	7310	0,5	B6EVX	5136			
Sfera 80 Automatic	80		B9ES	2611	0,5	B9EVX	7254	202	BR9EIX	3981
Skipper	80		B9ES	2611	0,6	B9EVX	7254	202	BR9EIX	3981
TPH Automatic	80	94 -	B9ES	2611	0,5	B9EVX	7254	202	BR9EIX	3981
Typhoon	80		BR9ES	5722	0,6	BR9EVX	1265	208	BR9EIX	3981
Diesis 100	100	01 -	CR8EB	7784	0,6	CR8EVX	6487		CR8EIX	4218
Free 100	100	02 -	CR8EB	7784	0,6	CR8EVX	6487		CR8EIX	4218
PK 100 S	100	06.82 -	BR7HS	4122	0,6			211	BR7HIX	7067
125 T5	125	03.85 -	B8ES	2411	0,6	B8EVX	7051	201	BR8EIX	5044
Ape	125		B7HS	5110	0,5	B7HVX	7836	204	BR7HIX	7067
Beverly 125	125	02 -	CR8EB	7784	0,6	CR8EVX	6487		CR8EIX	4218
Cosa 125	125	- 91	B8ES	2411	0,5	B8EVX	7051	201	BR8EIX	5044
Cosa FL 125	125	91 -	B9ES	2611	0,5	B9EVX	7254	202	BR9EIX	3981
Cosa 200 FL EBC 12PS	125		B8ES	2411	0,5	B8EVX	7051	201	BR8EIX	5044
Cosa 125 MA AE	125	01.88 -	B9ES	2611	0,6	B9EVX	7254	202	BR9EIX	3981
ET 3	125		BR7HS	4122	0,6			211	BR7HIX	7067
ET 4 Automatic	125		CR7EB	4663	0,6					
Fly 125	125	05 -	CR7EB	4663	0,6					
Hexagon LX 4Takt 2V Air	125		CR7EB	4663	0,6					
Hexagon LX 4T / 4V H2O watercooler	125		CR8EB	7784	0,6	CR8EVX	6487		CR8EIX	4218
Hexagon LX 125	125	94 -	B9ES	2611	0,5	B9EVX	7254	202	BR9EIX	3981
Liberty 125	125		CR7E	4578	0,6			225	CR7EIX	7385
Liberty 4Takt	125		CR7EB	4663	0,6					
P 125 ETS	125	01.83 -12.85	BR7HS	4122	0,6			211	BR7HIX	7067
PK 125 XL Automatic	125		BR7HS	4122	0,6			211	BR7HIX	7067
PK 125, E, S	125		BR6HS	3922	0,5			209	BR6HIX	3419
PK Automatic	125		B7HS	5110	0,5	B7HVX	7836	204	BR7HIX	7067
PK 125 XL 2	125		B8ES	2411	0,5	B8EVX	7051	201	BR8EIX	5044
Primavera	125	01.76 -12.83	BR7HS	4122	0,6			211	BR7HIX	7067

Order  
No.Gold-  
Palla-  
dium

Platin

Order Quick  
No. No.Order  
No.**PIAGGIO / VESPA**

PX 125 E Lusso	125	01.82 -	B6HS	4510	0,5	B6HVX	7435	203	BR6HIX	3419
Sfera RL 125 - 4Takt	125		CR9E	6263	0,6	CR9EVX	5943	227	CR9EIX	3521
Sfera RST 4 Takt	125	95 -	CR7E	4578	0,6			225	CR7EIX	7385
Sfera 125	125	01.95 -	CR9E	6263	0,6	CR9EVX	5943	227	CR9EIX	3521
Skipper 125 LX	125	01.93 -	B9ES	2611	0,6	B9EVX	7254	202	BR9EIX	3981
Skipper 125 4 Takt	125	00 -	CR7EB	4663	0,6					
SKR 125	125	08.93 -	B9ES	2611	0,5	B9EVX	7254	202	BR9EIX	3981
Super Hexagon GTX 125 4Takt	125	01 -	CR8EB	7784	0,6	CR8EVX	6487		CR8EIX	4218
TPH	125	95 -	B9ES	2611	0,5	B9EVX	7254	202	BR9EIX	3981
Vespa 125 CL/LS/NK Primavera	125		B6HS	4510	0,5	B6HVX	7435	203	BR6HIX	3419
Vespa PX 125 MA AE	125	.86 -	B6HS	4510	0,5	B6HVX	7435	203	BR6HIX	3419
Vespa ET4	125	99 -	CR7EB	4663	0,6					
Vespa LX 125	125	05 -	CR7EB	4663	0,6					
Vespa PK 125	125	.85 -	BR7HS	4122	0,6			211	BR7HIX	7067
Vespa PX 125 MA AE	125	01.96 -	B6HS	4510	0,6	B6HVX	7435	203	BR6HIX	3419
Vespa T5	125		B9ES	2611	0,5	B9EVX	7254	202	BR9EIX	3981
Vespa PX 125 Kat	125		B9ES	2611	0,5	B9EVX	7254	202	BR9EIX	3981
Vespa Special ET3 Primavera	125		B7HS	5110	0,6	B7HVX	7836	204	BR7HIX	7067
Vespa 125 FL2	125	01.90 -	B7HS	5110	0,6	B7HVX	7836	204	BR7HIX	7067
Vespa Gandturismo	125	-04.04	CR9EB	6955	0,6				CR9EIX	3521
Vespa ET4 125	125	01.96 -	CR8EB	7784	0,7	CR8EVX	6487		CR8EIX	4218
Vespa Special ET4 Carburatore	125		CR8EB	7784	0,6	CR8EVX	6487		CR8EIX	4218
Vespa GT	125	03 -	CR8EB	7784	0,6	CR8EVX	6487		CR8EIX	4218
Vespa XL 125 Plurimat/Elestart	125		B7HS	5110	0,6	B7HVX	7836	204	BR7HIX	7067
Vespa 125 T5 Sport/Elestart	125		B9ES	2611	0,6	B9EVX	7254	202	BR9EIX	3981
Vespa T3Li/T3	125		B6HS	4510	0,5	B6HVX	7435	203	BR6HIX	3419
X 8	125	04 -	CR8EB	7784	0,6	CR8EVX	6487		CR8EIX	4218
X 9 11kW	125	05.02 -	CR8EB	7784	0,6	CR8EVX	6487		CR8EIX	4218
X 9 11kW	125	-04.02	CR9EB	6955	0,6				CR9EIX	3521
Zip 125	125		CR9EB	6955	0,6				CR9EIX	3521
Cosa	150		BR9ES	5722	0,6	BR9EVX	1265	208	BR9EIX	3981
EX 150 (Hexagon)	150	94 -	B9ES	2611	0,5	B9EVX	7254	202	BR9EIX	3981
Hexagon 150	150	01.94 -	B9ES	2611	0,6	B9EVX	7254	202	BR9EIX	3981
Liberty	150		CR7EB	4663	0,6					
PX 150 E Lusso	150	01.82 -	B6HS	4510	0,5	B6HVX	7435	203	BR6HIX	3419
Skipper 150	150	01.93 -	B9ES	2611	0,6	B9EVX	7254	202	BR9EIX	3981
Skipper ST 150 4Takt	150	- 00	BR9ES	5722	0,7	BR9EVX	1265	208	BR9EIX	3981
Skipper ST 4T	150	01 -	CR7EB	4663	0,6					
SKR 150	150	98 -	B9ES	2611	0,5	B9EVX	7254	202	BR9EIX	3981
Vespa PX 150 MA AE	150	.86 -	B6HS	4510	0,5	B6HVX	7435	203	BR6HIX	3419
Vespa PX 150 MA AE	150	01.96 -	B6HS	4510	0,6	B6HVX	7435	203	BR6HIX	3419
Vespa 150 ET4	150	- 01	CR7E	4578	0,6			225	CR7EIX	7385
Vespa PX 150 Kat	150		BR6HS	3922	0,7			209	BR6HIX	3419
Vespa 150 ET4	150	01 - 02	CR8EB	7784	0,6	CR8EVX	6487		CR8EIX	4218
Vespa 150 long 12,7 mm	150		B6HS	4510	0,5	B6HVX	7435	203	BR6HIX	3419
Vespa 150 long 19,0 mm	150		B6ES	7310	0,5	B6EVX	5136			
Vespa 150 ET 4	150	02 -	CR7EB	4663	0,8					
Vespa 160/ GT	160		B6HS	4510	0,5	B6HVX	7435	203	BR6HIX	3419
Vespa 175	175		B6HS	4510	0,5	B6HVX	7435	203	BR6HIX	3419
Hexagon LXT 180	180	01.98 -	B9ES	2611	0,6	B9EVX	7254	202	BR9EIX	3981
Super Hexagon LXT 180	180	01 -	CR8EB	7784	0,6	CR8EVX	6487		CR8EIX	4218
Vespa SS	180		B6HS	4510	0,5	B6HVX	7435	203	BR6HIX	3419

Order  
No.Platin  
Gold-  
Palla-  
diumOrder Quick  
No. No.

Iridium

Order  
No.**PIAGGIO / VESPA**

X 9 4T Amalfi	180	01 -	CR8EB	7784	0,6	CR8EVX	6487		CR8EIX	4218
Ape	190		B7HS	5110	0,5	B7HVX	7836	204	BR7HIX	7067
Cosa 2 200 MA AE	200	01.88 -	BR8ES	5422	0,6	BR8EVX	1262	207	BR8EIX	5044
Beverly 200	200	01 -	CR8EB	7784	0,6	CR8EVX	6487		CR8EIX	4218
Cosa 200 Aluzyl.12PS	200	93 - 97	BR8ES	5422	0,6	BR8EVX	1262	207	BR8EIX	5044
Cosa 2 200	200	01.88 - 91	BR8ES	5422	0,6	BR8EVX	1262	207	BR8EIX	5044
Cosa FL 200	200	91 -	BR8ES	5422	0,6	BR8EVX	1262	207	BR8EIX	5044
Cosa 200 MA AE	200	01.88 -	BR8ES	5422	0,6	BR8EVX	1262	207	BR8EIX	5044
Cosa MA AE	200		BR8ES	5422	0,6	BR8EVX	1262	207	BR8EIX	5044
DN	200		BR7ES	5122	0,5	BR7EVX	4556			
DS	200		BR7ES	5122	0,5	BR7EVX	4556			
PE	200		BR7ES	5122	0,5	BR7EVX	4556			
PX 200 E Lusso	200	01.84 -	BR7ES	5122	0,5	BR7EVX	4556			
PX 200 E Grand-Sport	200	01.84 -	BR7ES	5122	0,5	BR7EVX	4556			
Vespa 200 DN/ DS/ E	200		B5ES	6410	0,5					
Vespa Granturimo 200 L	200		CR7EKB	4455	0,6					
Vespa PX 200 MA AE	200	01.96 -	B6ES	7310	0,6	B6EVX	5136			
Vespa PX 200E/Iris/Iris Elestart	200		B7ES	1111	0,6	B7EVX	6934			
Vespa PX 200 MA AE	200	.86 -	B6ES	7310	0,5	B6EVX	5136			
Vespa 200 TX/Elestart	200		B7ES	1111	0,6	B7EVX	6934			
Vespa Rally	200		BR7ES	5122	0,5	BR7EVX	4556			
X 8 200	200	05 -	CR7EKB	4455	0,6					
Ape	220		B7HS	5110	0,5	B7HVX	7836	204	BR7HIX	7067
Beverly 250	250	03 -	CR7EKB	4455	0,6					
Hexagon GT 250 4Takt	250	98 -	DPR6EA-9	5531	0,9					
Super Hexagon GTX 250	250		CR9E	6263	0,7	CR9EVX	5943	227	CR9EIX	3521
Vespa GTS 250	250	06 -	CR8EB	7784	0,6	CR8EVX	6487		CR8EIX	4218
Vespa GTS 250 IE	250	06 -	CR8EB	7784	0,6	CR8EVX	6487		CR8EIX	4218
X 8 250 i.e.	250	06 -	CR8EB	7784	0,6	CR8EVX	6487		CR8EIX	4218
X 9 Evolution	250		CR8EB	7784	0,6	CR8EVX	6487		CR8EIX	4218
X 9 (4T)	250	00 - 03	DPR7EA-9	5129	0,9	DPR7EVX-9	7682	220	DPR7EIX-9	7803
Beverly 500	500	03 -	CR7EKB	4455	0,6				CR7EIX	7385
X 9 EVO (4T)	500	04 -	CR7EKB	4455	0,6				CR7EIX	7385
X 9 (4T)	500	11.03 -	CR7EKB	4455	0,6				CR7EIX	7385

**PUCH**

Lido	50		BPR6HS	7022	0,7	BPR6HVX	2740	214	BPR6HIX	4085
Lido 125	125		DR8ES	5423	0,7	DR8EVX	6354	217	DR8EIX	6681

**RENAULT SPORT**

Campus	50	01 -	BR8ES	5422	0,6	BR8EVX	1262	207	BR8EIX	5044
Spécimen	50	01 -	BR8HS	4322	0,6	BR8HVX	6265	212	BR8HIX	7001
Spécimen	100	01 -	BR8HS	4322	0,6	BR8HVX	6265	212	BR8HIX	7001
Fulltime	125	01 -	CR9EB	6955	0,6				CR9EIX	3521
Groomy	125	01 -	CR9EB	6955	0,6				CR9EIX	3521
Kouranos	125	01 -	CR9EB	6955	0,6				CR9EIX	3521

**REX**

Rex 25	25		BPR7HS	6422	0,6	BPR7HVX	2938	215	BPR7HIX	5944
Rexy 50	25	96 -	BPR7HS	6422	0,6	BPR7HVX	2938	215	BPR7HIX	5944
Rexy 25	25	96 -	BPR7HS	6422	0,6	BPR7HVX	2938	215	BPR7HIX	5944
Rex 50	50	96 -	BPR7HS	6422	0,6	BPR7HVX	2938	215	BPR7HIX	5944

Order  
No.Platin  
Gold-  
Palla-  
diumOrder Quick  
No. No.Order  
No.**REX**

Scooter	50	96 -	BPR7HS	6422	0,6	BPR7HVX	2938	215	BPR7HIX	5944
Silver Star	50		BPR7HS	6422	0,6	BPR7HVX	2938	215	BPR7HIX	5944
Silver Street	50		BPR7HS	6422	0,6	BPR7HVX	2938	215	BPR7HIX	5944
Rex 125	125	97 -	CR7HSA	4549	0,5				CR7HIX	7544
Rexy 125	125		CR7HSA	4549	0,5				CR7HIX	7544

**RIEJU**

Drac 50 (AM5)	50	96 -	BR8ES	5422	0,6	BR8EVX	1262	207	BR8EIX	5044
MRX 50 EURO (AM6)	50	02 -	BR9ES	5722	0,6	BR9EVX	1265	208	BR9EIX	3981
MRX 50 Top (AM6)	50	03 -	BR9ES	5722	0,6	BR9EVX	1265	208	BR9EIX	3981
MX 50 Infantil (Morini S5)	50	01 - 01	B6HS	4510	0,5	B6HVX	7435	203	BR6HIX	3419
MX 50 Infantil (Morini S6)	50	02 -	B9ES	2611	0,6	B9EVX	7254	202	BR9EIX	3981
NKD 50 (AM6)	50	03 -	BR9ES	5722	0,6	BR9EVX	1265	208	BR9EIX	3981
RR 50 (AM5)	50	97 -	BR8ES	5422	0,6	BR8EVX	1262	207	BR8EIX	5044
RR 50 (AM6)	50	01 -	BR8ES	5422	0,6	BR8EVX	1262	207	BR8EIX	5044
RR 50 Castrol (AM6)	50	02 -	BR9ES	5722	0,6	BR9EVX	1265	208	BR9EIX	3981
RR 50 EURO (AM6)	50	02 -	BR9ES	5722	0,6	BR9EVX	1265	208	BR9EIX	3981
RS1 (AM5)	50	97 -	BR8ES	5422	0,6	BR8EVX	1262	207	BR8EIX	5044
RS1 EVO (AM6)	50	98 -	BR8ES	5422	0,6	BR8EVX	1262	207	BR8EIX	5044
RS1 EVO EURO (AM6)	50	02 -	BR9ES	5722	0,6	BR9EVX	1265	208	BR9EIX	3981
RS2 Matrix (AM6)	50	03 -	BR9ES	5722	0,6	BR9EVX	1265	208	BR9EIX	3981
SMX 50 EURO (AM6)	50	02 -	BR9ES	5722	0,6	BR9EVX	1265	208	BR9EIX	3981
Windy (MY50)	50		BR7HS	4122	0,5			211	BR7HIX	7067
MRX 125 (Yamaha)	125	02 -	CR7HSA	4549	0,6				CR7HIX	7544
SMX 125 (Yamaha)	125	02 -	CR7HSA	4549	0,6				CR7HIX	7544

**RIVERO**

Linos 50	50		BPR7HS	6422	0,5	BPR7HVX	2938	215	BPR7HIX	5944
----------	----	--	--------	------	-----	---------	------	-----	---------	------

**ROYAL**

Royal 125	125	96 -	C7HSA	4629	0,6	C7HVX	4533		CR7HIX	7544
-----------	-----	------	-------	------	-----	-------	------	--	--------	------

**SACHS**

49er	50	05 -	CR7HSA	4549	0,5				CR7HIX	7544
Buxy (RS)	50		B7HS	5110	0,6	B7HVX	7836	204	BR7HIX	7067
City Roller CV 50	50		BPR6HS	7022	0,7	BPR6HVX	2740	214	BPR6HIX	4085
Limbo	50		BP6HS	4511	0,6	BP6HVX	4635		BPR6HIX	4085
MadAss 50	50	04 -	CR7HSA	4549	0,6				CR7HIX	7544
Reggae (RS)	50		B7HS	5110	0,6	B7HVX	7836	204	BR7HIX	7067
Samba SR	50		B8HS	5510	0,5	B8HVX	2634	205	BR8HIX	7001
Speedake	50		B7HS	5110	0,6	B7HVX	7836	204	BR7HIX	7067
Speedfight 50 AC	50	97 -	BR7HS	4122	0,6			211	BR7HIX	7067
Speedfight 50 LC	50	97 -	BR7HS	4122	0,6			211	BR7HIX	7067
Speedfight 50 LC ADT	50	97 -	BR7HS	4122	0,6			211	BR7HIX	7067
Splinter	50		B7HS	5110	0,6	B7HVX	7836	204	BR7HIX	7067
Squab	50		BR8HS	4322	0,6	BR8HVX	6265	212	BR8HIX	7001
SR 50	50		B8HS	5510	0,6	B8HVX	2634	205	BR8HIX	7001
SV 50	50		B8HS	5510	0,6	B8HVX	2634	205	BR8HIX	7001
SV 50 Junior	50		B8HS	5510	0,6	B8HVX	2634	205	BR8HIX	7001
Zenith	50		BP6HS	4511	0,6	BP6HVX	4635		BPR6HIX	4085
City Roller CV 80	80		BPR6HS	7022	0,7	BPR6HVX	2740	214	BPR6HIX	4085
City Roller CV 80 E	80		BR8HS	4322	0,7	BR8HVX	6265	212	BR8HIX	7001





Order No.



Gold-Palladium

Platin



Order No.

Quick No.

Iridium



Order No.

**SACHS**

SR 80	80		B8HS	5510	0,6	B8HVX	2634	205	BR8HIX	7001
SV 80	80		B8HS	5510	0,6	B8HVX	2634	205	BR8HIX	7001
SR 125	125		BP6HS	4511	0,6	BP6HVX	4635		BPR6HIX	4085
SR 125 C	125		BP6HS	4511	0,6	BP6HVX	4635		BPR6HIX	4085
Superduke	125	97 -	C7HSA	4629	0,6	C7HVX	4533		CR7HIX	7544
SV 125	125		BP6HS	4511	0,6	BP6HVX	4635		BPR6HIX	4085
SV 125 C	125		BP6HS	4511	0,6	BP6HVX	4635		BPR6HIX	4085

**SAN YANG**

Fancy 50	50	10.95 -	BR8HSA	5539	0,6	BR8HVX	6265		BR8HIX	7001
Flash 50	50		BR8HSA	5539	0,6	BR8HVX	6265		BR8HIX	7001
Free 50	50		BR8HSA	5539	0,6	BR8HVX	6265		BR8HIX	7001
Jet 50	50		BR8HSA	5539	0,6	BR8HVX	6265		BR8HIX	7001
Mike 50	50		BR8HSA	5539	0,6	BR8HVX	6265		BR8HIX	7001
Pure 50	50		BR8HSA	5539	0,6	BR8HVX	6265		BR8HIX	7001
Red Devil 50	50		BR8HSA	5539	0,6	BR8HVX	6265		BR8HIX	7001
Super Fancy 50	50		BR8HSA	5539	0,6	BR8HVX	6265		BR8HIX	7001
Duke 125	125		C7HSA	4629	0,6	C7HVX	4533		CR7HIX	7544
Super Duke 125	125		C7HSA	4629	0,6	C7HVX	4533		CR7HIX	7544

**SASY**

Classic 200 E	50	96 -	BPR6HS	7022	0,5	BPR6HVX	2740	214	BPR6HIX	4085
JC 50	50	96 -	C7HSA	4629	0,6	C7HVX	4533		CR7HIX	7544
Jet 50	50	96 -	BPR6HS	7022	0,5	BPR6HVX	2740	214	BPR6HIX	4085
Mulan B	50	96 -	BPR6HS	7022	0,5	BPR6HVX	2740	214	BPR6HIX	4085
Mulan Super AG	50	96 -	BPR6HS	7022	0,5	BPR6HVX	2740	214	BPR6HIX	4085
Standard 50	50	96 -	BPR6HS	7022	0,5	BPR6HVX	2740	214	BPR6HIX	4085

**SHE LUNG**

Club (I)	50		BP7HS	5111	0,6	BP7HVX	7468		BPR7HIX	5944
Racer (I)	50		BP7HS	5111	0,6	BP7HVX	7468		BPR7HIX	5944

**SIAM**

Falkon 50	50	97 -	BR7HS	4122	0,6			211	BR7HIX	7067
Scros (I)	50		BPR6HS	7022	0,6	BPR6HVX	2740	214	BPR6HIX	4085
Scross	50		BPR6HS	7022	0,7	BPR6HVX	2740	214	BPR6HIX	4085

**SIAMOTO**

Birdie 25 Mofa	25	99 -	BPR6HS	7022	0,7	BPR6HVX	2740	214	BPR6HIX	4085
Sross 50	50	99 -	BR7HS	4122	0,5			211	BR7HIX	7067
Capri 125 4-Takt	125	99 -	C7HSA	4629	0,7	C7HVX	4533		CR7HIX	7544
Favourite 125 4-Takt	125	99 -	C7HSA	4629	0,7	C7HVX	4533		CR7HIX	7544
KD 125 4-Takt	125	99 -	C7HSA	4629	0,7	C7HVX	4533		CR7HIX	7544

**SIMSON**

City 2000	50	95 -	B8HS	5510	0,6	B8HVX	2634	205	BR8HIX	7001
SR 50 ( 1B)	50		B8HS	5510	0,6	B8HVX	2634	205	BR8HIX	7001
SR 50 ( 1XCE) Gamma	50		B8HS	5510	0,6	B8HVX	2634	205	BR8HIX	7001
SR 50 ( 1XG) Gamma	50		B8HS	5510	0,6	B8HVX	2634	205	BR8HIX	7001
Star 50	50	96 -	BPR6HS	7022	0,7	BPR6HVX	2740	214	BPR6HIX	4085
Hot Summer 80	70	97 -	B9HS	5810	0,4	B9HVX	2254			
Star Classic 80	70	97 -	B9HS	5810	0,4	B9HVX	2254			

Order  
No.Platin  
Gold-  
Palla-  
diumOrder Quick  
No. No.Order  
No.**SIMSON**

SR 80 /1B	80		B8HS	5510	0,6	B8HVX	2634	205	BR8HIX	7001
SR 80 /1XCE	80		B8HS	5510	0,6	B8HVX	2634	205	BR8HIX	7001

**STAR QUAD**

Jinlun JL50QT-5 Roller 50	50		C7HSA	4629	0,7	C7HVX	4533		CR7HIX	7544
---------------------------	----	--	-------	------	-----	-------	------	--	--------	------

**STEFFEN**

Steffi	50	98 -	BP6HS	4511	0,6	BP6HVX	4635		BPR6HIX	4085
Steffi S	50	98 -	BP6HS	4511	0,6	BP6HVX	4635		BPR6HIX	4085

**SUNDIRO**

Speedy 50	50	96 -			0,6	B9EVX	7254			
Speedy 80	80				0,6	B9EVX	7254			
Phönix XDZ 125 T	125	96 -	CR7HSA	4549	0,6				CR7HIX	7544
Phönix XDZ 125 TA	125	96 -	CR7HSA	4549	0,6				CR7HIX	7544

**SUZUKI**

Address (I)	50		BPR6HS	7022	0,6	BPR6HVX	2740	214	BPR6HIX	4085
AH 50 (I)	50	01.92 -	BPR6HS	7022	0,6	BPR6HVX	2740	214	BPR6HIX	4085
AH 50 Adress (CA1GA)	50	92 -	BPR6HS	7022	0,7	BPR6HVX	2740	214	BPR6HIX	4085
AH 50 GP	50	95 -	BPR6HS	7022	0,6	BPR6HVX	2740	214	BPR6HIX	4085
AJ 50 ZZ (I)	50	95 -	BPR7HS	6422	0,5	BPR7HVX	2938	215	BPR7HIX	5944
AP 50 S CA1JA)	50	95 -	BPR6HS	7022	0,6	BPR6HVX	2740	214	BPR6HIX	4085
AP 50 T (I)	50	96 -	BPR6HS	7022	0,7	BPR6HVX	2740	214	BPR6HIX	4085
AY Katana WRX/WR/W (AA)	50	97 -	BPR6HS	7022	0,6	BPR6HVX	2740	214	BPR6HIX	4085
AY 50 Katana (Di-Tech)	50	05 -	CPR8E	7411	0,6	ZMR7AP	6914			
CP 50 (I)	50	.89 - 92	BPR6HS	7022	0,7	BPR6HVX	2740	214	BPR6HIX	4085
UF50 Estilete (WVBA)	50	00 -	BPR7HS	6422	0,6	BPR7HVX	2938	215	BPR7HIX	5944
UX 50 W Zillion (AT)	50	99 -	BPR6HS	7022	0,7	BPR6HVX	2740	214	BPR6HIX	4085
AH 100 (I)	100	- 93	BPR7HS	6422	0,6	BPR7HVX	2938	215	BPR7HIX	5944
AH 100 (CE12A)	100	95 -	BPR7HS	6422	0,7	BPR7HVX	2938	215	BPR7HIX	5944
AH 100 (I)	100	- 93	BPR7HS	6422	0,5	BPR7HVX	2938	215	BPR7HIX	5944
AN 125 (CF42A)	125	95 - 95	CR8E	1275	0,7	CR8EVX	6487	226	CR8EIX	4218
AN 125 (CF42A)	125	96 -	CR7E	4578	0,7			225	CR7EIX	7385
AN 125 S (I)	125	95 -	CR8E	1275	0,7	CR8EVX	6487	226	CR8EIX	4218
AN 125 T (I)	125	01.96 -	CR7E	4578	0,7			225	CR7EIX	7385
UC 125 / U Epicuro (AX)	125	99 -	CR8E	1275	0,7	CR8EVX	6487	226	CR8EIX	4218
UE 125 (WVBH)	125	01 -	CR7E	4578	0,7			225	CR7EIX	7385
UH 125 (WVBP)(K1-K7)	125	02 -	CR8E	1275	0,7	CR8EVX	6487	226	CR8EIX	4218
AN 150 T (I)	150	01.96 -	CR7E	4578	0,7			225	CR7EIX	7385
UH 200 (K7)	200	07 -	CR8EK	3478	0,7				CR8EIX	4218
AN 250 Burgman (AN/WVAN)	250	05.98 -	CR8EK	3478	0,7				CR8EIX	4218
AN 400 Burgman (AU/WVAU)(WVBW)	400	99 -	CR7E	4578	0,7			225	CR7EIX	7385
AN 400 Burgman (K7)	400	07 -	CR7E	4578	0,7			225	CR7EIX	7385
AN 650 Burgmann 650 (K3)(K4)	650	03 - 06	CR8E	1275	0,7	CR8EVX	6487	226	CR8EIX	4218

**SYM**

DD 50	50		BR8HSA	5539	0,6	BR8HVX	6265		BR8HIX	7001
Fancy	50	96 -	BR8HSA	5539	0,6	BR8HVX	6265		BR8HIX	7001
Fiddle 50	50		BR8HSA	5539	0,6	BR8HVX	6265		BR8HIX	7001
Flash	50	96 -	BR8HSA	5539	0,6	BR8HVX	6265		BR8HIX	7001
Free	50	96 -	BR8HSA	5539	0,6	BR8HVX	6265		BR8HIX	7001

Order  
No.Gold-  
Palla-  
dium

Platin

Order Quick  
No. No.

Iridium

Order  
No.

<b>SYM</b>										
Jet	50	96 -	BR8HSA	5539	0,6	BR8HVX	6265		BR8HIX	7001
Mask 50	50		BR8HSA	5539	0,6	BR8HVX	6265		BR8HIX	7001
Mio 50	50	05 -	CR6HSA	2983	0,7				CR6HIX	7274
Pure 50	50	96 -	BR8HSA	5539	0,6	BR8HVX	6265		BR8HIX	7001
Red Devil	50		BR8HSA	5539	0,6	BR8HVX	6265		BR8HIX	7001
RS 50	50	05 -	BR8HSA	5539	0,6	BR8HVX	6265		BR8HIX	7001
Shark 50	50		BR8HSA	5539	0,6	BR8HVX	6265		BR8HIX	7001
Super Fancy	50	96 -	BR8HSA	5539	0,6	BR8HVX	6265		BR8HIX	7001
Euro MX 125 4V	125	05 -	CR8E	1275	0,7	CR8EVX	6487	226	CR8EIX	4218
GTS 125	125	06 -	CR8E	1275	0,7	CR8EVX	6487	226	CR8EIX	4218
HD 125	125		CR8E	1275	0,7	CR8EVX	6487	226	CR8EIX	4218
HD 125	125	05 -	CR8E	1275	0,7	CR8EVX	6487	226	CR8EIX	4218
Joyride 125	125	05 -	CR8E	1275	0,7	CR8EVX	6487	226	CR8EIX	4218
Joyride 125	125	03 -	CR7HSA	4549	0,6				CR7HIX	7544
Megalo 125	125		C7HSA	4629	0,7	C7HVX	4533		CR7HIX	7544
RS 125 4V	125	05 -	CR8E	1275	0,7	CR8EVX	6487	226	CR8EIX	4218
Shark 125	125	99 -	C7HSA	4629	0,7	C7HVX	4533		CR7HIX	7544
Super Duke 125	125	96 -	C7HSA	4629	0,7	C7HVX	4533		CR7HIX	7544
HD 200	200	05 -	CR8E	1275	0,7	CR8EVX	6487	226	CR8EIX	4218
Joyride 200	200	05 -	CR8E	1275	0,7	CR8EVX	6487	226	CR8EIX	4218
GTS 250	250	06 -	CR8E	1275	0,7	CR8EVX	6487	226	CR8EIX	4218
500 GT	500	04 -	CR7EKB	4455	0,6					
500 XP	500	04 -	CR7EKB	4455	0,6					

**T.G.M. Bimota**

Akros 50	50		BP6HS	4511	0,7	BP6HVX	4635		BPR6HIX	4085
Ergon 50	50		BP6HS	4511	0,7	BP6HVX	4635		BPR6HIX	4085

**TGB**

Bunny AS 50 X	50		BP6HS	4511	0,6	BP6HVX	4635		BPR6HIX	4085
KBX 50	50		BP6HS	4511	0,6	BP6HVX	4635		BPR6HIX	4085

**TOKAIDO**

2000 K50	50	96 -	BR7HS	4122	0,6			211	BR7HIX	7067
50 V	50		BP7HS	5111	0,6	BP7HVX	7468		BPR7HIX	5944
SM 50	50		BP7HS	5111	0,6	BP7HVX	7468		BPR7HIX	5944
SM 50/1	50		BP7HS	5111	0,6	BP7HVX	7468		BPR7HIX	5944

**VELOCIFERO**

Velocifero 50 (l)	50		B8HS	5510	0,6	B8HVX	2634	205	BR8HIX	7001
-------------------	----	--	------	------	-----	-------	------	-----	--------	------

**VESPA**

-> PIAGGIO										
------------	--	--	--	--	--	--	--	--	--	--

**VILLA BS**

Giorno 50 (l)	50		BR8HSA	5539	0,6	BR8HVX	6265		BR8HIX	7001
GP 50 Dio (l)	50		BPR8HS	3725	0,6				BPR8HIX	6742
SP 50 Dio (l)	50		BPR7HS	6422	0,6	BPR7HVX	2938	215	BPR7HIX	5944
Z5 50 (l)	50		BR8HSA	5539	0,6	BR8HVX	6265		BR8HIX	7001
ZX 50 (l)	50		BR8HSA	5539	0,6	BR8HVX	6265		BR8HIX	7001

Order  
No.Platin  
Gold-  
Palla-  
diumOrder Quick  
No. No.Order  
No.**VIVA**

Viva 50	50	96 -	BP7HS	5111	0,5	BP7HVX	7468		BPR7HIX	5944
---------	----	------	-------	------	-----	--------	------	--	---------	------

**WINKING**

Bunny AS / AT / AX	50		BP7HS	5111	0,7	BP7HVX	7468		BPR7HIX	5944
Bunny AS 50 X	50		BP6HS	4511	0,7	BP6HVX	4635		BPR6HIX	4085
Koala 2	50		B5HS	4210	0,6					
Koala LM	50		B6HS	4510	0,6	B6HVX	7435	203	BR6HIX	3419
Scooty Roller	50		B6HS	4510	0,6	B6HVX	7435	203	BR6HIX	3419

**WP**

Wave 50	50	96 -	BPR7HS	6422	0,5	BPR7HVX	2938	215	BPR7HIX	5944
---------	----	------	--------	------	-----	---------	------	-----	---------	------

**YAMAHA**

Aerox	50	97 -	BR8HS	4322	0,6	BR8HVX	6265	212	BR8HIX	7001
Aerox Racing	50	04 -	BR8HS	4322	0,6	BR8HVX	6265	212	BR8HIX	7001
Aerox R Toyota Racing	50	03 -	BR8HS	4322	0,6	BR8HVX	6265	212	BR8HIX	7001
Axis (YA50R) (3UG)	50	97 -	BR8HS	4322	0,7	BR8HVX	6265	212	BR8HIX	7001
Axis 50 (I)	50	01.95 -	BR7HS	4122	0,6			211	BR7HIX	7067
Axis Mofa (5AK)(YA50R)	50	97 -	BR7HS	4122	0,7			211	BR7HIX	7067
Beluga (I)	50		BP7HS-10	7829	1,0					
Breeze (4RC)(YM50)	50	95 -	BR8HS	4322	0,7	BR8HVX	6265	212	BR8HIX	7001
Breeze 50 (I)	50	01.94 -	BR7HS	4122	0,6			211	BR7HIX	7067
BW'S NG 99 (SA056)	50	99 -	BR8HS	4322	0,6	BR8HVX	6265	212	BR8HIX	7001
BW 50 Spy (CW50RSP;4VA)	50	96 -	BR8HS	4322	0,7	BR8HVX	6265	212	BR8HIX	7001
BW 50 (4BX)	50	91 - 95	BR7HS	4122	0,7			211	BR7HIX	7067
BW 50 (CW50)	50	96 -	BR8HS	4322	0,7	BR8HVX	6265	212	BR8HIX	7001
BW 50 Bump (CW50RSX)	50	96 -	BR8HS	4322	0,7	BR8HVX	6265	212	BR8HIX	7001
BW 50 NG (CW50RS;4VA)	50	96 -	BR8HS	4322	0,7	BR8HVX	6265	212	BR8HIX	7001
BW 50 R (4BX)	50	96 -	BR8HS	4322	0,7	BR8HVX	6265	212	BR8HIX	7001
CR 50 Z (I)	50		BR7HS	4122	0,5			211	BR7HIX	7067
CT 50 S (I)	50		BP7HS-10	7829	0,7					
CT 50 SS (I)	50		BP7HS	5111	0,7	BP7HVX	7468		BPR7HIX	5944
CW 50 R (4BX)	50		BR8HS	4322	0,7	BR8HVX	6265	212	BR8HIX	7001
Evolis (YE50)(4FW)	50		BR7HS	4122	0,5			211	BR7HIX	7067
Forte (YA50R) (3UG)	50		BR8HS	4322	0,7	BR8HVX	6265	212	BR8HIX	7001
JogR	50		BR8HS	4322	0,6	BR8HVX	6265	212	BR8HIX	7001
JogRR	50		BR8HS	4322	0,6	BR8HVX	6265	212	BR8HIX	7001
Jog-Z 50 (I)	50	01.95 -	BP7HS	5111	0,7	BP7HVX	7468		BPR7HIX	5944
Neo's	50	97 - 07	BR8HS	4322	0,6	BR8HVX	6265	212	BR8HIX	7001
Slider (SA09)	50	00 -	BR8HS	4322	0,6	BR8HVX	6265	212	BR8HIX	7001
Spy 50 (I)	50		BR8HS	4322	0,6	BR8HVX	6265	212	BR8HIX	7001
Why (SA03)	50	99 -	BR8HS	4322	0,6	BR8HVX	6265	212	BR8HIX	7001
YA 50 (5AK)	50	97 -	BR7HS	4122	0,7			211	BR7HIX	7067
Zest/ YE50 (4FW)	50		BR8HS	4322	0,7	BR8HVX	6265	212	BR8HIX	7001
Evolis (4MU)	80		BR7HS	4122	0,7			211	BR7HIX	7067
Zest (4MU)(YE80)	80		BR7HS	4122	0,7			211	BR7HIX	7067
Aerox 100	100	01 -	BR8HS	4322	0,6	BR8HVX	6265	212	BR8HIX	7001
BW 100 (SB02)	100	99 - 00	BR8HS	4322	0,6	BR8HVX	6265	212	BR8HIX	7001
BW 100 (SB02)	100	00 -	BR7HS	4122	0,7			211	BR7HIX	7067
Neos 100 (SB04)	100	00 -	BR8HS	4322	0,6	BR8HVX	6265	212	BR8HIX	7001
BL 125 (50W)	125	.85 - .89	BPR8HS	3725	0,6				BPR8HIX	6742
Doodo (SE041)	125	01 -	CR8E	1275	0,7	CR8EVX	6487	226	CR8EIX	4218

Order  
No.Gold-  
Palla-  
dium

Platin

Order Quick  
No. No.

Iridium

Order  
No.**YAMAHA**

Majesty 125 (I)	125		DR8EA	7162	0,6	DR8EVX	6354		DR8EIX	6681
Maxster 125	125	00 -	CR8E	1275	0,7	CR8EVX	6487	226	CR8EIX	4218
Teo's (SE041)	125	01 -	CR8E	1275	0,7	CR8EVX	6487	226	CR8EIX	4218
XC 125 Cygnus	125	04 -	CR7E	4578	0,7			225	CR7EIX	7385
XC 125 Cygnus	125	- 94	CR6HSA	2983	0,7				CR6HIX	7274
XC 125 Beluga	125		CR6HSA	2983	0,7				CR6HIX	7274
XC 125 Cygnus	125	01.95 -	CR7E	4578	0,7			225	CR7EIX	7385
XC 125 TR Cygnus (4NB)	125	96 -	CR7E	4578	0,7			225	CR7EIX	7385
XC 125 (3TE)	125	90 -	CR6HSA	2983	0,7				CR6HIX	7274
XC 125 T Cygnus T (4NB)	125	96 -	CR7E	4578	0,6			225	CR7EIX	7385
XC 125 T (4KY)	125	95 -	CR7E	4578	0,6			225	CR7EIX	7385
XC 125 T (4NB)	125	94 -	CR7E	4578	0,7			225	CR7EIX	7385
XC 125 X Cygnus	125	07 -	CR7E	4578	0,7			225	CR7EIX	7385
YP 125 R X-MAX	125	06 -	CPR9EA-9	2308						
YP 125 R Majesty	125	98 -	CR8E	1275	0,7	CR8EVX	6487	226	CR8EIX	4218
XC 150 Fly one (I)	150	01.95 -	CR7E	4578	0,7			225	CR7EIX	7385
X-City 250 (VP250)	250	04.07 -	DPR8EA-9	4929	0,9	DPR8EVX-9	2872	221	DPR8EIX-9	2202
YP 250 Majesty (I)	250		DR8EA	7162	0,6	DR8EVX	6354		DR8EIX	6681
YP 250 Grand Majesty	250	04 -	CPR7EA-9		0,9					
YP 250 Majesty (4UC)	250		DR8EA	7162	0,6	DR8EVX	6354		DR8EIX	6681
YP 250 DX Majesty ABS (SG021)	250	99 -	DR8EA	7162	0,6	DR8EVX	6354		DR8EIX	6681
YP 250 (SG041)	250	00 -	DR8EA	7162	0,6	DR8EVX	6354		DR8EIX	6681
YP 250 R X-MAX 250	250	05 -	DR8EA	7162	0,7	DR8EVX	6354		DR8EIX	6681
VP 300 Versity	300	03 -	DR8EA	7162	0,6	DR8EVX	6354		DR8EIX	6681
T MAX 500	500	04 -	CR7E	4578	0,7			225	CR7EIX	7385

**ZONGSHEN**

Vento Phantom 2Stroke	50		BP7HS	5111	0,5	BP7HVX	7468		BPR7HIX	5944
Vento Zip 2Stroke	50		BP7HS	5111	0,5	BP7HVX	7468		BPR7HIX	5944
Qingqi B2 2Stroke QM50QT-B2	50		BP7HS	5111	0,5	BP7HVX	7468		BPR7HIX	5944
Vento Triton 2Stroke	50		BP7HS	5111	0,5	BP7HVX	7468		BPR7HIX	5944
Qingqi 10D GY6	125		CR7HSA	4549	0,6				CR7HIX	7544
Qingqi 10D GY6	150		CR7HSA	4549	0,6				CR7HIX	7544

Order  
No.Platin  
Gold-  
Palla-  
diumOrder Quick  
No. No.Order  
No.**ACCESS**

Long 50	50		BR8HSA	5539	0,8	BR8HVX	6265		BR8HIX	7001
Streak 50	50		BR8HSA	5539	0,8	BR8HVX	6265		BR8HIX	7001
Long 100	100		BR8HSA	5539	0,8	BR8HVX	6265		BR8HIX	7001

**ADLY**

ATV 50	50		BP7HS	5111	0,6	BP7HVX	7468		BPR7HIX	5944
Buggy 125	125		CR7HSA	4549	0,8				CR7HIX	7544

**AEON**

Cobra	50	03 -	BPR7HS	6422	0,8	BPR7HVX	2938	215	BPR7HIX	5944
Minikolt	50	03 -	BPR7HS	6422	0,8	BPR7HVX	2938	215	BPR7HIX	5944
Revo	50	04 -	BPR7HS	6422	0,8	BPR7HVX	2938	215	BPR7HIX	5944
Cobra	100	02 -	BPR7HS	6422	0,8	BPR7HVX	2938	215	BPR7HIX	5944
Revo	100	04 -	BPR7HS	6422	0,8	BPR7HVX	2938	215	BPR7HIX	5944
Cobra Utility	125	02 -	CR7HS	7223	0,8				CR7HIX	7544
Cobra Sport	125	02 -	CR8HSA	2086	0,8	CR8HVX	7236		CR8HIX	7669
Cobra RS 1	125		CR7HS	7223	0,8				CR7HIX	7544
Cobra RS 2	125		CR7HS	7223	0,8				CR7HIX	7544
Overland	125	04 -	CR7HS	7223	0,8				CR7HIX	7544
Cobra Sport	180	02 -	CR8HSA	2086	0,8	CR8HVX	7236		CR8HIX	7669
Cobra RS 2	180	04 -	CR7HSA	4549	0,8				CR7HIX	7544
Cobra RS 2	180		CR7HS	7223	0,8				CR7HIX	7544
Cobra RS 1	180		CR7HS	7223	0,8				CR7HIX	7544
LG 180	180	05 -	CR7HSA	4549	0,8				CR7HIX	7544
Overland	180	04 -	CR7HS	7223	0,8				CR7HIX	7544
Overland II	180	05 -	CR7HSA	4549	0,8				CR7HIX	7544
Utility	180	02 -	CR7HS	7223	0,8				CR7HIX	7544
Cobra 220	220	05 -	CR7HSA	4549	0,6				CR7HIX	7544

**ARCTIC CAT**

90	90	02 -	BPR7HS	6422	0,6	BPR7HVX	2938	215	BPR7HIX	5944
250 Quad 4x4	250	01 -	DR7EA	7839	0,6					
300 Quad 2x4 / 4x4	300	99 -	DR7EA	7839	0,6					
300	300	04 -	DR7EA	7839	0,6					
375	375	02 -	CR7E	4578	0,8			225	CR7EIX	7385
400	400	- 98	CR8E	1275	0,7	CR8EVX	6487	226	CR8EIX	4218
400	400	99 - 01	CR6E	6965	0,7					
400	400	03 -	CR7E	4578	0,8			225	CR7EIX	7385
400 TBX	400	04 -	CR7E	4578	0,6			225	CR7EIX	7385
400i	400	04 -	CR7E	4578	0,6			225	CR7EIX	7385
400	400	04 -	CR7E	4578	0,6			225	CR7EIX	7385
454	454	96 - 97	CR8E	1275	0,7	CR8EVX	6487	226	CR8EIX	4218
454	454	98 -	CR6E	6965	0,7					
500	493	99 -	CR6E	6965	0,7					
500 Auto	493	01 -	CR6E	6965	0,7					
500 TRV	500	04 -	CR6E	6965	0,7					
500 TBX	500	04 -	CR6E	6965	0,7					

**ARGO**

Vanguard 6X6 B&S OHV V-Twin 16hp	480		BKR5E	7938	0,6				BKR5EIX	6341
Vanguard 2 6X6 B&S OHV V-Twin 16hp	480		BKR5E	7938	0,6				BKR5EIX	6341
Bigfoot 6X6 B&S OHV V-Twin 18hp	570		BKR5E	7938	0,6				BKR5EIX	6341



Order No.



Gold-Palladium



Order Quick No. No.

Iridium



Order No.

**ARGO**

Response 8X8 B&S OHV V-Twin 18hp	570		BKR5E	7938	0,6				BKR5EIX	6341
Conquest 6X6 Kawasaki FD620D 20hp	614		BKR5E	7938	0,6				BKR5EIX	6341
Conquest 8X8 Kawasaki FD620D 20hp	617		BMR4A	5728	0,6					
Avenger 8X8 Kohler Aegis LH685	674		BMR4A	5728	0,6					

**ATK**

50 Mini Quad	50	01 -	B7HS	5110	0,5	B7HVX	7836	204	BR7HIX	7067
90 Mini Quad	90	01 -	B7HS	5110	0,5	B7HVX	7836	204	BR7HIX	7067

**BAROSSA MOTOR**

Mini	50		BPR7HS	6422	0,6	BPR7HVX	2938	215	BPR7HIX	5944
Python	50		BPR7HS	6422	0,8	BPR7HVX	2938	215	BPR7HIX	5944
Python	100		BPR7HS	6422	0,8	BPR7HVX	2938	215	BPR7HIX	5944
Magna	150		DR8EA	7162	0,7	DR8EVX	6354		DR8EIX	6681
Magna	170		DR8EA	7162	0,7	DR8EVX	6354		DR8EIX	6681
Magna	250		DR8EA	7162	0,7	DR8EVX	6354		DR8EIX	6681

**BLANEY**

FX70	79	99 -	BP7HS	5111	0,7	BP7HVX	7468		BPR7HIX	5944
FX90	90	00 -	BP7HS	5111	0,7	BP7HVX	7468		BPR7HIX	5944
FX100	100	00 -	BP7HS	5111	0,7	BP7HVX	7468		BPR7HIX	5944

**BOMBARDIER**

50 DS	50	02 -	BPR7HS	6422	0,6	BPR7HVX	2938	215	BPR7HIX	5944
50 Quest	50	03 - 03	BPR7HS	6422	0,8	BPR7HVX	2938	215	BPR7HIX	5944
DS 50	50	04 -	BR9ECS	3570	0,5					
Quest 50	50	04 -	BR9ECS	3570	0,5					
90 DS	83	02 -	BPR7HS	6422	0,6	BPR7HVX	2938	215	BPR7HIX	5944
90 DS 4stroke	90	02 -	CR7HSA	4549	0,7				CR7HIX	7544
90 Quest	90	03 - 03	CR7HSA	4549	0,7				CR7HIX	7544
DS 90	90	04 -	BR9ECS	3570	0,5					
Quest 90	90	04 -	BR9ECS	3570	0,5					
175	175	03 -	CR8E	1275	0,7	CR8EVX	6487	226	CR8EIX	4218
Rally 200	176	04 -	BR9ECS	3570	0,5					
200 Rally	200	03 -	CR8E	1275	0,7	CR8EVX	6487	226	CR8EIX	4218
330	330	02 -	DCPR8E	4339	0,9	DCPR8EVX	2265		DCPR8EIX	6546
Outlander 330	330	04 -	BR9ECS	3570	0,5					
400 Outlander	400	03 -	DCPR8E	4339	0,9	DCPR8EVX	2265		DCPR8EIX	6546
Outlander 400	400	04 -	BR9ECS	3570	0,5					
Quest 498	498	03 -	BR9ECS	3570	0,5					
Traxter 498	498	03 -	BR9ECS	3570	0,5					
500	500	02 -	DCPR8E	4339	0,9	DCPR8EVX	2265		DCPR8EIX	6546
500 Traxter 7401	500	99 - 02	DR8EA	7162	0,7	DR8EVX	6354		DR8EIX	6681
500 Traxter 7414	500	98 - 02	DR8EA	7162	0,7	DR8EVX	6354		DR8EIX	6681
Quest 644	644	03 -	BR9ECS	3570	0,5					
650 Quest	650	02 - 03	DCPR8E	4339	0,9	DCPR8EVX	2265		DCPR8EIX	6546
650 Traxter DS / DR	650	00 -	DR8EA	7162	0,7	DR8EVX	6354		DR8EIX	6681
650 DS 653	653	03 -	BR9ECS	3570	0,5					

**BOSS**

X2S1-90R	90		BP6HS	4511	0,6	BP6HVX	4635		BPR6HIX	4085
X4SZ-150R	155		BP6HS	4511	0,6	BP6HVX	4635		BPR6HIX	4085

Order  
No.Platin  
Gold-  
Palla-  
diumOrder Quick  
No. No.

Iridium

Order  
No.**BRISTER**

Brister's Chuck Wagon 11.0 HP Honda OHV GX340			BPR6ES-11	4824	1,1	BPR6EVX-11	4233		BPR6EIX-11	3903
F1-25 5 HP OHV Tecumseh			BR6ES	4922	0,6					
F1-265, F1-265E 6.5 HP OHV Tecumseh			BR6ES	4922	0,6					
F2-265, F2-265E 6.5 HP OHV Tecumseh			BR6ES	4922	0,6					
The Bug 3 HP Tecumseh			BR6S	3522	0,6					
The Scorpion 6.5 HP OHV Tecumseh			BR6ES	4922	0,6					
The Scorpion S 6.5 HP OHV Tecumseh			BR6ES	4922	0,6					
The Scorpion S 11.0 HP OHV Tecumseh			BR6ES	4922	0,6					
The Spider 5 HP OHV Tecumseh			BR6ES	4922	0,6					
The Spider X 6.5 HP OHV Tecumseh			BR6ES	4922	0,6					
The Stinger 5 HP OHV Tecumseh			BR6ES	4922	0,6					

**BUSH HOG**

Trail Hunter 16.0 hp B&S			BKR5E	7938	0,6				BKR5EIX	6341
Trail Hunter 24.0 hp Honda			ZGR5A	5839	0,6					
Trail Hunter 20.0 hp Honda			BPR6ES	7822	0,8	BPR6EVX	6764		BPR6EIX	6637

**CANNONDALE**

FX 400	432	00 -	CR9EK	4548	0,7			230	CR9EIX	3521
440 Moto	440	02 -	CR9EK	4548	0,7			230	CR9EIX	3521
Blaze	440	02 -	CR9EK	4548	0,7			230	CR9EIX	3521
Cannibal	440	02 -	CR9EK	4548	0,7			230	CR9EIX	3521
Glamis	440	03 -	CR9EK	4548	0,7			230	CR9EIX	3521
Speed	440	02 -	CR9EK	4548	0,7			230	CR9EIX	3521

**CARTER**

3.5 HP B&S			BR2LM	5798	0,6			310		
5.0 HP B&S			BR2LM	5798	0,6			310		
5.0 HP TECUMSEH OHH50			BP6ES	7811	0,8	BP6EVX	5832		BPR6EIX	6637
5.5 HP HONDA GX160			BPR6ES	7822	0,8	BPR6EVX	6764		BPR6EIX	6637
6.0 HP TECUMSEH OHH60			BR6ES	4922	0,7					
6.5 HP OHV Tecumseh			BR6ES	4922	0,6					
6.5 HP Tecumseh OHH65			BP6ES	7811	0,8	BP6EVX	5832		BPR6EIX	6637
8.0 HP B&S			BR2LM	5798	0,6			310		
8.0 HP TECUMSEH			BR4LM	4133	0,6					
8.0 HP TECUSEH			BR6S	3522	0,6					
10.0 HP TECUMSEH			BR4LM	4133	0,6					
SMC ENGINE			CR7HSA	4549	0,8				CR7HIX	7544

**CPI**

200	50	03 -	BR7ES	5122	0,8	BR7EVX	4556			
Carb 50	50	03 -	BR8HSA	5539	0,8	BR8HVX	6265		BR8HIX	7001
Dirt Demon	50	02 -	BR8HSA	5539	0,8	BR8HVX	6265		BR8HIX	7001
Carb 100	100	03 -	BR8HSA	5539	0,8	BR8HVX	6265		BR8HIX	7001
Dirt Demon	100	02 -	BR8HSA	5539	0,8	BR8HVX	6265		BR8HIX	7001
XS 250	250	06 -	CR7HSA	4549	0,8				CR7HIX	7544

**CUB CADET**

4x2 9.5 hp Kawasaki			BPR5ES	7422	0,7	BPR5EVX	4875		BPR5EIX	6597
4x2 18.0 hp Honda V-Twin OHV			ZGR5A	5839	0,7					
6x4 20.0 hp Honda V-Twin OHV			ZGR5A	5839	0,7					





Order No.



Gold-Palladium

Platin



Order No.

Quick No.

Iridium



Order No.

**DAREN**

50	50	00 -	BPR7HS	6422	0,8	BPR7HVX	2938	215	BPR7HIX	5944
100	100	00 -	BPR7HS	6422	0,8	BPR7HVX	2938	215	BPR7HIX	5944
125	125	00 -	DR8EA	7162	0,7	DR8EVX	6354		DR8EIX	6681
150	150	00 -	DR8EA	7162	0,7	DR8EVX	6354		DR8EIX	6681
Stinger 50	50		CR7HSA	4549	0,8				CR7HIX	7544
Raider Classic 150R	150		CR7HSA	4549	0,7				CR7HIX	7544
Raider Max 150R	150		CR8E	1275	0,7	CR8EVX	6487	226	CR8EIX	4218
Buggy 175	175		DPR8EA-8	4929	0,9	DPR8EVX-9	2872		DPR8EIX-9	2202
Raider Max 175R	175		CR8E	1275	0,7	CR8EVX	6487	226	CR8EIX	4218
Raider Max 250R	250		CR8E	1275	0,7	CR8EVX	6487	226	CR8EIX	4218

**DERBI**

170	170		DR8EA	7162	0,7	DR8EVX	6354		DR8EIX	6681
250	250		CR8HS	7423	0,7	CR8HVX	7236		CR8HIX	7669

**DINLI**

Cobia DL-503	50		BPR7HS	6422	0,6	BPR7HVX	2938	215	BPR7HIX	5944
Diamond Back DL601-50 2-Stroke	50		BPR7HS	6422	0,8	BPR7HVX	2938	215	BPR7HIX	5944
Dino	50	02 -	BPR7HS	6422	0,6	BPR7HVX	2938	215	BPR7HIX	5944
Dino DL501-50 2-Stroke	50		BPR7HS	6422	0,8	BPR7HVX	2938	215	BPR7HIX	5944
Helix	50	04 -	BPR7HS	6422	0,8	BPR7HVX	2938	215	BPR7HIX	5944
JP DL502-51 2-Stroke	50		BPR7HS	6422	0,6	BPR7HVX	2938	215	BPR7HIX	5944
T-Rex	50	03 -	BPR7HS	6422	0,8	BPR7HVX	2938	215	BPR7HIX	5944
Beast DL602-90 2-Stroke	90		BPR7HS	6422	0,8	BPR7HVX	2938	215	BPR7HIX	5944
Diamond Back DL601-90 2-Stroke	90		BPR7HS	6422	0,8	BPR7HVX	2938	215	BPR7HIX	5944
Helix DL603-90 2-Stroke	90		BPR7HS	6422	0,7	BPR7HVX	2938	215	BPR7HIX	5944
T-Rex 100	100		BP6HS	4511	0,6	BP6HVX	4635		BPR6HIX	4085
Diablo DL604-150 4-Stroke	150		C7HSA	4629	0,6	C7HVX	4533		CR7HIX	7544
Enforcer DL605-150 4-Stroke	150		C7HSA	4629	0,7	C7HVX	4533		CR7HIX	7544
Helix DL603-150 4-Stroke	150		C7HSA	4629	0,7	C7HVX	4533		CR7HIX	7544

**DRR**

DRR 50	50	04 -	BP7HS	5111	0,7	BP7HVX	7468		BPR7HIX	5944
DRR 90	90	04 -	BP7HS	5111	0,7	BP7HVX	7468		BPR7HIX	5944
DRR 90 GT	90	04 -	C7HSA	4629	0,7	C7HVX	4533		CR7HIX	7544

**E.ATV**

siehe /see KTM

**EAR RACING**

Evolution 510	510		DCPR8E	4179	0,6	DCPR8EVX	2265		DCPR8EIX	6546
Explorer 625	625		DR8EA	7162	0,6	DR8EVX	6354		DR8EIX	6681
Extreme 950	950		CR8EK	3478	0,7				CR8EIX	4218
Energia 992	992		DCPR8E	4179	0,6	DCPR8EVX	2265		DCPR8EIX	6546

**ERING**

Bug Rider BR250 Dual Seat	250		DPR7EA-9	5129	0,9	DPR7EVX-9	7682	220	DPR7EIX-9	7803
Tornado 50	50		BP7HS	5111	0,7	BP7HVX	7468		BPR7HIX	5944

**E-TON**

Viper Juior	40	03 -	BPM7A	7321	0,6			305		
Viper	50	02 -	BPR7HS	6422	0,6	BPR7HVX	2938	215	BPR7HIX	5944

Order  
No.Platin  
Gold-  
Palla-  
diumOrder  
No.Quick  
No.

Iridium

Order  
No.**E-TON**

Sierra Ranger	90	03 -	BPR7HS	6422	0,8	BPR7HVX	2938	215	BPR7HIX	5944
Viper	90	02 -	BPR7HS	6422	0,8	BPR7HVX	2938	215	BPR7HIX	5944
Yukon	150	99 -	C7HSA	4629	0,6	C7HVX	4533		CR7HIX	7544

**FOX**

50	50	00 -	BPR7HS	6422	0,8	BPR7HVX	2938	215	BPR7HIX	5944
50 VR Sport	50	01 -	BPR7HS	6422	0,8	BPR7HVX	2938	215	BPR7HIX	5944
90 MT	90	99 -	CR7HSA	4549	0,8				CR7HIX	7544
100	100	00 -	BPR7HS	6422	0,8	BPR7HVX	2938	215	BPR7HIX	5944

**G+G**

QUAD not Twinspark	1130	03 -	BKR7EKC	7354					BKR7EIX	2667
--------------------	------	------	---------	------	--	--	--	--	---------	------

**GAS GAS**

300 Wild	300	02 -	BR8EG	3130	0,5					
450 Wild	450	02 -	CR8E	1275	0,7	CR8EVX	6487	226	CR8EIX	4218

**HERKULES**

ATV 50 VS	50	04 -	BP7HS	5111	0,7	BP7HVX	7468		BPR7HIX	5944
ATV 50 VG	50	04 -	BP7HS	5111	0,7	BP7HVX	7468		BPR7HIX	5944
ATV 50 RS XXL	50	03.05 -	BPR7HS	6422	0,8	BPR7HVX	2938	215	BPR7HIX	5944
ATV 100 V	100	04 -	BPR7HS	6422	0,8	BPR7HVX	2938	215	BPR7HIX	5944
ATK 125 R Go Kart	125	04 -	C7HSA	4629	0,7	C7HVX	4533		CR7HIX	7544
ATV 150 U	150	04 -	CR8E	1275	0,7	CR8EVX	6487	226	CR8EIX	4218
ATV 150 S	150	04 -	CR8E	1275	0,7	CR8EVX	6487	226	CR8EIX	4218
ATV 300 U	300	04 -	DR8EA	7162	0,7	DR8EVX	6354		DR8EIX	6681
ATV 300 S	300	04 -	DR8EA	7162	0,7	DR8EVX	6354		DR8EIX	6681

**HONDA**

TRX 70	70		CR7HS	7223	0,7				CR7HIX	7544
ATC 90	90	70 - 78	D8HA	7112	0,6					
TRX 90	90	93 - 94	CR6HSA	2983	0,7				CR6HIX	7274
TRX 90	90	95 -	CR7HSA	4549	0,7				CR7HIX	7544
ATC 125 M	125		DR8ESL	2923	0,6	DR8EVX	6354	218	DR8EIX	6681
TRAX 125	125		DR8ESL	2923	0,7	DR8EVX	6354	218	DR8EIX	6681
TRX 125	125		DR8ESL	2923	0,7	DR8EVX	6354	218	DR8EIX	6681
ATC 185	185		D8EA	2120	0,7	D8EVX	2850	216	DR8EIX	6681
ATC 185 S	185		DR8ESL	2923	0,6	DR8EVX	6354	218	DR8EIX	6681
ATC 200	200		DR8ESL	2923	0,6	DR8EVX	6354	218	DR8EIX	6681
TRX 200 D	200	92 -	DR8ESL	2923	0,6	DR8EVX	6354	218	DR8EIX	6681
TRX 200 SX	200		DR8ESL	2923	0,7	DR8EVX	6354	218	DR8EIX	6681
ATC 250 ES /SX	250	85 -	DR8ESL	2923	0,7	DR8EVX	6354	218	DR8EIX	6681
ATC 250 R	250		BR9ES	5722	0,8	BR9EVX	1265	208	BR9EIX	3981
FL 250	250		BR9ES	5722	0,8	BR9EVX	1265	208	BR9EIX	3981
TRAX 250	250		DR8ESL	2923	0,6	DR8EVX	6354	218	DR8EIX	6681
TRX 250	250		DR8ESL	2923	0,6	DR8EVX	6354	218	DR8EIX	6681
TRX 250 EX	250	05 -	DPR8EA-9	4929	0,9	DPR8EVX-9	2872	221	DPR8EIX-9	2202
TRX 250 R	250		BR9ES	5722	0,6	BR9EVX	1265	208	BR9EIX	3981
TRX 250 X	250		DR8ESL	2923	0,7	DR8EVX	6354	218	DR8EIX	6681
TRX 300	300	93 -	DPR8EA-9	4929	0,9	DPR8EVX-9	2872	221	DPR8EIX-9	2202
TRX 300 EX	300	93 -	DR8ESL	2923	0,6	DR8EVX	6354	218	DR8EIX	6681
TRX 300 FW	300	93 -	DPR8EA-9	4929	0,9	DPR8EVX-9	2872	221	DPR8EIX-9	2202

Order  
No.Gold-  
Palla-  
diumOrder Quick  
No. No.

Iridium

Order  
No.**HONDA**

TRX 300 N	300	92 -	DPR8EA-9	4929	0,9	DPR8EVX-9	2872	221	DPR8EIX-9	2202
TRX 300 EX	300	05 -	DR8ESL	2923	0,7	DR8EVX	6354	218	DR8EIX	6681
ATC 350 X	350		DR8ESL	2923	0,7	DR8EVX	6354	218	DR8EIX	6681
FL 350 R	350		BR9ES	5722	0,8	BR9EVX	1265	208	BR9EIX	3981
TRX 350 FE	350	05 -	DPR7EA-9	5129	0,9	DPR7EVX-9	7682	220	DPR7EIX-9	7803
TRX 350	350	93 -	DR8ESL	2923	0,6	DR8EVX	6354	218	DR8EIX	6681
TRX 350 FM	350	05 -	DPR7EA-9	5129	0,9	DPR7EVX-9	7682	220	DPR7EIX-9	7803
TRX 350 TE	350	05 -	DPR7EA-9	5129	0,9	DPR7EVX-9	7682	220	DPR7EIX-9	7803
TRX 350 TM	350	05 -	DPR7EA-9	5129	0,9	DPR7EVX-9	7682	220	DPR7EIX-9	7803
TRX 400 FA	400	05 -	DPR8EA-9	4929	0,9	DPR8EVX-9	2872	221	DPR8EIX-9	2202
TRX 400 FGA	400	05 -	DPR8EA-9	4929	0,9	DPR8EVX-9	2872	221	DPR8EIX-9	2202
TRX 400 FW	400	95 -	DPR7EA-9	5129	0,9	DPR7EVX-9	7682	220	DPR7EIX-9	7803
TRX 450 / R	450	05 -	DPR7EA-9	5129	0,9	DPR7EVX-9	7682	220	DPR7EIX-9	7803
TRX 500	500	05 -			0,9				IJR7A-9	7901
TRX 500 FA	500	02 -			0,9				IJR7A-9	7901
Rincon TRX 650	650	01.04 -			1,1				IFR5L11	6502
TRX 650 FGA	650	05 -			1,1				IFR5L11	6502
TRX 650 FA	650	05 -			1,1				IFR5L11	6502

**HUSQVARNA**

QM 450	450	05 -	CR8EB	7784	0,6	CR8EVX	6487		CR8EIX	4218
--------	-----	------	-------	------	-----	--------	------	--	--------	------

**HYOSUNG**

50	50	03 -	BP6HS	4511	0,7	BP6HVX	4635		BPR6HIX	4085
90	50	03 -	BPR7HS	6422	0,8	BPR7HVX	2938	215	BPR7HIX	5944
WOW 50	50	04 -	BP7HS	5111	0,7	BP7HVX	7468		BPR7HIX	5944
WOW 90	90	04 -	BP7HS	5111	0,7	BP7HVX	7468		BPR7HIX	5944

**JOHN DEERE**

Gator 4x2			BPR6ES	7822	0,8	BPR6EVX	6764		BPR6EIX	6637
Gator Kawasaki OHV 18.0 hp			BMR6A	7421	0,6			306		
Gator 6x4			BMR2A-10	4452	0,9					
Gator Kawasaki FD620D 20.0 hp			BMR2A-10	4452	0,9					
Gator Kawasaki 10.0 hp			B5HS	4210	0,6					
Gator Kawasaki FE250D 8.0 hp	250		BPR5ES	7422	0,7	BPR5EVX	4875		BPR5EIX	6597
Gator Kawasaki FE290D 9.5 hp	290		BPR5ES	7422	0,7	BPR5EVX	4875		BPR5EIX	6597
Buck	500		DR8EA	7162	0,7	DR8EVX	6354		DR8EIX	6681
Trail Buck	500		DCPR8E	4339	0,9	DCPR8EVX	2265		DCPR8EIX	6546
Trail Buck	650		DCPR8E	4339	0,9	DCPR8EVX	2265		DCPR8EIX	6546

**KARCHER**

KM 170-8	170		DR8EA	7162	0,7	DR8EVX	6354		DR8EIX	6681
KM 250-10	250		CR8HS	7423	0,7	CR8HVX	7236		CR8HIX	7669
KM 250-11	250		CR8HS	7423	0,7	CR8HVX	7236		CR8HIX	7669
KM 250-9	250		CR8HS	7423	0,7	CR8HVX	7236		CR8HIX	7669

**KAWASAKI**

KFX 50 A (SQ)	50	03 -	BPR4HS	7823	0,7					
KFX 80	80	04 -	BPR4HS	7823	0,6					
KLF 185	185		DR8ES	5423	0,7	DR8EVX	6354	217	DR8EIX	6681
KLF 220	220	88 - 02	DR8ES	5423	0,7	DR8EVX	6354	217	DR8EIX	6681
KDX 250	250		BR8ES	5422	0,8	BR8EVX	1262	207	BR8EIX	5044

Order  
No.Platin  
Gold-  
Palla-  
diumOrder Quick  
No. No.Order  
No.**KAWASAKI**

KDX 250	250	91 -	BR9ES	5722	0,8	BR9EVX	1265	208	BR9EIX	3981
KDX 250 SR	250	92 -	BR8ES	5422	0,8	BR8EVX	1262	207	BR8EIX	5044
KLF 250 A	250	02 -	DR8ES	5423	0,7	DR8EVX	6354	217	DR8EIX	6681
KEF 300 A&B (SQ)	300	95 -	DR7EA	7839	0,7					
KLF 300 2X4	300	88 -	BR8ES	5422	0,8	BR8EVX	1262	207	BR8EIX	5044
KLF 300 4X4	300	88 -	DR8EA	7162	0,7	DR8EVX	6354	207	DR8EIX	6681
KVF 360 A &B	360	02 -	DPR8EA-9	4929	0,9	DPR8EVX-9	2872	221	DPR8EIX-9	2202
KFX 400	400	03 -	CR7E	4578	0,8			225	CR7EIX	7385
KFX 400 A (SQ)	400	03 -	CR8E	1275	0,7	CR8EVX	6487	226	CR8EIX	4218
KLF 400 B	400	93 - 99	DPR8EA-9	4929	0,9	DPR8EVX-9	2872	221	DPR8EIX-9	2202
KVF 400 C&D	400	99 - 02	DPR8EA-9	4929	0,9	DPR8EVX-9	2872	221	DPR8EIX-9	2202
KXF 400 A	400	03 -	CR8EB	7784	0,6	CR8EVX	6487		cr8eix	4218
Mule 1000 / KAF 450B (UV)	450	90 - 95	D6EA	7512	0,7					
Mule 2010 / KAF 540C (UV)	540	90 - 93	BPR5ES	7422	0,6	BPR5EVX	4875		BPR5EIX	6597
Mule 2510 / KAF 620A&C (UV)	620	93 - 02	BMR2A	7677	0,6					
Mule 3010 / KAF 620E&G (UV)	620	01 -	BPR2ES	2264	0,6					
KVF 650 4X4	650	05 -	CR7E	4578	0,8			225	CR7EIX	7385
KVF 650 A	650	00 -	CR7E	4578	0,8			225	CR7EIX	7385
KFV 700	700	04 -	CR7E	4578	0,8			225	CR7EIX	7385
KFX 700 Quad	700	04 -	CR7E	4578	0,8			225	CR7EIX	7385
KSV 700	700	04 -	CR7E	4578	0,8			225	CR7EIX	7385
KVF 750	750	05 -	CR7E	4578	0,8			225	CR7EIX	7385

**KOLPIN**

50	50		BR8HSA	5539	0,8	BR8HVX	6265		BR8HIX	7001
90	90		BR8HSA	5539	0,8	BR8HVX	6265		BR8HIX	7001

**KREIDLER**

Mini Mustang	50	05 -	BPR7HS	6422	0,8	BPR7HVX	2938	215	BPR7HIX	5944
Mustang	50	05 -	BPR7HS	6422	0,8	BPR7HVX	2938	215	BPR7HIX	5944
F-Kart 100	100	05 -	BPR7HS	6422	0,8	BPR7HVX	2938	215	BPR7HIX	5944
Mustang 170	170	05 -	DR8EA	7162	0,7	DR8EVX	6354		DR8EIX	6681
Mustang 200	170	05 -	DR8EA	7162	0,7	DR8EVX	6354		DR8EIX	6681
Mustang 250	250	05 -	CR8HS	7423	0,7	CR8HVX	7236		CR8HIX	7669

**KYMCO**

MX 50	50	01 -	BR8HSA	5539	0,5	BR8HVX	6265		BR8HIX	7001
MXér 50	50	05 -	BR8HSA	5539	0,5	BR8HVX	6265		BR8HIX	7001
MX 150	150	01 -	DR8EA	7162	0,7	DR8EVX	6354		DR8EIX	6681
KXR 250	250	01 -	DPR7EA-9	5129	0,9	DPR7EVX-9	7682	220	DPR7EIX-9	7803
MXU 250	250	05 -	DPR7EA-9	5129	0,9	DPR7EVX-9	7682	220	DPR7EIX-9	7803
Maxxer 300	300	05 -	DPR7EA-9	5129	0,9	DPR7EVX-9	7682	220	DPR7EIX-9	7803
MXU 500 4x4	500	06 -	CR8E	1275	0,6			226	CR8EIX	4218

**LEM**

Cayman	50	97 - 04	BR8HS	4322	0,6	BR8HVX	6265	212	BR8HIX	7001
Condor	50	97 - 04	BR8HS	4322	0,6	BR8HVX	6265	212	BR8HIX	7001

**LINHAI**

260	260	05 -	DR8EA	7162	0,7	DR8EVX	6354		DR8EIX	6681
-----	-----	------	-------	------	-----	--------	------	--	--------	------



Order No.



Gold-Palladium

Platin



Order No.

Quick No.

Iridium



Order No.

**MANCO**

Miny Indy 5.0 hp Subaru Engine	50		BR6HS	3922	0,7			209	BR6HIX	3419
Stock Car 4.0 hp Subaru Engine	50		BR6HS	3922	0,7			209	BR6HIX	3419
ZSR-50	50		BPR7HS	6422	0,8	BPR7HVX	2938	215	BPR7HIX	5944
ZSR-90	90		BPR7HS	6422	0,8	BPR7HVX	2938	215	BPR7HIX	5944
Bandit Kart 4.0 hp Subaru Engine	126		BR6HS	3922	0,6			209	BR6HIX	3419
Critter Kart 5.0 hp Subaru Engine	126		BR6HS	3922	0,7			209	BR6HIX	3419
Eliminator Kart 5.0 hp Subaru Engine	126		BR6HS	3922	0,6			209	BR6HIX	3419
Force Five Kart 5.0 hp Subaru Engine	126		BR6HS	3922	0,6			209	BR6HIX	3419
Quicksilver Kart 5.0 hp Subaru Engine	126		BR6HS	3922	0,7			209	BR6HIX	3419
Eliminator Kart 6.5 hp Subaru Engine	169		BR6HS	3922	0,7			209	BR6HIX	3419
EZ Rider 6.5 hp Subaru Engine	169		BR6HS	3922	0,7			209	BR6HIX	3419
Aerforce Kart 7.0 hp Subaru Engine	211		BR6HS	3922	0,7			209	BR6HIX	3419
Intruder Kart 7.0 hp Subaru Engine	211		BR6HS	3922	0,7			209	BR6HIX	3419
8260E	260		DR8EA	7162	0,7	DR8EVX	6354		DR8EIX	6681
Aerforce Kart 10.0 hp Robin Subaru Engine	265		BR6HS	3922	0,7			209	BR6HIX	3419
XTK-713E 13.5 hp Robin Subaru Engine	404		BR6HS	3922	0,6			209	BR6HIX	3419
618 Super Deuce 18.0 hp Honda V-Twin OHV	450		BPR5ES	7422	0,7	BPR5EVX	4875		BPR5EIX	6597

**MOTOR TEK**

MT 125	125	05 -	CR7HSA	4549	0,8				CR7HIX	7544
MT 175	175	05 -	DR8EA	7162	0,7	DR8EVX	6354		DR8EIX	6681

**MSA**

Fox	50	00 -	BR8HSA	5539	0,8	BR8HVX	6265		BR8HIX	7001
Mini Fox	50	00 -	BM6A	5921	0,6					
Sport	50	00 -	BR8HSA	5539	0,8	BR8HVX	6265		BR8HIX	7001
Fox	90	00 -	CR7HSA	4549	0,6				CR7HIX	7544
Fox	100	00 -	BR8HSA	5539	0,8	BR8HVX	6265		BR8HIX	7001
Sport	100	00 -	BR8HSA	5539	0,8	BR8HVX	6265		BR8HIX	7001

**MZ**

ATV 50	50	03 -	BP6HS	4511	0,6	BP6HVX	4635		BPR6HIX	4085
ATV 100	100	03 -	BP6HS	4511	0,6	BP6HVX	4635		BPR6HIX	4085
MT 125 Cobra	125	05 -	C7HSA	4629	0,6	C7HVX	4533		CR7HIX	7544
KX 150	150	05 -	CR7E	4578	0,6			225	CR7EIX	7385
VRS 150	150	05 -	CR7E	4578	0,6			225	CR7EIX	7385

**PANDA**

KD 50 A	50	00 - 01	CR6HSA	2983	0,7				CR6HIX	7274
KD 80 A	80	00 - 01	CR6HSA	2983	0,7				CR6HIX	7274
KD 125 A	125	00 - 01	CR6HSA	2983	0,7				CR6HIX	7274

**PGO**

110	110	03 -	BPR7HS	6422	0,8	BPR7HVX	2938	215	BPR7HIX	5944
151	150	03 -	CR7HSA	4549	0,6				CR7HIX	7544

**POLARIS**

UTV 2X4 24 PS 4Takt			BKR5E	7938	0,6				BKR5EIX	6341
UTV 4X4 30 PS 4Takt			BKR5E	7938	0,6				BKR5EIX	6341
UTV 6X6 30 PS 4Takt			BKR5E	7938	0,6				BKR5EIX	6341
Predator AR03-01	50	03 -	BPR7HS	6422	0,8	BPR7HVX	2938	215	BPR7HIX	5944
Youth Scrambler AR03	50	01 - 03	BPR7HS	6422	0,8	BPR7HVX	2938	215	BPR7HIX	5944

Order  
No.Platin  
Gold-  
Palla-  
diumOrder Quick  
No. No.Order  
No.**POLARIS**

Youth Predator AR07	90	03 -	BPR7HS	6422	0,8	BPR7HVX	2938	215	BPR7HIX	5944
Youth Scrambler AR07	90	01 - 02	BPR7HS	6422	0,8	BPR7HVX	2938	215	BPR7HIX	5944
Youth Sportsman AR07	90	01 -	BPR7HS	6422	0,8	BPR7HVX	2938	215	BPR7HIX	5944
Phönix 200	200	05 -	CR7HSA	4549	0,6				CR7HIX	7544
Big Boss	250	89 - 93	BR8ES	5422	0,6	BR8EVX	1262	207	BR8EIX	5044
Cyclone	250	88 - 89	BR8ES	5422	0,6	BR8EVX	1262	207	BR8EIX	5044
Scrambler	250	89 - 93	BR8ES	5422	0,6	BR8EVX	1262	207	BR8EIX	5044
Trail Blazer	250	90 -	BR8ES	5422	0,6	BR8EVX	1262	207	BR8EIX	5044
Trail Boss	250	85 -	BR8ES	5422	0,6	BR8EVX	1262	207	BR8EIX	5044
Xplorer EC25	250	00 - 02	BR8ES	5422	0,5	BR8EVX	1262	207	BR8EIX	5044
Xplorer 300	283	94 -	BR8ES	5422	0,6	BR8EVX	1262	207	BR8EIX	5044
Xpress 300	283	94 -	BR8ES	5422	0,6	BR8EVX	1262	207	BR8EIX	5044
Xplorer EC28	300	94 - 00	BR8ES	5422	0,5	BR8EVX	1262	207	BR8EIX	5044
Xpress EC28	300	94 - 00	BR8ES	5422	0,5	BR8EVX	1262	207	BR8EIX	5044
Magnum 330 4x4	330	05 -	BKR6ES	3783	0,6	BKR6EVX	3539		BKR6EIX	6418
Trail Boss 330	330	05 -	BKR6ES	3783	0,6	BKR6EVX	3539		BKR6EIX	6418
Sportsman 335	334	99 -	BKR7E	6097	0,6				BKR7EIX	2667
Big Boss	350	93 -	BR8ES	5422	0,6	BR8EVX	1262	207	BR8EIX	5044
Trail Boss	350	90 - 93	BR8ES	5422	0,6	BR8EVX	1262	207	BR8EIX	5044
Trail Boss EC35	350	90 - 93	BR8ES	5422	0,5	BR8EVX	1262	207	BR8EIX	5044
Big Boss 400L (6X6)	379	95 - 97	BR8ES	5422	0,6	BR8EVX	1262	207	BR8EIX	5044
Scambler 400 (4X4)	379	94 -	BR8ES	5422	0,6	BR8EVX	1262	207	BR8EIX	5044
Sport 400	379	98 -	BR8ES	5422	0,6	BR8EVX	1262	207	BR8EIX	5044
Sport ATV	379	95 - 97	BR8ES	5422	0,6	BR8EVX	1262	207	BR8EIX	5044
Sportsman 4x4	379	94 - 97	BR8ES	5422	0,6	BR8EVX	1262	207	BR8EIX	5044
Xplorer 400/400L 4x4	379	94 -	BR8ES	5422	0,6	BR8EVX	1262	207	BR8EIX	5044
Xpress 400 L 2x4	379	96 - 97	BR8ES	5422	0,6	BR8EVX	1262	207	BR8EIX	5044
Big Boss EC38	400	95 - 98	BR8ES	5422	0,5	BR8EVX	1262	207	BR8EIX	5044
Scrambler EC38	400	94 - 02	BR8ES	5422	0,5	BR8EVX	1262	207	BR8EIX	5044
Sport EC38	400	95 - 99	BR8ES	5422	0,5	BR8EVX	1262	207	BR8EIX	5044
Sportsman EC38	400	94 - 97	BR8ES	5422	0,5	BR8EVX	1262	207	BR8EIX	5044
Sportsman EC38	400	03 -	BKR5E	7938	0,6				BKR5EIX	6341
Trail Blazer EC38	400	03 -	BR8ES	5422	0,5	BR8EVX	1262	207	BR8EIX	5044
Xplorer EC38	400	94 - 02	BR8ES	5422	0,5	BR8EVX	1262	207	BR8EIX	5044
Xpress EC38	400	96 - 97	BR8ES	5422	0,5	BR8EVX	1262	207	BR8EIX	5044
Expedition EH42	425	01 - 03	BKR5E	7938	0,6				BKR5EIX	6341
Magnum (2X4)	425	95 -	BKR5E	7938	0,6				BKR5EIX	6341
Magnum (4X4)	425	95 -	BKR5E	7938	0,6				BKR5EIX	6341
Magnum (6X6)	425	96 - 97	BKR5E	7938	0,6				BKR5EIX	6341
Ranger EH42	425	02 -	BKR5E	7938	0,6				BKR5EIX	6341
Sportsman EH42	425	01 - 04	BKR5E	7938	0,6				BKR5EIX	6341
ATP 500	500	05 -	BKR6ES	3783	0,6	BKR6EVX	3539		BKR6EIX	6418
Big Boss 500 (6X6)	500	98 -	BKR5E	7938	0,6				BKR5EIX	6341
Hauler Light Utility EH50	500	02 - 03	BKR5E	7938	0,6				BKR5EIX	6341
Magnum 500	500	99 -	BKR5E	7938	0,6				BKR5EIX	6341
Predator ES 50	500	03 -	DCPR8E	4339	0,9	DCPR8EVX	2265		DCPR8EIX	6546
Predator 500	500	05 -	DCPR8E	4339	0,9	DCPR8EVX	2265		DCPR8EIX	6546
Pro ATV EH50	500	02 - 03	BKR5E	7938	0,6				BKR5EIX	6341
Ranger	500	99 -	BKR5E	7938	0,6				BKR5EIX	6341
Scrambler 500	500	98 -	BKR5E	7938	0,6				BKR5EIX	6341
Sportsman 500	500	96 - 04	BKR5E	7938	0,6				BKR5EIX	6341
Sportsman 6x6	500	05 -	BKR6ES	3783	0,6	BKR6EVX	3539		BKR6EIX	6418



Order No.



Gold-Palladium



Order No.

Quick No.

Iridium



Order No.

## POLARIS

Task Force Utility EH50	500	02 - 03	BKR5E	7938	0,6				BKR5EIX	6341
Xplorer 500	500	97 -	BKR5E	7938	0,6				BKR5EIX	6341
Sportsmann 600	600	03 -	BKR7E	6097	0,6				BKR7EIX	2667
Ranger TM	653	04 -	BPR4ES	7222	0,7	BPR4EVX	3436			
Sportsmann 700	700	03 -	BKR7E	6097	0,6				BKR7EIX	2667
Sportsman 800	800	05 -	BKR7E	6097	0,6				BKR7EIX	2667

## SACHS

4rock 50	50	06 -	BPR7HS	6422	0,7	BPR7HVX	2938	215	BPR7HIX	5944
Little Devil	50		BP6HS	4511	0,6	BP6HVX	4635		BPR6HIX	4085
T-Rex 50	50	06 -	BPR7HS	6422	0,6	BPR7HVX	2938	215	BPR7HIX	5944
Helix 100	100	06 -	BPR7HS	6422	0,6	BPR7HVX	2938	215	BPR7HIX	5944
T-Rex 100	100	06 -	BPR7HS	6422	0,6	BPR7HVX	2938	215	BPR7HIX	5944
4rock 110	110	06 -	BPR7HS	6422	0,7	BPR7HVX	2938	215	BPR7HIX	5944
4rock 150	150	06 -	C7HSA	4629	0,7	C7HVX	4533		CR7HIX	7544
Helix 150	150	06 -	C7HSA	4629	0,6	C7HVX	4533		CR7HIX	7544
4rock 250	250	06 -	CR8HS	7423	0,7	CR8HVX	7236		CR8HIX	7669

## SUZUKI

LT 50	50		BPR4HS	7823	0,7					
LT 80	80		BPR7HS	6422	0,7	BPR7HVX	2938	215	BPR7HIX	5944
LT 160 E	160	- 92	D7EA	7912	0,7	D7EVX	2734			
LT 160 E	160	93 -	DPR7EA-9	5129	0,9	DPR7EVX-9	7682	220	DPR7EIX-9	7803
LT 160 F	160	93 -	DP7EA-9	5629	0,9	DPR7EVX-9	7682		DPR7EIX-9	7803
LT-F 160	160	95 -	DP7EA-9	5629	0,9	DPR7EVX-9	7682		DPR7EIX-9	7803
LT 230 E	230	93 -	D7EA	7912	0,7	D7EVX	2734			
LT 230 E/F	230		DR7ES	3123	0,7					
LT 230 GE	230		D7EA	7912	0,7	D7EVX	2734			
LT 250 4WD/F4WD	250	- 94	DR7ES	3123	0,7					
LT 250 E/EF	250	93 -	D8EA	2120	0,7	D8EVX	2850	216	DR8EIX	6681
LT 250 EF	250		DR8ESL	2923	0,7	DR8EVX	6354	218	DR8EIX	6681
LT 250 R	250				0,6	BR8EVX	1262		BR8EIX	5044
LT 250 R	250	93 -			0,6	B9EGV	5827			
LT 250 S	250		DPR7EA-9	5129	0,9	DPR7EVX-9	7682	220	DPR7EIX-9	7803
LTF 250	250	93 -	DR7ES	3123	0,7					
LTF 250	250	- 94	DR7ES	3123	0,7					
LTF 250	250	95 -	D7EA	7912	0,6	D7EVX	2734			
LT-4 WDX	280	95 -	D7EA	7912	0,6	D7EVX	2734			
LT-4WD / F4WD	280	95 -	DR7EA	7839	0,6					
LT-F4WDX	280	93 - 94	DR7ES	3123	0,7					
LT-300	300	87 - 89	D8EA	2120	0,6	D8EVX	2850	216	DR8EIX	6681
LT-F 300	300	99 -	D7EA	7912	0,6	D7EVX	2734			
LT-A 400F	400	02 -	CR7E	4578	0,6			225	CR7EIX	7385
LT-A 400	400	02 -	CR7E	4578	0,6			225	CR7EIX	7385
LT-F 400	400	02 -	CR7E	4578	0,6			225	CR7EIX	7385
LT-F 400F	400	02 -	CR7E	4578	0,6			225	CR7EIX	7385
LT-Z 400	400	02 -	CR7E	4578	0,6			225	CR7EIX	7385
LT-A 500F	500	00 -	CR6E	6965	0,6					
LT-F 500	500	98 - 99	CR7E	4578	0,6			225	CR7EIX	7385
LT-F 500F	500	00 -	CR6E	6965	0,6					



Order No.



Gold-Palladium



Order No.

Quick No.

Iridium



Order No.

**SYM**

Track Runner 200	200	06 -	CR8E	1275	0,6			226	CR8EIX	4218
Quad Lander 250	250	06 -	CR8E	1275	0,6			226	CR8EIX	4218

**TNG**

Venice 492	50		BP7HS	5111	0,7	BP7HVX	7468		BPR7HIX	5944
Del Ray 125	125		C7HSA	4629	0,7	C7HVX	4533		CR7HIX	7544
Milano 125	125		C7HSA	4629	0,7	C7HVX	4533		CR7HIX	7544
Baja 150	150		C7HSA	4629	0,6	C7HVX	4533		CR7HIX	7544
Milano 150	150		C7HSA	4629	0,7	C7HVX	4533		CR7HIX	7544

**TRAILBLAZER**

50	50		BP7HS	5111	0,7	BP7HVX	7468		BPR7HIX	5944
Mini	50		BPR7HS	6422	0,7	BPR7HVX	2938	215	BPR7HIX	5944
2-Stroke/ Takt	90		BP7HS	5111	0,7	BP7HVX	7468		BPR7HIX	5944
4-Stroke/ Takt	90		CR7HSA	4549	0,7				CR7HIX	7544
170	170	04 -	DR8EA	7162	0,7	DR8EVX	6354		DR8EIX	6681
Trailblazer 170	170		DR8EA	7162	0,7	DR8EVX	6354		DR8EIX	6681
250	250		CR8HSA	2086	0,8	CR8HVX	7236		CR8HIX	7669

**TRAILSPORT**

TS-500 5.0hp		04 -	BR2LM	5798	0,6			310		
TSB-600 6.0hp		04 -	BR2LM	5798	0,6			310		

**UNILLI**

KX 150	150	05 -	CR7E	4578	0,6			225	CR7EIX	7385
--------	-----	------	------	------	-----	--	--	-----	--------	------

**UNISOM**

Desert-Cat 50	50	04 -	BR8HS	4322	0,6	BR8HVX	6265	212	BR8HIX	7001
Desert-Cat 90	90	04 -	BR8HS	4322	0,6	BR8HVX	6265	212	BR8HIX	7001

**UNITED MOTORS**

Dirt Squirt	50		BR8HS	4322	0,6	BR8HVX	6265	212	BR8HIX	7001
Monntrax	50		BPR7HS	6422	0,8	BPR7HVX	2938	215	BPR7HIX	5944
Dirt Squirt	90		BR8HS	4322	0,6	BR8HVX	6265	212	BR8HIX	7001
Earthlander	90		BPR7HS	6422	0,8	BPR7HVX	2938	215	BPR7HIX	5944
Moontrax	90		BPR7HS	6422	0,6	BPR7HVX	2938	215	BPR7HIX	5944
Reptile	90		C7HSA	4629	0,7	C7HVX	4533		CR7HIX	7544

**VENTO**

Avalanche EX100	100		BPR6HS	7022	0,7	BPR6HVX	2740	214	BPR6HIX	4085
Rhino 250	250		DR8EA	7162	0,7	DR8EVX	6354		DR8EIX	6681

**VINSON**

ETV 4Takt	150		C7HSA	4629	0,6	C7HVX	4533		CR7HIX	7544
ETV 4Takt	250		C7HSA	4629	0,6	C7HVX	4533		CR7HIX	7544

**XING FU**

XF Trail 150	150	05 -	C7HSA	4629	0,6	C7HVX	4533		CR7HIX	7544
XF Trail 250	250	05 -	C7HSA	4629	0,6	C7HVX	4533		CR7HIX	7544

**YAMAHA**

YMF 50 S	50	04 -	CR7HS	7223	0,7				CR7HIX	7544
----------	----	------	-------	------	-----	--	--	--	--------	------





Order No.



Platin Gold-Palladium

Order Quick No. No.

Iridium



Order No.

# YAMAHA

YF 60 (1HN)	60	87 - 88	BPR6HS	7022	0,7	BPR6HVX	2740	214	BPR6HIX	4085
YFM 80	80		CR7HS	7223	0,7				CR7HIX	7544
YFM 80 W	80	02 -	CR7HS	7223	0,7				CR7HIX	7544
YFM 80 W Badger	80	02 -	CR7HS	7223	0,7				CR7HIX	7544
YFM 80 E / F	80	93 -	C7HSA	4629	0,7	C7HVX	4533		CR7HIX	7544
YFA 1 Breeze	125	89 - 04	CR7HS	7223	0,7				CR7HIX	7544
YFA 1 F	125	94 -	C7HSA	4629	0,7	C7HVX	4533		CR7HIX	7544
YT 125	125		BP6ES	7811	0,8	BP6EVX	5832		BPR6EIX	6637
YT 125 CH	125		BP6ES	7811	0,8	BP6EVX	5832		BPR6EIX	6637
YT 125 H	125		BP6ES	7811	0,8	BP6EVX	5832		BPR6EIX	6637
YT 175	175		BP7ES	2412	0,8	BP7EVX	7270	206	BPR7EIX	4055
YFM 200	200	92 -	D7EA	7912	0,6	D7EVX	2734			
YFM 200 (52H)	200	85 - 86	DR7ES	3123	0,7					
YFM 225 (2HT)	200		DR7ES	3123	0,7					
YFM 225 (59V)	200		DR7ES	3123	0,7					
YFS 200 Blaster	200	90 - 04	BR8ES	5422	0,8	BR8EVX	1262	207	BR8EIX	5044
YFS 200 E / F	200	93 -	B8ES	2411	0,8	B8EVX	7051	201	BR8EIX	5044
TT 225	225		DR8ESL	2923	0,7	DR8EVX	6354	218	DR8EIX	6681
YFM 225 59V/2HT	225	92 -	DR7ES	3123	0,7					
YFB 250 / E / F / FWF	250	93 -	D7EA	7912	0,7	D7EVX	2734			
YFB 250 / FW	250	94 -	DR7EA	7839	0,7					
YFM 250 Timberwolf	250		DR7EA	7839	0,7					
YFM 250 (3GH)	250	90 -	DR7ES	3123	0,7					
YFM 250 Bruin	250	05 -	DR7EA	7839	0,6					
YFM 250 X Bear Tracker	250	99 - 04	DR7EA	7839	0,7					
YFM 350 (3HN)	350	89 -	DR8ESL	2923	0,6	DR8EVX	6354	218	DR8EIX	6681
YFM 350 2HR/2HN	350	92 -	DR8ESL	2923	0,6	DR8EVX	6354	218	DR8EIX	6681
YFM 350 4x4 (2HR)	350		DR8ESL	2923	0,7	DR8EVX	6354	218	DR8EIX	6681
YFM 350 4x4 (3HN)	350		DR8ESL	2923	0,7	DR8EVX	6354	218	DR8EIX	6681
YFM 350 ERF / FWF / XF	350	94 -	D8EA	2120	0,7	D8EVX	2850	216	DR8EIX	6681
YFM 350 FW	350	94 -	DR8EA	7162	0,7	DR8EVX	6354		DR8EIX	6681
YFM 350 X Warrior	350	97 - 04	DR8EA	7162	0,7	DR8EVX	6354		DR8EIX	6681
YFZ 350	350	94 -	BR8ES	5422	0,8	BR8EVX	1262	207	BR8EIX	5044
YFZ 350 Banshee	350	86 - 04	BR8ES	5422	0,8	BR8EVX	1262	207	BR8EIX	5044
YFZ 350 E / F	350	93 -	B8ES	2411	0,8	B8EVX	7051	201	BR8EIX	5044
YFM 400	400	93 -	DR8ESL	2923	0,7	DR8EVX	6354	218	DR8EIX	6681
YFM 400 AN Kodiak	400	03 - 04	DR8EA	7162	0,7	DR8EVX	6354		DR8EIX	6681
YFM 400 FW	400	94 - 04	DR8EA	7162	0,7	DR8EVX	6354		DR8EIX	6681
YFM 400 FWF	400	94 -	D8EA	2120	0,7	D8EVX	2850	216	DR8EIX	6681
YFM 400 FWA Kodiak	400	00 - 04	DR8EA	7162	0,7	DR8EVX	6354		DR8EIX	6681
YFM 450 FWAN Kodiak	400	03 - 04	DR8EA	7162	0,7	DR8EVX	6354		DR8EIX	6681
YFZ 450 S	450	04 -	CR8E	1275	0,7	CR8EVX	6487	226	CR8EIX	4218
YFM 660 FWA Grizzly	660	02 - 04	DPR8EA-9	4929	0,9	DPR8EVX-9	2872	221	DPR8EIX-9	2202
YFM 660 R	660	01 - 04	DPR8EA-9	4929	0,9	DPR8EVX-9	2872	221	DPR8EIX-9	2202
YXR 660 Rhino	660	05 -	DPR8EA-9	4929	0,9	DPR8EVX-9	2872	221	DPR8EIX-9	2202
YXR 660 FAS	660	04 -	DPR8EA-9	4929	0,9	DPR8EVX-9	2872	221	DPR8EIX-9	2202
YFM 700	700	05 -	CR7E	4578	0,6			225	CR7EIX	7385
YFM 700	700	09.06 -	CPR7EA-9		0,9					

# YERF-DOG

23000	90	04 -	BP7HS	5111	0,7	BP7HVX	7468		BPR7HIX	5944
23100	150	04 -	BR6ES	4922	0,6					





ccm

Order-  
No.**APRILIA**

AF1 50	01.86 -	50	LB05F	8051
ET 50 AE,-Fire	01.87 -	50	LB05F	8051
GL 50	02.93 -	50	LB05F	8051
LX 50	02.93 -	50	LB05F	8051
RC 50	01.79 - 12.82	50	LB05F	8051
Red Rose 50	06.87 -	50	LB05F	8051
RS 50 Extrema / Replica	01.93 -	50	LB05F	8051
RX 50	09.90 -	50	LB05F	8051
Tuareg 50	01.87 -	50	LB05F	8051
RX 125	01.90 -	125	LB05F	8051

**BMW**

R 45 26kW	06.78 - 06.83	475	LB05F	8051
R 45 20kW	06.78 - 07.85	475	LB05F	8051
R 50/5		500	LB05F	8051
R 60/5, /6, /7	- 06.78	600	LB05F	8051
R 65	06.78 -	650	LB05F	8051
R 75/5, /6, /7		750	LB05F	8051
R 80	08.82 - 95	800	LB05F	8051
R 80 RT	08.82 - 95	800	LB05F	8051
R 80 R	80 -	800	LB05F	8051
R 80 ST	08.82 - 95	800	LB05F	8051
R 80 GS	08.82 - 94	800	LB05F	8051
R 80/7N /7S	09.77 - 08.80	800	LB05F	8051
R 850 GS	98 -	850	LB05F	8051
R 850 R 52kW	10.94 -	850	LB05F	8051
R 850 RT	99 -	850	LB05F	8051
R 90/6		900	LB05F	8051
R 90/S		900	LB05F	8051
R 100		1000	LB05F	8051
R 100 R	94 -	1000	LB05F	8051
R 100 RS	09.86 -	1000	LB05F	8051
R 100/7		1000	LB05F	8051
R 100/CS /RT		1000	LB05F	8051
R 100/RS	- 08.86	1000	LB05F	8051
R 100 GS	09.86 -	1000	LB05F	8051
R 100/S /T	09.76 - 08.80	1000	LB05F	8051

**CAGIVA**

WMX 125/84		125	LB05F	8051
WMX 125/85		125	LB05F	8051
WMX 125/88		125	LB05F	8051
All		175	LB05F	8051
All		200	LB05F	8051
MX,MXR,RR,RX,WMX		250	LB05F	8051
NC,RL,SS,SST	01.83 -	250	LB05F	8051
RX 250 Rally	01.79 - 11.83	250	LB05F	8051
SX, SXT	01.83 - 12.84	250	LB05F	8051
Ala Blu 350		350	LB05F	8051
Ala Rossa 350/4T	01.83 -	350	LB05F	8051
Ala Verde 350		350	LB05F	8051
Alazzurra 350 (D)	01.84 -	350	LB05F	8051



ccm

Order-  
No.

<b>CAGIVA</b>				
Elefant 350 (D)		350	LB05F	8051
Lucky 350		350	LB05F	8051
SST 350		350	LB05F	8051
W12	94 -	350	SD05FP	8325
W16	94 -	600	SB05F	8080
<b>DAELIM</b>				
125 Daystar	01.00 -	125	XB01F	8431
VC 125 Advance	95 -	125	XB01F	8431
VT 125 Evolution	03.98 -	125	XB01F	8431
<b>DUCATI</b>				
600 Pantah SL/TL (D)	81 -	600	VB05F	8032
900 S,SS,GTS,SD,S2,HR (D)	80 - 87	900	VB05F	8032
<b>GAS GAS</b>				
TT 125		125	LB05F/CR2	8051/8048
TT 200		200	LB05F/CR2	8051/8048
Cross 250		250	LB05F/CR2	8051/8048
TT 250		250	LB05F/CR2	8051/8048
TT 300		300	LB05F/CR2	8051/8048
<b>GILERA</b>				
50 TS	01.79 - 12.82	50	LB05F	8051
CB1 4V		50	LB05F	8051
Touring	01.73 - 12.81	50	LB05F	8051
Trial		50	LB05F	8051
Giubileo 4 T, SS		98	LB05F	8051
125 5V Regolarità		125	LB05F	8051
125 Arcore, Export	01.72 - 06.80	125	LB05F	8051
125 SV Regolarità		125	LB05F	8051
Saturno 500	04.88 - 92	500	LB05F	8051
<b>HERCULES</b>				
City Bike C1	10.72 - 08.78	50	LB05F	8051
City Bike C2	10.72 - 08.78	50	LB05F	8051
City Bike C3	09.74 - 08.78	50	LB05F	8051
Hobby Rider HR 1	10.72 - 12.87	50	LB05F	8051
Hobby Rider HR 2	10.72 - 12.87	50	LB05F	8051
Jogging		50	LB05F	8051
K 50	- 08.78	50	LB05F	8051
K 50 Ultra	- 08.78	50	LB05F	8051
K 50 Ultra II	- 08.78	50	LB05F	8051
K 50 Ultra LC	- 08.78	50	LB05F	8051
K 50 Ultra LC II	- 08.78	50	LB05F	8051
K 50 Ultra LC III	- 08.78	50	LB05F	8051
KX 5	01.86 -	50	LB05F	8051
Lastboy		50	LB05F	8051
M1	10.72 - 12.77	50	LB05F	8051
M2	10.72 - 12.77	50	LB05F	8051
M4	09.74 - 12.78	50	LB05F	8051
M5	09.74 - 12.78	50	LB05F	8051



ccm

Order-  
No.**HERCULES**

MK 1S	01.78 - 08.80	50	LB05F	8051
MK 2S	01.78 - 08.80	50	LB05F	8051
MP 2	10.72 - 12.77	50	LB05F	8051
MP 4	10.72 - 12.77	50	LB05F	8051
MX 1	01.89 -	50	LB05F	8051
MX 1		50	LB05F	8051
Optima 3	01.78 -	50	LB05F	8051
Optima 50		50	LB05F	8051
Prima 2		50	LB05F	8051
Prima 2S	01.89 -	50	LB05F	8051
Prima 3		50	LB05F	8051
Prima 3S	01.89 -	50	LB05F	8051
Prima 4		50	LB05F	8051
Prima 4LN,5LN		50	LB05F	8051
Prima 5		50	LB05F	8051
Prima 5,5S,5SE	01.89 -	50	LB05F	8051
Prima 6		50	LB05F	8051
Prima G3		50	LB05F	8051
Prima GT	01.89 -	50	LB05F	8051
Prima GT,GX		50	LB05F	8051
Prima Presto		50	LB05F	8051
Prima Pronto		50	LB05F	8051
Prima S		50	LB05F	8051
Prima SL		50	LB05F	8051
Prima SX		50	LB05F	8051
Sport Bike SB1	10.72 - 08.74	50	LB05F	8051
Sport Bike SB2	10.72 - 08.79	50	LB05F	8051
Sport Bike SB3	09.74 - 08.79	50	LB05F	8051
Sport Bike SB5	09.74 - 08.76	50	LB05F	8051
Supra 2D,3D	06.80 -	50	LB05F	8051
Supra 4	06.78 -	50	LB05F	8051
Supra 4GP	01.80 -	50	LB05F	8051
Supra Enduro	03.80 -	50	LB05F	8051
Ultra 50		50	LB05F	8051
XE 5	01.86 -	50	LB05F	8051
ZX 1		50	LB05F	8051
RX 9		80	LB05F	8051
Ultra 80 LC		80	LB05F	8051
Ultra 80 AC	01.82 -	80	LB05F	8051
XE 9	01.82 -	80	LB05F	8051
K 100 X		100	LB05F	8051
K 125 BW Military	09.74 -	125	LB05F	8051
K 125 GS		125	LB05F	8051
K 125 MC		125	LB05F	8051
K 125 S	10.72 - 08.79	125	LB05F	8051
K 125 T	10.72 - 08.79	125	LB05F	8051
K 125 X		125	LB05F	8051
175 GS		175	LB05F	8051
250 GS		250	LB05F	8051
350 GS		350	LB05F	8051



ccm

Order-  
No.

				<b>HONDA</b>
Camino PA 50	01.75 - 12.87	50	LB05F	8051
CB 50		50	LD05F	8060
CB 50 Y	01.73 - 01.83	50	LD05F	8060
CY 50	01.81 -	50	LD05F	8060
Elite 50/S		50	LB05F	8051
MB 50 F (AC01)		50	LB05F	8051
MB 50 S (AC01)		50	LB05F	8051
MBX 50 M (AC05)		50	LB05EMH	8160
MBX 50 S (AC05)		50	LB05EMH	8160
MBX 50 SD (AC05)		50	LB05EMH	8160
MR 50		50	LB05F	8051
MT 50 F (AD04)		50	LB05F	8051
MT 50 S (AD04)		50	LB05F	8051
MTX 50 R		50	LB05EMH	8160
MTX 50 S	86 -	50	LB05EMH	8160
NC 50		50	LB05F	8051
NE 50		50	LB05F	8051
NE 50 Vision	90 -	50	LB05F	8051
NSR 50	89 -	50	LB05F	8051
NT 50		50	LB05F	8051
NX 50		50	LB05F	8051
NX 50 M		50	LB05F	8051
PA 50	84 -	50	LB05F	8051
PF 50		50	LB05F	8051
PK 50 DX (AB25)	95 -	50	LB05F	8051
PK 50 Wallaroo	90 -	50	LB05F	8051
PM 50		50	LB05F	8051
PX 50	84 -	50	LB05F	8051
PX 50 E	80 -	50	LB05F	8051
PX 50 R	85 -	50	LB05F	8051
PZ 50		50	LB05F	8051
SA 50 (AF29)		50	LB05F	8051
SE 50		50	LB05F	8051
SFX 50	96 -	50	LB05F	8051
SH 50 T (AF40)	97 -	50	LB05F	8051
SH 50	01.84 -	50	LB05F	8051
SJ 50 Bali		50	LB05F	8051
ST 50 C (AB23) Dax		50	LD05F	8060
TLM 50		50	LB05EMH	8160
XL 50	01.80 -	50	LD05F	8060
XR 50	93 - 02	50	LD05F	8060
Z 50 GZ (Monkey)	01.80 - 12.84	50	LD05F	8060
Z 50 J (Monkey)		50	LD05F	8060
Z 50 R (Monkey)	94 -	50	LD05F	8060
ZB 50 P (AB22)(Monkey)	88 -	50	VD05F	8052
CT 70	92 -	70	LD05F	8060
ST 70	94 -	70	LD05F	8060
NS-1	96 -	75	LB05F	8051
CR 80 R	- 85	80	LB05EMH	8160
CR 80 R	86 -	80	LB05EMH	8160
CY 80		80	LD05F	8060
MB 80 (HC01)	01.80 -	80	LB05F	8051



ccm

Order-  
No.**HONDA**

MBX 80 SWD/SW2D (HC04)	87 -	80	LB05F	8051
MCX 80 (HC05)	01.80 -	80	LB05F	8051
MT 80 F		80	LB05F	8051
MT 80 S (HD02)		80	LB05F	8051
MTX 80 C	82 -	80	LB05EMH	8160
MTX 80 R (D) (HD08)		80	LB05EMH	8160
MTX 80 R (F) (HD08)		80	LB05EMH	8160
MTX 80 R II (HD09)	87 -	80	LB05EMH	8160
MTX 80 RS (HD08)	83 - 85	80	LB05EMH	8160
NSR 80		80	LB05F	8051
SH 80 E Scoopy	84 -	80	LB05F	8051
XR 80R	92 -	80	LB05F	8051
EZ 90	93 -	90	LB05F	8051
NH 90 M	93 -	90	LB05F	8051
NH 90 Yupy	90 -	90	LB05F	8051
XR 100R	92 -	100	VD05F	8052
CG 110		110	LD05F	8060
CA 125 Rebel (JC24)	95 -	125	LD05F	8060
CA 125 C Rebel (JC26)	97 -	125	LD05F	8060
CB 125		125	LD05F	8060
CB 125 K		125	LD05F	8060
CB 125 T		125	LD05F	8060
CB 125 Y		125	LD05F	8060
CG 125		125	LD05F	8060
CG 125 (JC27)	98 -	125	LD05FP	8070
CH 125		125	LD05F	8060
CLR 125 Cityfly (JD18A/B)	98 -	125	VD05FMH	8425
CM 125 (JC05)		125	LD05FP	8070
CM 125 C Custum	94 -	125	LD05F	8060
CR 125 R		125	LB05F/CR2	8051/8048
Italia 125 (I)		125	LD05F	8060
Lead 125 (JF01)		125	LB05F/CR2	8051/8048
MBX 125 F		125	SD05FM	8392
MTX 125		125	LB05EMH	8160
MTX 125 R (I)		125	LB05F	8051
MTX 125 R2 (I)		125	LB05F	8051
NS 125 F (I)		125	LB05EMH	8160
NS 125 R (I)		125	LB05F	8051
NSR 125 F		125	LB05F	8051
TL 125		125	VD05F	8052
XL 125 (I)		125	LD05F	8060
XL 125 R		125	VD05FMH	8425
XL 125 S		125	LD05F	8060
XLR 125 R	98 -	125	VD05FMH	8425
XR 125		125	LD05F	8060
CD 185 T		185	LD05F	8060
CM 185 T	01.78 -	185	LD05F	8060
XL 185 S	01.79 -	185	VD05F	8052
CD 200 T		200	LD05F	8060
CM 200 T		200	LD05F	8060
MTX 200 RW (MD07)	83 - 85	200	LB05EMH	8160
XL 200 R	01.83 -	200	VD05F	8052



ccm

Order-  
No.

				<b>HONDA</b>
250 Spacy (I)		250	LD05F	8060
CB 250 (MC26)	96 -	250	XD05F	8072
CB 250 N	01.80 -	250	XD05F	8072
CB 250 RS (MC02)	01.80 -	250	XD05F	8072
CB 250 T		250	LD05F	8060
CBX 250		250	SD05FM	8392
CD 250 U		250	XD05F	8072
CH 250		250	VD05F	8052
CM 250 C (MC06)	01.82 -	250	LD05FP	8070
CMX 250 CT (MC13)	96 -	250	VD05F	8052
CMX 250 C (MC32B)	97 -	250	VD05F	8052
CR 250 R	82 - 02	250	LB05F/CR2	8051/8048
CR 250 R	- 81	250	LB05F/CR2	8051/8048
NX 250 J (MD21)	88 -	250	VD05F	8052
NX 250 K (MD21)	89 -	250	VD05F	8052
NX 250 L (MD25)	91 -	250	VD05F	8052
TLR 250		250	VD05FMH	8425
VT 250 F2		250	SD05FMC	30465
XL 250 R (MD11)	- 83	250	SD05F	8022
XL 250 R (MD11)	84 - 85	250	SD05F	8022
XL 250 R (MD11)	86 -	250	SD05F	8022
XR 250 L	92 -	250	SD05F	8022
XL 350 R (ND03)	85 - 87	350	VD05F	8052
XR 350 R		350	VD05F	8052
CB 400 A	01.79 -	400	VD05F(IN)XD05F(OUT)	8052/8072
CB 400 N	01.78 - 12.84	400	XD05F	8072
CB 400 T		400	YB05F	8082
CB-1 (NC27)	91 -	400	SD05F	8022
CBX 400 F		400	SD05FMC	30465
CBX 400 F2		400	SD05FMC	30465
CM 400 T	01.80 - 12.84	400	XD05F	8072
CB 450 N (PC14)	85 -	450	LB05F	8051
CB 450 S (PC17)(D)	86 - 88	450	XD05F	8072
CB 450 S (PC17)(I)		450	XD05F	8072
CMX 450 C		450	XD05F	8072
FT 500 (PC07)	01.82 - 12.85	500	VD05F	8052
GB 500 (PC16)	92 -	500	SD05F	8022
VF 500 F (PC12)	84 -	500	SD05FMC	30465
VF 500 F2 (PC12)	85 -	500	SD05FMC	30465
VF 500 F2 (PC12)	- 84	500	SD05FMC	30465
VT 500 C (PC08)	83 -	500	VD05F	8052
VT 500 E (PC11)	83 - 85	500	VD05F	8052
XL 500 R (PD02)	86 -	500	VD05F	8052
XL 500 R (PD02)	- 85	500	VD05F	8052
XL 500 S (PD01)	01.79 - 12.81	500	VD05F	8052
XR 500		500	VD05F	8052
XR 500 R		500	VD05F	8052
CB 550	06.71 - 12.87	550	SD05F(IN)XD05F(OUT)	8022/8072
CB 550 (F1/F2)	76 -	550	SD05F(IN)XD05F(OUT)	8022/8072
CB 550 (K3/4)	76 -	550	SD05F(IN)XD05F(OUT)	8022/8072
CB 550 F	06.71 - 12.87	550	SD05FMC	30465
CBX 550 F (PC04)		550	SD05FMC	30465





ccm

Order-  
No.**HONDA**

CBX 550 F2 (PC04)		550	SD05FMC	30465
CBR 600 F2 (PC25)	93 - 94	600	CR1	8035
CBR 600 F (PC25)	91 - 94	600	CR1	8035
CBR 600 F3 (PC31)	95 - 98	600	CR1	8035
CBR 600 F (PC23)	89 - 90	600	CR1	8035
CBR 600 F (PC19)	87 - 88	600	CR1	8035
CBX 600 E	01.83 - 12.87	600	SD05FMC	30465
NTV 600		600	SD05F/VD05F	8022
XL 600 L		600	SD05FM	8392
XL 600 LM (PD04)	85 - 87	600	SD05FM	8392
XL 600 R (PD03)	83 - 87	600	SD05FM	8392
XL 600 RM (I)		600	SD05FM	8392
XL 600 RM (PD04)	86 -	600	SD05FM	8392
XL 600 V / VN	87 -	600	SD05F	8022
XR 600 / V		600	SD05FM	8392
XR 600 R / L	01.87 -	600	SD05FM	8392
CB 650 C (RC05)		650	XD05F	8072
CB 650 SC (RC08)	01.80 -	650	XD05F	8072
CB 650 Z		650	XD05F	8072
CBX 650 E (RC13)	83 -	650	SD05FMC	30465
FMX 650	05 -	650	SD05F	8022
NX 650 (RD02)/Dominator	88 -	650	SD05F	8022
NX 650 Dominator (RD08)(I)	01.88 -	650	SD05F	8022
Transalp XL 650	94 -	650	SD05F	8022
XL 650L	94 -	650	SD05F	8022
CB 750 (RC42)	92 -	750	SD05F	8022
CB 750 (RC04)	01.82 - 12.83	750	SD05F	8022
CB 750 C (RC06)	01.80 -	750	SD05F	8022
CB 750 F	- 91	750	SD05F	8022
CB 750 F2		750	SD05F	8022
CB 750 F2N / FII	91 -	750	SD05F(IN)XD05F(OUT)	8022/8072
CB 750 FA (I)		750	SD05F	8022
CB 750 Four (I)		750	SD05F	8022
CB 750 FZ		750	SD05F	8022
CB 750 K	01.82 - 12.83	750	SD05F	8022
CB 750 KZ		750	SD05F	8022
NR 750 (RC40)	93 -	750	SD05F	8022
RVF (RC45)	94 -	750	SD05F	8022
VF 750 C	95 - 00	750	SD05F	8022
VF 750 C Magna	94 - 95	750	CR1	8035
VF 750 F (RC15)	83 - 84	750	CR1	8035
VF 750 S (RC07)	82 - 83	750	SD05F	8022
VFR 750 F	94 -	750	XD05F	8072
VFR 750 F (I)		750	XD05F	8072
VFR 750 F (RC24)	86 - 87	750	XD05F	8072
VFR 750 F (RC24)	88 - 89	750	XD05F	8072
VFR 750 F (RC36)	90 - 94	750	XD05F	8072
VFR 750 FJ (I)		750	XD05F	8072
VT 750 C (RC29)	87 -	750	XD05F/VD05F	8072/8052
VT 750 C/C2V (RC44)	97 -	750	XD05F/VD05F	8072/8052
PC 800 Pacific Coast	98 -	800	SD05F	8022
CB 900 F	01.79 -	900	SD05F(IN)XD05F(OUT)	8022/8072



ccm

Order-  
No.

					<b>HONDA</b>
CB 900 F2		01.79 - 12.83	900	SD05F(IN)XD05F(OUT)	8022/8072
CBR 900 RR (SC33)		96 -	900	XD05F	8072
CBR 900 RR (SC28)		91 -	900	XD05F	8072
CB 1000 F (SC30)		93 - 00	1000	SD05F(IN)XD05F(OUT)	8022/8072
CBR 1000 F (SC24)		95 - 00	1000	SD05F(IN)XD05F(OUT)	8022/8072
CBR 1000 F (SC21)		87 - 88	1000	SD05F(IN)XD05F(OUT)	8022/8072
CBR 1000 F (SC24)		89 - 92	1000	SD05F(IN)XD05F(OUT)	8022/8072
GL 1000 (GL1)			1000	XD05F	8072
VF 1000 F		- 86	1000	SD05FMC	30465
VF 1000 F (SC15)		87 -	1000	SD05FMC	30465
VF 1000 F2 (SC15)		85 -	1000	SD05FMC	30465
VF 1000 R (SC16)		84 - 86	1000	SD05FMC	30465
CBX 1000 (CB1)			1050	XD05F	8072
CB 1100 F (SC11)			1100	XD05F	8072
CB 1100 R (SC08)			1100	SD05F(IN)XD05F(OUT)	8022/8072
GL 1100 (SC02)		82 -	1100	XD05F	8072
GL 1100 (SC02)		- 81	1100	XD05F	8072
GL 1100 DX (SC02)		82 -	1100	XD05F	8072
GL 1100 DX (SC02)		- 81	1100	XD05F	8072
GL 1100 R			1100	XD05F	8072
VF 1100 C (SC12)		83 -	1100	SD05FMC	30465
GL 1200 (SC14)		84 - 87	1200	XD05F	8072
					<b>HUSQVARNA</b>
CR 250		01 -	250	LB05F/CR2	8051/8048
WR 250		01 -	250	LB05F/CR2	8051/8048
410 TE (2AA)		96 - 00	400	SD05FP	8325
TE 410		01 -	400	SD05FP	8325
SM 570 R		01 -	570	SD05FP	8325
TC 570		07.01 -	576	SD05FP	8325
TE 570		07.01 -	576	SD05FP	8325
610 e TE/TC		98 -	610	SD05FP	8325
SM 610 e		98 -	610	SD05FP	8325
					<b>KAWASAKI</b>
AE 50		83 -	50	LB05F	8051
AE 50		- 82	50	LB05F	8051
AR 50		93 -	50	LB05F	8051
AR 50		83 - 92	50	LB05F	8051
AR 50		- 82	50	LB05F	8051
AV 50		84 -	50	LB05F	8051
AV 50		- 83	50	LB05F	8051
KH 50			50	LB05F	8051
KMX 50 (KSR-I)		93 -	50	LB05F	8051
KX 60		- 92	60	LB05F	8051
KX 60		93 -	60	LB05F	8051
AE 80		83 -	80	LB05F	8051
AE 80		- 82	80	LB05F	8051
AN 80			80	LB05F	8051
AR 80		- 82	80	LB05F	8051
AR 80		83 -	80	LB05F	8051
DX 80			80	LB05F	8051



ccm

Order-  
No.**KAWASAKI**

KD 80		80	LB05F	8051
KDX 80		80	LB05F	8051
KH 80		80	LB05F	8051
KMX 80 (KSR-2)	93 -	80	LB05F	8051
KX 80	81 - 82	80	LB05F	8308
KX 80	- 80	80	LB05F	8308
KX 80	83 - 91	80	LB05F	8308
KX 80 (KX80S7)	97 -	80	LB05F	8308
KX 80 (KX80V7)	97 -	80	LB05F	8308
KX 80 /80-2	92 -	80	LB05F	8308
KC 90		90	LB05F	8051
KC 90 A		90	LB05F	8051
KC 90 C		90	LB05F	8051
KC 90 D		90	LB05F	8051
KE 90		90	LB05F	8051
KH 90		90	LB05F	8051
KM 90		90	LB05F	8051
KC 100	80 -	100	LB05F	8051
KD 100		100	LB05E	8031
KE 100	93 -	100	LB05F	8051
KE 100	01.76 - 12.79	100	LB05F	8051
KH 100		100	LB05F	8051
KM 100	01.79 - 12.81	100	LB05E	8031
KV 100		100	LB05E	8031
AR 125	01.82 -	125	LB05F	8051
DX 125		125	LB05F	8051
KC 125		125	LB05F	8051
KD 125		125	LB05E	8031
KDX 125 SR		125	LB05F/CR2	8051/8048
KE 125	01.76 - 12.83	125	LB05E	8031
KH 125	93 -	125	LB05F	8051
KH 125	01.77 - 12.81	125	LB05F	8051
KMX 125	01.86 -	125	LB05F	8051
KS 125	01.73 - 12.76	125	LB05E	8031
KX 125	82 - 84	125	LB05F	8051
KX 125	91 - 99	125	LB05EMH	8160
KX 125	90 - 91	125	LB05EMH	8160
KX 125	85 - 90	125	LB05F	8051
KX 125 (KX125K4)	97 -	125	LB05EMH	8160
KD 175		175	LB05F	8051
KDX 175	01.80 - 12.84	175	LB05F	8308
KE 175	81 -	175	LB05F	8051
KE 175	- 80	175	LB05F	8051
KE 175 B		175	LB05F	8051
KE 175 D		175	LB05F	8051
KDX 200	93 - 94	200	LB05F	8308
KDX 200 H	95 -	200	LB05EMH	8160
KMX 200	01.88 - 92	200	LB05F/CR2	8051/8048
Z 200	01.77 - 12.79	200	LB05F	8051
BJ 250A (Estrella)	93 - 96	250	LD05F	8060
BJ 250 C(Estrella)	97 -	250	LD05F	8060
GPZ 250 Belt Drive		250	LD05F	8060



ccm

Order-  
No.**KAWASAKI**

GPZ 250 R		250	LD05F	8060
KE 250		250	LB05E	8031
KH 250	01.73 - 12.79	250	LB05E	8031
KL 250 (A)	01.79 - 12.83	250	LB05F	8051
KL 250 (KLR 250)	01.83 - 91	250	LD05F	8060
KLX 250	01.80 - 12.84	250	LB05E	8031
KLX 250 (KLX250E)	93 -	250	XD05F	8072
KR-1R		250	LB05F	8051
KR-1S		250	LB05F	8051
KT 250		250	LB05E	8031
KX 250	- 91	250	LB05F	8051
LTD 250 Belt Drive		250	LD05F	8060
LX 250		250	LB05F	8051
Z 250		250	LB05F	8051
Z 250 A	01.80 -	250	LD05F	8060
Z 250 B		250	LD05F	8060
Z 250 Belt Drive		250	LD05F	8060
Z 250 C	01.80 -	250	LB05F	8051
Z 250 D		250	LB05F	8051
Z 250 G		250	LB05F	8051
Z 250 J		250	LD05F	8060
Z 250 LTD	01.81 -	250	LB05F	8051
Z 250 T		250	LD05F	8060
ZR 250 (Balius)	93 -	250	SD05F	8022
MULE 500/ KAF 300 A&B (UV)	92 - 96	300	LB05F	8051
GPZ 305 Belt Drive	01.83 -	305	LD05F	8060
Z 305		305	LD05F	8060
EN 400 A		400	XD05F	8072
GPZ 400		400	XD05F	8072
GPZ 400 F		400	XD05F	8072
GPZ 400 F II		400	XD05F	8072
KH 400		400	LB05E	8031
KLE 400	93 -	400	XD05F	8072
KX 400		400	LBER	8308
LTD 400		400	LD05F	8060
Z 400	01.76 - 12.81	400	LB05F	8051
Z 400 A/B/C/D/G/H		400	LB05F	8051
Z 400 F		400	LD05F	8060
Z 400 F	83 -	400	LD05F	8060
Z 400 F-II		400	LD05F	8060
Z 400 J		400	LD05F	8060
Z 400 J (I)		400	LD05F	8060
Z 400 K		400	LD05F	8060
Z 400 LTD		400	LB05F	8051
Z 400 M		400	LD05F	8060
ZL 400 (Eliminator 400SE)	93 -	400	LD05F	8060
ZR 400	84 -	400	LD05F	8060
ZR 400	- 83	400	LD05F	8060
ZR 400-C (Zephyr 400)	93 -	400	LD05F	8060
ZR 400-D (Xanthus)	93 -	400	LD05F	8060
ZX 400 (Z 400-F2)	93 -	400	LD05F	8060
Z 440	01.80 - 12.85	440	LB05F	8051



ccm

Order-  
No.**KAWASAKI**

Z 440 H (I)		440	LB05F	8051
EN 450 A (I)		450	XD05F	8072
LTD 450	01.85 -	450	LD05F	8060
EN 500	90 -	500	XD05F	8072
EX 500 (GPZ 500S EN 500)	93 -	500	XB05F	8062
KH 500		500	LB05E	8031
KX 500	93 -	500	LBER	8308
Z 500		500	LD05F	8060
ZR 500		500	LD05F	8060
GPZ 550		550	LD05F	8060
GPZ 550 Unitrack (I)		550	LD05F	8060
LTD 550	01.80 - 12.85	550	LD05F	8060
Z 550		550	LD05F	8060
ZR 550 B Zephyr	91 -	550	LD05F	8060
ZX 550 A1		550	LD05F	8060
ZL 600	01.86 -	600	XD05F	8072
ZL 600 (ZL600B/B1)	95 -	600	XD05F	8072
ZX 600 A (I)		600	LD05F	8060
KLR 650	09.86 - 94	650	XD05F	8072
KLR 650 (KL650C1/C3)	95 -	650	XD05F	8072
KLX 650 (KLX650C)	93 -	650	SD05FM	8392
KLX 650 R	98 -	650	SD05FM	8392
KLX 650 R (KLX650A)	93 - 96	650	SD05FM	8392
Z 650		650	LB05F	8051
Z 650 F-B		650	LB05F	8051
LTD 700		700	LB05F	8051
750 Turbo	01.73 - 12.86	750	LB05F	8051
GPX 750 R	01.87 -	750	SD05F	8022
GPX 750 R (I)		750	SD05F	8022
GPZ 750	01.82 -	750	LB05F	8051
GPZ 750 R	01.85 -	750	SD05F	8022
LTD 750 4 Cyl.	01.82 - 12.87	750	LB05F	8051
VN 750 Twin		750	XD05F(IN)LD05F(OUT)	8072/8060
VN 750 Vulcan		750	XD05F(IN)LD05F(OUT)	8072/8060
Z 2		750	XD05F(IN)LD05F(OUT)	8072/8060
Z 750		750	LB05F	8051
ZR 750 C Zephyr	91 - 00	750	LD05FP	8070
ZR 750 D1/2 Zephyr	96 - 00	750	LD05FP	8070
ZX 750 J		750	LB05FP	8030
ZXR 750	09.88 -	750	XD05F	8072
ZXR 750 R	90 -	750	XD05F	8072
ZXR 750 R (ZX750L/M)	93 -	750	XD05F	8072
GPZ 900 R		900	XD05F(IN)LD05F(OUT)	8072/8060
GPZ 900 R (I)		900	XD05F(IN)LD05F(OUT)	8072/8060
Z 1		900	SB05F(IN)YB05F(OUT)	8080/8082
Z 900	01.73 - 12.76	900	SB05F(IN)YB05F(OUT)	8080/8082
KZ 1000 Police	93 -	1000	XB05F(IN)LB05FP(OUT)	8062/8030
Z 1000	- 80	1000	LB05F	8051
Z 1000	81 -	1000	LB05F	8051
Z 1000 ES (I)		1000	LB05F	8051
Z 1000 J (I)		1000	LB05F	8051
ZL 1000	09.86 -	1000	SD05FM	8392



ccm

Order-  
No.**KAWASAKI**

ZX 10	87 - 90	1000	SD05FM	8392
GPZ 1100		1100	XB05F(IN)YB05F(OUT)	8062/8082
GPZ 1100 (ZX1100E1E1H)	95 -	1100	XB05F(IN)YB05F(OUT)	8062/8082
GPZ 1100 ABS (ZX1100F1)	97 -	1100	XB05F(IN)YB05F(OUT)	8062/8082
Z 1100		1100	XB05F(IN)YB05F(OUT)	8062/8082
Zephyr 1100 (ZR1100A)		1100	SD05FM	8392
ZRX 1100 (ZR1100C1)(ZRT10C)	97 - 00	1100	SD05FM	8392
Zephyr (ZR 1100 B1)	96 -	1100	SD05FM	8392
VN-15 A/B (VN-1500/SE/C/D2)		1500	XD05F(IN)LD05FP(OUT)	8072/8070

**KTM**

50 GP	10.81 -	50	LB05F	8051
50 GXE		50	LB05F	8051
50 SX Pro Junior LC Beta Engine	03 -	50	LB05EMH	8160
50 ME	10.81 -	50	LB05F	8051
50 MLS		50	LB05F	8051
50 MMS		50	LB05F	8051
50 MS	10.81 -	50	LB05F	8051
50 RSL		50	LB05F	8051
50 SX Pro Senior LC	03 -	50	LB05EMH	8160
50 Senior	03 -	50	LB05EMH	8160
Bora 25	10.81 -	50	LB05F	8051
Bora 50		50	LB05F	8051
Comet	09.76 -	50	LB05F	8051
Crazy (CH)		50	LB05F	8051
Foxi		50	LB05F	8051
Foxi (DK)		50	LB05F	8051
Hobby	10.81 -	50	LB05F	8051
Pony	10.81 -	50	LB05F	8051
Pony (CH)	10.81 -	50	LB05F	8051
Postmofa		50	LB05F	8051
SM 25		50	LB05F	8051
Squadra		50	LB05F	8051
60 SX	98 -	60	LB05EMH	8338
65 SX Beta Engine	03 -	65	LB05EMH	8160
65 SX	98 - 00	65	LB05EMH	8338
80 Chopper		80	LB05F	8051
80 Enduro		80	LB05F	8051
80 PL	06.83 - 12.84	80	LB05F	8051
80 RL	10.81 -	80	LB05F	8051
80 RLS	10.81 -	80	LB05F	8051
80 RLW	10.81 -	80	LB05F	8051
80 RS	10.81 -	80	LB05F	8051
Bora 80	10.81 -	80	LB05F	8051
85 SX	04 -	85	TB05EMA	8636
GS 100	08.73 - 08.76	100	LB05F	8051
MC 100	08.73 - 08.76	100	LB05F	8051
105 SX	04 -	105	TB05EMA	8636
125 EGS	98 -	125	LB05EMH	8160
125 EGS	99 -	125	LB05EMH	8160
125 Enduro		125	LB05F	8051
125 EXC	96 - 08.97	125	LB05EMH	8160



ccm

Order-  
No.**KTM**

125 EXC	98 - 99	125	LB05EMH	8160
125 EXC	93 - 95	125	LB05EMH	8160
125 EXC	08.97 - 98	125	LB05EMH	8160
125 EXC	01 -	125	LB05EMH	8160
125 EXC	99 - 00	125	LB05EMH	8160
125 EXE	99 -	125	LB05EMH	8160
125 LC 2 (Langgewinde)	96 - 00	125	LB05EMH	8160
125 Sting	98 -	125	LB05EMH	8160
125 Supermoto	99 -	125	LB05EMH	8160
125 SX (98er)	08.97 - 98	125	LB05EMH	8160
125 SX	02 -	125	LB05EMH	8160
125 SX	99 - 00	125	LB05EMH	8160
125 SX	96 - 08.97	125	LB05EMH	8160
GS 125 12,7 mm		125	LB05F	8051
MC 125 12,7 mm		125	LB05F	8051
MC 125 19,0 mm		125	LB05F	8051
MC 125 GP		125	LB05F	8051
GS 175		175	LB05F	8051
MC 175		175	LB05F	8051
200 EGS	99 -	200	LB05EMH	8160
200 EGS	98 -	200	LB05EMH	8160
200 EXC	99 - 01	200	LB05EMH	8160
200 EXC	02 -	200	LB05EMH	8160
200 EXC	98 - 99	200	LB05EMH	8160
200 MXC	99 -	200	LB05EMH	8160
200 SX	03 -	200	LB05EMH	8160
250 DXC		250	LB05EMH	8160
250 EGS	97 -	250	LB05EMH	8160
250 EGS	98 -	250	LB05EMH	8160
250 EGS	99 -	250	LB05EMH	8160
250 EGS	93 - 95	250	LB05EMH	8160
250 Enduro		250	LB05EMH	8160
250 EXC Racing	03 -	250	VD05EG	
250 EXC	93 - 95	250	LB05EMH	8160
250 EXC Enduro Competition	03 -	250	LB05EMH	8160
250 EXC Racing GS	03 -	250	VD05EG	
250 EXC	97 - 98	250	LB05EMH	8160
250 EXC	96 - 96	250	LB05EMH	8160
250 EXC / Sixt Days	98 - 01	250	LB05EMH	8160
250 MX		250	LB05EMH	8160
250 SX	99 -	250	LB05EMH	8160
250 SX	98 - 99	250	LB05EMH	8160
250 SX	93 - 95	250	LB05EMH	8160
250 SX	96 -	250	LB05EMH	8160
250 SX 4Takt	05 -	250	VD05EG	
250 SX	97 - 98	250	LB05EMH	8160
250 SXC	99 -	250	LB05EMH	8160
250 SXF	05 -	250	VD05EG	
GS 250 12,7 mm		250	LB05F	8051
MC 250 12,7 mm		250	LB05F	8051
MC 250 19,0 mm		250	LB05F	8051
MC 250 GP 12,7 mm		250	LB05F	8051



ccm

Order-  
No.**KTM**

MC 250 GP 19,0 mm		250	LB05F	8051
300 EGS	99 -	300	LB05EMH	8160
300 EXC Enduro Competition	03 -	300	LB05EMH	8160
300 EXC / Sixt Days	99 -	300	LB05EMH	8160
300 EXC	97 - 98	300	LB05EMH	8160
300 MXC	03 -	300	LB05EMH	8160
300 SX	99 -	300	LB05EMH	8160
360 EXC	97 -	360	LB05EMH	8160
360 MXC	97 -	360	LB05EMH	8160
360 SX	97 -	360	LB05EMH	8160
360 SX	96 -	360	LB05EMH	8160
380 Enduro	98 -	380	LB05EMH	8160
380 EGS	98 -	380	LB05EMH	8160
380 EGS	99 -	380	LB05EMH	8160
380 EXC	98 -	380	LB05EMH	8160
380 SX	99 -	380	LB05EMH	8160
400 Enduro-E	98 -	400	SD05F	8022
400 EGS	97 -	400	SD05F	8022
400 EGS-E	97 -	400	SD05F	8022
400 EXC Racing	99 - 04.02	400	VD05F	8025
400 EXC Racing	03 -	400	VD05EG	
400 LC4-E	99 - 04.02	400	SD05F	8022
400 LC4	99 - 04.02	400	SD05F	8022
400 LS-E	97 - 04.02	400	SD05F	8022
400 SC	98 -	400	SD05F	8022
400 SC	96 -	400	SD05F	8022
400 SX	98 - 04.02	400	SD05F	8022
400 SX Racing / Six Days	99 - 04.02	400	VD05F	8025
400 SXC	98 - 04.02	400	SD05F	8022
400 SXC	99 - 04.02	400	SD05F	8022
400 SXC 20kW	99 - 04.02	400	SD05F	8022
GS 400		400	LB05F	8051
LC4- E 400 Enduro	01 -	400	SD05F	8022
LC4 400	98 -	400	SD05F	8022
LC4 400 EGS	93 -	400	SD05F	8022
LC4 400 EXC	93 -	400	SD05F	8022
LC4 Competition	98 -	400	SD05F	8022
MC 400		400	LB05F	8051
MC 400 GP		400	LB05F	8051
450 EXC Racing	03 -	450	VD05EG	
450 EXC Racing GS	03 -	450	VD05EG	
450 MXC GS	03 -	450	VD05EG	
450 MXC Dessert	03 -	450	VD05EG	
450 SMR	05 -	450	VD05EG	
450 SX Racing	03 -	450	VD05EG	
GS 500 2Stroke		500	LB05F	8051
GS 500 4Stroke		500	LD05F	8060
MC 500 2Stroke		500	LB05F	8051
MC 500 4Stroke		500	LD05F	8060
520 EXC Racing / Six Days	99 - 04.02	520	VD05F	8025
520 SX Racing	99 - 04.02	520	VD05F	8025
525 EXC Racing	03 -	525	VD05EG	





ccm

Order-  
No.**KTM**

525 EXC Racing GS	03 -	525	VD05EG	
525 MXC	03 -	525	VD05EG	
525 MXC Desert Racing	05 -	525	VD05EG	
525 SMR	05 -	525	VD05EG	
525 SX Racing	03 -	525	VD05EG	
540 SXC	98 -	540	SD05F	8022
540 SXC	99 -	540	SD05F	8022
540 SXC 20kW	99 -	540	SD05F	8022
540 SXS Racing	02 -	540	VD05F	8025
600 Country		600	LD05F	8060
600 Enduro		600	LD05F	8060
600 MX		600	LD05F	8060
LC4 Enduro 17kW	- 87	600	LD05F	8060
LC4 Enduro 36kW	- 87	600	LD05F	8060
LC4 600 EGS	93 -	600	LD05F	8060
LC4 600 EXC	93 -	600	LD05F	8060
620 Duke	94 -	609	LD05F	8060
LC4 620 SC Supermoto	01 - 04.02	609	SD05F	8022
LC4 620 Supercompetition	01 - 04.02	609	SD05F	8022
LC4 612 EXC	93 -	612	LD05F	8060
LC4 612 EGS	93 -	612	LD05F	8060
620 Duke-E	97 -	620	SD05F	8022
620 EGS	97 -	620	SD05F	8022
620 EGS-E	97 -	620	SD05F	8022
620 LS4 Rally	97 -	620	SD05F	8022
620 LS-E	97 -	620	SD05F	8022
620 SC	98 -	620	SD05F	8022
620 SC	96 -	620	SD05F	8022
620 Supercompetition	97 - 04.02	620	SD05F	8022
620 SX	99 -	620	SD05F	8022
620 SX	96 -	620	SD05F	8022
LC4 620 SX	94 -	620	SD05F	8022
LC4 620 EXC	94 -	620	SD05F	8022
LC4 620 EGS	94 -	620	SD05F	8022
LC4 Super Competition	00 - 04.02	620	SD05F	8022
Supermoto Competition 620	98 - 00	620	SD05F	8022
625 SC	02 -	625	SD05F	8022
625 SMC	05 -	625	VD05EG	
625 SXC Hard Enduro	03 -	625	SD05EG	
625 SXC Super Moto	02 -	625	SD05F	8022
640 Duke	05 -	625	VD05EG	
640 Duke 2	02 - 04.02	625	SD05F	8022
640 LC4 SM	05 -	625	VD05EG	
640 Supermoto Spezial Edition	03 -	625	SD05EG	
Adventure R 640	98 - 01	625	SD05F	8022
Duke 2	00 - 04.02	625	SD05F	8022
Duke 640	98 - 01	625	SD05F	8022
Duke II	99 - 01	625	SD05F	8022
LC4- 640 Adventure	01 - 04.02	625	SD05F	8022
640 LC4-E SM Prestige	02 - 04.02	625	SD05F	8022
640 LC4-E Six Days	02 - 04.02	625	SD05F	8022
640 LC4 Super Moto	02 - 04.02	625	SD05F	8022



ccm

Order-  
No.

<b>KTM</b>				
640 LC4	02 - 04.02	625	SD05F	8022
640 LC4	99 - 01	625	SD05F	8022
LC4-640 Hard Enduro	03 -	625	SD05EG	
LC4 640	98 - 00	625	SD05F	8022
LC4- E	00 - 00	625	SD05F	8022
LC4 640 Duke II	03 -	625	SD05EG	
LC4- E 640 Enduro	01 - 01	625	SD05F	8022
640 LC4 Adventure	02 - 04.02	625	SD05F	8022
LC4- E Supermoto	00 - 00	625	SD05F	8022
LC4 Adventure	00 - 00	625	SD05F	8022
LC4- E 640 Supermoto	01 - 01	625	SD05F	8022
660 Rallye	02 - 04.02	650	SD05F	8022
660 Super Moto Factory Replica	02 -	650	SD05F	8022
660 LC4 Rallye	99 - 01	650	SD05F	8022
Rallye	00 - 01	650	SD05F	8022
660 SMC	05 -	660	VD05EG	
<b>MAICO</b>				
GS 125		125	LBER	8308
MC 125		125	LBER	8308
SG 125		125	LBER	8308
250	94 -	250	LBER	8308
GM Star 250		250	LBER	8308
GM Star E 250		250	LBER	8308
GS 250		250	LBER	8308
GSE 250	- 05.83	250	LBER	8308
MC 250		250	LBER	8308
320	94 -	320	LBER	8308
GS 400	01.74 - 05.83	400	LBER	8308
MC 400		400	LBER	8308
440	94 -	440	LBER	8308
GSE 490	- 05.83	490	LBER	8308
MC 490	- 05.83	490	LBER	8308
500	94 -	500	LBER	8308
GS 500		500	LBER	8308
GS Star 500		500	LBER	8308
GS Star E 500		500	LBER	8308
MC 500		500	LBER	8308
685 Gespann	94 -	685	LBER	8308
<b>MBK</b>				
41		49	LB05F	8051
50 EV		49	LB05F	8051
50 EW		49	LB05F	8051
50 L		49	LB05F	8051
50 S		49	LB05F	8051
50 VL		49	LB05F	8051
50 VS		49	LB05F	8051
51 New West		49	LB05F	8051
51 S		49	LB05F	8051
51 SL		49	LB05F	8051
51 Super		49	LB05F	8051



ccm

Order-  
No.**MBK**

51 Super Special	49	LB05F	8051
51 V	49	LB05F	8051
51 VL	49	LB05F	8051
88	49	LB05F	8051
88 IP	49	LB05F	8051
88 IU	49	LB05F	8051
89	49	LB05F	8051
Active	49	LB05F	8051
AV 40	49	LB05F	8051
AV 42	49	LB05F	8051
AV 44	49	LB05F	8051
AV 46	49	LB05F	8051
AV 48	49	LB05F	8051
AV 56	49	LB05F	8051
AV 59	49	LB05F	8051
AV 65	49	LB05F	8051
AV 68	49	LB05F	8051
AV 76	49	LB05F	8051
AV 79	49	LB05F	8051
AV 85	49	LB05F	8051
AV 88	49	LB05F	8051
AV 89	49	LB05F	8051
AV 92	49	LB05F	8051
AV 98	49	LB05F	8051
Cady	49	LB05F	8051
CF	49	LB05F	8051
Champ	49	LB05F	8051
Daytona Beach	49	LB05F	8051
Daytona Cruiser	49	LB05F	8051
FXK	49	LB05F	8051
G 40	49	LB05F	8051
G 50	49	LB05F	8051
Hobby IV	49	LB05F	8051
KW Magnum	49	LB05F	8051
M 1	49	LB05F	8051
M 1L	49	LB05F	8051
M 1P	49	LB05F	8051
M 1PR	49	LB05F	8051
M 1PRT	49	LB05F	8051
M 1PRTS	49	LB05F	8051
Mobylett	49	LB05F	8051
N 40	49	LB05F	8051
N 50	49	LB05F	8051
Rock	49	LB05F	8051
SP 50	49	LB05F	8051
SP 92	49	LB05F	8051
SP 93	49	LB05F	8051
SP 94	49	LB05F	8051
SP 98	49	LB05F	8051
SP 99	49	LB05F	8051
Weeky	49	LB05F	8051
X 1	49	LB05F	8051



ccm

Order-  
No.**MBK**

X 1L		49	LB05F	8051
X 7L		49	LB05F	8051
X 7S		49	LB05F	8051
X 7VL		49	LB05F	8051
X 7VS		49	LB05F	8051
ZX		49	LB05F	8051
151 L	01.79 - 07.83	50	LB05F	8051
151 LB	01.79 - 07.83	50	LB05F	8051
151 LC	01.79 - 07.83	50	LB05F	8051
50 R		50	LB05F	8051
50 VL	01.71 - 12.80	50	LB05F	8051
50 VLC	01.71 - 12.80	50	LB05F	8051
51 SU	01.81 - 07.83	50	LB05F	8051
89	- 07.83	50	LB05F	8051
93		50	LB05F	8051
98	- 07.83	50	LB05F	8051
99		50	LB05F	8051
D50		50	LB05F	8051
Monty MB3V	01.77 - 07.83	50	LB05F	8051
Monty SP3V	- 11.81	50	LB05F	8051
Monty SP3V	12.81 -	50	LB05F	8051
SP 94 TT		50	LB05F	8051
D75		75	LB05F	8051
125 12,7 mm		125	LB05F	8051
125 19,0 mm		125	LB05F	8051
250		250	LB05F	8051
350	04.73 - 04.79	350	LB05F	8051
350 E		350	LB05F	8051
350 Injection		350	LB05F	8051

**MONTESA**

Brio,Cirlo,Fura,Mini Cota		50	LB05F	8051
Cota 25A/25C/49,Mini Mont.		50	LB05F	8051
Scorpion 50R		50	LB05F	8051
Cota 74 /74T /80		75	LB05F	8051
Crono 75		75	LB05F	8051
Enduro 75 H6 /H7/ L		75	LB05F	8051
Cota 123/C/T, Cota 125		123	LB05F	8051
Cota 172/200		175	LB05F	8051
Cota 348,Trial		310	LB05F	8051
315R	97 -	315	LB05F	8051
Cota 330,Trial		330	LB05F	8051
Cota 335/335E/349/349T/350		350	LB05F	8051
Crono 350		350	LB05F	8051
Enduro 360 H6/H7/H7S/L		350	LB05F	8051

**MOTO GUZZI**

250 FD	74 - 76	250	LD05F	8060
250 TS	01.74 - 07.80	250	LB05F	8051
V 35 II	12.80 - 01.87	350	LB05F	8051
V 35 III	07.85 -	350	LB05F	8051
V 35 Imola	11.79 - 01.87	350	LB05F	8051



ccm

Order-  
No.**MOTO GUZZI**

V 35 Imola II	79 - 86	350	LB05F	8051
V 65 NTX	90 - 92	650	LB05F	8051
V 65 Polizia NT		650	LB05F	8051
V 65 SP	- 86	650	LB05F	8051
850 California	12.75 - 12.81	850	LB05F	8051
850 Le Mans II / III	01.78 - 12.81	850	LB05F	8051
850 T4	07.80 - 12.83	850	LB05F	8051
850 T5	06.83 - 12.87	850	LB05F	8051
850 TS 5	82 - 84	850	LB05F	8051
1000 SP III	88 - 92	1000	LB05F	8051

**MOTOR HISPANIA**

Minicross		50	LB05F	8051
Style		50	LB05F	8051

**MZ**

Saxon Roadstar 7kW		125	LB05F	8051
Saxon Sportstar 7/11kW		125	LB05F	8051
Saxon Roadstar 9kW		150	LB05F	8051
Saxon Sportstar 9kW		150	LB05F	8051
ETZ Classic 13/15kW		251	LB05F	8051
Saxon 251 Fun 13/15kW		251	LB05F	8051
Saxon 251 Tour 13/15kW		251	LB05F	8051
ETZ 301 Classic 17kW		301	LB05F	8051
Saxon 301 Fun 17kW		301	LB05F	8051
Saxon 301 Tour 17kW		301	LB05F	8051

**MZ (TR)**

TS 125	01.75 - 12.85	125	LB05F	8051
--------	---------------	-----	-------	------

**PEUGEOT**

101	04.75 -	50	LB05F	8051
102	04.75 -	50	LB05F	8051
103	04.75 -	50	LB05F	8051
103 CRX		50	LB05F	8051
103 LC		50	LB05F	8051
103 LSM-D	06.82 -	50	LB05F	8051
103 MP/MR		50	LB05F	8051
103 Racen		50	LB05F	8051
103 SP	86 -	50	LB05F	8051
103 SPM-D	04.75 -	50	LB05F	8051
103 T16		50	LB05F	8051
103 TXLC, TXR		50	LB05F	8051
103 Vogue		50	LB05F	8051
103 XP, XPLC	01.86 -	50	LB05F	8051
104		50	LB05F	8051
105		50	LB05F	8051
SC80L	06.82 -	80	LB05F	8051
SX8T	02.78 - 12.82	80	LB05F	8051

**PUCH**

Cobra 12,9 mm	81 -	80	LB05F	8051
---------------	------	----	-------	------



ccm

Order-  
No.

<b>PUCH</b>				
Cobra 19,0 mm	81 -	80	LB05F	8051
<b>RIEJU</b>				
RR 50 AM6		50	LB05F	8051
RS 1		50	LB05F	8051
<b>SACHS</b>				
RS 125	97 -	125	LB05F	8051
ZX 125	97 -	125	LB05F	8051
<b>SUZUKI</b>				
A 50 K		50	LB05F	8051
A 50 P		50	LB05F	8051
AE 50	93 -	50	LB05F	8051
AJ 50	95 -	50	LB05F	8051
AJ 50 ZZ	95 -	50	LB05F	8051
AP 50 (CA1JA)	95 -	50	LB05F	8051
CL 50 DO		50	LB05F	8051
CP 50 (CA14C/E)		50	LB05F	8051
CP 50 H-J,L/M/N		50	LB05F	8051
CS 50		50	LB05F	8051
CX 50		50	LB05F	8051
CY 50		50	LB05F	8051
DM 50		50	LB05F	8051
DR Big 50	89 -	50	LB05F	8051
DV 50		50	LB05F	8051
FA 50		50	LB05F	8051
FR 50		50	LB05F	8051
FS 50		50	LB05F	8051
FZ 50		50	LB05F	8051
GT 50		50	LB05F	8051
JR 50	93 - 94	50	LB10EH	31110
JR 50	95 -	50	LB10EH	31110
K 50		50	LB05F	8051
Katana AY50 aircooled	97 -	50	LB05F	8051
Katana AY50 water (Spain)	97 -	50	LB05F	8051
Katana AY50 watercooled	97 -	50	LB05F	8051
Maxi 50		50	LB05F	8051
OR 50		50	LB05F	8051
RB 50 GAG	88 - 88	50	LD05F	8060
RG 50 KE		50	LB05F	8051
RG 50 W		50	LB05F	8051
RM 50	- 89	50	LB05F	8051
RM 50	90 -	50	LB05F	8051
RV 50		50	LB05F	8051
Suzy	95 -	50	LB05F	8051
TR 50		50	LB05F	8051
TR 50 S Magic	98 -	50	LB05F	8051
TS 50 12,7mm		50	LB05F	8051
TS 50 19,0mm		50	LB05F	8051
TS 50 ER		50	LB05F	8051
TS 50 XK (SA11C)		50	LB05F	8051



ccm

Order-  
No.**SUZUKI**

ZR 50		50	LB05F	8051
CS 80		80	LB05F	8051
DS 80	93 - 94	80	LB05F	8051
DS 80	95 -	80	LB05F	8051
FR 80		80	LB05F	8051
GT 80 EX/LX		80	LB05F	8051
RG 80 G (D) (NC11A)		80	LB05F	8051
RG 80 Gamma		80	LB05F	8051
RG 80 WF		80	LB05F	8051
RM 80	93 -	80	LB05F	8051
RM 80 H		80	LB05F	8051
RM 80 X	91 -	80	LB05F	8051
RM 80 X	- 90	80	LB05F	8051
TS 80 ERX		80	LB05F	8051
TS 80 X (SA11A)		80	LB05F	8051
TS 80 XE-H		80	LB05F	8051
FM 90		90	LB05F	8051
RV 90		90	LB05F	8051
A 100	95 -	100	LB05F	8051
FB 100 / D	95 -	100	LD05F	8060
GP 100		100	LB05F	8051
TS 100 X	- 77	100	LB05F	8051
TS 100 X	78 -	100	LB05F	8051
CS 125		125	LD05F	8060
DR 125 S/L-N	91 -	125	LD05F	8060
DR 125 SE (SF44A)	95 -	125	LD05F	8060
DR 125 SJ (SF43B)		125	LD05F	8060
GN 125	91 -	125	LD05F	8060
GN 125 V (NF41A)	97 -	125	LD05F	8060
GP 125		125	LB05F	8051
GS 125 S	99 -	125	LD05F	8060
GS 125 S		125	LD05F	8060
GT 125,-E		125	LB05F	8051
RG 125	01.85 -	125	LB05F	8051
RM 125	93 - 95	125	LB05F/CR2	8051/8048
RM 125	- 86	125	LB05F/CR2	8051/8048
RM 125	87 - 92	125	LB05F/CR2	8051/8048
RM 125	96 - 97	125	LB05F/CR2	8051/8048
RC 125		125	LB05F	8051
TS 125 X		125	LB05F	8051
TS 125 ER T, X	80 - 83	125	LB05F	8051
TS 125 ER N	79 - 79	125	LB05F	8051
TS 125 C,C2	01.78 - 78	125	LB05F	8051
TS 125 A / B	76 - 12.77	125	LB05F	8051
TS 125 K, L, M	73 - 75	125	LB05F	8051
TS 125 N	79 - 79	125	LB05F	8051
TS 125 R		125	LB05F/CR2	8051/8048
TS 125 X E	84 -	125	LB05F	8051
GT 185		185	LB05F	8051
TS 185 ER	93 -	185	LB05F	8051
DR 200 SZ	95 -	200	LD05F	8060
GT 200		200	LB05F	8051



ccm

Order-  
No.**SUZUKI**

TS 200		200	LB05F/CR2	8051/8048
DR 250	91 -	250	LD05F	8060
DR 250 S	90 -	250	XD05F	8072
DR 250 S (SJ42A)		250	XD05F	8072
DR 250 SZ	95 -	250	XD05F	8072
DR 250 SZ-H		250	XD05F	8072
GSX 250 L		250	SD05F	8022
DR 400 S	01.80 - 12.83	400	LD05F	8060
GN 400 TD-X		400	LD05F	8060
GS 400 TX		400	VB05F	8032
GSF 400 (BANDIT GK75B)	- 92	400	SD05F	8022
GSF 400 (BANDIT GK75B)	92 -	400	SD05F	8022
GSX 400 E (GS40X)	01.83 -	400	VB05F	8032
GSX 400 FW		400	SD05F	8022
GSX 400 FX		400	SD05F	8022
GSX 400 LX		400	SD05F	8022
GSX 400 S		400	SD05F	8022
GSX 400 SE/EF (GK53C)		400	SD05F	8022
GSX-R400		400	SD05F	8022
GSX-R400	93 -	400	SD05F	8022
GS 450 E/ES (GS450)		450	VB05F	8032
GS 450 L (GL51D)		450	VB05F	8032
GS 450 SF		450	VB05F	8032
GS 450 TX		450	VB05F	8032
GS 500 E	- 00	500	XB05F(IN)VB05F(OUT)	8062/8032
GS 500 E (GM51B)	93 - 00	500	XD05F(IN)VD05F(OUT)	8072/8052
GSX 550 EF (I)		550	SD05F	8022
GT 550	01.73 - 12.77	550	LB05F	8051
DR 600		600	LD05F	8060
DR 600 R Djebel (I)		600	LD05F	8060
DR 600 S (SN41A)		600	LD05F	8060
GR 650 D/XD/XF (GP51A)		650	LD05F	8060
GS 750 D/E/L		750	XB05F(IN)VB05F(OUT)	8062/8032
GSX 750 E		750	SD05F	8022
GSX 750 E (I)		750	SD05F	8022
GSX 750 EF	- 85	750	SD05F	8022
GSX 750 ES (I)		750	SD05F	8022
GSX 750 S		750	SD05F	8022
GSX 750 S Katana (I)		750	SD05F	8022
GSX R 750 (GR75A)	- 87	750	XD05F	8072
GSX R 750 (GR77B)	88 -	750	XD05F	8072
GSX-R 750 (GR7AB)	91 -	750	XD05F	8072
VS 750 GL/H/J-K		750	SD05F	8022
GS 850 G (GS72A)		850	XB05F(IN)VB05F(OUT)	8062/8032
GS 850 GL		850	XB05F(IN)VB05F(OUT)	8062/8032
GS 1000 D/E/H/S-1980/GL/GX		1000	XB05F(IN)VB05F(OUT)	8062/8032
GSX 1100 EFE (I)		1100	SD05F	8022
GSX 1100 EFG/ESG/EG(GV71C)		1100	SD05F	8022
GSX 1100 EZ/ESD (GU71B)		1100	SD05F	8022
GSX 1100 S/SZ Kata.(GS110XS)		1100	SD05F	8022
GSX 1150 E	- 85	1150	SD05F	8022
GSX 1150 E	86 -	1150	SD05F	8022





ccm

Order-  
No.**SUZUKI**

GSX 1150 EF		1150	SD05F	8022
GSX 1150 ES		1150	SD05F	8022

**YAMAHA**

Golf Car G2A/G9A	92 -		LB05F	8051
CA 50 (14T)	83 - 87	50	LB05F	8051
CE 50 E		50	LB05F	8051
CH 50		50	LB05F	8051
CR 50 Z/SS	93 -	50	LB05F	8051
CV 50		50	LB05F	8051
CW 50	91 - 93	50	LB05F	8051
CW 50 (4BX)	94 -	50	LB05F	8051
CY 50	94 -	50	LB05F	8051
CY 50 E	93 -	50	LB05F	8051
CY 50 F	94 -	50	LB05F	8051
DT 50		50	LB05F	8051
DT 50 A (F)		50	LB05F	8051
DT 50 E	93 -	50	LB05F	8051
DT 50 F	94 -	50	LB05F	8051
DT 50 M (2M4)	78 - 81	50	LB05F	8051
DT 50 M (A) (B)	86 -	50	LB05F	8051
DT 50 M (NL)	86 -	50	LB05F	8051
DT 50 M (D)	86 -	50	LB05F	8051
DT 50 M (S)	86 -	50	LB05F	8051
DT 50 MX (1NN)	01.86 - 12.89	50	LB05F	8051
DT 50 R (3MN2)(3MN3)(3HL3)(4CT2)(4CT4)(4CT6)	91 -	50	LB05F	8051
ES 50		50	LB05F	8051
Fizz (4RC)	95 -	50	LB05F	8051
FS 1 DX (3F2)	79 - 80	50	LB05F	8051
FS 1 E		50	LB05F	8051
FS 3 M		50	LB05F	8051
GT 50 B		50	LB05F	8051
GT 50 D (FT1)	73 - 75	50	LB05F	8051
Jog 50	90 -	50	LB05F	8051
LB 2		50	LB05F	8051
LB 2 80	81 -	50	LB05F	8051
LB 2 80	- 80	50	LB05F	8051
LB 2 M	81 -	50	LB05F	8051
LB 2 M (551)	75 - 80	50	LB05F	8051
LB 3 80		50	LB05F	8051
LB 3 M		50	LB05F	8051
LC 50		50	LB05F	8051
LC 50 H		50	LB05F	8051
LC 50 M		50	LB05F	8051
MA 50		50	LB05F	8051
MA 50 M		50	LB05F	8051
MBK Magnum	90 -	50	LB05F	8051
MR 50		50	LB05F	8051
MR 50 H		50	LB05F	8051
PW 50 (3PT)	01.87 -	50	LB05F	8051
PW 50 E	93 -	50	LB05F	8051
PW 50 H / F		50	LB05F	8051



ccm

Order-  
No.**YAMAHA**

QT 50		50	LB05F	8051
QT 50 H		50	LB05F	8051
RD 50 DX (353)	73 - 75	50	LB05F	8051
RD 50 H		50	LB05F	8051
RD 50 MX (2E0)	77 - 81	50	LB05F	8051
SA 50		50	LB05F	8051
SA 50 H		50	LB05F	8051
SA 50 M		50	LB05F	8051
SG 50 (34N)	84 - 85	50	LB05F	8051
SH 50 / F		50	LB05F	8051
SH 50 E / ED / MF	93 -	50	LB05F	8051
T 50		50	LD05F	8060
TY 50 M (1G3)	77 - 80	50	LB05F	8051
V 50		50	LB05F	8051
V 50 D	93 -	50	LB05F	8051
V 50 E		50	LB05F	8051
V 50 M	84 -	50	LB05F	8051
V 50 M	81 - 83	50	LB05F	8051
V 50 M	- 80	50	LB05F	8051
YA 50 (5AK)	97 -	50	LB05F	8051
YB 50 S		50	LB05F	8051
YE 50	93 -	50	LB05F	8051
YZ 50		50	LB05F	8051
YZ 50 H		50	LB05F	8051
RD 60 B		60	LB05F	8051
YB 60		60	LB05F	8051
YZ 60 H		60	LB05F	8051
CW 65	94 -	65	LB05F	8051
Active 80	90 -	80	LB05F	8051
CH 80		80	LB05F	8051
CV 80		80	LB05F	8051
DT 80 LC-I (37A)	83 - 86	80	LB05F	8051
DT 80 LC-II (53V)	84 -	80	LB05F	8051
DT 80 MX (5J1)	81 - 84	80	LB05F	8051
DT 80 MX-S (5T8)	83 - 86	80	LB05F	8051
FS 80		80	LB05F	8051
FS 80 SE (5A7)	81 - 82	80	LB05F	8051
GT 80 (477)	74 - 75	80	LB05F	8051
GT 80 D		80	LB05F	8051
GT 80 E		80	LB05F	8051
LB 80		80	LB05F	8051
LB 80 2A		80	LB05F	8051
LB 80 2AC		80	LB05F	8051
LB 80 2AD		80	LB05F	8051
LB 80 2H		80	LB05F	8051
LB 80 2HD		80	LB05F	8051
LB 80 3 (1M9)	78 - 79	80	LB05F	8051
LB 80 3D		80	LB05F	8051
MX 80		80	LB05F	8051
MX 80 H		80	LB05F	8051
PW 80 (21W)	83 - 90	80	LB05F	8051
PW 80 E / F (4BC..)	93 -	80	LB05F	8051



ccm

Order-  
No.**YAMAHA**

RD 80 LC-II (30W)	83 - 87	80	LB05F	8051
RD 80 MX (5G1)	81 - 82	80	LB05F	8051
RX 80 SE (12N)	82 - 83	80	LB05F	8051
T 80		80	LD05F	8060
TY 80		80	LB05F	8051
V 80		80	LB05F	8051
V 80 H / D		80	LB05F	8051
Y 80		80	LB05F	8051
Y 80 E		80	LB05F	8051
YB 80		80	LB05F	8051
YE 80 (4MU)	94 -	80	LB05F	8051
YZ 80	84 - 85	80	LB05F	8051
YZ 80 (4GT)	95 -	80	LB05F	8051
YZ 80 (1LR)	86 -	80	LB05F	8051
YZ 80 B		80	LB05F	8051
YZ 80 C		80	LB05F	8051
YZ 80 D		80	LB05F	8051
YZ 80 E	- 92	80	LB05F	8051
YZ 80 E / F/LW(4LB)/ LWF	93 -	80	LB05F	8051
YZ 80 H	- 83	80	LB05F	8051
YZ 80 H.R.		80	LB05F	8051
YZ 80 L.R.		80	LB05F	8051
YA 90 E / F	93 -	90	LB05F	8051
AG 100		100	LB05F	8051
AG 100 H / E / F		100	LB05F	8051
DT 100		100	LB05F	8051
DT 100 B		100	LB05F	8051
DT 100 C		100	LB05F	8051
DT 100 D		100	LB05F	8051
DT 100 E		100	LB05F	8051
DT 100 H		100	LB05F	8051
DT 100 SD		100	LB05F	8051
DT 100 X		100	LB05F	8051
DX 100		100	LB05F	8051
DX 100 H		100	LB05F	8051
MX 100	79 -	100	LB05F	8051
MX 100 B		100	LB05F	8051
MX 100 H		100	LB05F	8051
RS 100 B		100	LB05F	8051
RS 100 DX (1Y8)	76 - 81	100	LB05F	8051
RS 100 P		100	LB05F	8051
RS 100 S		100	LB05F	8051
RS 100 X		100	LB05F	8051
RT 100 E / F	93 -	100	LB05F	8051
RX 100 12,7mm		100	LB05F	8051
RX 100 19,0mm		100	LB05F	8051
RXS 100		100	LB05F	8051
RX-ZD	93 -	100	LB05F	8051
V 100/E/S/SH	93 -	100	LB05F	8051
YB 100	94 -	100	LB05F	8051
YB 100 M		100	LB05F	8051
YB 100 P		100	LB05F	8051



ccm

Order-  
No.**YAMAHA**

YZ 100	- 83	100	LB05F	8051
YZ 100 E		100	LB05F	8051
YZ 100 H		100	LB05F	8051
V 110 E	93 -	110	LB05F	8051
RX 115	93 -	115	LB05F	8051
V 120 JR / ZR	94 -	120	LB05F	8051
BL 125 (50W)	85 - 89	125	LB05F	8051
DT 125	94 -	125	LB05F	8051
DT 125 E (1G0)	77 - 79	125	LB05F	8051
DT 125 E (AT2)	73 - 76	125	LB05F	8051
DT 125 ED		125	LB05F	8051
DT 125 F		125	LB05F	8051
DT 125 H		125	LB05F	8051
DT 125 LC	86 -	125	LB05F	8051
DT 125 LC (10V)	82 - 85	125	LB05F	8051
DT 125 MX		125	LB05F	8051
DT 125 R (4BL) / RE (3RM)	91 -	125	LB05F/CR2	8051/8048
DT 125 Tenere (I)		125	LB05F	8051
IT 125		125	LB05F	8051
IT 125 H		125	LB05F	8051
MX 125		125	LB05F	8051
R 125 SE		125	LB05F	8051
RD 125 12,7mm		125	LB05F	8051
RD 125 19,0mm		125	LB05F	8051
RD 125 C		125	LB05F	8051
RD 125 C-DX		125	LB05F	8051
RD 125 D		125	LB05F	8051
RD 125 D-DX (AS3)	73 - 75	125	LB05F	8051
RD 125 LC	84 -	125	LB05F	8051
RD 125 LC (10W)	82 - 83	125	LB05F	8051
RS 125 DX		125	LB05F	8051
RS 125 E		125	LB05F	8051
RS 125 P		125	LB05F	8051
RS 125 Z		125	LB05F	8051
RX 125 12,7mm		125	LB05F	8051
RX 125 19,0mm		125	LB05F	8051
RX 125 H		125	LB05F	8051
SR 125		125	LD05F	8060
SR 125 (10F)	97 -	125	LD05F	8060
SR 125 Z	93 -	125	LD05F	8060
TA 125 (400)	73 - 75	125	LB05F	8051
TA 125 A		125	LB05F	8051
TDR 125 (4GW)	92 -	125	LB05F	8051
TDR 125 (5AN)	97 -	125	LB05F	8051
TY 125 (1K6)	77 - 81	125	LB05F	8051
TZ 125 (4JT)	95 -	125	LB05F	8051
TZ 125 (3V3)	80 -	125	LB05F	8051
TZ 125 / F	94 -	125	LB05F	8051
TZ 125 H		125	LB05F	8051
TZR 125	93 -	125	LB05E	8031
TZR 125	- 92	125	LB05F/CR2	8051/8048
XT 125		125	LD05F	8060



ccm

Order-  
No.**YAMAHA**

XV 125 (5AJ)	97 -	125	LD05F	8060
YB 125		125	LB05F/CR2	8051/8048
YS 125		125	LB05F	8051
YZ 125		125	LB05F/CR2	8051/8048
YZ 125 B		125	LB05F	8051
YZ 125 C		125	LB05F	8051
YZ 125 E		125	LB05F	8051
YZ 125 E / E1 / F	93 -	125	LB05F	8051
YZ 125 H		125	LB05F	8051
YZ 125 X		125	LB05F	8051
FZ 150	94 -	150	LD05F	8060
FZR 150	94 -	150	LD05F	8060
RX 150	93 -	150	LB05F	8051
SR 150	93 -	150	LD05F	8060
DT 165 R	91 -	165	LB05F	8051
AG 175		175	LB05F	8051
AG 175 H		175	LB05F	8051
DT 175 (CT1)	74 - 75	175	LB05F	8051
DT 175 E / F		175	LB05F	8051
DT 175 H		175	LB05F	8051
DT 175 MX (2K4)	09.78 - 12.81	175	LB05F	8051
IT 175 (5Y0)	83 - 84	175	LB05F	8051
IT 175 E		175	LB05F	8051
IT 175 H		175	LB05F	8051
MX 175		175	LB05F	8051
MX 175 B		175	LB05F	8051
MX 175 H		175	LB05F	8051
TY 175		175	LB05F	8051
TY 175 E		175	LB05F	8051
TY 175 J		175	LB05F	8051
YZ 175		175	LB05F	8051
RT 180 E	93 -	180	LB05F	8051
XC 180 (32H)	83 - 84	180	LD05F	8060
SH 185 H		185	LD05F	8060
RS 195		195	LB05F	8051
AG 200 E / F	93 -	200	LD05F	8060
BW 200		200	LD05F	8060
DT 200 LC / RE / RF	93 -	200	LB05F	8051
DT 200 R		200	LB05F/CR2	8051/8048
IT 200 S		200	LB05F	8051
NR 200		200	LB05F	8051
RD 200 12,7mm		200	LB05F	8051
RD 200 19,0mm (397)		200	LB05F	8051
RD 200 C		200	LB05F	8051
RD 200 C-DX		200	LB05F	8051
RD 200 D		200	LB05F	8051
RD 200 D-DX (1E8)	77 - 80	200	LB05F	8051
RS 200		200	LB05F	8051
TW 200	01.87 -	200	LD05F	8060
TW 200 E / EC / F	93 -	200	LD05F	8060
TW 200 FC	94 -	200	LD05F	8060
WR 200 R / RE / RF	93 -	200	LB05F	8051



ccm

Order-  
No.**YAMAHA**

XT 225 E / EC / F / FC	93 -	225	LD05F	8060
TDR 240		240	LB05F	8051
XV 240		240	LD05F	8060
DT 250 (512)	75 - 76	250	LB05F	8051
DT 250 E		250	LB05F	8051
DT 250 H		250	LB05F	8051
DT 250 MX (1R7)	77 - 81	250	LB05F	8051
IT 250 (45J)	85 -	250	LB05F	8051
IT 250 (4V5)	81 -	250	LB05F	8051
IT 250 J		250	LB05F	8051
IT 250 K		250	LB05F	8051
IT 250 N		250	LB05F	8051
MX 250		250	LB05F	8051
R1-Z	93 -	250	L05F/CR2	../8048
RD 250 (522)	75 -	250	LB05F	8051
RD 250 D		250	LB05F	8051
RD 250 LC (4L1)	80 - 83	250	LB05F	8051
SE 250 (I)		250	LB05F	8051
SR 250 (I)		250	LB05F	8051
SR 250 H / F		250	LB05F	8051
SR 250 SE (3Y8)	80 - 82	250	LB05F	8051
SR 250 TH		250	LB05F	8051
TDR 250 (3CK)	88 - 89	250	LB05F	8051
TRD 250 (I)		250	LB05F	8051
TT 250		250	LB05F	8051
TT 250 R / RF	94 -	250	LB05F/CR2	8051/8048
TY 250 (38V)	84 - 87	250	LB05F	8051
TY 250 (3BA)	88 - 90	250	LB05F	8051
TY 250 (S16)	75 - 79	250	LB05F	8051
TY 250 Z (4GG)	94 - 96	250	LB05F	8051
TZ 250	84 -	250	LB05F	8051
TZ 250	- 83	250	LB05F	8051
TZ 250 (4DP)	95 -	250	LB05F	8051
TZ 250 / F	94 -	250	LB05F	8051
TZ 250 E	- 83	250	LB05F	8051
TZ 250 E/E1	93 -	250	LB05F	8051
TZ 250 H	- 83	250	LB05F	8051
TZR 250 " V2"	91 - 95	250	LB05E	8051
TZR 250 (2MA)	87 - 89	250	LB05F	8051
TZR 250R/RS/RSP	93 -	250	LB05E	8051
WR 250 Z / ZE / ZF (4JW)	93 -	250	LB05E	8031
XS 250 (1V5)	78 - 79	250	LB05F	8051
XS 250 C		250	LB05F	8051
XS 250 H		250	LB05F	8051
XS 250 RH	- 83	250	LB05F	8051
XS 250 SE		250	SD05F	8022
XS 250 SH		250	SD05F	8022
XT 250 (3Y3)	80 - 82	250	SD05F	8022
XT 250 H	- 84	250	LB05F	8051
XV 250	94 -	250	LD05F	8060
XV 250 (3LS,3LW)	89 -	250	LD05F	8060
XV 250 F	94 -	250	LD05F	8060



ccm

Order-  
No.**YAMAHA**

XV 250 S (3LW)	95 -	250	LD05F	8060
YZ 250 (4MX)	95 -	250	LB05F	8051
YZ 250 (2VM,3JE,3SP,3XK)	88 - 91	250	LB05F	8051
YZ 250 (39X,56A,1LU,2HH)	84 - 87	250	LB05F	8051
YZ 250 (4DA,4EW)	92 -	250	LB05F	8051
YZ 250 (5X5,24Y)	82 - 83	250	LB05F	8051
YZ 250 F	94 -	250	LB05F	8051
BW 350		350	LD05F	8060
TZ 350 B		350	LB05F	8051
TZ 350 H		350	LB05F	8051
XT 350 (3YT)	91 -	350	LD05F	8060
XT 350 (55V)	85 - 90	350	LD05F	8060
XT 350 E / F	93 -	350	LD05F	8060
DT 360 (RT2)	01.73 - 12.75	360	LB05F	8051
MX 360		360	LB05F	8051
YZ 360		360	LB05F	8051
DT 400 (513)	11.75 - 12.76	400	LB05F	8051
DT 400 E		400	LB05F	8051
DT 400 H		400	LB05F	8051
DT 400 MX (1R6)	77 - 80	400	LB05F	8051
FZR 400	04.87 -	400	SD05F	8022
IT 400		400	LB05F	8051
IT 400 E		400	LB05F	8051
MX 400		400	LB05F	8051
RD 400 (1A3)	76 - 79	400	LB05F	8051
RD 400 E		400	LB05F	8051
SR 400		400	LB05F/CR2	8051/8048
TT 400 C		400	LB05F	8051
XJ 400		400	XD05F	8072
XT 400	84 -	400	LD05F	8060
XV 400 SE		400	XB05F	8062
YZ 400		400	LB05F	8051
YZ 400 C		400	LB05F	8051
YZ 400 E		400	LB05F	8051
IT 425		425	LB05E	8031
IT 465 (4V6)	81 -	465	LB05E	8031
IT 465 H		465	LB05E	8031
YZ 465		465	LB05E	8031
YZ 465 H		465	LB05E	8031
IT 490 (29W)	83 - 85	490	LB05F	8051
YZ 490		490	LB05F	8051
IT 500		500	LB05F	8051
RD 500 LC (1GE)	85 - 86	500	LB05F	8051
RD 500 LC (47X)	- 84	500	LB05F	8051
SR 500 (3EB)	95 -	500	LB05F/CR2	8051/8048
SR 500 (2J4,48T)	01.79 - 96	500	LB05F/CR2	8051/8048
SR 500 (48T)	97 -	500	LB05F/CR2	8051/8048
SR 500 E		500	LB05F/CR2	8051/8048
SR 500 H		500	LB05F/CR2	8051/8048
XJ 500		500	XD05F	8072
XT 500 (1E6,1V6)	76 - 89	500	LB05F	8051
XT 500 C		500	LB05F	8051



ccm

Order-  
No.**YAMAHA**

XT 500 E	-	92	500	LB05F	8051
XT 500 H			500	LB05F	8051
XV 500 (I)			500	XB05F	8062
XV 500 SE (26R)	83 -	87	500	XB05F	8062
XT 550 (5Y3)	82 -	83	550	LD05F	8060
XZ 550 (11V)	82 -	84	550	LD05F	8060
XZ 550 S (11V)	83 -	84	550	LD05F	8060
SRX 600 (1XM,1XN)	86 -	89	600	SD05F	8022
XT 600 (2KF,2NF)	87 -	90	600	XD05F	8072
XT 600 (43F)	84 -	87	600	XD05F	8072
XT 600 E (4PT / 4SK)	95 -		600	LD05F	8060
XT 600 E / EF / EFC	94 -		600	LD05F	8060
XT 600 E(h) (3TB)	97 -		600	LD05F	8060
XT 600 E(n) (3UW)	97 -		600	LD05F	8060
XT 600 E/K (3TB/3UW)	90 -	94	600	LD05F	8060
XJ 650 (4K0)	80 -	83	650	XB05F	8062
XJ 650 H			650	XB05F	8062
XJ 650 LH			650	XB05F	8062
XJ 650 SH			650	XB05F	8062
XJ 650 T (Turbo) (11T)	82 -		650	XB05F	8062
XS 650 (447)	76 -	83	650	XB05F	8062
XS 650 (I)			650	XB05F	8062
XS 650 E			650	XB05F	8062
XS 650 H			650	XB05F	8062
XS 650 II			650	XB05F	8062
XS 650 S			650	XB05F	8062
XS 650 SE (3L1)	79 -	81	650	XB05F	8062
XS 650 SH			650	XB05F	8062
FZ 750 (1FN)	85 -	86	750	SD05F	8022
FZ 750 (3KT)	91 -		750	SD05F	8022
FZ 750 Genesis (2KK)	87 -	90	750	SD05F	8022
TZ 750			750	LB05F	8051
TZ 750 D			750	LB05F	8051
XJ 750	-	83	750	LB05F/CR2	8051/8048
XJ 750 (41Y)	84 -	85	750	LB05F/CR2	8051/8048
XJ 750 RH			750	LB05F/CR2	8051/8048
XS 750 (1T5)	77 -	79	750	XB05F	8062
XS 750 C			750	XB05F	8062
XS 750 D			750	XB05F	8062
XS 750 E			750	XB05F	8062
XS 750 S			750	XB05F	8062
XS 750 SE			750	XB05F	8062
XS 750 T			750	XB05F	8062
XTS 750 SE			750	XB05F	8062
XV 750	-	83	750	XB05F	8062
XV 750 (4PW)	95 -		750	XB05F	8062
XS 850 (4E2)	80 -	81	850	XB05F	8062
XS 850 H			850	XB05F	8062
XS 850 LH			850	XB05F	8062
XS 850 SH			850	XB05F	8062
XJ 900 (31A)	83 -	84	900	XB05F	8062
XJ 900 (4BB)	91 -		900	XB05F	8062





ccm



Order-  
No.

### YAMAHA

XJ 900 (58L)	85 - 90	900	<b>XB05F</b>	<b>8062</b>
FJ 1100 (47E)	84 - 85	1100	<b>SD05F</b>	<b>8022</b>
XS 1100 (2H9)	78 - 82	1100	<b>XB05F</b>	<b>8062</b>
XS 1100 E		1100	<b>XB05F</b>	<b>8062</b>
XS 1100 H		1100	<b>XB05F</b>	<b>8062</b>
XS 1100 LH		1100	<b>XB05F</b>	<b>8062</b>
XS 1100 RH		1100	<b>XB05F</b>	<b>8062</b>
XS 1100 S (5K7)	81 - 82	1100	<b>XB05F</b>	<b>8062</b>
XS 1100 SH		1100	<b>XB05F</b>	<b>8062</b>
XV 1100 (3LP)	95 -	1100	<b>XB05F</b>	<b>8062</b>
XV 1100 SC		1100	<b>XB05F</b>	<b>8062</b>
FJ 1200 (1XJ)	86 - 87	1200	<b>SD05F</b>	<b>8022</b>
FJ 1200 (3CW)	88 - 90	1200	<b>SD05F</b>	<b>8022</b>
FJ 1200 (3YA)	91 -	1200	<b>SD05F</b>	<b>8022</b>
FJ 1200 AE/ AEC / E / F	93 -	1200	<b>SD05F</b>	<b>8022</b>
XVZ 12T (47G)	84 - 87	1200	<b>XD05F</b>	<b>8072</b>



ccm

Order-  
No.

<b>APRILIA</b>				
Scarabeo 50	93 - 03	50	LB05F	8051
Scarabeo De Luxe (PF)	98 - 03	50	LB05F	8051
<b>CCF</b>				
Cat 50	97 -	50	LB05FP	8030
<b>DAELIM</b>				
VC 125	97 -	125	XB01F	30275
VS 125	97 -	125	XB01F	30275
<b>HONDA</b>				
Joker SRX50T	97 -	50	LB05F	8051
NB 50		50	LB05F	8051
NB 50 M Melody (AB07)	84 -	50	LB05F	8051
NH 50 M	93 -	50	LB05F	8051
NH 50 MS Lead (AF01)	85 - 87	50	LB05F	8051
PK 50 Wallaro	90 -	50	LB05F	8051
PX 50	89 - 90	50	LB05F	8051
SA 50 Vision	01.88 - 90	50	LB05F	8051
SFX 50	95 -	50	LB05F	8051
SGX 50 Sky	97 -	50	LB05F	8051
SH 50 P	01.93 - 95	50	LB05F	8051
SH 50 T	96 -	50	LB05F	8051
SH 50 (AF40)	97 -	50	LB05F	8051
SH 50 (I)	01.87 - 96	50	LB05F	8051
SJ 50 Bali		50	LB05F	8051
NH 80 MS Lead (HD01)	83 -	80	LB05F	8051
SH 100 T	01.96 -	100	LB05F	8051
SJ 100 Bali	01.96 -	100	LB05F	8051
CH 125	01.86 - 95	125	LD05F	8060
CH 125 P	- 01.93	125	LD05F	8060
NH 125 D Lead	83 -	125	LB05F	8051
Spacy CH 125 (JS03)	97 -	125	LD05F	8060
CN 250	01.86 -	250	VD05F	8052
CN 250 Fusion		250	VD05F	8052
CN 250 Helix (MF02)	01.87 - 99	250	VD05F	8052
<b>ITALJET</b>				
Dragster 50	98 -	50	LB10F	31125
Dragster 50	97 - 98	50	LB10F	31125
Dragster 50	96 - 97	50	LB10F	31125
Fastboy	98 -	50	LB05F	8051
Formula 50 aircool	98 -	50	LB05F	8051
Formula 50 watercool	98 -	50	LB05F	8051
Torpedo 25	97 -	50	LB10F	31125
Dragster 125	97 - 97	125	LB05F	8051
Formula 125	97 - 98	125	LB05F	8051
Formula 125	98 -	125	LB05F	8051
<b>KTM</b>				
Chrono 50		50	LB05F	8051
Go 50		50	LB05F	8051



ccm

Order-  
No.**KTM**

K 50 (I)		50	LB05F	8051
----------	--	----	-------	------

**KYMCO**

Calypso 50	97 -	50	VD05F	8052
Calypso 125	97 -	125	VD05F	8052

**K-ZWO**

Cat 50	97 -	50	LB05FP	8030
--------	------	----	--------	------

**PEUGEOT**

Elystar TSDI 50		50	RC-X99	
Jet Force 50 / TSDI	03.03 -	50	RC-X99	
Looxor 50 TSDI		50	RC-X99	
Speedfight M	96 -	50	LB05E	8031
Speedfight LC	96 -	50	LB05E	8031
SV 50	96 -	50	LB05E	8031
Trekker Off Road	98 -	50	LB05E	8031
Trekker Road		50	LB05E	8031
Speedfight 100	96 - 03	100	LB05E	8031
SV 100	96 -	100	LB05E	8031
Trekker 100	98 -	100	LB05E	8031

**PGO**

Big Max 25/50		50	LB05F	8051
Big Max 50		50	LB05F	8051
Big Max Sport 50	96 -	50	LB05F	8051
Comet		50	LB05F	8051
Galaxy 25		50	LB05F	8051
Galaxy 50		50	LB05F	8051
Mega 50	96 -	50	LB05F	8051
PMS 50	99 -	50	LB05F	8051
PMX 50	99 -	50	LB05F	8051
Rodoshow	02.00 -	50	LB05F	8051
Star 2		50	LB05F	8051
Star 50		50	LB05F	8051
Tornado 50	97 -	50	LB05F	8051
T-REX 50	99 -	50	LB05F	8051
Star 80		80	LB05F	8051
Big Max 90	96 -	82	LB05F	8051
T-REX 125 2T	99 -	125	LB05F	8051
T-REX 125 4T	99 -	125	YB05F	8082

**PIAGGIO / VESPA**

Free 25 Mofa		25	LB05F	8051
Zip 25 Mofa		25	LB05F	8051
Zip Base 25 / Mofa		25	LB05F	8051
50 R, Special		50	LB05F	8051
50 S		50	LB05F	8051
Boss		50	LB05F	8051
Bravo PV		50	LB05F	8051
Bravo P		50	LB05F	8051
Bravo - Si / Moped		50	LB05F	8051



ccm

Order-  
No.**PIAGGIO / VESPA**

Ciao M Kat		50	LB05F	8051
Ciao Mix / Mix		50	LB05F	8051
Ciao V Kat		50	LB05F	8051
Ciao-Bravo SI / Mofa		50	LB05F	8051
Eaglet		50	LB05F	8051
Free 50	93 -	50	LB05F	8051
Grillo / Mofa		50	LB05F	8051
NRG Extreme		50	LB05F	8051
NRG		50	LB05F	8051
NRG mc2 50	01.96 -	50	LB05F	8051
NRG Extreme Kat		50	LB05F	8051
NRG H_0 Kat		50	LB05F	8051
NRG mc2 DT,DD		50	LB05F	8051
PK 50 XL2 Auto		50	LB05F	8051
PK 50 S Auto		50	LB05F	8051
PK 50 SS		50	LB05F	8051
PK 50	09.82 - 12.87	50	LB05F	8051
PK 50 S	09.82 - 12.87	50	LB05F	8051
PK 50 XL 2		50	LB05F	8051
Plurimatic		50	LB05F	8051
PX 50		50	LB05F	8051
Quarz 50 Automatic	06.92 -	50	LB05F	8051
Sfera 50 Automatico	01.91 -	50	LB05F	8051
Sfera 50 , FL, RL, RST		50	LB05F	8051
Storm Automatic	94 -	50	LB05F	8051
Super Bravo / Mofa		50	LB05F	8051
Super Bravo 2 Gang / Mofa		50	LB05F	8051
TPH	93 -	50	LB05F	8051
Velofax / Mofa		50	LB05F	8051
Vespa Delta,Puch Condor		50	LB05F	8051
Vespa PK 50 XL 2 ,Automatic		50	LB05F	8051
Vespa Vale Especial/Standard		50	LB05F	8051
Vespa HP 4M		50	LB05F	8051
Vespa Elestart		50	LB05F	8051
Vespino		50	LB05F	8051
Vespino NX/SC/T/TL/TN/TS		50	LB05F	8051
Vespino TX/XE		50	LB05F	8051
Zip 50 Fast Rider	01.93 -	50	LB05F	8051
Zip 50	01.92 -	50	LB05F	8051
Zip Base 50		50	LB05F	8051
Zip 50 SP		50	LB05F	8051
Zip & Zip (Hybrid)	94 -	50	LB05F	8051
Vespa PK 75S/Elestart/Junior		75	LB05F	8051
Vespa PK 75XL/ Elestart		75	LB05F	8051
Vespa PK 75S Primavera / T3 Prima.		75	LB05F	8051
PK 80 S	09.82 - 12.85	80	LB05F	8051
PX 80 E Lusso		80	LB05F	8051
PX 80 E,P 80 X		80	LB05F	8051
Sfera 80 Automatic		80	LB05F	8051
TPH Automatic	94 -	80	LB05F	8051
PK 100 S	06.82 -	100	LB05F	8051
125 T5	03.85 -	125	LB05F	8051



ccm

Order-  
No.**PIAGGIO / VESPA**

Ape		125	LB05F	8051
Cosa FL 125	91 -	125	LB05F	8051
Cosa 125	- 91	125	LB05F	8051
Cosa 125 MA AE	01.88 -	125	LB05F	8051
Cosa 200 FL EBC 12PS		125	LB05F	8051
ET 3		125	LB05F	8051
ET 4 Automatic		125	LB05F	8051
Hexagon LX 125	94 -	125	LB05F	8051
P 125 ETS	01.83 - 12.85	125	LB05F	8051
PK 125, E, S		125	LB05F	8051
PK 125 XL 2		125	LB05F	8051
PK 125 XL Automatic		125	LB05F	8051
PK Automatic		125	LB05F	8051
Primavera	01.76 - 12.83	125	LB05F	8051
PX 125 E Lusso	01.82 -	125	LB05F	8051
Sfera RST 4 Takt	95 -	125	LB05F	8051
Sfera 125	01.95 -	125	LB05F	8051
Skipper 125 LX	01.93 -	125	LB05F	8051
SKR 125	08.93 -	125	LB05F	8051
TPH	95 -	125	LB05F	8051
Vespa PX 125 Kat		125	LB05F	8051
Vespa T3Li/T3		125	LB05F	8051
Vespa 125 T5 Sport/Elestart		125	LB05F	8051
Vespa 125 CL/LS/NK Primavera		125	LB05F	8051
Vespa 125 FL2	01.90 -	125	LB05F	8051
Vespa PX 125 MA AE	86 -	125	LB05F	8051
Vespa T5		125	LB05F	8051
Vespa PK 125	85 -	125	LB05F	8051
Vespa ET4 125	01.96 -	125	LB05F	8051
Vespa Special ET3 Primavera		125	LB05F	8051
Vespa XL 125 Plurimat/Elestart		125	LB05F	8051
EX 150 (Hexagon)	94 -	150	LB05F	8051
Hexagon 150	01.94 -	150	LB05F	8051
PX 150 E Lusso	01.82 -	150	LB05F	8051
Skipper 150	01.93 -	150	LB05F	8051
SKR 150	98 -	150	LB05F	8051
Vespa PX 150 Kat		150	LB05F	8051
Vespa PX 150 MA AE	86 -	150	LB05F	8051
Vespa 150 long 19,0 mm		150	LB05F	8051
Vespa 150 long 12,7 mm		150	LB05F	8051
Vespa 160/ GT		160	LB05F	8051
Vespa 175		175	LB05F	8051
Vespa SS		180	LB05F	8051
Ape		190	LB05F	8051
Cosa 200 Aluzyl.12PS	93 - 97	200	LB05F	8051
Cosa 2 200	01.88 - 91	200	LB05F	8051
Cosa 200 MA AE	01.88 -	200	LB05F	8051
Cosa FL 200	91 -	200	LB05F	8051
PX 200 E Lusso	01.84 -	200	LB05F	8051
PX 200 E Grand-Sport	01.84 -	200	LB05F	8051
Vespa PX 200 MA AE	86 -	200	LB05F	8051
Vespa PX 200E/Iris/Iris Elestart		200	LB05F	8051



ccm

Order-  
No.

<b>PIAGGIO / VESPA</b>				
Vespa 200 TX/Elestart		200	LB05F	8051
Vespa 200 DN/ DS/ E		200	LB05F	8051
Ape		220	LB05F	8051
Hexagon GT 250 4Takt	98 -	250	VD05F	8052
<b>PUCH</b>				
Lido		50	LB05F	8051
Lido 125		125	LB05F	8051
<b>SACHS</b>				
Speedfight 50 AC	97 -	50	LB05F	8051
Speedfight 50 LC	97 -	50	LB05F	8051
Speedfight 50 LC ADT	97 -	50	LB05F	8051
<b>SIAM</b>				
Falkon 50	97 -	50	LB05FP	8030
<b>SUZUKI</b>				
AH 50 Adress (CA1GA)	92 -	50	LB05F	8051
AH 50 GP	95 -	50	LB05F	8051
AJ 50 ZZ (I)	95 -	50	LB05F	8051
AP 50 S (CA1JA)	95 -	50	LB05F	8051
AP 50 T (I)	96 -	50	LB05F	8051
CP 50 (I)	89 - 92	50	LB05F	8051
AH 100 (CE12A)	95 -	100	LB05F	8051
AH 100 (I)	- 93	100	LB05F	8051
AN 125 (CF42A)	95 - 95	125	LD05F	8060
AN 125 (CF42A)	96 -	125	LD05F	8060
AN 150 T (I)	01.96 -	150	LD05F	8060
<b>YAMAHA</b>				
Aerox	97 -	50	LB05F	8051
Axis (YA50R) (3UG)	97 -	50	LB05F	8051
Axis Mofa (5AK)(YA50R)	97 -	50	LB05F	8051
Breeze (4RC)(YM50)	95 -	50	LB05F	8051
BW 50 Spy (CW50RSP;4VA)	96 -	50	LB05F	8051
BW 50 (4BX)	91 - 95	50	LB05F	8051
BW 50 (CW50)	96 -	50	LB05F	8051
BW 50 Bump (CW50RSX)	96 -	50	LB05F	8051
BW 50 NG (CW50RS;4VA)	96 -	50	LB05F	8051
BW 50 R (4BX)	96 -	50	LB05F	8051
CR 50 Z (I)		50	LB05F	8051
CT 50 S (I)		50	LB05F	8051
CT 50 SS (I)		50	LB05F	8051
CW 50 R (4BX)		50	LB05F	8051
Evolis (YE50)(4FW)		50	LB05F	8051
Forte (YA50R) (3UG)		50	LB05F	8051
Jog-Z 50 (I)	01.95 -	50	LB05F	8051
Neo's	97 - 07	50	LB05F	8051
Spy 50 (I)		50	LB05F	8051
YA 50 (5AK)	97 -	50	LB05F	8051
Zest/ YE50 (4FW)		50	LB05F	8051



ccm



Order-  
No.

### YAMAHA

Evolis	(4MU)			80	LB05F	8051
Zest	(4MU)(YE80)			80	LB05F	8051
BL 125	(50W)	85 -	89	125	LB05F	8051
XC 125	(3TE)	90 -		125	LD05F	8060
XC 125 T	(4NB)	94 -		125	LD05F	8060
XC 125 T Cygnus T	(4NB)	96 -		125	LD05F	8060
XC 125 TR Cygnus	(4NB)	96 -		125	LD05F	8060
XC 125 Cygnus		-	94	125	LD05F	8060
XC 125 Cygnus		01.95 -		125	LD05F	8060
XC 125 T	(4KY)	95 -		125	LD05F	8060
XC 150 Fly one (I)		01.95 -		150	LD05F	8060
YP 250 Majesty	(4UC)			250	LD05F	8060



ccm

Order-  
No.

<b>HONDA</b>				
TRX 70		70	LD05F	8060
TRX 90	93 - 94	90	LD05F	8060
TRX 90	95 -	90	LD05F	8060
ATC 125 M		125	LD05F	8060
TRAX 125		125	LD05F	8060
TRX 125		125	VD05F	8052
ATC 185		185	LD05F	8060
ATC 185 S		185	LD05F	8060
ATC 200		200	VD05F	8052
TRX 200 D	92 -	200	VD05F	8052
ATC 250 ES /SX	85 -	250	VD05F	8052
TRX 250		250	VD05F	8052
TRX 250 R		250	VD05F	8052
TRX 250 X		250	VD05F	8052
<b>KAWASAKI</b>				
KLF 185		185	LD05F	8060
KLF 220	88 - 02	220	LD05F	8060
KDX 250		250	LBER	8308
KDX 250	91 -	250	LB05F	8051
KDX 250 SR	92 -	250	LB05F	8051
KEF 300 A&B (SQ)	95 -	300	LD05F	8060
KLF 300 2X4	88 -	300	LB05F	8051
KLF 300 4X4	88 -	300	LB05F	8051
<b>POLARIS</b>				
Big Boss	89 - 93	250	LB05EZ	8744
Cyclone	88 - 89	250	LB05EZ	8744
Scrambler	89 - 93	250	LB05EZ	8744
Trail Blazer	90 -	250	LB05EZ	8744
Trail Boss	85 -	250	LB05EZ	8744
Xplorer 300	94 -	283	LB05EZ	8744
Xpress 300	94 -	283	LB05EZ	8744
Sportsman 335	99 -	334	LB05EZ	8744
Big Boss	93 -	350	LB05EZ	8744
Trail Boss	90 - 93	350	LB05EZ	8744
Big Boss 400L (6X6)	95 - 97	379	LB05EZ	8744
Scambler 400 (4X4)	94 -	379	LB05EZ	8744
Sport 400	98 -	379	LB05EZ	8744
Sport ATV	95 - 97	379	LB05EZ	8744
Sportsman 4x4	94 - 97	379	LB05EZ	8744
Xplorer 400/400L 4x4	94 -	379	LB05EZ	8744
Xpress 400 L 2x4	96 - 97	379	LB05EZ	8744
Magnum (2X4)	95 -	425	LB05EZ	8744
Magnum (4X4)	95 -	425	LB05EZ	8744
Magnum (6X6)	96 - 97	425	LB05EZ	8744
Big Boss 500 (6X6)	98 -	500	LB05EZ	8744
Magnum 500	99 -	500	LB05EZ	8744
Ranger	99 -	500	LB05EZ	8744
Scrambler 500	98 -	500	LB05EZ	8744
Sportsman 500	96 - 04	500	LB05EZ	8744
Xplorer 500	97 -	500	LB05EZ	8744





ccm

Order-  
No.**SUZUKI**

LT 50			50	LB05F	8051
LT 80			80	LB05F	8051
LT 160 E	-	92	160	LD05F	8060
LT 160 E	93 -		160	LD05F	8060
LT 160 F	93 -		160	LD05F	8060
LT-F 160	95 -		160	LD05F	8060
LT 230 E	93 -		230	LD05F	8060
LT 230 E/F			230	LD05F	8060
LT 230 GE			230	LD05F	8060

**YAMAHA**

YF 60 (1HN)	87 -	88	60	LB05F	8051
YFM 80			80	LD05F	8060
YFM 80 W Badger	02 -		80	LD05F	8060
YFM 80 W	02 -		80	LD05F	8060
YFM 80 E / F	93 -		80	LD05F	8060
YFA 1 Breeze	89 -	04	125	LD05F	8060
YFA 1 F	94 -		125	LD05F	8060
YT 125			125	LB05F	8051
YT 125 CH			125	LB05F	8051
YT 125 H			125	LB05F	8051
YT 175			175	LB05F	8051
YFM 200	92 -		200	LD05F	8060
YFM 200 (52H)	85 -	86	200	LD05F	8060
YFM 225 (2HT)			200	LD05F	8060
YFM 225 (59V)			200	LD05F	8060
YFS 200 Blaster	90 -	04	200	LB05F	8051
YFS 200 E / F	93 -		200	LB05F	8051
TT 225			225	LD05F	8060
YFM 225 59V/2HT	92 -		225	LD05F	8060
YFB 250 / E / F / FWF	93 -		250	LD05F	8060
YFB 250 / FW	94 -		250	LD05F	8060
YFM 250 Timberwolf			250	LD05F	8060
YFM 250 (3GH)	90 -		250	LD05F	8060



Cyl.

Order  
No.

Iridium

Order  
No.**AERO MARINE**

165 CR Serie	1966 - 1970	0,8	BR6ES	4922		
240 Serie		0,6	XR5	5953	XR5IX	7355
265 Serie	1969 - 1970	0,9	XR5	5953	XR5IX	7355
265 Serie	1971 -	1,1	UR4	4762	UR4IX	7401
304		0,8	BPR6ES	7822	BPR6EIX	6637
320 Serie	1966 - 1970	0,8	BR6ES	4922		
320 Serie	1971 -	1,1	UR4	4762	UR4IX	7401
350 Serie	1966 - 1970	0,8	BR6ES	4922		
360 Jet		0,8	BPR6ES	7822	BPR6EIX	6637
375 Serie	1966 - 1970	0,8	BR6ES	4922		
375 Serie	1970 - 1971	1,1	UR4	4762	UR4IX	7401
427 Jet Serie	1971 -	1,1	UR4	4762	UR4IX	7401
454 Serie		1,1	UR4	4762	UR4IX	7401
455 Serie		0,9	XR5	5953	XR5IX	7355
482 Serie		0,8	BPR6ES	7822	BPR6EIX	6637

**AIRMASTER**

Airboot (V-Twin) 25h.p. Kohler engine		0,8	BKR5ES	2460		
---------------------------------------	--	-----	--------	------	--	--

**ALBIN**

0-1 No.18965>		0,8	A6	1010		
0-11		0,8	A6	1010		
0-1L No.1948>		0,6	B6HS	4510	BR6HIX	3419
0-2 No.15826>		0,8	A6	1010		
0-21		0,6	B6HS	4510	BR6HIX	3419
0-21		0,8	A6	1010		
0-41		0,8	A6	1010		
0-411		0,8	A6	1010		
0-4SP No. 19325>		0,8	A6	1010		
2000 V-1		0,6	B6HS	4510	BR6HIX	3419
2000 SP		0,7	BR7HS	4122	BR7HIX	7067
A4		0,6	B6HS	4510	BR6HIX	3419
A-6SP		0,7	BR7HS	4122	BR7HIX	7067
AL22		0,8	A6	1010		
AL23		0,8	A6	1010		
E4		0,8	A6	1010		
E5		0,8	A6	1010		
E6		0,8	A6	1010		
G-6		0,8	A6	1010		
G-6B		0,8	A6	1010		
S-4		0,6	B6HS	4510	BR6HIX	3419
T1500 Spezial		0,6	B6HS	4510	BR6HIX	3419
T-4		0,8	A6	1010		

**AMECO**

302 Ford engine		0,8	WR5	1071	WR5IX	7510
351 W cid Ford engine		0,8	WR5	1071	WR5IX	7510



Cyl.

Order  
No.

Iridium

Order  
No.**AMERICAN CHALLENGER**

Eagle 400			0,5	UR5	2139	UR5IX	7177
Eagle 400			0,5	UR5	2139	UR5IX	7177
Eagle 400			0,9	UR5	2139	UR5IX	7177
Eagle 600			0,5	UR5	2139	UR5IX	7177
Eagle 600			0,9	UR5	2139	UR5IX	7177
Eagle 600			0,5	UR5	2139	UR5IX	7177
Eagle 800			0,8	UR5	2139	UR5IX	7177
Eagle 800			0,5	UR5	2139	UR5IX	7177
Eagle 800			0,5	UR5	2139	UR5IX	7177

**AUSTIN**

18 mm			0,6	A6	1010		
Chief (14mm)			0,6	BR6ES	4922		
Healey 35			0,6	BR6ES	4922		
Healey 55			0,6	BR6ES	4922		
Healey 75			0,6	BR6ES	4922		
Healey 3300			0,6	BR6ES	4922		
Skipper (14mm)			0,6	BR6ES	4922		

**B & W**

BW30 , 35			0,6	B6ES	7310		
BW60 , 105 , 155 , 165			0,6	B6S	3510		
LH Master , LH (dual ign.)			0,6	B6S	3510		
LH Super , LH Super Special			0,6	B6S	3510		

**B.L.M.C.**

1100 Vedette			0,6	B6ES	7310		
1622 Navigator 1959			0,6	B6ES	7310		
850 Sea Prince 2912 cc			0,6	BP5ES	6511	BPR5EIX	6597
950 , 1678 , 3000 CC			0,6	B6ES	7310		

**BARR (Conversions)*****Buick***

Buick engines 400cid		1967 - 1969	1,1	UR4	4762	UR4IX	7401
Buick engines 430cid		1967 - 1969	1,1	UR4	4762	UR4IX	7401
Buick engines 455cid		1970 - 1970	1,1	UR4	4762	UR4IX	7401
Buick engines 455cid		1971 - 1974	0,7	BPR5FS	2423		

***Chevrolet***

Chevrolet engines 194cid	6	1962 - 1969	0,9	BPR5ES	7422	BPR5EIX	6597
Chevrolet engines 230cid	6	1962 - 1969	0,9	BPR5ES	7422	BPR5EIX	6597
Chevrolet engines 230cid	6	1970 -	1,1	UR4	4762	UR4IX	7401
Chevrolet engines 250cid	6	1962 - 1969	0,9	BPR5ES	7422	BPR5EIX	6597
Chevrolet engines 250cid	6	1970 - 1978	0,7	BPR5FS	2423		
Chevrolet engines 250cid	6	1979 - 1984	1,1	UR4	4762	UR4IX	7401
Chevrolet engines 283cid	8	1955 - 1967	1,0	XR4	2637	XR4IX	7189
Chevrolet engines 292cid	6	1963 - 1969	0,9	BR6ES	4922		



Cyl.

Order  
No.

Iridium

Order  
No.**BARR (Conversions)*****Chevrolet***

Chevrolet engines 292cid	6	1970 - 1992	1,1	UR4	4762	UR4IX	7401
Chevrolet engines 302cid	8	1967 - 1969	0,9	XR4	2637	XR4IX	7189
Chevrolet engines 307cid	8	1968 - 1970	1,0	XR4	2637	XR4IX	7189
Chevrolet engines 307cid	8	1971 - 1973	0,7	BPR5FS	2423		
Chevrolet engines 327cid	8	1961 - 1969	0,9	XR5	5953	XR5IX	7355
Chevrolet engines 350cid	8	1971 - 1990	1,1	UR4	4762	UR4IX	7401
Chevrolet engines 350cid 2-bbl	8	1967 - 1970	1,0	XR4	2637	XR4IX	7189
Chevrolet engines 350cid 4-bbl	8	1970 -	1,0	XR4	2637	XR4IX	7189
Chevrolet engines 400cid	8	1970 -	1,0	XR4	2637	XR4IX	7189
Chevrolet engines 400cid	8	1971 - 1990	1,1	UR4	4762	UR4IX	7401
Chevrolet engines 427cid	8	1971 - 1972	0,9	UR5	2139	UR5IX	7177
Chevrolet engines 427cid	8	1973 - 1990	1,1	UR4	4762	UR4IX	7401
Chevrolet engines 454cid	8	1979 - 1989	1,1	UR4	4762	UR4IX	7401

***Chrysler***

Chrysler engines 383cid 2-bbl		1960 - 1971	0,9	BP4	2911		
Chrysler engines 383cid 4-bbl		1968 - 1971	1,0	XR4	2637	XR4IX	7189
Chrysler engines 383cid Hi-Perf.		1966 - 1967	1,0	XR4	2637	XR4IX	7189
Chrysler engines 413cid		1963 - 1965	0,9	BP4	2911		
Chrysler engines 413cid Hi-Perf.		1963 - 1965	1,0	XR4	2637	XR4IX	7189
Chrysler engines 413cid two 4-bbl		1963 - 1964	1,0	XR4	2637	XR4IX	7189
Chrysler engines 440cid 350hp.		1966 - 1971	1,0	XR4	2637	XR4IX	7189
Chrysler engines 440cid 375hp.		1966 - 1971	0,9	XR4	2637	XR4IX	7189
Chrysler engines 440cid.		1972 - 1979	1,0	XR4	2637	XR4IX	7189

***Oldsmobile***

Oldsmobile engines 350cid		1971 - 1974	1,0	XR4	2637	XR4IX	7189
Oldsmobile engines 350cid 2-bbl		1968 - 1970	1,0	XR4	2637	XR4IX	7189
Oldsmobile engines 350cid 4-bbl		1968 - 1970	1,0	XR4	2637	XR4IX	7189
Oldsmobile engines 455cid		1976 - 1978	0,9	BP4	2911		
Oldsmobile engines 455cid 2-bbl		1971 -	0,9	BP4	2911		
Oldsmobile engines 455cid 4-bbl		1970 - 1971	1,0	XR4	2637	XR4IX	7189
Oldsmobile engines 455cid 4-bbl		1972 - 1974	0,9	BP4	2911		
Oldsmobile engines 455cid Hi-Perf.		1972 - 1974	1,0	XR4	2637	XR4IX	7189

***Pontiac***

Pontiac engines 389cid		1960 - 1967	1,0	XR4	2637	XR4IX	7189
Pontiac engines 400cid		1967 - 1971	1,0	XR4	2637	XR4IX	7189
Pontiac engines 400cid		1972 - 1974	0,7	BPR5FS	2423		
Pontiac engines 421cid		1963 - 1966	1,0	XR4	2637	XR4IX	7189
Pontiac engines 428cid		1967 - 1969	1,0	XR4	2637	XR4IX	7189
Pontiac engines 455cid		1972 - 1974	0,7	BPR5FS	2423		
Pontiac engines 455cid 2-bbl		1971 -	0,9	BP4	2911		
Pontiac engines 455cid 4-bbl		1970 - 1971	0,9	BP4	2911		

**BAUDOIN**

CR , H4 , LH , LK , LKL			0,6	B6L	3212		
LA , LO3 , LO3H , LOL			0,5	B4	3210		



Cyl.

Order  
No.

Iridium

Order  
No.**BAUDOIN**

VL3 , VL3F , VL3FT

0,5

**B6S****3510****BERKELEY*****Chevrolet***

350 cid Chevrolet

1976 - 1990

0,9

**YR5****5334****YR5IX****7516*****Ford***

460 cid Ford Big Block

1976 - 1990

0,9

**UR5****2139****UR5IX****7177*****GM***

454 cid GM Big Block

1976 - 1990

0,9

**YR5****5334****YR5IX****7516*****Oldsmobile***

302 cid Oldsmobile, 14mm Hds.

1974 - 1990

0,9

**UR5****2139****UR5IX****7177**

302 cid Oldsmobile, 18mm Hds.

1974 - 1977

0,9

**AR6FS****3323**

351 cid Oldsmobile, 14mm Hds.

1974 - 1990

0,9

**UR5****2139****UR5IX****7177**

351 cid Oldsmobile, 18mm Hds.

1974 - 1977

0,9

**AR6FS****3323**

455 cid Oldsmobile

1976 - 1968

0,9

**XR4****2637****XR4IX****7189****BMW**

411

0,6

**BP6ES****7811****BPR6EIX****6637**

412

0,6

**BP8ES****2912**

611

0,6

**BP6ES****7811****BPR6EIX****6637**

B130 , 130S

0,6

**BP5ES****6511****BPR5EIX****6597**

B190, B220

0,6

**BP5ES****6511****BPR5EIX****6597**

B1901, B190S

0,6

**BP5ES****6511****BPR5EIX****6597**

B2201, B220S

0,6

**BP5ES****6511****BPR5EIX****6597**

G130-1, G130-S

0,6

**BP5ES****6511****BPR5EIX****6597**

G190-1, G190-S

0,6

**BP5ES****6511****BPR5EIX****6597**

G220-1, G220-S

0,6

**BP5ES****6511****BPR5EIX****6597**

G2400 , G3400 , G4700

0,5

**BR4HS****3322**

G800

0,5

**B6HS****4510****BR6HIX****3419****BOG MARIN**

16 (14 mm)

0,6

**B6HS****4510****BR6HIX****3419**

16 (18mm)

0,6

**A6****1010**

26

0,6

**B6S****3510**

55 (14 mm)

0,6

**B6S****3510**

55 (18 mm)

0,6

**A6****1010****BOMBARDIER (Sea-Doo)*****Rotax***

Challenger Rotax 787 cc

0,6

**BR8ES****3961****BR8EIX****5044**

Explorer Rotax 717 cc

0,6

**BR8ES****3961****BR8EIX****5044**

Speedster Rotax 717 cc

0,5

**BR8ES****3961****BR8EIX****5044**

Sportser Rotax 717 cc

0,6

**BR8ES****3961****BR8EIX****5044**



Cyl.



Order No.

Iridium



Order No.

**BPM**

1800L / LR / M / MR ,3500LR/MR			0,6	<b>B6S</b>	<b>3510</b>		
Artic 181 / 157			0,6	<b>BP6ES</b>	<b>7811</b>	<b>BPR6EIX</b>	<b>6637</b>
Ionic 144 / 127			0,6	<b>BP7ES</b>	<b>2412</b>	<b>BPR7EIX</b>	<b>4055</b>
Oceanic 235 / 265, Vulcano 375			0,6	<b>BP7ES</b>	<b>2412</b>	<b>BPR7EIX</b>	<b>4055</b>
Vulcano 450			0,6	<b>BP8ES</b>	<b>2912</b>		

**BRIDAN**

500 cc , 700 cc			0,6	<b>B6HS</b>	<b>4510</b>	<b>BR6HIX</b>	<b>3419</b>
-----------------	--	--	-----	-------------	-------------	---------------	-------------

**BRIT**

18 mm			0,5	<b>A6</b>	<b>1010</b>		
Imp , Sprite			0,5	<b>B6ES</b>	<b>7310</b>		
Minor 1255 , Skippy			0,6	<b>B6HS</b>	<b>4510</b>	<b>BR6HIX</b>	<b>3419</b>

**BRIT. LEYLAND**

1622 Navigator			0,6	<b>B6ES</b>	<b>7310</b>		
850 Sea Prince 2912 cc			0,6	<b>BP5ES</b>	<b>6511</b>	<b>BPR5EIX</b>	<b>6597</b>
950 , 1678 , 3000 cc			0,6	<b>B6ES</b>	<b>7310</b>		

**BRIT. SEAGULL**

SD110 (102cc)			0,9	<b>A6</b>	<b>1010</b>		
SD160 (102cc)			0,9	<b>B7ES</b>	<b>1111</b>		
ST110		1979 - 1981	0,9	<b>A6</b>	<b>1010</b>		

**BUEHLER**

Jetstream,Chrysler273,428cu.in			0,9	<b>BR6ES</b>	<b>4922</b>		
--------------------------------	--	--	-----	--------------	-------------	--	--

**CAILLE**

all models 18 mm			0,5	<b>A6</b>	<b>1010</b>		
------------------	--	--	-----	-----------	-------------	--	--

**CASTOLDI**

1966cc 113hp		1974 -	0,9	<b>WR5</b>	<b>1071</b>	<b>WR5IX</b>	<b>7510</b>
2261E		1974 -	0,9	<b>BR6ES</b>	<b>4922</b>		
2264E		1974 -	0,9	<b>BPR5ES</b>	<b>7422</b>	<b>BPR5EIX</b>	<b>6597</b>
2614E		1974 -	0,9	<b>GR5</b>	<b>7537</b>	<b>GR5IX</b>	<b>7214</b>

**CHEVROLET (Marine Conversions)**

194cid	6	1962 - 1969	0,9	<b>BPR5ES</b>	<b>7422</b>	<b>BPR5EIX</b>	<b>6597</b>
230cid	6	1962 - 1969	0,9	<b>BPR5ES</b>	<b>7422</b>	<b>BPR5EIX</b>	<b>6597</b>
230cid	6	1970 -	1,1	<b>UR4</b>	<b>4762</b>	<b>UR4IX</b>	<b>7401</b>
250cid	6	1962 - 1969	0,9	<b>BPR5ES</b>	<b>7422</b>	<b>BPR5EIX</b>	<b>6597</b>
250cid	6	1979 - 1984	1,1	<b>UR4</b>	<b>4762</b>	<b>UR4IX</b>	<b>7401</b>
283cid	8	1955 - 1967	1,0	<b>XR4</b>	<b>2637</b>	<b>XR4IX</b>	<b>7189</b>



Cyl.

Order  
No.

Iridium

Order  
No.**CHEVROLET (Marine Conversions)**

292cid	6	1963 - 1969	1,1	UR4	4762	UR4IX	7401
292cid	6	1970 - 1978	0,7	BPR5FS	2423		
302cid	8	1967 - 1969	0,9	XR4	2637	XR4IX	7189
307cid	8	1968 - 1970	0,9	XR4	2637	XR4IX	7189
307cid	8	1971 - 1973	0,7	BPR5FS	2423		
327cid	8	1961 - 1969	0,9	XR5	5953	XR5IX	7355
350cid	8	1971 - 1990	1,1	UR4	4762	UR4IX	7401
350cid 2-bbl	8	1967 - 1970	1,0	XR4	2637	XR4IX	7189
350cid 4-bbl	8	1970 -	1,0	XR4	2637	XR4IX	7189
400cid	8	1970 -	1,0	XR4	2637	XR4IX	7189
400cid	8	1971 - 1990	1,1	UR4	4762	UR4IX	7401
427cid	8	1971 - 1972	0,7	UR6	4079	UR6IX	7348
427cid	8	1973 - 1990	1,1	UR4	4762	UR4IX	7401
454cid	8	1979 - 1990	0,8	UR5	2139	UR5IX	7177

**CHRIS-CRAFT**

153 ->No. 603191			0,9	BR6ES	4922		
181 ->No. 603191			0,9	BR6ES	4922		
181 No.603192->			0,7	UR6	4079	UR6IX	7348
225 Serie			1,0	XR4	2637	XR4IX	7189
283 Gasket Seat			0,6	XR5	5953	XR5IX	7355
3.0 Ltr. OMC Cobra			1,1	UR4	4762	UR4IX	7401
302, 307, 327 Gasket Seat			0,6	XR5	5953	XR5IX	7355
305, GLV, K-Serie		1986 - 1997	1,1	UR4	4762	UR4IX	7401
307, 350 Tapered Seat			0,7	UR6	4079	UR6IX	7348
307, GLV,K 215hp		1975 - 1976	0,7	BPR5FS	2423		
350 Hi-Perf.			0,9	UR5	2139	UR5IX	7177
350, FLV Hi-Perf. 300hp		1975 - 1986	1,1	UR4	4762	UR4IX	7401
350, GLV, K-Serie 250hp		1975 - 1986	1,1	UR4	4762	UR4IX	7401
350, Q-Serie		1979 - 1991	1,1	UR4	4762	UR4IX	7401
4.3 Ltr. OMC Cobra			1,1	UR4	4762	UR4IX	7401
427 Serie			0,8	WR5	1071	WR5IX	7510
430 Serie			0,8	WR5	1071	WR5IX	7510
431 Serie			0,8	WR5	1071	WR5IX	7510
454 Tapered Seat			0,7	UR6	4079	UR6IX	7348
5.0Ltr. EFi OMC Cobra			1,1	UR4	4762	UR4IX	7401
5.7 Ltr. TBI / Carburator			1,1	UR4	4762	UR4IX	7401
5.8 Ltr. Efi OMC Cobra			0,9	BPR6EFS	3623		
5.8 Ltr. Efi OMC King Cobra			0,9	BPR6EFS	3623		
5.8 Ltr. OMC Cobra			0,9	BPR6EFS	3623		
7.4Ltr. OMC Cobra			1,1	UR4	4762	UR4IX	7401
7.4Ltr. EFi OMC Cobra			1,1	UR4	4762	UR4IX	7401
8.2Ltr. Mpi / Carburator			1,1	UR4	4762	UR4IX	7401
A,B,BA,C,H,K,KB / Alu Heads			0,7	B6L	3212		
A,B,BA,C,H,K,KB / Regular Heads			0,7	BR6S	3522		
KBL,KC,KFL,KL,KLC / Alu Heads			0,7	B6L	3212		
KBL,KC,KFL,KL,KLC / Regular Heads			0,7	BR6S	3522		
LC,LD,M,MB,MBL / Alu Heads			0,7	B6L	3212		
LC,LD,M,MB,MBL / Regular Heads			0,7	BR6S	3522		
MC,MCL,ML,W,WB / Alu Heads			0,7	B6L	3212		



Cyl.



Order No.

Iridium



Order No.

**CHRIS-CRAFT**

MC,MCL,ML,W,WB / Regular Heads			0,7	BR6S	3522		
--------------------------------	--	--	-----	------	------	--	--

**CHRYSLER**

B46-4	6		0,9	BR6S	3522	---	---
B46S-3	6		0,9	BR6S	3522	---	---
LM318A	8		0,9	BPR6ES	7822	BPR6EIX	6637
LM318AC	8		0,9	BPR6ES	7822	BPR6EIX	6637
LM318B	8		0,9	BPR6ES	7822	BPR6EIX	6637
LM318BC	8		0,9	BPR6ES	7822	BPR6EIX	6637
LM318BJ	8		0,9	BPR6ES	7822	BPR6EIX	6637
LM318BT	8		0,9	BPR6ES	7822	BPR6EIX	6637
LM318BV	8		0,9	BPR6ES	7822	BPR6EIX	6637
LM318D	8		0,9	BPR6ES	7822	BPR6EIX	6637
LM340B	8		0,9	BPR6ES	7822	BPR6EIX	6637
LM340BJ	8		0,9	BPR6ES	7822	BPR6EIX	6637
LM340BT	8		0,9	BPR6ES	7822	BPR6EIX	6637
LM340BV	8		0,9	BPR6ES	7822	BPR6EIX	6637
M122A	4		0,9	B7HS	5110	---	---
M122B	4		0,9	B7HS	5110	---	---
M170	6		0,9	BR6ES	4922	---	---
M183B	6		0,9	B7HS	5110	---	---
M225A	6		0,9	BR6ES	4922	---	---
M225D	6	- 1974	0,9	BR6ES	4922	---	---
M225D	6	1975 - 1979	0,9	BPR6FS	2623	---	---
M225GD	6		0,9	BR6ES	4922	---	---
M265	6		0,9	BR6S	3522	---	---
M265A	6		0,9	BR6S	3522	---	---
M273A	8		0,9	BPR6ES	7822	BPR6EIX	6637
M273B	8		0,9	BPR6ES	7822	BPR6EIX	6637
M273BT	8		0,9	BPR6ES	7822	BPR6EIX	6637
M318A	8		0,9	XR5	5953	XR5IX	7355
M318B	8		0,9	XR5	5953	XR5IX	7355
M318C	8		0,9	XR5	5953	XR5IX	7355
M318GD	8		0,9	XR5	5953	XR5IX	7355
M360A	8		0,9	BPR6ES	7822	BPR6EIX	6637
M360B	8		0,9	BPR6ES	7822	BPR6EIX	6637
M360BC	8		0,9	BPR6ES	7822	BPR6EIX	6637
M360BJ	8		0,9	BPR6ES	7822	BPR6EIX	6637
M360BT	8		0,9	BPR6ES	7822	BPR6EIX	6637
M360BV	8		0,9	BPR6ES	7822	BPR6EIX	6637
M383B	8		0,9	XR5	5953	XR5IX	7355
M383BV	8		0,9	XR5	5953	XR5IX	7355
M400B	8		0,9	XR5	5953	XR5IX	7355
M400BV	8		0,9	XR5	5953	XR5IX	7355
M400S	8		0,9	XR5	5953	XR5IX	7355
M413B	8		0,9	XR5	5953	XR5IX	7355
M413D	8		0,9	XR5	5953	XR5IX	7355
M413E	8		0,9	BR6ES	4922	---	---
M426B	8		0,9	XR5	5953	XR5IX	7355
M426D	8		0,9	XR5	5953	XR5IX	7355
M426-Ski	8		0,9	XR5	5953	XR5IX	7355





Cyl.

Order  
No.

Iridium

Order  
No.**CHRYSLER**

M44	8		0,9	BR6S	3522	---	---
M440B	8		0,9	XR5	5953	XR5IX	7355
M440BJ	8		0,9	XR5	5953	XR5IX	7355
M440BV	8		0,9	XR5	5953	XR5IX	7355
M440D	8		0,9	XR5	5953	XR5IX	7355
M440S	8		0,9	XR5	5953	XR5IX	7355
M440SV	8		0,9	XR5	5953	XR5IX	7355
M44-3	8		0,9	BR6S	3522	---	---
M45	8		0,9	BR6ES	4922	---	---
M45-3	8		0,9	BR6ES	4922	---	---
M45S	8		0,9	BR6ES	4922	---	---
M45-S3	8		0,9	BR6ES	4922	---	---
M45-SP3	8		0,9	BR6ES	4922	---	---
M460B	8		0,9	UR5	2139	UR5IX	7177
M46-3	6		0,9	BR6S	3522	---	---
M47-3	6		0,9	BR6S	3522	---	---
M47-4	6		0,9	BR6S	3522	---	---
M47S-3	6		0,9	BR6S	3522	---	---
M80	8		0,9	XR5	5953	XR5IX	7355
M81	8		0,9	BR6ES	4922	---	---
M91D	4		0,9	BP6ES	7811	BPR6EIX	6637
M91F	4		0,9	BP6ES	7811	BPR6EIX	6637

**CHRYSLER-VOLVO**

110			0,7	BR7HS	4122	BR7HIX	7067
115			0,7	BR7HS	4122	BR7HIX	7067
120			0,7	BR7HS	4122	BR7HIX	7067
130			0,7	BR7HS	4122	BR7HIX	7067
165			0,7	BR7HS	4122	BR7HIX	7067
170			0,7	BR7HS	4122	BR7HIX	7067

**CLIMAX**

98 cu in.			0,8	BPR6ES	7822	BPR6EIX	6637
302 , 351 cu in.			0,8	A6FS	2210		
460 cu in.			0,8	APR6FS	2922		

**CLINTON**

all models			0,6	B6S	3510		
------------	--	--	-----	-----	------	--	--

**CON-O-LIFT**

Marine Hydraulic Triler Honda engine 5,5hp			0,8	BPR5ES	7422	BPR5EIX	6597
--	--	--	-----	--------	------	---------	------



Cyl.



Order No.

Iridium



Order No.

**CORNELL**

Marine Hoists

0,7

A6

1010

**Chrysler**

225cid Marine Hoists Chrysler engine

0,7

BPR5FS

2423

**Ford**

300cid Marine Hoists Ford engine

0,8

AR6FS

3323

**COVENTRY- VICTOR**

all other models 18mm, 18 x 1

0,5

A6

1010

AN3 , WN3

0,5

B6ES

7310

Midget

0,5

B6HS

4510

BR6HIX

3419

**CRESCENT**

45

0,5

B8HS

5510

BR8HIX

7001

**CROSLEY**

all models

0,6

B6S

3510

**CRUSADER**

165 229 cid

1979 - 1980

0,9

BPR6FS

2623

---

---

185 292 cid

1971 - 1980

0,9

R5674-7

3535

---

---

210 307 cid

1971 - 1980

0,9

R5674-7

3535

---

---

229 cu

1979 - 1980

0,7

UR6

4079

UR6IX

7348

229 cu

1981 - 1984

0,8

UR5

2139

UR5IX

7177

255 351 cid

1974 - 1975

0,8

AR6FS

3323

---

---

270 350 cid

1971 - 1998

0,9

BPR6FS

2623

---

---

292 cu Modell 185

1971 - 1980

0,7

UR6

4079

UR6IX

7348

302 cid

1974 - 1975

0,8

AR6FS

3323

---

---

307 cu Modell 210

1971 - 1980

0,7

UR6

4079

UR6IX

7348

350 454 cid

1972 - 1980

0,9

BPR6FS

2623

---

---

350 460 cid

1974 - 1975

0,9

BPR6FS

2623

---

---

427 427 cid

1968 - 1980

0,9

R5674-7

3535

---

---

502 502 cid

1989 - 1998

0,9

BPR6FS

2623

---

---

CH185 229 cid

1981 - 1984

0,9

BPR6FS

2623

---

---

Mark 140

0,6

B6S

3510

---

---

Mark 170

0,6

B6S

3510

---

---

Mark 200

0,6

B6S

3510

---

---

Mark 225

0,6

B6S

3510

---

---

Mark 240

0,8

B6ES

7310

---

---

Mark 275

0,8

B8S

3810

---

---

Mark 280

0,8

B6ES

7310

---

---

Mark 300

0,8

B8S

3810

---

---

Mark 325

0,8

B8S

3810

---

---



Cyl.

Order  
No.

Iridium

Order  
No.**CRUSADER**

<b>CRUSADER</b>							
<i>Boat Builder</i>							
170J			0,6	<b>B6S</b>	<b>3510</b>	---	---
185			0,6	<b>XR5</b>	<b>5953</b>	<b>XR5IX</b>	<b>7355</b>
190			0,6	<b>XR5</b>	<b>5953</b>	<b>XR5IX</b>	<b>7355</b>
200J			0,6	<b>XR5</b>	<b>5953</b>	<b>XR5IX</b>	<b>7355</b>
210			0,6	<b>XR5</b>	<b>5953</b>	<b>XR5IX</b>	<b>7355</b>
220			0,6	<b>XR5</b>	<b>5953</b>	<b>XR5IX</b>	<b>7355</b>
230			0,6	<b>XR5</b>	<b>5953</b>	<b>XR5IX</b>	<b>7355</b>
230J			0,6	<b>XR5</b>	<b>5953</b>	<b>XR5IX</b>	<b>7355</b>
250			0,6	<b>XR5</b>	<b>5953</b>	<b>XR5IX</b>	<b>7355</b>
280			0,9	<b>BR6ES</b>	<b>4922</b>		
CM Cadilac			0,6	<b>XR5</b>	<b>5953</b>	<b>XR5IX</b>	<b>7355</b>
CS100			0,8	<b>B6ES</b>	<b>7310</b>	---	---
CS150			0,8	<b>B6ES</b>	<b>7310</b>	---	---
CS165			0,8	<b>B6ES</b>	<b>7310</b>	---	---
CS180			0,8	<b>B6S</b>	<b>3510</b>	---	---
CS220			0,8	<b>B6S</b>	<b>3510</b>	---	---
CS250			0,8	<b>B6S</b>	<b>3510</b>	---	---
CS280			0,8	<b>B6ES</b>	<b>7310</b>	---	---
CS320			0,8	<b>B6ES</b>	<b>7310</b>	---	---
<i>Champion</i>							
305 cid			0,9	<b>BPR6FS</b>	<b>2623</b>	---	---
350 cid			0,9	<b>BPR6FS</b>	<b>2623</b>	---	---
350 cu HT			0,8	<b>UR5</b>	<b>2139</b>	<b>UR5IX</b>	<b>7177</b>
454 cid			0,9	<b>BPR6FS</b>	<b>2623</b>	---	---
<i>Charger</i>							
CS185			0,6	<b>B6S</b>	<b>3510</b>	---	---
CS220			0,6	<b>B6S</b>	<b>3510</b>	---	---
CS250			0,6	<b>B6S</b>	<b>3510</b>	---	---
CS280			0,9	<b>B6ES</b>	<b>7310</b>	---	---
CS320			0,8	<b>B6ES</b>	<b>7310</b>	---	---
<i>Classic</i>							
5.7L Plus EFI			1,1	---	---	<b>TR5IX</b>	<b>7397</b>
5.7L Plus MPI			1,1	---	---	<b>TR5IX</b>	<b>7397</b>
7.4L HO MPI			1,1	<b>BR6FS</b>	<b>4323</b>	---	---
7.4L MPI			1,1	---	---	<b>TR5IX</b>	<b>7397</b>
8.2L MPI			1,1	<b>BR6FS</b>	<b>4323</b>	---	---
<i>Platinum</i>							
5.7L Plus MPI			1,1	---	---	<b>TR5IX</b>	<b>7397</b>
7.4L HO MPI			1,1	<b>BR6FS</b>	<b>4323</b>	---	---
7.4L MPI			1,1	---	---	<b>TR5IX</b>	<b>7397</b>
8.2L MPI			1,1	<b>BR6FS</b>	<b>4323</b>	---	---
<i>XL/Xii</i>							
262 cid		1985 - 1998	0,9	<b>BPR6FS</b>	<b>2623</b>	---	---
305 cid			0,9	<b>BPR6FS</b>	<b>2623</b>	---	---



Cyl.

Order  
No.

Iridium

Order  
No.**CRUSADER***XL/Xii*

350 cid			0,9	BPR6FS	2623	---	---
350 cid HT			0,9	BPR6FS	2623	---	---
454 cid		1981 - 1998	0,9	BPR6FS	2623	---	---
454 cid HO			0,9	BPR6FS	2623	---	---
502 cid			0,9	BPR6FS	2623	---	---

**CUYUNA**

430LC 40hp Jet Drive			0,8	BR8ES	5422	BR8EIX	5044
SP 250			0,7	BR6ES	4922		

**DAYTONA**

100 , 150			0,9	B6ES	7310		
200 , 300			0,9	B6S	3510		
400 , 400 Turbo			0,9	B7ES	1111		
427 , 427 Turbo heavy Service			0,9	B8ES	2411	BR8EIX	5044
427 , 427 Turbo light Service			0,9	B7ES	1111		

**DIESEL-TECHNIEK**

DTR 40			0,6	BP6HS	4511	BPR6HIX	4085
DTR 50			0,6	BP6HS	4511	BPR6HIX	4085

**DYNAFOIL**

G440-BW (432cc) Xenoah engine			0,9	BR6ES	4922		
-------------------------------	--	--	-----	-------	------	--	--

**EVINRUDE**

CU , SU 153cid 110, 120hp			0,9	BR6ES	4922		
DU 89 cid 88, 90hp			0,8	B6S	3510		
HU 225 cid 150,155hp			0,9	BP5S	3011		
KU 283 cid 185hp			0,9	B6S	3510		
NU 1600cc 89,90hp			0,6	BP6ES	7811	BPR6EIX	6637
TU 14 , 15 , 16 300 cid 200hp			0,9	XR4	2637	XR4IX	7189
TU 17 ->283,307 cid 210hp			0,9	XR4	2637	XR4IX	7189

**FAGEOL**

44 , 53			0,6	B6S	3510		
FM 200 , FM 225			0,5	B6S	3510		

**FLAGSHIP**

155 292 cid			0,9	B6ES	7310	---	---
181FL 181 cid 125FMC		1975 - 1977	0,9	YR5	5334	YR5IX	7516
280E 280 cid		1975 - 1977	0,9	R5674-7	3535	---	---
300 427 cid		1971 - 1974	0,9	B7ES	1111	---	---



Cyl.

Order  
No.

Iridium

Order  
No.**FLAGSHIP****Heavy Service**

305 cid	1975 - 1993	1,1	<b>R5674-7</b>	<b>3535</b>	---	---
350 cid	1975 - 1993	1,1	<b>R5674-7</b>	<b>3535</b>	---	---
454 cid	1975 - 1993	1,1	<b>R5674-7</b>	<b>3535</b>	---	---
300 cid	1977 -	1,1	<b>R5674-7</b>	<b>3535</b>	---	---

**Hi Performance**

295FAS 350 cid	1975 - 1993	0,9	<b>R5674-7</b>	<b>3535</b>	---	---
335 350 cid	1975 - 1993	0,9	<b>R5674-7</b>	<b>3535</b>	---	---
380FAS 350 cid	1975 - 1993	0,9	<b>R5674-7</b>	<b>3535</b>	---	---
400FAJ 454 cid	1975 - 1977	0,9	<b>R5674-7</b>	<b>3535</b>	---	---
400FAS 454 cid	1975 - 1977	0,9	<b>R5674-7</b>	<b>3535</b>	---	---
450FAJ 454 cid	1975 - 1993	0,9	<b>R5674-7</b>	<b>3535</b>	---	---
450FAS 454 cid	1975 - 1993	0,9	<b>R5674-7</b>	<b>3535</b>	---	---
460FAJ 454 cid	1975 - 1977	0,9	<b>R5674-7</b>	<b>3535</b>	---	---
460FAS 454 cid	1975 - 1977	0,9	<b>R5674-7</b>	<b>3535</b>	---	---
500FAJ 454 cid	1975 - 1977	0,9	<b>R5674-7</b>	<b>3535</b>	---	---
500FAJ 490 cid	1975 - 1981	0,9	<b>R5674-7</b>	<b>3535</b>	---	---
500FAS 454 cid	1975 - 1977	0,9	<b>R5674-7</b>	<b>3535</b>	---	---
500FAS 490 cid	1975 - 1981	0,9	<b>R5674-7</b>	<b>3535</b>	---	---
675FAJ (Normal Use) 466 cid	1975 - 1981	0,9	<b>R5674-7</b>	<b>3535</b>	---	---
675FAJ (Racing) 466 cid	1975 - 1977	0,9	<b>R5673-10</b>	<b>2482</b>	---	---
675FAS (Normal Use) 466 cid	1975 - 1981	0,9	<b>R5674-7</b>	<b>3535</b>	---	---
675FAS (Racing) 466 cid	1975 - 1977	0,9	<b>R5673-10</b>	<b>2482</b>	---	---
TC400 350 cid	1975 - 1993	0,9	<b>R5674-7</b>	<b>3535</b>	---	---
TC450 350 cid	1975 - 1993	0,9	<b>R5673-7</b>	<b>4367</b>	---	---
TC500 454 cid	1975 - 1993	0,9	<b>R5673-8</b>	<b>4140</b>	---	---
TC500 350 cid	1975 - 1993	0,9	<b>R5673-8</b>	<b>4140</b>	---	---
TC550 454 cid	1975 - 1993	0,9	<b>R5674-7</b>	<b>3535</b>	---	---
TC600 454 cid	1975 - 1993	0,9	<b>R5673-7</b>	<b>4367</b>	---	---
TC650 454 cid	1975 - 1977	0,9	<b>R5673-8</b>	<b>4140</b>	---	---
TC700 466 cid	1975 - 1981	0,9	<b>R5673-10</b>	<b>2482</b>	---	---
TC800 460 cid	1975 - 1977	0,9	<b>R5673-10</b>	<b>2482</b>	---	---
TCX950 466 cid	1975 - 1981	0,9	<b>R5673-10</b>	<b>2482</b>	---	---

**Light Service**

454 cid	1975 - 1977	1,1	<b>UR5</b>	<b>2139</b>	<b>UR5IX</b>	<b>7177</b>
305 cid	1975 - 1977	1,1	<b>UR5</b>	<b>2139</b>	<b>UR5IX</b>	<b>7177</b>
300 cid	1977 -	1,1	<b>UR5</b>	<b>2139</b>	<b>UR5IX</b>	<b>7177</b>

**Transdrive, Inboard, V-Drive**

66		0,8	<b>B4</b>	<b>3210</b>		
85		0,8	<b>BR6S</b>	<b>3522</b>		
90		0,8	<b>BR6S</b>	<b>3522</b>		
96		0,8	<b>B4</b>	<b>3210</b>		
100		0,8	<b>BR6S</b>	<b>3522</b>		
118		0,8	<b>BR6S</b>	<b>3522</b>		
136		0,8	<b>B4</b>	<b>3210</b>		
145		0,8	<b>BR6S</b>	<b>3522</b>		
150		0,8	<b>BR6S</b>	<b>3522</b>		
181FL	1975 - 1977	1,1	<b>UR4</b>	<b>4762</b>	<b>UR4IX</b>	<b>7401</b>



Cyl.

Order  
No.

Iridium

Order  
No.**FLAGSHIP****Transdrive, Inboard, V-Drive**

185			0,8	BR6S	3522		
190			0,8	BR6S	3522		
220			0,8	BR6S	3522		
225			0,8	BR6S	3522		
240			0,8	BR6S	3522		
250			0,8	BR6S	3522		
280E		1975 - 1977	0,7	UR6	4079	UR6IX	7348
283			0,8	BR6S	3522		
292 cu in. 155			0,9	BR6ES	4922		
292 cu in.		1971 - 1974	0,7	UR5	2139	UR5IX	7177
305 cu in.		1977 - 1993	0,7	UR6	4079	UR6IX	7348
307 cu in.		1971 - 1974	0,7	UR6	4079	UR6IX	7348
310			0,8	BR6S	3522		
327			0,8	BR6S	3522		
350 cu in.		1971 - 1993	0,7	UR6	4079	UR6IX	7348
350M			0,8	BR6S	3522		
427 cu in. 300			0,9	BR6ES	4922		
427 cu in.		1971 - 1974	0,7	UR6	4079	UR6IX	7348
454 cu in.		1971 - 1993	0,9	UR6	4079	UR6IX	7348

**FORD**

67 cu in.			0,9	GR5	7537	GR5IX	7214
98 cu in.			0,9	GR5	7537	GR5IX	7214
104 cu in.			0,7	GR4	7038	GR4IX	7149
158 cu in.			0,9	BR6ES	4922		
172 cu in.			0,7	B6L	3212		
201 cu in.			0,9	BR6ES	4922		
250 cu in.			0,8	AR6FS	3323		
427 cu in.		1975 - 1989	0,7	UR5	2139	UR5IX	7177
427 cu in. 302,351W		- 1974	0,9	WR5	1071	WR5IX	7510
429 cu in.		1975 - 1989	0,7	UR5	2139	UR5IX	7177
460 cu in. 302,351W		1975 - 1989	0,8	UR5	2139	UR5IX	7177
477 cu in.		1976 -	0,8	AR6FS	3323		
534 cu in.		1976 -	0,8	AR6FS	3323		

**GOFF**

GMP 225		1969 - 1973	0,9	XR4	2637	XR4IX	7189
GMP 455		1961 - 1970	0,8	XR4	2637	XR4IX	7189
GMP 455		1971 - 1972	1,0	XR4	2637	XR4IX	7189
GMP 455		1973 -	1,0	XR4	2637	XR4IX	7189

**GOTA**

5-6 , 10-12 , 15-18			0,5	A6	1010		
SLF10 , SL3 , SL6 , SL12			0,5	A6	1010		



Cyl.

Order  
No.

Iridium

Order  
No.**GRAYMARINE***Express*

Four 52			0,7	AB6	2910		
Four 112			0,7	AB6	2910		
Four 140			0,7	A6	1010		
Four 162			0,7	A6	1010		
Seascout 91			0,9	BR6S	3522		
Six 71			0,7	AB6	2910		
Six 77			0,7	AB6	2910		
Six 80			0,7	AB6	2910		
Six 91			0,7	A8	1210		
Six 111			0,7	AB6	2910		
Six 121			0,7	A6	1010		
Six 186			0,7	A6	1010		
Six 224			0,7	A8	1210		
Six 427			0,7	AB6	2910		
Super 117			0,7	A6	1010		
Super 427			0,7	A6	1010		

*Fireball*

135			0,7	XR5	5953	XR5IX	7355
138			0,7	XR5	5953	XR5IX	7355
138A			0,7	XR5	5953	XR5IX	7355
170			0,7	XR5	5953	XR5IX	7355
175			0,7	XR5	5953	XR5IX	7355
178			0,7	XR5	5953	XR5IX	7355
178B			0,7	XR5	5953	XR5IX	7355
188			0,7	XR5	5953	XR5IX	7355
195			0,7	XR5	5953	XR5IX	7355
215			0,7	XR5	5953	XR5IX	7355
220			0,7	XR5	5953	XR5IX	7355
225			0,7	XR5	5953	XR5IX	7355
238			0,7	XR5	5953	XR5IX	7355
260			0,7	XR5	5953	XR5IX	7355
280			0,7	XR5	5953	XR5IX	7355
304			0,7	GR4	7038	GR4IX	7149
310			0,7	XR5	5953	XR5IX	7355
360			0,7	GR4	7038	GR4IX	7149
427			0,7	XR5	5953	XR5IX	7355
C, CF, CH			0,7	XR5	5953	XR5IX	7355
Four 50			0,9	BR6S	3522		
Four 90			0,7	AB6	2910		
Six 116			0,7	A6	1010		
Six 140			0,7	A6	1010		
Six 150			0,7	A6	1010		
Six 160			0,7	A6	1010		
Six 232 Stern Drive			0,9	GR5	7537	GR5IX	7214
Super 330			0,7	A6	1010		

*Lugger*

Four 22			0,7	A7	1110		
Four 40			0,7	AB6	2910		
Four 52			0,7	A7	1110		
Four 69			0,9	BR6S	3522		



Cyl.

Order  
No.

Iridium

Order  
No.**GRAYMARINE*****Lugger***

Four 75		0,7	AB6	2910	
Four 80		0,7	AB6	2910	
Four 85TD		0,7	AB6	2910	
Four 112		0,7	A7	1110	
Four 140		0,7	AB6	2910	
Four 162		0,7	AB6	2910	
Seascout 45		0,9	BR6S	3522	
Seascout 91		0,9	BR6S	3522	
Six 51		0,7	A7	1110	
Six 71		0,7	A6	1010	
Six 77		0,7	A6	1010	
Six 91		0,7	AB6	2910	
Six 121		0,7	A7	1110	
Six 186		0,7	A7	1110	
Six 226		0,7	A7	1110	
Six 244		0,7	AB6	2910	
Six 330		0,7	A7	1110	

***Phantom***

Four 45		0,9	BR6S	3522	
Four 62		0,7	A6	1010	
Four 75		0,7	AB6	2910	
Four 85		0,7	AB6	2910	
Four 86		0,7	AB6	2910	
Four 162		0,7	AB6	2910	
Four 620		0,7	AB6	2910	
Four 750		0,7	AB6	2910	
Six 70		0,7	AB6	2910	
Six 80		0,7	AB6	2910	
Six 88		0,7	A6	1010	
Six 90		0,7	A6	1010	
Six 100		0,7	AB6	2910	
Six 103		0,7	A6	1010	
Six 104		0,7	A6	1010	
Six 109		0,7	AB6	2910	
Six 109TD		0,7	AB6	2910	
Six 110		0,7	AB6	2910	
Six 112		0,7	A6	1010	
Six 115		0,7	A8	1210	
Six 116		0,7	AB6	2910	
Six 118		0,7	AB6	2910	
Six 120		0,7	AB6	2910	
Six 122		0,7	AB6	2910	
Six 125		0,7	A6	1010	
Six 135		0,7	A8	1210	
Six 135		0,7	AB6	2910	
Six 136		0,7	AB6	2910	
Six 150		0,7	AB6	2910	
Six 165		0,7	AB6	2910	
Six 175		0,7	AB6	2910	
Six 185		0,7	AB6	2910	
Six 200		0,7	A8	1210	





Cyl.

Order  
No.

Iridium

Order  
No.**GUARDIAN MARINE*****Chevrolet***

454 cid			1,1	UR4	4762	UR4IX	7401
---------	--	--	-----	-----	------	-------	------

***Ford***

302 cid			0,9	UR5	2139	UR5IX	7177
351W cid			0,9	UR5	2139	UR5IX	7177
460 cid			0,9	UR5	2139	UR5IX	7177

***Oldsmobile***

455 cid			0,9	XR4	2637	XR4IX	7189
---------	--	--	-----	-----	------	-------	------

**HARDIN**

H225IO		1980 - 1986	0,9	YR5	5334	YR5IX	7516
H225J		1980 - 1986	0,9	YR5	5334	YR5IX	7516
H225V		1980 - 1986	0,9	YR5	5334	YR5IX	7516
H240J (Gasket Seat)		1969 - 1990	0,9	XR5	5953	XR5IX	7355
H240J (Taper Seat)		1969 - 1990	0,9	UR5	2139	UR5IX	7177
H240V (Gasket Seat)		1969 - 1990	0,9	XR5	5953	XR5IX	7355
H240V (Taper Seat)		1969 - 1990	0,9	UR5	2139	UR5IX	7177
H260IO		1980 - 1986	0,9	YR5	5334	YR5IX	7516
H260J		1980 - 1986	0,9	YR5	5334	YR5IX	7516
H260V		1980 - 1986	0,9	YR5	5334	YR5IX	7516
H280		1980 - 1986	0,9	YR5	5334	YR5IX	7516
H280J		1980 - 1980	0,9	YR5	5334	YR5IX	7516
H280V		1980 - 1986	0,9	YR5	5334	YR5IX	7516
H295J		1960 - 1976	0,9	XR5	5953	XR5IX	7355
H295V		1960 - 1976	0,9	XR5	5953	XR5IX	7355
H300J		1977 - 1990	0,9	XR5	5953	XR5IX	7355
H300V		1977 - 1990	0,9	XR5	5953	XR5IX	7355
H305I		1979 - 1990	0,9	YR5	5334	YR5IX	7516
H320J		1979 - 1990	0,9	YR5	5334	YR5IX	7516
H320TC		1978 - 1990	0,7	R5673-7	4367	---	---
H320V		1979 - 1990	0,9	YR5	5334	YR5IX	7516
H324J		1975 - 1976	0,9	XR5	5953	XR5IX	7355
H324V		1975 - 1976	0,9	XR5	5953	XR5IX	7355
H325J		1969 - 1976	0,7	XR5	5953	XR5IX	7355
H325V		1969 - 1976	0,7	XR5	5953	XR5IX	7355
H333J		1976 - 1990	0,9	YR5	5334	YR5IX	7516
H333V		1976 - 1990	0,9	YR5	5334	YR5IX	7516
H345J		1969 - 1976	0,7	XR5	5953	XR5IX	7355
H345V		1969 - 1976	0,7	XR5	5953	XR5IX	7355
H350I		1979 - 1990	0,9	YR5	5334	YR5IX	7516
H405J		1974 - 1990	0,9	YR5	5334	YR5IX	7516
H405TC		1978 - 1990	0,7	B7HS	5110	---	---
H405V		1974 - 1990	0,9	YR5	5334	YR5IX	7516
H454I		1979 - 1990	0,9	YR5	5334	YR5IX	7516
H455J (ET)		1976 -	0,9	XR5	5953	XR5IX	7355
H455V (ET)		1976 -	0,9	XR5	5953	XR5IX	7355
HM225		1983 - 1990	0,9	UR5	2139	UR5IX	7177
HM260		1983 - 1990	0,9	UR5	2139	UR5IX	7177



Cyl.



Order No.

Iridium



Order No.

**HARDIN**

HM280		1983 - 1990	0,9	UR5	2139	UR5IX	7177
HM333		1983 - 1990	0,9	UR5	2139	UR5IX	7177
HM400		1983 - 1990	0,9	UR5	2139	UR5IX	7177
HM405		1983 - 1990	0,9	UR5	2139	UR5IX	7177
HM430		1983 - 1990	0,9	UR5	2139	UR5IX	7177

**HARMAN HOUSE**

<b>Chevrolet</b>							
350 cid			0,9	UR5	2139	UR5IX	7177
454 cid			1,1	UR4	4762	UR4IX	7401
<b>Ford</b>							
460 cid			0,9	UR5	2139	UR5IX	7177

**HOVER AIR AMERICA**

3 +1 (4,3Ltr)			1,1	UR4	4762	UR4IX	7401
---------------	--	--	-----	-----	------	-------	------

**HUSTLER**

350			0,7	UR6	4079	UR6IX	7348
375			0,7	UR6	4079	UR6IX	7348
450			0,7	UR6	4079	UR6IX	7348
525			0,7	UR6	4079	UR6IX	7348
585			0,7	UR6	4079	UR6IX	7348

**IMC**

850cc			0,8	BR9ES	5722	BR9EIX	3981
1300cc			0,8	BR9ES	5722	BR9EIX	3981

**INDMAR**

<b>Cadillac</b>							
4.6L MPI Northstar	279 cid	Cadillac	6		1,2	---	TR55IX 7164
<b>Ford</b>							
5.0L V8 200	302 cid	Ford	8	1991 - 1995	1,1	UR5	2139 UR5IX 7177
5.0L V8 225	302 cid	Ford	8	1991 - 1997	0,9	UR5	2139 UR5IX 7177
5.8L V8	351 cid	Ford	8	1983 - 1987	0,9	A6FS	2210 --- ---
5.8L V8 250	351 cid	Ford	8	1991 - 1997	0,9	UR5	2139 UR5IX 7177
5.8L V8 285 H.O.	351 cid	Ford	8	1991 - 1997	1,1	BPR6EFS	3623 --- ---
7.5L V8	460 cid	Ford	8	1976 - 1984	0,9	UR5	2139 UR5IX 7177
<b>GM</b>							
3.0L		GM	4		0,9	BR6FS	4323 --- ---
4.3L V6 EFI		GM	6		1,1	BR6FS	4323 --- ---
5.0L V8 230		GM Small Block	8		1,1	BR6FS	4323 --- ---
5.0L V8 230SP		GM Small Block	8		1,1	BR6FS	4323 --- ---
5.7L V8		GM Small Block	8	1976 - 1987	1,0	UR5	2139 UR5IX 7177
5.7L V8 Carb		GM Small Block	8		1,1	BR6FS	4323 --- ---



Cyl.

Order  
No.

Iridium

Order  
No.**INDMAR****GM**

5.7L V8 Carb H.O.	GM Small Block	8		1,1	<b>BPR6EFS</b>	<b>3623</b>	---	---
5.7L V8 EFI	GM Small Block	8		1,1	<b>BR6FS</b>	<b>4323</b>	---	---
5.7L V8 EFI MCX 350	GM Small Block	8	2003 -	1,0			<b>TR55IX</b>	<b>7164</b>
5.7L V8 EFI H.O.	GM Small Block	8		1,1	<b>BPR6EFS</b>	<b>3623</b>	---	---
5.7L V8 Gen 1+ Carb	GM Small Block	8		1,1	<b>BPR6EFS</b>	<b>3623</b>	---	---
5.7L V8 Gen 1+ H.O. Carb	GM Small Block	8		1,1	<b>BPR6EFS</b>	<b>3623</b>	---	---
5.7L V8 Gen 1+ H.O. PFI	GM Small Block	8		1,1	<b>BPR6EFS</b>	<b>3623</b>	---	---
5.7L V8 Indmar TBI	GM Small Block	8		1,1	<b>BR6FS</b>	<b>4323</b>	---	---
5.7L V8 LS1	GM Small Block	8	2003 -	1,5	<b>TR55</b>	<b>1048</b>	<b>TR55IX</b>	<b>7164</b>
5.7L V8 LT-1	GM Small Block	8		1,1	<b>BPR6EFS</b>	<b>3623</b>	---	---
6.0L V8	GM Big Block	8	2003 -	1,5	<b>TR55</b>	<b>1048</b>	<b>TR55IX</b>	<b>7164</b>
6.6L V8	GM Small Block	8		1,1	<b>BR6FS</b>	<b>4323</b>	---	---
7.4L V8	GM Big Block	8	1998 - 1999	1,1	<b>BPR6EFS</b>	<b>3623</b>	---	---
7.4L V8	GM Big Block	8	2003 -	1,1	<b>TR5</b>	<b>7837</b>	<b>TR5IX</b>	<b>7397</b>
7.4L V8 Carb	GM Big Block	8	- 1997	1,1	<b>BR6FS</b>	<b>4323</b>	---	---
7.4L V8 Carb H.O.	GM Big Block	8	- 1997	1,1	<b>BR6FS</b>	<b>4323</b>	---	---
7.4L V8 EFI	GM Big Block	8	- 1997	1,1	<b>BR6FS</b>	<b>4323</b>	---	---
7.4L V8 EFI H.O.	GM Big Block	8	- 1997	1,1	<b>BR6FS</b>	<b>4323</b>	---	---
7.4L V8 H.O.	GM Big Block	8	- 1997	1,1	<b>BPR6EFS</b>	<b>3623</b>	---	---
8.1L MPI Vortec	GM Big Block	8	2003 -	1,5	<b>TR55</b>	<b>1048</b>	<b>TR55IX</b>	<b>7164</b>
8.2L V8	GM Big Block	8	- 1997	1,1	<b>BR6FS</b>	<b>4323</b>	---	---
8.2L V8	GM Big Block	8	1998 - 1999	1,1	<b>BPR6EFS</b>	<b>3623</b>	---	---
8.2L V8	GM Big Block	8	2003 -	1,1	<b>TR5</b>	<b>7837</b>	<b>TR5IX</b>	<b>7397</b>
8.2L V8 H.O.	GM Big Block	8	- 1997	1,1	<b>BR6FS</b>	<b>4323</b>	---	---

**Oldsmobile**

5.7L V8 350 cid	Oldsmobile	8	1976 - 1982	1,0	<b>XR4</b>	<b>2637</b>	<b>XR4IX</b>	<b>7189</b>
6.6L V8 403 cid	Oldsmobile	8	1976 - 1982	1,0	<b>XR4</b>	<b>2637</b>	<b>XR4IX</b>	<b>7189</b>
7.5L V8 455 cid	Oldsmobile	8	1975 - 1976	1,0	<b>XR4</b>	<b>2637</b>	<b>XR4IX</b>	<b>7189</b>

**INTERCEPTOR**

104 V4		4		0,8	<b>BPR7HS</b>	<b>6422</b>	<b>BPR7HIX</b>	<b>5944</b>
122 V6		6		0,8	<b>BPR7HS</b>	<b>6422</b>	<b>BPR7HIX</b>	<b>5944</b>
144 Side Draught				0,8	<b>WR5</b>	<b>1071</b>	<b>WR5IX</b>	<b>7510</b>
170 Down Draught				0,9	<b>AR6FS</b>	<b>3323</b>		
170 Side Draught				0,8	<b>WR5</b>	<b>1071</b>	<b>WR5IX</b>	<b>7510</b>
200				0,9	<b>AR6FS</b>	<b>3323</b>		
256				0,9	<b>AR6FS</b>	<b>3323</b>		
272				0,9	<b>AR6FS</b>	<b>3323</b>		
289				0,9	<b>AR6FS</b>	<b>3323</b>		
292				0,9	<b>AR6FS</b>	<b>3323</b>		
302				0,8	<b>WR5</b>	<b>1071</b>	<b>WR5IX</b>	<b>7510</b>
312				0,9	<b>AR6FS</b>	<b>3323</b>		
352				0,9	<b>AR6FS</b>	<b>3323</b>		
390				0,8	<b>WR5</b>	<b>1071</b>	<b>WR5IX</b>	<b>7510</b>
427 300hp				0,9	<b>AR6FS</b>	<b>3323</b>		
427 400hp				0,8	<b>WR5</b>	<b>1071</b>	<b>WR5IX</b>	<b>7510</b>



Cyl.



Order No.

Iridium



Order No.

**JOHNSON**

CU , SU 153cid 110,120hp			0,9	B6ES	7310		
DU 89cid 88,90hp			0,8	B6S	3510		
HU 225cid 150,155hp			0,9	XR4	2637	XR4IX	7189
KU 283cid 185hp			0,9	XR5	5953	XR5IX	7355
NU 1600cc 80,90hp			0,7	GR5	7537	GR5IX	7214
TU -14 , -15 , -16 300cid 200hp			0,9	XR4	2637	XR4IX	7189
TU -17 ->283,307 cid 210hp			1,0	XR4	2637	XR4IX	7189

**KERMATH**

Sea Pup , Sea Twin			0,9	XR5	5953	XR5IX	7355
--------------------	--	--	-----	-----	------	-------	------

**KING**

350 cid 240hp		1971 - 1973	1,0	XR4	2637	XR4IX	7189
454 cid 450hp		1973 - 1986	1,1	UR4	4762	UR4IX	7401
455 cid 270hp		1971 - 1973	1,0	XR4	2637	XR4IX	7189
455 cid 325hp		1972 - 1973	1,0	XR4	2637	XR4IX	7189
455 cid 410hp		1972 - 1973	1,0	XR4	2637	XR4IX	7189

**KODIAK**

3.0L L4 140 hp 181 cid	4	1999 - 2000	1,1	UR4	4762	UR4IX	7401
4.3L V6 220 hp 262 cid	6	1999 - 2000	1,1	BR6FS	4323	---	---
5.7L V8 310 hp 350 cid	8	1999 - 2000	1,1	TR5	7837	TR5IX	7397
7.4L V8 350 hp 454 cid	8	1999 - 2000	1,1	BR6FS	4323	---	---

**KOHLER**

L-160			0,6	B6S	3510		
TU-17			0,9	B6S	3510		

**MARINE DRIVE SYSTEMS**

85 Stern Drive			0,6	BP7HS	5111	---	---
110 Stern Drive			0,6	BP7HS	5111	---	---

**MARINE POWER**

181	Gasket Seat	4	1975 - 1978	0,9	BR6ES	4922	
181 .460" Reach	Tapered Seat		1975 - 1991	1,1	UR4	4762	UR4IX 7401
181 .708" Reach	Tapered Seat		1992 - 1997	0,9	TR4	4392	TR4IX 7300
181 .708" Reach	Tapered Seat	4	1998 -	0,9	TR4	4392	TR4IX 7300
229 cid GM engine		6		1,1	UR4	4762	UR4IX 7401
250 cid GM engine		6		0,7	BPR5FS	2423	
262 200, 225 hp		6	- 2000	1,1	UR4	4762	UR4IX 7401
262 cid GM engine		6		1,1	UR4	4762	UR4IX 7401
292 cid GM engine	Gasket Seat			0,9	BR6ES	4922	
292 cid GM engine	Tapered Seat			1,1	UR4	4762	UR4IX 7401



Cyl.

Order  
No.

Iridium

Order  
No.**MARINE POWER**

302 cid Ford engine			0,9	UR5	2139	UR5IX	7177
305 GLV, K-Serie	8	1977 - 1986	1,1	UR4	4762	UR4IX	7401
305 cid GM engine			1,1	UR4	4762	UR4IX	7401
307 GLV, K-215 hp	8	1975 - 1976	0,9	UR4	4762	UR4IX	7401
318 cid Chrysler engine			0,9	BPR5ES	7422	BPR5EIX	6597
327 cid GM engine			0,9	XR5	5953	XR5IX	7355
350 GLV K-Serie 250hphp	8	1975 - 1986	1,1	UR4	4762	UR4IX	7401
350 FLV Hi-Perf. 300hp	8	1975 - 1986	1,1	UR4	4762	UR4IX	7401
350 Q-Serie	8	1979 - 1991	1,1	UR4	4762	UR4IX	7401
350 260,300,325 hp	8	1992 -	1,1	UR4	4762	UR4IX	7401
350 Premium 294hp	8	1996 - 1997	0,9	TR4	4392	TR4IX	7300
350 cid GM engine			1,1	UR4	4762	UR4IX	7401
351 W cid Ford engine			0,9	WR5	1071	WR5IX	7510
360 cid Chrysler engine			0,9	BPR5ES	7422	BPR5EIX	6597
440 cid Chrysler engine			1,0	XR4	2637	XR4IX	7189
454 B,BM 330hp	8	1975 - 1991	1,1	UR4	4762	UR4IX	7401
454 340,390,440hp	8	1992 -	1,1	UR4	4762	UR4IX	7401
454 cid GM engine			0,9	UR5	2139	UR5IX	7177
460 cid Ford engine			0,9	UR5	2139	UR5IX	7177
502 410,475hp	8	- 1997	1,1	UR4	4762	UR4IX	7401
502 410,475hp	8	1998 - 2000	1,1	UR4	4762	UR4IX	7401
502 502X	8	1999 -	1,1	UR4	4762	UR4IX	7401
502 700X 700hp	8	2000 -	1,1	UR4	4762	UR4IX	7401
540 550HP	8	- 1997	0,7	UR5	2139	UR5IX	7177
Vortec 7.4L Mpi 325,340hp	8	1998 -	1,1	UR4	4762	UR4IX	7401
Vortec 4.3L 225hp	8	1998 -	0,7	UR5	2139	UR5IX	7177
Vortec 5.7L 325hp	8	1998 -	0,7	UR5	2139	UR5IX	7177

**MARINE REPOWER**

<b>Chrysler</b>							
318 cid			0,9	BPR5ES	7422	BPR5EIX	6597
360 cid			0,9	BPR5ES	7422	BPR5EIX	6597
440 cid			1,0	XR4	2637	XR4IX	7189
<b>Ford</b>							
302 cid			0,9	UR5	2139	UR5IX	7177
351W cid			0,9	WR5	1071	WR5IX	7510
460 cid			0,9	UR5	2139	UR5IX	7177
<b>GM</b>							
229 cid V6	6		1,1	UR4	4762	UR4IX	7401
250 cid V6	6		0,7	BPR5FS	2423		
262 cid V6	6		1,1	UR4	4762	UR4IX	7401
292 cid Gasket Seat			0,7	BR6ES	4922		
292 cid Tapered Seat			1,1	UR4	4762	UR4IX	7401
305 cid			1,1	UR4	4762	UR4IX	7401
327 cid			0,9	XR5	5953	XR5IX	7355
350 cid			1,1	UR4	4762	UR4IX	7401
454 cid			0,9	UR5	2139	UR5IX	7177



Cyl.



Order No.

Iridium



Order No.

**MARINETEK****Chrysler**

318 cid	1966 - 1974	1,0	XR4	2637	XR4IX	7189
318 cid	1975 - 1988	0,9	BPR5ES	7422	BPR5EIX	6597
360 cid	1975 - 1988	0,9	BPR5ES	7422	BPR5EIX	6597

**Ford**

302 cid	1968 - 1974	0,9	WR5	1071	WR5IX	7510
302 cid	1975 - 1980	0,9	UR5	2139	UR5IX	7177
302 cid	1981 - 1995	1,1	UR4	4762	UR4IX	7401
351 cid	1969 - 1974	0,9	WR5	1071	WR5IX	7510
351 cid	1975 - 1987	0,9	UR5	2139	UR5IX	7177
460 cid	1973 - 1974	0,9	WR5	1071	WR5IX	7510
460 cid	1975 - 1987	0,9	UR5	2139	UR5IX	7177

**GM**

181 cid 3.0l HO	1990 - 1997	1,1	TR4	4392	TR4IX	7300
229 cid	1980 - 1984	1,1	UR4	4762	UR4IX	7401
250 cid	1970 - 1980	1,1	UR4	4762	UR4IX	7401
262 cid	1985 - 1992	1,1	UR4	4762	UR4IX	7401
305 cid	1976 - 1995	1,1	UR4	4762	UR4IX	7401
350 cid	1967 - 1970	1,0	XR4	2637	XR4IX	7189
350 cid	1971 - 1995	1,1	UR4	4762	UR4IX	7401
350 cid HO	1987 - 1995	0,9	UR5	2139	UR5IX	7177
454 cid	1973 - 1987	1,1	UR4	4762	UR4IX	7401
454 cid Gen V	1992 - 1993	0,9	UR5	2139	UR5IX	7177
454 cid HO	1984 - 1991	0,9	UR5	2139	UR5IX	7177

**MERCURISER****224Kw Petrol**

350MAG Mpi Horizon	8	0,9			TR55IX	7164
--------------------	---	-----	--	--	--------	------

**Ford 302 & 351cid**

215	8	0,8	AR6FS	3323		
225	8	0,8	AR6FS	3323		
233 18mm Dia	8	0,8	AR6FS	3323		
233 14mm Dia	8	1,1	UR4	4762	UR4IX	7401
255	8	1,1	UR4	4762	UR4IX	7401

**GM 305,327&350**

198	8	1,1	UR4	4762	UR4IX	7401
225	8	0,8	B7S	3710		
228	8	1,1	UR4	4762	UR4IX	7401
230	8	1,1	UR4	4762	UR4IX	7401
250 (from 2317201->2797056	8	0,8	B7S	3710		
255	8	1,1	UR4	4762	UR4IX	7401
260	8	1,1	UR4	4762	UR4IX	7401
270 Gasket Seat	8	0,8	B7S	3710		
270 Tapered Seat	8	1,1	UR4	4762	UR4IX	7401
350 Magnum ->0F799999 / Efi,MP,Mpi	8	1,0	BR6FS	4323		



Cyl.

Order  
No.

Iridium

Order  
No.**MARINE REPOWER****GM 305,327&350**

350 Magnum OF800000-> /Gen+Efi,Mpi	8		0,8	TR4	4392	TR4IX	7300
350 MagnumSki Carb.	8		1,0	BR6FS	4323		
5.0 L	8		1,0	BR6FS	4323		
5.7 Ski	8		1,0	BR6FS	4323		
5.7 L	8		1,0	BR6FS	4323		

**GM 427,454 &502**

325 2762442->	8		0,9	R5673-7	4367		
330	8		1,1	UR4	4762	UR4IX	7401
340	8		1,1	UR4	4762	UR4IX	7401
350	8		0,9	R5673-7	4367		
400 Jet	8		1,1	UR4	4762	UR4IX	7401
454 EFi, MP,,Mpi SKI	8		1,1	UR4	4762	UR4IX	7401
7.4 L Efi,MP,Mpi	8		1,1	UR4	4762	UR4IX	7401
7.4 L Hurth	8		1,1	UR4	4762	UR4IX	7401
7.4 L B-W	8		1,1	UR4	4762	UR4IX	7401
8.2 L Carbu. ,Mpi	8		1,1	UR4	4762	UR4IX	7401

**Jet Drive**

Sportjet 90		1993 - 1995	0,8	BZ7HS-10	3579		
Sportjet 120		1995 -	0,8	BZ7HS-10	3579		
Sportjet 120XR		1996 - 1997	0,8	BZ7HS-10	3579		
Sportjet 95XR		1996 - 1997	0,8	BZ7HS-10	3579		
Sportjet 175XR2		1997 -		BU8H	6431		
Sportjet 175XR2		1997 -		BU8H	6431		

**MCM Renault**

60	4		0,6	BR7HS	4122	BR7HIX	7067
80	4		0,9	GR5	7537	GR5IX	7214
90	4		0,9	GR5	7537	GR5IX	7214

**Mercury**

165 224cid	4		0,8	UR5	2139	UR5IX	7177
170 224cid	4		0,8	UR5	2139	UR5IX	7177
180 224cid	4		0,8	UR5	2139	UR5IX	7177
190 224cid	4		0,8	UR5	2139	UR5IX	7177
3.7L 224cid	4		0,8	UR5	2139	UR5IX	7177
3.7LX 224cid	4		0,8	UR5	2139	UR5IX	7177
470 224cid	4		0,8	UR5	2139	UR5IX	7177
485 224cid	4		0,8	UR5	2139	UR5IX	7177
488 224cid	4		0,8	UR5	2139	UR5IX	7177

**Mercury 224cid**

470 224cid	4		0,9	UR6	4079	UR6IX	7348
------------	---	--	-----	-----	------	-------	------

**Stern Drive-Ford 302 & 351**

215	8		0,8	AR6FS	3323		
225	8		0,8	AR6FS	3323		



Cyl.



Order No.

Iridium



Order No.

**MARINE REPOWER*****Stern Drive-Ford 302 & 351***

233 18mm Dia	8	0,8	AR6FS	3323		
255 ->4175498	8	0,8	AR6FS	3323		
255 14mm Dia 4175499->	8	1,1	UR4	4762	UR4IX	7401
255 18mm Dia 4175499->	8	0,8	AR6FS	3323		
888 14mm Dia 4169597->	8	1,1	UR4	4762	UR4IX	7401
888 ->4169596	8	0,8	AR6FS	3323		
888 18mm Dia 4169597->	8	0,8	AR6FS	3323		

***Stern Drive-GM 153***

110	4	0,9	BR6ES	4922		
120 ->3825578	4	0,9	BR6ES	4922		
120 3825579->	4	1,1	UR4	4762	UR4IX	7401
2.5L	4	1,1	UR4	4762	UR4IX	7401

***Stern Drive-GM 194, 230 & 292***

140	6	0,9	BR6ES	4922		
150	6	0,9	BR6ES	4922		
160	6	0,9	BR6ES	4922		
165 2771484->	6	1,1	UR4	4762	UR4IX	7401
165 ->2771483	6	0,9	BR6ES	4922		
200	6	0,9	BR6ES	4922		

***Stern Drive-GM 229***

185	6	1,1	UR4	4762	UR4IX	7401
-----	---	-----	-----	------	-------	------

***Stern Drive-GM 262***

175	6	1,1	UR4	4762	UR4IX	7401
185	6	1,1	UR4	4762	UR4IX	7401
262 Mag. OF80300-> Efi Gen+	6	1,1	TR4	4392	TR4IX	7300
4.3 LX Alpha ->OF80299	6	1,0	BR6FS	4323		
4.3 LX Alpha OF80300-> Gen+	6	1,1	BPR6EFS	3623	---	---
4.3 L Alpha ->OF80299	6	1,0	BR6FS	4323		
4.3 LXH Alpha OF80300-> Gen+	6	1,1	BPR6EFS	3623	---	---

***Stern Drive-GM 283, 305, 327 & 350***

190	8	0,9	XR5	5953	XR5IX	7355
200	8	1,0	BR6FS	4323		
225 -> 2278646	8	0,8	B7S	3710		
225 2278647->	8	0,9	XR5	5953	XR5IX	7355
228	8	1,0	BR6FS	4323		
230	8	1,0	BR6FS	4323		
250 4768000->	8	1,1	UR4	4762	UR4IX	7401
250 -> 2639854	8	0,8	B7S	3710		
255	8	1,1	UR4	4762	UR4IX	7401
260	8	1,0	BR6FS	4323		
270 Tapered Seat	8	0,9	R5673-7	4367		
270 Gasket Seat	8	0,8	B7S	3710		
280	8	1,1	UR4	4762	UR4IX	7401
300 Tempest	8	1,1	UR4	4762	UR4IX	7401





Cyl.

Order  
No.

Iridium

Order  
No.**MARINE REPOWER*****Stern Drive-GM 283, 305, 327 & 350***

320 Efi	8		1,1	UR4	4762	UR4IX	7401
350 Mag. No.OF602000-> Mpi Gen+	8		1,1	TR4	4392	TR4IX	7300
350 Magnum No.->OF602199 Efi, Mpi	8		1,0	BR6FS	4323		
350 Mag. No.OF800500-> Efi Gen+	8		1,1	TR4	4392	TR4IX	7300
350 Magnum Carburator	8		1,0	BR6FS	4323		
377 Scorpion OL416146->	8		1,1	TR4	4392	TR4IX	7300
5.0L Bravo	8		1,0	BR6FS	4323		
5.0L Alpha	8		1,0	BR6FS	4323		
5.0LX Alpha	8		1,0	BR6FS	4323		
5.0L Mpi	8	2002 -	1,1	TR4	4392	TR4IX	7300
5.7L, LX Bravo, Efi	8		1,0	BR6FS	4323		
5.7LX Bravo Gen+	8		1,1	TR4	4392	TR4IX	7300
5.7L, LX Alpha , Efi	8		1,0	BR6FS	4323		
898	8		1,0	BR6FS	4323		

***Stern Drive-GM 377***

6.2L MX Mpi	8		0,9	TR4	4392	TR4IX	7300
-------------	---	--	-----	-----	------	-------	------

***Stern Drive-GM 427, 454 & 482***

325 3043030->	8		0,9	R5673-7	4367		
330 B-W	8		1,1	UR4	4762	UR4IX	7401
330 No.3043030->	8		1,1	UR4	4762	UR4IX	7401
370	8		1,1	UR4	4762	UR4IX	7401
400	8		1,1	UR4	4762	UR4IX	7401
400 Cyclone	8		1,1	UR4	4762	UR4IX	7401
420	8		1,1	UR4	4762	UR4IX	7401
440 Cyclone	8		1,1	UR4	4762	UR4IX	7401
454 Magnum Alpha	8		1,1	UR4	4762	UR4IX	7401
454 Magnum Bravo	8		1,1	UR4	4762	UR4IX	7401
454 Magnum Efi, Mpi	8		1,1	UR4	4762	UR4IX	7401
460 Cyclone	8		0,9	R5673-7	4367		
475 Turbo	8		0,9	R5673-7	4367		
7.4LX Efi Bravo	8		1,0	BR6FS	4323		
7.4LTR No.OB771113->OC407646	8		1,0	BR6FS	4323		
7.4L Bravo 1,2&3	8		1,0	BR6FS	4323		
7.4L Alpha	8		1,0	BR6FS	4323		
7.4LX Mpi Bravo	8		1,0	BR6FS	4323		
HP 425	8		0,9	R5673-7	4367		
HP 450	8		0,9	R5673-7	4367		
HP 525SC	8		0,9	R5673-7	4367		

***Stern Drive-GM 502, 540 & 572***

502 Magnum Efi,Mp,Mpi	8		0,9	R5673-7	4367		
502 Magnum Carburator	8		0,9	R5673-7	4367		
HP 465	8		0,9	R5673-7	4367		
HP 500 (502cid)	8		0,9	R5673-7	4367		
HP 500 Bulldog (540cid)	8		0,9	R5673-7	4367		
HP 525SC (454cid)	8		0,9	R5673-7	4367		
HP 575	8		0,9	R5673-7	4367		
HP 600SC Bobtail	8		0,9	R5673-7	4367		



Cyl.

Order  
No.

Iridium

Order  
No.**MARINE REPOWER****Stern Drive-GM 502, 540 & 572**

HP 800SC (572cid)	8	0,9	R5673-7	4367		
HP 900SC	8	0,9	R5671A-9	7382		

**Stern Drive-GMI 181**

140 -> No.3826282	4	0,9	BR6ES	4922		
140 No. 3826283->	4	1,1	UR4	4762	UR4IX	7401
3.0L	4	1,1	UR4	4762	UR4IX	7401
3.0LX Alpha Delco EST Ign.	4	1,1	UR4	4762	UR4IX	7401
3.0LX Alpha Delco Digital Ign.	4	1,1	TR4	4392	TR4IX	7300

**MERCURY****273kW Racing Sterndrive**

Scorpion 377 6,2Ltr.	8	0,9	TR4	4392	TR4IX	7300
----------------------	---	-----	-----	------	-------	------

**350kW Racing Sterndrive**

HP500 EFI 8,2Ltr.	8	1,1	UR4	4762	UR4IX	7401
HP500 Bulldog 8,9Ltr.	8	0,9	R5673-7	4367		

**410kW Racing Sterndrive**

HP575 SCI 8,2Ltr.	8	0,9	R5673-7	4367		
-------------------	---	-----	---------	------	--	--

**Jet Drive**

90hp Sport Jet		1995 -	0,9	BZ7HS-10	3579	
95hp Sport Jet XR		1996 -	0,9	BZ7HS-10	3579	
120hp Sport Jet		1995 -	0,9	BZ7HS-10	3579	
120hp Sport Jet XR		1996 -	0,9	BZ7HS-10	3579	
175hp Sport Jet XR		1997 -		BUZ8H	7447	

**NISSAN Marine**

HA 120		1987 - 1989	0,9	BR6ES	4922	
--------	--	-------------	-----	-------	------	--

**O.M.C.**

AJ, 14mm Hds, 3/8" Rch. Inboard			0,9	XR5	5953	XR5IX	7355
AJ, 14mm Hds, Taper Seat Inboard			0,9	UR5	2139	UR5IX	7177
AT, 14mm Hds, 3/8" Rch. Inboard			0,9	XR5	5953	XR5IX	7355
AT, 14mm Hds, Taper Seat Inboard			0,9	UR5	2139	UR5IX	7177
TJ, 14mm Hds, 3/8" Rch. Inboard			0,9	XR5	5953	XR5IX	7355
TJ, 14mm Hds, Taper Seat Inboard			0,9	UR5	2139	UR5IX	7177
TT, 14mm Hds, 3/8" Rch. Inboard			0,9	XR5	5953	XR5IX	7355
TT, 14mm Hds, Taper Seat Inboard			0,9	UR5	2139	UR5IX	7177

**Jet Drive**

Turbojet 115			0,8	BZ7HS-10	3579	---	---
Turbojet 90			0,8	BZ7HS-10	3579	---	---

**Sail Drive**

15S10G		1977 - 1984	1,1	BPR6HS	7022	BPR6HIX	4085
15S10S		1977 - 1984	1,1	BPR6HS	7022	BPR6HIX	4085



Cyl.

Order  
No.

Iridium

Order  
No.**O.M.C.****Sail Drive**

15S11C	1977 - 1984	1,1	BPR6HS	7022	BPR6HIX	4085
15S13A	1977 - 1984	1,1	BPR6HS	7022	BPR6HIX	4085
15S14M	1977 - 1984	1,1	BPR6HS	7022	BPR6HIX	4085

**Sea Drive**

1.6L 115-SD	1985 - 1991	0,8	BZ7HS-10	3579	---	---
1.8L 140-SD	1985 - 1991	0,8	BZ7HS-10	3579	---	---
2.0L 140-SD	1985 - 1991	0,8	BZ7HS-10	3579	---	---
2.7L 225-SD	1987 -	0,8	BZ7HS-10	3579	---	---
3.0L 225-SD	1985 - 1991	0,8	BZ7HS-10	3579	---	---
3.6L 275-SD	1987 - 1981	0,8	BZ7HS-10	3579	---	---
4.0L 300-SD	1985 - 1991	0,8	BZ7HS-10	3579	---	---

**Stern Drive**

14mm Hds, 3/4" Rch.	1973 - 1974	0,9	B6ES	7310	---	---
14mm Hds, Taper Seat	1973 - 1985	0,9	UR5	2139	UR5IX	7177
18mm Hds, Taper Seat	1974 -	0,7	AR6FS	3323	---	---
2.3L Cobra Stern Drive	1987 - 1990	0,9	TR5	7837	TR5IX	7397
3.0L Cobra Stern Drive	1987 - 1992	1,1	UR4	4762	UR4IX	7401
3.0L Cobra Stern Drive	1993 - 1994	1,1	TR5	7837	TR5IX	7397
3.0L Cobra HO	1990 - 1995	1,1	TR5	7837	TR5IX	7397
4.3L Cobra	1986 - 1995	0,9	UR4	4762	UR4IX	7401
4.3L Cobra HO	1990 - 1991	0,9	UR4	4762	UR4IX	7401
4.3L Cobra HO	1993 - 1994	1,1	UR4	4762	UR4IX	7401
4.3L Stinger	1978 - 1986	0,8	UR4	4762	UR4IX	7401
480		0,7	B8S	3810	---	---
5.0L Cobra	1986 - 1995	0,9	UR4	4762	UR4IX	7401
5.0L Cobra EFI	1993 - 1995	1,1	TR5	7837	TR5IX	7397
5.0L Cobra HO	1989 - 1995	0,9	UR4	4762	UR4IX	7401
5.7L Cobra	1986 - 1992	0,9	UR4	4762	UR4IX	7401
5.7L K	1993 - 1995	1,1	UR4	4762	UR4IX	7401
5.7L King Cobra	1986 - 1992	0,9	UR4	4762	UR4IX	7401
5.8L Cobra	1989 - 1995	0,9	UR4	4762	UR4IX	7401
5.8L Cobra EFI	1992 - 1995	1,1	TR5	7837	TR5IX	7397
5.8L King Cobra EFI HO	1993 - 1995	1,1	TR5	7837	TR5IX	7397
7.4L Cobra	1990 - 1994	1,1	UR4	4762	UR4IX	7401
7.4L Cobra HO	1991 - 1993	1,1	UR4	4762	UR4IX	7401
7.4L King Cobra	1995 -	1,1	UR4	4762	UR4IX	7401
7.4L King Cobra EFI	1995 -	1,1	UR4	4762	UR4IX	7401
7.5L Cobra	1986 - 1990	0,9	UR4	4762	UR4IX	7401
8.2L King Cobra	1992 - 1994	1,1	UR4	4762	UR4IX	7401
CU		0,9	B6ES	7310	---	---
DU		0,7	B8S	3810	---	---
GU		0,9	B6ES	7310	---	---
HU		0,9	XR5	5953	XR5IX	7355
JU		0,9	BR6FS	4323	---	---
KU		0,9	B6S	3510	---	---
LU		0,9	B6ES	7310	---	---
NU		0,6	BP6ES	7811	BPR6EIX	6637
Stinger	1978 - 1986	0,9	UR4	4762	UR4IX	7401



Cyl.



Order No.

Iridium



Order No.

**O.M.C.**

**Stern Drive**

SU			0,9	B6ES	7310	---	---
TU-14			0,9	XR5	5953	XR5IX	7355
TU-15			0,9	XR5	5953	XR5IX	7355
TU-16			0,9	XR5	5953	XR5IX	7355
TU-17			0,9	B6S	3510	---	---
TU-20			0,9	BR6FS	4323	---	---
TU-21			0,9	BR6FS	4323	---	---
VU			0,9	B6ES	7310	---	---
WU			0,9	BR6FS	4323	---	---
XU-20C			0,9	BR6FS	4323	---	---
XU20S			0,9	B6S	3510	---	---

**PALMER-GREENW.**

M196 , M265 , M392			0,8	B6S	3510		
M304, M345, MKIV-115, MKVI-150			0,8	B6S	3510		
M549 , M345B , M392B			0,8	B6S	3510		
MKVIII: 200 , 225 , 275 , 300			0,8	B6S	3510		
P302 , P351			0,8	AP6FS	2710		
PA190 , PA220 , PA255			0,8	AR6FS	3323		
PA350			0,8	BPR5FS	2423		
PB-V-215 (V-8)	8		0,9	B6HS	4510	BR6HIX	3419
PW27 (14mm)			0,8	BP5S	3011		
PW27 (18mm)			0,8	A6	1010		
Y304 , Y345 , Y392			0,8	B6S	3510		

**PANTER**

400 Plus C		1976 - 1980	1,1	UR4	4762	UR4IX	7401
400 Plus-F		1976 - 1980	0,8	UR5	2139	UR5IX	7177
500 Plus		1976 - 1980	1,1	UR4	4762	UR4IX	7401
500 Plus-7		1978 - 1980	0,9	R5673-7	4367		
F 110		1978 - 1980	1,1	UR4	4762	UR4IX	7401
F 140		1978 - 1980	1,1	UR4	4762	UR4IX	7401
F 185		1976 - 1980	0,9	BPR5ES	7422	BPR5EIX	6597
F 235		1976 - 1980	0,9	BPR5ES	7422	BPR5EIX	6597
M 360		1976 - 1980	0,9	BPR5ES	7422	BPR5EIX	6597
M 405		1976 - 1980	1,1	UR4	4762	UR4IX	7401
M 454		1976 - 1980	1,1	UR4	4762	UR4IX	7401
M 460		1976 - 1980	0,8	UR5	2139	UR5IX	7177

**PCM**

150 cid			1,1	UR4	4762	UR4IX	7401
200 cid			1,1	UR4	4762	UR4IX	7401
220 cid			1,1	UR4	4762	UR4IX	7401
229 cid			1,1	UR4	4762	UR4IX	7401
230 cid			1,1	UR4	4762	UR4IX	7401
250 cid			1,1	UR4	4762	UR4IX	7401
280 cid			1,1	UR4	4762	UR4IX	7401
302 cid	14mm		1,1	UR4	4762	UR4IX	7401



Cyl.

Order  
No.

Iridium

Order  
No.**PCM**

302 cid	18mm		0,8	AR6FS	3323		
305 cid			1,1	UR4	4762	UR4IX	7401
350 cid			1,1	UR4	4762	UR4IX	7401
350 cid			1,1	UR4	4762	UR4IX	7401
351 cid	14mm		1,1	UR4	4762	UR4IX	7401
351 cid	18mm		0,8	AR6FS	3323		
454 cid			1,1	UR4	4762	UR4IX	7401
460 cid	14mm		1,1	UR4	4762	UR4IX	7401
460 cid	18mm		0,8	AR6FS	3323		
5.7L HO MPI			1,1	TR4	4392	TR4IX	7300
5.7L HO Ski TBI	275hp		1,1	UR4	4762	UR4IX	7401
5.8L Carburator	260hp		0,7	UR6	4079	UR6IX	7348
5.8L HO MPI	310hp		1,1	TR4	4392	TR4IX	7300
7.4L MPI			1,1	TR4	4392	TR4IX	7300
7.4L Carburator			1,1	UR4	4762	UR4IX	7401
7.4L HO TBI	350hp		1,1	UR4	4762	UR4IX	7401

**PERFORMANCE JET SYSTEM**

Viper 5000			0,8	BR8ES	5422	BR8EIX	5044
Viper 6000			0,8	BR8ES	5422	BR8EIX	5044
Viper 7000			0,8	BR8ES	5422	BR8EIX	5044
Viper 8000			0,8	BR8ES	5422	BR8EIX	5044
Viper 9000			0,8	BR8ES	5422	BR8EIX	5044

**PIAGGIO**

Idrogetto (2-cyl. + 3-cyl.)			0,5	B7ES	1111		
KS 150 , KS 200			0,6	B7ES	1111		

**PMC***Chrysler*

225 cid	Gasket Seat		0,9	BR6ES	4922		
225 cid	Tapered Seat		0,7	UR6	4079	UR6IX	7348
318 cid			0,9	BPR5ES	7422	BPR5EIX	6597
340 cid			0,9	GR5	7537	GR5IX	7214
360 cid			0,9	BPR5ES	7422	BPR5EIX	6597
440 cid			0,9	XR4	2637	XR4IX	7189

*Ford*

302 cid	14mm		1,1	UR4	4762	UR4IX	7401
302 cid	18mm		0,8	AR6FS	3323		
351 cid	14mm		1,1	UR4	4762	UR4IX	7401
351 cid	18mm		0,8	AR6FS	3323		
390 cid			0,8	WR5	1071	WR5IX	7510
460 cid	14mm		1,1	UR4	4762	UR4IX	7401
460 cid	18mm		0,8	AR6FS	3323		
5.8L HO EFI			0,9	BPR6EFS	3623		



Cyl.



Order No.

Iridium



Order No.

**PMC****GM**

229 cid	6		1,1	UR4	4762	UR4IX	7401
250 cid			0,7	BPR5FS	2423		
305 cid			1,1	UR4	4762	UR4IX	7401
307 cid Gasket Seat			1,0	XR4	2637	XR4IX	7189
307 cid Tapered Seat			1,1	UR4	4762	UR4IX	7401
350 cid			1,1	UR4	4762	UR4IX	7401
350 cid Efi			1,1	UR4	4762	UR4IX	7401
4.3L	6		1,1	UR4	4762	UR4IX	7401
454 cid			1,1	UR4	4762	UR4IX	7401

**POLARIS****Jet Drive**

Optimax 3.0L 250 h p EX2100/LE2100			1,1	PZFR5F-11	4363		
------------------------------------	--	--	-----	-----------	------	--	--

**POWER PRODUCTS**

626			0,6	B6S	3510		
1000			0,6	B4	3210		
3000			0,6	B6L	3212		

**REDLINE**

5.0L 302 cid			0,9	BPR6FS	2632	---	---
5.8L 351 cid			0,9	BPR6FS	2632	---	---
5.8L 351 cid HO			1,0	BPR6EFS	3623	---	---
7.5L 460 cid			0,9	BPR6FS	2632	---	---

**RENAULT/COUACH**

RC25 , RC30			0,6	BP6HS	4511	BPR6HIX	4085
RC6 , RC8 , RC15			0,6	A6	1010		

**REVLEY**

R225 , R300 , R401			0,9	BP5S	3011		
--------------------	--	--	-----	------	------	--	--

**ROLLS ROYCE**

LM 841			0,9	B6ES	7310		
V8 Marine	8		0,6	B6ES	7310		

**SALSBURY**

all models			0,6	B4	3210		
------------	--	--	-----	----	------	--	--

**SCRIPPS**

(14mm)			0,6	B6S	3510		
(18mm)			0,6	A6	1010		



Cyl.

Order  
No.

Iridium

Order  
No.**SEADRIVE**

1100			0,6	B6ES	7310		
------	--	--	-----	------	------	--	--

**SEAFARER**

Seafarer			0,5	B6ES	7310		
----------	--	--	-----	------	------	--	--

**SEAMASTER**

300 , 534			0,8	A6FS	2210		
-----------	--	--	-----	------	------	--	--

**ST.LAWRENCE**

(14mm)			0,6	B6L	3212		
(18mm)			0,6	A6	1010		

**STARBUCK BOATS**

350 cid			1,1	UR4	4762	UR4IX	7401
454 cid			0,9	UR5	2139	UR5IX	7177

**STOKES**

Willys Tornado			0,6	B6HS	4510	BR6HIX	3419
----------------	--	--	-----	------	------	--------	------

**STUART TURNER**

other models (14mm)			0,6	B6HS	4510	BR6HIX	3419
other models (18mm)			0,5	A6	1010		
P6 , P66 , R3M , ST4M			0,5	B6HS	4510	BR6HIX	3419

**TEMPEST**

Vedette Mk8			0,6	B6ES	7310		
-------------	--	--	-----	------	------	--	--

**TOYOTA**

Epic VT300i 4,0Ltr.	8		1,1	PFR5G-11	2647		
Epic 21 4.0L 300 hp			1,1	---	---	IFR6T-11	4589
Epic 22 4.0L 300 hp			1,1	---	---	IFR6T-11	4589
S22 4.0L 300 hp			1,1	---	---	IFR6T-11	4589
X22 4.0L 300 hp			1,1	---	---	IFR6T-11	4589

**TURBO MARINE****Ford**

104 cid		1973 -	0,9	GR5	7537	GR5IX	7214
302 cid Escort	8	1973 -	0,8	AR6FS	3323		

**Kohler**

K-399-2		1971 - 1973	0,8	A6	1010		
---------	--	-------------	-----	----	------	--	--



Cyl.



Order No.

Iridium



Order No.

**UNIVERSAL**

Arrow			0,9	B6S	3510	---	---
Atomic 1			0,9	B6S	3510	---	---
Atomic 2			0,9	B6S	3510	---	---
Atomic 3			0,9	B6S	3510	---	---
Atomic 4			0,9	B6S	3510	---	---
Atomic Stevedore			0,9	B6S	3510	---	---
Big King			0,9	WR5	1071	WR5IX	7510
Bluefin			0,9	B6S	3510	---	---
Bullit			0,9	B6S	3510	---	---
Colt			0,9	B6S	3510	---	---
DX Super Sabre			0,9	XR5	5953	XR5IX	7355
Elf			0,7	B6S	3510	---	---
Knight			0,7	B6S	3510	---	---
LEV 188 hp			0,7	B6S	3510	---	---
LEVH 188 hp			0,7	B6S	3510	---	---
Little King			0,7	B6S	3510	---	---
Marlin			0,7	B6S	3510	---	---
NKEV 277 hp			0,9	WR5	1071	WR5IX	7510
Sabre 198 cid 140 hp			0,9	XR5	5953	XR5IX	7355
Strato King			0,7	B6S	3510	---	---
Super Sabre 225 cid 155 hp			0,9	XR5	5953	XR5IX	7355
Tarpon			0,7	B6S	3510	---	---
Z-Drive			0,9	B6S	3510	---	---

**US MARINE**

181 F 3.0L			0,9	BR6ES	4922		
305 cid 5.0L 225 hp			0,9	BR6FS	4323		
305 K 5.0L			0,8	UR5	2139	UR5IX	7177
350 K 5.7L			1,1	UR4	4762	UR4IX	7401
351 cid 5.8L 240 hp			1,0	UR5	2139	UR5IX	7177
454 cid 7.4L 330 hp			0,9	BR6FS	4323		
454 7.5L			1,1	UR4	4762	UR4IX	7401

**VALMET**

BVRE (6 PS) , BVR (6 PS)			0,5	B6HS	4510	BR6HIX	3419
Vire 70E (7 PS)			0,7	B6HS	4510	BR6HIX	3419

**VOLVO PENTA****AQ Series**

80			0,8	BR6S	3522		
90			0,8	BR6HS	3922		
95 A			0,8	BPR6HS	7022	BPR6HIX	4085
95			0,8	BPR6HS	7022	BPR6HIX	4085
100			0,8	BPR6HS	7022	BPR6HIX	4085
105 A			0,8	BPR7HS	6422	BPR7HIX	5944
110			0,8	BPR7HS	6422	BPR7HIX	5944
115 A			0,8	BPR7HS	6422	BPR7HIX	5944
120 (B21)			0,9	GR5	7537	GR5IX	7214
120			0,8	BPR7HS	6422	BPR7HIX	5944





Cyl.

Order  
No.

Iridium

Order  
No.**VOLVO PENTA*****AQ Series***

125 A / B			0,9	GR5	7537	GR5IX	7214
130 / A / B / C / D			0,8	BPR7HS	6422	BPR7HIX	5944
131 / A / B / C / D			0,9	GR5	7537	GR5IX	7214
140 / A			0,9	GR5	7537	GR5IX	7214
145 / A / B			0,9	GR5	7537	GR5IX	7214
145			0,9	GR5	7537	GR5IX	7214
150 A / B			0,9	XR4	2637	XR4IX	7189
151 / A / B / C			0,9	GR5	7537	GR5IX	7214
165 A			0,8	BPR7HS	6422	BPR7HIX	5944
170 / A / B / C			0,8	BPR7HS	6422	BPR7HIX	5944
171 / A / C			0,9	GR5	7537	GR5IX	7214
175 / A			1,1	UR4	4762	UR4IX	7401
180			0,9	XR5	5953	XR5IX	7355
190 A Ford			0,6	AR6FS	3323		
190 Ford			1,1	UR4	4762	UR4IX	7401
200 / A / B / C / D / F			0,7	UR6	4079	UR6IX	7348
205 A			1,1	UR4	4762	UR4IX	7401
210 A No. 177315->			0,7	UR6	4079	UR6IX	7348
210 A -> No.177314			0,9	XR5	5953	XR5IX	7355
211 / A / DP			1,1	UR4	4762	UR4IX	7401
225 E / F			1,1	UR4	4762	UR4IX	7401
225 / A / C			0,7	UR6	4079	UR6IX	7348
225 D 305cid			1,0	BR6FS	4323		
230 A			0,9	BPR6ES	7822	BPR6EIX	6637
231 / DP			1,1	UR4	4762	UR4IX	7401
231 A / B			1,1	UR4	4762	UR4IX	7401
240 A Ford			0,7	UR5	2139	UR5IX	7177
255 B			0,7	UR6	4079	UR6IX	7348
260 A / B			1,1	UR4	4762	UR4IX	7401
271 A / B / C / D			1,1	UR4	4762	UR4IX	7401
271 / DP			1,1	UR4	4762	UR4IX	7401
280 A			0,7	UR6	4079	UR6IX	7348
290 A / B			1,1	UR4	4762	UR4IX	7401
311 A / B			1,1	UR4	4762	UR4IX	7401
430			1,1	UR4	4762	UR4IX	7401
500 A			1,1	UR4	4762	UR4IX	7401
501 A			1,1	UR4	4762	UR4IX	7401
531			1,1	UR4	4762	UR4IX	7401
570 A			1,1	UR4	4762	UR4IX	7401
571 A			1,1	UR4	4762	UR4IX	7401
572			1,1	UR4	4762	UR4IX	7401
740 A			1,1	UR4	4762	UR4IX	7401

***B / BB Series***

16 A / C			0,9	BP4	2911		
18 A / C			0,7	BR7HS	4122	BR7HIX	7067
25			0,8	BR6S	3522		
30 B			0,7	BR7HS	4122	BR7HIX	7067
70 sustained full throttle			0,8	B6S	3510		
70			0,8	BR6S	3522		
100 / A			0,8	BR6HS	3922		
115 / A / B			0,8	BPR7HS	6422	BPR7HIX	5944



Cyl.



Order No.

Iridium



Order No.

**VOLVO PENTA*****B / BB Series***

140		0,8	BPR7HS	6422	BPR7HIX	5944
145 / A		0,9	BPR6ES	7822	BPR6EIX	6637
165 A		0,8	BPR7HS	6422	BPR7HIX	5944
170 A / B / C		0,8	BPR7HS	6422	BPR7HIX	5944
225 A / B / C		1,1	UR4	4762	UR4IX	7401
231 A		1,1	UR4	4762	UR4IX	7401
260 A / B / C		1,1	UR4	4762	UR4IX	7401
261		1,1	UR4	4762	UR4IX	7401

***C Series***

C5		0,7	A7	1110		
C10		0,7	A7	1110		
C23		0,7	A7	1110		

***DP Series***

4.3L GIPNCA. 460" Reach		1,1	UR4	4762	UR4IX	7401
4.3L GIPNCS. 708" Reach		0,9	TR4	4392	TR4IX	7300
5.0L Fi		0,9	TR4	4392	TR4IX	7300
5.0L FL		1,1	UR4	4762	UR4IX	7401
5.7L Gsi		0,9	TR4	4392	TR4IX	7300
5.7L Gi / GL / GLi / GS		1,1	UR4	4762	UR4IX	7401
5.8L FL		1,1	UR4	4762	UR4IX	7401
5.8L Fsi		0,9	BPR6EFS	3623		
7.4L Gi / GL		1,1	UR4	4762	UR4IX	7401
8.2L GSi		1,1	UR4	4762	UR4IX	7401

***DPX Series***

7.4L DPX 385		1,1	UR4	4762	UR4IX	7401
8.2L 600		0,9	R5673-7	4367		
8.2L 500		0,9	R5673-7	4367		
8.2L 525		0,9	R5673-7	4367		
8.2L DPX 415		1,1	UR4	4762	UR4IX	7401

***Inboard Series***

5.8L FSi / HS1		0,9	BPR6EFS	3623		
5.7L Gsi / Gxi	2002 -	1,1	TR4	4392	TR4IX	7300
5.7L Gi	2002 -	1,1	UR4	4762	UR4IX	7401
5.8L FL / HS1		1,1	UR4	4762	UR4IX	7401
7.4L GL / Gi / HS1		1,1	UR4	4762	UR4IX	7401
8.1L Gi / Gsi	2002 -	1,1	TR4	4392	TR4IX	7300
8.2L GL / HS1	2002 -	1,1	UR4	4762	UR4IX	7401

***M Series***

AQ 60 F Kerosine engine		0,9	B5HS	4210		
B 18 F Kerosine engine		0,9	B5HS	4210		
BB 30 F Kerosine engine		0,9	B5HS	4210		
MB 10 / A		0,6	BP5HS	4111		
MB 20 / A / B / C		0,8	BPR6HS	7022	BPR6HIX	4085
MB 36 / A / B		0,9	XR5	5953	XR5IX	7355



Cyl.

Order  
No.

Iridium

Order  
No.**VOLVO PENTA*****M Series***

MB 250S Sail Drive			0,6	D6HA	6512		
PZ-200 I / O W / Chevrolet 305 cid			1,1	UR4	4762	UR4IX	7401

***Ocean Series***

4.3L OSi-XDP GM V-6	6	2002 -	0,9	TR4	4392	TR4IX	7300
5.0L OSi-XDP GM V-8	8	2002 -	0,9	TR4	4392	TR4IX	7300
5.7L OXSi-XDP GM V-8	8	2002 -	0,9	TR4	4392	TR4IX	7300
5.7L OSi-XDP GM V-8	8	2002 -	0,9	TR4	4392	TR4IX	7300

***PJX Water Jet***

4.3L Gi / GS			1,1	UR4	4762	UR4IX	7401
--------------	--	--	-----	-----	------	-------	------

***SX Cobra Series***

3.0L GS			1,1	TR4	4392	TR4IX	7300
4.3L GIPNCS. 708" Reach			1,1	TR4	4392	TR4IX	7300
4.3L GIPNCA. 460" Reach			1,1	UR4	4762	UR4IX	7401
5.0L FL			1,1	UR4	4762	UR4IX	7401
5.0L Fi			1,1	TR4	4392	TR4IX	7300
5.7L Gsi			1,1	TR4	4392	TR4IX	7300
5.7L Gi / GL / GLi / GS			1,1	UR4	4762	UR4IX	7401
5.8L FL			1,1	UR4	4762	UR4IX	7401
5.8L Fi / Fsi			0,9	BPR6EFS	3623		
7.4L Gi / GL / Gsi			1,1	UR4	4762	UR4IX	7401
8.2L Gsi			1,1	UR4	4762	UR4IX	7401

**VW**

SDI 45-4	4	2001 -		Y-732U	2408		
SDI 50-4	4			Y-732U	2408		
SDI 55-5	5	2001 -		Y-732U	2408		
SDI 60-4	4	2001 -		Y-732U	2408		
SDI 75-5	5	2001 -		Y-732U	2408		
TDI 100-5	5	2001 -		Y-732U	2408		
TDI 115-4	4	2001 -		Y-732U	2408		
TDI 120-5	5			Y-732U	2408		
TDI 150-5	5	2001 -		Y-732U	2408		
TDI 165-5	5			Y-732U	2408		
TDI 225-6	6			Y-732U	2408		

**WAUKESHA**

155 hp / WAR / WLA / 302/2B			0,8	AR6FS	3323		
165 hp / WRE / WLE			0,8	AR6FS	3323		
165 hp / 302/2A			0,8	AR6FS	3323		
185 hp / WRB / WLB			0,8	AR6FS	3323		
185 hp / 302/ 2			0,8	AR6FS	3323		
215 hp / WRC / WLC /302/4			0,8	AR6FS	3323		
255 hp / WRD / WLD /351/4			0,8	AR6FS	3323		
350 hp / 460/4			0,9	UR5	2139	UR5IX	7177
350 hp / WRF / WLF			0,9	UR5	2139	UR5IX	7177



Cyl.

Order  
No.

Iridium

Order  
No.**WEST BEND**

Shark-o-Matic

0,8

BR6S

3522

**WICKSTROM**

W 1 / 2 / 3

0,7

A6

1010

**WORTHAM BLAKE**

Dolphin V6

6

0,5

GR5

7537

GR5IX

7214

Dolphin Mk.2

4

0,9

BPR5ES

7422

BPR5EIX

6597

Fisherboy 4 OHV

4

0,5

GR5

7537

GR5IX

7214

Fisherboy 4 SV

0,6

B6HS

4510

BR6HIX

3419

Sprite

4

0,9

BPR5ES

7422

BPR5EIX

6597

Sprite 4

4

0,9

GR5

7537

GR5IX

7214

**YAMAHA**

AR 210 1200cc

2003 -

0,8

BR8HS

4322

BR8HIX

7001

AR 230 1100cc

2003 -

0,8

CR9EB

6955

Exciter 135 1200cc

1998 - 1999

0,8

BR8HS

4322

BR8HIX

7001

Exciter 220 1100cc

1996 - 1998

0,8

BR8HS

4322

BR8HIX

7001

Exciter 227 1200cc

1998 - 1999

0,8

BR8HS

4322

BR8HIX

7001

LS 2000 1200cc

1999 -

0,8

BR8HS

4322

BR8HIX

7001

LS 210 1200cc

2003 -

0,8

BR8HS

4322

BR8HIX

7001

LX 2000 1200cc

2002 -

0,8

BR8HS

4322

BR8HIX

7001

LX 210 1200cc

2003 -

0,8

BR8HS

4322

BR8HIX

7001

SR 230 999cc

2003 -

0,8

CR9EB

6955

SR 230 1100cc

2003 -

0,8

CR9EB

6955

SX 230 1100cc

2003 -

0,8

CR9EB

6955

XR 1800 1200cc

2000 - 2001

1,0

BR8HS-10

1134

***Stern Drive***

L4 3.0L All

4

0,8

BR6FS

4323

V6 All

6

0,8

BR6FS

4323

V8 All

8

0,8

BR6FS

4323



Cyl.

Order  
No.

Iridium

Order  
No.**AERO MARINE**

AM 4000	4 PS	1970 - 1973	0,9	BP5S	3011		
AM 5000 M, AM 5000 E	5 PS	1970 - 1972	0,9	B6L	3212		
AM 7500M, AM 7500E	7,5 PS	1970 - 1973	0,9	BM6A	5921		
AM 9000	9 PS	1971 - 1973	0,6	BM6A	5921		
Jet Pak		1971 - 1973	0,9	BP5S	3011		

**AILSA CRAIG**

AL-23			0,6	A6	1010		
0-11, 0-21, 0-22, 0-41, 0-411			0,6	A6	1010		

**AIRBOY**

120			0,8	B6L	3212		
20, 40, 90 (B S)			0,8	B6S	3510		
50			0,8	B6S	3510		
90 (OMC)			0,8	AP5FS	2610		

**ALSPORT**

14mm			0,8	BR6HS	3922	BR6HIX	3419
18mm			0,8	A7	1110		

**APACHE**

J 5			0,8	BR6S	3522		
J 9			0,8	BR6S	3522		

**ARKOS**

Aquascooter			0,5	B6HS	4510	BR6HIX	3419
-------------	--	--	-----	------	------	--------	------

**ARROW**

4, 5.5, 7.5 PS			0,5	BP5S	3011		
----------------	--	--	-----	------	------	--	--

**BEAVER**

2.0 hp			0,8	BR6S	3522		
4.0 hp			0,7	BM4A	5628		
5.5 hp			0,7	XR4	2637	XR4IX	7189
7.5 hp			0,7	XR4	2637	XR4IX	7189
9.0 hp			0,7	XR4	2637	XR4IX	7189

**BIANCHI**

125 CC			0,5	B6S	3510		
--------	--	--	-----	-----	------	--	--



Cyl.



Order No.

Iridium



Order No.

**BLUEJET**

3.5 hp	1961 -	0,8	BR6S	3522		
5.0 hp	1963 -	0,7	BM4A	5628		

**BOATIMPELLER**

all models		0,5	A6	1010		
------------	--	-----	----	------	--	--

**BOMBARDIER**

Speedster 20	Mot. 1503	0,7	DCPR8E	4339	DCPR8EIX	6546
Sportster 4-TEC	Mot. 1503	0,7	DCPR8E	4339	DCPR8EIX	6546
Sportster LE-Di	Mot. 947Di	1,1	ZFR4F-11	4043		

**BRIT. SEAGULL**

125, 160, 170		0,8	B7ES	1111		
45, 55, 60, 75, 80, 90		0,5	A6	1010		
Century, /Plus, Featherweight		0,5	A6	1010		
Century, /Plus, Featherweight		0,5	A6	1010		
Forty Plus (CD ign. -'80)		0,5	A6	1010		
Forty Plus (Magneto ign. -'80)		0,5	A6	1010		
Minor BM		0,5	B6HS	4510	BR6HIX	3419
QB serie: Curlew, Osprey		0,8	B7ES	1111		
QB serie: Kingfisher		0,8	B7ES	1111		

**BRITISH ANZANI**

180	18 PS	0,7	B6L	3212		
65		0,7	B6S	3510		
Fleetwin, Unitwin, 400		0,6	B6HS	4510	BR6HIX	3419
Pilot 1, 2, 3, 4		0,6	B6HS	4510	BR6HIX	3419
Pilot 30 Minor Seamaid, Jet 3		0,6	B6HS	4510	BR6HIX	3419
Seasprite, Supertwin, Magnitwin		0,6	B6HS	4510	BR6HIX	3419
Super Single, Super Snipe		0,6	A6	1010		
Triton		0,6	B6ES	7310		

**CAL-JET**

Econojet, Ramjet		0,8	B6S	3510		
------------------	--	-----	-----	------	--	--

**CARNITI**

18, 280CN, 45, 55, 65, 80		0,5	B8HS	5510	BR8HIX	7001
25, 40, 50, 70, 85, 100 PS		0,5	B6HS	4510	BR6HIX	3419
3, 3.5, 5, 8, 9.5, 15, 20 PS		0,5	B6HS	4510	BR6HIX	3419
45S, 65S, 80S		0,8	B9HS	5810		
700Sport, 850Sport, 1000Sport		0,5	B8HS	5510	BR8HIX	7001



Cyl.

Order  
No.

Iridium

Order  
No.**CARNITS**

90.0 hp			0,8	BR6HS	3922	BR6HIX	3419
---------	--	--	-----	-------	------	--------	------

**CHIEF**

J-200/300/350/400/500/700			0,8	BM6A	5921		
J-5			0,8	BM6A	5921		
J-9			0,8	BP5S	3011		
K-150/200/300/400/990			0,8	BM6A	5921		
K-201	1976 - 1978		0,6	BP5S	3011		
K-350	1976 - 1978		0,6	BM6A	5921		
K-500, K-700, K-750	1974 - 1975		0,8	BP5S	3011		
K-500, K-700, K-750	1973 -		0,8	BM6A	5921		
K-505, K-550, K-751	1976 - 1978		0,6	BP5S	3011		
K-753, K-900	1976 - 1978		0,6	BP5S	3011		

**CHRIS-CRAFT**

Challenger, Commander			0,7	B6S	3510		
-----------------------	--	--	-----	-----	------	--	--

**CHRYSLER**

3.5PS Economate Std.Ign.	1980 - 1986		0,8	BR6HS	3922	BR6HIX	3419
4.0PS	1976 - 1986		0,8	BR6HS	3922	BR6HIX	3419
5.0PS	1974 - 1976		0,8	BR5HS	3722		
6.0PS	1971 - 1977		0,8	BR6HS	3922	BR6HIX	3419
6.0PS	1978 - 1986		0,8	BR6HS	3922	BR6HIX	3419
7.5PS	1978 - 1983		0,8	BR6HS	3922	BR6HIX	3419
8.0PS	1978 - 1981		0,8	BR6HS	3922	BR6HIX	3419
8.0PS	1971 - 1977		0,8	B7HS	5110	BR7HIX	7067
9.9PS	1968 - 1986		0,8	BR6HS	3922	BR6HIX	3419
4.4PS	1968 -		0,8	BR6HS	3922	BR6HIX	3419
4.5PS	1972 -		0,8	BR6HS	3922	BR6HIX	3419
4.9PS	1973 - 1975		0,8	BR5HS	3722		
5.0PS	1969 - 1970		0,8	BR6HS	3922	BR6HIX	3419
6.0PS	1965 - 1967		0,8	BR5HS	3722		
6.6PS	1968 -		0,8	BR6HS	3922	BR6HIX	3419
7.0PS	1969 - 1970		0,8	BR6HS	3922	BR6HIX	3419
9.0PS	1965 -		0,8	BR6S	3522		
9.2PS	1966 - 1967		0,8	BR6S	3522		
10.0PS	1974 - 1978		0,8	BR6HS	3922	BR6HIX	3419
12.9PS	1971 - 1973		0,8	BR6HS	3922	BR6HIX	3419
12PS	1979		0,8	BR6HS	3922	BR6HIX	3419
15PS	1974 - 1984		0,8	BR6HS	3922	BR6HIX	3419
20PS	1968 - 1982		0,8	BR6HS	3922	BR6HIX	3419
20PS	1965 - 1967		0,8	BR6S	3522		
25PS	1973 - 1984		0,8	BR6HS	3922	BR6HIX	3419
30PS	1973 - 1982		0,8	BR6HS	3922	BR6HIX	3419
35PS	1968 - 1984		0,8	BR6HS	3922	BR6HIX	3419
35PS	1965 - 1967		0,8	BR6S	3522		
45PS Magneto	1971 - 1978		0,8	BR6HS	3922	BR6HIX	3419
45PS	1968 - 1984		0,8	BR6HS	3922	BR6HIX	3419



Cyl.



Order No.

Iridium



Order No.

**CHRYSLER**

45PS	1965 - 1967	0,8	BR6S	3522		
50PS	1981 - 1984	0,8	BR6HS	3922	BR6HIX	3419
50PS	1965 - 1966	0,8	BR6S	3522		
55PS Std Ign	1967 - 1976	0,8	B6HS	4510	BR6HIX	3419
55PS Magneto	1969 - 1980		BUHX	2522		
55PS	1980 - 1983		BUHW	2622		
60PS	1974 - 1976		BUHX	2522		
60PS	1984 -		BUHW	2622		
65PS	1977 - 1978		BUHX	2522		
70PS	1979 - 1980		BUHW	2622		
70PS	1969 - 1973		BUHW	2622		
75PS	1966 - 1967	0,8	BR6S	3522		
75PS	1974 - 1984		BUHW	2622		
75PS	1968 -		BUHX	2522		
80PS	1965 -	0,8	BR6S	3522		
85PS	1969 - 1973		BUHW	2622		
85PS	1977 - 1984		BUHW	2622		
90PS	1983 - 1984		BUHW	2622		
90PS	1974 - 1977		BUHW	2622		
100PS	1979 - 1984		BUHW	2622		
105PS	1968 - 1974		BUHW	2622		
105PS	1975 - 1976		BUHX	2522		
105PS	1976 - 1983		BUHW	2622		
105PS	1966 - 1967	0,8	BR6S	3522		
115PS	1983 - 1984		BUHX	2522		
115PS	1977 - 1982		BUHW	2622		
120PS	1977 - 1982		BUHW	2622		
125PS	1981 -		BUHX	2522		
130PS	1972 - 1973		BUHW	2622		
135PS	1969 - 1971		BUHW	2622		
135PS	1974 - 1977		BUHW	2622		
140PS	1978 - 1984		BUHW	2622		
150PS	1972 - 1976		BUHW	2622		

**CLINTON**

AJ-9, BJ-9, J-200, J-300		0,8	BM6A	5921		
J-350/400/500/700		0,8	BM6A	5921		
J-5		0,8	BM6A	5921		
J-7, J-8		0,8	B6L	3212		
J-9		0,8	B2	3110		
K-150	1976 - 1978	0,6	BM7A	6521		
K-150/200/300/400/990		0,8	BM6A	5921		
K-201	1976 - 1978	0,6	B2	3110		
K-350	1976 - 1978	0,6	BM6A	5921		
K-500, K-700, K-750	1974 - 1975	0,8	BP5S	3011		
K-500, K-700, K-750	1973 -	0,8	BM6A	5921		
K-505, K-550, K-751	1976 - 1978	0,6	BP5S	3011		
K-753, K-900	1976 - 1978	0,6	BP5S	3011		
W-100, W-140, W-250		0,6	B6HS	4510	BR6HIX	3419





Cyl.

Order  
No.

Iridium

Order  
No.**COAST TO COAST**

4.6 hp

1965 -

0,8

BR6S

3522

**COLT**

3.0 hp

1963 -

0,8

BR6S

3522

5.0 hp

1963 -

0,9

BM4A

5628

**COMMODORE**

18.0 hp

0,8

BR6S

3522

40.0 hp

0,8

BR6S

3522

**COV. CLIMAX**

FWA Mk.III, PPF

0,6

B8ES

2411

BR8EIX

5044

FWM 750 cc

0,6

B6ES

7310

**COV. VICTOR**

14 mm, M14 x 12,7

0,6

B6HS

4510

BR6HIX

3419

14 mm, M14 x 19

0,6

B6ES

7310

18 mm, M18 X 12

0,5

A6

1010

**CRUISE N`CARRY**

1.5 hp

1981 - 1988

0,7

BM4A

5628

*Xenoah Engines*

1.75 hp

0,8

BR6S

3522

2.5 hp

1984 - 1988

0,8

BR6S

3522

6.0 hp

0,7

BPR5HS

6222

**CUYUNA**

40 hp

0,8

BR8ES

5422

BR8EIX

5044

**DELFINO**

2.5, 3 PS

0,5

B6S

3510

**DM**

DM 5 219cid

0,8

B5HS

4210

**DUCATI**

100, 150, 200

0,5

B6HS

4510

BR6HIX

3419

Bambi 30

0,6

B6HS

4510

BR6HIX

3419



Cyl.



Order No.

Iridium



Order No.

**DUCATI**

Cucciolo 5, 10, 15, 20 PS

0,5

B6HS

4510

BR6HIX

3419

**DYNAFOIL***Xenoah Engines*

340 cc 3/4 Rch

0,8

BR6ES

4922

440 cc 3/4 Rch

0,8

BR6ES

4922

**ELGIN**

3.5 hp 60900

0,9

BM4A

5628

3.5 hp 6092

0,9

BM4A

5628

3.5 hp 6091

0,9

BM4A

5628

9.0 hp 6067

0,9

BM4A

5628

9.0 hp 6066

0,9

BM4A

5628

12 hp 6012

1,0

BR6S

3522

14 hp 6015

1,0

BR6S

3522

14 hp 6069

1,0

BR6S

3522

14 hp 6013

1,0

BR6S

3522

14 hp 6014

1,0

BR6S

3522

18 hp 59671

1,0

BR6S

3522

18 hp 59661

1,0

BR6S

3522

25 hp 6025

1,0

BR6S

3522

25 hp 6028

1,0

BR6S

3522

25 hp 6032

1,0

BR6S

3522

27.7 hp 6033

1,0

BR6S

3522

27.7 hp 6035

1,0

BR6S

3522

28 hp 6034

1,0

BR6S

3522

28 hp 6070

1,0

BR6S

3522

28 hp 6038

1,0

BR6S

3522

28 hp 6036

1,0

BR6S

3522

28 hp 6037

1,0

BR6S

3522

40 hp 594031

1,0

BR6S

3522

40 hp 6040

1,0

BR6S

3522

40 hp 59461

1,0

BR6S

3522

40 hp 6043

1,0

BR6S

3522

40 hp 59421

1,0

BR6S

3522

40 hp 6047

1,0

BR6S

3522

40 hp 594001

1,0

BR6S

3522

40 hp 594011

1,0

BR6S

3522

40 hp 59471

1,0

BR6S

3522

43.7 hp 6053

1,0

BR6S

3522

43.7 hp 6052

1,0

BR6S

3522

45 hp 6057

1,0

BR6S

3522

45 hp 6062

1,0

BR6S

3522

45 hp 6056

1,0

BR6S

3522

45 hp 6055

1,0

BR6S

3522

45 hp 6054

1,0

BR6S

3522

45 hp 6063

1,0

BR6S

3522

60 hp 6060

1,0

BR6S

3522

60 hp 6061

1,0

BR6S

3522

60 hp 6062

1,0

BR6S

3522



Cyl.

Order  
No.

Iridium

Order  
No.**ELGIN**

60 hp 6063			1,0	BR6S	3522		
75 hp 6075			1,0	BR6S	3522		
75 hp 6074			1,0	BR6S	3522		
75 hp 6076			1,0	BR6S	3522		
75 hp 6064			1,0	BR6S	3522		
75 hp 6077			1,0	BR6S	3522		
75 hp 6065			1,0	BR6S	3522		
75.2 hp 6072			1,0	BR6S	3522		
75.2 hp 6073			1,0	BR6S	3522		

**ELLIOTT**

21.1 cc			0,7	BM4A	5628		
40 cc 2.2hp			0,8	BPM6A	7021		

**EMERALD BAY**

80 hp Banshee XS		1996 -	0,9	B8ES	2411	BR8EIX	5044
50 hp Banshee XS		1996 -	0,9	B8ES	2411	BR8EIX	5044

**ESKA**

1.2, 2.5 PS		1977 - 1978	0,6	BR6S	3522		
1707, 1747, 1777, 1790		1970 - 1974	0,8	BP5S	3011		
3.0, 4.5, 5.5 PS		1975 -	0,8	BP5S	3011		
3.0, 4.5, 5.5, 9.9 PS		1976 -	0,8	XR5	5953	XR5IX	7355
3.5, 4.0, 5.0 PS		1977 - 1978	0,8	XR5	5953	XR5IX	7355
3.5, 5.0, 7.5 PS		1970 - 1974	0,8	BP5S	3011		
7.5, 9.9, 15 PS		1975 -	0,8	BP5S	3011		
7.5, 9.9, 15 PS		1977 - 1978	0,8	XR5	5953	XR5IX	7355
9.5, 14 PS		1970 - 1974	0,8	BP5S	3011		

**EVINRUDE**

2.0 hp	1	1991 - 1997	0,8	BPR6HS	7022	BPR6HIX	4085
2.0 hp Jr, Colt	1	1971 - 1990	0,8	BR6S	3522		
2.3 hp	1	1991 - 1997	0,8	BPR6HS	7022	BPR6HIX	4085
2.5 hp	1	1987 - 1988	0,8	BR6HS	3922	BR6HIX	3419
3.0 hp	2	1989 - 1997	0,8	BR6HS	3922	BR6HIX	3419
3.3 hp	1	1991 - 1997	0,8	BPR6HS	7022	BPR6HIX	4085
4.0 hp	1	1969 - 1976	0,8	BR6S	3522		
4.0 hp	1	1977 - 1987	0,8	BR6HS	3922	BR6HIX	3419
4.0 hp	2	1989 - 1997	0,8	BR6HS	3922	BR6HIX	3419
4.0 hp		1988 -	0,8	BZ7HS-10	3579		
4.5 hp		1980 - 1985	0,8	BR6HS	3922	BR6HIX	3419
5.0 hp (4-stroke) OHC 128cc		1997 -	0,7	DR5HS	4623		
5.0 hp		1990 - 1997	0,8	BR6HS	3922	BR6HIX	3419
5.0 hp (4-stroke)		1997 -	0,7	D6HA	6512		
6.0 hp (2-stroke)		1977 - 1997	0,8	BR6HS	3922	BR6HIX	3419
6.0 hp (4-stroke)		1997 -	0,7	D6HA	6512		



Cyl.



Order No.

Iridium



Order No.

**EVINRUDE**

6.0 hp (4-stroke) OHC 128cc		1997 -	0,7	DR5HS	4623		
6.5 hp COM.		1981 - 1993	0,8	BZ7HS-10	3579		
7.5 hp		1977 - 1997	0,8	BR6HS	3922	BR6HIX	3419
8.0 hp (4-stroke) OHC 211cc		1996 -	0,7	DR5HS	4623		
8.0 hp (4-stroke)		1995 - 1997	0,7	D6HA	6512		
8.0 hp COM.		1977 - 1997	0,8	BR6HS	3922	BR6HIX	3419
8.0 hp		1977 -	0,8	BR6HS	3922	BR6HIX	3419
9.9 hp		1974 1976	0,8	B7HS	5110	BR7HIX	7067
9.9 hp (2-stroke)		1977 - 1997	0,8	BR6HS	3922	BR6HIX	3419
9.9 hp (4-stroke) OHC 305cc		1998 -	0,8	DCPR7E	3932	DCPR7EIX	6046
9.9 hp (4-stroke) OHC		1995 - 1997	0,8	DCPR7E	3932	DCPR7EIX	6046
9.9 hp (4-stroke) 211cc		1996 - 1997	0,7	D6HA	6512		
10.0 hp		1994 - 1997	0,8	BR6HS	3922	BR6HIX	3419
10.0 hp COM.		1992 - 1993	0,8	BZ7HS-10	3579		
14.0 hp		1992 - 1993	0,8	BZ7HS-10	3579		
14.0 hp COM.		1981 - 1991	0,8	BZ7HS-10	3579		
15.0 hp (2-stroke)		1994 - 1997	0,8	BR6HS	3922	BR6HIX	3419
15.0 hp		1977 - 1992	0,8	BZ7HS-10	3579		
15.0 hp COM.		1992 - 1993	0,8	BZ7HS-10	3579		
15.0 hp		1974 - 1976	0,8	B7HS	5110	BR7HIX	7067
15.0 hp COM.		1994 - 1997	0,8	BR6HS	3922	BR6HIX	3419
15.0 hp Kero		1995 - 1997		BUHXW-1	5526		
15.0 hp (4-stroke) OHC		1995 -	0,8	DCPR7E	3932	DCPR7EIX	6046
18.0 hp Jet	2	1995 - 1997	0,8	BR6HS	3922	BR6HIX	3419
18.0 hp		1957 - 1973	0,8	BR6S	3522		
20.0 hp		1978 - 1993	0,8	BR6HS	3922	BR6HIX	3419
20.0 hp	2	1978 - 1997	0,8	BR6HS	3922	BR6HIX	3419
25.0 hp	3	1995 - 1997	0,8	BR6HS	3922	BR6HIX	3419
25.0 hp	2	1977 - 1997	0,8	BR6HS	3922	BR6HIX	3419
25.0 hp	2	1977 -	0,8	BR6HS	3922	BR6HIX	3419
25.0 hp	3	1998 -	0,8	BR6HS	3922	BR6HIX	3419
25.0 hp COM.		1981 - 1997		BUHXW-1	5526		
28.0 hp	2	1978 - 1997	0,8	BR6HS	3922	BR6HIX	3419
28.0 hp Jet		1992 - 1997	0,8	BPR7HS	6422	BPR7HIX	5944
30.0 hp	2	1978 - 1997	0,8	BR6HS	3922	BR6HIX	3419
30.0 hp		2002 -	0,7	DCPR7E	3932	DCPR7EIX	6046
35.0 hp Jet	2	1993 - 1997	0,8	BPR7HS	6422	BPR7HIX	5944
35.0 hp		1976 -	0,8	B7HS	5110	BR7HIX	7067
35.0 hp	2	1977 - 1997	0,8	BZ7HS-10	3579		
35.0 hp	3	1995 - 1997	0,8	BR6HS	3922	BR6HIX	3419
35.0 hp	3	1998 -	0,8	BR6HS	3922	BR6HIX	3419
40.0 hp	2	1989 - 1997	0,8	BPR7HS	6422	BPR7HIX	5944
40.0 hp COM. 45cid		1984 - 1997		BUHXW-1	5526		
40.0 hp (4-stroke) DOHC 815cc		1999 -	0,8	DCPR7E	3932	DCPR7EIX	6046
40.0 hp		1974 - 1976	0,8	B7HS	5110	BR7HIX	7067
40.0 hp	2	1980 - 1988	0,8	BZ7HS-10	3579		
40.0 hp COM. 43cid		1981 - 1990	0,8	B7HS	5110	BR7HIX	7067
45.0 hp COM.		1986 - 1997		BUHXW-1	5526		
48.0 hp	2	1980 - 1988	0,8	BZ7HS-10	3579		
48.0 hp	2	1989 - 1997	0,8	BPR7HS	6422	BPR7HIX	5944
48.0 hp SPL	2	1994 - 1997	0,8	BPR7HS	6422	BPR7HIX	5944
50.0 hp (4-stroke) DOHC 815cc		1999 -	0,8	DCPR7E	3932	DCPR7EIX	6046



Cyl.



Order No.

Iridium



Order No.

**EVINRUDE**

50.0 hp	2	1989 - 1997	0,8	<b>BPR7HS</b>	<b>6422</b>	<b>BPR7HIX</b>	<b>5944</b>
50.0 hp		1971 - 1975	0,8	<b>BZ7HS-10</b>	<b>3579</b>		
50.0 hp	2	1980 - 1988	0,8	<b>BZ7HS-10</b>	<b>3579</b>		
50.0 hp	3	1995 - 1997	0,8	<b>BPR7HS</b>	<b>6422</b>	<b>BPR7HIX</b>	<b>5944</b>
55.0 hp	2	1976 - 1989	0,8	<b>BZ7HS-10</b>	<b>3579</b>		
55.0 hp	3	1968 - 1969	0,8	<b>BZ7HS-10</b>	<b>3579</b>		
55.0 hp COM.		1986 - 1997		<b>BUHXW-1</b>	<b>5526</b>		
55.0 hp COM.	2	1994 - 1995	0,8	<b>BPR7HS</b>	<b>6422</b>	<b>BPR7HIX</b>	<b>5944</b>
60.0 hp 56cid	3	1994 - 1997	0,8	<b>BPR7HS</b>	<b>6422</b>	<b>BPR7HIX</b>	<b>5944</b>
60.0 hp	3	1970 - 1971	0,8	<b>BZ7HS-10</b>	<b>3579</b>		
60.0 hp	2	1980 - 1985	0,8	<b>BZ7HS-10</b>	<b>3579</b>		
60.0 hp	3	1975 - 1993	0,8	<b>BZ7HS-10</b>	<b>3579</b>		
65.0 hp	4	1968 -	0,8	<b>BZ7HS-10</b>	<b>3579</b>		
65.0 hp COM.	3	1994 - 1995	0,8	<b>BPR7HS</b>	<b>6422</b>	<b>BPR7HIX</b>	<b>5944</b>
65.0 hp Jet	4	1992 - 1997	0,8	<b>BR6HS</b>	<b>3922</b>	<b>BR6HIX</b>	<b>3419</b>
65.0 hp COM. HC LC		1988 - 1997		<b>BUHXW-1</b>	<b>5526</b>		
65.0 hp COM.HC LC		1984 - 1987	0,8	<b>BZ7HS-10</b>	<b>3579</b>		
65.0 hp	3	1972 - 1973	0,8	<b>BZ7HS-10</b>	<b>3579</b>		
70.0 hp Backtroller	3	1994 - 1997	0,8	<b>BPR7HS</b>	<b>6422</b>	<b>BPR7HIX</b>	<b>5944</b>
70.0 hp	3	1975 - 1993	0,8	<b>BZ7HS-10</b>	<b>3579</b>		
75.0 hp 49cid		1975 - 1989	0,8	<b>BZ7HS-10</b>	<b>3579</b>		
80.0 hp Jet	4	1979 - 1997	0,8	<b>BR6HS</b>	<b>3922</b>	<b>BR6HIX</b>	<b>3419</b>
80.0 hp		1966 - 1967	0,8	<b>BR6S</b>	<b>3522</b>		
85.0 hp		1968 - 1980	0,8	<b>BZ7HS-10</b>	<b>3579</b>		
85.0 hp Backtroller	4	1994 - 1995	0,8	<b>BR6HS</b>	<b>3922</b>	<b>BR6HIX</b>	<b>3419</b>
85.0 hp		1986 - 1993	0,8	<b>BZ7HS-10</b>	<b>3579</b>		
88.0 hp (CV4)	4	1979 - 1997	0,8	<b>BR6HS</b>	<b>3922</b>	<b>BR6HIX</b>	<b>3419</b>
90.0 hp (LV4)	4	1995 - 1997	0,8	<b>BPR7HS</b>	<b>6422</b>	<b>BPR7HIX</b>	<b>5944</b>
90.0 hp Turbojet		1979 - 1997	0,8	<b>BR6HS</b>	<b>3922</b>	<b>BR6HIX</b>	<b>3419</b>
90.0 hp (CV4)	4	1979 - 1997	0,8	<b>BR6HS</b>	<b>3922</b>	<b>BR6HIX</b>	<b>3419</b>
90.0 hp (V4) FFI (Ficht)	4	2000 -	0,8	<b>PZFR6H</b>	<b>7696</b>		
110.0 hp (CV4)	4	1979 - 1997	0,8	<b>BR6HS</b>	<b>3922</b>	<b>BR6HIX</b>	<b>3419</b>
100.0 hp		1967 - 1972	0,8	<b>BZ7HS-10</b>	<b>3579</b>		
100.0 hp	4	1979 - 1980	0,8	<b>BZ7HS-10</b>	<b>3579</b>		
100.0 hp COM.		1984 - 1997		<b>BUHXW-1</b>	<b>5526</b>		
105.0 hp Jet incl COM.	6	1993 - 1997	0,8	<b>BPR7HS</b>	<b>6422</b>	<b>BPR7HIX</b>	<b>5944</b>
105.0 hp (LV4) COM.	4	1997 -	0,8	<b>BPR7HS</b>	<b>6422</b>	<b>BPR7HIX</b>	<b>5944</b>
112.0 hp (CV4)	4	1979 - 1997	0,8	<b>BR6HS</b>	<b>3922</b>	<b>BR6HIX</b>	<b>3419</b>
115.0 hp		1985 -		<b>BUHXW-1</b>	<b>5526</b>		
115.0 hp COM.		1975 - 1984	1,0	<b>B7HS-10</b>	<b>2129</b>		
115.0 hp		1973 - 1984	0,8	<b>BZ7HS-10</b>	<b>3579</b>		
115.0 hp		1986 - 1993	0,8	<b>BZ7HS-10</b>	<b>3579</b>		
115.0 hp (LV4) Intruder	4	1995 - 1997	0,8	<b>BPR7HS</b>	<b>6422</b>	<b>BPR7HIX</b>	<b>5944</b>
115.0 hp Turbojet		1994 - 1997	0,8	<b>BR6HS</b>	<b>3922</b>	<b>BR6HIX</b>	<b>3419</b>
115.0 hp		1969 - 1970	1,0	<b>B7HS-10</b>	<b>2129</b>		
115.0 hp (V4) FFI (Ficht)	4	2000 -	0,8	<b>PZFR6H</b>	<b>7696</b>		
115.0 hp (CV4)	4	1979 - 1997	0,8	<b>BR6HS</b>	<b>3922</b>	<b>BR6HIX</b>	<b>3419</b>
120.0 hp (LV4)	4	1985 - 1997	0,8	<b>BPR7HS</b>	<b>6422</b>	<b>BPR7HIX</b>	<b>5944</b>
125.0 hp		1971 - 1972	1,0	<b>B7HS-10</b>	<b>2129</b>		
130.0 hp (LV4)	4	1985 - 1997	0,8	<b>BPR7HS</b>	<b>6422</b>	<b>BPR7HIX</b>	<b>5944</b>
135.0 hp		1973 - 1984		<b>BUHXW-1</b>	<b>5526</b>		
140.0 hp (LV4)	4	1985 - 1997	0,8	<b>BPR7HS</b>	<b>6422</b>	<b>BPR7HIX</b>	<b>5944</b>



Cyl.



Order No.

Iridium



Order No.

**EVINRUDE**

140.0 hp COM.		1973 - 1984		<b>BUHXW-1</b>	<b>5526</b>		
150.0 hp (LV6) Intruder	6	1991 - 1997	0,8	<b>BPR7HS</b>	<b>6422</b>	<b>BPR7HIX</b>	<b>5944</b>
150.0 hp (CV6)	6	1978 - 1987		<b>BUHXW-1</b>	<b>5526</b>		
150.0 hp (CV6)	6	1988 - 1991	0,8	<b>BZ7HS-10</b>	<b>3579</b>		
150.0 hp (V6) FFI (Ficht)	6	2000 -	0,8	<b>PZFR6H</b>	<b>7696</b>		
150.0 hp (LV6) COM.	6	1993 -	0,8	<b>BPR7HS</b>	<b>6422</b>	<b>BPR7HIX</b>	<b>5944</b>
155.0 hp (CV6)	6	1978 - 1987		<b>BUHXW-1</b>	<b>5526</b>		
155.0 hp (CV6) COM.	6	1989 - 1992		<b>BUHXW-1</b>	<b>5526</b>		
175.0 hp (LV6) Intruder	6	1991 - 1997	0,8	<b>BPR7HS</b>	<b>6422</b>	<b>BPR7HIX</b>	<b>5944</b>
175.0 hp		1978 - 1987		<b>BUHXW-1</b>	<b>5526</b>		
175.0 hp (CV6)	6	1988 - 1991	0,8	<b>BZ7HS-10</b>	<b>3579</b>		
175.0 hp (V6) FFI (Ficht)	6	2000 -	0,8	<b>PZFR6H</b>	<b>7696</b>		
185 Com.		1990 - 1993	1,0	<b>BZ7HS-10</b>	<b>3579</b>		
185.0 hp		1977 - 1987		<b>BUHXW-1</b>	<b>5526</b>		
185.0 hp COM.	6	1990 - 1993	0,8	<b>BZ7HS-10</b>	<b>3579</b>		
200.0 hp (V6) FFI (Ficht)	6	1999 -	0,8	<b>PZFR6H</b>	<b>7696</b>		
200.0 hp COM.		1993 - 1997	0,8	<b>BR6HS</b>	<b>3922</b>	<b>BR6HIX</b>	<b>3419</b>
200.0 hp (V6) Vindicator	6	1992 - 1998	0,8	<b>BPR7HS</b>	<b>6422</b>	<b>BPR7HIX</b>	<b>5944</b>
200.0 hp (V6)	6	1986 - 1993	0,8	<b>BZ7HS-10</b>	<b>3579</b>		
200.0 hp		1976 - 1983		<b>BUHXW-1</b>	<b>5526</b>		
200.0 hp COM.		1992 -		<b>BUHXW-1</b>	<b>5526</b>		
225.0 hp (V6) Vindicator	6	1994 - 1997	0,8	<b>BPR7HS</b>	<b>6422</b>	<b>BPR7HIX</b>	<b>5944</b>
225.0 hp (V6) FFI (Ficht)	6	1999 -	0,8	<b>PZFR6H</b>	<b>7696</b>		
225.0 hp	6	1986 - 1993	0,8	<b>BZ7HS-10</b>	<b>3579</b>		
235.0 hp		1978 - 1985		<b>BUHXW-1</b>	<b>5526</b>		
250.0 hp (V8)	8	1985 - 1997	0,8	<b>BPR7HS</b>	<b>6422</b>	<b>BPR7HIX</b>	<b>5944</b>
275.0 hp		1985 - 1988	0,8	<b>BPR7HS</b>	<b>6422</b>	<b>BPR7HIX</b>	<b>5944</b>
275.0 hp	6	1985 - 1986	0,8	<b>BZ7HS-10</b>	<b>3579</b>		
300.0 hp (V8)	8	1985 - 1997	0,8	<b>BPR7HS</b>	<b>6422</b>	<b>BPR7HIX</b>	<b>5944</b>
300.0 hp	6	1985 - 1986	0,8	<b>BZ7HS-10</b>	<b>3579</b>		
Sea Drive		1988 - 1992	0,8	<b>BZ7HS-10</b>	<b>3579</b>		
<b>Models with Standard Ignition</b>							
18 mm		1939 - 1950	0,6	<b>A6</b>	<b>1010</b>		
1.0 hp 1R	1	1968 - 1970	0,8	<b>BR6S</b>	<b>3522</b>		
1.2 hp Magneto	1	1986 - 1990	0,8	<b>BR6S</b>	<b>3522</b>		
1.5 hp	1	1968 - 1970	0,8	<b>BR6S</b>	<b>3522</b>		
2.0 hp	1	1966 - 1970	0,8	<b>BM4A</b>	<b>5628</b>		
2.0 hp	1	1968 - 1970	0,8	<b>BR6S</b>	<b>3522</b>		
2.0 hp 2R	1	1971 - 1984	0,8	<b>BR6S</b>	<b>3522</b>		
3.0 hp	1	1952 - 1974	0,8	<b>BR6S</b>	<b>3522</b>		
3.3 hp	1	1948 - 1951	0,8	<b>BR6S</b>	<b>3522</b>		
4.0 hp V4S / VX / VXH	1	1958 - 1967	0,8	<b>BR6S</b>	<b>3522</b>		
4.0 hp	1	1981 - 1984	0,8	<b>BZ7HS-10</b>	<b>3579</b>		
4.0 hp 4R/4W	1	1969 - 1976	0,8	<b>BR6S</b>	<b>3522</b>		
4.0 hp V4 / V4A / V4M	1	1958 - 1967	0,8	<b>BR6S</b>	<b>3522</b>		
5.0 hp	1	1965 - 1968	0,8	<b>BR6S</b>	<b>3522</b>		
5.2 hp	1	1952 - 1974	0,8	<b>BR6S</b>	<b>3522</b>		
5.5 hp	1	1956 - 1964	0,8	<b>BR6S</b>	<b>3522</b>		
6.0 hp	1	1965 - 1976	0,8	<b>BR6S</b>	<b>3522</b>		
6.0 hp 6R / 6RL	1	1971 - 1976	0,8	<b>BR6S</b>	<b>3522</b>		

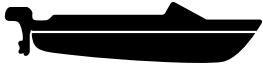

Cyl.

Order  
No.

Iridium

Order  
No.**EVINRUDE****Models with Standard Ignition**

7.5 hp	1	1952 - 1958	0,8	BR6S	3522		
9.0 hp 9E / EL / R / RL		1974 -	0,8	BZ7HS-10	3579		
9.5 hp	1	1964 - 1973	0,8	BR6S	3522		
9.7 hp		1942 - 1949	0,8	A7	1110		
10.0 hp	1	1952 - 1963	0,8	BR6S	3522		
10.0 hp 10E / EL / R / RL		1975 - 1976	0,8	BZ7HS-10	3579		
14.0 hp	1	1950 - 1972	0,8	BR6S	3522		
15.0 hp 15E / EL / R / RL		1974 - 1976	0,8	BZ7HS-10	3579		
15.0 hp	1	1954 - 1956	0,8	BR6S	3522		
18.0 hp		1957 - 1973	0,8	BR6S	3522		
20.0 hp		1966 - 1973	0,8	BR6S	3522		
20.0 hp 20R / 20RL		1969 -	0,8	BR6S	3522		
25.0 hp 25E / 25EL		1972 -	0,8	BR6S	3522		
25.0 hp 25E / 25EL / 25R / 25RL		1973 - 1976	0,8	BR6S	3522		
25.0 hp		1969 - 1976	0,8	BR6S	3522		
25.0 hp		1952 - 1955	0,8	BR6S	3522		
25.0 hp 25R / 25RL		1969 - 1972	0,8	BR6S	3522		
28.0 hp		1962 - 1964	0,8	BR6S	3522		
30.0 hp		1956 - 1971	0,8	BR6S	3522		
33.0 hp 33R / 33E		1969 - 1971	0,8	BR6S	3522		
35.0 hp		1957 - 1959	0,8	BR6S	3522		
35.0 hp 35E / EL / R / RL		1976 -	0,8	BZ7HS-10	3579		
40.0 hp 40E / EL / R / RL		1974 - 1976	0,8	BZ7HS-10	3579		
40.0 hp		1960 - 1973	0,8	BR6S	3522		
40.0 hp 40ES		1969 - 1971	0,8	BR6S	3522		
40.0 hp 40R / 40E / 40EL / 40RL		1969 - 1973	0,8	BR6S	3522		
50.0 hp		1958 - 1959	0,8	BR6S	3522		
60.0 hp (V4)		1964 - 1967	0,8	BR6S	3522		
75.0 hp (V4)		1960 - 1965	0,8	BR6S	3522		
80.0 hp		1966 - 1967	0,8	BR6S	3522		
90.0 hp		1964 - 1965	0,8	BR6S	3522		
100.0 hp		1966 -	0,8	BR6S	3522		
Air Buoy Driving Unit			0,8	BM4A	5628		
CD / JH / FD / FDE/ JW / MQ		1952 - 1968	0,8	BR6S	3522		
JHF / JWF / LD / SC		1965 - 1968	0,8	BR6S	3522		
RD / RDE / RDS / RJE / RK		1951 - 1968	0,8	BR6S	3522		
RX / RXE /		1962 - 1968	0,8	BR6S	3522		
TN / AD / QD / V4H / V4ML		1952 - 1966	0,8	BR6S	3522		

**EXPLORER**

3.5 hp		1981 - 1984	0,7	XR4	2637	XR4IX	7189
5.0 hp		1981 - 1984	0,7	XR4	2637	XR4IX	7189
7.5 hp		1981 - 1984	0,7	XR4	2637	XR4IX	7189
9.9 hp		1981 - 1984	0,7	XR4	2637	XR4IX	7189
15.0 hp		1981 - 1984	0,7	XR4	2637	XR4IX	7189

**FEDERAL**

3.5 hp		1971 - 1974	0,7	XR4	2637	XR4IX	7189
5.0 hp		1971 - 1974	0,7	XR4	2637	XR4IX	7189



Cyl.



Order No.

Iridium



Order No.

**FEDERAL**

7.0 hp	1971 - 1974	0,7	XR4	2637	XR4IX	7189
--------	-------------	-----	-----	------	-------	------

**FIAT NAUTICA**

3.5 hp		0,9	BR6HS	3922	BR6HIX	3419
6.0 hp		0,9	BR6HS	3922	BR6HIX	3419
8.0 hp		0,9	BR6HS	3922	BR6HIX	3419
12.0 hp		0,9	BR6HS	3922	BR6HIX	3419
14.0 hp		0,9	BR6HS	3922	BR6HIX	3419
24.0 hp		0,9	BR6HS	3922	BR6HIX	3419

**FIRESTONE**

Featherweight 5	1966 -	0,8	BR6S	3522		
-----------------	--------	-----	------	------	--	--

**FISHER PIERCE**

Bearcat 55		0,8	BR6S	3522		
Bearcat 85		0,8	BR8ES	5422	BR8EIX	5044

**FLAMBEAU**

Single (2.5PS), Double (5 PS)		0,6	B6S	3510		
-------------------------------	--	-----	-----	------	--	--

**FLYING-O**

3.5 hp	1968 - 1969	0,8	BR6S	3522		
5.0 hp	1968 - 1969	0,8	BR6S	3522		
5.0 hp	1970 - 1974	0,7	XR4	2637	XR4IX	7189
5.5 hp	1975 -	0,7	XR4	2637	XR4IX	7189
7.0 hp	1970 - 1972	0,7	XR4	2637	XR4IX	7189
7.0 hp	1968 - 1969	0,8	BR6S	3522		
7.5 hp	1973 -	0,7	XR4	2637	XR4IX	7189
9.9 hp	1973 - 1974	0,7	XR4	2637	XR4IX	7189
15.0 hp	1973 - 1974	0,7	XR4	2637	XR4IX	7189

**FORCE**

3 HP	1990 - 1994	1,0	BP6HS-10	6326		
3 M		1,0	BPR6HS-10	2633		
4 HP	1984 - 1987	0,8	B6HS	4510	BR6HIX	3419
5 HP	1988 - 1997	0,8	BP6HS	4511	BPR6HIX	4085
5 M / ML		0,7	B6HS	4510	BR6HIX	3419
7.5 HP	1985 -	0,8	B6HS	4510	BR6HIX	3419
9.9 HP	1984 - 1997	0,8	BP6HS	4511	BPR6HIX	4085
9.9 M / ML		0,7	BP6HS	4511	BPR6HIX	4085
15 HP	1984 - 1997	0,8	BP6HS	4511	BPR6HIX	4085
15 M / ML		0,7	BP6HS	4511	BPR6HIX	4085
25 HP	1996 - 1997	0,8	BP6HS	4511	BPR6HIX	4085
25 HP	1989 - 1991	0,8	BR6HS	3922	BR6HIX	3419





Cyl.

Order  
No.

Iridium

Order  
No.**FORCE**

35 E / EL / ELT / ELH				<b>BUHW</b>	<b>2622</b>		
35 HP	1989 - 1991	0,8		<b>BR6HS</b>	<b>3922</b>	<b>BR6HIX</b>	<b>3419</b>
40 HP	1992 - 1997			<b>BUZHW</b>	<b>2147</b>		
50 EL / ELPT				<b>BUHW</b>	<b>2622</b>		
50 HP Thunderbolt	1991 - 1997			<b>BUZHW</b>	<b>2147</b>		
50 HP	1984 - 1987	0,8		<b>B7HS</b>	<b>5110</b>	<b>BR7HIX</b>	<b>7067</b>
50 HP Prestolite	1988 - 1991			<b>BUHX</b>	<b>2522</b>		
60 HP	1985 -			<b>BUZHW</b>	<b>2147</b>		
70 EL / ELPT				<b>BUHW</b>	<b>2622</b>		
70 HP	1991 - 1995			<b>BUZHW</b>	<b>2147</b>		
75 HP	1996 - 1997			<b>BUZHW</b>	<b>2147</b>		
85 HP	1983 - 1989			<b>BUHX</b>	<b>2522</b>		
90 ELPT				<b>BUHW</b>	<b>2622</b>		
90 HP Prestolite	1990 - 1991			<b>BUHX</b>	<b>2522</b>		
90 HP Thunderbolt	1991 - 1997			<b>BUZHW</b>	<b>2147</b>		
120 ELPT				<b>BUHW</b>	<b>2622</b>		
120 HP Prestolite	1980 - 1991			<b>BUHX</b>	<b>2522</b>		
120 HP Thunderbolt	1991 - 1997			<b>BUZHW</b>	<b>2147</b>		
125 HP	1983 - 1989			<b>BUHX</b>	<b>2522</b>		
150 ELPT				<b>BUHW</b>	<b>2622</b>		
150 HP	1991 - 1994			<b>BUZHW</b>	<b>2147</b>		
150 HP Prestolite	1989 - 1991			<b>BUHX</b>	<b>2522</b>		

**FOREMOST**

9.2 hp		0,8		<b>BR6S</b>	<b>3522</b>		
--------	--	-----	--	-------------	-------------	--	--

**FRANCHI**

6 PS		0,7		<b>B6S</b>	<b>3510</b>		
18 PS, 40 PS		0,7		<b>B6L</b>	<b>3212</b>		

**FURY**

3.5 hp	1961 -	0,8		<b>BR6S</b>	<b>3522</b>		
--------	--------	-----	--	-------------	-------------	--	--

**GALE**

Buccaneer 25, 35, 40, 60 PS		0,8		<b>B6S</b>	<b>3510</b>		
Buccaneer 3, 5, 5.5, 12, 15 PS		0,8		<b>B6S</b>	<b>3510</b>		
Sovereign 35, 40, 60 PS		0,8		<b>B6S</b>	<b>3510</b>		

**GAMBLES**

3.5 hp	1970 -	0,7		<b>XR4</b>	<b>2637</b>	<b>XR4IX</b>	<b>7189</b>
3.5 hp	- 1969	0,8		<b>BR6S</b>	<b>3522</b>		
5.0 hp	- 1969	0,8		<b>BR6S</b>	<b>3522</b>		
5.0 hp	1970 -	0,7		<b>XR4</b>	<b>2637</b>	<b>XR4IX</b>	<b>7189</b>
7.0 hp	1969 -	0,7		<b>XR4</b>	<b>2637</b>	<b>XR4IX</b>	<b>7189</b>



Cyl.



Order No.

Iridium



Order No.

**GARELLI**

Gari Jet		0,5	B6HS	4510	BR6HIX	3419
----------	--	-----	------	------	--------	------

**GUAZZONI**

Gamberino 4.5 PS		0,5	B6S	3510		
------------------	--	-----	-----	------	--	--

**HONDA**

BF 2 B		0,6	CR5HSB	6535	CR5HIX	7120
BF 2 D	1999 -	0,6	CR5HSB	6535	CR5HIX	7120
BF 2 / A 4 Stroke Side Valve	1984 -	0,7	BMR4A	5728		
BF 2 B		0,6	CR5HSB	6535	CR5HIX	7120
BF 2.3		0,6	CR5HSB	6535	CR5HIX	7120
BF 4.5 B		0,8	BPR5ES	7422	BPR5EIX	6597
BF 5 AK		0,8	BPR5ES	7422	BPR5EIX	6597
BF 5 4 Stroke Vertical OHV	1984 -	0,8	BPR5ES	7422	BPR5EIX	6597
BF 5 A		0,8	BPR5ES	7422	BPR5EIX	6597
BF 6 B	2003 -	0,6	DR4HS	3326		
BF 6		0,6	DR4HS	3326		
BF 6 CH	2004 -	0,9	CR5EH-9	6689		
BF 7,5	1977 -	0,7	DR5HS	4623		
BF 8	2001 -	0,9	CR5EH-9	6689		
BF 8 D		0,9	CR5EH-9	6689		
BF 8 D1 8.0HP 4-Stroke	2 2001 -	0,9	CR5EH-9	6689		
BF 8 4 Stroke In-Line OHC	1987 - 2000	0,7	DR5HS	4623		
BF 8 A / B / C	1990 - 2000	0,7	DR5HS	4623		
BF 8 B1		0,9	CR5EH-9	6689		
BF 9 / A		0,7	DR5HS	4623		
BF 9.9 4 Stroke In-Line OHC	1987 - 2001	0,7	DR5HS	4623		
BF 9.9 A / B		0,7	DR5HS	4623		
BF 9.9 D1 9.9HP 4-Stroke	2 2001 -	0,9	CR5EH-9	6689		
BF 10 D	2001 -	0,9	CR5EH-9	6689		
BF 10 / B1	2001 -	0,9	CR5EH-9	6689		
BF 15 D	2003 -	0,9	CR5EH-9	6689		
BF 15 B		0,7	DR5HS	4623		
BF 15 4 Stroke In-Line OHC	1987 - 1990	0,7	DR6HS	4823		
BF 15 A	1996 - 2002	0,7	DR5HS	4623		
BF 20	1993 -	0,7	DR7EA	7839		
BF 20 / F 4 Stroke Side Valve	1985 -	0,6	BMR4A	5728		
BF 20 D	2003 -	0,9	CR5EH-9	6689		
BF 25 / A 4 Stroke OHC	1993 -	0,7	DR7EA	7839		
BF 25 B		0,6	DR7EA	7839		
BF 25 D4	2004 -	0,7	DR7EA	7839		
BF 28		0,6	CR5HSB	6535	CR5HIX	7120
BF 28 D		0,6	CR5HSB	6535	CR5HIX	7120
BF 30 / A 4 Stroke OHC	1994 -	0,6	DR7EA	7839		
BF 30 D4	2004 -	0,7	DR7EA	7839		
BF 35 / A 4 Stroke OHC	1990 -	0,7	DR7EA	7839		
BF 40 B		0,6	DR7EA	7839		
BF 40 / A 4 Stroke OHC	1994 -	0,7	DR7EA	7839		
BF 45 / A 4 Stroke OHC	1990 -	0,7	DR7EA	7839		
BF 50 / F 4 Stroke Vertical OHV	1985 - 1994	0,7	BPR5ES	7422	BPR5EIX	6597



Cyl.

Order  
No.

Iridium

Order  
No.**HONDA**

BF 50	4 Stroke Vertical OHV		1986 - 1994	0,8	BPR5ES	7422	BPR5EIX	6597
BF 50 / A	4 Stroke OHC		1994 -	0,7	DR7EA	7839		
BF 70 A	4 Stroke OHC 12Valve			0,6	DR7EA	7839		
BF 75			2003 -	0,7	DR7EA	7839		
BF 75 B				0,6	DR7EA	7839		
BF 75 E	4 Stroke In-Line OHC			0,6	DR5HS	4623		
BF 75 A	4 Stroke OHC 12Valve		1995 -	0,6	DR7EA	7839		
BF 75	4 Stroke In-Line OHC			0,6	DR5HS	4623		
BF 90 / A	4 Stroke OHC 12Valve		1995 -	0,6	DR7EA	7839		
BF 100 E	4 Stroke In-Line OHC			0,6	DR5HS	4623		
BF 100	4 Stroke In-Line OHC			0,6	DR5HS	4623		
BF 115 / A	4 Stroke OHC	4	1998 -	0,8	ZFR7F	5913		
BF 130 A	4 Stroke OHC	4	1998 -	0,8	ZFR7F	5913		
BF 135 A				1,1	IZFR6K-11	6994		
BF 150 A				1,1	IZFR6K-11	6994		
BF 175 A				1,1	IZFR6K-11	6994		
BF 200 A	V6	6	2002 -	1,1	IZFR6K-11	6994		
BF 225 A	V6	6	2002 -	1,1	IZFR6K-11	6994		
BFP 8D1	8.0HP 4-Stroke	2	2001 -	0,9	CR5EH-9	6689		
BFP 9.9D1	9.9HP 4-Stroke	2	2001 -	0,9	CR5EH-9	6689		
GB-30 (3HP)				0,6	B6HS	4510	BR6HIX	3419
GB-40 (4HP)				0,6	B6HS	4510	BR6HIX	3419

**HUSQVARNA**

all models				0,5	B6HS	4510	BR6HIX	3419
------------	--	--	--	-----	------	------	--------	------

**ITALMARINE**

70 hp 920 25 SIL / SITL		3		1,0	BZ7HS-10	3579		
150 hp Ocean Runner V6		6			BUZW	2147		
175 hp Ocean Runner V6		6			BUZW	2147		
200 hp Ocean Runner V6		6		1,0	BZ7HS-10	3579		
225 hp Ocean Runner V6		6		1,0	BZ7HS-10	3579		
250 hp Ocean Runner V6		6		1,0	BZ7HS-10	3579		

**J.C.PENNY**

3.0 hp			1974 - 1980	0,7	XR4	2637	XR4IX	7189
3.5 hp			1978 - 1980	0,7	XR4	2637	XR4IX	7189
5.0 hp			1979 -	0,7	XR4	2637	XR4IX	7189
5.5 hp			1974 - 1978	0,7	XR4	2637	XR4IX	7189
7.5 hp			1974 - 1979	0,7	XR4	2637	XR4IX	7189
9.9 hp			1975 - 1979	0,7	XR4	2637	XR4IX	7189
15.0 hp			1975 - 1978	0,7	XR4	2637	XR4IX	7189

**J.L.O.**

Aquascooter				0,5	B6HS	4510	BR6HIX	3419
L-35				0,5	B6HS	4510	BR6HIX	3419



Cyl.



Order No.

Iridium



Order No.

**JOHNSON**

2.0 hp Jr, Colt	1	1971 - 1990	0,8	BR6S	3522		
2.0 hp	1	1991 -	0,8	BPR6HS	7022	BPR6HIX	4085
2.3 hp	1	1991 - 1997	0,8	BPR6HS	7022	BPR6HIX	4085
2.5 hp	1	1987 - 1988	0,8	BR6HS	3922	BR6HIX	3419
3.0 hp	2	1989 - 1997	0,8	BR6HS	3922	BR6HIX	3419
3.3 hp	1	1991 -	0,8	BPR6HS	7022	BPR6HIX	4085
3.5 hp	1	2001 - 2002	0,8	BPR6HS	7022	BPR6HIX	4085
4.0 hp	1	1969 - 1976	0,8	BR6S	3522		
4.0 hp	1	1977 - 1987	0,8	BR6HS	3922	BR6HIX	3419
4.0 hp		1988 -	0,8	BZ7HS-10	3579		
4.0 hp	2	1989 -	0,8	BR6HS	3922	BR6HIX	3419
4.0 hp Ultra,Excel		1987 - 1988	0,8	BZ7HS-10	3579		
4.5 hp		1980 - 1985	0,8	BR6HS	3922	BR6HIX	3419
5.0 hp (4-stroke)		1997 -	0,7	D6HA	6512		
5.0 hp	1	1998 -	0,8	BZ7HS-10	3579		
5.0 hp		1990 - 1997	0,8	BR6HS	3922	BR6HIX	3419
6.0 hp (2-stroke)		1977 - 1997	0,8	BR6HS	3922	BR6HIX	3419
6.0 hp (4-stroke)		1997 -	0,7	D6HA	6512		
6.5 hp COM.		1981 - 1993	0,8	BZ7HS-10	3579		
7.5 hp		1977 - 1997	0,8	BR6HS	3922	BR6HIX	3419
8.0 hp (4-stroke)		1995 -	0,7	D6HA	6512		
8.0 hp		1977 - 1997	0,8	BR6HS	3922	BR6HIX	3419
8.0 hp (2-stroke)		1998 -	0,8	BR6HS	3922	BR6HIX	3419
8.0 hp (4-stroke) SOHC		2002 -	0,7	DR5HS	4623		
8.0 hp COM.		1977 -	0,8	BR6HS	3922	BR6HIX	3419
9.9 hp (2-stroke)		1977 -	0,8	BR6HS	3922	BR6HIX	3419
9.9 hp (4-stroke)		1996 -	0,7	D6HA	6512		
9.9 hp (4-stroke) OHC		1995 - 1997	0,8	DCPR7E	3932	DCPR7EIX	6046
9.9 hp (4-stroke) OHC 305cc		1998 -	0,8	DCPR7E	3932	DCPR7EIX	6046
9.9 hp		1974 - 1976	0,8	B7HS	5110	BR7HIX	7067
10.0 hp COM.		1994 - 1997	0,8	BR6HS	3922	BR6HIX	3419
10.0 hp COM.		1992 - 1993	0,8	BZ7HS-10	3579		
14.0 hp		1988 - 1989	0,8	BZ7HS-10	3579		
14.0 hp COM.		1981 - 1991	0,8	BZ7HS-10	3579		
15.0 hp (4-stroke) OHC		1995 -	0,8	DCPR7E	3932	DCPR7EIX	6046
15.0 hp COM.		1992 - 1993	0,8	BZ7HS-10	3579		
15.0 hp incl. COM.		1994 - 1997	0,8	BR6HS	3922	BR6HIX	3419
15.0 hp Kero		1995 - 1998		BUHXW-1	5526		
15.0 hp		1998 -	0,8	BR6HS	3922	BR6HIX	3419
15.0 hp		1974 - 1976	0,8	B7HS	5110	BR7HIX	7067
15.0 hp		1977 - 1992	0,8	BZ7HS-10	3579		
18.0 hp		1957 - 1973	0,8	BR6S	3522		
18.0 hp Jet	2	1995 - 1998	0,8	BR6HS	3922	BR6HIX	3419
20.0 hp	2	1978 - 1997	0,8	BR6HS	3922	BR6HIX	3419
20.0 hp	1	1978 - 1993	0,8	BR6HS	3922	BR6HIX	3419
20.0 hp Jet	2	1998 -	0,8	BR6HS	3922	BR6HIX	3419
28.0 hp SPL	2	1978 - 1997	0,8	BR6HS	3922	BR6HIX	3419
25.0 hp	3	1995 - 1997	0,8	BR6HS	3922	BR6HIX	3419
25.0 hp	2	1998 -	0,8	BR6HS	3922	BR6HIX	3419
25.0 hp	2	1977 - 1997	0,8	BR6HS	3922	BR6HIX	3419
25.0 hp COM.		1981 -		BUHXW-1	5526		
25.0 hp	3	1998 -	0,8	BR6HS	3922	BR6HIX	3419



Cyl.

Order  
No.

Iridium

Order  
No.**JOHNSON**

28.0 hp Jet		1992 - 1997	0,8	BPR7HS	6422	BPR7HIX	5944
30.0 hp Jet	2	1999 -	0,8	BPR7HS	6422	BPR7HIX	5944
30.0 hp	2	1978 -	0,8	BR6HS	3922	BR6HIX	3419
35.0 hp		1976 -	0,8	B7HS	5110	BR7HIX	7067
35.0 hp	2	1977 - 1997	0,8	BZ7HS-10	3579		
35.0 hp	3	1995 -	0,8	BR6HS	3922	BR6HIX	3419
35.0 hp Jet	2	1993 - 1997	0,8	BPR7HS	6422	BPR7HIX	5944
40.0 hp COM.		1981 - 1990	0,8	B7HS	5110	BR7HIX	7067
40.0 hp	2	1980 - 1988	0,8	BZ7HS-10	3579		
40.0 hp	2	1989 -	0,8	BPR7HS	6422	BPR7HIX	5944
40.0 hp	3	1999 -	0,8	BPR7HS	6422	BPR7HIX	5944
40.0 hp		1974 - 1976	0,8	B7HS	5110	BR7HIX	7067
40.0 hp 815cc	3	2002 -	0,7	DCPR7E	3932	DCPR7EIX	6046
40.0 hp COM.		1984 -		BUHXW-1	5526		
45.0 hp COM.		1986 - 1997		BUHXW-1	5526		
48.0 hp	2	1989 - 1997	0,8	BPR7HS	6422	BPR7HIX	5944
48.0 hp SPL	2	1994 - 1997	0,8	BPR7HS	6422	BPR7HIX	5944
48.0 hp	2	1980 - 1988	0,8	BZ7HS-10	3579		
50.0 hp	3	1995 - 1998	0,8	BPR7HS	6422	BPR7HIX	5944
50.0 hp	2	1998 -	0,8	BPR7HS	6422	BPR7HIX	5944
50.0 hp 815cc	3	2002 -	0,7	DCPR7E	3932	DCPR7EIX	6046
50.0 hp	2	1989 - 1997	0,8	BPR7HS	6422	BPR7HIX	5944
50.0 hp		1971 - 1975	0,8	BZ7HS-10	3579		
50.0 hp	2	1980 - 1988	0,8	BZ7HS-10	3579		
55.0 hp COM.		1994 - 1995	0,8	BPR7HS	6422	BPR7HIX	5944
55.0 hp	2	1976 - 1989	0,8	BZ7HS-10	3579		
55.0 hp	3	1968 - 1969	0,8	BZ7HS-10	3579		
55.0 hp COM.		1986 - 1997		BUHXW-1	5526		
60.0 hp	3	1994 - 1998	0,8	BPR7HS	6422	BPR7HIX	5944
60.0 hp	3	1975 - 1993	0,8	BZ7HS-10	3579		
60.0 hp	3	1970 - 1971	0,8	BZ7HS-10	3579		
60.0 hp	2	1980 - 1985	0,8	BZ7HS-10	3579		
65.0 hp	4	1968 -	0,8	BZ7HS-10	3579		
65.0 hp Jet (CV4)	4	1992 - 1997	0,8	BR6HS	3922	BR6HIX	3419
65.0 hp COM. HC LC		1988 -		BUHXW-1	5526		
65.0 hp	3	1972 - 1973	0,8	BZ7HS-10	3579		
65.0 hp COM.	3	1994 - 1995	0,8	BPR7HS	6422	BPR7HIX	5944
65.0 hp COM.HC LC		1984 - 1987	0,8	BZ7HS-10	3579		
70.0 hp Backtroller	3	1994 - 1997	0,8	BPR7HS	6422	BPR7HIX	5944
70.0 hp	3	1998 -	0,8	BPR7HS	6422	BPR7HIX	5944
70.0 hp	3	1975 - 1993	0,8	BZ7HS-10	3579		
75.0 hp	3	1975 - 1989	0,8	BZ7HS-10	3579		
80.0 hp		1966 - 1967	0,8	BR6S	3522		
80.0 hp Jet (CV4)	4	1979 -	0,8	BR6HS	3922	BR6HIX	3419
85.0 hp		1986 - 1993	0,8	BZ7HS-10	3579		
85.0 hp		1968 - 1980	0,8	BZ7HS-10	3579		
85.0 hp Backtroller	4	1994 - 1995	0,8	BR6HS	3922	BR6HIX	3419
88.0 hp SPL	4	1979 - 1997	0,8	BR6HS	3922	BR6HIX	3419
90.0 hp 1950cc	4	2003 -	0,7	BKR6E	6962	BKR6EIX	6418
90.0 hp (CV4)	4	1979 - 1998	0,8	BR6HS	3922	BR6HIX	3419
90.0 hp (LV4)	4	1995 -	0,8	BPR7HS	6422	BPR7HIX	5944
90.0 hp Turbojet		1994 - 1997	0,8	BR6HS	3922	BR6HIX	3419



Cyl.

Order  
No.

Iridium

Order  
No.**JOHNSON**

100.0 hp		1967 - 1972	0,8	<b>BZ7HS-10</b>	<b>3579</b>		
100.0 hp	4	1979 - 1980	0,8	<b>BZ7HS-10</b>	<b>3579</b>		
100.0 hp COM.		1998 -		<b>BUHXW-1</b>	<b>5526</b>		
110.0 hp (CV4)	4	1979 - 1997	0,8	<b>BR6HS</b>	<b>3922</b>	<b>BR6HIX</b>	<b>3419</b>
100.0 hp COM.		1984 - 1997		<b>BUHXW-1</b>	<b>5526</b>		
105.0 hp (V6) Jet, COM.	6	1993 - 1997	0,8	<b>BPR7HS</b>	<b>6422</b>	<b>BPR7HIX</b>	<b>5944</b>
105.0 hp COM.	6	1997 -	0,8	<b>BPR7HS</b>	<b>6422</b>	<b>BPR7HIX</b>	<b>5944</b>
112.0 hp (CV4)	4	1979 - 1997	0,8	<b>BR6HS</b>	<b>3922</b>	<b>BR6HIX</b>	<b>3419</b>
115.0 hp Turbojet		1994 - 1998	0,8	<b>BR6HS</b>	<b>3922</b>	<b>BR6HIX</b>	<b>3419</b>
115.0 hp		1985 -		<b>BUHXW-1</b>	<b>5526</b>		
115.0 hp		1969 - 1970	0,8	<b>BZ7HS-10</b>	<b>3579</b>		
115.0 hp		1986 - 1993	0,8	<b>BZ7HS-10</b>	<b>3579</b>		
115.0 hp COM.		1975 - 1984	1,0	<b>B7HS-10</b>	<b>2129</b>		
115.0 hp		1973 - 1984	0,8	<b>BZ7HS-10</b>	<b>3579</b>		
115.0 hp (CV4)	4	1979 - 1998	0,8	<b>BR6HS</b>	<b>3922</b>	<b>BR6HIX</b>	<b>3419</b>
115.0 hp (LV4) FastStrike	4	1995 -	0,8	<b>BPR7HS</b>	<b>6422</b>	<b>BPR7HIX</b>	<b>5944</b>
120.0 hp (LV4)	4	1985 - 1997	0,8	<b>BPR7HS</b>	<b>6422</b>	<b>BPR7HIX</b>	<b>5944</b>
125.0 hp (CV6)	6	1971 - 1972	0,8	<b>BZ7HS-10</b>	<b>3579</b>		
130.0 hp (LV4)	4	1985 -	0,8	<b>BPR7HS</b>	<b>6422</b>	<b>BPR7HIX</b>	<b>5944</b>
135.0 hp		1973 - 1984		<b>BUHXW-1</b>	<b>5526</b>		
140.0 hp		1973 - 1984		<b>BUHXW-1</b>	<b>5526</b>		
140.0 hp (LV4)	4	1985 - 1997	0,8	<b>BPR7HS</b>	<b>6422</b>	<b>BPR7HIX</b>	<b>5944</b>
150 hp		2003 -	1,0	<b>BPZ8HS-10</b>	<b>3133</b>		
150.0 hp (CV6)	6	1988 - 1991	0,8	<b>BZ7HS-10</b>	<b>3579</b>		
150.0 hp (CV6)	6	1978 - 1987		<b>BUHXW-1</b>	<b>5526</b>		
150.0 hp (LV6) FastStrike	6	1991 -	0,8	<b>BPR7HS</b>	<b>6422</b>	<b>BPR7HIX</b>	<b>5944</b>
150.0 hp (LV6) COM.	6	1993 - 1998	0,8	<b>BPR7HS</b>	<b>6422</b>	<b>BPR7HIX</b>	<b>5944</b>
155.0 hp (CV6) COM.	6	1989 - 1992		<b>BUHXW-1</b>	<b>5526</b>		
155.0 hp (CV6)	6	1978 - 1987		<b>BUHXW-1</b>	<b>5526</b>		
175.0 hp (CV6)	6	1977 - 1987		<b>BUHXW-1</b>	<b>5526</b>		
175.0 hp (CV6)	6	1988 - 1991	0,8	<b>BZ7HS-10</b>	<b>3579</b>		
175.0 hp (LV6) FastStrike	6	1991 -	0,8	<b>BPR7HS</b>	<b>6422</b>	<b>BPR7HIX</b>	<b>5944</b>
185.0 hp COM.	6	1990 - 1993	0,8	<b>BZ7HS-10</b>	<b>3579</b>		
185.0 hp		1977 - 1987		<b>BUHXW-1</b>	<b>5526</b>		
200.0 hp COM.		1993 - 1997	0,8	<b>BR6HS</b>	<b>3922</b>	<b>BR6HIX</b>	<b>3419</b>
200.0 hp (LV6) Venom	6	1994 - 1998	0,8	<b>BPR7HS</b>	<b>6422</b>	<b>BPR7HIX</b>	<b>5944</b>
200.0 hp		1976 - 1983		<b>BUHXW-1</b>	<b>5526</b>		
200.0 hp (V6)	6	1986 - 1993	0,8	<b>BZ7HS-10</b>	<b>3579</b>		
200.0 hp COM.		1992 -		<b>BUHXW-1</b>	<b>5526</b>		
225.0 hp (LV6) Venom	6	1994 -	0,8	<b>BPR7HS</b>	<b>6422</b>	<b>BPR7HIX</b>	<b>5944</b>
225.0 hp	6	1986 - 1993	0,8	<b>BZ7HS-10</b>	<b>3579</b>		
235.0 hp	6	1978 - 1985		<b>BUHXW-1</b>	<b>5526</b>		
250.0 hp	6	1999 -		<b>BUHXW-1</b>	<b>5526</b>		
250.0 hp (V8)	8	1985 - 1997	0,8	<b>BPR7HS</b>	<b>6422</b>	<b>BPR7HIX</b>	<b>5944</b>
275.0 hp		1985 - 1988	0,8	<b>BPR7HS</b>	<b>6422</b>	<b>BPR7HIX</b>	<b>5944</b>
300.0 hp (V8)	8	1985 - 1997	0,8	<b>BPR7HS</b>	<b>6422</b>	<b>BPR7HIX</b>	<b>5944</b>
Sea Drive		1988 - 1992	0,8	<b>BZ7HS-10</b>	<b>3579</b>		
<b>Models with Standard Ignition</b>							
1.0 hp 1R	1	1968 - 1970	0,8	<b>BR6S</b>	<b>3522</b>		
1.2 hp Magneto	1	1986 - 1990	0,8	<b>BR6S</b>	<b>3522</b>		



Cyl.

Order  
No.

Iridium

Order  
No.**JOHNSON****Models with Standard Ignition**

1.5 hp	1	1968 - 1970	0,8	<b>BR6S</b>	<b>3522</b>		
2.0 hp 2R	1	1971 - 1984	0,8	<b>BR6S</b>	<b>3522</b>		
2.0 hp Aquanaut Driving Unit	1	1966 - 1970	0,8	<b>BM4A</b>	<b>5628</b>		
2.0 hp	1	1968 - 1970	0,8	<b>BR6S</b>	<b>3522</b>		
3.0 hp	1	1952 - 1974	0,8	<b>BR6S</b>	<b>3522</b>		
3.3 hp	1	1948 - 1951	0,8	<b>BR6S</b>	<b>3522</b>		
4.0 hp V4S / VX / VXH	1	1958 - 1967	0,8	<b>BR6S</b>	<b>3522</b>		
4.0 hp	1	1981 - 1984	0,8	<b>BZ7HS-10</b>	<b>3579</b>		
4.0 hp 4R/4W	1	1969 - 1976	0,8	<b>BR6S</b>	<b>3522</b>		
4.0 hp V4 / V4A / V4M	1	1958 - 1967	0,8	<b>BR6S</b>	<b>3522</b>		
5.0 hp	1	1965 - 1968	0,8	<b>BR6S</b>	<b>3522</b>		
5.2 hp	1	1952 - 1974	0,8	<b>BR6S</b>	<b>3522</b>		
5.5 hp	1	1956 - 1964	0,8	<b>BR6S</b>	<b>3522</b>		
6.0 hp 6R / 6RL	1	1971 - 1976	0,8	<b>BR6S</b>	<b>3522</b>		
6.0 hp	1	1965 - 1976	0,8	<b>BR6S</b>	<b>3522</b>		
7.5 hp	1	1952 - 1958	0,8	<b>BR6S</b>	<b>3522</b>		
9.0 hp 9E / EL / R / RL		1974 -	0,8	<b>BZ7HS-10</b>	<b>3579</b>		
9.5 hp	1	1964 - 1973	0,8	<b>BR6S</b>	<b>3522</b>		
9.7 hp		1942 - 1949	0,8	<b>A7</b>	<b>1110</b>		
10.0 hp 10E / EL / R / RL		1975 - 1976	0,8	<b>BZ7HS-10</b>	<b>3579</b>		
10.0 hp	1	1952 - 1963	0,8	<b>BR6S</b>	<b>3522</b>		
14.0 hp	1	1950 - 1972	0,8	<b>BR6S</b>	<b>3522</b>		
15.0 hp	1	1954 - 1956	0,8	<b>BR6S</b>	<b>3522</b>		
18.0 hp		1957 - 1973	0,8	<b>BR6S</b>	<b>3522</b>		
20.0 hp 20R / 20RL		1969 -	0,8	<b>BR6S</b>	<b>3522</b>		
20.0 hp		1966 - 1973	0,8	<b>BR6S</b>	<b>3522</b>		
25.0 hp		1952 - 1955	0,8	<b>BR6S</b>	<b>3522</b>		
25.0 hp 25E / 25EL / 25R / 25RL		1973 - 1976	0,8	<b>BR6S</b>	<b>3522</b>		
25.0 hp		1969 - 1976	0,8	<b>BR6S</b>	<b>3522</b>		
25.0 hp 25R / 25RL		1969 - 1972	0,8	<b>BR6S</b>	<b>3522</b>		
25.0 hp 25E / 25EL		1972 -	0,8	<b>BR6S</b>	<b>3522</b>		
28.0 hp		1962 - 1964	0,8	<b>BR6S</b>	<b>3522</b>		
30.0 hp		1956 - 1971	0,8	<b>BR6S</b>	<b>3522</b>		
33.0 hp 33R / 33E		1969 - 1971	0,8	<b>BR6S</b>	<b>3522</b>		
35.0 hp 35E / EL / R / RL		1976 -	0,8	<b>BZ7HS-10</b>	<b>3579</b>		
35.0 hp		1957 - 1959	0,8	<b>BR6S</b>	<b>3522</b>		
40.0 hp 40R / 40E / 40EL / 40RL		1969 - 1973	0,8	<b>BR6S</b>	<b>3522</b>		
40.0 hp 40E / EL / R / RL		1974 - 1976	0,8	<b>BZ7HS-10</b>	<b>3579</b>		
40.0 hp		1960 - 1973	0,8	<b>BR6S</b>	<b>3522</b>		
40.0 hp 40ES		1969 - 1971	0,8	<b>BR6S</b>	<b>3522</b>		
50.0 hp		1958 - 1959	0,8	<b>BR6S</b>	<b>3522</b>		
60.0 hp (V4)		1964 - 1967	0,8	<b>BR6S</b>	<b>3522</b>		
75.0 hp (V4)		1960 - 1965	0,8	<b>BR6S</b>	<b>3522</b>		
80.0 hp		1966 - 1967	0,8	<b>BR6S</b>	<b>3522</b>		
90.0 hp		1964 - 1965	0,8	<b>BR6S</b>	<b>3522</b>		
100.0 hp		1966 -	0,8	<b>BR6S</b>	<b>3522</b>		
18 mm		1939 - 1950	0,6	<b>A6</b>	<b>1010</b>		
Air Buoy Driving Unit			0,8	<b>BM4A</b>	<b>5628</b>		
CD / JH / FD / FDE/ JW / MQ		1952 - 1968	0,8	<b>BR6S</b>	<b>3522</b>		
JHF / JWF / LD / SC		1965 - 1968	0,8	<b>BR6S</b>	<b>3522</b>		
RD / RDE / RDS / RJE / RK		1951 - 1968	0,8	<b>BR6S</b>	<b>3522</b>		
RX / RXE /		1962 - 1968	0,8	<b>BR6S</b>	<b>3522</b>		



Cyl.

Order  
No.

Iridium

Order  
No.**JOHNSON****Models with Standard Ignition**

TN / AD / QD / V4H / V4ML

1952 - 1966

0,8

BR6S

3522

**LAURA**

Boatmaster

0,5

B6HS

4510

BR6HIX

3419

Boatmaster Sustained full throttle

0,8

BR6HS

3922

BR6HIX

3419

**MARINEPOWER**

2.5 2-Takt/Stroke

1,0

BPR6HS-10

2633

3.3 2-Takt/Stroke

1,0

BPR6HS-10

2633

4 2-Takt/Stroke

1,0

BPR7HS-10

1092

4 4-Takt/Stroke

0,6

DCPR6E

3481

5 2-Takt/Stroke

1,0

BPR7HS-10

1092

5 4-Takt/Stroke

0,8

DCPR6E

3481

6 2-Takt/Stroke

1,0

BP8HN-10

4838

6 4-Takt/Stroke

0,8

DCPR6E

3481

8 2-Takt/Stroke

1,0

BP8HN-10

4838

8 4-Takt/Stroke

0,9

DPR6EA-9

5531

9.9 2-Takt/Stroke

1,5

BP8HS-15

6729

9.9 4-Takt/Stroke

0,9

DPR6EA-9

5531

15 4-Takt/Stroke

0,9

DPR6EA-9

5531

25 4-Takt/Stroke

0,9

DPR6EA-9

5531

30 Vergaser 4-Takt/Stroke

0,9

DPR6EA-9

5531

30 EFI 4-Takt/Stroke

0,9

DCPR7E

3932

DCPR7EIX

6046

40 EFI 4-Takt/Stroke

0,9

DCPR7E

3932

DCPR7EIX

6046

40 Vergaser 4-Takt/Stroke

0,9

DPR6EA-9

5531

45 4-Takt/Stroke

- 2001

0,9

DPR6EA-9

5531

60 4-Takt/Stroke

0,9

DPR6EA-9

5531

50 4-Takt/Stroke

0,9

DPR6EA-9

5531

75 4-Takt/Stroke

1,1

LFR5A-11

6376

90 4-Takt/Stroke

1,1

LFR5A-11

6376

10 Seapro Marathon

1,5

BP8HS-15

6729

XR10 2-Takt/Stroke

1,5

BP8HS-15

6729

15 2-Takt/Stroke

1,5

BP8HS-15

6729

15 Seapro Marathon

1,5

BP8HS-15

6729

20 2-Takt/Stroke

1,0

BP8HN-10

4838

25 2-Takt/Stroke

1,0

BP8HN-10

4838

30 2-Takt/Stroke

1,0

BPZ8HN-10

4495

40 2-Takt/Stroke

1,0

BPZ8HN-10

4495

50 2-Takt/Stroke

1,0

BPZ8HN-10

4495

60 4-Takt/Stroke

- 2001

1,0

BPZ8HN-10

3133

60 2-Takt/Stroke

1,0

BPZ8HN-10

4495

75 Optimax

2004 -

0,8

PZFR6H

7696

75 Seapro Marathon 2-Takt/Stroke

BUZHW-2

2173

75 2-Takt/Stroke

BUZHW-2

2173

90 2-Takt/Stroke

BUZHW-2

2173

90 Optimax

2004 -

0,8

PZFR6H

7696

100 2-Takt/Stroke

1,0

BPZ8HN-10

4495

115 2-Takt/Stroke

1,0

BPZ8HN-10

4495

115 Optimax

2000

1,1

PZFR5F-11

4363





Cyl.

Order  
No.

Iridium

Order  
No.**MARINEPOWER**

115	4-Takt/Stroke		1,1	LFR6A-11	3672		
115 Optimax		2004 -	0,8	PZFR6H	7696		
125	2-Takt/Stroke		1,0	BPZ8HN-10	4495		
135 Optimax			1,1	PZFR5F-11	4363		
135	2-Takt/Stroke	- 1999	0,7	BU8H	6431		
140	2-Takt/Stroke	2004 -	1,0	BPZ8HN-10	4495		
140	2-Takt/Stroke	- 2003	1,0	BPZ8HS-10	3133		
150 Optimax			1,1	PZFR5F-11	4363		
150	2-Takt/Stroke	2004 -	1,0	BPZ8HN-10	4495		
150	2-Takt/Stroke	- 1999	0,7	BU8H	6431		
150	2-Takt/Stroke	- 2003	1,0	BPZ8HS-10	3133		
175	2-Takt/Stroke	- 2003	1,0	BPZ8HS-10	3133		
175 Optimax			1,1	PZFR5F-11	4363		
175	2-Takt/Stroke	- 1999	0,7	BU8H	6431		
200 Optimax			1,1	PZFR5F-11	4363		
200	2-Takt/Stroke	- 1999	0,7	BU8H	6431		
200	2-Takt/Stroke	2003	1,0	BPZ8HS-10	3133		
200	2-Takt/Stroke	2004	1,0	BPZ8HN-10	4495		
Sport Jet 175XR <sup>2</sup>			0,8	BUZ8H	7447		
210 Jetdrive			0,8	BUZ8H	7447		
225	2-Takt/Stroke		0,7	BR8HS	4322	BR8HIX	7001
225	4-Takt/Stroke	2004 -	1,1	LFR5A-11	6376		
225 Optimax			1,1	PZFR5F-11	4363		
3L	2-Takt/Stroke		0,7	BR8HS	4322	BR8HIX	7001
240 Jetdrive			1,0	BPZ8HS-10	3133		
250	2-Takt/Stroke		0,7	BR8HS	4322	BR8HIX	7001

**MARINER**

2.0 hp 2A 646 / 2B 6A1		1993 - 1994	0,6	B6HS	4510	BR6HIX	3419
2.5 hp (2-stroke)75cc 3Kw	1	1989 - 1997	0,6	B6HS	4510	BR6HIX	3419
2.5 hp	1	1998 -	0,8	BPR6HS	7022	BPR6HIX	4085
3.0 hp		1990 - 1992	0,6	B6HS	4510	BR6HIX	3419
3.3 hp	1	1998 -	0,8	BPR6HS	7022	BPR6HIX	4085
3.3 hp (2-stroke)75cc 3Kw	1	1993 - 1997	0,6	B6HS	4510	BR6HIX	3419
3.5 hp 642		1993 - 1994	0,6	B6HS	4510	BR6HIX	3419
4.0 hp (2-stroke)		1990 -	0,8	BPR7HS	6422	BPR7HIX	5944
4.0 hp 4		1990 - 1997	0,9	BR7HS	4122	BR7HIX	7067
4.0 hp (4-stroke)		1999 -	0,8	DCPR7E	3932	DCPR7EIX	6046
4.0 hp (4-stroke) Sailmate 3Kw 123cc	1	1999 -	0,8	DCPR7E	3932	DCPR7EIX	6046
4.0 hp 4A 6EO		1989 - 1996	0,9	BR7HS	4122	BR7HIX	7067
5.0 hp (2-stroke) 4Kw 102cc	1	1990 -	0,9	BR7HS	4122	BR7HIX	7067
5.0 hp 5B 661, 5C 6E3	1	1990 - 1997	0,9	BR7HS	4122	BR7HIX	7067
5.0 hp (4-stroke) 4Kw 123cc	1	1999 -	0,8	DCPR7E	3932	DCPR7EIX	6046
5.0 hp 5	1	1990 - 1997	0,9	BR7HS	4122	BR7HIX	7067
6.0 hp (2-stroke) 5Kw 210cc	2	1992 - 1999	0,7	BP5HA	7426		
6.0 hp (4-stroke)	2	1992 - 1999	0,9	DCPR6E	3481		
6.0 hp (2-stroke)	2	1992 - 1999	0,9	BP5HA	7426		
6.0 hp 6B 678		1993 - 1996	0,9	BR7HS	4122	BR7HIX	7067
6.0 hp	2	1992 - 1997	0,8	BPR7HS	6422	BPR7HIX	5944
6.0 hp 6C 6H8	1	1993 - 1996	0,9	BR7HS	4122	BR7HIX	7067



Cyl.



Order No.

Iridium



Order No.

**MARINER**

8.0 hp K8 680		1991 - 1995	0,9	BR7HS	4122	BR7HIX	7067
8.0 hp 8A 647,655		1991 - 1995	0,9	BR7HS	4122	BR7HIX	7067
8.0 hp 8 Bodensee		1995 - 1997	0,7	C7HSA	4629		
8.0 hp B W8 77		1991 - 1995	0,9	BR7HS	4122	BR7HIX	7067
8.0 hp C 6G1		1991 - 1995	0,9	BR7HS	4122	BR7HIX	7067
8.0 hp Marathon 8 677		1991 - 1995	0,9	BR7HS	4122	BR7HIX	7067
9.9 hp (4-stroke) Bigfoot, sail power		1995 -	0,7	C7HSA	4629		
8.0 hp	2	1987 - 1997	0,8	BPR7HS	6422	BPR7HIX	5944
9.9 hp (4-stroke)		1995 - 1997	0,7	C7HSA	4629		
8.0 hp	2	1998 -	0,7	BP5HA	7426		
9.9 hp 9.9C 682 CDI			0,9	BR7HS	4122	BR7HIX	7067
9.9 hp	2	1995 - 1997	1,0	BPR7HS-10	1092		
9.9 hp	2	1998 -	0,9	BP5HA	7426		
9.9 hp		1987 - 1994	0,8	BPR7HS	6422	BPR7HIX	5944
9.9 hp 9.9C 682			0,9	BR7HS	4122	BR7HIX	7067
10.0 hp (2-stroke)Magnum/Marathon 7kW 262cc	2	1991 - 1996	1,0	BPR7HS-10	1092		
10.0 hp Magnum/Marathon		1997 -	1,0	BPR7HS-10	1092		
15.0 hp	2		0,7	BP5HA	7426		
15.0 hp K15 / K15C6K4 / W15684			0,9	BR7HS	4122	BR7HIX	7067
15.0 hp (4-stroke) Bigfoot	2	1998 -	0,9	DCPR6E	3481		
15.0 hp 15A / 15C651,684 /K15669			0,9	BR7HS	4122	BR7HIX	7067
15.0 hp Marathon15/ 15B662,664			0,9	BR7HS	4122	BR7HIX	7067
15.0 hp Marathon 15		1992 -	0,7	BP5HA	7426		
15.0 hp	2	1989 - 1997	1,0	BPR7HS-10	1092		
20.0 hp 20 Jet		1995 -	1,0	BPR7HS-10	1092		
20.0 hp	2	1985 -	1,0	BPR7HS-10	1092		
20.0 hp Hi-Igni.		1985 - 1997	0,9	DCPR6E	3481		
20.0 hp 20A653 / 20C6A9			0,6	B6HS	4510	BR6HIX	3419
25.0 hp Marathon 25	2	1993 -	1,0	BPR7HS-10	1092		
25.0 hp 25A 648 /25B 690 /25C 695			0,8	BZ7HS-10	3579		
25.0 hp W25 694 / W25 695			0,8	BZ7HS-10	3579		
25.0 hp 25		1985 -	1,0	BPR7HS-10	1092		
25.0 hp (4-stroke) Bigfoot		1998 -	0,9	DCPR6E	3481		
25.0 hp Marathon 25 684 / 694 / 695		1993 - 1996	0,8	BZ7HS-10	3579		
25.0 hp K25 6A4 / W25 648		1992 - 1996	0,8	BZ7HS-10	3579		
28.0 hp 664			0,9	BR7HS	4122	BR7HIX	7067
30.0 hp 30 Jet		1995 -	1,0	BPR7HS-10	1092		
30.0 hp 30A689 / W30689A / 689B		1992 - 1997	0,9	BR7HS	4122	BR7HIX	7067
30.0 hp (4-stroke) Bigfoot		2000 -	0,9	DCPR6E	3481		
30.0 hp Marathon 30 698B			0,9	BR7HS	4122	BR7HIX	7067
30.0 hp Marathon 30	2	1995 -	1,0	BPR7HS-10	1092		
40.0 hp 995cc	4	1998 - 2001	0,9	DPR6EA-9	5531		
40.0 hp Marathon 40	2	1995 -	1,0	BPR7HS-10	1092		
40.0 hp 40C6E9 / W40676A		1992 - 1996	1,0	BR8HS-10	1134		
40.0 hp 40A676A / 40B675			0,6	BR8HS	4322	BR8HIX	7001
40.0 hp Marathon 40 6F6		1985 - 1994	1,0	BR8HS-10	1134		
40.0 hp K406F5 / W40 / W406F6		1997 -	0,8	BR6HS	3922	BR6HIX	3419
40.0 hp K406F5 / W40 / W406F6		1992 - 1996	1,0	BPR7HS-10	1092		
40.0 hp (4-stroke) Bigfoot 30kW 995cc	4	2000 -	0,9	DCPR6E	3481		
40.0 hp 747cc .	3	1998 - 2001	0,9	DPR6EA-9	5531		
40.0 hp 747cc	3	2002 -	0,9	DCPR7E	3932	DCPR7EIX	6046
40.0 hp 995cc	4	2002 -	0,9	DCPR7E	3932	DCPR7EIX	6046



Cyl.

Order  
No.

Iridium

Order  
No.**MARINER**

40.0 hp (2-stroke)	3	1998 -	1,0	BPR7HS-10	1092		
40.0 hp (2-stroke)	2	1998 -	1,0	BPR7HS-10	1092		
40.0 hp	4	1989 - 1997		BUZHW-2	2173		
45.0 hp 45 Bodensee	4	1995 -	0,9	DCPR6E	3481		
45.0 hp 45 Jet		1995 -	1,0	BPR7HS-10	1092		
45.0 hp	4	1986 - 1989		BUZHW-2	2173		
48.0 hp 48 / W48 670			0,6	B6HS	4510	BR6HIX	3419
50.0 hp	4	1980 - 1985		BUZHW-2	2173		
50.0 hp 849cc	3	1991 -	1,0	BPR7HS-10	1092		
50.0 hp (4-stroke) 935cc		1995 - 1997	0,9	DCPR6E	3481		
50.0 hp	3	1986 - 1990		BUZHW-2	2173		
50.0 hp (4-stroke) Bigfoot 37kW 995cc	4	2000 -	0,9	DCPR6E	3481		
55.0 hp M55 663		1993 - 1994	0,9	BR7HS	4122	BR7HIX	7067
55.0 hp W55 663			1,0	BR8HS-10	1134		
55.0 hp 55EL S/N			1,0	BR8HS-10	1134		
55.0 hp Marathon 55		1991 -	1,0	BPR7HS-10	1092		
55.0 hp 55E S/N			1,0	BR8HS-10	1134		
60.0 hp 60 / 6F0		1991 - 1997	1,0	BPR7HS-10	1092		
60.0 hp 60EL	2		1,0	BR8HS-10	1134		
60.0 hp EFI	4	2002 -	0,9	DCPR7E	3932	DCPR7EIX	6046
60.0 hp	3	1984 - 1990		BUZHW	2147		
60.0 hp Marathon 60	3	1998 -	1,0	BPR7HS-10	1092		
60.0 hp	4	2001 -	0,9	DPR6EA-9	5531		
60.0 hp 60		1998 -	1,0	BPR7HS-10	1092		
60.0 hp 60E	2		1,0	BR8HS-10	1134		
60.0 hp (2-stroke) Bigfoot 45kW 967cc	3		1,0	BP7HS-10	7829		
60.0 hp Bigfoot, Marathon	3	1995 - 1997	1,0	BPR7HS-10	1092		
65.0 hp Jet	3	1995 - 1997		BUZHW-2	2173		
65.0 hp Jet		1998 -		BUZHW-2	2173		
70.0 hp	3	1978 - 1994		BUZHW-2	2173		
75.0 hp 4-Stroke		2000 -	1,1	LFR5A-11	6376		
75.0 hp (2-stroke)	3	1987 -		BUZHW-2	2173		
75.0 hp (2-stroke) Marathon 75	3	1991 -		BUZHW-2	2173		
75.0 hp all models				BUZHW-2	2173		
80.0 hp Jet		1998 -	1,0	BPR7HS-10	1092		
80.0 hp Jet	3	1995 - 1997	1,0	BPR7HS-10	1092		
80.0 hp all models				BUZHW-2	2173		
85.0 hp				BUZHW-2	2173		
90.0 hp	6			BUHW	2622		
90.0 hp (2-stroke)		2000 -	1,1	LFR5A-11	6376		
90.0 hp	3	1987 - 1997		BUZHW-2	2173		
90.0 hp (2-stroke)	4	1998 -		BUZHW-2	2173		
100.0 hp	4	1988 - 1997	1,0	BPR7HS-10	1092		
105.0 hp Jet 105		1995 - 1999		BU8H	6431		
115.0 hp	6	1979 - 1994		BUZHW	2147		
115.0 hp	4	1989 - 1997	1,0	BPR7HS-10	1092		
115.0 hp (2-stroke) 86kW	4	1998 -	1,0	BPR7HS-10	1092		
125.0 hp	4	1998 -	1,0	BPR7HS-10	1092		
125.0 hp (2-stroke) 1848cc 93kW	4	1994 - 1997	1,0	BPR7HS-10	1092		
135.0 hp V6	6	1998 -	1,0	BPR7HS-10	1092		
135.0 hp 135Marathon / W135 V6	6	1986 - 1997		BU8H	6431		
140.0 hp Jet 140		1995 - 1997		BU8H	6431		



Cyl.



Order No.

Iridium



Order No.

**MARINER**

140.0 hp	6			<b>BUZHW</b>	<b>2147</b>		
150.0 hp (2-stroke) V6 RFI 112kW 2507cc	6			<b>BU8H</b>	<b>6431</b>		
150.0 hp (2-stroke) V6 EFi 112kW 2507cc	6	2000 -	1,0	<b>BPZ8HS-10</b>	<b>3133</b>		
150.0 hp DFI	6	1997 -	1,1	<b>ZFR6F-11</b>	<b>4291</b>		
150.0 hp 150 / V150 / W150	6	2000 -	1,0	<b>BPR7HS-10</b>	<b>1092</b>		
150.0 hp (2-stroke) Magnum Efi,II,III 112kW 2507cc	6	1985 - 1997		<b>BU8H</b>	<b>6431</b>		
150.0 hp (2-stroke) SuperMagnum Efi, 112kW 2507cc	6	1997 -		<b>BU8H</b>	<b>6431</b>		
150.0 hp Magnum Efi I , II	6	2000 -	1,0	<b>BPR7HS-10</b>	<b>1092</b>		
150.0 hp 150 / V150 / W150	6	1979 - 1997		<b>BU8H</b>	<b>6431</b>		
175.0 hp Magnum EFi, 175 Ski	6	2000 -	1,0	<b>BPR7HS-10</b>	<b>1092</b>		
175.0 hp (2-stroke) Magnum Efi,131kW, SKi175 2507cc	6	1989 - 1997		<b>BU8H</b>	<b>6431</b>		
175.0 hp V175	6	1978 - 1997		<b>BU8H</b>	<b>6431</b>		
200.0 hp (2-stroke) Magnum /Super-Mag. EFi,V200 2507cc	6	1989 - 1997		<b>BU8H</b>	<b>6431</b>		
200.0 hp Super-Magnum Efi	6	2000 -	1,0	<b>BPR7HS-10</b>	<b>1092</b>		
200.0 hp DFI 3.0L	6	1997 -	1,1	<b>ZFR6F-11</b>	<b>4291</b>		
220.0 hp Magnum Efi, V220	6	1987 - 1988		<b>BU8H</b>	<b>6431</b>		
225.0 hp 3.0L EFi , Carb	6	1998 -		<b>BR8HS</b>	<b>4322</b>		
225.0 hp (2-stroke) Super-Mag. EFi, 3032cc 168kW	6	1997 -		<b>BU8H</b>	<b>6431</b>		
225.0 hp 3.0L EFi , Carb	6	1995 - 1997		<b>BR8HS</b>	<b>4322</b>	<b>BR8HIX</b>	<b>7001</b>
225.0 hp Marathon	6	1994 -		<b>BR8HS</b>	<b>4322</b>		
245.0 hp 2.5L Carb.	6	1995 -		<b>BU8H</b>	<b>6431</b>		
250.0 hp 3.4L	6	1989 - 1990		<b>BU8H</b>	<b>6431</b>		
250.0 hp (2-stroke) 3.0L EFi, 3032cc 186kW	6	1997 -		<b>BR8HS</b>	<b>4322</b>	<b>BR8HIX</b>	<b>7001</b>
250.0 hp 3.0L Efi	6	1998 -		<b>BR8HS</b>	<b>4322</b>		
260.0 hp 2.5L Efi	6	1995 - 1998		<b>BU8H</b>	<b>6431</b>		
265.0 hp 2.5L Efi	6	1997 -		<b>BU8H</b>	<b>6431</b>		
275.0 hp 3.4L	6	1991 - 1994		<b>BU8H</b>	<b>6431</b>		

**OptiMax**

115.0 hp Optimax		2000 -	1,0	<b>PZFR5F-11</b>	<b>4363</b>		
150.0 hp Optimax 112kW 2507cc	6	1998 -	1,1	<b>PZFR5F-11</b>	<b>4363</b>		
200.0 hp Optimax 149kW 3032cc	6	1998 -	1,1	<b>PZFR5F-11</b>	<b>4363</b>		
225.0 hp Optimax 168kW 3032cc	6		1,1	<b>PZFR5F-11</b>	<b>4363</b>		

**RFI**

60.0 hp (2-stroke) Bigfoot 45kW 967cc RFI	3		1,0	<b>BPR7HS-10</b>	<b>1092</b>		
---	---	--	-----	------------------	-------------	--	--

**MARTIN**

20 (2xPS), 100 (10PS)			0,9	<b>B6S</b>	<b>3510</b>		
40, 45 (4.5PS), 75 (7.5PS)			0,9	<b>B6S</b>	<b>3510</b>		
60, 66 (7.2PS)			0,9	<b>B6S</b>	<b>3510</b>		

**McCULLOCH**

14 PS			0,9	<b>B6S</b>	<b>3510</b>		
28, 45 PS			0,9	<b>B6S</b>	<b>3510</b>		
4 PS			0,9	<b>BP5S</b>	<b>3011</b>		
590630			0,9	<b>B6S</b>	<b>3510</b>		
9 PS			0,9	<b>BM6A</b>	<b>5921</b>		
9.5 PS			0,9	<b>B6S</b>	<b>3510</b>		



Cyl.

Order  
No.

Iridium

Order  
No.**MEDINA**

all models

0,8

**B6HS****4510****BR6HIX****3419****MERCURY**

Jet 20 M

1,0

**BPR7HS-10****1092**

Jet 65 ELPTO

**BUZHW-2****2173**

Jet 80 ELPTO

1,0

**BPR7HS-10****1092****112KW(2-stroke)2507cc**

150 EFI

6

**BU8H****6431**

150 EFI SW

6

**BU8H****6431**

150 RFI

6

**BU8H****6431**

150 RFI SW

6

**BU8H****6431**

150 XR6

6

**BU8H****6431**

150 XR6 RFI

6

**BU8H****6431****11kW(4-stroke)323cc**

F15EL Bigfoot

2

0,9

**DCPR7E****3932****DCPR7EIX****6046**

F15ML Bigfoot

2

0,9

**DCPR7E****3932****DCPR7EIX****6046****131KW(2-stroke)2507cc**

175 EFI

6

**BU8H****6431**

175 RFI

6

**BU8H****6431****168KW(2-stroke)3032cc**

225 EFI

6

0,8

**BR8HS****4322****BR8HIX****7001**

225 EFI SW

6

0,8

**BR8HS****4322****BR8HIX****7001****186KW(2-stroke)3032cc**

250 EFI SW

6

0,8

**BR8HS****4322****BR8HIX****7001****19kW(4-stroke)498cc**

F25E Bigfoot

2

0,9

**DCPR7E****3932****DCPR7EIX****6046**

F25EL Bigfoot

2

0,9

**DCPR7E****3932****DCPR7EIX****6046**

F25ELPT Bigfoot

2

0,9

**DCPR7E****3932****DCPR7EIX****6046**

F25ML Bigfoot

2

0,9

**DCPR7E****3932****DCPR7EIX****6046****22kW(4-stroke)747cc**

F30EL Bigfoot

3

0,9

**DCPR7E****3932****DCPR7EIX****6046**

F30ELPT Bigfoot

3

0,9

**DCPR7E****3932****DCPR7EIX****6046**

F30M Bigfoot

3

0,9

**DCPR7E****3932****DCPR7EIX****6046**

F30ML Bigfoot

3

0,9

**DCPR7E****3932****DCPR7EIX****6046****30kW(4-stroke)747cc**

F40EL

3

1,0

**BPR7HS-10****1092**

F40EL RFI

3

1,0

**BPR7HS-10****1092**

F40ELPT

3

1,0

**BPR7HS-10****1092**

F40ELPT RFI

3

1,0

**BPR7HS-10****1092**



Cyl.



Order No.

Iridium



Order No.

**MERCURY**

		<b>30kW(4-stroke)747cc</b>							
F40ML		3		1,0	<b>BPR7HS-10</b>	<b>1092</b>			
F40ML	RFI	3		1,0	<b>BPR7HS-10</b>	<b>1092</b>			
		<b>30kW(4-stroke)995cc</b>							
F40ELPT	Bigfoot	4	2000 -	0,9	<b>DCPR7E</b>	<b>3932</b>	<b>DCPR7EIX</b>	<b>6046</b>	
F40ML	Bigfoot	4	2000 -	0,9	<b>DCPR7E</b>	<b>3932</b>	<b>DCPR7EIX</b>	<b>6046</b>	
		<b>37kW(2-stroke)967cc</b>							
F50ELPTO		3		1,0	<b>BPR7HS-10</b>	<b>1092</b>			
F50ELPTO	RFI	3		1,0	<b>BPR7HS-10</b>	<b>1092</b>			
		<b>37kW(4-stroke)995cc</b>							
F50ELPT	Bigfoot	4	2000 -	0,9	<b>DCPR7E</b>	<b>3932</b>	<b>DCPR7EIX</b>	<b>6046</b>	
		<b>45kW(2-stroke)967cc</b>							
60ELPTO	Bigfoot	3		1,0	<b>BPR7HS-10</b>	<b>1092</b>			
60ELPTO	Bigfoot RFI	3		1,0	<b>BPR7HS-10</b>	<b>1092</b>			
		<b>67kW(2-stroke)1386cc</b>							
90ELPTO		3			<b>BUHW-2</b>	<b>5626</b>			
90ELPTO	RFI	3			<b>BUZHW-2</b>	<b>2173</b>			
		<b>7kW(4-stroke)323cc</b>							
F9.9EL		2		0,9	<b>BP5HA</b>	<b>7426</b>			
F9.9EL	Bigfoot	2		0,8	<b>C7HSA</b>	<b>4629</b>			
F9.9M		2		0,7	<b>BP5HA</b>	<b>7426</b>			
F9.9M	RFI	2		1,0	<b>BPR7HS-10</b>	<b>1092</b>			
		<b>93KW(2-stroke)1848cc</b>							
125		4		1,0	<b>BPR7HS-10</b>	<b>1092</b>			
125	RFI	4		1,0	<b>BPZ8HN-10</b>	<b>4495</b>			
		<b>Customer Performance 209kW</b>							
2.5 EFI Offshore	2507cc		1999 -	0,8	<b>BR8HS</b>	<b>4322</b>	<b>BR8HIX</b>	<b>7001</b>	
		<b>Jet Series</b>							
25 hp	20 Jet 400cc	2			<b>BUZHW-2</b>	<b>2173</b>			
40 hp	30 Jet 719cc	4			<b>BUZHW</b>	<b>2147</b>			
60 hp	45 Jet 8490cc	3			<b>BUZHW-2</b>	<b>2173</b>			
90 hp	65 Jet 1386cc	4			<b>BUZHW</b>	<b>2147</b>			
115 hp	80 Jet 1848cc	4			<b>BUZHW-2</b>	<b>2173</b>			
		<b>Mercury Series with Thunderbolt Ignition</b>							
2.2 hp		1	1984 - 1989	1,0	<b>BPR6HS-10</b>	<b>2633</b>			
2.5 hp		1	1993 -	0,8	<b>BPR6HS</b>	<b>7022</b>	<b>BPR6HIX</b>	<b>4085</b>	
3.0 hp		1	1990 - 1992	0,8	<b>BPR7HS</b>	<b>6422</b>	<b>BPR7HIX</b>	<b>5944</b>	
3.3 hp		1	1993 - 1997	0,8	<b>BPR7HS</b>	<b>6422</b>	<b>BPR7HIX</b>	<b>5944</b>	
3.3 hp		1	1998 -	0,8	<b>BPR6HS</b>	<b>7022</b>	<b>BPR6HIX</b>	<b>4085</b>	
3.5 hp		1	1983 - 1985	0,8	<b>BPR7HS</b>	<b>6422</b>	<b>BPR7HIX</b>	<b>5944</b>	



Cyl.

Order  
No.

Iridium

Order  
No.**MERCURY***Mercury Series with Thunderbolt Ignition*

3.6 hp	1	1980 - 1982	0,8	BPR7HS	6422	BPR7HIX	5944
4.0 hp	1	1976 - 1979	0,6	B6HS	4510	BR6HIX	3419
4.0 hp	1	1986 - 1987		BUZHW-2	2173		
4.0 hp	1	1980 - 1982	0,8	BPR7HS	6422	BPR7HIX	5944
4.0 hp	1	1970 - 1974		BUZHW-2	2173		
4.0 hp	1	1988 - 1997	0,8	BPR7HS	6422	BPR7HIX	5944
4.0 hp (2-stroke)	1	1988 -	0,8	BPR7HS	6422	BPR7HIX	5944
4.0 hp (4-stroke)	1	2000 -	0,9	DCPR7E	3932	DCPR7EIX	6046
4.5 hp	1	1975 - 1985		BUZHW-2	2173		
5.0 hp (4-stroke)	1	2000 -	0,9	DCPR7E	3932	DCPR7EIX	6046
5.0 hp (2-stroke)	1	1998 -	0,8	BPR7HS	6422	BPR7HIX	5944
5.0 hp	1	1988 - 1997	0,8	BPR7HS	6422	BPR7HIX	5944
6.0 hp (4-stroke)	2	2000 -	0,9	DCPR7E	3932	DCPR7EIX	6046
6.0 hp (2-stroke)	2	1998 -	1,0	BP8HN10	4838		
6.0 hp	2	1986 - 1997	0,8	BPR7HS	6422	BPR7HIX	5944
7.5 hp	2	1970 - 1978		BUZHW-2	2173		
7.5 hp	2	1979 - 1985	0,8	BZ7HS-10	3579		
8.0 hp	2	1998 -	1,5	BPZ8HS15	3133		
8.0 hp	2	1986 - 1997	0,8	BPR7HS	6422	BPR7HIX	5944
8.0 hp Bodensee	2	1995 - 1999	0,7	C7HSA	4629		
9.8 hp	2	1979 - 1985	0,8	BZ7HS-10	3579		
9.8 hp	2	1970 - 1978		BUZHW-2	2173		
9.9 hp (4-stroke)	2	1995 - 1997	0,7	C7HSA	4629		
9.9 hp (2-stroke)	2	1995 - 1997	1,0	BPZ8HN-10	4495		
9.9 hp (2-stroke)	2	1998 -	1,5	BPZ8HS15	3133		
9.9 hp (4-stroke)	2	1998 -	0,9	DCPR7E	3932	DCPR7EIX	6046
9.9 hp	2	1986 - 1994	0,8	BPR7HS	6422	BPR7HIX	5944
10.0 hp	2	1991 - 1996	1,0	BPZ8HN-10	4495		
10.0 hp Sea Pro	2	1997 -	1,0	BPZ8HN-10	4495		
10.0 hp Sea Pro	2	1991 - 1996	1,0	BPZ8HN-10	4495		
15.0 hp Sea Pro	2	1998 -	0,9	BP5HA	7426		
15.0 hp (4-stroke) Bigfoot	2	1998 -	0,9	DCPR7E	3932	DCPR7EIX	6046
15.0 hp	2	1989 - 1997	1,0	BPZ8HN-10	4495		
15.0 hp (2-stroke)	2	1998 -	1,5	BPZ8HS15	3133		
15.0 hp Sea Pro	2	1995 - 1997	1,0	BPZ8HN-10	4495		
18.0 hp	2	1980 - 1985	0,8	BZ7HS-10	3579		
20.0 hp	2	1986 - 1997	0,8	BPR7HS	6422	BPR7HIX	5944
20.0 hp Jet	2	1995 -	0,8	BPR7HS	6422	BPR7HIX	5944
20.0 hp (2-stroke)	2	1998 -	0,8	BPR7HS	6422	BPR7HIX	5944
20.0 hp	2	1970 - 1981		BUZHW-2	2173		
25.0 hp Sea Pro (2-stroke)	2	1998 -	0,8	BPR7HS	6422	BPR7HIX	5944
25.0 hp	2	1980 - 1997	0,8	BPR7HS	6422	BPR7HIX	5944
25.0 hp (4-stroke) Bigfoot	2	1997 -	0,9	DCPR7E	3932	DCPR7EIX	6046
25.0 hp Sea Pro	2	1998	0,8	BPR7HS	6422	BPR7HIX	5944
25.0 hp (4-stroke)	2	1998 -	0,9	DCPR7E	3932	DCPR7EIX	6046
25.0 hp Sea Pro	2	1993 - 1997	0,8	BPR7HS	6422	BPR7HIX	5944
30.0 hp Sea Pro	2	1995 - 1997	0,8	BPR7HS	6422	BPR7HIX	5944
30.0 hp Jet	2	1995 - 1997		BUZHW-2	2173		
30.0 hp Jet	3	1998 -	0,8	BPR7HS	6422	BPR7HIX	5944
30.0 hp Sea Pro	2	1998 -	0,8	BPR7HS	6422	BPR7HIX	5944
30.0 hp (4-stroke)	2	1999 -	0,9	DCPR7E	3932	DCPR7EIX	6046
30.0 hp (2-stroke)	2	1995 -	0,8	BPR7HS	6422	BPR7HIX	5944



Cyl.



Order No.

Iridium



Order No.

**MERCURY****Mercury Series with Thunderbolt Ignition**

35.0 hp	2	1984 - 1991		BUZHW	2147		
40.0 hp	3	1970 - 1983		BUZHW	2147		
40.0 hp	3	1995 -	1,0	BPZ8HN-10	4495		
40.0 hp	3	1997 -	1,0	BPZ8HN-10	4495		
40.0 hp	3	1988 - 1997		BUZHW-2	2173		
40.0 hp Sea Pro	2	1995 - 1997	1,0	BPZ8HN-10	4495		
40.0 hp Sea Pro	3	1995 - 1997	1,0	BPZ8HN-10	4495		
40.0 hp Sea Pro		1998 -	1,0	BPZ8HN-10	4495		
40.0 hp (4-stroke)Bigfoot D706		1998 -	0,9	DCPR7E	3932	DCPR7EIX	6046
45.0 hp 45 Jet		1995 - 1997	1,0	BPZ8HN-10	4495		
45.0 hp 45 Bodensee	4	1998 -	0,9	DCPR7E	3932	DCPR7EIX	6046
45.0 hp 45 Jet	3	1998 -	1,0	BPZ8HN-10	4495		
45.0 hp 45 Bodensee		1995 - 1997	0,9	DCPR7E	3932	DCPR7EIX	6046
45.0 hp		1986 - 1989		BUZHW-2	2173		
50.0 hp (4-stroke)	4	1995 - 1997	0,9	DCPR7E	3932	DCPR7EIX	6046
50.0 hp (4-stroke)Bigfoot	4	1995 -	0,9	DCPR7E	3932	DCPR7EIX	6046
50.0 hp (2-stroke)	3	1998 -	1,0	BPZ8HN-10	4495		
50.0 hp	3	1991 - 1997	1,0	BPZ8HN-10	4495		
50.0 hp		1970 - 1990		BUZHW	2147		
50.0 hp 500SS		1966 - 1969		BUZHW	2147		
55.0 hp Sea Pro		1992 -	1,0	BPZ8HN-10	4495		
60.0 hp (4-stroke)	4	2001 -	0,9	DCPR7E	3932	DCPR7EIX	6046
60.0 hp Sea Pro	3	1998 -	1,0	BPZ8HN-10	4495		
60.0 hp	3	1991 -	1,0	BPZ8HN-10	4495		
60.0 hp Big Foot, Sea Pro	3	1995 - 1997	1,0	BPZ8HN-10	4495		
60.0 hp		1980 - 1984		BUZHW	2147		
60.0 hp Big Foot	3	1998 -	1,0	BPZ8HN-10	4495		
65.0 hp 65 Jet		1995 -		BUZHW-2	2173		
65.0 hp 650SS		1966 - 1969		BUZHW	2147		
65.0 hp		1970 - 1976		BUZHW	2147		
70.0 hp		1977 - 1983		BUZHW	2147		
70.0 hp		1987 - 1989		BUZHW-2	2173		
75.0 hp (4-stroke)	4	2000 -	1,1	LFR5A-11	6376		
75.0 hp	4	1984 - 1986		BUZHW-2	2173		
75.0 hp (2-stroke)	3	1998 -		BUZHW-2	2173		
75.0 hp (2-stroke) Sea Pro		1998 -		BUZHW-2	2173		
75.0 hp Sea Pro		1990 - 1997		BUZHW-2	2173		
75.0 hp	3	1987 - 1997		BUZHW-2	2173		
80.0 hp 80 Jet		1995 - 1997	1,0	BPZ8HN-10	4495		
80.0 hp		1969 - 1972		BUZHW	2147		
80.0 hp		1978 - 1989		BUZHW-2	2173		
80.0 hp 800		1966 - 1969		BU8H	6431		
80.0 hp 80 Jet		1998 -	1,0	BPZ8HN-10	4495		
85.0 hp		1973 - 1977		BUZHW	2147		
90.0 hp (4-stroke)	4	2000 -	1,1	LFR5A-11	6376		
90.0 hp	3	1987 - 1997		BUZHW-2	2173		
90.0 hp	6	1978 - 1986		BUZHW	2147		
90.0 hp (2-stroke)	3	1998 -		BUZHW-2	2173		
95.0 hp 950, 950SS		1966 - 1969		BU8H	6431		
100.0 hp		1988 - 1994	1,0	BPZ8HN-10	4495		
100.0 hp		1996 -	1,0	BPZ8HN-10	4495		
100.0 hp 1000BP, 1000SS		1966 - 1969		BU8H	6431		





Cyl.

Order  
No.

Iridium

Order  
No.**MERCURY*****Mercury Series with Thunderbolt Ignition***

105.0 hp 105 Jet		1995 - 1997		<b>BU8H</b>	<b>6431</b>		
110.0 hp 1100BP, 1100SS		1966 - 1969		<b>BU8H</b>	<b>6431</b>		
115.0 hp	4	1989 - 1997	1,0	<b>BPZ8HN-10</b>	<b>4495</b>		
115.0 hp (2-stroke)	4	1998 -	1,0	<b>BPZ8HN-10</b>	<b>4495</b>		
115.0 hp	6	1970 - 1988		<b>BUZHW</b>	<b>2147</b>		
125.0 hp	4	1994 -	1,0	<b>BPZ8HN-10</b>	<b>4495</b>		
125.0 hp 1250BP, 1250SS		1966 - 1969		<b>BU8H</b>	<b>6431</b>		
135.0 hp	6	1986 - 1997		<b>BU8H</b>	<b>6431</b>		
135.0 hp	6	1970 - 1971		<b>BUZHW</b>	<b>2147</b>		
135.0 hp EFI (4stroke)Supercharged	6	2006 -		<b>ILFR6G</b>	<b>5588</b>		
135.0 hp V6	6	2000 -	0,8	<b>BPR7HS</b>	<b>6422</b>	<b>BPR7HIX</b>	<b>5944</b>
140.0 hp	6	1970 - 1980		<b>BUZHW</b>	<b>2147</b>		
140.0 hp 140 Jet	6	1995 - 1997		<b>BU8H</b>	<b>6431</b>		
150.0 hp V6 XRI	6	1993 - 1997		<b>BU8H</b>	<b>6431</b>		
150.0 hp	6	1973 - 1977		<b>BUZHW</b>	<b>2147</b>		
150.0 hp V6 Efi	6	2000 -	1,0	<b>BPZ8HS-10</b>	<b>3133</b>		
150.0 hp V6	6	1978 - 1997		<b>BU8H</b>	<b>6431</b>		
150.0 hp V6 XR2, XR4, XR6	6	1985 - 1999		<b>BU8H</b>	<b>6431</b>		
150.0 hp EFI (4stroke) Supercharged	6	2006 -		<b>ILFR6G</b>	<b>5588</b>		
175.0 hp V6 XRI EFI	6	2000 -	0,8	<b>BPR7HS</b>	<b>6422</b>	<b>BPR7HIX</b>	<b>5944</b>
175.0 hp V6	6	1976 - 1997		<b>BU8H</b>	<b>6431</b>		
175.0 hp V6 XRI	6	1991 - 1997		<b>BU8H</b>	<b>6431</b>		
175.0 hp	6	1991 -		<b>BUZHW</b>	<b>2147</b>		
175.0 hp EFI (4stroke) Supercharged	6	2006 -		<b>ILFR6G</b>	<b>5588</b>		
200.0 hp SST 120 EFI 2.0L	6	1997 -		<b>BU8H</b>	<b>6431</b>		
200.0 hp EFI (4stroke) Supercharged	6	2006 -		<b>ILFR6G</b>	<b>5588</b>		
200.0 hp EFI (4stroke) Verado	6	2004 -		<b>ILFR6G</b>	<b>5588</b>		
200.0 hp Deuce High EFI 2.0L	6	1997 -		<b>BUZHW</b>	<b>2147</b>		
200.0 hp V6 XRI EFI	6	2000 -	0,8	<b>BPR7HS</b>	<b>6422</b>	<b>BPR7HIX</b>	<b>5944</b>
200.0 hp V6	6	1978 - 1997		<b>BU8H</b>	<b>6431</b>		
200.0 hp V6	6	2000 -	0,8	<b>BPR7HS</b>	<b>6422</b>	<b>BPR7HIX</b>	<b>5944</b>
200.0 hp	6	1991 -		<b>BUZHW</b>	<b>2147</b>		
200.0 hp V6 DFI 3.0L	6	1996 - 1997	1,1	<b>ZFR6F-11</b>	<b>4291</b>		
200.0 hp XR2 SS EFI 2.0L	6	1997 -		<b>BUZHW</b>	<b>2147</b>		
200.0 hp V6 XRI	6	1989 - 1997		<b>BU8H</b>	<b>6431</b>		
220.0 hp XRI	6	1987 - 1988		<b>BU8H</b>	<b>6431</b>		
225.0 hp V6 Sea Pro 3.0L	6	1998 -	0,8	<b>BR8HS</b>	<b>4322</b>	<b>BR8HIX</b>	<b>7001</b>
225.0 hp 2.5L	6	1991 -		<b>BUZHW</b>	<b>2147</b>		
245.0 hp 2.5L	6	1995 - 1996		<b>BU8H</b>	<b>6431</b>		
225.0 hp V6	6	1994 - 1997	1,0	<b>BPZ8HN-10</b>	<b>4495</b>		
225.0 hp V6 DFI 3.0L	6	1997 -	1,1	<b>ZFR6F-11</b>	<b>4291</b>		
225.0 hp V6	6	1998 -	0,8	<b>BR8HS</b>	<b>4322</b>		
225.0 hp	6	1980 - 1981		<b>BU8H</b>	<b>6431</b>		
225.0 hp V6 Sea Pro 3.0L	6	1995 - 1997	1,0	<b>BPZ8HN-10</b>	<b>4495</b>		
225.0 hp V6 XRI EFI	6	1998 -	0,8	<b>BR8HS</b>	<b>4322</b>		
225.0 hp V6 XRI EFI	6	1995 - 1997	0,8	<b>BR8HS</b>	<b>4322</b>		
225.0 hp EFI (4stroke) Verado	6	2004 -		<b>ILFR6G</b>	<b>5588</b>		
225.0 hp EFI (4stroke) Supercharged	6	2006 -		<b>ILFR6G</b>	<b>5588</b>		
250.0 hp EFI (4stroke) Supercharged	6	2006 -		<b>ILFR6G</b>	<b>5588</b>		
250.0 hp EFI (4stroke) Verado	6	2004 -		<b>ILFR6G</b>	<b>5588</b>		
250.0 hp V6 XRI EFI	6	1995 -	0,8	<b>BR8HS</b>	<b>4322</b>	<b>BR8HIX</b>	<b>7001</b>
250.0 hp 3.4L	6	1989 - 1990		<b>BU8H</b>	<b>6431</b>		



Cyl.



Order No.

Iridium



Order No.

**MERCURY****Mercury Series with Thunderbolt Ignition**

260.0 hp	2.5L Offshore		1995 - 1998		<b>BU8H</b>	<b>6431</b>		
265.0 hp	2.5L SS Drag EFI		1997 -		<b>BU8H</b>	<b>6431</b>		
275.0 hp	3.4L		1984 - 1988		<b>BU8H</b>	<b>6431</b>		
275.0 hp	EFI (4stroke) Supercharged	6	2006 -		<b>ILFR6G</b>	<b>5588</b>		
275.0 hp	EFI (4stroke) Verado	6	2004 -		<b>ILFR6G</b>	<b>5588</b>		
275.0 hp			1989 - 1994		<b>BU8H</b>	<b>6431</b>		
280.0 hp	2.0L F1 EFI		1997 -		<b>BU8H</b>	<b>6431</b>		
300.0 hp	2.5L S3000 EFI		1997 -		<b>BU8H</b>	<b>6431</b>		
300.0 hp			1980 - 1983		<b>BUZHW</b>	<b>2147</b>		

**Optimax 115ELPT 86kW 1526cc**

115			2005 -				<b>IZFR5J</b>	
-----	--	--	--------	--	--	--	---------------	--

**Optimax 115XL 85kW 1526cc**

115			2005 -				<b>IZFR5J</b>	
-----	--	--	--------	--	--	--	---------------	--

**Optimax 75ELPT 67kW 1526cc**

75			2005 -				<b>IZFR5J</b>	
----	--	--	--------	--	--	--	---------------	--

**Optimax 90ELPT 67kW 1526cc**

90			2005 -				<b>IZFR5J</b>	
----	--	--	--------	--	--	--	---------------	--

**Optimax 300 XS 3.16L**

300 xs	(2stroke)	6	2007 -				<b>IZFR7M</b>	<b>4214</b>
--------	-----------	---	--------	--	--	--	---------------	-------------

**Optimax Dig 85kW**

115			2000 - 2004				<b>IZFR5G</b>	<b>5887</b>
-----	--	--	-------------	--	--	--	---------------	-------------

**Optimax Dig 101kW**

101			2000 -				<b>IZFR5G</b>	<b>5887</b>
-----	--	--	--------	--	--	--	---------------	-------------

**Optimax Dig 101kW 2507cc**

135		6	2000 -	1,1	<b>PZFR5F-11</b>	<b>4363</b>		
135		6	2001 -	1,1	<b>LFR5A-11</b>	<b>6376</b>		

**Optimax Dig 101kW 507cc**

135		6	2000 -	1,1	<b>PZFR5F-11</b>	<b>4363</b>		
135		6	2001 -	1,1	<b>LFR5A-11</b>	<b>6376</b>		

**Optimax Dig 112kW 2507cc**

150		6	2003 -				<b>IZFR5G</b>	<b>5887</b>
150		6	1998 - 2002	1,1	<b>PZFR5F-11</b>	<b>4363</b>		



Cyl.

Order  
No.

Iridium

Order  
No.**MERCURY**

<b>MERCURY</b>							
<b>Optimax Dig 149kW 3032cc</b>							
200		6	1998 - 2002	1,1	PZFR5F-11	4363	
200		6	2003 -				IZFR5G 5887
<b>Optimax Dig 168kW 3032cc</b>							
225		6	1998 - 2002	1,1	PZFR5F-11	4363	
225		6	2003 -				IZFR5G 5887
<b>Racing 134kW</b>							
SST 120	1998cc				BUHW	2622	
SST 120	1998cc RFI				BUZHW	2147	
<b>Racing 224kW</b>							
2.5 Drag	2507cc				BU8H	6431	
2.5 Drag	2507cc RFI				BU8H	6431	
S3000	2507cc				BU8H	6431	
<b>Racing 224kW</b>							
S3000	2507cc RFI				BU8H	6431	
<b>Sea Pro</b>							
10M			1991 - 2000	1,5	BP8HS-15	6729	
10M	RFI			1,0	BPZ8HN-10	4495	
10ML			1991 - 2000	1,5	BP8HS-15	6729	
10ML	RFI			1,0	BPZ8HN-10	4495	
15M				0,9	BP5HA	7426	
15M	RFI		1995 - 1996	1,0	BP8HS-10	3823	
15ML	RFI		1995 - 1996	1,0	BP8HS-10	3823	
15ML				0,9	BP5HA	7426	
25M				1,0	BP7HS-10	7829	
25M	RFI			1,0	BPZ8HN-10	4495	
25ML				1,0	BP7HS-10	7829	
25ML	RFI			1,0	BPZ8HN-10	4495	
40ML				1,0	BP7HS-10	7829	
40ML	RFI			1,0	BPZ8HN-10	4495	
40MLL	RFI			1,0	BPZ8HN-10	4495	
40MLL				1,0	BP7HS-10	7829	
55ML				1,0	BP7HS-10	7829	
55ML	RFI			1,0	BPZ8HN-10	4495	
55MLL				1,0	BP7HS-10	7829	
55MLL	RFI			1,0	BPZ8HN-10	4495	
60ML	RFI			1,0	BPZ8HN-10	4495	
60ML				1,0	BP7HS-10	7829	
60MLL				1,0	BP7HS-10	7829	
60MLL	RFI			1,0	BPZ8HN-10	4495	
75ELH	RFI				BUZHW-2	2173	
75ELH					BUZHW-2	2173	
75ELLH	RFI				BUZHW-2	2173	
75ELLH					BUZHW-2	2173	
75ML	RFI				BUZHW-2	2173	
75ML					BUZHW-2	2173	



Cyl.



Order No.

Iridium



Order No.

**MERCURY****Sea Pro**75MLL RFI  
75MLLBUZHW-2 2173  
BUZHW-2 2173**Verado 99kW 1732cc**135L 2006 -  
135XL 2006 -ILFR6G  
ILFR6G**Verado 110kW 1732cc**150L 2006 -  
150XL 2006 -ILFR6G  
ILFR6G**Verado 149kW 2598cc**200L 2006 -  
200XL 2006 -ILFR6G  
ILFR6G**Verado 168kW 2598cc**225L 2006 -  
225XL 2006 -ILFR6G  
ILFR6G**Verado 186kW 2598cc**250L 2006 -  
250XL 2006 -ILFR6G  
ILFR6G**Verado 205kW 2598cc**275L 2006 -  
275XL 2006 -ILFR6G  
ILFR6G**MIGHTY MITE**1.7hp 0,6 B2 3110  
2.0hp 0,6 B2 3110**MONO**M-50 0,8 B6S 3510  
M-5A, M-6A 0,8 B6S 3510  
M-75 0,8 BP5S 3011**MOSKVA**Moskva-25 0,8 BP6HS 4511 BPR6HIX 4085  
Moskva-30D 0,8 BP6ES 7811**NAUTILO**100 (5PS) 0,5 B6HS 4510 BR6HIX 3419  
75 (3PS) 0,5 B6HS 4510 BR6HIX 3419



Cyl.

Order  
No.

Iridium

Order  
No.**NEPTUNE**

1A39			0,6	<b>B6S</b>	<b>3510</b>		
4A39			0,6	<b>B6S</b>	<b>3510</b>		
5A39			0,6	<b>B6S</b>	<b>3510</b>		
9A39			0,6	<b>B6S</b>	<b>3510</b>		
10A1			0,6	<b>B6S</b>	<b>3510</b>		
10A16			0,6	<b>A6</b>	<b>1010</b>		
10A4/A6/A10			0,6	<b>B6S</b>	<b>3510</b>		
11A1			0,6	<b>B4</b>	<b>3210</b>		
11A10			0,6	<b>B6S</b>	<b>3510</b>		
11A12			0,6	<b>A6</b>	<b>1010</b>		
11A16			0,6	<b>A6</b>	<b>1010</b>		
11A3/AA3			0,6	<b>B6S</b>	<b>3510</b>		
11A6/AA6			0,6	<b>B6S</b>	<b>3510</b>		
15A1			0,6	<b>B4</b>	<b>3210</b>		
15A3/AA3			0,6	<b>B6S</b>	<b>3510</b>		
15A6 / AA6			0,6	<b>B6S</b>	<b>3510</b>		
15A9/AA9			0,6	<b>B6S</b>	<b>3510</b>		
16A39			0,6	<b>A6</b>	<b>1010</b>		
17A1, 17A2, 17A3, A1,AA1, AA1A			0,6	<b>B6S</b>	<b>3510</b>		
101			0,6	<b>B6S</b>	<b>3510</b>		
104			0,6	<b>B6S</b>	<b>3510</b>		
106			0,6	<b>B6S</b>	<b>3510</b>		
111			0,6	<b>B4</b>	<b>3210</b>		
113			0,6	<b>B6S</b>	<b>3510</b>		
114			0,6	<b>B6S</b>	<b>3510</b>		
116			0,6	<b>B6S</b>	<b>3510</b>		
139			0,6	<b>B6S</b>	<b>3510</b>		
189			0,6	<b>B6S</b>	<b>3510</b>		
238			0,6	<b>A6</b>	<b>1010</b>		
239			0,6	<b>A6</b>	<b>1010</b>		
438			0,6	<b>A6</b>	<b>1010</b>		
439			0,6	<b>A6</b>	<b>1010</b>		
539			0,6	<b>B6S</b>	<b>3510</b>		
639			0,6	<b>A6</b>	<b>1010</b>		
938			0,6	<b>B6S</b>	<b>3510</b>		
939			0,6	<b>B6S</b>	<b>3510</b>		
1010			0,6	<b>B6S</b>	<b>3510</b>		
1016			0,6	<b>A6</b>	<b>1010</b>		
1110			0,6	<b>B6S</b>	<b>3510</b>		
1638			0,6	<b>A6</b>	<b>1010</b>		
1639			0,6	<b>A6</b>	<b>1010</b>		
A2			0,6	<b>B6S</b>	<b>3510</b>		
AA2			0,6	<b>B6S</b>	<b>3510</b>		
AA4			0,6	<b>B6S</b>	<b>3510</b>		
AA6			0,6	<b>B6S</b>	<b>3510</b>		
AA10			0,6	<b>B6S</b>	<b>3510</b>		
OB1			0,6	<b>A6</b>	<b>1010</b>		
OB2			0,6	<b>A6</b>	<b>1010</b>		
OB2C			0,6	<b>A6</b>	<b>1010</b>		
OB3			0,6	<b>A6</b>	<b>1010</b>		
OB4			0,6	<b>A6</b>	<b>1010</b>		
OB11			0,6	<b>A6</b>	<b>1010</b>		



Cyl.



Order No.

Iridium



Order No.

**NEPTUNE**

OB12			0,6	A6	1010		
OB31			0,6	A6	1010		
OB32			0,6	A6	1010		
OB34			0,6	A6	1010		
OB51			0,6	A6	1010		
OB63			0,6	A6	1010		
OB64			0,6	A6	1010		
OB65			0,6	A6	1010		
OB102			0,6	A6	1010		
OB112			0,6	A6	1010		

**NISSAN**

NS 2.5A 2.5hp		- 2001	1,0	BPR6HS-10	2633		
NS 2.5A 2.5hp		1985 - 1996	1,0	BP6HS-10	6326		
NS 3.5A 3.5hp		1997 - 2001	1,0	BPR6HS-10	2633		
NS 3.5B 3.5hp		1997 -	1,0	BPR6HS-10	2633		
NS 3.5A 3.5hp		1985 - 1992	1,0	BP6HS-10	6326		
NS 3.5B 3.5hp		1993 - 1996	1,0	BP6HS-10	6326		
NSF 4A 4.0hp		2000 -	0,8	DCPR6E	3481		
NS 5B 5.0hp		1997 -	1,0	BPR7HS-10	1092		
NSF 5A 5.0hp		1999 -	0,8	DCPR6E	3481		
NS 5 5 hp		1985 - 1996	1,0	BP7HS-10	7829		
NSF 6A 6.0 hp 4-Stroke		2004 -	0,8	DCPR6E	3481		
NS 8B 8.0hp		1997 -	1,0	BPR7HS-10	1092		
NS 8B 8.0hp		1987 - 1996	1,0	BP7HS-10	7829		
NS 8A 8 hp		1985 - 1986	1,0	BP7HS-10	7829		
NSF 8A 8.0 hp 4-Stroke		2004 -	0,8	DCPR6E	3481		
NS 9.8B 9.8hp		1998 -	1,0	BPR7HS-10	1092		
NSF 9.9B 9.9 hp 4-Stroke		2004 -	0,8	DCPR6E	3481		
NS 9.9C 9.9 hp		2004 -	1,0	B7HS-10	2129		
NS 9.9D 9.9 hp		2004 -	1,0	B7HS-10	2129		
NSF 9.9A 9.9hp		2000 -	0,8	DCPR6E	3481		
NS 9.9B 9.9hp		1985 - 1986	1,0	B7HS-10	2129		
NS 9.9B 9.9hp		1997 -	1,0	BP7HS-10	7829		
NS 12 12hp		1985 - 1987	1,0	B7HS-10	2129		
NS 12C 12 hp		2004 -	1,0	BR7HS-10	1098		
NS 12 12hp		1994 -	1,0	B7HS-10	2129		
NS 15D 15 hp		2004 -	1,0	BR7HS-10	1098		
NS 15B 15 hp		1982 - 1985	1,0	B7HS-10	2129		
NS 15C 15 hp		2004 -	1,0	B7HS-10	2129		
NSF 15A 15 hp 4-Stroke		2004 -	0,8	DCPR6E	3481		
NSF 15B 15 hp 4-Stroke		2004 -	0,8	DCPR6E	3481		
NS 15C 15hp		1997 - 1999	1,0	BPR7HS-10	1092		
NS 15B 15hp		1985 - 1992	1,0	B7HS-10	2129		
NS 15D 15hp		2000 - 2001	1,0	BPR7HS-10	1092		
NS 15C 15hp		1993 - 1996	1,0	BP7HS-10	7829		
NS 15B 15 hp		2004 -	1,0	BR7HS-10	1098		
NS 18C 18hp		1985 - 1992	1,0	B7HS-10	2129		
NS 18 18hp		1997 - 1999	1,0	BR7HS-10	1098		
NS 18E 18hp		2000 -	1,0	BPR7HS-10	1092		



Cyl.

Order  
No.

Iridium

Order  
No.**NISSAN**

NS 18	18hp		1993 - 1996	1,0	<b>B7HS-10</b>	<b>2129</b>		
NS 18C	18 hp		2004 -	1,0	<b>B7HS-10</b>	<b>2129</b>		
NS 18D	18 hp		2004 -	1,0	<b>B7HS-10</b>	<b>2129</b>		
NSF 18B	18 hp	4-Stroke	2004 -	0,8	<b>DCPR6E</b>	<b>3481</b>		
NSF 25A	25 hp	4-Stroke	2004 -	0,8	<b>DCPR6E</b>	<b>3481</b>		
NS 25	25hp		1986 - 1996	1,0	<b>B7HS-10</b>	<b>2129</b>		
NS 25C	25 hp		1997 -	1,0	<b>BR7HS-10</b>	<b>1098</b>		
NS 25C3	25hp		1997 - 2001	1,0	<b>BR7HS-10</b>	<b>1098</b>		
NS 30A	30hp		1997 - 2001	1,0	<b>BR7HS-10</b>	<b>1098</b>		
NSF 30A	30 hp	4-Stroke	2004 -	0,8	<b>DCPR6E</b>	<b>3481</b>		
NS 30A	30hp		1986 - 1996	1,0	<b>B7HS-10</b>	<b>2129</b>		
NS 35C	35hp		1994 - 1995	1,0	<b>B7HS-10</b>	<b>2129</b>		
NSD 40B	40 hp	TLDI	2004 -	0,8	<b>PZFR6H</b>	<b>7696</b>		
NS 40C	40hp		1985 - 1992	1,0	<b>B7HS-10</b>	<b>2129</b>		
NS 40D	40hp		1991 - 1996	1,0	<b>B7HS-10</b>	<b>2129</b>		
NSD 40A	40 hp	TLDI	2004 -	1,1	<b>ZFR6F-11</b>	<b>4291</b>		
NS 40D	40hp		1997 -	1,0	<b>BR7HS-10</b>	<b>1098</b>		
NS 40C	40 hp		2004 -	1,0	<b>BR7HS-10</b>	<b>1098</b>		
NS 45A	45hp		1994 - 1995	1,0	<b>B8HS-10</b>	<b>5126</b>		
W 50B	50 hp	TLDI	2004 -	0,8	<b>PZFR6H</b>	<b>7696</b>		
NS 50D	50hp		1991 - 1996	1,0	<b>B8HS-10</b>	<b>5126</b>		
NS 50C	50 hp		1985 - 1992	1,0	<b>B8HS-10</b>	<b>5126</b>		
NS 50D	50hp		1997 -	1,0	<b>BR8HS-10</b>	<b>1134</b>		
NS 50C	50hp		1985 - 1992	1,0	<b>B8HS-10</b>	<b>5126</b>		
NSD 50B	50 hp	TLDI	2004 -	0,8	<b>PZFR6H</b>	<b>7696</b>		
NSD 50A	50 hp	TLDI	2004 -	1,1	<b>ZFR6F-11</b>	<b>4291</b>		
NS 60C	60 hp		2004 -	1,0	<b>BR8HS-10</b>	<b>1134</b>		
NS 60B	60 hp		2004 -	1,0	<b>B8HS-10</b>	<b>5126</b>		
NS 60A	60hp		1987 - 1992	1,0	<b>B8HS-10</b>	<b>5126</b>		
NS 60B	60hp		1993 - 1995	1,0	<b>B8HS-10</b>	<b>5126</b>		
NS 55	60hp		1985 - 1986	1,0	<b>B8HS-10</b>	<b>5126</b>		
NS 70B	70hp		1986 - 1996	1,0	<b>B8HS-10</b>	<b>5126</b>		
NS 70C	70hp		2000 -	1,0	<b>BR8HS-10</b>	<b>1134</b>		
NSD 70B	70 hp	TLDI	2004 -	0,8	<b>PZFR6H</b>	<b>7696</b>		
NSD 70A	70 hp	TLDI	2004 -	1,1	<b>ZFR6F-11</b>	<b>4291</b>		
NS 70B	70 hp		2004 -	1,0	<b>B8HS-10</b>	<b>5126</b>		
NS 70B	70hp		1997 - 1999	1,0	<b>BR8HS-10</b>	<b>1134</b>		
NS 90A	90hp		1987 - 1996	1,0	<b>B8HS-10</b>	<b>5126</b>		
NS 90A	90hp		1997 -	1,0	<b>BR8HS-10</b>	<b>1134</b>		
NSD 90A	90 hp	TLDI	2004 -	1,1	<b>ZFR6F-11</b>	<b>4291</b>		
NSD 90B	90 hp	TLDI	2004 -	0,8	<b>PZFR6H</b>	<b>7696</b>		
NS 90A	90hp		1987 - 1996	1,0	<b>B8HS-10</b>	<b>5126</b>		
NS 120A	120hp		1990 - 1996	1,0	<b>B8HS-10</b>	<b>5126</b>		
NS 120A	120hp		1997 -	1,0	<b>BR8HS-10</b>	<b>1134</b>		
NS 140A2	140hp		1997 -	1,0	<b>BR8HS-10</b>	<b>1134</b>		
NS 140A	140hp		1990 - 1996	1,0	<b>B8HS-10</b>	<b>5126</b>		
Y9, Y12, Y15				0,7	<b>B6HS</b>	<b>4510</b>	<b>BR6HIX</b>	<b>3419</b>

**NORDEC-BOND**

2430 PS, 4050 PS				0,6	<b>B6ES</b>	<b>7310</b>		
Flat 4				0,6	<b>B6ES</b>	<b>7310</b>		



Cyl.



Order No.

Iridium



Order No.

**O.M.C.**

1.5		1968 - 1970	0,7	<b>B6S</b>	<b>3510</b>		
2 Jr.		1971 - 1990	0,7	<b>BR6S</b>	<b>3522</b>		
2.0		1991 -	0,8	<b>BPR6HS</b>	<b>7022</b>	<b>BPR6HIX</b>	<b>4085</b>
2.3		1991 -	0,8	<b>BPR6HS</b>	<b>7022</b>	<b>BPR6HIX</b>	<b>4085</b>
2.5		1987 - 1988	0,8	<b>BR6HS</b>	<b>3922</b>	<b>BR6HIX</b>	<b>3419</b>
3.0		1952 - 1970	0,7	<b>B6S</b>	<b>3510</b>		
3.0		1989 -	0,8	<b>BR6HS</b>	<b>3922</b>	<b>BR6HIX</b>	<b>3419</b>
3.3		1991 -	0,8	<b>BPR6HS</b>	<b>7022</b>	<b>BPR6HIX</b>	<b>4085</b>
4.0		1989 -	0,8	<b>BR6HS</b>	<b>3922</b>	<b>BR6HIX</b>	<b>3419</b>
4.0		1969 - 1976	0,7	<b>B6S</b>	<b>3510</b>		
4.0		1977 - 1987	0,8	<b>BR6HS</b>	<b>3922</b>	<b>BR6HIX</b>	<b>3419</b>
4.0		1988 -	1,0	<b>BZ7HS-10</b>	<b>3579</b>		
4.0 Delux		1989 -	0,8	<b>BR6HS</b>	<b>3922</b>	<b>BR6HIX</b>	<b>3419</b>
4.5		1980 - 1985	0,8	<b>BR6HS</b>	<b>3922</b>	<b>BR6HIX</b>	<b>3419</b>
5.0		1990 -	0,8	<b>BR6HS</b>	<b>3922</b>	<b>BR6HIX</b>	<b>3419</b>
5.0 (4-stroke)		1997 -	0,7	<b>D6HA</b>	<b>6512</b>		
5.0		1965 - 1968	0,7	<b>B6S</b>	<b>3510</b>		
5.5		1954 - 1964	0,7	<b>B6S</b>	<b>3510</b>		
6.0		1965 - 1976	0,7	<b>B6S</b>	<b>3510</b>		
6.0 (4-stroke)		1998 -	0,7	<b>D6HA</b>	<b>6512</b>		
6.0		1977 -	1,0	<b>BZ7HS-10</b>	<b>3579</b>		
6.5 Comm.		1981 - 1993	1,0	<b>BZ7HS-10</b>	<b>3579</b>		
7.5		1977 -	1,0	<b>BZ7HS-10</b>	<b>3579</b>		
7.5		1952 - 1958	0,7	<b>B6S</b>	<b>3510</b>		
8.0 (4-stroke)		1998 -	0,7	<b>D6HA</b>	<b>6512</b>		
8.0		1977 -	1,0	<b>BZ7HS-10</b>	<b>3579</b>		
8.0 Comm.		1977 -	1,0	<b>BZ7HS-10</b>	<b>3579</b>		
9.5		1964 - 1973	0,8	<b>B7S</b>	<b>3710</b>		
9.9		1977 -	1,0	<b>BZ7HS-10</b>	<b>3579</b>		
9.9 Big Bore		1993 -	0,8	<b>BR6HS</b>	<b>3922</b>	<b>BR6HIX</b>	<b>3419</b>
9.9		1974 - 1976	0,8	<b>B7HS</b>	<b>5110</b>	<b>BR7HIX</b>	<b>7067</b>
9.9 (4-stroke) 211cc		1998 -	0,7	<b>D6HA</b>	<b>6512</b>		
9.9 (4-stroke) 305cc		1998 -	0,8	<b>DCPR7E</b>	<b>3932</b>	<b>DCPR7EIX</b>	<b>6046</b>
10.0		1952 - 1958	0,7	<b>B6S</b>	<b>3510</b>		
10.0		1959 - 1963	0,8	<b>B7S</b>	<b>3710</b>		
10.0 Comm.		1992 - 1993	1,0	<b>BZ7HS-10</b>	<b>3579</b>		
10.0 Comm.		1994 -	0,8	<b>BR6HS</b>	<b>3922</b>	<b>BR6HIX</b>	<b>3419</b>
14.0 Comm.		1981 - 1991	1,0	<b>BZ7HS-10</b>	<b>3579</b>		
14.0		1988 - 1989	1,0	<b>BZ7HS-10</b>	<b>3579</b>		
15.0 (4-stroke)		1998 -	0,8	<b>DCPR7E</b>	<b>3932</b>	<b>DCPR7EIX</b>	<b>6046</b>
15.0 Big Bore		1993 -	0,8	<b>BR6HS</b>	<b>3922</b>	<b>BR6HIX</b>	<b>3419</b>
15.0		1977 - 1992	1,0	<b>BZ7HS-10</b>	<b>3579</b>		
15.0 Comm.		1994 -	0,8	<b>BR6HS</b>	<b>3922</b>	<b>BR6HIX</b>	<b>3419</b>
15.0		1954 - 1956	0,7	<b>B6S</b>	<b>3510</b>		
15.0 Kero		1995 -		<b>BUHXW-1</b>	<b>5526</b>		
15.0 Comm.		1992 - 1993	1,0	<b>BZ7HS-10</b>	<b>3579</b>		
15.0		1974 - 1976	0,8	<b>B7HS</b>	<b>5110</b>	<b>BR7HIX</b>	<b>7067</b>
18.0 Jet 25 h.p.		1995 -	1,0	<b>BZ7HS-10</b>	<b>3579</b>		
18.0		1957 - 1973	0,8	<b>B7S</b>	<b>3710</b>		
20.0		1978 -	1,0	<b>BZ7HS-10</b>	<b>3579</b>		
20.0		1966 - 1973	0,8	<b>B7S</b>	<b>3710</b>		
25.0	3	1998 -	0,8	<b>BR6HS</b>	<b>3922</b>	<b>BR6HIX</b>	<b>3419</b>





Cyl.

Order  
No.

Iridium

Order  
No.**O.M.C.**

25.0	3	1995 - 1997	0,8	<b>BR6HS</b>	<b>3922</b>	<b>BR6HIX</b>	<b>3419</b>
25.0		1969 - 1976	0,8	<b>B7S</b>	<b>3710</b>		
25.0		1952 - 1955	0,8	<b>B7S</b>	<b>3710</b>		
25.0 Comm.		1981 -		<b>BUHXW-1</b>	<b>5526</b>		
25.0		1977 -	1,0	<b>BZ7HS-10</b>	<b>3579</b>		
28.0		1962 - 1964	0,8	<b>B7S</b>	<b>3710</b>		
28.0		1978 -	1,0	<b>BZ7HS-10</b>	<b>3579</b>		
28 Jet 40 h.p.		1992 -	0,8	<b>BPR7HS</b>	<b>6422</b>	<b>BPR7HIX</b>	<b>5944</b>
30.0		1978 -	1,0	<b>BZ7HS-10</b>	<b>3579</b>		
30.0		1956 -	0,7	<b>B6S</b>	<b>3510</b>		
33.0		1965 - 1971	0,8	<b>B7S</b>	<b>3710</b>		
35 Jet 50 h.p.		1993 -	0,8	<b>BPR7HS</b>	<b>6422</b>	<b>BPR7HIX</b>	<b>5944</b>
35.0	3	1998 -	0,8	<b>BR6HS</b>	<b>3922</b>	<b>BR6HIX</b>	<b>3419</b>
35.0	3	1995 - 1997	0,8	<b>BR6HS</b>	<b>3922</b>	<b>BR6HIX</b>	<b>3419</b>
35.0		1957 - 1959	0,7	<b>B6S</b>	<b>3510</b>		
35.0		1977 -	1,0	<b>BZ7HS-10</b>	<b>3579</b>		
35.0		1976 -	0,8	<b>B7HS</b>	<b>5110</b>	<b>BR7HIX</b>	<b>7067</b>
40.0	2	1980 - 1988		<b>BUZHW-2</b>	<b>2173</b>		
40.0	2	1989 -	0,8	<b>BPR7HS</b>	<b>6422</b>	<b>BPR7HIX</b>	<b>5944</b>
40.0 Comm. 43cu.in.		1981 - 1990	0,8	<b>B7HS</b>	<b>5110</b>	<b>BR7HIX</b>	<b>7067</b>
40.0		1974 - 1976	0,8	<b>B7HS</b>	<b>5110</b>	<b>BR7HIX</b>	<b>7067</b>
40.0		1960 - 1973	0,8	<b>B7S</b>	<b>3710</b>		
40.0 Comm. 45cu.in.		1984 -		<b>BUHXW-1</b>	<b>5526</b>		
45.0 Comm.		1986 -		<b>BUHXW-1</b>	<b>5526</b>		
48.0	2	1980 - 1988		<b>BUZHW-2</b>	<b>2173</b>		
48.0	2	1989 -	0,8	<b>BPR7HS</b>	<b>6422</b>	<b>BPR7HIX</b>	<b>5944</b>
50.0	3	1995 -	0,8	<b>BPR7HS</b>	<b>6422</b>	<b>BPR7HIX</b>	<b>5944</b>
50.0	2	1989 -	0,8	<b>BPR7HS</b>	<b>6422</b>	<b>BPR7HIX</b>	<b>5944</b>
50.0	2	1980 - 1988		<b>BUZHW-2</b>	<b>2173</b>		
50.0 (V4)		1958 - 1959	0,8	<b>B7S</b>	<b>3710</b>		
50.0		1971 - 1975	1,0	<b>BZ7HS-10</b>	<b>3579</b>		
55.0	3	1968 - 1969		<b>BUHW</b>	<b>2622</b>		
55.0	2	1967 - 1989		<b>BUZHW-2</b>	<b>2173</b>		
55.0 Comm.		1986 -		<b>BUHXW-1</b>	<b>5526</b>		
60.0	3	1970 - 1971		<b>BUHW</b>	<b>2622</b>		
60.0 56 cu.in.	3	1994 -	0,8	<b>BPR7HS</b>	<b>6422</b>	<b>BPR7HIX</b>	<b>5944</b>
60.0 (V4)		1964 - 1967	0,8	<b>B7S</b>	<b>3710</b>		
60.0 49 cu.in.	3	1975 - 1989	0,8	<b>B7HS</b>	<b>5110</b>	<b>BR7HIX</b>	<b>7067</b>
60.0	2	1980 - 1985		<b>BUZHW-2</b>	<b>2173</b>		
60.0 56 cu.in.	3	1989 - 1993	0,8	<b>B7HS</b>	<b>5110</b>	<b>BR7HIX</b>	<b>7067</b>
65.0 Comm.		1988 -		<b>BUHXW-1</b>	<b>5526</b>		
65.0 (V4)		1968 -		<b>BUHW</b>	<b>2622</b>		
65.0 Jet 90 deg.Cross"V"		1992 -	1,0	<b>BZ7HS-10</b>	<b>3579</b>		
65.0	3	1972 - 1973	1,0	<b>B7HS-10</b>	<b>2129</b>		
65.0 Comm.		1984 - 1987		<b>BUZHW-2</b>	<b>2173</b>		
70.0 56 cu.in.	3	1989 - 1993	0,8	<b>B7HS</b>	<b>5110</b>	<b>BR7HIX</b>	<b>7067</b>
70.0 56 cu.in.	3	1994 -	0,8	<b>BPR7HS</b>	<b>6422</b>	<b>BPR7HIX</b>	<b>5944</b>
70.0 49 cu.in.	3	1975 - 1989	0,8	<b>B7HS</b>	<b>5110</b>	<b>BR7HIX</b>	<b>7067</b>
75.0 (V4)		1960 - 1965	0,8	<b>B7S</b>	<b>3710</b>		
75.0 49 cu.in.	3	1975 - 1989	0,8	<b>B7HS</b>	<b>5110</b>	<b>BR7HIX</b>	<b>7067</b>
80.0 Jet		1979 -	1,0	<b>BZ7HS-10</b>	<b>3579</b>		
80.0		1966 - 1967	0,8	<b>B7S</b>	<b>3710</b>		



Cyl.



Order No.

Iridium



Order No.

**O.M.C.**

85.0		1968 - 1972		<b>BUHW</b>	<b>2622</b>		
85.0		1973 - 1980	0,8	<b>B7HS</b>	<b>5110</b>	<b>BR7HIX</b>	<b>7067</b>
88.0		1979 -	1,0	<b>BZ7HS-10</b>	<b>3579</b>		
90.0	Turbojet 90 deg.Cross "V"	1994 -	1,0	<b>BZ7HS-10</b>	<b>3579</b>		
90.0	60 deg.Loop "V"	1995 -	0,8	<b>BPR7HS</b>	<b>6422</b>	<b>BPR7HIX</b>	<b>5944</b>
90.0		1964 - 1965	0,8	<b>B7S</b>	<b>3710</b>		
90.0		1979 -	1,0	<b>BZ7HS-10</b>	<b>3579</b>		
100.0		1971 - 1972		<b>BUHW</b>	<b>2622</b>		
100.0		1967 - 1968		<b>BUZHW-2</b>	<b>2173</b>		
100.0		1966 - 1966	0,8	<b>B7S</b>	<b>3710</b>		
100.0	Comm.	1984 -		<b>BUZHW-2</b>	<b>2173</b>		
105.0	Comm.60 deg.Loop "V"	1997 -	0,8	<b>BPR7HS</b>	<b>6422</b>	<b>BPR7HIX</b>	<b>5944</b>
105.0	Jet 60 deg.Loop "V"	1993 -	0,8	<b>BPR7HS</b>	<b>6422</b>	<b>BPR7HIX</b>	<b>5944</b>
110.0		1979 -	1,0	<b>BZ7HS-10</b>	<b>3579</b>		
112.0		1979 -	1,0	<b>BZ7HS-10</b>	<b>3579</b>		
115.0	Turbojet 90 deg.Cross "V"	1994 -	1,0	<b>BZ7HS-10</b>	<b>3579</b>		
115.0	Comm.	1973 - 1979		<b>BUHXW-1</b>	<b>5526</b>		
115.0		1969 - 1970		<b>BUHW</b>	<b>2622</b>		
115.0	90 deg.C "V"	1979 -	1,0	<b>BZ7HS-10</b>	<b>3579</b>		
115.0	60 deg.Loop "V"	1995 -	0,8	<b>BPR7HS</b>	<b>6422</b>	<b>BPR7HIX</b>	<b>5944</b>
120.0	90 deg.Loop "V"	1985 -		<b>BUHXW-1</b>	<b>5526</b>		
125.0		1971 - 1972		<b>BUHW</b>	<b>2622</b>		
130.0	90 deg.Loop "V"	1985 -		<b>BUHXW-1</b>	<b>5526</b>		
135.0		1973 - 1984		<b>BUHXW-1</b>	<b>5526</b>		
140.0	90 deg.Loop "V"	1985		<b>BUHXW-1</b>	<b>5526</b>		
140.0		1973 1984		<b>BUHXW-1</b>	<b>5526</b>		
150.0	90 deg. Cross "V"	1978 - 1987		<b>BUHXW-1</b>	<b>5526</b>		
150.0	Comm.60 deg.Loop "V"	1993 -	0,8	<b>BPR7HS</b>	<b>6422</b>	<b>BPR7HIX</b>	<b>5944</b>
175.0	.60 deg.Loop "V"	1991 -	0,8	<b>BPR7HS</b>	<b>6422</b>	<b>BPR7HIX</b>	<b>5944</b>
150.0	.60 deg.Loop "V"	1991 -	0,8	<b>BPR7HS</b>	<b>6422</b>	<b>BPR7HIX</b>	<b>5944</b>
150.0	90 deg.Cross "V"	1988 - 1991	1,0	<b>BZ7HS-10</b>	<b>3579</b>		
150.0	FFI 60 deg.Loop "V"	1997 -		<b>PZFR5F-11</b>	<b>4363</b>		
155.0	Comm. 90 deg.Loop "V"	1989 - 1992		<b>BUHXW-1</b>	<b>5526</b>		
155.0	90 deg. Cross "V"	1978 - 1987		<b>BUHXW-1</b>	<b>5526</b>		
175.0	90 deg.Cross "V"	1988 - 1991	1,0	<b>BZ7HS-10</b>	<b>3579</b>		
175.0	FFI 60 deg.Loop "V"	1997 -	1,1	<b>PZFR5F-11</b>	<b>4363</b>		
175.0		1977 - 1987		<b>BUHXW-1</b>	<b>5526</b>		
185.0	Comm.	1990 - 1993		<b>BUHXW-1</b>	<b>5526</b>		
185.0		1977 - 1987		<b>BUHXW-1</b>	<b>5526</b>		
200.0		1976 - 1983		<b>BUHXW-1</b>	<b>5526</b>		
200.0		1986 - 1993	1,0	<b>BZ7HS-10</b>	<b>3579</b>		
200.0	Comm.	1992 -		<b>BUHXW-1</b>	<b>5526</b>		
200.0	Comm.	1993 -	0,8	<b>BPR7HS</b>	<b>6422</b>	<b>BPR7HIX</b>	<b>5944</b>
200.0		1994 -	0,8	<b>BPR7HS</b>	<b>6422</b>	<b>BPR7HIX</b>	<b>5944</b>
225.0		1986 - 1993	1,0	<b>BZ7HS-10</b>	<b>3579</b>		
225.0		1994 -	0,8	<b>BPR7HS</b>	<b>6422</b>	<b>BPR7HIX</b>	<b>5944</b>
235.0		1978 - 1985		<b>BUHXW-1</b>	<b>5526</b>		
275.0		1985 - 1988	1,0	<b>BR9HS-10</b>	<b>4551</b>		
300.0		1986 - 1989	1,0	<b>BR9HS-10</b>	<b>4551</b>		
Sea Drive		1988 - 1992	1,0	<b>BZ7HS-10</b>	<b>3579</b>		
Ultra,Excel 4		1987 - 1988	1,0	<b>B7HS-10</b>	<b>2129</b>		
all V8 engine	8	1985 -	0,8	<b>BPR7HS</b>	<b>6422</b>	<b>BPR7HIX</b>	<b>5944</b>



Cyl.

Order  
No.

Iridium

Order  
No.**OTASCO**

5 h.p.	1970 - 1974	0,9	XR4	2637	XR4IX	7189
7 h.p.	1970 - 1974	0,9	XR4	2637	XR4IX	7189
7.5 h.p.	1970 - 1974	0,9	XR4	2637	XR4IX	7189
9.9 h.p.	1970 - 1974	0,9	XR4	2637	XR4IX	7189
15 h.p.	1970 - 1974	0,9	XR4	2637	XR4IX	7189

**OTTERBINE**

2 h.p.		0,8	BR2LM	5798		
--------	--	-----	-------	------	--	--

**OUTBOARD JET**

J55, J555B (5.5 PS)		0,8	B6S	3510		
---------------------	--	-----	-----	------	--	--

**OUTBOARD MARINE***Sea Drive O.M.C.*

1.6L	1984 - 1992	0,8	BZ7HS-10	3579		
1.8L	1984 - 1992	0,8	BZ7HS-10	3579		
1AA / 2,6L	1981 - 1983		BUZHW	2147		
1AB / 2,5L	1981 - 1983		BUZHW	2147		
2.0L	1990 - 1992	0,8	BZ7HS-10	3579		
2.3L	1990 - 1992	0,8	BZ7HS-10	3579		
2.6L	1984 - 1990	0,8	BZ7HS-10	3579		
2.7L	1984 - 1990	0,8	BZ7HS-10	3579		
3.6L	1984 - 1990	0,8	BZ7HS-10	3579		
4.0L	1990 - 1991	0,8	BZ7HS-10	3579		

**PERKINS**

4.5 h.p.	1962 - 1965	0,7	BR6S	3522		
6.0 h.p.	1959 - 1961	0,7	BR6S	3522		
6.5 h.p.	1962 - 1965	0,7	BR6S	3522		
30.0 h.p.	1962 - 1965	0,8	BR6HS	3922	BR6HIX	3419
35.0 h.p. 18mm Heads	1959 - 1961	0,8	A6	1010		
35.0 h.p. 14mm Heads	1961 -	0,8	BR6HS	3922	BR6HIX	3419
40.0 h.p.	1959 - 1965	0,8	BR6HS	3922	BR6HIX	3419

**PIAGGIO**

Moscone		0,5	B6S	3510		
---------	--	-----	-----	------	--	--

**PUFFIN**

75, 105, 105 De Luxe		0,5	B6ES	7310		
----------------------	--	-----	------	------	--	--

**SALUT**

Salut-E 45cid		0,8	B5HS	4210		
---------------	--	-----	------	------	--	--



Cyl.

Order  
No.

Iridium

Order  
No.**SEA KING (Wards)**

2.0 hp	1979 - 1980	0,6	<b>B2</b>	<b>3110</b>		
3.5 hp	1964 - 1970	0,8	<b>B6L</b>	<b>3212</b>		
3.5 hp	1979 - 1980	0,6	<b>BM6A</b>	<b>5921</b>		
4.0 hp	1979 - 1986	0,8	<b>B6HS</b>	<b>4510</b>	<b>BR6HIX</b>	<b>3419</b>
5.0 hp	1969 -	0,8	<b>B6S</b>	<b>3510</b>		
5.8 hp	1964 - 1970	0,8	<b>B6L</b>	<b>3212</b>		
5.9 hp	1979 - 1980	0,6	<b>XR5</b>	<b>5953</b>	<b>XR5IX</b>	<b>7355</b>
6.0 hp	1967 - 1971	0,8	<b>B6L</b>	<b>3212</b>		
6.0 hp	1972 - 1976	0,8	<b>B8HS</b>	<b>5510</b>	<b>BR8HIX</b>	<b>7001</b>
7.0 hp	1969 -	0,6	<b>XR5</b>	<b>5953</b>	<b>XR5IX</b>	<b>7355</b>
7.5 hp	1979 - 1986	0,8	<b>B6HS</b>	<b>4510</b>	<b>BR6HIX</b>	<b>3419</b>
9.2 cu in.	1979 - 1980	0,6	<b>XR5</b>	<b>5953</b>	<b>XR5IX</b>	<b>7355</b>
9.6 hp	1968 - 1974	0,8	<b>B8HS</b>	<b>5510</b>	<b>BR8HIX</b>	<b>7001</b>
9.9 hp	1980 - 1986	0,8	<b>B7HS</b>	<b>5110</b>	<b>BR7HIX</b>	<b>7067</b>
10 hp	1974 - 1976	0,8	<b>B8HS</b>	<b>5510</b>	<b>BR8HIX</b>	<b>7001</b>
15 hp	1978 - 1986	0,8	<b>B7HS</b>	<b>5110</b>	<b>BR7HIX</b>	<b>7067</b>
15 hp	1974 - 1976	0,8	<b>B8HS</b>	<b>5510</b>	<b>BR8HIX</b>	<b>7001</b>
20 hp	1968 - 1974	0,8	<b>B8HS</b>	<b>5510</b>	<b>BR8HIX</b>	<b>7001</b>
25 hp	1974 - 1976	0,8	<b>B8HS</b>	<b>5510</b>	<b>BR8HIX</b>	<b>7001</b>
35 hp	1968 - 1975	0,8	<b>B8HS</b>	<b>5510</b>	<b>BR8HIX</b>	<b>7001</b>
35 hp	1978 - 1979	0,8	<b>B8HS</b>	<b>5510</b>	<b>BR8HIX</b>	<b>7001</b>
55 hp	1968 - 1975	0,8	<b>B8HS</b>	<b>5510</b>	<b>BR8HIX</b>	<b>7001</b>

**SEA-BEE**

3		0,5	<b>B6HS</b>	<b>4510</b>	<b>BR6HIX</b>	<b>3419</b>
4		0,5	<b>B6HS</b>	<b>4510</b>	<b>BR6HIX</b>	<b>3419</b>
Minor		0,5	<b>B6HS</b>	<b>4510</b>	<b>BR6HIX</b>	<b>3419</b>

**SEARS**

1.2 hp 585121		0,6	<b>BR6S</b>	<b>3522</b>		
1.2 hp 585122		0,6	<b>BMR6A</b>	<b>7421</b>		
1.2 hp 585120		0,6	<b>BR6S</b>	<b>3522</b>		
2.0 hp 58250		0,6	<b>B4</b>	<b>3210</b>		
2.0 hp 58241		0,6	<b>B4</b>	<b>3210</b>		
3.0 hp 585211		0,7	<b>XR5</b>	<b>5953</b>	<b>XR5IX</b>	<b>7355</b>
3.0 hp 585210		0,7	<b>XR5</b>	<b>5953</b>	<b>XR5IX</b>	<b>7355</b>
3.0 hp 58544		0,7	<b>XR5</b>	<b>5953</b>	<b>XR5IX</b>	<b>7355</b>
3.0 hp 58543		0,7	<b>XR5</b>	<b>5953</b>	<b>XR5IX</b>	<b>7355</b>
3.0 hp 58541		0,7	<b>XR5</b>	<b>5953</b>	<b>XR5IX</b>	<b>7355</b>
3.0 hp 58540		0,7	<b>XR5</b>	<b>5953</b>	<b>XR5IX</b>	<b>7355</b>
3.0 hp 585220		0,7	<b>XR5</b>	<b>5953</b>	<b>XR5IX</b>	<b>7355</b>
3.5 hp 585241		0,7	<b>XR5</b>	<b>5953</b>	<b>XR5IX</b>	<b>7355</b>
3.5 hp 585280		0,7	<b>XR5</b>	<b>5953</b>	<b>XR5IX</b>	<b>7355</b>
3.5 hp 59501		0,6	<b>BM6A</b>	<b>5921</b>		
3.5 hp 59860		0,6	<b>B6S</b>	<b>3510</b>		
3.5 hp 59861		0,6	<b>B6S</b>	<b>3510</b>		
3.5 hp 59862		0,7	<b>XR5</b>	<b>5953</b>	<b>XR5IX</b>	<b>7355</b>
3.5 hp 60020		0,6	<b>B6L</b>	<b>3212</b>		
3.5 hp 585240		0,7	<b>XR5</b>	<b>5953</b>	<b>XR5IX</b>	<b>7355</b>



Cyl.

Order  
No.

Iridium

Order  
No.**SEARS**

3.5 hp 60030			0,6	<b>B6L</b>	<b>3212</b>		
3.5 hp 59900			0,6	<b>BM6A</b>	<b>5921</b>		
3.5 hp 58560			0,7	<b>XR5</b>	<b>5953</b>	<b>XR5IX</b>	<b>7355</b>
3.5 hp 6003			0,6	<b>B6L</b>	<b>3212</b>		
3.5 hp 6091			0,6	<b>BM6A</b>	<b>5921</b>		
3.5 hp 6094			0,6	<b>BM6A</b>	<b>5921</b>		
3.5 hp 58510			0,6	<b>B6S</b>	<b>3510</b>		
3.5 hp 58542			0,7	<b>XR5</b>	<b>5953</b>	<b>XR5IX</b>	<b>7355</b>
3.5 hp 58550			0,7	<b>XR5</b>	<b>5953</b>	<b>XR5IX</b>	<b>7355</b>
3.5 hp 585230			0,7	<b>XR5</b>	<b>5953</b>	<b>XR5IX</b>	<b>7355</b>
3.6 hp 58511			0,6	<b>B6S</b>	<b>3510</b>		
3.6 hp 6001			0,6	<b>B6L</b>	<b>3212</b>		
3.6 hp 58512			0,6	<b>B6S</b>	<b>3510</b>		
3.6 hp 58513			0,7	<b>XR5</b>	<b>5953</b>	<b>XR5IX</b>	<b>7355</b>
3.6 hp 58514			0,7	<b>XR5</b>	<b>5953</b>	<b>XR5IX</b>	<b>7355</b>
3.6 hp 60000			0,6	<b>B6L</b>	<b>3212</b>		
4.0 hp 585270			0,7	<b>XR5</b>	<b>5953</b>	<b>XR5IX</b>	<b>7355</b>
4.0 hp 58580			0,7	<b>XR5</b>	<b>5953</b>	<b>XR5IX</b>	<b>7355</b>
4.5 hp 59464			0,7	<b>XR5</b>	<b>5953</b>	<b>XR5IX</b>	<b>7355</b>
4.5 hp 59463			0,7	<b>XR5</b>	<b>5953</b>	<b>XR5IX</b>	<b>7355</b>
4.5 hp 59461			0,7	<b>XR5</b>	<b>5953</b>	<b>XR5IX</b>	<b>7355</b>
4.5 hp 59460			0,7	<b>XR5</b>	<b>5953</b>	<b>XR5IX</b>	<b>7355</b>
4.5 hp 59462			0,7	<b>XR5</b>	<b>5953</b>	<b>XR5IX</b>	<b>7355</b>
4.8 hp 58971			0,7	<b>XR5</b>	<b>5953</b>	<b>XR5IX</b>	<b>7355</b>
4.8 hp 58970			0,7	<b>XR5</b>	<b>5953</b>	<b>XR5IX</b>	<b>7355</b>
5.0 hp 59670			0,6	<b>B6S</b>	<b>3510</b>		
5.0 hp 58520			0,6	<b>B6S</b>	<b>3510</b>		
5.0 hp 595440			0,7	<b>XR5</b>	<b>5953</b>	<b>XR5IX</b>	<b>7355</b>
5.0 hp 595431			0,7	<b>XR5</b>	<b>5953</b>	<b>XR5IX</b>	<b>7355</b>
5.0 hp 595410			0,7	<b>XR5</b>	<b>5953</b>	<b>XR5IX</b>	<b>7355</b>
5.0 hp 585470			0,7	<b>XR5</b>	<b>5953</b>	<b>XR5IX</b>	<b>7355</b>
5.0 hp 585460			0,7	<b>XR5</b>	<b>5953</b>	<b>XR5IX</b>	<b>7355</b>
5.0 hp 585420			0,7	<b>XR5</b>	<b>5953</b>	<b>XR5IX</b>	<b>7355</b>
5.0 hp 585411			0,7	<b>XR5</b>	<b>5953</b>	<b>XR5IX</b>	<b>7355</b>
5.0 hp 59680			0,7	<b>XR5</b>	<b>5953</b>	<b>XR5IX</b>	<b>7355</b>
5.0 hp 585441			0,7	<b>XR5</b>	<b>5953</b>	<b>XR5IX</b>	<b>7355</b>
5.0 hp 59673			0,7	<b>XR5</b>	<b>5953</b>	<b>XR5IX</b>	<b>7355</b>
5.0 hp 59671			0,6	<b>B6S</b>	<b>3510</b>		
5.0 hp 58990			0,7	<b>XR5</b>	<b>5953</b>	<b>XR5IX</b>	<b>7355</b>
5.0 hp 585430			0,7	<b>XR5</b>	<b>5953</b>	<b>XR5IX</b>	<b>7355</b>
5.0 hp 58521			0,7	<b>XR5</b>	<b>5953</b>	<b>XR5IX</b>	<b>7355</b>
5.0 hp 58610			0,7	<b>XR5</b>	<b>5953</b>	<b>XR5IX</b>	<b>7355</b>
5.0 hp 58620			0,7	<b>XR5</b>	<b>5953</b>	<b>XR5IX</b>	<b>7355</b>
5.0 hp 58960			0,6	<b>B6S</b>	<b>3510</b>		
5.0 hp 59672			0,6	<b>B6S</b>	<b>3510</b>		
5.0 hp 58962			0,7	<b>XR5</b>	<b>5953</b>	<b>XR5IX</b>	<b>7355</b>
5.0 hp 58991			0,7	<b>XR5</b>	<b>5953</b>	<b>XR5IX</b>	<b>7355</b>
5.0 hp 58992			0,7	<b>XR5</b>	<b>5953</b>	<b>XR5IX</b>	<b>7355</b>
5.0 hp 59310			0,7	<b>XR5</b>	<b>5953</b>	<b>XR5IX</b>	<b>7355</b>
5.0 hp 59311			0,7	<b>XR5</b>	<b>5953</b>	<b>XR5IX</b>	<b>7355</b>
5.0 hp 59520			0,6	<b>B6S</b>	<b>3510</b>		
5.0 hp 58961			0,6	<b>B6S</b>	<b>3510</b>		



Cyl.

Order  
No.

Iridium

Order  
No.**SEARS**

5.5 hp 59433		0,7	XR5	5953	XR5IX	7355
5.5 hp 59980		0,7	XR5	5953	XR5IX	7355
5.5 hp 59432		0,7	XR5	5953	XR5IX	7355
5.5 hp 59431		0,7	XR5	5953	XR5IX	7355
5.5 hp 585710		0,7	XR5	5953	XR5IX	7355
5.5 hp 59430		0,7	XR5	5953	XR5IX	7355
6.0 hp 6004		0,6	B6L	3212		
6.0 hp 6005		0,6	B6L	3212		
6.0 hp 60060		0,6	B6L	3212		
7.0 hp 59840		0,7	XR5	5953	XR5IX	7355
7.0 hp 585861		0,7	XR5	5953	XR5IX	7355
7.0 hp 59970		0,7	XR5	5953	XR5IX	7355
7.0 hp 59440		0,7	XR5	5953	XR5IX	7355
7.0 hp 58830		0,7	XR5	5953	XR5IX	7355
7.0 hp 58532		0,7	XR5	5953	XR5IX	7355
7.0 hp 58531		0,7	XR5	5953	XR5IX	7355
7.0 hp 58530		0,7	XR5	5953	XR5IX	7355
7.0 hp 585860		0,7	XR5	5953	XR5IX	7355
7.5 hp 6010		0,6	B6L	3212		
7.5 hp 60070		0,6	B6L	3212		
7.5 hp 59491		0,7	XR5	5953	XR5IX	7355
7.5 hp 59490		0,7	XR5	5953	XR5IX	7355
7.5 hp 59450		0,7	XR5	5953	XR5IX	7355
7.5 hp 58891		0,7	XR5	5953	XR5IX	7355
7.5 hp 58882		0,7	XR5	5953	XR5IX	7355
7.5 hp 60090		0,6	B6L	3212		
7.5 hp 58881		0,7	XR5	5953	XR5IX	7355
7.5 hp 58880		0,7	XR5	5953	XR5IX	7355
7.5 hp 58850		0,7	XR5	5953	XR5IX	7355
7.5 hp 58821		0,7	XR5	5953	XR5IX	7355
7.5 hp 58820		0,7	XR5	5953	XR5IX	7355
7.5 hp 6012		0,6	B6L	3212		
7.5 hp 585930		0,7	XR5	5953	XR5IX	7355
7.5 hp 6008		0,6	B6L	3212		
7.5 hp 60100		0,6	B6L	3212		
7.5 hp 58809		0,7	XR5	5953	XR5IX	7355
7.5 hp 585890		0,7	XR5	5953	XR5IX	7355
7.5 hp 585780		0,7	XR5	5953	XR5IX	7355
7.5 hp 585911		0,7	XR5	5953	XR5IX	7355
7.5 hp 586120		0,7	XR5	5953	XR5IX	7355
7.5 hp 586111		0,7	XR5	5953	XR5IX	7355
7.5 hp 586110		0,7	XR5	5953	XR5IX	7355
7.5 hp 585931		0,7	XR5	5953	XR5IX	7355
7.5 hp 585910		0,7	XR5	5953	XR5IX	7355
7.5 hp 585880		0,7	XR5	5953	XR5IX	7355
7.5 hp 585850		0,7	XR5	5953	XR5IX	7355
7.5 hp 585840		0,7	XR5	5953	XR5IX	7355
7.5 hp 585830		0,7	XR5	5953	XR5IX	7355
7.5 hp 585821		0,7	XR5	5953	XR5IX	7355
7.5 hp 585811		0,7	XR5	5953	XR5IX	7355
7.5 hp 585810		0,7	XR5	5953	XR5IX	7355
7.5 hp 585920		0,7	XR5	5953	XR5IX	7355



Cyl.

Order  
No.

Iridium

Order  
No.**SEARS**

9.9 hp	586230		0,7	<b>XR5</b>	<b>5953</b>	<b>XR5IX</b>	<b>7355</b>
9.9 hp	586220		0,7	<b>XR5</b>	<b>5953</b>	<b>XR5IX</b>	<b>7355</b>
9.9 hp	586231		0,7	<b>XR5</b>	<b>5953</b>	<b>XR5IX</b>	<b>7355</b>
9.9 hp	586210		0,7	<b>XR5</b>	<b>5953</b>	<b>XR5IX</b>	<b>7355</b>
9.9 hp	58711		0,7	<b>XR5</b>	<b>5953</b>	<b>XR5IX</b>	<b>7355</b>
9.9 hp	58710		0,7	<b>XR5</b>	<b>5953</b>	<b>XR5IX</b>	<b>7355</b>
9.9 hp	586211		0,7	<b>XR5</b>	<b>5953</b>	<b>XR5IX</b>	<b>7355</b>
9.9 hp	586240		0,7	<b>XR5</b>	<b>5953</b>	<b>XR5IX</b>	<b>7355</b>
10.5 hp	58720		0,7	<b>XR5</b>	<b>5953</b>	<b>XR5IX</b>	<b>7355</b>
10.5 hp	58721		0,7	<b>XR5</b>	<b>5953</b>	<b>XR5IX</b>	<b>7355</b>
12 hp	5927		0,6	<b>B6L</b>	<b>3212</b>		
14 hp	6013		0,6	<b>B6S</b>	<b>3510</b>		
14 hp	6014		0,6	<b>B6S</b>	<b>3510</b>		
14 hp	6015		0,6	<b>B6S</b>	<b>3510</b>		
15 hp	58760		0,7	<b>XR5</b>	<b>5953</b>	<b>XR5IX</b>	<b>7355</b>
15 hp	586340		0,7	<b>XR5</b>	<b>5953</b>	<b>XR5IX</b>	<b>7355</b>
15 hp	586331		0,7	<b>XR5</b>	<b>5953</b>	<b>XR5IX</b>	<b>7355</b>
15 hp	586330		0,7	<b>XR5</b>	<b>5953</b>	<b>XR5IX</b>	<b>7355</b>
15 hp	586320		0,7	<b>XR5</b>	<b>5953</b>	<b>XR5IX</b>	<b>7355</b>
15 hp	586311		0,7	<b>XR5</b>	<b>5953</b>	<b>XR5IX</b>	<b>7355</b>
15 hp	58761		0,7	<b>XR5</b>	<b>5953</b>	<b>XR5IX</b>	<b>7355</b>
15 hp	58105		0,6	<b>B7HS</b>	<b>5110</b>	<b>BR7HIX</b>	<b>7067</b>
15 hp	586310		0,7	<b>XR5</b>	<b>5953</b>	<b>XR5IX</b>	<b>7355</b>
25 hp			0,6	<b>B8HS</b>	<b>5510</b>	<b>BR8HIX</b>	<b>7001</b>
27.7 hp	6033		0,6	<b>B6S</b>	<b>3510</b>		
27.7 hp	6035		0,6	<b>B6S</b>	<b>3510</b>		
28 hp	60370		0,6	<b>B8S</b>	<b>3810</b>		
28 hp	6038		0,6	<b>B6S</b>	<b>3510</b>		
28 hp	60360		0,6	<b>B8S</b>	<b>3810</b>		
28 hp	60380		0,6	<b>B8S</b>	<b>3810</b>		
28 hp	60340		0,6	<b>B8S</b>	<b>3810</b>		
28 hp	6037		0,6	<b>B6S</b>	<b>3510</b>		
35 hp	5941		0,6	<b>B8S</b>	<b>3810</b>		
43.7 hp	60644		0,6	<b>B6S</b>	<b>3510</b>		
43.7 hp	6045		0,6	<b>B6S</b>	<b>3510</b>		
43.7 hp	6050		0,6	<b>B6S</b>	<b>3510</b>		
43.7 hp	60541		0,6	<b>B6S</b>	<b>3510</b>		
45 hp	60550		0,6	<b>B8S</b>	<b>3810</b>		
45 hp	60540		0,6	<b>B8S</b>	<b>3810</b>		
45 hp	5058		0,6	<b>B8S</b>	<b>3810</b>		
45 hp	5056		0,6	<b>B8S</b>	<b>3810</b>		
45 hp	5057		0,6	<b>B8S</b>	<b>3810</b>		
75 hp	6078		0,6	<b>B8S</b>	<b>3810</b>		
75 hp	60740		0,6	<b>B8S</b>	<b>3810</b>		
75 hp	60750		0,6	<b>B8S</b>	<b>3810</b>		
75.2 hp	6071		0,6	<b>B6S</b>	<b>3510</b>		
75.2 hp	6070		0,6	<b>B6S</b>	<b>3510</b>		
75.2 hp	6077		0,6	<b>B8S</b>	<b>3810</b>		
75.2 hp	6076		0,6	<b>B8S</b>	<b>3810</b>		



Cyl.

Order  
No.

Iridium

Order  
No.**SELVA**

2.4 HP Elba 56cc	1		0,5	<b>BPMR6A</b>	<b>6726</b>		
2.5 HP S60 SI			0,5	<b>BPM6A</b>	<b>7021</b>		
4 / 6 HP models	1		0,5	<b>BP6HS</b>	<b>4511</b>	<b>BPR6HIX</b>	<b>4085</b>
5.0 HP Capri 125cc	1		0,8	<b>BPR6HS</b>	<b>7022</b>	<b>BPR6HIX</b>	<b>4085</b>
5.0 HP S115 / S115 SI			0,5	<b>BPR6HS</b>	<b>7022</b>	<b>BPR6HIX</b>	<b>4085</b>
8.0 HP Izmir 170cc	2		0,8	<b>BPR6HS</b>	<b>7022</b>	<b>BPR6HIX</b>	<b>4085</b>
8.0 HP S165			0,5	<b>BPR6HS</b>	<b>7022</b>	<b>BPR6HIX</b>	<b>4085</b>
9.9, 15 HP models	2		0,5	<b>BP6HS</b>	<b>4511</b>	<b>BPR6HIX</b>	<b>4085</b>
20, 25 HP models	2		0,5	<b>BP7HS</b>	<b>5111</b>		
20.0 HP Rhodes 398cc	2		0,8	<b>BPR6HS</b>	<b>7022</b>	<b>BPR6HIX</b>	<b>4085</b>
20.0 HP S405			0,5	<b>BPR6HS</b>	<b>7022</b>	<b>BPR6HIX</b>	<b>4085</b>
25.0 HP Antibes 489cc	2		0,8	<b>BPR6HS</b>	<b>7022</b>	<b>BPR6HIX</b>	<b>4085</b>
25.0 HP Majorca 489cc	2		0,8	<b>BPR6HS</b>	<b>7022</b>	<b>BPR6HIX</b>	<b>4085</b>
25.0 HP Master	2	1989 -	0,5	<b>B8HS</b>	<b>5510</b>	<b>BR8HIX</b>	<b>7001</b>
25.0 HP S1050 Super Best			1,0	<b>B7HS-10</b>	<b>2129</b>		
25.0 HP S495			0,5	<b>BPR6HS</b>	<b>7022</b>	<b>BPR6HIX</b>	<b>4085</b>
25.0 HP S500 Grand Prix			1,0	<b>B7HS-10</b>	<b>2129</b>		
25.0 HP S600 Master			1,0	<b>B7HS-10</b>	<b>2129</b>		
25.0 HP S800 Best			1,0	<b>B7HS-10</b>	<b>2129</b>		
25.0 HP XS (495CC, 2carb.)	2	1988 -	0,5	<b>BP6HS</b>	<b>4511</b>	<b>BPR6HIX</b>	<b>4085</b>
30.0 HP S505 Antibes 489cc	2		1,0	<b>B7HS-10</b>	<b>2129</b>		
35, 50 HP other models,	2		0,5	<b>B8HS</b>	<b>5510</b>	<b>BR8HIX</b>	<b>7001</b>
35.0 HP S525 Majorca 489cc	2		1,0	<b>B7HS-10</b>	<b>2129</b>		
40.0 HP S625 Madeira 684cc	2		1,0	<b>B7HS-10</b>	<b>2129</b>		
40.0 HP Saint Tropez 741cc	3		1,0	<b>B7HS-10</b>	<b>2129</b>		
50.0 HP S700 Madeira 684cc	2		1,0	<b>B7HS-10</b>	<b>2129</b>		
55.0 HP S750			1,0	<b>B7HS-10</b>	<b>2129</b>		
60.0 HP Saint Tropez 831cc	3		1,0	<b>B7HS-10</b>	<b>2129</b>		
65, 80 HP other models	3		0,5	<b>B8HS</b>	<b>5510</b>	<b>BR8HIX</b>	<b>7001</b>
65.0 HP S850			1,0	<b>B7HS-10</b>	<b>2129</b>		
70.0 HP Tenerife 831cc	3		1,0	<b>B7HS-10</b>	<b>2129</b>		
74.5 HP S1300 Endurance			1,0	<b>B7HS-10</b>	<b>2129</b>		
75.0 HP Montecarlo 1298cc	4		1,0	<b>B7HS-10</b>	<b>2129</b>		
80.0 HP S1000 Potofino 1026cc	3		1,0	<b>B7HS-10</b>	<b>2129</b>		
90.0 HP S1350 Montecarlo 1298cc	4		1,0	<b>B7HS-10</b>	<b>2129</b>		
100.0 HP S1400 Montecarlo 1368cc	4		1,0	<b>B7HS-10</b>	<b>2129</b>		
S130, S135, S165, S170	3		0,5	<b>BP6HS</b>	<b>4511</b>	<b>BPR6HIX</b>	<b>4085</b>
S1350, S1400			0,5	<b>B8HS</b>	<b>5510</b>	<b>BR8HIX</b>	<b>7001</b>
S155, S175, S495 XS, S525			0,5	<b>BP6HS</b>	<b>4511</b>	<b>BPR6HIX</b>	<b>4085</b>
S250, S260, S350	3		0,5	<b>BP6HS</b>	<b>4511</b>	<b>BPR6HIX</b>	<b>4085</b>
S400,S405,S490,S495,S505	3		0,5	<b>BP7HS</b>	<b>5111</b>		
S500	3		0,5	<b>B6HS</b>	<b>4510</b>	<b>BR6HIX</b>	<b>3419</b>
S600 Master, S650 (40HP)			0,5	<b>B8HS</b>	<b>5510</b>	<b>BR8HIX</b>	<b>7001</b>
S650 (50HP), S850			0,5	<b>B8HS</b>	<b>5510</b>	<b>BR8HIX</b>	<b>7001</b>
S650	2	1989 -	0,5	<b>B8HS</b>	<b>5510</b>	<b>BR8HIX</b>	<b>7001</b>
S650, S700, S750, S800	3		0,5	<b>B8HS</b>	<b>5510</b>	<b>BR8HIX</b>	<b>7001</b>
S800 Best, S1000	3		0,5	<b>B8HS</b>	<b>5510</b>	<b>BR8HIX</b>	<b>7001</b>
S85,S95,S110,S120,S125	3		0,5	<b>BP6HS</b>	<b>4511</b>	<b>BPR6HIX</b>	<b>4085</b>
S95 SC,S115 SC,S115,S135 SC			0,5	<b>BP6HS</b>	<b>4511</b>	<b>BPR6HIX</b>	<b>4085</b>





Cyl.

Order  
No.

Iridium

Order  
No.**SELVA GEMINI**3, 4,5 PS  
6 PS0,5  
0,5**B6S**  
**B6S****3510**  
**3510****SOLO**2.5, 4 PS  
55, 70 PS0,5  
0,9**B6HS**  
**B9HS****4510**  
**5810****BR6HIX****3419****SPIRIT**2 PS  
4.5 PS  
5 PS  
9.9 PS  
16 PS  
20 PS  
25 PS  
50 PS  
65 PS1977 -  
1976 - 1977  
1978 -  
1976 -  
1976 -  
1976 -  
1976 -  
1977 -  
1978 -0,6  
0,6  
0,6  
0,6  
0,6  
0,6  
0,6  
0,5  
0,6**B6HS**  
**B6HS**  
**B6HS**  
**B6HS**  
**B6HS**  
**B6HS**  
**B6HS**  
**B8HS**  
**B8HS****4510**  
**4510**  
**4510**  
**4510**  
**4510**  
**4510**  
**4510**  
**5510**  
**5510****BR6HIX**  
**BR6HIX**  
**BR6HIX**  
**BR6HIX**  
**BR6HIX**  
**BR6HIX**  
**BR6HIX**  
**BR8HIX**  
**BR8HIX****3419**  
**3419**  
**3419**  
**3419**  
**3419**  
**3419**  
**3419**  
**7001**  
**7001****SPRITE**

J-5

0,8

**BM6A****5921****STARLING JET**

5 PS

0,6

**B2****3110****SUBARU**

Y6, Y7.5, Y9, Y9.9, Y12, Y15

0,6

**B6HS****4510****BR6HIX****3419****SUZUKI**

9.9Y

0,9

**BR6HS****3922****BR6HIX****3419****DF**DF 4 4-Stroke  
DF 5 4-Stroke  
DF 6 4-Stroke  
DF 9.9AEL 4-Stroke  
DF 9.9AES 4-Stroke  
DF 9.9AL 4-Stroke  
DF 9.9AS 4-Stroke  
DF 15AL  
DF 15ARL  
DF 15ARS  
DF 15AS  
DF 25 4-Stroke1 2002 -  
1 2002 -  
1 2002 -  
2 1995 -  
2 1995 -  
2 1995 -  
2 1995 -  
2 1995 - 1999  
2 1995 - 1999  
2 1995 - 1999  
2 1995 - 1999  
3 2000 -0,8  
0,8  
0,8  
0,9  
0,9  
0,9  
0,9  
0,9  
0,9  
0,9  
0,9**BPR6ES**  
**BPR6ES**  
**BPR6ES**  
**DCPR6E**  
**DCPR6E**  
**DCPR6E**  
**DCPR6E**  
**DCPR6E**  
**DCPR6E**  
**DCPR6E**  
**DCPR6E****7822**  
**7822**  
**7822**  
**3481**  
**3481**  
**3481**  
**3481**  
**3481**  
**3481**  
**3481**  
**3481****BPR6EIX**  
**BPR6EIX**  
**BPR6EIX**  
**BPR6EIX**  
**BPR6EIX**  
**BPR6EIX**  
**BPR6EIX**  
**BPR6EIX**  
**BPR6EIX**  
**BPR6EIX**  
**BPR6EIX****6637**  
**6637**  
**6637**  
**6637**  
**6637**  
**6637**  
**6637**  
**6637**  
**6637**  
**6637**  
**6637**



Cyl.



Order No.

Iridium



Order No.

**SUZUKI****DF**

DF 30	4-Stroke	3	2000 -	0,9	DCPR6E	3481		
DF 40	4-Stroke	3	1999 -	0,9	DCPR6E	3481		
DF 50	4-Stroke	3	1999 -	0,9	DCPR6E	3481		
DF 60	4-Stroke	4	1998 -	0,8	BPR6ES	7822	BPR6EIX	6637
DF 70	4-Stroke	4	1998 -	0,8	BPR6ES	7822	BPR6EIX	6637
DF 90	4-Stroke	4	2001 -	0,8	BKR6E	6962	BKR6EIX	6418
DF 115	4-Stroke	4	2001 -	0,8	BKR6E	6962	BKR6EIX	6418
DF 140	4-Stroke	4	2002 -	0,8	BKR6E	6962	BKR6EIX	6418
DF 200	(4-Stroke)	4	2004 -	0,8	BKR6E	6962	BKR6EIX	6418
DF 225	(4-Stroke)	4	2004 -	0,8	BKR6E	6962	BKR6EIX	6418
DF 250	(4-Stroke)	4	2004 -	0,8	BKR6E	6962	BKR6EIX	6418

**DT**

DT 2			1986 - 1990	0,6	BR4HS	3322		
DT 2			1991 - 1999	0,7	BR5HS	3722		
DT 2.2			1992 -	0,7	BR5HS	3722		
DT 3,5				0,7	BP6HS	4511	BPR6HIX	4085
DT 4			1988 - 1992	0,7	BP5HS	4111		
DT 4			1993 - 2001	0,7	BPR5HS	6222		
DT 4,5				0,6	BR6HS	3922	BR6HIX	3419
DT 4L/S			1994 -	0,7	BPR5HS	6222		
DT 4L/S			- 1993	0,7	BP5HS	4111		
DT 5			1986 - 1992	0,6	BP6HS	4511	BPR6HIX	4085
DT 5			1993 - 1994	0,9	BPR6HS	7022	BPR6HIX	4085
DT 5			1995 - 2000	0,6	BR6HS	3922	BR6HIX	3419
DT 5 W			1986 - 1992	0,6	BR6HS	3922	BR6HIX	3419
DT 5Y			1998 - 2001	1,0	BPR7HS-10	1092		
DT 6			1986 - 1992	1,0	B6HS-10	1052		
DT 6			1993 - 2002	0,6	BR6HS	3922	BR6HIX	3419
DT 6			- 1985	0,6	B6HS	4510	BR6HIX	3419
DT 6			1995 - 1999	1,0	BR6HS-10	1090		
DT 6L				0,9	BR6HS	3922	BR6HIX	3419
DT 6L /5PS				0,9	BR6HS	3922	BR6HIX	3419
DT 6S				0,9	BR6HS	3922	BR6HIX	3419
DT 6S /5PS			- 1992	0,8	B6HS	4510	BR6HIX	3419
DT 7,5				0,6	BR6HS	3922	BR6HIX	3419
DT 8			1986 - 2002	0,9	BPR6HS	7022	BPR6HIX	4085
DT 8C			1988 - 1997	1,0	BR6HS-10	1090		
DT 8CL				0,9	BR6HS	3922	BR6HIX	3419
DT 8CS				0,9	BR6HS	3922	BR6HIX	3419
DT 9				0,6	B6HS-10	1052		
DT 9.9			1986 - 1999	1,0	BR7HS-10	1098		
DT 9.9			1977 - 1978	0,6	B7HS	5110	BR7HIX	7067
DT 9.9			1979 - 1984	0,6	BR6HS	3922	BR6HIX	3419
DT 9.9			1976 - 1976	0,6	B6HS	4510	BR6HIX	3419
DT 9.9C			1988 - 1997	1,0	BR6HS-10	1090		
DT 9.9E			1982 -	0,7	B6HS	4510	BR6HIX	3419
DT 9.9E			1984 -	0,7	B7HS	5110	BR7HIX	7067
DT 9.9E			1983 -	1,0	BR7HS-10	1098		
DT 9.9K			1985 - 1986	0,7	B6HS	4510	BR6HIX	3419
DT 9.9K			- 1985	0,7	BR6HS	3922	BR6HIX	3419



Cyl.

Order  
No.

Iridium

Order  
No.**SUZUKI****DT**

DT 9.9K	1986 - 1990	0,7	B6HS	4510	BR6HIX	3419
DT 9.9P	- 1983	0,9	BPR6HS	7022	BPR6HIX	4085
DT 13		0,6	BR7HS	4122	BR7HIX	7067
DT 14		0,6	BR7HS	4122	BR7HIX	7067
DT 15	1986 - 2002	1,0	BR7HS-10	1098		
DT 15C	1989 - 1997	1,0	BR7HS-10	1098		
DT 15K	- 1985	0,7	BR6HS	3922	BR6HIX	3419
DT 15K	1986 -	0,9	B6HS	4510	BR6HIX	3419
DT 16/P		0,7	BR7HS	4122	BR7HIX	7067
DT 20	1997 - 2000	1,0	BR7HS-10	1098		
DT 20/P	- 1985	0,7	BR7HS	4122	BR7HIX	7067
DT 20/P	1986 -	1,0	BR7HS-10	1098		
DT 20K	- 1985	1,0	BR7HS-10	1098		
DT 20K	1986 - 1987	1,0	B7HS-10	2129		
DT 25	- 1985	0,6	BR7HS	4122	BR7HIX	7067
DT 25	2000 - 2001	1,0	BR7HS-10	1098		
DT 25C	1989 - 1997	1,0	BR7HS-10	1098		
DT 25CL		1,0	BR7HS	4122	BR7HIX	7067
DT 25CRL		1,0	BR7HS	4122	BR7HIX	7067
DT 25CRS		1,0	BR7HS	4122	BR7HIX	7067
DT 25CS		1,0	BR7HS	4122	BR7HIX	7067
DT 25E	1983 - 1985	1,0	BPR7HS-10	1092		
DT 25E	- 1982	0,7	B7HS	5110	BR7HIX	7067
DT 25E	1986 -	1,0	BR7HS-10	1098		
DT 25K	1986 -	1,0	BR7HS-10	1098		
DT 28P/ DT 28/ DT 28E ->83		0,7	B7HS	5110	BR7HIX	7067
DT 30	1986 -	1,0	BR7HS-10	1098		
DT 30	1983 - 1985	1,0	BR7HS-10	1098		
DT 30C	1988 - 2000	1,0	BR7HS-10	1098		
DT 30E	1983 -	1,0	BR7HS-10	1098		
DT 40	- 1983	0,9	B8HS	5510	BR8HIX	7001
DT 40/E		0,9	BR8HS	4322	BR8HIX	7001
DT 40C	1986 - 1999	1,0	BR8HS-10	1134		
DT 40C / CR /TC	1998 -	1,0	BR8HS-10	1134		
DT 40CL		1,0	BR8HS	4322	BR8HIX	7001
DT 40CRL		1,0	BR8HS	4322	BR8HIX	7001
DT 40CRS		1,0	BR8HS	4322	BR8HIX	7001
DT 40CS		1,0	BR8HS	4322	BR8HIX	7001
DT 40K/KR		1,0	B7HS-10	2129		
DT 40TCL		1,0	BR8HS	4322	BR8HIX	7001
DT 40TCS		1,0	BR8HS	4322	BR8HIX	7001
DT 40W		0,9	B8HS	5510	BR8HIX	7001
DT 40W	1995 -	1,0	B7HS-10	2129		
DT 40WK	1998 -	1,0	B7HS-10	2129		
DT 40WK	- 1997	0,6	B7HS	5110	BR7HIX	7067
DT 48M	2001 -	1,0	B8HS-10	5126		
DT 48M	- 2000	0,9	B8HS	5510	BR8HIX	7001
DT 50	1979 - 1983	0,9	B8HS	5510	BR8HIX	7001
DT 50	- 1978	0,9	B7HS	5110	BR7HIX	7067
DT 50	1984 - 1989	1,0	B8HS-10	5126		
DT 50ACR	1994 - 1996	1,0	B8HS-10	5126		
DT 50ACR	1993 - 1993	1,0	BR8HS	4322	BR8HIX	7001



Cyl.



Order No.

Iridium



Order No.

**SUZUKI****DT**

DT 50C	1984 - 2000	1,0	<b>B8HS-10</b>	<b>5126</b>		
DT 50K		0,9	<b>B7HS</b>	<b>5110</b>	<b>BR7HIX</b>	<b>7067</b>
DT 50M/DT50(W)	1986 - 1989	1,0	<b>B8HS-10</b>	<b>5126</b>		
DT 50M/DT50(W)/DT50T	- 1985	0,9	<b>B8HS</b>	<b>5510</b>	<b>BR8HIX</b>	<b>7001</b>
DT 50M; DT50(W)	2001 -	1,0	<b>BR8HS-10</b>	<b>1134</b>		
DT 55C	1988 - 1998	1,0	<b>BR8HS-10</b>	<b>1134</b>		
DT 55M; MQ	- 2000	0,9	<b>B8HS</b>	<b>5510</b>	<b>BR8HIX</b>	<b>7001</b>
DT 55M; MQ	2001 -	1,0	<b>BR8HS-10</b>	<b>1134</b>		
DT 55TC; CRQ	1998 -	1,0	<b>BR8HS-10</b>	<b>1134</b>		
DT 55TCL		1,0	<b>BR8HS</b>	<b>4322</b>	<b>BR8HIX</b>	<b>7001</b>
DT 55TCS		1,0	<b>BR8HS</b>	<b>4322</b>	<b>BR8HIX</b>	<b>7001</b>
DT 60		1,0	<b>B8HS-10</b>	<b>5126</b>		
DT 60C	2001 -	1,0	<b>BR8HS-10</b>	<b>1134</b>		
DT 60C	1986 - 1987	1,0	<b>B8HS-10</b>	<b>5126</b>		
DT 65/T	- 1983	0,9	<b>BR8HS</b>	<b>4322</b>	<b>BR8HIX</b>	<b>7001</b>
DT 65C	1988 - 1999	1,0	<b>BR8HS-10</b>	<b>1134</b>		
DT 65TC	1994 - 1995	1,0	<b>BR8HS-10</b>	<b>1134</b>		
DT 65TCL		1,0	<b>BR8HS</b>	<b>4322</b>	<b>BR8HIX</b>	<b>7001</b>
DT 65TCS		1,0	<b>BR8HS</b>	<b>4322</b>	<b>BR8HIX</b>	<b>7001</b>
DT 75/85	1990 - 1992	0,9	<b>B8HS</b>	<b>5510</b>	<b>BR8HIX</b>	<b>7001</b>
DT 75/85	1993 - 2000	1,0	<b>BR8HS-10</b>	<b>1134</b>		
DT 75C	2001 -	1,0	<b>BR8HS-10</b>	<b>1134</b>		
DT 75C	1993 - 2000	0,8	<b>BR8HS</b>	<b>4322</b>	<b>BR8HIX</b>	<b>7001</b>
DT 75M	2001 -	1,0	<b>BR8HS-10</b>	<b>1134</b>		
DT 75M	- 2000	0,8	<b>BR8HS</b>	<b>4322</b>	<b>BR8HIX</b>	<b>7001</b>
DT 75TC	- 2000	0,8	<b>B8HS</b>	<b>5510</b>	<b>BR8HIX</b>	<b>7001</b>
DT 75TC	2001 -	1,0	<b>BR8HS-10</b>	<b>1134</b>		
DT 75W		0,8	<b>BR8HS</b>	<b>4322</b>	<b>BR8HIX</b>	<b>7001</b>
DT 85	- 1992	0,8	<b>BR8HS</b>	<b>4322</b>	<b>BR8HIX</b>	<b>7001</b>
DT 85C	2001 -	1,0	<b>BR8HS-10</b>	<b>1134</b>		
DT 85C	1993 - 2000	0,8	<b>BR8HS</b>	<b>4322</b>	<b>BR8HIX</b>	<b>7001</b>
DT 85C	- 1992	0,8	<b>BR8HS</b>	<b>4322</b>	<b>BR8HIX</b>	<b>7001</b>
DT 85M	2001 -	1,0	<b>BR8HS-10</b>	<b>1134</b>		
DT 85M	- 2000	0,8	<b>BR8HS</b>	<b>4322</b>	<b>BR8HIX</b>	<b>7001</b>
DT 85MQ	1995 - 1996	1,0	<b>B8HS-10</b>	<b>5126</b>		
DT 85Q	2001 -	1,0	<b>BR8HS-10</b>	<b>1134</b>		
DT 85Q	- 2000	0,8	<b>BR8HS</b>	<b>4322</b>	<b>BR8HIX</b>	<b>7001</b>
DT 85TC	- 2000	0,9	<b>B8HS</b>	<b>5510</b>	<b>BR8HIX</b>	<b>7001</b>
DT 85TC	2001 -	1,0	<b>BR8HS-10</b>	<b>1134</b>		
DT 85W	2001 -	1,0	<b>B8HS-10</b>	<b>5126</b>		
DT 85W	- 2000	0,8	<b>BR8HS</b>	<b>4322</b>	<b>BR8HIX</b>	<b>7001</b>
DT 85WT	2001 -	1,0	<b>B8HS-10</b>	<b>5126</b>		
DT 85WT	1995 - 1996	1,0	<b>B8HS-10</b>	<b>5126</b>		
DT 90	- 2000	1,0	<b>BR8HCS-10</b>	<b>1157</b>		
DT 90	2001 -	1,0	<b>BR8HS-10</b>	<b>1134</b>		
DT 90TC	1996 - 1997	0,8	<b>BR8HS</b>	<b>4322</b>	<b>BR8HIX</b>	<b>7001</b>
DT 90TC	- 1995	1,0	<b>BR8HCS-10</b>	<b>1157</b>		
DT 90TC	1998 -	1,0	<b>BR8HS-10</b>	<b>1134</b>		
DT 100	2001 -	1,0	<b>BR8HS-10</b>	<b>1134</b>		
DT 100	1996 - 2000	1,0	<b>BR8HS-10</b>	<b>1134</b>		
DT 100	1990 - 1995	1,0	<b>BR8HCS-10</b>	<b>1157</b>		
DT 100	2000 - 2000	1,0	<b>BR8HCS-10</b>	<b>1157</b>		



Cyl.

Order  
No.

Iridium

Order  
No.**SUZUKI****DT**

DT 100TC	- 1995	1,0	BR8HCS-10	1157		
DT 100TC	1998 -	1,0	BR8HS-10	1134		
DT 100TC	1996 - 1997	0,8	BR8HS	4322	BR8HIX	7001
DT 115	- 1990	0,9	B8HS	5510	BR8HIX	7001
DT 115	1992 -	1,0	BR8HCS-10	1157		
DT 115C	1991 - 1993	1,0	BR8HCS-10	1157		
DT 115C	- 1990	0,9	B8HS	5510	BR8HIX	7001
DT 115C	2001 -	1,0	BR8HS-10	1134		
DT 115S	1996 -	1,0	BR8HS-10	1134		
DT 115STC	1996 -	1,0	BR8HS-10	1134		
DT 115TC	- 1988	1,0	B8HS-10	5126		
DT 115TC		1,0	BR8HCS-10	1157		
DT 115TC (EFI)		1,0	BR8HS-10	1134		
DT 140	1992 -	1,0	BR8HCS-10	1157		
DT 1140	- 1990	0,9	B8HS	5510	BR8HIX	7001
DT 140 EFI	1996 -	1,0	BR8HS-10	1134		
DT 140C	1991 - 1996	1,0	BR8HCS-10	1157		
DT 1140C	- 1990	0,9	B8HS	5510	BR8HIX	7001
DT 140 C EFI	1997 -	1,0	BR8HCS-10	1157		
DT 140T	- 2000	1,0	BR8HCS-10	1157		
DT 140T	2001 -	1,0	BR8HS-10	1134		
DT 140TC	- 2000	1,0	BR8HCS-10	1157		
DT 140TC EFI		1,0	BR8HS-10	1134		
DT 150	1987 - 2002	1,0	BR8HS-10	1134		
DT 150G		1,0	BR8HS-10	1134		
DT 150S		1,0	BR8HS-10	1134		
DT 150SS		1,0	BR8HS-10	1134		
DT 150STC		1,0	BR8HS-10	1134		
DT 150TC	1989 -	1,0	BR8HS-10	1134		
DT 150TC EFI		1,0	BR8HS-10	1134		
DT 175	1989 - 2002	1,0	BR8HS-10	1134		
DT 175TC	- 1988	1,0	B8HS-10	5126		
DT 175TC	1989 -	1,0	BR8HS-10	1134		
DT 200	1989 - 2002	1,0	BR8HS-10	1134		
DT 200G		1,0	BR8HS-10	1134		
DT 200T		1,0	BR8HS-10	1134		
DT 200TC	1989 -	1,0	BR8HS-10	1134		
DT 200V		1,0	BR8HS-10	1134		
DT 225	1991 - 2002	1,0	BR8HS-10	1134		
DT 225TC		1,0	BR8HS-10	1134		
DT 225TCL EFI		1,0	BR8HS	4322	BR8HIX	7001

**PU**

PU 40	- 1993	0,9	B8HS	5510	BR8HIX	7001
PU 40	1994 -	1,0	BR8HS-10	1134		
PU 55	1994 -	1,0	BR8HS-10	1134		
PU 55	- 1993	0,9	B8HS	5510	BR8HIX	7001
PU 85	1994 -	1,0	BR8HS-10	1134		
PU 85	- 1993	0,9	B8HS	5510	BR8HIX	7001
PU 140	- 1993	0,9	B8HS	5510	BR8HIX	7001
PU 140	1994 -	1,0	BR8HS-10	1134		



Cyl.



Order No.

Iridium



Order No.

**TANAKA**

Aqua Bug		0,6	BM6A	5921		
Bumble Bee	1992 -	0,6	BM6F	6221		
Super Bug		0,6	BM6A	5921		
TOB 12		0,6	BM6A	5921		
TOB 120		0,6	BMR6A	7421		
TOB 175		0,6	BMR6A	7421		
TOB 25	- 1985	0,6	BM6A	5921		
TOB 25	1986 -	0,6	BMR6A	7421		
TOB 300		0,6	BMR6A	7421		
TOB 550 / L		0,7	BPR7HS	6422	BPR7HIX	5944

**TECNAMOTOR**

MV85M, MV100M, MV125M		0,6	BM6A	5921		
-----------------------	--	-----	------	------	--	--

**TOHATSU**

2.5 h.p. MFS 2.5 4-Stroke	2003 -	0,6	DCPR6E	3481		
2.5 h.p. (2-stroke) M2.5A 75cc	1	0,8	BPR6HS	7022	BPR6HIX	4085
3.5 h.p. MFS 3.5 4-Stroke	2003 -	0,6	DCPR6E	3481		
3.5 h.p. (2-stroke) M3.5A / M3.5B 75cc	1	0,8	BPR6HS	7022	BPR6HIX	4085
4.0 h.p. MFS 4A 4 HP 4-Stroke	2000 -	0,6	DCPR6E	3481		
4.0 h.p. M4C	1	0,8	BPR7HS	6422	BPR7HIX	5944
5.0 h.p. MFS 5A 4-Stroke	1999 -	0,6	DCPR6E	3481		
5.0 h.p. B13B , B9B	1	0,8	BR6HS	3922	BR6HIX	3419
5.0 h.p. M5B, M5BS 2-Stroke	1	1,0	BPR7HS-10	1092		
5.0 h.p. (4-stroke) 123cc	1	0,9	FR5	4876		
6.0 h.p. M6B	1	0,8	BPR7HS	6422	BPR7HIX	5944
6.0 h.p. MFS 6A 4-Stroke	2000 -	0,6	DCPR6E	3481		
8.0 h.p. (2-stroke) M8A, M8B 169cc	2	0,7	BPR5HS	6222		
8.0 h.p. Proof 8 BEF, 169cc	2	0,8	BPR7HS	6422	BPR7HIX	5944
8.0 h.p. B13B , B9B	1	0,8	BR6HS	3922	BR6HIX	3419
8.0 h.p. 4-Stroke	2003 -	0,6	DCPR6E	3481		
9.8 h.p. MFS 9.8A 4-Stroke	2003 -	0,6	DCPR6E	3481		
9.8 h.p. B18C , B18D		0,8	BR6HS	3922	BR6HIX	3419
9.9 h.p. M9.9B2 / M9.9C 2-Stroke	2	0,8	BR7HS	4122	BR7HIX	7067
9.9 h.p. MFS 9.9A / B 9,9HP 4-Stroke	2000 -	0,6	DCPR6E	3481		
12.0 h.p. M12B		1,0	BR7HS-10	1098		
12.0 h.p. B18C , B18D		0,8	BR6HS	3922	BR6HIX	3419
13.0 h.p. M13	2	1,0	BR7HS-10	1098		
15.0 h.p. MFS 15A / B /B2 15 HP 4-Stroke	2000 -	0,6	DCPR6E	3481		
15.0 h.p. M15A / M15B2 / M15C / M15D 2-Stroke	2	1,0	BR7HS-10	1098		
16.0 h.p. M16		1,0	BR7HS-10	1098		
18.0 h.p. M18A / M18C2 / M18D / M18E / 294cc / (2-stroke)	2	1,0	BR7HS-10	1098		
18.0 h.p. MFS 18B4 /18B 4-Stroke	2001 -	0,6	DCPR6E	3481		
18.0 h.p. MFS 18B2 4-Stroke	2001 -	0,6	DCPR6E	3481		
20.0 h.p. M20		1,0	BR7HS-10	1098		
20.0 h.p. B40A, B30C		1,0	BR6HS-10	1090		
25.0 h.p. Proof 25C2, 430cc	2	1,0	BR7HS-10	1098		
25.0 h.p. M25C,M25C2	2	1,0	BR7HS-10	1098		
25.0 h.p. B40A, B30C		1,0	BR6HS-10	1090		

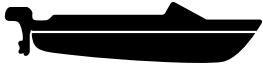

Cyl.

Order  
No.

Iridium

Order  
No.**TOHATSU**

25.0 h.p. MFS 25A 4-Stroke		2002 -	0,6	DCPR6E	3481		
30.0 h.p. (2-stroke) M30A / M30A3 / 430cc	2		1,0	BR7HS-10	1098		
30.0 h.p. MFS 30A 4-Stroke		2002 -	0,6	DCPR6E	3481		
35.0 h.p. M35A			0,9	BPR7HS	6422	BPR7HIX	5944
40.0 h.p. MD40B TLDI		2004 -	0,8	PZFR6H	7696		
40.0 h.p. M40D/2 / 697cc / (2-stroke)	3		0,9	BPR7HS	6422	BPR7HIX	5944
40.0 h.p. Proof 40D Mega / 697cc	3		1,0	B8HS-10	5126		
40.0 h.p. Proof 40D Mega / 697cc / EFTO	3		1,0	B8HS-10	5126		
40.0 h.p. M40D Mega EPTO / (2-stroke) / 697cc	3		0,6	BR7HS	4122	BR7HIX	7067
40.0 h.p. M40C / 493cc / (2-stroke)	2		1,0	BPR6HS-10	2633		
40.0 h.p. MD40A TLDI		2004 -	1,1	ZFR6F-11	4291		
50.0 h.p. (2-stroke) / 697cc	3		1,0	B8HS-10	5126		
50.0 h.p. MD50A TLDI		2004 -	1,1	ZFR6F-11	4291		
50.0 h.p. MD50B TLDI		2004 -	0,8	PZFR6H	7696		
50.0 h.p. W50		2004 -	0,8	PZFR6H	7696		
50.0 h.p. M50C / M50D	3		1,0	B8HS-10	5126		
55.0 h.p. M55A / B	3		1,0	B8HS-10	5126		
60.0 h.p. (2-stroke) / 938cc / M60A / M60B / M60C	3		1,0	B8HS-10	5126		
70.0 h.p. MD70A 2 TLDI		2004 -	1,1	ZFR6F-11	4291		
70.0 h.p. MD70B TLDI		2004 -	0,8	IZFR5J			
70.0 h.p. (2-stroke) / 938cc / M70A / M70A2 / M70B	3		1,0	B8HS-10	5126		
80.0 h.p. M80A			1,0	B8HS-10	5126		
90.0 h.p. (2-stroke) / 1267cc / M90A	3		1,0	B8HS-10	5126		
90.0 h.p. MD90B TLDI		2004 -	0,8	IZFR5J			
90.0 h.p. MD90A TLDI		2004 -	1,1	ZFR6F-11	4291		
90.0 h.p. MD90A 2 TLDI		2004 -	1,1	ZFR6F-11	4291		
115.0 h.p. MD115A TLDI		2004 -	0,8	IZFR5J			
115.0 h.p. M115A / A2	4		1,0	B8HS-10	5126		
120.0 h.p. (2-stroke) / 1768cc / M120A	4		1,0	B8HS-10	5126		
140.0 h.p. (2-stroke) / 1768cc / M140A	4		1,0	B8HS-10	5126		

**TOMOS**

18			1,0	BPR7HS-10	1092		
18E			1,0	BPR7HS-10	1092		
3.0 h.p.			0,6	B6HS	4510	BR6HIX	3419
3.5 h.p.			0,6	B6HS	4510	BR6HIX	3419
4.4 h.p. Electronic / 10 / 10E			0,6	B6HS	4510	BR6HIX	3419
4.5 h.p.			0,6	B6HS	4510	BR6HIX	3419
5.0 h.p.5 / TS4 / Lamo 06N			0,6	BR7HS	4122	BR7HIX	7067
T10			0,6	BR7HS	4122	BR7HIX	7067
T18			0,6	BR7HS	4122	BR7HIX	7067
T4RN			0,6	B6HS	4510	BR6HIX	3419

**TRITON**

4.0 h.p.			0,8	XR5	5953	XR5IX	7355
5.5 h.p.			0,8	XR5	5953	XR5IX	7355
7.5 h.p.			0,8	XR5	5953	XR5IX	7355



Cyl.



Order No.

Iridium



Order No.

**VALMET**

Terhi 3			0,7	<b>BP5S</b>	<b>3011</b>		
Terhi 3.5 PS			0,5	<b>B6S</b>	<b>3510</b>		
Terhi 4.5PS, 9.9PS, 23PS			0,5	<b>B6HS</b>	<b>4510</b>	<b>BR6HIX</b>	<b>3419</b>
Terhi 5, 15, 20, 40			0,5	<b>B6HS</b>	<b>4510</b>	<b>BR6HIX</b>	<b>3419</b>
Terhi 50 PS			0,5	<b>BP5HS</b>	<b>4111</b>		
Tern 6, 17, 25			0,5	<b>B6HS</b>	<b>4510</b>	<b>BR6HIX</b>	<b>3419</b>

**VIKING**

3.5, 15 PS		1965 - 1971	0,8	<b>B6L</b>	<b>3212</b>		
6 PS		1965 - 1971	0,8	<b>B6L</b>	<b>3212</b>		
9.2 PS		1960 - 1970	0,8	<b>B6S</b>	<b>3510</b>		
9.6, 20, 35, 55 PS		1968 - 1971	0,8	<b>B6HS</b>	<b>4510</b>	<b>BR6HIX</b>	<b>3419</b>

**VOLVO PENTA**

35		- 1974	1,0	<b>BR7HS-10</b>	<b>1098</b>		
39		- 1974	1,0	<b>BR7HS-10</b>	<b>1098</b>		
39		1975 - 1979	1,0	<b>BR7HS-10</b>	<b>1098</b>		
40		- 1974	1,0	<b>BR7HS-10</b>	<b>1098</b>		
50		- 1974	1,0	<b>BR7HS-10</b>	<b>1098</b>		
50A		- 1974	1,0	<b>BR7HS-10</b>	<b>1098</b>		
51		1975 - 1979	1,0	<b>BR7HS-10</b>	<b>1098</b>		
60		1978 - 1979	1,0	<b>BR7HS-10</b>	<b>1098</b>		
80		- 1974	1,0	<b>BR6HS-10</b>	<b>1090</b>		
90		- 1979	1,0	<b>BR6HS-10</b>	<b>1090</b>		
120		- 1974	1,0	<b>BR6HS-10</b>	<b>1090</b>		
140		- 1979	1,0	<b>BR6HS-10</b>	<b>1090</b>		
200		1976 - 1979	1,0	<b>BPR7HS-10</b>	<b>1092</b>		
250		1975 -	1,0	<b>BPR7HS-10</b>	<b>1092</b>		
252		- 1974	0,9	<b>BPR7HS</b>	<b>6422</b>	<b>BPR7HIX</b>	<b>5944</b>
350		1975 - 1976	1,0	<b>BPR7HS-10</b>	<b>1092</b>		
360		- 1974	1,0	<b>BR7HS-10</b>	<b>1098</b>		
450		- 1974	1,0	<b>BPR7HS-10</b>	<b>1092</b>		
450		1975 - 1976		<b>BUHX</b>	<b>2522</b>		
550X		1971 - 1974	1,0	<b>BPR7HS-10</b>	<b>1092</b>		
600		1975 - 1976	1,0	<b>BPR7HS-10</b>	<b>1092</b>		
600		- 1974	1,0	<b>BPR7HS-10</b>	<b>1092</b>		
700		- 1974	1,0	<b>BPR7HS-10</b>	<b>1092</b>		
700		1975 - 1979	1,0	<b>BPR7HS-10</b>	<b>1092</b>		
U22		- 1974	1,0	<b>BR7HS-10</b>	<b>1098</b>		

**VOYAGER**

1VA, 2VA, 1VB, V-2L/2LL/2N			0,8	<b>A6</b>	<b>1010</b>		
V-3L-GS, V-3N-GS, V-3LL-GS			0,8	<b>B6S</b>	<b>3510</b>		
V-4L-GS			0,8	<b>A6</b>	<b>1010</b>		
V-4LL-GS, V-4N-GS			0,8	<b>B6S</b>	<b>3510</b>		
V-6LL-GS, V-6N-GS			0,8	<b>B6S</b>	<b>3510</b>		





Cyl.

Order  
No.

Iridium

Order  
No.**WEST BEND**

18 h.p.	1960 - 1962	0,9	<b>BR6S</b>	<b>3522</b>		
20 h.p.	1961 - 1965	0,9	<b>BR6S</b>	<b>3522</b>		
35 h.p.	1964 - 1965	0,9	<b>BR6S</b>	<b>3522</b>		
40 h.p.	1961 - 1962	0,9	<b>BR6S</b>	<b>3522</b>		
45 h.p.	1961 - 1965	0,9	<b>BR6S</b>	<b>3522</b>		
50 h.p.	1964 - 1965	0,9	<b>BR6S</b>	<b>3522</b>		
80 h.p.	1961 - 1965	0,9	<b>BR6S</b>	<b>3522</b>		

**WHITE AUTO STORES**

4.5 h.p.	1975 -	0,9	<b>XR4</b>	<b>2637</b>	<b>XR4IX</b>	<b>7189</b>
5.0 h.p.	1972 - 1974	0,9	<b>XR4</b>	<b>2637</b>	<b>XR4IX</b>	<b>7189</b>
5.5 h.p.	1975 -	0,9	<b>XR4</b>	<b>2637</b>	<b>XR4IX</b>	<b>7189</b>
7.0 h.p.	1972 - 1974	0,9	<b>XR4</b>	<b>2637</b>	<b>XR4IX</b>	<b>7189</b>
7.5 h.p.	1975 -	0,9	<b>XR4</b>	<b>2637</b>	<b>XR4IX</b>	<b>7189</b>
7.5 h.p.	1972 - 1974	0,9	<b>XR4</b>	<b>2637</b>	<b>XR4IX</b>	<b>7189</b>
9.9 h.p.	1972 - 1974	0,9	<b>XR4</b>	<b>2637</b>	<b>XR4IX</b>	<b>7189</b>
15.0 h.p.	1972 - 1974	0,9	<b>XR4</b>	<b>2637</b>	<b>XR4IX</b>	<b>7189</b>

**WHITEHEAD**

W6,W12,W24,W25S,W30 all models		0,5	<b>B6HS</b>	<b>4510</b>	<b>BR6HIX</b>	<b>3419</b>
--------------------------------	--	-----	-------------	-------------	---------------	-------------

**WIZARD**

3.0 h.p.	1976 -	0,9	<b>XR4</b>	<b>2637</b>	<b>XR4IX</b>	<b>7189</b>
3.2 h.p.WD3 / WD35		0,9	<b>BR6S</b>	<b>3522</b>		
3.5 h.p.	1970 - 1974	0,9	<b>XR4</b>	<b>2637</b>	<b>XR4IX</b>	<b>7189</b>
4.5 h.p.	1975 -	0,9	<b>XR4</b>	<b>2637</b>	<b>XR4IX</b>	<b>7189</b>
5.0 h.p.	1977 - 1979	0,9	<b>XR4</b>	<b>2637</b>	<b>XR4IX</b>	<b>7189</b>
5.0 h.p.WH6 / WH6-1 / WH6A		0,9	<b>BR6S</b>	<b>3522</b>		
5.0 h.p.	1969 -	0,9	<b>BR6S</b>	<b>3522</b>		
5.0 h.p.	1970 - 1974	0,9	<b>XR4</b>	<b>2637</b>	<b>XR4IX</b>	<b>7189</b>
5.5 h.p.	1976 -	0,9	<b>XR4</b>	<b>2637</b>	<b>XR4IX</b>	<b>7189</b>
5.5 h.p.	1975 -	0,9	<b>XR4</b>	<b>2637</b>	<b>XR4IX</b>	<b>7189</b>
5.5 h.p.	1977 - 1979	0,9	<b>XR4</b>	<b>2637</b>	<b>XR4IX</b>	<b>7189</b>
5.5 h.p.OC575 / OC585		0,9	<b>BR6S</b>	<b>3522</b>		
6.0 h.p.WF4 / WGA		0,9	<b>BR6S</b>	<b>3522</b>		
6.0 h.p.WD4 / WD4S		0,9	<b>BR6S</b>	<b>3522</b>		
7.0 h.p.	1969 -	0,9	<b>XR4</b>	<b>2637</b>	<b>XR4IX</b>	<b>7189</b>
7.0 h.p.	1970 - 1974	0,9	<b>XR4</b>	<b>2637</b>	<b>XR4IX</b>	<b>7189</b>
7.5 h.p.	1970 - 1979	0,9	<b>XR4</b>	<b>2637</b>	<b>XR4IX</b>	<b>7189</b>
9.2 h.p.	1966 - 1971	0,9	<b>BR6S</b>	<b>3522</b>		
9.9 h.p.	1970 - 1979	0,9	<b>XR4</b>	<b>2637</b>	<b>XR4IX</b>	<b>7189</b>
10.0 h.p.WK7 / WM7 / WM7A		0,9	<b>BR6S</b>	<b>3522</b>		
10.0 h.p.WF7 / WG7		0,9	<b>BR6S</b>	<b>3522</b>		
10.0 h.p.WH7 / WG7A / WJ7		0,9	<b>BR6S</b>	<b>3522</b>		
12.0 h.p.	1959 - 1964	0,9	<b>BR6S</b>	<b>3522</b>		
12.0 h.p.WN7 / WN7A		0,9	<b>BR6S</b>	<b>3522</b>		
14.0 h.p.	1959 - 1964	0,9	<b>BR6S</b>	<b>3522</b>		
20.0 h.p.	1965 - 1967	0,9	<b>BR6S</b>	<b>3522</b>		



Cyl.

Order  
No.

Iridium

Order  
No.**WIZARD**

20.0 h.p.	1968 - 1971	0,8	<b>BR6HS</b>	<b>3922</b>	<b>BR6HIX</b>	<b>3419</b>
25.0 h.p. WA25 / WA25E		0,9	<b>BR6S</b>	<b>3522</b>		
35.0 h.p. OC3585		0,9	<b>A6</b>	<b>1010</b>		
40.0 h.p.	1959 - 1964	0,9	<b>BR6S</b>	<b>3522</b>		
60.0 h.p.	1959 - 1964	0,9	<b>BR6S</b>	<b>3522</b>		

**YAMAHA**

2A		0,6	<b>B6HS</b>	<b>4510</b>	<b>BR6HIX</b>	<b>3419</b>
2B	1987 -	0,6	<b>BR5HS</b>	<b>3722</b>		
2B	- 1984	0,6	<b>BR5HS</b>	<b>3722</b>		
2B	1985 - 1986	0,6	<b>B7HS</b>	<b>5110</b>	<b>BR7HIX</b>	<b>7067</b>
2C	1995 -	0,6	<b>B7HS</b>	<b>5110</b>	<b>BR7HIX</b>	<b>7067</b>
3,5A/AC		0,6	<b>B6HS</b>	<b>4510</b>	<b>BR6HIX</b>	<b>3419</b>
3A (Malta)		1,0	<b>BR6HS-10</b>	<b>1090</b>		
4A/AC/AS/BC		0,6	<b>BR7HS</b>	<b>4122</b>	<b>BR7HIX</b>	<b>7067</b>
4A/B	2001 -	0,6	<b>B7HS</b>	<b>5110</b>	<b>BR7HIX</b>	<b>7067</b>
5A/AS		0,6	<b>B7HS</b>	<b>5110</b>	<b>BR7HIX</b>	<b>7067</b>
5B/BS		0,6	<b>B6HS</b>	<b>4510</b>	<b>BR6HIX</b>	<b>3419</b>
5C		0,6	<b>BR7HS</b>	<b>4122</b>	<b>BR7HIX</b>	<b>7067</b>
5D		0,6	<b>B5HS</b>	<b>4210</b>		
6A		0,6	<b>B6HS</b>	<b>4510</b>	<b>BR6HIX</b>	<b>3419</b>
6B		0,6	<b>B5HS</b>	<b>4210</b>		
6C		1,0	<b>BR7HS-10</b>	<b>1098</b>		
6D		1,0	<b>BR6HS-10</b>	<b>1090</b>		
7A		0,6	<b>B6HS</b>	<b>4510</b>	<b>BR6HIX</b>	<b>3419</b>
8A		0,6	<b>B6HS</b>	<b>4510</b>	<b>BR6HIX</b>	<b>3419</b>
8B		0,6	<b>B7HS</b>	<b>5110</b>	<b>BR7HIX</b>	<b>7067</b>
8C		1,0	<b>BR7HS-10</b>	<b>1098</b>		
9.5A		0,6	<b>B7HS</b>	<b>5110</b>	<b>BR7HIX</b>	<b>7067</b>
9.9B		0,6	<b>B7HS</b>	<b>5110</b>	<b>BR7HIX</b>	<b>7067</b>
9.9D		1,0	<b>BR7HS-10</b>	<b>1098</b>		
9.9F	1995 -	1,0	<b>BR7HS-10</b>	<b>1098</b>		
9A		0,6	<b>B6HS</b>	<b>4510</b>	<b>BR6HIX</b>	<b>3419</b>
12A		0,6	<b>B7HS</b>	<b>5110</b>	<b>BR7HIX</b>	<b>7067</b>
13.5A		1,0	<b>BR7HS-10</b>	<b>1098</b>		
13.5F		1,0	<b>B7HS-10</b>	<b>2129</b>		
15 2 stroke 15	2 2004 -	1,0	<b>B7HS-10</b>	<b>2129</b>		
15A		0,6	<b>B7HS</b>	<b>5110</b>	<b>BR7HIX</b>	<b>7067</b>
15B		0,6	<b>B7HS</b>	<b>5110</b>	<b>BR7HIX</b>	<b>7067</b>
15C		0,6	<b>B7HS</b>	<b>5110</b>	<b>BR7HIX</b>	<b>7067</b>
15D		1,0	<b>BR7HS-10</b>	<b>1098</b>		
15F	1995 -	1,0	<b>BR7HS-10</b>	<b>1098</b>		
20A		0,6	<b>B6HS</b>	<b>4510</b>	<b>BR6HIX</b>	<b>3419</b>
20B		0,6	<b>B6HS</b>	<b>4510</b>	<b>BR6HIX</b>	<b>3419</b>
20C (C20)	1999 -	0,6	<b>B7HS</b>	<b>5110</b>	<b>BR7HIX</b>	<b>7067</b>
20C/CE/CM		1,0	<b>BR7HS-10</b>	<b>1098</b>		
20D		1,0	<b>BR7HS-10</b>	<b>1098</b>		
25A		0,6	<b>B7HS</b>	<b>5110</b>	<b>BR7HIX</b>	<b>7067</b>
25B	- 1994	0,6	<b>B7HS</b>	<b>5110</b>	<b>BR7HIX</b>	<b>7067</b>
25B	2001 -	1,0	<b>BR7HS-10</b>	<b>1098</b>		
25B/25Q	1995 - 2000	1,0	<b>BR7HS-10</b>	<b>1098</b>		



Cyl.

Order  
No.

Iridium

Order  
No.**YAMAHA**

25CMK			0,6	B6HS	4510	BR6HIX	3419
25D (C25)			0,6	B7HS	5110	BR7HIX	7067
25DE			1,0	BR7HS-10	1098		
25J			1,0	BR7HS-10	1098		
25N			1,0	BR7HS-10	1098		
25V (25)		1995 -	1,0	BR7HS-10	1098		
28A/AE			0,6	B7HS	5110	BR7HIX	7067
30A/AE/AM			0,6	B7HS	5110	BR7HIX	7067
30D			1,0	BR7HS-10	1098		
30G		1995 -	1,0	B8HS-10	5126		
30H		2001 -	1,0	B8HS-10	5126		
40AE/AM/AR			0,6	B8HS	5510	BR8HIX	7001
40BE/BM/BR			0,6	B8HS	5510	BR8HIX	7001
40C			0,6	B8HS	5510	BR8HIX	7001
40D		- 1989	0,6	B8HS	5510	BR8HIX	7001
40F			0,6	B8HS	5510	BR8HIX	7001
40FE			1,0	B7HS-10	2129		
40GK			0,6	B7HS	5110	BR7HIX	7067
40H			1,0	BR7HS-10	1098		
40J		2001 -	0,6	B7HS	5110	BR7HIX	7067
40Q (40)		1995 -	0,6	BR8HS	4322	BR8HIX	7001
40V		1995 -	1,0	BR7HS-10	1098		
40X		- 2000	0,6	BR7HS	4122	BR7HIX	7067
40Y (MH)		2001 -	1,0	BR7HS-10	1098		
40Y (ET)		2001 -	1,0	BR8HS-10	1134		
48A/B			0,6	B7HS	5110	BR7HIX	7067
50 50TLRB		2003 -	1,0	B7HS-10	2129		
50		2001 -	0,9	B8HS-10	5126		
50C			0,6	B8HS	5510	BR8HIX	7001
50CE			1,0	B8HS-10	5126		
50D			1,0	BR8HS-10	1134		
50G / 50H		1995 -	1,0	BR8HS-10	1134		
50H		1995 -	1,0	BR8HS-10	1134		
55AE		- 1978	0,6	B8HS	5510	BR8HIX	7001
55AE		1979 -	1,0	B8HS-10	5126		
55AEM/AM/AW			0,6	B8HS	5510	BR8HIX	7001
55B			1,0	B8HS-10	5126		
55B		1990 -	1,0	BR8HS-10	1134		
55B(M)		1995 -	0,6	B8HS	5510	BR8HIX	7001
55BM/BW			0,6	B8HS	5510	BR8HIX	7001
60 4stroke T60		2004 -	0,9	DPR5EA-9	2887		
60		2001 -	0,9	B8HS-10	5126		
60AE		1979 -	1,0	B8HS-10	5126		
60AE		- 1978	0,6	B8HS	5510	BR8HIX	7001
60B			1,0	B8HS-10	5126		
60CE/CET			1,0	B8HS-10	5126		
60D		1986 -	1,0	BR8HS-10	1134		
60DE			1,0	B8HS-10	5126		
60F			1,0	BR8HS-10	1134		
70B			1,0	BR8HS-10	1134		
70C			1,0	BR8HS-10	1134		
70ETO			1,0	BR8HS-10	1134		



Cyl.

Order  
No.

Iridium

Order  
No.**YAMAHA**

75A			1,0	BR8HS-10	1134		
75B			1,0	BR8HS-10	1134		
75C			1,0	BR8HS-10	1134		
80A			1,0	BR8HS-10	1134		
85A			1,0	BR8HS-10	1134		
90 4stroke F90		2003 -	1,1	LFR5A-11	6376		
90A			1,0	BR8HS-10	1134		
100 F100		1999 - 2002	1,1	LFR5A-11	6376		
100 AETOL		1998 -	1,0	BR8HS-10	1134		
100A			1,0	BR8HS-10	1134		
115 4stroke F115		2004 -	1,1	LFR6A-11	3672		
115A		2004 -	1,0	B8HS-10	5126		
115AEO/AO			1,0	BR8HS-10	1134		
115B/BETO			1,0	BR8HS-10	1134		
115C			1,0	BR8HS-10	1134		
115D		1995 -	1,0	BR8HS-10	1134		
130A			1,0	BR9HS-10	4551		
130B		1995 -	1,0	BR9HS-10	4551		
130BETO			1,0	BR9HS-10	4551		
140A			1,0	BR8HS-10	1134		
140B		- 1988	1,0	BR8HS-10	1134		
140B		1989 -	1,0	BR9HS-10	4551		
140BETO			1,0	BR9HS-10	4551		
140C / L140C		1995 -	1,0	BR9HS-10	4551		
150A		- 1985	1,0	BR7HS-10	1098		
150A		1986 -	1,0	BR8HS-10	1134		
150AETO/C			1,0	BR8HS-10	1134		
150C			1,0	BR8HS-10	1134		
150F / L150F			1,0	BR7HS-10	1098		
150G			1,0	BR7HS-10	1098		
175A			1,0	BR8HS-10	1134		
175B			1,0	BR8HS-10	1134		
175D			1,0	BR8HS-10	1134		
175F			1,0	BR8HS-10	1134		
200A			1,0	BR8HS-10	1134		
200C			1,0	BR9HS-10	4551		
200F (L200F)			1,0	BR8HS-10	1134		
200G			1,0	BR8HS-10	1134		
220A / AET		1986 -	1,0	BR8HS-10	1134		
225AETO			1,0	BR8HS-10	1134		
225A0/BETO/B/C			1,0	BR9HS-10	4551		
225D			1,0	BR8HS-10	1134		
225G			1,0	BR9HS-10	4551		
250A / L250A			1,0	BR8HS-10	1134		
250B / L250B			1,0	BR9HS-10	4551		
D150H			1,0	BR8HS-10	1134		
E 8D			1,0	BR7HS-10	1098		
E40X / 40X			0,6	BR7HS	4122	BR7HIX	7067
E60H			1,0	BR8HS-10	1134		
F 2.5A 4Stroke	1	2002 -	0,8	BR6HS	3922	BR6HIX	3419
F 4A	1	1998 -	0,8	BR6HS	3922	BR6HIX	3419
F 6A 4Stroke	2	2000 -	1,0	BR6HS-10	1090		



Cyl.

Order  
No.

Iridium

Order  
No.**YAMAHA**

F 6B	4-Stroke	2	2001 -	1,0	BR6HS-10	1090		
F 8	4-Stroke 8,0 HP	2	2001 -	0,9	BR6HS-10	1090		
F 8A		2	- 1985	0,6	CR6HS	7023	CR6HIX	7274
F 8A/AM/AEM		2	1986 - 2002	0,6	CR5HS	2874	CR5HIX	7120
F 8B/BM/BE		2	1986 -	0,6	CR5HS	2874	CR5HIX	7120
F 8C	4Stroke	2	2000 -	1,0	BR6HS-10	1090		
F 9.9A		2	1985 - 2000	0,6	CR6HS	7023	CR6HIX	7274
F 9.9B		2	1986 - 2000	0,6	CR6HS	7023	CR6HIX	7274
F 9.9C / D		2	1998 - 2003	0,9	DPR6EA-9	5531		
F 9.9 DE		2		1,0	BR7HS-10	1098		
F 13.5A		2	1998 - 2003	0,9	DPR6EA-9	5531		
F15A		2	1998 - 2003	0,9	DPR6EA-9	5531		
F20A		2	1998 - 2001	0,9	DPR6EA-9	5531		
F25A (E,ET)		2	1998 - 2002	0,9	DPR6EA-9	5531		
F25A (MH)				0,9	DPR6EA-9	5531		
F30	OHC 4-Stroke	3	2001 - 2002	0,9	DPR6EA-9	5531		
F30A	4 Stroke	3	2001 - 2002	0,9	DPR6EA-9	5531		
F40A		3	2000 - 2002	0,9	DPR6EA-9	5531		
F40B	4Stroke	3	2000 - 2002	0,9	DPR6EA-9	5531		
F40C				0,9	DPR5EA-9	2887		
F45A / AETL			1998 -	0,9	DPR6EA-9	5531		
F50 (EFI) 4cyl. 4stroke OHC standard				0,9	DPR6EB-9	3108		
F50A./ B.		4	1995 - 2002	0,9	DPR6EA-9	5531		
F60A	4Stroke	4	2002 -	0,9	DPR5EA-9	2887		
F60 (EFI)	4stroke			0,9	DPR6EB-9	3108		
F80A	4Stroke	4	2000 - 2003	1,1	LFR5A-11	6376		
F100A	4Stroke	4	1999 - 2003	1,1	LFR5A-11	6376		
F115	V4 -1,7L	4	1999 - 2003	1,1	LFR6A-11	3672		
F115A	4Stroke (FL115A)	4		1,1	LFR6A-11	3672		
F150 V6 2.6L 4Takt/Stroke		6	2004 -	1,1	LFR5A-11	6376		
F150A (FL150A)		6		1,1	LFR5A-11	6376		
F200A	4Stroke (FL200A)	6	2002 -	1,1	LFR5A-11	6376		
F225A	4Stroke (FL225A)	6	2002 -	1,1	LFR5A-11	6376		
F250A		6		1,1	LFR5A-11	6376		
FT8D	4Stroke	2		1,0	BR6HS-10	1090		
FT9.9 A...		2	1998 -	0,6	CR6HS	7023	CR6HIX	7274
FT9.9D	4Stroke	2		0,9	DPR6EA-9	5531		
FT25B	4Stroke	2		0,9	DPR6EA-9	5531		
FT50C	4Stroke	4		0,9	DPR6EA-9	5531		
FT50G		4		0,9	DPR6EA-9	5531		
FT50B / BETL		4	1998 -	0,9	DPR6EA-9	5531		
FT60D		4		0,9	DPR6EA-9	5531		
FT60B	4Stroke	4		0,9	DPR5EA-9	2887		
FX700 (FX1)			1995 -	0,6	BR8HS	4322	BR8HIX	7001
L 4 3,0 L. Z-Antrieb				0,6	BR6FS	4323		
L140BETO				1,0	BR9HS-10	4551		
L150A/150C/L150C/150D			1995 -	1,0	BR8HS-10	1134		
L150AETO/CETO				1,0	BR8HS-10	1134		
L150F				1,0	BR7HS-10	1098		
L200A/L200B			1995 -	1,0	BR8HS-10	1134		
L200AETO/BETO				1,0	BR8HS-10	1134		
L200F				1,0	BR8HS-10	1134		



Cyl.

Order  
No.

Iridium

Order  
No.**YAMAHA**

L225C		1995 -	1,0	BR8HS-10	1134		
LF115 V4 -1,7L	4	2000 -	1,1	LFR6A-11	3672		
LF150 V6 2.6L	6	2004 -	1,1	LFR5A-11	6376		
LS150F			1,0	BR7HS-10	1098		
LX300 3.3L 300HP		2004 -		BKR6EKU	6993		
LZ150P				BKR6EKU	6993		
LZ150TX HPDI (From 800555)		2001 -		BKR6EKU	6993		
LZ150TX HPDI (To 800554)		2000 - 2001	1,1	BKR6ES-11	5553	BKR6EIX-11	3764
LZ200 V6 2,6L	6	2000 -	1,1	BKR7ES-11	2387		
LZ200TX HPDI (2000 to 100874)		2000 - 2001	1,1	BKR7ES-11	2387		
LZ200TX HPDI (From 100875)		2001 -		BKR7EKU	5881		
MJ500S/T			0,6	B7HS	5110	BR7HIX	7067
PRO 100			1,0	BR8HS-10	1134		
PROV200		1996 -	1,0	BR8HS-10	1134		
PROV200		- 1995	1,0	BR9HS-10	4551		
RA1100 (Raider 1100)		1995 -	0,6	BR8HS	4322	BR8HIX	7001
RA700 (Raider)		1995 -	0,6	BR8HS	4322	BR8HIX	7001
RA700A (Raider)		1995 -	0,6	BR8HS	4322	BR8HIX	7001
S150U			1,0	BR7HS-10	1098		
S200F			1,0	BR8HS-10	1134		
SJ650 (Super Jet)		1995 -	0,6	BR8HS	4322	BR8HIX	7001
SJ700 (Super Jet)		1995 -	0,6	BR8HS	4322	BR8HIX	7001
T8 OHV 4-Stroke High Thrust 8,0 HP		2001 -	0,9	BR6HS-10	1090		
T25 OHC 4-Stroke High Thrust 25 HP		2001 -	0,9	DPR6EA-9	5531		
T 50 LRD(EFI)4cyl. 4stroke OHC High Thrust			0,9	DPR6EB-9	3108		
T 50 (EFI)4cyl. 4stroke OHC High Thrust			0,9	DPR6EB-9	3108		
T 60 (EFI) 4stroke			0,9	DPR6EB-9	3108		
V 6 4,3 L. Z-Antrieb	6		0,6	BR6FS	4323		
V 8 5,0 L. Z-Antrieb	8		0,6	BR6FS	4323		
V 8 5,7 L. Z-Antrieb	8		0,6	BR6FS	4323		
V 8 7,4 L. Z-Antrieb	8		0,6	BR6FS	4323		
V175 V6 2,6L	6	2000 -	0,9	BR8HS-10	1134		
Vmax 150HPDI (Z150Q) 2Stroke				BKR6EKU	6993		
Vmax 150TRP (D150H) 2Stroke			1,0	BR8HS-10	1134		
Vmax 200 (200G) 2Stroke			1,0	BR8HS-10	1134		
Vmax 200HPDI (Z200P) 2Stroke				BKR7EKU	5881		
Vmax 225EFI (225G) 2Stroke			1,0	BR9HS-10	4551		
Vmax 250HPDI (Z250F) 2Stroke				BKR7EKU	5881		
VX150 V6 2,6L	6	2000 -	0,6	BR7HS	4122	BR7HIX	7067
VX200 V760 EFI V6 3,1L	6	2000 -	0,9	BR8HS-10	1134		
VZ150TL HPDI (From 800712)		2001 -		BKR6EKU	6993		
VZ150TL HPDI (To 800711)		2000 - 2001	1,1	BKR6ES-11	5553	BKR6EIX-11	3764
VZ175TL HPDI (800105 to 800201)		2001 -	1,1	BKR7ES-11	2387		
VZ175TL HPDI (From 800202)		2001 -		BKR7EKU	5881		
VZ250		2003 -		BKR7EKU	5881		
VZ250		2004 -		BKR6EKU	6993		
VZ300		2004 -		BKR6EKU	6993		
WB700 (Blaster)		1995 -	0,6	BR8HS	4322	BR8HIX	7001
WJ500/F(89)			0,6	B7HS	5110	BR7HIX	7067
WR500/F(89)			0,6	B7HS	5110	BR7HIX	7067
WRA650 (Runner III)		1995 -	0,6	BR8HS	4322	BR8HIX	7001
WRA700 (Runner III GP)		1995 -	0,6	BR8HS	4322	BR8HIX	7001





CCM

Order  
No.Platin/  
Gold-  
PalladiumOrder  
No.

Iridium

Order  
No.**AQUABUG**

Aquabug 120 1.2HP	120		BP5S	3011	0,8				
Superbug 175 1.75HP	175		BP5S	3011	0,8				
Superbug 300 3.0HP	300		BP5S	3011	0,8				

**AQUA-JET**

Solution SX1	432		B7ES	1111	0,8	B7EVX	6934		
--------------	-----	--	------	------	-----	-------	------	--	--

**AQUASCOOTER**

ILO engine	---		B5HS	4210	0,8				
------------	-----	--	------	------	-----	--	--	--	--

**ARCTCO**

Barracuda	639	1994 -	BR9EV	4725	0,8	BR9EVX	1265	BR9EIX	3981
Daytona	639	1994 -	BR9EV	4725	0,8	BR9EVX	1265	BR9EIX	3981
Monte Carlo	639	1994 -	BR9EV	4725	0,8	BR9EVX	1265	BR9EIX	3981
Montego	639	1995 -	BR9EV	4725	0,8	BR9EVX	1265	BR9EIX	3981
Montego Deluxe	639	1995 -	BR9EV	4725	0,8	BR9EVX	1265	BR9EIX	3981
Tigershark Daytona	639	1993 -	BR9EV	4725	0,8	BR9EVX	1265	BR9EIX	3981
TS 640	640	1998 -	BR9EYA	7548	0,7	BR9EVX	1265		
TS 640 L	640	1998 -	BR9EYA	7548	0,7	BR9EVX	1265		
TS 640 R	640	1998 -	BR9EYA	7548	0,7	BR9EVX	1265		
Montego	644	1994 -	BR9EV	4725	0,8	BR9EVX	1265	BR9EIX	3981
Montego Deluxe	644	1994 -	BR9EV	4725	0,8	BR9EVX	1265	BR9EIX	3981
Tigershark	644	1993 -	BR9EV	4725	0,8	BR9EVX	1265	BR9EIX	3981
Tigershark Daytona	644	1993 -	BR9EV	4725	0,8	BR9EVX	1265	BR9EIX	3981
Daytona 770	768	1996 - 1997	BR9EV	4725	0,8	BR9EVX	1265	BR9EIX	3981
Monte Carlo 770	770	1996 - 1997	BR9EV	4725	0,8	BR9EVX	1265	BR9EIX	3981
TS 770	770	1998 -	BR9EYA	7548	0,7	BR9EVX	1265		
TS 770 L	770	1998 -	BR9EYA	7548	0,7	BR9EVX	1265		
TS 770 R	770	1998 -	BR9EYA	7548	0,7	BR9EVX	1265		
Monte Carlo 900	896	1995 -	BR9EV	4725	0,8	BR9EVX	1265	BR9EIX	3981
Tigershark	900	1995 -	BR9EV	4725	0,8	BR9EVX	1265	BR9EIX	3981
Daytona 1000	1000	1997 -	BR9EV	4725	0,8	BR9EVX	1265	BR9EIX	3981
Monte Carlo 1000	1000	1997 -	BR9EV	4725	0,8	BR9EVX	1265	BR9EIX	3981
TS 1000 L	1000	1998 -	BR9EYA	7548	0,7	BR9EVX	1265		
TS 1000 R	1000	1998 -	BR9EYA	7548	0,7	BR9EVX	1265		

**BOMBARDIER**

Barracuda Premium 6157/6158		2004 -	BR8ES	5422	0,6	BR8EVX	1262	BR8EIX	5044
Bullet 5599/6115/6162/6163		2004 -	DCPR8E	4339	0,6	DCPR8EVX	2265	DCPR8EIX	6546
GTI LE 6135/6136		2004 -	BR8ES	5422	0,6	BR8EVX	1262	BR8EIX	5044
GTI STD 6133/6134		2004 -	BR8ES	5422	0,6	BR8EVX	1262	BR8EIX	5044
GTI-RFI LE 6139/6140		2004 -	BR8ES	5422	0,6	BR8EVX	1262	BR8EIX	5044
GTI-RFI STD 6137/6138		2004 -	BR8ES	5422	0,6	BR8EVX	1262	BR8EIX	5044
GTX 4-Tec LTD 6141/6142		2004 -	DCPR8E	4339	0,6	DCPR8EVX	2265	DCPR8EIX	6546
GTX 4-Tec STD 6147/6148		2004 -	DCPR8E	4339	0,6	DCPR8EVX	2265	DCPR8EIX	6546
GTX 4-Tec Supercharg 6143/6144		2004 -	DCPR8E	4339	0,6	DCPR8EVX	2265	DCPR8EIX	6546
GTX 4-Tec Wake 6149/6150		2004 -	DCPR8E	4339	0,6	DCPR8EVX	2265	DCPR8EIX	6546





ccm

Order  
No.Platin/  
Gold-  
PalladiumOrder  
No.

Iridium

Order  
No.**BOMBARDIER**

XP-Di STD 6151/6152		2004 -	ZFR4F-11	4043	1,1				
5801	580	1988 -	BR7ES	5122	0,7	BR7EVX	4556		
5802	580	1989 -	BR7ES	5122	0,7	BR7EVX	4556		
5803	580	1990 -	BR7ES	5122	0,7	BR7EVX	4556		
5810	580	1990 -	BR7ES	5122	0,7	BR7EVX	4556		
EXP	580	1993 -	BR7ES	5122	0,7	BR7EVX	4556		
GT	580	1991 -	BR7ES	5122	0,7	BR7EVX	4556		
GTS	580	1992 -	BR7ES	5122	0,7	BR7EVX	4556		
GTX	580	1992 - 1993	BR7ES	5122	0,7	BR7EVX	4556		
SP	580	1991 -	BR7ES	5122	0,7	BR7EVX	4556		
SPi	580	1993 -	BR7ES	5122	0,7	BR7EVX	4556		
SPX	580	1993 -	BR7ES	5122	0,7	BR7EVX	4556		
XP	580	1991 - 1992	BR7ES	5122	0,7	BR7EVX	4556		
GTX	650	1994 -	BR8ES	5422	0,6	BR8EVX	1262	BR8EIX	5044
SPX	650	1994 -	BR8ES	5422	0,6	BR8EVX	1262	BR8EIX	5044
XP	650	1993 -	BR8ES	5422	0,6	BR8EVX	1262	BR8EIX	5044
GS	718	1997 -	BR8ES	5422	0,6	BR8EVX	1262	BR8EIX	5044
GSI	718	1997 -	BR8ES	5422	0,6	BR8EVX	1262	BR8EIX	5044
GTI	718	1996 - 1997	BR8ES	5422	0,6	BR8EVX	1262	BR8EIX	5044
GTI 3	718	1997 -	BR8ES	5422	0,6	BR8EVX	1262	BR8EIX	5044
GTS	718	1998 -	BR8ES	5422	0,6	BR8EVX	1262	BR8EIX	5044
GTS	718	1997 -	BR8ES	5422	0,6	BR8EVX	1262	BR8EIX	5044
HX	718	1995 -	BR8ES	5422	0,6	BR8EVX	1262	BR8EIX	5044
SPX	718	1996 - 1997	BR8ES	5422	0,6	BR8EVX	1262	BR8EIX	5044
XP	718	1995 -	BR8ES	5422	0,6	BR8EVX	1262	BR8EIX	5044
XP 785	781	1995 -	BR8ES	5422	0,6	BR8EVX	1262	BR8EIX	5044
GSX	782	1996 - 1997	BR8ES	5422	0,6	BR8EVX	1262	BR8EIX	5044
GTX	782	1996 - 1997	BR8ES	5422	0,6	BR8EVX	1262	BR8EIX	5044
SP	782	1997 -	BR8ES	5422	0,6	BR8EVX	1262	BR8EIX	5044
SPX	782	1997 -	BR8ES	5422	0,6	BR8EVX	1262	BR8EIX	5044
XP	782	1996 - 1997	BR8ES	5422	0,6	BR8EVX	1262	BR8EIX	5044
GSX Limited	951	1997 -	BR8ES	5422	0,6	BR8EVX	1262	BR8EIX	5044
GTX Limited	951	1998 -	BR8ES	5422	0,6	BR8EVX	1262	BR8EIX	5044
XP Limited	951	1998 -	BR8ES	5422	0,6	BR8EVX	1262	BR8EIX	5044

**DOLPHIN**

Mark 7 Auxiliary 12HP			B6ES	7310	0,6	B6EVX	5136		
-----------------------	--	--	------	------	-----	-------	------	--	--

**FUN BOATS**

Pump'r with 60HP			B7HS	5110	1,0	B7HVX	7836	BR7HIX	7067
------------------	--	--	------	------	-----	-------	------	--------	------

**HONDA**

ARX 1200 N3/T3	1200	2002 - 2004			0,9			IMR9D-9H	6544
ARX 1200 N2/T2	1200	2004 - 2004			0,9			IMR9D-9H	6544



CCM

Order  
No.Platin/  
Gold-  
PalladiumOrder  
No.

Iridium

Order  
No.**HYDRO-DISC**

50 HP			<b>B9ES</b>	<b>2611</b>	0,8	<b>B9EVX</b>	<b>7254</b>	<b>BR9EIX</b>	<b>3981</b>
-------	--	--	-------------	-------------	-----	--------------	-------------	---------------	-------------

**JET BREEZE**

Hurricane 50 HP			<b>B9ES</b>	<b>2611</b>	0,8	<b>B9EVX</b>	<b>7254</b>	<b>BR9EIX</b>	<b>3981</b>
-----------------	--	--	-------------	-------------	-----	--------------	-------------	---------------	-------------

**JET STAR 1250**

Suzuki engine			<b>B6HS</b>	<b>4510</b>	0,8	<b>B6HVX</b>	<b>7435</b>	<b>BR6HIX</b>	<b>3419</b>
---------------	--	--	-------------	-------------	-----	--------------	-------------	---------------	-------------

**KAWASAKI**

300	300		<b>BR7ES</b>	<b>5122</b>	0,8	<b>BR7EVX</b>	<b>4556</b>		
300SX	300		<b>B7ES</b>	<b>1111</b>	0,8	<b>B7EVX</b>	<b>6934</b>		
JS 400A	400		<b>B7ES</b>	<b>1111</b>	0,8	<b>B7EVX</b>	<b>6934</b>		
440	440		<b>BR7ES</b>	<b>5122</b>	0,8	<b>BR7EVX</b>	<b>4556</b>		
440 SX	440	- 1992	<b>BR7ES</b>	<b>5122</b>	0,8	<b>BR7EVX</b>	<b>4556</b>		
550	550	1986 -	<b>BR8ES</b>	<b>5422</b>	0,8	<b>BR8EVX</b>	<b>1262</b>	<b>BR8EIX</b>	<b>5044</b>
550	550	- 1985	<b>BR7ES</b>	<b>5122</b>	0,8	<b>BR7EVX</b>	<b>4556</b>		
550SX	550		<b>BR8ES</b>	<b>5422</b>	0,8	<b>BR8EVX</b>	<b>1262</b>	<b>BR8EIX</b>	<b>5044</b>
650SC	650		<b>BR7ES</b>	<b>5122</b>	0,8	<b>BR7EVX</b>	<b>4556</b>		
650SX	650		<b>BR7ES</b>	<b>5122</b>	0,8	<b>BR7EVX</b>	<b>4556</b>		
650TS	650		<b>BR7ES</b>	<b>5122</b>	0,8	<b>BR7EVX</b>	<b>4556</b>		
650X-2	650		<b>BR7ES</b>	<b>5122</b>	0,8	<b>BR7EVX</b>	<b>4556</b>		
JB 650 Jet Mate	650	1989 - 1992	<b>BR7ES</b>	<b>5122</b>	0,8	<b>BR7EVX</b>	<b>4556</b>		
JF 650 AX-2	650	1986 - 1995	<b>BR7ES</b>	<b>5122</b>	0,8	<b>BR7EVX</b>	<b>4556</b>		
JF 650 B TS	650	1989 - 1996	<b>BR7ES</b>	<b>5122</b>	0,8	<b>BR7EVX</b>	<b>4556</b>		
Mate	650		<b>BR7ES</b>	<b>5122</b>	0,8	<b>BR7EVX</b>	<b>4556</b>		
750 X4 (JH750E)	750		<b>BR8ES</b>	<b>5422</b>	0,7	<b>BR8EVX</b>	<b>1262</b>	<b>BR8EIX</b>	<b>5044</b>
750 XII (JH750F)	750		<b>BR8ES</b>	<b>5422</b>	0,7	<b>BR8EVX</b>	<b>1262</b>	<b>BR8EIX</b>	<b>5044</b>
750 ZXI (JH750C)	750		<b>BR8ES</b>	<b>5422</b>	0,7	<b>BR8EVX</b>	<b>1262</b>	<b>BR8EIX</b>	<b>5044</b>
750FX	750		<b>BR8ES</b>	<b>5422</b>	0,8	<b>BR8EVX</b>	<b>1262</b>	<b>BR8EIX</b>	<b>5044</b>
750SS	750		<b>BR8ES</b>	<b>5422</b>	0,8	<b>BR8EVX</b>	<b>1262</b>	<b>BR8EIX</b>	<b>5044</b>
750STS (JT750B1)	750		<b>BR8ES</b>	<b>5422</b>	0,8	<b>BR8EVX</b>	<b>1262</b>	<b>BR8EIX</b>	<b>5044</b>
750SX	750		<b>BR9ES</b>	<b>5722</b>	0,8	<b>BR9EVX</b>	<b>1265</b>	<b>BR9EIX</b>	<b>3981</b>
750SXi (JT750B1)	750		<b>BR8ES</b>	<b>5422</b>	0,8	<b>BR8EVX</b>	<b>1262</b>	<b>BR8EIX</b>	<b>5044</b>
750X-4	750		<b>BR8ES</b>	<b>5422</b>	0,8	<b>BR8EVX</b>	<b>1262</b>	<b>BR8EIX</b>	<b>5044</b>
750Xi	750		<b>BR8ES</b>	<b>5422</b>	0,8	<b>BR8EVX</b>	<b>1262</b>	<b>BR8EIX</b>	<b>5044</b>
750ZXi (JH750C1)	750		<b>BR8ES</b>	<b>5422</b>	0,8	<b>BR8EVX</b>	<b>1262</b>	<b>BR8EIX</b>	<b>5044</b>
JH 750 A Super Sport	750	1992 - 1994	<b>BR8ES</b>	<b>5422</b>	0,8	<b>BR8EVX</b>	<b>1262</b>	<b>BR8EIX</b>	<b>5044</b>
JH 750 B Super Sport Xi	750	1993 - 1995	<b>BR8ES</b>	<b>5422</b>	0,8	<b>BR8EVX</b>	<b>1262</b>	<b>BR8EIX</b>	<b>5044</b>
JH 750 E Super Sport	750	1996 - 1998	<b>BR8ES</b>	<b>5422</b>	0,8	<b>BR8EVX</b>	<b>1262</b>	<b>BR8EIX</b>	<b>5044</b>
JH 750 G	750	1998 -	<b>BR8ES</b>	<b>5422</b>	0,8	<b>BR8EVX</b>	<b>1262</b>	<b>BR8EIX</b>	<b>5044</b>
JS 750 A	750	1992 - 1994	<b>BR8ES</b>	<b>5422</b>	0,8	<b>BR8EVX</b>	<b>1262</b>	<b>BR8EIX</b>	<b>5044</b>
JS 750 C SXI	750	1998 -	<b>BR8ES</b>	<b>5422</b>	0,8	<b>BR8EVX</b>	<b>1262</b>	<b>BR8EIX</b>	<b>5044</b>
JS 750 SX (JS750A)	750		<b>BR8ES</b>	<b>5422</b>	0,7	<b>BR8EVX</b>	<b>1262</b>	<b>BR8EIX</b>	<b>5044</b>
JS 750 SXI (JS750B)	750		<b>BR8ES</b>	<b>5422</b>	0,7	<b>BR8EVX</b>	<b>1262</b>	<b>BR8EIX</b>	<b>5044</b>
JT 750 C	750	1998 -	<b>BR8ES</b>	<b>5422</b>	0,8	<b>BR8EVX</b>	<b>1262</b>	<b>BR8EIX</b>	<b>5044</b>
JT 750 Sxi Pro	750	2003 -	<b>BR8ES</b>	<b>5422</b>	0,8	<b>BR8EVX</b>	<b>1262</b>	<b>BR8EIX</b>	<b>5044</b>
JS 800 SX-R	800	2003 -	<b>BR9ES</b>	<b>5722</b>	0,8	<b>BR9EVX</b>	<b>1265</b>	<b>BR9EIX</b>	<b>3981</b>
900 ZXI (JH900A)	900		<b>BR9ES</b>	<b>5722</b>	0,7	<b>BR9EVX</b>	<b>1265</b>	<b>BR9EIX</b>	<b>3981</b>
900ZXi (JH900A1)	900		<b>BR9ES</b>	<b>5722</b>	0,8	<b>BR9EVX</b>	<b>1265</b>	<b>BR9EIX</b>	<b>3981</b>



ccm

Order  
No.Platin/  
Gold-  
PalladiumOrder  
No.

Iridium

Order  
No.**KAWASAKI**

JT 900 STX	900	1998 -	BR9ES	5722	0,8	BR9EVX	1265	BR9EIX	3981
1100 STX	1071	1998 -	BR9ES	5722	0,8	BR9EVX	1265	BR9EIX	3981
1100 SXI	1071	1998 -	BR9ES	5722	0,8	BR9EVX	1265	BR9EIX	3981
JH 1100-A	1071	1998 -	BR9ES	5722	0,8	BR9EVX	1265	BR9EIX	3981
JT 1100-B	1071	1998 -	BR9ES	5722	0,8	BR9EVX	1265	BR9EIX	3981
1100 STX (JT1100A)	1100		BR9ES	5722	0,7	BR9EVX	1265	BR9EIX	3981
1100 ZXI (JH1100A)	1100		BR9ES	5722	0,7	BR9EVX	1265	BR9EIX	3981
STX 1100 Di	1100	2002 -	BR9ES	5722	0,8	BR9EVX	1265	BR9EIX	3981
STX 1100 Di (C1/F1)	1100	2000 -	PZFR7G-G	4253	0,8				
150Ultra	1200	2004 -	BR9ES	5722	0,8	BR9EVX	1265	BR9EIX	3981
JH 1200 Ultra 150	1200	1999 - 2000	R6918C-9	5196	0,6				
JH 1200 Ultra 150	1200	2000 -	BR9ES	5722	0,8	BR9EVX	1265	BR9EIX	3981
STX 1200	1200	2000 -	BR9ES	5722	0,8	BR9EVX	1265	BR9EIX	3981
STX 1200 12F	1200	2003 -	CR9EK	4548	0,6			CR9EIX	3521
STX 1200 F	1200	2004 -	CR9EK	4548	0,6			CR9EIX	3521
STX 1200 R	1200	2002 -	BR9ES	5722	0,8	BR9EVX	1265	BR9EIX	3981
STX 1500 F	1500	2004 -	CR9EK	4548	0,6			CR9EIX	3521
250X Ultra	1500	2006 -				PMR9B	4717		

**NAUTICA**

Mercury 90HP			BZ7HS-10	3579	1,0				
Mercury 120HP			BZ7HS-10	3579	1,0				

**POLARIS**

SL	650	1994 - 1995	BPR7ES	2023	0,7	BPR7EVX	5565	BPR7EIX	4055
Delux	700	1997 -	BPR6ES	7822	0,8	BPR6EVX	6764	BPR6EIX	6637
Hurricane	700	1996 - 1997	BPR8ES	3923	0,7	BPR8EVX	5573		
SL-700	700	1996 - 1997	BPR7ES	2023	0,7	BPR7EVX	5565	BPR7EIX	4055
SLR-700	700	1996 - 1997	BPR7ES	2023	0,7	BPR7EVX	5565	BPR7EIX	4055
SLT-700	700	1996 - 1997	BPR7ES	2023	0,7	BPR7EVX	5565	BPR7EIX	4055
SL 750	750	1994 - 1995	BPR7ES	2023	0,7	BPR7EVX	5565	BPR7EIX	4055
SLT 750	750	1995 -	BPR7ES	2023	0,7	BPR7EVX	5565	BPR7EIX	4055
SLX Pro785 EC78PWE 04	778	1998 -	BR9ES	5722	0,8	BR9EVX	1265	BR9EIX	3981
SL-780	780	1996 - 1997	BPR8ES	3923	0,7	BPR8EVX	5573		
SLT-780	780	1996 - 1997	BPR8ES	3923	0,7	BPR8EVX	5573		
SLX EC78ZPWE 04	780	1998 -	BR9ES	5722	0,8	BR9EVX	1265	BR9EIX	3981
SLX-780	780	1996 - 1997	BPR8ES	3923	0,7	BPR8EVX	5573		
SL-900	900	1996 - 1997	BPR8ES	3923	0,7	BPR8EVX	5573		
SLT-1050	1050	1996 - 1997	BPR8ES	3923	0,7	BPR8EVX	5573		
SLTX W 105 TCSP 04	1050	1998 -	BR9ES	5722	0,8	BR9EVX	1265	BR9EIX	3981
SLTX-1050	1050	1996 - 1997	BPR8ES	3923	0,7	BPR8EVX	5573		
SLXH W 9105 TCSP 05	1050	1998 -	BR9ES	5722	0,8	BR9EVX	1265	BR9EIX	3981
SLTX-1051	1051	1999 -	BPR8ES	3923	0,7	BPR8EVX	5573		
SLX-1051	1051	1999 -	BPR8ES	3923	0,7	BPR8EVX	5573		
Genesis 1165	1165	1999 -	BR9ES	5722	0,8	BR9EVX	1265	BR9EIX	3981
Genesis 1165 inj.	1165	2000 -	PZFR6H	7696	0,8				
Pro 1165	1165	2000 -	BR9ES	5722	0,8	BR9EVX	1265	BR9EIX	3981
SLX 1165	1165	2000 -	BR9ES	5722	0,8	BR9EVX	1265	BR9EIX	3981



CCM

Order  
No.Platin/  
Gold-  
PalladiumOrder  
No.

Iridium

Order  
No.**POLARIS**

Virage 1165	1165	2000 -	BR9ES	5722	0,8	BR9EVX	1265	BR9EIX	3981
Virage 1165 inj.	1165	2001 -	PZFR6H	7696	0,8				
X45 1165	1165	1999 -	BR9ES	5722	0,8	BR9EVX	1265	BR9EIX	3981
Genesis 1200 inj.	1200	2000 -	PZFR6H	7696	0,8				

**POWER BOARD**

Power Board		1989 -	BPR7HS-10	1092	1,0				
-------------	--	--------	-----------	------	-----	--	--	--	--

**PROGRESSIVE POWER**

Formula Micro		1987 - 1990	BPM6A	7021	0,6				
---------------	--	-------------	-------	------	-----	--	--	--	--

**SEA-DOO**

Barracuda Premium		2004 -	BR8ES	5422	0,8	BR8EVX	1262	BR8EIX	5044
GTi STD,LE,RFI		2004 -	BR8ES	5422	0,8	BR8EVX	1262	BR8EIX	5044
5801	580	1988 - 1995	BR7ES	5122	0,6	BR7EVX	4556		
5802	580	1989 -	BR7ES	5122	0,6	BR7EVX	4556		
5803	580	1990 -	BR7ES	5122	0,6	BR7EVX	4556		
5810	580	1990 -	BR7ES	5122	0,6	BR7EVX	4556		
EXP	580	1993 -	BR7ES	5122	0,6	BR7EVX	4556		
GT	580	1991 -	BR7ES	5122	0,6	BR7EVX	4556		
GTS	580	1992 - 1997	BR7ES	5122	0,6	BR7EVX	4556		
GTX	580	1992 - 1993	BR7ES	5122	0,6	BR7EVX	4556		
SP	580	1991 - 1997	BR7ES	5122	0,6	BR7EVX	4556		
SPI	580	1993 - 1997	BR7ES	5122	0,6	BR7EVX	4556		
SPX	580	1993 -	BR7ES	5122	0,6	BR7EVX	4556		
XP	580	1991 - 1993	BR7ES	5122	0,6	BR7EVX	4556		
GTX 650	650	1994 - 1995	BR8ES	5422	0,8	BR8EVX	1262	BR8EIX	5044
SPX 650	650	1994 - 1995	BR8ES	5422	0,8	BR8EVX	1262	BR8EIX	5044
XP 650	650	1993 - 1995	BR8ES	5422	0,8	BR8EVX	1262	BR8EIX	5044
GS 718	718	1997 -	BR8ES	5422	0,8	BR8EVX	1262	BR8EIX	5044
GSi 718	718	1997 - 1999	BR8ES	5422	0,8	BR8EVX	1262	BR8EIX	5044
GTi 718	718	1996 -	BR8ES	5422	0,8	BR8EVX	1262	BR8EIX	5044
GTi 718 Le,Le Rfi	718	2003 -	BR8ES	5422	0,8	BR8EVX	1262	BR8EIX	5044
GTS 718	718	1997 -	BR8ES	5422	0,8	BR8EVX	1262	BR8EIX	5044
HX 718	718	1995 - 1996	BR8ES	5422	0,8	BR8EVX	1262	BR8EIX	5044
SPX 718	718	1996 - 1997	BR8ES	5422	0,8	BR8EVX	1262	BR8EIX	5044
XP 718	718	1995 -	BR8ES	5422	0,8	BR8EVX	1262	BR8EIX	5044
GSX 782	782	1996 - 1998	BR8ES	5422	0,8	BR8EVX	1262	BR8EIX	5044
GTX 782	782	1996 - 1998	BR8ES	5422	0,8	BR8EVX	1262	BR8EIX	5044
SP 782	782	1997 -	BR8ES	5422	0,8	BR8EVX	1262	BR8EIX	5044
SPX 782	782	1997 - 1998	BR8ES	5422	0,8	BR8EVX	1262	BR8EIX	5044
XP 782	782	1995 - 1997	BR8ES	5422	0,8	BR8EVX	1262	BR8EIX	5044
GTX 947 Di	947	2000 -	ZFR5F	5165	0,8			ZFR5FIX-11	2477
RX 947	947	2000 -	ZFR5F	5165	0,8			ZFR5FIX-11	2477
GSX 951 Limited	951	1997 - 1998	BR8ES	5422	0,8	BR8EVX	1262	BR8EIX	5044
GTX 951 Di	951	2000 -	ZFR5F	5165	0,8			ZFR5FIX-11	2477
LRV 951	951		BR8ES	5422	0,8	BR8EVX	1262	BR8EIX	5044
RX 951 Di	951	2003 -	ZFR4F-11	4043	1,1				



ccm

Order  
No.Platin/  
Gold-  
PalladiumOrder  
No.

Iridium

Order  
No.**SEA-DOO**

RX 951 Di	951	2001 -	ZFR5F	5165	0,8			ZFR5FIX-11	2477
XP 951	951	1996 -	BR8ES	5422	0,8	BR8EVX	1262	BR8EIX	5044
XP 951 LTD Di	951	2004 -	ZFR4F-11	4043	1,1				

**SEAFLASH**

Suzuki engine			B6HS	4510	0,8	B6HVX	7435	BR6HIX	3419
---------------	--	--	------	------	-----	-------	------	--------	------

**SEA-SOO**

Bullet		2004 -	DCPR8E	4339	0,8	DCPR8EVX	2265	DCPR8EIX	6546
GTX 1494 4TEC Lim.Superchar.	1500	2004 -	DCPR8E	4339	0,8	DCPR8EVX	2265	DCPR8EIX	6546
GTX 1494 4TEC Superchar.	1500	2004 -	DCPR8E	4339	0,8	DCPR8EVX	2265	DCPR8EIX	6546

**SKIDADDL**

Aquajet			BR7ES	5122	0,8	BR7EVX	4556		
---------	--	--	-------	------	-----	--------	------	--	--

**SKI-FREE**

2 Cyl. 40HP			BR8ES	5422	0,6	BR8EVX	1262	BR8EIX	5044
-------------	--	--	-------	------	-----	--------	------	--------	------

**SKI-WHEEL**

Ski Tow Kohler 440-2LC	440		B9ES	2611	0,6	B9EVX	7254	BR9EIX	3981
------------------------	-----	--	------	------	-----	-------	------	--------	------

**SOS EXPRESS**

Tide Rider Cuyuna 45HP			BR8ES	5422	0,6	BR8EVX	1262	BR8EIX	5044
------------------------	--	--	-------	------	-----	--------	------	--------	------

**SURF- JET**

Fuji engine LC 26	255	1980 - 1997	B6HS	4510	0,6	B6HVX	7435	BR6HIX	3419
Fuji engine LC 26	260	1980 - 1997	B6HS	4510	0,6	B6HVX	7435	BR6HIX	3419
Fuji engine LC26	260	1998 -	B7HS	5110	0,6	B7HVX	7836	BR7HIX	7067

**SUZUKI**

Nomad 292	292		B7HS	5110	0,7	B7HVX	7836	BR7HIX	7067
C340	340		BR9EYA	7548	0,8			BR9EIX	3981
F340	340		BR9EYA	7548	0,8			BR9EIX	3981
Nomad 336	340		B7HS	5110	0,7	B7HVX	7836	BR7HIX	7067
SM10	360		B7HS	5110	0,7	B7HVX	7836	BR7HIX	7067
SM10D	360		B7HS	5110	0,7	B7HVX	7836	BR7HIX	7067
C370	370		BR9EYA	7548	0,8			BR9EIX	3981
F370	370		BR9EYA	7548	0,8			BR9EIX	3981
SM20	395		B7HS	5110	0,7	B7HVX	7836	BR7HIX	7067
SM20 Hop Up Kit	395		B8ES	2411	0,7	B8EVX	7051	BR8EIX	5044
Wide Track 400	395		B7HS	5110	0,7	B7HVX	7836	BR7HIX	7067
XR400	395		B7HS	5110	0,7	B7HVX	7836	BR7HIX	7067
C-ZRV 440	400	2000 -	BR9EYA	7548	0,8			BR9EIX	3981
L / C-ZRV 440	400	1998 -	BR10ES	4832	0,7	BR10EVX	7613	BR10EIX	6801



CCM



Order No.

Platin/  
Gold-  
Palladium

Order No.

Iridium



Order No.

**SUZUKI**

L / C-ZRV 440	400	1999 -	BR10EYA	6029	0,8	BR10EVX	7613	BR10EIX	6801
L440	400	2000 -	BR9EYA	7548	0,8			BR9EIX	3981
XR440	432		B7HS	5110	0,7	B7HVX	7836	BR7HIX	7067
C440	433		BR9EYA	7548	0,8			BR9EIX	3981
C-LWS 440	433		BR9EYA	7548	0,8			BR9EIX	3981
F / C-C 440	433		BR9ES	5722	0,8	BR9EVX	1265	BR9EIX	3981
F440	433		BR9EYA	7548	0,8			BR9EIX	3981
L440	433		BR9EYA	7548	0,8			BR9EIX	3981
SM 440M	433				0,8	BR9EVX	1265	BR9EIX	3981
F / C 500	500		BR9ES	5722	0,8	BR9EVX	1265	BR9EIX	3981
L / C 500	500		BR9EYA	7548	0,8			BR9EIX	3981
L / C 500	500	2000 -	BR10EYA	6029	0,8	BR10EVX	7613	BR10EIX	6801
L / C-EID 500	500		BR9EYA	7548	0,8			BR9EIX	3981
L / C 530	530		BR10ES	4832	0,7	BR10EVX	7613	BR10EIX	6801
L / C 550	530		BR9EYA	7548	0,8			BR9EIX	3981
L / C-EID 580	580		BR9EYA	7548	0,8			BR9EIX	3981
L / C 600	600		BR9EYA	7548	0,8			BR9EIX	3981
L / C-EID 600	600		BR9EYA	7548	0,8			BR9EIX	3981
L / C 650	650		BR10ES	4832	0,7	BR10EVX	7613	BR10EIX	6801
L / C 700	650		BR10ES	4832	0,7	BR10EVX	7613	BR10EIX	6801
F / C 700	700	- 1995	BR9ES	5722	0,8	BR9EVX	1265	BR9EIX	3981
L / C 785	785		BR9EYA	7548	0,8			BR9EIX	3981
L / C 800	800		BR9EYA	7548	0,8			BR9EIX	3981
L / C 900	900		BR9EYA	7548	0,8			BR9EIX	3981
L / C 1000	1000		BR9EYA	7548	0,8			BR9EIX	3981

**THUNDER JET**

F - II 700			BR8ES	5422	0,6	BR8EVX	1262	BR8EIX	5044
F - II 800			BR8ES	5422	0,6	BR8EVX	1262	BR8EIX	5044
F14			BR8ES	5422	0,6	BR8EVX	1262	BR8EIX	5044
F15			BR8ES	5422	0,6	BR8EVX	1262	BR8EIX	5044

**TIDE RIDER**

Cuyuna engine 45HP			BR8ES	5422	0,6	BR8EVX	1262	BR8EIX	5044
--------------------	--	--	-------	------	-----	--------	------	--------	------

**TIGERSHARK**

639	639	1993 - 1997	B9ES	2611	0,6	B9EVX	7254	BR9EIX	3981
644	644	1993 - 1994	B9ES	2611	0,6	B9EVX	7254	BR9EIX	3981
768	768	1997 -	B9ES	2611	0,6	B9EVX	7254	BR9EIX	3981
896	896	1995 - 1997	B9ES	2611	0,6	B9EVX	7254	BR9EIX	3981
999	999	1997 -	B9ES	2611	0,6	B9EVX	7254	BR9EIX	3981

**ULTRANAUTICS**

Wetbike Suzuki engine			B7HS	5110	1,0	B7HVX	7836	BR7HIX	7067
Seafash ST Suzuki engine	789		B7HS	5110	1,0	B7HVX	7836	BR7HIX	7067
Seafash XL Suzuki engine	789		B7HS	5110	1,0	B7HVX	7836	BR7HIX	7067
Seafash XP Suzuki engine	789		B7HS	5110	1,0	B7HVX	7836	BR7HIX	7067



ccm

Order  
No.Platin/  
Gold-  
PalladiumOrder  
No.

Iridium

Order  
No.**ULTRANAUTICS**

Mercury engine	1231		BUHW	2622					
----------------	------	--	------	------	--	--	--	--	--

**WET JET**

428	428	1985 -	BR8ES	5422	0,7	BR8EVX	1262	BR8EIX	5044
428 LC	428	1986 - 1988	BR8ES	5422	0,7	BR8EVX	1262	BR8EIX	5044
200 Duo	432	1994 -	BR8ES	5422	0,7	BR8EVX	1262	BR8EIX	5044
432	432	1988 -	BR8ES	5422	0,7	BR8EVX	1262	BR8EIX	5044
432 Brut	432	1988 - 1992	BR8ES	5422	0,7	BR8EVX	1262	BR8EIX	5044
Special Edition Brut	432	1991 - 1992	BR8ES	5422	0,7	BR8EVX	1262	BR8EIX	5044
Sport Brut	432	1992 -	BR8ES	5422	0,7	BR8EVX	1262	BR8EIX	5044
Sport II Brut	432	1990 - 1992	BR8ES	5422	0,7	BR8EVX	1262	BR8EIX	5044
Duo	701	1996 -	BR8HS	4322	0,6	BR8HVX	6265	BR8HIX	7001
Duo 300	701	1995 -	BR8HS	4322	0,6	BR8HVX	6265	BR8HIX	7001
Duo 300ZX	701	1995 -	BR8HS	4322	0,6	BR8HVX	6265	BR8HIX	7001
Duo 300ZX Kraze	701	1995 -	BR8HS	4322	0,6	BR8HVX	6265	BR8HIX	7001
Kraze	701	1996 - 1997	BR8HS	4322	0,6	BR8HVX	6265	BR8HIX	7001
ZX	701	1996 -	BR8HS	4322	0,6	BR8HVX	6265	BR8HIX	7001

**WETBIKE**

Spirit engine			B7HS	5110	1,0	B7HVX	7836	BR7HIX	7067
Suzuki engine			B6HS	4510	0,8	B6HVX	7435	BR6HIX	3419

**WILD CAT**

Brute 50HP			B9ES	2611	0,6	B9EVX	7254	BR9EIX	3981
Brute 75HP			B9ES	2611	0,6	B9EVX	7254	BR9EIX	3981

**YAMAHA**

FX 140 F1B	140	2002 -	CR9EB	6955	0,7				
WJ 500	500	1987 - 1990	B7HS	5110	0,6	B7HVX	7836	BR7HIX	7067
WJ 500	500		B7HS	5110	0,6	B7HVX	7836	BR7HIX	7067
WR 500	500	1987 - 1994	B7HS	5110	0,6	B7HVX	7836	BR7HIX	7067
WR 500	500	1987 - 1993	B7HS	5110	0,6	B7HVX	7836	BR7HIX	7067
MJ 650	650	1989 - 1994	BR8HS	4322	0,6	BR8HVX	6265	BR8HIX	7001
MJ T 650	650	1990 - 1995	BR8HS	4322	0,6	BR8HVX	6265	BR8HIX	7001
MJ TX 650	650	1992 -	BR8HS	4322	0,6	BR8HVX	6265	BR8HIX	7001
SJ 650 Super Jet	650	1990 - 1994	B8HS	5510	0,6	B8HVX	2634	BR8HIX	7001
WR 650	650	1990 - 1992	B8HS	5510	0,6	B8HVX	2634	BR8HIX	7001
WRA 650	650	1995 -	B8HS	5510	0,6	B8HVX	2634	BR8HIX	7001
WRA 650	650	1990 - 1993	BR8HS	4322	0,6	BR8HVX	6265	BR8HIX	7001
WRB 650	650	1991 - 1996	B8HS	5510	0,6	B8HVX	2634	BR8HIX	7001
FX1 FX 700	700	1995 - 1997	B8HS	5510	0,6	B8HVX	2634	BR8HIX	7001
MJ TL 700	700	1993 - 1996	BR8HS	4322	0,6	BR8HVX	6265	BR8HIX	7001
MJ TX 700	700	1993 - 1996	BR8HS	4322	0,6	BR8HVX	6265	BR8HIX	7001
RA 700	700	1994 -	BR8HS	4322	0,6	BR8HVX	6265	BR8HIX	7001
SJ 700 Super Jet	700	1998 -	BR7HS	4122	0,6			BR7HIX	7067





Order  
No.Quick  
No.**AL-KO**

KB 3501	BPMR7A	4626	0,5	309
KB 4001	BPMR7A	4626	0,5	309
KB 4501	BPMR7A	4626	0,5	309
KB 5000	BPMR7A	4626	0,5	309

**ALLEN**

HF 108	BMR6A	7421	0,6	307
HF 750	BM4A	5628	0,6	
HT 230 A	BM7A	6521	0,6	
STP 102	BMR6A	7421	0,6	307

**ALPINA**

A-35/ -40/E	BPM7A	7321	0,5	305
0-70 / S / -90	BPM7A	7321	0,5	305
Forest 120	BPM7A	7321	0,5	305
160Green / 180Jolly / 210Flex	BM7A	6521	0,5	
330 / 380 Mini	BPM7A	7321	0,5	305
432 / 438 MiniProf	BPM7A	7321	0,5	305
540 Isofloat	BPM7A	7321	0,5	305
MS 540i	BPMR7A	4626	0,7	309
MS 600i	BPMR7A	4626	0,7	309
MS P 34	BPMR7A	4626	0,7	309
MS P 400	BPMR7A	4626	0,7	309
MS P 450	BPMR7A	4626	0,7	309
Prof P34	BPM7A	7321	0,5	305
Prof 34	BPM7A	7321	0,5	305
Prof 41	BPM7A	7321	0,5	305
Prof 45	BPM7A	7321	0,5	305
Prof 55	BPM7A	7321	0,5	305
Prof 56	BPM7A	7321	0,5	305
Prof 65	BPM7A	7321	0,5	305
Prof 66	BPM7A	7321	0,5	305
Prof 70	BPM7A	7321	0,5	305
Prof 90	BPM7A	7321	0,5	305
Prof 120	BPM7A	7321	0,5	305
Prof 200	B6S	3510	0,5	302
Vip 20	BPMR7A	4626	0,5	309
Vip 24	BPMR7A	4626	0,5	309
Vip 32	BPMR7A	4626	0,5	309

**BLITZ**

B 34 / 35 / 38	BPMR7A	4626	0,5	309
B 42 / 45	BPMR7A	4626	0,5	309
B 50 / 52 / 54 / 55	BPMR7A	4626	0,5	309
B 60	BPMR7A	4626	0,5	309
B 80	BPMR7A	4626	0,5	309
B 100	BPMR7A	4626	0,5	309
B 300 / 304	BPMR7A	4626	0,5	309
B 400 / 404	BPMR7A	4626	0,5	309
B 500 / 502 / 504	BPMR7A	4626	0,5	309
B 600	BPMR7A	4626	0,5	309
B 701 / 702	BPMR7A	4626	0,5	309

Order  
No.Quick  
No.

<b>BLITZ</b>				
B 800 / 802 / 804	BPMR7A	4626	0,5	309
<b>BOLENS</b>				
3300 / 5500 / 5600 / 5700	B4L	3112	0,7	
Swifty 3014	B6S	3510	0,5	302
Thrifty 3010	B6S	3510	0,5	302
<b>CLINTON</b>				
D 15	BMR6A	7421	0,6	307
D 25	BMR6A	7421	0,6	307
D 35	BR6S	3522	0,6	
D 55	BR6S	3522	0,6	
D 65	BR6S	3522	0,6	
E 10	BM7A	6521	0,6	
E 75	BMR6A	7421	0,6	307
E 95	BMR6A	7421	0,6	307
<b>DANARM</b>				
110 / 125	BR6S	3522	0,6	
1-36 / 1-36SS / 1-71 / 2-36-SS	BM7A	6521	0,6	
36AV / 55 / 55LH / RH / 76	BM7A	6521	0,6	
<b>DERBI</b>				
3230	BMR6A	7421	0,6	307
3835	BM7A	6521	0,5	
5240	BMR6A	7421	0,6	307
6240	BM7A	6521	0,5	
<b>DOLMAR</b>				
100	BPMR6F	1270	0,5	
100s	BPMR6F	1270	0,5	
101	BMR6A	7421	0,5	307
102	BPMR6F	1270	0,5	
103	BMR6A	7421	0,5	307
104	BMR6A	7421	0,5	307
105	BMR6A	7421	0,5	307
106	BMR6A	7421	0,5	307
108	BMR6A	7421	0,5	307
109	BPMR7A	4626	0,5	309
110 (7.86-)	BPMR7A	4626	0,5	309
110 (-6.86)	BMR6F	2144	0,5	
110i	BPMR7A	4626	0,5	309
111	BPMR7A	4626	0,5	309
112 / Super	BPMR7A	4626	0,5	309
113 / Super	BPMR7A	4626	0,5	309
114	BPMR7A	4626	0,5	309
115	BPMR7A	4626	0,5	309
115 i	BPMR7A	4626	0,5	309
116 Si	BPMR7A	4626	0,5	309
117	BPMR7A	4626	0,5	309
118	BM7A	6521	0,5	
118 S	BPM7A	7321	0,5	305

Order  
No.Quick  
No.**DOLMAR**

119	BPM7A	7321	0,5	305
120 / Si	BPMR7A	4626	0,5	309
120 s 02.87-	BPMR7A	4626	0,5	309
121	BPMR7A	4626	0,5	309
122 / S / SL	BM7A	6521	0,5	
123	BPMR7A	4626	0,5	309
128 KMS4	BM7A	6521	0,5	
133	BPMR7A	4626	0,5	309
133 s	BPMR7A	4626	0,5	309
143	BPMR7A	4626	0,5	309
144	BM7A	6521	0,5	
152	BM6A	5921	0,5	303
153	BPMR7A	4626	0,5	309
160 / 166	BPMR7A	4626	0,5	309
308	BPMR7A	4626	0,5	309
309	BPMR7A	4626	0,5	309
310	BPMR7A	4626	0,5	309
343	BPMR7A	4626	0,5	309
PS-33	BPMR6F	1270	0,5	
PS-330	BPMR6F	1270	0,5	
PS-3300 TH	BMR6A	7421	0,5	307
PS-34	BPMR7A	4626	0,5	309
PS-340	BPMR6F	1270	0,5	
PS-341	BPMR6F	1270	0,5	
PS-344	BPMR6F	1270	0,5	
PS-400	BPMR6F	1270	0,5	
PS-401	BPMR6F	1270	0,5	
PS-410/33	BPMR6F	1270	0,5	
PS-411/33	BPMR6F	1270	0,5	
PS-6000i	BPMR7A	4626	0,5	309
PS-6000i H	BPMR7A	4626	0,5	309
PS-6400	BPMR7A	4626	0,5	309
PS-6800i	BPMR7A	4626	0,5	309
PS-6800i H	BPMR7A	4626	0,5	309
PS-7300	BPMR7A	4626	0,5	309
PS-7900	BPMR7A	4626	0,5	309
PS-9000	BPMR7A	4626	0,5	309
PS-9010	BPMR7A	4626	0,5	309
S6000	BPMR7A	4626	0,5	309

**ECHO**

CLS-4610	BPM7A	7321	0,6	305
CS-30EVL	BMR6A	7421	0,6	307
CS-60S	BMR6A	7421	0,6	307
CS-280EG / EVL	BMR6A	7421	0,6	307
CS-285EVL	BMR6A	7421	0,6	307
CS-290EVL	BMR6A	7421	0,6	307
CS-300EVL	BPMR6Y	5256	0,6	
CS-320EVL	BMR6A	7421	0,6	307
CS-330EVL	BMR6A	7421	0,6	307
CS-332	BPMR7A	4626	0,6	309
CS-351VL	BMR6A	7421	0,6	307

Order  
No.Quick  
No.**ECHO**

CS-400EVL	BPM6A	7021	0,6	304
CS-440EVL	BPMR7A	4626	0,6	309
CS-451VL	BMR6A	7421	0,6	307
CS-452VL	BMR6A	7421	0,6	307
CS-500VL / EVL	BPMR6A	6726	0,6	308
CS-510EVL	BPMR7A	4626	0,6	309
CS-600	BMR6A	7421	0,6	307
CS-601/ S / SVL / EVL	BMR6A	7421	0,6	307
CS-602VL	BPMR7A	4626	0,6	309
CS-650EVL	BPMR7A	4626	0,6	309
CS-660EVL	BPMR7A	4626	0,6	309
CS-701 / VL / SVL	BMR6A	7421	0,6	307
CS-702VL / EVL	BPMR7A	4626	0,6	309
CS-750VL / EVL	BPMR7A	4626	0,6	309
CS-900EVL	BPMR7A	4626	0,6	309
CS-1001VL	BMR6A	7421	0,6	307
CS-3000	BPM7A	7321	0,6	305
CS-3400	BPM7A	7321	0,6	305
CS-3600	BPM7A	7321	0,6	305
CS-3900	BPM6A	7021	0,6	304
CS-4000	BPM7A	7321	0,6	305
CS-4400	BPM7A	7321	0,6	305
CS-4500	BPM7A	7321	0,6	305
CS-4600	BPM7A	7321	0,6	305
CS-4601	BPM7A	7321	0,6	305
CS-5500	BPM7A	7321	0,6	305
CS-5501	BPM7A	7321	0,6	305
CS-6700	BPMR7A	4626	0,6	309
CS-6701	BPM7A	7321	0,6	305
CS-8000	BPM7A	7321	0,6	305
CSO-1200	BPMR7A	4626	0,6	309
CST-600EVL	BPMR7A	4626	0,6	309
HC-160 /-210 /-1000 /-1500	BM6A	5921	0,6	303

**EFCO**

131	BPMR7A	4626	0,6	309
134	BPMR7A	4626	0,6	309
135	BPMR7A	4626	0,6	309
136	BPMR7A	4626	0,6	309
138	BPMR7A	4626	0,6	309
140	BPMR7A	4626	0,6	309
140s	BPMR7A	4626	0,6	309
141	BPMR7A	4626	0,6	309
142	BPMR7A	4626	0,6	309
146	BPMR7A	4626	0,6	309
151	BPMR7A	4626	0,6	309
156	BPMR7A	4626	0,6	309
162	BPMR7A	4626	0,6	309
170	BPMR7A	4626	0,6	309
180	BPMR7A	4626	0,6	309
199	BPMR7A	4626	0,6	309

Order  
No.Quick  
No.**HERKULES**

ECV 3801	BPM7A	7321	0,5	305
----------	-------	------	-----	-----

**HOMELITE**

66 / 80 / C72	B6S	3510	0,6	302
135	BM7A	6521	0,6	
150 / 190 / 330	BM6F	6221	0,6	
200	BPM6F	5950	0,6	
240	BMR6F	2144	0,6	
240 SL / 330SL	BPM6F	5950	0,6	
245 HG / SL	BMR6F	2144	0,6	
290	BPMR7A	4626	0,6	309
300	BPM7A	7321	0,6	305
340	BPMR7A	4626	0,6	309
350 / 360 / 360SL	BM7F	6421	0,6	
410	BMR6F	2144	0,6	
410 SL	BPM6F	5950	0,6	
450	BM7F	6421	0,6	
540	BMR6F	2144	0,6	
550 SL / 550	BM7F	6421	0,6	
650 / 750 / 750W	BM7A	6521	0,6	
1000	BMR7A	4226	0,6	
1050 / 1130G / 2100G	BM7A	6521	0,6	
205	BPMR7A	4626	0,6	309
252	BPMR7A	4626	0,6	309
3100G	BM7A	6521	0,6	
8800	BPM7A	7321	0,6	305
DM 20 Multi-Purpose	BM7A	6521	0,6	
DM 40 Multi-Purpose	BPMR6F	1270	0,6	
DM 50 Multi-Purpose	BM7A	6521	0,6	
DM 54 Multi-Purpose	BPMR6F	1270	0,6	
i 3350 b	BPMR7A	4626	0,6	309
i 3850 b	BPMR7A	4626	0,6	309
Super 1050	BPM7A	7321	0,6	305
Super 1130G /2100/EZ-A0	BM7F	6421	0,6	
Super 2	BM6F	6221	0,6	
Super Wiz55 / 66 / 80	B6S	3510	0,6	302
Super XL 925	BPM7A	7321	0,6	305
Super XL-A0	BM7A	6521	0,6	
SXL-922SL	BMR7A	4226	0,6	
SXL-A0	BMR7A	4226	0,6	
SXL-MiniA0	BM7F	6421	0,6	
V1-130SL	BR6S	3522	0,6	
V1-944 / 955	BM7A	6521	0,6	
V1-Super2 / 2SL	BM6F	6221	0,6	
XL Mini / Auto	BM7F	6421	0,6	
XL	BPMR6F	1270	0,6	
XL 1A0	BM7F	6421	0,6	
XL 2	BM6F	6221	0,6	
XL 12	BM6A	5921	0,6	303
XL 76	BR6S	3522	0,6	
XL 98 A Multi-Purpose	BM7A	6521	0,6	
XL 100A	BM6A	5921	0,6	303

Order  
No.Quick  
No.**HOMELITE**

XL 123	BM7A	6521	0,6	
XL 600F	BM6A	5921	0,6	303
XL 923, -A	BM6A	5921	0,6	303
XLBC 4	BM7A	6521	0,6	

**HUSQVARNA**

1R	BPM7A	7321	0,5	305
33	BPMR6A	6726	0,5	308
36	BPMR7A	4626	0,5	309
36R	BPM7A	7321	0,5	305
40	BPMR7A	4626	0,5	309
45 / 42D / Spezial	BPMR6A	6726	0,5	308
40P / 44 / 44P	BPM6A	7021	0,5	304
41	BPMR7A	4626	0,5	309
42	BPMR7A	4626	0,5	309
45	BPMR7A	4626	0,5	309
51	BPMR7A	4626	0,5	309
55D / 66	BPMR6A	6726	0,5	308
55	BPMR7A	4626	0,5	309
61	BPMR7A	4626	0,5	309
61D / 61P	BPM7A	7321	0,5	305
65 / 65K	BM7A	6521	0,5	
77SS	BM7A	6521	0,5	
140	BPM6A	7021	0,5	304
140R / 140S	BM7A	6521	0,5	
160S / 162E / FE / FG / SE / SG	BM7A	6521	0,5	
162S	BPM6A	7021	0,5	304
163CD / 163CS / 165R	BM7A	6521	0,5	
181 / CD / SE / SG	BM6F	6221	0,5	
185CD	BM6F	6221	0,5	
234SE / SG	BM7A	6521	0,5	
238SE / SG	BPMR6A	6726	0,5	308
240S / SE / SG	BM7A	6521	0,5	
242XP / 242XPG	BPMR7A	4626	0,5	309
244R	BM7A	6521	0,5	
254XP / 254XPG / 257D	BPMR7A	4626	0,5	309
257	BPMR7A	4626	0,5	309
260CD	BM7A	6521	0,5	
262XP / 262XPG	BPMR7A	4626	0,5	309
263CD	BM7A	6521	0,5	
266FE / FG / SE / SG	BPM7A	7321	0,5	305
266XP / 268 / 268K	BPMR7A	4626	0,5	309
272XP / 272XPG / 272K	BPMR7A	4626	0,5	309
280CD / S / G	BM7A	6521	0,5	
281XP / 288XP / 288XPG	BPMR7A	4626	0,5	309
285CD	BM7A	6521	0,5	
340SE / SG / 344FE / FG	BM7A	6521	0,5	
380CD / K / S	BPM6A	7021	0,5	304
394XP	BPMR7A	4626	0,5	309
444FE / FG / SE / SG	BM7A	6521	0,5	
480CD / K	BM7A	6521	0,5	
1100CD / 2100CD / -W	BM6F	6221	0,5	

Order  
No.Quick  
No.**HUSQVARNA**

133SE / 133SG	BM7A	6521	0,5	
154SE / 154SG	BM7A	6521	0,5	
180S	BM7A	6521	0,5	
3120XP	BPMR7A	4626	0,5	309
334	BPMR7A	4626	0,5	309
338	BPMR7A	4626	0,5	309
339	BPMR7A	4626	0,5	309
346	BPMR7A	4626	0,5	309
353	BPMR7A	4626	0,5	309
357	BPMR7A	4626	0,5	309
385	BPMR7A	4626	0,5	309
390	BPMR7A	4626	0,5	309
395	BPMR7A	4626	0,5	309
455	BPMR7A	4626	0,5	309
575	BPMR7A	4626	0,5	309
A100	BM7A	6521	0,5	
A65 / B65	BM7A	6521	0,5	
A70	BM7A	6521	0,5	
A77 / B77	BM7A	6521	0,5	
F65 / G65 / K65 / L65 / R65	BPM6A	7021	0,5	304
F70	BM6A	5921	0,5	303
Husky 32	BPM7A	7321	0,5	305
Husky 34 / 34D	BM6F	6221	0,5	
Husky 35 / 35VR	BPM7A	7321	0,5	305
Husky 38 / 38VR	BPM7A	7321	0,5	305
L77	BPM6A	7021	0,5	304
PS50 Astsäge	BPMR6A	6726	0,5	308
Rancher 40 / 50 / 61	BPMR6A	6726	0,5	308

**JOHN DEERE**

12, 14, 15, 17, 18, 19	BM7A	6521	0,6	
200CS, 230CS	BPM7A	7321	0,6	305
23	BM7A	6521	0,6	
25EV / 28 / 30 / 35EV / 40V	BM6A	5921	0,6	303
28	BM6A	5921	0,6	303
30	BM6A	5921	0,6	303
300CS	BPM6A	7021	0,6	304
350CS	BM7A	6521	0,6	
35EV	BM6A	5921	0,6	303
40V	BM6A	5921	0,6	303
450V	BPM6A	7021	0,6	304
46EV / 51SV / 55SV / 60V	BPM7A	7321	0,7	305
50	BM6A	5921	0,6	303
50V	BM6A	5921	0,6	303
51SV, 55EV	BPM6A	7021	0,6	304
550CS	BPM7A	7321	0,6	305
55V	BPM6A	7021	0,6	304
60V	BPM6A	7021	0,6	304
61 / 81 / 91	BM7A	6521	0,6	
65EV	BPM6A	7021	0,6	304
65SV / 66SV / 70V / 80EV	BPM7A	7321	0,7	305
70V	BPM6A	7021	0,6	304

Order  
No.Quick  
No.**JOHN DEERE**

72	BPM6A	7021	0,6	304
8/ 9/ 12/ 14/ 15/ 17/ 18/19/23	BM7A	6521	0,6	
800V	BPM6A	7021	0,6	304
80EV	BPM6A	7021	0,6	304
80V / 450V / 800V	BPM7A	7321	0,7	305
81	BM7A	6521	0,6	
82	BM7A	6521	0,6	
820, 840	BPM7A	7321	0,6	305
91	BM7A	6521	0,6	
R70EV	BPM6A	7021	0,6	304
S80, S82	BPM6A	7021	0,6	304

**JONSERED**

45E	BPM7A	7321	0,5	305
49SP	BPMR6A	6726	0,5	308
52E / 62 / 66E / 70E / 80 /90	BPM6F	5950	0,5	
62	BPM6F	5950	0,5	
361/AV	BM7A	6521	0,5	
365 / 370 / 380	BPMR6A	6726	0,5	308
410 / 425	BPM7F	1268	0,5	
435 / 450	BPMR6A	6726	0,5	308
451 E / EV / 452	BPM6F	5950	0,5	
455	BPMR6A	6726	0,5	308
490	BPM6F	5950	0,5	
510 SP	BPM6A	7021	0,5	304
520 SP	BPM6F	5950	0,5	
521 / 525 / 535 / 590	BPMR6A	6726	0,5	308
621	BPM6F	5950	0,5	
625 / 630 / 670 / - Super	BPMR7A	4626	0,5	309
801	BPM6F	5950	0,5	
820 / 830	BPMR6A	6726	0,5	308
910 E	BPM6A	7021	0,5	304
920	BPM6F	5950	0,5	
930 Super	BPMR6A	6726	0,5	308
2036 Turbo / 2040 Turbo / 2045	BPMR7A	4626	0,5	309
2041	BPMR7A	4626	0,5	309
2050	BPMR7A	4626	0,5	309
2051 Turbo / 2054 Turbo / 2050	BPMR7A	4626	0,5	309
2055 Turbo	BPMR7A	4626	0,5	309
2077 Turbo / 2095 Turbo	BPMR7A	4626	0,6	309
2083 Turbo	BPMR7A	4626	0,5	309
RS40 / 45 / 51	BPMR6A	6726	0,5	308
RS52E	BPM7A	7321	0,5	305

**LANDONI**

L40	BM6A	5921	0,6	303
L48 / E	BPM6A	7021	0,6	304
L75	BM6F	6221	0,6	
L90	B8HS	5510	0,6	
L98	B7HS	5110	0,6	
L110	B7HS	5110	0,6	
L771 E / S / L772L / S	BPM6A	7021	0,6	304



Order  
No.Quick  
No.**LANDONI**

L773	BM6F	6221	0,6	
LF30 CL / LF36S	BPM6A	7021	0,6	304

**LOMBARD**

3 / 3A / 3-1/2	BM6A	5921	0,6	303
30 / 34 / 35 / 36 / 37	BM6A	5921	0,6	303
4	B7S	3710	0,6	
5,5A	BM6A	5921	0,6	303
648 / 650 / 658	B6S	3510	0,6	302
660	BM6A	5921	0,6	303
68 / 69 / 70	BM6A	5921	0,6	303
7	B7S	3710	0,6	
AL42	BM7A	6521	0,6	
AP22 / AP22-1/ AP22D / AP22D1	BPM7A	7321	0,6	305
AP24 / AP24D	BPM7A	7321	0,6	305
AP42/ AP42-1/ AP42D/ AP42D-AV	BPM7A	7321	0,6	305
AP42SE	BPM7A	7321	0,6	305
Comango	BM7A	6521	0,6	
F54	BM6A	5921	0,6	303
L30 / L50 / L55 / L70	BM6A	5921	0,6	303
L80 / L90 / L100	BM6A	5921	0,6	303
Little Lighting / Deluxe	BPM7A	7321	0,6	305
Pony	BM6F	6221	0,6	
Super AL42 / AL51	BM7A	6521	0,6	
Super AV	BPM7A	7321	0,6	305
Super Comango	BM7A	6521	0,6	
Super L100	BP5S	3011	0,6	
Super L30750/60/70/90	BM6A	5921	0,6	303
Super Lighting	BM7A	6521	0,6	

**MAKITA**

DCS330S Dolmar engine 33cc	BPMR6F	1270	0,5	
DCS340 Dolmar engine 33cc	BPMR6F	1270	0,5	
DCS341 Dolmar engine 33cc	BPMR6F	1270	0,5	
DCS390 Dolmar engine 39cc	BPMR6F	1270	0,5	
DCS400 Dolmar engine 39cc	BPMR6F	1270	0,5	
DCS401 Dolmar engine 39cc	BPMR6F	1270	0,5	
DCS430 Dolmar engine 43cc	BPMR7A	4626	0,5	309
DCS431 Dolmar engine 43cc	BPMR7A	4626	0,5	309
DCS5200i Dolmar engine 52cc	BPMR7A	4626	0,5	309
DCS520i Dolmar engine 52cc	BPMR7A	4626	0,5	309
DCS6800i Dolmar engine 68cc	BPMR7A	4626	0,5	309
DCS9000 Dolmar engine 90cc	BPMR7A	4626	0,5	309
DPC7000 Dolmar engine 70cc	BPMR7A	4626	0,5	309
DPC7001 Dolmar engine 70cc	BPMR7A	4626	0,5	309
DPC9500 Dolmar engine 95cc	BPMR7A	4626	0,5	309
DPC9501 Dolmar engine 95cc	BPMR7A	4626	0,5	309

**McCULLOCH**

1,9	BPM7A	7321	0,6	305
1-10	BM6F	6221	0,6	
2,3	BPM7A	7321	0,6	305

Order  
No.Quick  
No.**McCULLOCH**

2-10 / A / G	BM6F	6221	0,6	
3-10 / E	BM6F	6221	0,6	
4-10	BM7F	6421	0,6	
5-10 / A / E / G	BM7F	6421	0,6	
6-10 / A	BM7F	6421	0,6	
7-10 / A	BM7F	6421	0,6	
10-10 / A / L	BM6F	6221	0,6	
250	BM6F	6221	0,6	
550 / 640 / 650	BM6F	6221	0,6	
640 / 650	BM6F	6221	0,6	
660	B6S	3510	0,6	302
795 / L / 797	BM6F	6221	0,6	
836	BPMR6F	1270	0,5	
838	BPMR6F	1270	0,5	
895	BM6F	6221	0,6	
895C	BM7F	6421	0,6	
930	BMR6F	2144	0,6	
935	BMR6F	2144	0,6	
940	BMR6F	2144	0,6	
950	BMR6F	2144	0,6	
951	BPMR6F	1270	0,5	
955	BPMR6F	1270	0,5	
960	BMR6F	2144	0,6	
961	BPMR6F	1270	0,5	
970	BMR6F	2144	0,5	
California	BMR6F	2144	0,5	
California 90	BMR6F	2144	0,6	
CP55	BM6F	6221	0,6	
CP70 / L	BM7F	6421	0,6	
CP125 / S	BM7F	6421	0,6	
G70	BM7F	6421	0,6	
LG6	BM7F	6421	0,6	
Mac Cat	BMR6F	2144	0,6	
Mac 1-10	BM6F	6221	0,6	
Mac 2-10 / 2-10A / 2-10G	BM6F	6221	0,6	
Mac 3-10 / 3-10E	BM6F	6221	0,6	
Mac 330 Cat	BMR6F	2144	0,6	
Mac 836	BPMR6F	1270	0,6	
Mac 838	BPMR6F	1270	0,6	
Mac 839 Cat	BPMR6F	1270	0,6	
Mac 110 / 120 / 130 / 140	BM6F	6221	0,6	
Mac LG6 / S-10A / SLG-6	BM7F	6421	0,6	
Might-Might	BM7A	6521	0,6	
Mini-Mac1 /1A / 6 / 6A /	BM6F	6221	0,6	
Mini-Mac 883	BPMR6F	1270	0,6	
Mini-Mac25	BM6F	6221	0,6	
Mini-Mac30 / 35 / 35AS /35CP	BM6F	6221	0,6	
Mini-Pro25 / 30 / 35	BM6F	6221	0,6	
P10-10A	BM6F	6221	0,6	
PM 364	BMR6F	2144	0,6	
PM 374	BMR6F	2144	0,6	
PM 474	BMR6F	2144	0,6	

Order  
No.Quick  
No.**McCULLOCH**

PM 484	BMR6F	2144	0,6	
PM 484 X	BMR6F	2144	0,5	
Pro-Mac 6 / 6A	BM6F	6221	0,6	
Pro-Mac 7	BMR6F	2144	0,5	
Pro-Mac 36	BMR6F	2144	0,5	
Pro-Mac 40	BMR6F	2144	0,5	
Pro-Mac 46	BMR6F	2144	0,5	
Pro-Mac 51	BPMR6F	1270	0,5	
Pro-Mac 55	BPMR6F	1270	0,5	
Pro-Mac 60	BM7F	6421	0,6	
Pro-Mac 105	BM7F	6421	0,6	
Pro-Mac 140	BM6F	6221	0,6	
Pro-Mac 310 / 320 / 330 / 340	BM6F	6221	0,6	
Pro-Mac 510	BM7F	6421	0,6	
Pro-Mac 555	BM6F	6221	0,6	
Pro-Mac 570	BM6F	6221	0,6	
Pro-Mac 610 / 650	BM7F	6421	0,6	
Pro-Mac 700	BM7F	6421	0,6	
Pro-Mac 800	BM6F	6221	0,6	
Pro-Mac 850	BM7F	6421	0,6	
Pro-Mac 1000 / 1010	BM6F	6221	0,6	
S 10-10 / A / E / L / LA	BM6F	6221	0,6	
S 2-10A	BM6F	6221	0,6	
S 250 / S550 / S797	BM6F	6221	0,6	
S 6-10A	BM7F	6421	0,6	
SLG 2	BM6F	6221	0,6	
SLG 6	BM7F	6421	0,6	
SP 40 / 55	BM6F	6221	0,6	
SP 60 / 70 / 80 / 81	BM7F	6421	0,6	
SP 105 / 125C	BM7F	6421	0,6	
SP 125	BM6F	6221	0,6	
Timber Bear 842	BPMR6F	1270	0,5	
Timber Bear 846	BPMR6F	1270	0,5	
Timber Bear 849	BPMR6F	1270	0,5	

**OLEO-MAC**

233 / 234	BPMR7A	4626	0,5	309
234 F	BPMR6A	6726	0,5	308
240 / 244 / 246 FDL	BPMR7A	4626	0,5	309
244 F	BPMR6A	6726	0,5	308
250 A / B / Super E1/	BPMR7A	4626	0,5	309
252 / 252 F/ 254 / 254 F	BPMR7A	4626	0,5	309
260 Auto / 261	BPMR7A	4626	0,5	309
264 F / 272F / 935DF	BPM7A	7321	0,5	305
271 / 272 / 272 F	BPMR7A	4626	0,5	309
280 / 281 / 284	BPMR7A	4626	0,5	309
335	BPMR7A	4626	0,5	309
340 / 340F	BPMR7A	4626	0,5	309
350 / 350 S / 355	BPMR7A	4626	0,5	309
350 AF	BPMR6A	6726	0,5	308
460 S / 460 AS	BPMR7A	4626	0,5	309
480 S / 480 AS	BPMR7A	4626	0,5	309

Order  
No.Quick  
No.**OLEO-MAC**

481	BPMR7A	4626	0,5	309
482 / 482 MP	BPMR7A	4626	0,5	309
930	BPMR7A	4626	0,5	309
935 / 935 DF	BPMR7A	4626	0,5	309
940	BPMR7A	4626	0,5	309
942	BPMR7A	4626	0,5	309
945 / 945 DF	BPMR7A	4626	0,5	309
945 AF	BPMR6A	6726	0,5	308
946	BPMR7A	4626	0,5	309
950 / 950 FS	BPMR7A	4626	0,5	309
950 AF	BPMR6A	6726	0,5	308
951	BPMR7A	4626	0,5	309
999 / 999 F	BPMR7A	4626	0,5	309
AM 150	BPMR7A	4626	0,5	309
AM 180	BPMR7A	4626	0,5	309
S 30	BPMR7A	4626	0,5	309
S 50	BPMR7A	4626	0,5	309
S 80	BPMR7A	4626	0,5	309
S 100	BPMR7A	4626	0,5	309
SA 18	BPMR7A	4626	0,5	309
SA 30	BPMR7A	4626	0,5	309
SA 45	BPMR7A	4626	0,5	309
SC 21	BPMR7A	4626	0,5	309
SC 23	BPMR7A	4626	0,5	309
SC 33	BPMR7A	4626	0,5	309
SC 55	BPMR7A	4626	0,5	309

**PARTNER**

330 / 340 /	BMR7A	4226	0,5	
345 / 365 / 365CCS / 395	BPMR7A	4626	0,5	309
350	BM6A	5921	0,5	303
360	BPMR7A	4626	0,5	309
400 / 410CCS / 460CCS	BPMR7A	4626	0,5	309
405 / 405CCS / 450 / 465 / 495	BPMR7A	4626	0,5	309
410	BPMR7A	4626	0,5	309
500 Formula / 510CCS	BPMR7A	4626	0,5	309
540 / 540PRO / 545 / 660PRO	BPMR7A	4626	0,5	309
550	BPMR7A	4626	0,5	309
650	BPMR7A	4626	0,5	309
933 / 944 / 946 / 947	BPM6F	5950	0,5	
1610 / 1611 / 1613	BPM6F	5950	0,5	
1612	BM6F	6221	0,5	
1614 / C , 1616 / C	BPM6F	5950	0,5	
1618	BM6F	6221	0,5	
1629 / 1630 / 1631	BR6S	3522	0,5	
1632 / C	BMR7A	4226	0,5	
1633 B	BM7A	6521	0,5	
1644 / 1645	BR6S	3522	0,5	
1646 / C 1647C / 1655 / B	BMR7A	4226	0,5	
1660 / 1661 / 1690	BR6S	3522	0,5	
1705 / 1712	BPM6F	5950	0,5	
2055 / B	BMR7A	4226	0,5	

Order  
No.Quick  
No.**PARTNER**

351 CCS	BPMR6A	6726	0,5	308
370 CCS	BPMR6A	6726	0,5	308
390 CCS	BPMR6A	6726	0,5	308
420 CCS	BPMR6A	6726	0,5	308
470 CCS	BPMR6A	6726	0,5	308
5000 / Plus	BPM7F	1268	0,5	
5500	BPMR7A	4626	0,5	309
7000	BMR6A	7421	0,5	307
7700 /7700PRO CCS	BPMR7A	4626	0,7	309
B17	BM7A	6521	0,5	
B172 / B173	BM7A	6521	0,5	
B400	BM6A	5921	0,5	303
C-6	BM7A	6521	0,5	
F55 / A	BM7A	6521	0,5	
F65	BM7A	6521	0,5	
K12	BP6HS	4511	0,5	
K12S	BPM7A	7321	0,5	305
K16 / K20 / K40	BM7A	6521	0,5	
K550 / K650 / K700 / K1200	BPMR7A	4626	0,5	309
Mini P / 2	BM7A	6521	0,5	
Mini P3 / 4	BM6F	6221	0,5	
P48 / P49	BM7F	6421	0,5	
P50 / P51 / P65 / P85	BPMR7A	4626	0,5	309
P55 / P70	BMR7A	4226	0,5	
P100 / S	BPMR7A	4626	0,5	309
P500 / P5000	BPM6F	5950	0,5	
P7000	BM7A	6521	0,5	
R11	BM7A	6521	0,5	
R12	BP6HS	4511	0,5	
R14 / TS / R15 / R16 / R17 / T	BM7A	6521	0,5	
R18 / T / R19 / T / R20 / T	BM7A	6521	0,5	
R21 / T	BM6A	5921	0,5	303
R22 / T	BM7A	6521	0,5	
R30	BM6A	5921	0,5	303
R40 / T	BM7A	6521	0,5	
R400	BMR7A	4226	0,5	
R417 / T	BM7A	6521	0,5	
R420 / T / R421 / T / R440 / T	BM7A	6521	0,5	
R517 / T / R523	BM7A	6521	0,5	
R85	BM7A	6521	0,5	
S50 / S55 / S65	BM7A	6521	0,5	

**PIONEER**

550/ 600/ 610/ 620 / 650 / 700	B6S	3510	0,6	302
700G / 750 / 800 / 850	B6S	3510	0,6	302
970 / 1072/ 1073 / 2071 / 2073	BM7A	6521	0,6	
1014 / 1074E / 1074UB	BM6A	5921	0,7	303
1074	BM6A	5921	0,6	303
1100	BM6A	5921	0,6	303
1100 / 1110 / 1120 / 1130	BM6A	5921	0,6	303
1150 / 1160 / 1200 / 1200A	BM6A	5921	0,6	303
1410 / 1410A / 1420 / 1450	BM6A	5921	0,6	303



Order No.  Quick No.

### PIONEER

1520 / 1560/ 1750/ 1770/ 1771	BM7A	6521	0,6	
1850 / 2071 / 2073	BM7A	6521	0,6	
2200/ 2270/ 2400 / 2460	BM6A	5921	0,6	303
3071 / 3200 / 3270 / 3270S	BM6A	5921	0,6	303
F / G / M	B4	3210	0,6	
Farmlite	BPMR7A	4626	0,7	309
Farmsasw 2	BMR6A	7421	0,7	307
HA / HB / One Man / Twin Super	B6S	3510	0,6	302
HC/ RA/ NU-17/ 400 / 410 / 450	B6S	3510	0,6	302
P10	BM7A	6521	0,6	
P11	BPM7A	7321	0,7	305
P20/ P25/ P26S	BM7A	6521	0,6	
P21 / P21S	BM6A	5921	0,6	303
P21B / P21SB / P28E	BM6A	5921	0,7	303
P26	BMR6A	7421	0,6	307
P28 / P28S	BMR6A	7421	0,6	307
P28B / P28SB	BMR6A	7421	0,7	307
P30 / P30S	BMR7A	4226	0,7	
P35 / P35S	BMR6A	7421	0,6	307
P38	BPMR7A	4626	0,7	309
P40 / P50	BM7A	6521	0,6	
P40 Light Service	BM6A	5921	0,6	303
P41 / P41S	BR6S	3522	0,6	
P42 / P42W	BPMR7A	4626	0,7	309
P50	BM7A	6521	0,6	
P51 / P51S	BM7A	6521	0,6	
P52 / P52W	BPMR7A	4626	0,7	309
P55 / P55S	BMR7A	4226	0,6	
P60	BPMR7A	4626	0,6	309
P62 / P62W	BPMR7A	4626	0,7	309
Super Twin	B6S	3510	0,6	302

### POULAN

1800 / 2000 / 2300	BM6A	5921	0,6	303
20 / 20D / 25 / 25DA	BM6A	5921	0,6	303
245A / 252A	BM6A	5921	0,6	303
3400	BPM6A	7021	0,6	304
36 / 306A / 306SA / 361	BM6A	5921	0,6	303
3700	BPM7A	7321	0,6	305
4000	BPM6A	7021	0,6	304
4200	BM7A	6521	0,6	
4200CVA	BPMR7A	4626	0,5	309
4400 / 4900 / 5200CVA	BM6A	5921	0,6	303
5200 / 5400 / 5500 / 6000	BM7A	6521	0,6	
53A / 54	B6S	3510	0,6	302
6000CVA	BPMR7A	4626	0,5	309
6900 / 7700 / 8500	BM7A	6521	0,6	
71A / 72 / 76 / 92 / 100	BM6A	5921	0,6	303
B520	BM4A	5628	0,6	
Log Splitter 19-7 / 26-TM	BM6A	5921	0,6	303
Log Splitter 26-10 / 26-10R	BM6A	5921	0,6	303
Log Splitter P-24-8AR/P-26-15A	BM6A	5921	0,6	303

Order  
No.Quick  
No.**POULAN**

Micro 25 / 25 Deluxe	BM6A	5921	0,6	303
Micro 25CVA / 25SN/MZ5	BM6A	5921	0,6	303
MicroSuper25/CAV/Deluxe	BM6A	5921	0,6	303
Multipurpose 25-14-12/45-12	BM7A	6521	0,6	
S25CVA / S25DA	BM6A	5921	0,6	303
S33	B6S	3510	0,6	302
S6000/Super 6000CVA	BPMR7A	4626	0,5	309
S68 / S72	BM6A	5921	0,6	303
Super XXV	BM6A	5921	0,6	303

**REMINGTON**

812/814/816/816AV	BPM6A	7021	0,6	304
840AV/850AV/860AV	BPM6A	7021	0,6	304
Jobmaster	BPM6A	7021	0,6	304
Logger	BM7A	6521	0,6	
Mighty-Mite	BM7A	6521	0,6	
Mighty-Mite 100 / 200 / 300	BPM6A	7021	0,6	304
Mighty-Mite 400 / 500 / 600	BPM6A	7021	0,6	304
Mighty-Mite Bantam / Deluxe	BM7A	6521	0,6	
Mighty-Mite Weekender	BM7A	6521	0,6	
Outdoorsman	BM7A	6521	0,6	
Outdoorsman II	BPM6A	7021	0,6	304
P5A/PL4/PL5/PL6/PL6A	BM7A	6521	0,6	
PL7/PL7A/PL55/PL55A	BM7A	6521	0,6	
Pow-R-Cut	BM7A	6521	0,6	
Rancher	BM7A	6521	0,6	
SL11 / SL11A	BM7A	6521	0,6	
SL14 / SL16 / SL55	BM7A	6521	0,6	
SL4/SL4A/SL7/SL9/SL9A	BM7A	6521	0,6	
SL9 Deluxe /SL10 / SL10A	BM7A	6521	0,6	
Sportsmann	BM7A	6521	0,6	
Sportsmann II	BPM6A	7021	0,6	304
Super 754	B6S	3510	0,6	302
Woodsmann	BM7A	6521	0,6	
Yardmaster	BPM6A	7021	0,6	304

**RYOBI**

GTS 28 /32 / 38	BPM7A	7321	0,6	305
GTS 56 /62	BPM7A	7321	0,6	305
RGS 3214 / 3214A	BPM7A	7321	0,6	305
RGS 3816 /4518 / 5418	BPM7A	7321	0,6	305

**SHINDAIWA**

440	BPMR6A	6726	0,6	308
488	BPMR6A	6726	0,6	308
450 / 451	BPMR6A	6726	0,6	308
460	BPMR6A	6726	0,6	308
300 /S / 345 / 350 / 360 / 377	BPMR6A	6726	0,6	308
400 / 410 / 415 / 416	BPMR6A	6726	0,6	308
420	BPMR6A	6726	0,6	308
500 / 510 / 575 / 577	BPMR6A	6726	0,6	308
580 (-87)	BPMR6A	6726	0,7	308

Order  
No.Quick  
No.**SHINDAIWA**

580 (88)	BPMR7A	4626	0,7	309
680	BPMR6A	6726	0,7	308
685 (-87)	BPMR6A	6726	0,7	308
685 (88)	BPMR7A	4626	0,7	309
695	BPMR6A	6726	0,6	308
757	BPMR6A	6726	0,6	308
CYB350	BPMR6A	6726	0,6	308
DBY354	BMR6A	7421	0,6	307
DBY453	BMR6A	7421	0,6	307
DYB190 / DYB191	BMR6A	7421	0,6	307
DYB200 / DYB201 / DYB202	BMR6A	7421	0,6	307
DYB251 / DYB252 / DYB253	BMR6A	7421	0,6	307
DYB254 / DYB345 / DYB351	BMR6A	7421	0,6	307
E300 / E345 / E350 / E406	BPMR6A	6726	0,7	308
E440 / E480	BPMR6A	6726	0,7	308
E580 (-87)	BPMR6A	6726	0,7	308
E580 (88)	BPMR7A	4626	0,7	309
E680 (-87)	BPMR6A	6726	0,7	308
E680 (88)	BPMR7A	4626	0,7	309
E680EV	BPMR6A	6726	0,7	308
YB291 / YB301 / YB401 / YB501	BPMR6A	6726	0,6	308
YB601 / YB701 / YB901	BPMR6A	6726	0,6	308
YB801 (-87)	BPMR6A	6726	0,6	308
YB801 (88)	BPMR7A	4626	0,6	309

**SKIL**

255	BM6A	5921	0,6	303
1610 / 1611 / 1612 / 1613	BM6F	6221	0,6	
1614 / 1616	BM6F	6221	0,6	
1620	BM6A	5921	0,6	303
1622 / 1624	BM6A	5921	0,6	303
1629	BR6S	3522	0,6	
1630 / 1631	BR6S	3522	0,6	
1632	BMR7A	4226	0,6	
1634	BM6A	5921	0,6	303
1636	BM6A	5921	0,6	303
1644	BR6S	3522	0,6	
1645	BR6S	3522	0,6	
1646 / 1647	BMR7A	4226	0,6	
1660 / 1661	BR6S	3522	0,6	
1690	BR6S	3522	0,6	
1705 / 1712	BM6F	6221	0,6	

**SOLO**

600 Mini / 600B	BPM6A	7021	0,5	304
603	BPMR7A	4626	0,5	309
605 (-84)	BPM6A	7021	0,5	304
605AV / 606AV / 616AV / 655AV	BPM6A	7021	0,5	304
606 (-84)	BPM6A	7021	0,5	304
610VA (-84)	BPM6A	7021	0,5	304
611	BPMR7A	4626	0,5	309
615VA (-80)	BPM6A	7021	0,5	304



Order  
No.Quick  
No.**SOLO**

616 (-80)	BPM6A	7021	0,5	304
620VA (-81)	BPM6A	7021	0,5	304
630	BPMR7A	4626	0,6	309
630 / 632	BM7A	6521	0,5	
633	BPMR7A	4626	0,6	309
634 / 638 / 639	BPMR7A	4626	0,5	309
635	BPMR7A	4626	0,6	309
636	BPMR7A	4626	0,6	309
640	BPMR7A	4626	0,6	309
640 / C	BPM6A	7021	0,5	304
641 / 642	BPMR7A	4626	0,5	309
642 (-78)	BM6A	5921	0,5	303
644 / 644SP / 644 VA	BPMR7A	4626	0,5	309
645 / 647	BPMR7A	4626	0,5	309
650VA (-84)	BPM6A	7021	0,5	304
651 / 651SP / 654	BPMR7A	4626	0,5	309
655AV (-84)	BPM6A	7021	0,5	304
660AV (-83)	BPM6A	7021	0,5	304
662 / 667 / 670 / 673 / 675	BPMR7A	4626	0,5	309
680 / 690	BPMR7A	4626	0,5	309
694	BPMR7A	4626	0,6	309
Twin 100	BM7A	6521	0,5	

**STIHL**

06 / 07 / 07S / 08	BP6HS	4511	0,5	
08S	B6HS	4510	0,5	
009/AV,010/AV,011/AV,015/AV	BPMR7A	4626	0,5	309
017	BPMR7A	4626	0,5	309
018 C	BPMR7A	4626	0,5	309
019 T	BPMR7A	4626	0,5	309
020 /024/026/028/030/031/032	BPMR7A	4626	0,5	309
020T / 024WB / 026C / 028S	BPMR7A	4626	0,5	309
021/023/C/025/029/039	BPMR7A	4626	0,5	309
023 L	BPMR7A	4626	0,5	309
025 C	BPMR7A	4626	0,5	309
034 /036/038/040/041/042/044	BPMR7A	4626	0,5	309
036 QS	BPMR7A	4626	0,5	309
044 C / 045 / 048 /050/051/056	BPMR7A	4626	0,5	309
046 / C	BPMR7A	4626	0,5	309
046 RHD	BPMR7A	4626	0,5	309
064/066/070/071/075/076/084	BPMR7A	4626	0,5	309
088	BPMR7A	4626	0,5	309
090AV / -N / -S	BPMR7A	4626	0,5	309
1106-CONTRA(G,GS),1601	BPMR6A	6726	0,5	308
BG60E	BMR6A	7421	0,5	307
HS60	BMR6A	7421	0,6	307
HS61	BPMR7A	4626	0,5	309
HS72	BPMR7A	4626	0,5	309
HS74	BPMR7A	4626	0,5	309
HS76	BPMR7A	4626	0,5	309
HS151 / HS202 / HS242	BPMR7A	4626	0,5	309
HS246	BPMR7A	4626	0,5	309

Order  
No.Quick  
No.**STIHL**

KS43	A6	1010	0,5	
MS 170	BPMR7A	4626	0,5	309
MS 180 / C / BE	BPMR7A	4626	0,5	309
MS 190 T	BPMR7A	4626	0,5	309
MS 192 T	BPMR7A	4626	0,5	309
MS 200	BPMR7A	4626	0,5	309
MS 200 T	BPMR7A	4626	0,5	309
MS 210	BPMR7A	4626	0,5	309
MS 210 C	BPMR7A	4626	0,5	309
MS 230 / C	BPMR7A	4626	0,5	309
MS 240	BPMR7A	4626	0,5	309
MS 250 / C	BPMR7A	4626	0,5	309
MS 260	BPMR7A	4626	0,5	309
MS 270	BPMR7A	4626	0,5	309
MS 270 / C	BPMR7A	4626	0,5	309
MS 280	BPMR7A	4626	0,5	309
MS 280 / C	BPMR7A	4626	0,5	309
MS 290	BPMR7A	4626	0,5	309
MS 310	BPMR7A	4626	0,5	309
MS 341	BPMR7A	4626	0,5	309
MS 361	BPMR7A	4626	0,5	309
MS 361 / C	BPMR7A	4626	0,5	309
MS 361 / W	BPMR7A	4626	0,5	309
MS 390	BPMR7A	4626	0,5	309
MS 440	BPMR7A	4626	0,5	309
MS 460	BPMR7A	4626	0,5	309
MS 650	BPMR7A	4626	0,5	309
MS 660	BPMR7A	4626	0,5	309
MS 880	BPMR7A	4626	0,5	309
S10	BPMR6A	6726	0,5	308
TS 200 / TS510	BPMR7A	4626	0,5	309
TS 350	BPR6HS	7022	0,5	
TS 350AVE / TS360AVE	BPMR6A	6726	0,5	308
TS 360S / TS760	BPMR6A	6726	0,5	308

**TANAKA**

ECS 290 / 300 / 307 / 350/ 351	BM6A	5921	0,6	303
ECS 320 / 330 93-	BM6A	5921	0,6	303
ECS 3301	BMR6A	7421	0,7	307
ECS 3351	BMR6A	7421	0,7	307
ECS 35 / 35B	BM6A	5921	0,6	303
ECS 3500 / 4000	BPM6A	7021	0,6	304
ECS 356 / 357	BM6A	5921	0,6	303
ECS 370	BM7A	6521	0,6	
ECS 3801	BPM7A	7321	0,7	305
ECS 405	BM7A	6521	0,6	
ECS 505	BM7A	6521	0,6	
ECS 506	BM7A	6521	0,6	
ECS 650	BM7A	6521	0,6	
ECV 3400 / 4501	BPMR7A	4626	0,5	309
EHC 120	BM7A	6521	0,6	
ESC 355	BMR6A	7421	0,5	307

Order  
No.Quick  
No.**TANAKA**

ESC 415	BPMR7A	4626	0,5	309
---------	--------	------	-----	-----

**TONDU**

30F	BPM7A	7321	0,6	305
-----	-------	------	-----	-----

35F	BPM7A	7321	0,6	305
-----	-------	------	-----	-----

42F	BPM7A	7321	0,6	305
-----	-------	------	-----	-----

**WRIGHT**

104 / 104D	BM6A	5921	0,6	303
------------	------	------	-----	-----

111 / 121 / 122A / 122CVA	BM6A	5921	0,6	303
---------------------------	------	------	-----	-----

136 / 137A / 140 / 141A	BM6A	5921	0,6	303
-------------------------	------	------	-----	-----

B316	BP4	2911	0,6	
------	-----	------	-----	--

C40 / C40D	B6S	3510	0,6	302
------------	-----	------	-----	-----

C50 / C50D / C50SG	B4	3210	0,6	
--------------------	----	------	-----	--

C70 / C70D / C70G	B6S	3510	0,6	302
-------------------	-----	------	-----	-----

GS2016	BP4	2911	0,6	
--------	-----	------	-----	--

GS218	B4	3210	0,6	
-------	----	------	-----	--

GS2520	B4	3210	0,6	
--------	----	------	-----	--

**XENOAH**

G320AV, G320AVS	BPM6A	7021	0,6	304
-----------------	-------	------	-----	-----

G36AV, G36AVS, G50AV	BPM6A	7021	0,6	304
----------------------	-------	------	-----	-----

G380AV, G380AVS	BPM6A	7021	0,6	304
-----------------	-------	------	-----	-----

G560AV, G560AVS	BPM6A	7021	0,6	304
-----------------	-------	------	-----	-----

G620AV, G620AVS	BPM6A	7021	0,6	304
-----------------	-------	------	-----	-----

**YANKEE CLIPPER**

1-36 MKI, 2-36-SS	BM7A	6521	0,6	
-------------------	------	------	-----	--

1-36 MKII	BM6F	6221	0,6	
-----------	------	------	-----	--

55LH, 55RH, 76, 1-71-SS	BM7A	6521	0,6	
-------------------------	------	------	-----	--



Order No.  Quick No.

<b>AGRIA</b>				
0300 , 1400		<b>B6HS</b>	<b>4510</b>	0,5 <b>203</b>
400 Quickly		<b>B4LM</b>	<b>3410</b>	0,6 <b>301</b>
Baby 2100 14mm		<b>B4H</b>	<b>4110</b>	0,5
Baby 2100 18mm		<b>A6</b>	<b>1010</b>	0,6
Baby 4000/S		<b>A6</b>	<b>1010</b>	0,5
Mot. B&S		<b>B4LM</b>	<b>3410</b>	0,5 <b>301</b>
Mot. F&S		<b>B7HS</b>	<b>5110</b>	0,5 <b>204</b>
Mot. ILO 14 mm 5.1977 -->		<b>B6HS</b>	<b>4510</b>	0,5 <b>203</b>
Mot. ILO 18 mm --> 4.1977		<b>A7</b>	<b>1110</b>	0,5
Mot. Lombardini		<b>B4H</b>	<b>4110</b>	0,5
Mot. MAG		<b>B4H</b>	<b>4110</b>	0,5
Mot. NSU		<b>B4H</b>	<b>4110</b>	0,5
Mot. Renault		<b>BP6HS</b>	<b>4511</b>	0,7
Record		<b>A6</b>	<b>1010</b>	0,6
<b>AL-KO</b>				
Aspera		<b>B4LM</b>	<b>3410</b>	0,5 <b>301</b>
B & S 10,5-13,5PS ohne OHV	Aufsitzmäher/Traktor-Motoren	<b>BR2LM</b>	<b>5798</b>	0,5 <b>310</b>
B & S 12,5-17PS OHV	Aufsitzmäher/Traktor-Motoren	<b>BKR5ES</b>	<b>2460</b>	0,7
B & S 12,5-20PS mit AVS 1&2Zyl	Aufsitzmäher/Traktor-Motoren	<b>BKR5ES</b>	<b>2460</b>	0,7
B&S 4Takt	Rasenmäher-Motoren	<b>BR4LM</b>	<b>4133</b>	0,5
Honda 4 Takt	Rasenmäher-Motoren	<b>BPR5ES</b>	<b>7422</b>	0,7
Tecumseh 4 Takt	Rasenmäher-Motoren	<b>BR6S</b>	<b>3522</b>	0,6
Tecumseh 11-13PS OHV	Aufsitzmäher/Traktor-Motoren	<b>BR7ES</b>	<b>5122</b>	0,7
<b>ALLEN</b>				
215 , 216 , 218 , 218ILO , 221 , 421		<b>BMR6A</b>	<b>7421</b>	0,7 <b>307</b>
Lawnranger , Parkranger		<b>BMR6A</b>	<b>7421</b>	0,7 <b>307</b>
Merlin , Merlin XL		<b>BMR6A</b>	<b>7421</b>	0,7 <b>307</b>
National 68 (B&S) , Greenfield 12		<b>BMR6A</b>	<b>7421</b>	0,7 <b>307</b>
National 68 (Kawasaki)		<b>BP4HS</b>	<b>3611</b>	0,7
National 84		<b>B6L</b>	<b>3212</b>	0,7
<b>ALPINA</b>				
Mot. Aspera		<b>B4LM</b>	<b>3410</b>	0,5 <b>301</b>
<b>AS MOTOR</b>				
21-165/2		<b>B6HS</b>	<b>4510</b>	0,5 <b>203</b>
21AH4		<b>B6HS</b>	<b>4510</b>	0,5 <b>203</b>
21AH6		<b>B6HS</b>	<b>4510</b>	0,5 <b>203</b>
21AH9		<b>B6HS</b>	<b>4510</b>	0,5 <b>203</b>
21H3		<b>B6HS</b>	<b>4510</b>	0,5 <b>203</b>
21H6		<b>B6HS</b>	<b>4510</b>	0,5 <b>203</b>
26AH4		<b>B6HS</b>	<b>4510</b>	0,5 <b>203</b>
26AH6		<b>B6HS</b>	<b>4510</b>	0,5 <b>203</b>
26AH8		<b>B6HS</b>	<b>4510</b>	0,5 <b>203</b>
26AH9		<b>B6HS</b>	<b>4510</b>	0,5 <b>203</b>
26H4		<b>B6HS</b>	<b>4510</b>	0,5 <b>203</b>
26H6		<b>B6HS</b>	<b>4510</b>	0,5 <b>203</b>
26H8		<b>B6HS</b>	<b>4510</b>	0,5 <b>203</b>
42B6		<b>B6HS</b>	<b>4510</b>	0,5 <b>203</b>
45B2/2		<b>B6HS</b>	<b>4510</b>	0,5 <b>203</b>

Order  
No.Quick  
No.**AS MOTOR**

45B3A	B6HS	4510	0,5	203
46B1	B6HS	4510	0,5	203
53B1	B6HS	4510	0,5	203
53B1R	B6HS	4510	0,5	203
53B3	B6HS	4510	0,5	203
53B8	B6HS	4510	0,5	203
AS 46 B 2	B6HS	4510	0,5	203
AS 45 B 4	B6HS	4510	0,5	203
AS 53 B 4	B6HS	4510	0,5	203
AS 53 B 5	B6HS	4510	0,5	203
AS 53 B 5R	B6HS	4510	0,5	203
AS 120 A	B6HS	4510	0,6	203
AS 120 C, D	B6HS	4510	0,6	203
AS 165 A	B6HS	4510	0,6	203
AS 165 E	B6HS	4510	0,6	203
AS 165 D,F,G	B6HS	4510	0,6	203

**ASPERA-TECNA**

AV 125	BR4LM	4133	0,6	
AV 520	BR4LM	4133	0,6	
AV 600	BR4LM	4133	0,6	
AV 750	BR4LM	4133	0,6	
BV 133	BR4LM	4133	0,6	
BV 150	BR4LM	4133	0,6	
BV 153	BR4LM	4133	0,6	
BV 172	BR4LM	4133	0,6	
BV 173	BR4LM	4133	0,6	
H7HS , HBL	BR4LM	4133	0,6	
H 30 , HB 30	BR4LM	4133	0,6	
H 35 , HB 35	BR4LM	4133	0,6	
HBP 40	BR4LM	4133	0,6	
HS , HLB 30	BR4LM	4133	0,6	
LAV 30	BR4LM	4133	0,6	
LAV 35	BR4LM	4133	0,6	
LAV 40	BR4LM	4133	0,6	
LAV 153	BR4LM	4133	0,6	
LAV 172	BR4LM	4133	0,6	
MV 100	BR4LM	4133	0,6	
MV 100 S	BR4LM	4133	0,6	

**ATCO**

B&S engine	BR2LM	5798	0,8	310
JAP engine 14mm	B5HS	4210	0,8	
Suffolk engine	B6S	3510	0,8	302
Tecumseh engine	B6S	3510	0,8	302
Villiers engine 14mm	B5HS	4210	0,8	
Villiers engine 18mm	A6	1010	0,8	

**B & S Motoren**

14 mm heads older models	BR2LM	5798	0,8	310
18.0 mm older models	A6	1010	0,7	
18.0 mm Heads older models	A6	1010	0,7	

Order  
No.Quick  
No.**B & S Motoren**

2.0 hp 60100 single cyl. "L" head	BR2LM	5798	0,7	310
2.0 hp 60000 serie	BR2LM	5798	0,7	310
2.5 hp 80100 serie	BR2LM	5798	0,7	310
3.0 hp 62000 2 cycle Engs. Single Cyl.	BR2LM	5798	0,7	310
3.0 hp 80000 serie single cyl. "L" head	BR2LM	5798	0,7	310
3.0 hp 90100 single cyl. "L" head	BR2LM	5798	0,7	310
3.0 hp 94500 single cyl. "L" head	BR2LM	5798	0,7	310
3.0 hp 90200 single cyl. "L" head	BR2LM	5798	0,7	310
3.0 hp 92500 single cyl. "L" head	BR2LM	5798	0,7	310
3.5 hp 96500 single cyl. "L" head	BR2LM	5798	0,7	310
3.5 hp 90700 single cyl. "L" head	BR2LM	5798	0,7	310
3.5 hp 94900 serie	BR2LM	5798	0,7	310
3.5 hp 93440 w/No Tank single cyl. "L" head	BR2LM	5798	0,7	310
3.5 hp 95900 single cyl. "L" head	BR2LM	5798	0,7	310
3.5 hp 93200 single cyl. "L" head	BR2LM	5798	0,7	310
3.5 hp 93400 w/Top single cyl. "L" head	BKR5ES	2460	0,7	
3.5 hp 91000 serie	BR2LM	5798	0,7	310
3.5 hp 91200 single cyl. "L" head	BR2LM	5798	0,7	310
3.5 hp 121000 single cyl. "L" head	BR2LM	5798	0,8	310
3.5 hp 128000 single cyl. "L" head	BR2LM	5798	0,8	310
3.5 hp 90000 serie	BR2LM	5798	0,7	310
3.5 hp 100000,100700 single cyl. "L" head	BR2LM	5798	0,8	310
3.5 hp 92900 single cyl. "L" head	BR2LM	5798	0,7	310
3.5 hp 92200 single cyl. "L" head	BR2LM	5798	0,7	310
3.5 hp 93900 single cyl. "L" head	BR2LM	5798	0,7	310
3.5 hp 91700 single cyl. "L" head	BR2LM	5798	0,7	310
3.5 hp 92000 serie	BR2LM	5798	0,7	310
3.75hp 96900 single cyl. "L" head	BR2LM	5798	0,7	310
3.75hp 98900 single cyl. "L" head	BR2LM	5798	0,7	310
3.8 hp 9D900 single cyl. "L" head	BR2LM	5798	0,7	310
3.8 hp 9C900 single cyl. "L" head	BR2LM	5798	0,7	310
4.0 hp 113000 single cyl. "L" head	BR2LM	5798	0,8	310
4.0 hp 12E000 single cyl. "L" head	BR2LM	5798	0,8	310
4.0 hp 854400 serie single cyl. OHV Vanguard	BCPR5ES	6130	0,7	
4.0 hp 123000 single cyl. "L" head	BR2LM	5798	0,8	310
4.0 hp 12T000 single cyl. "L" head	BR2LM	5798	0,8	310
4.0 hp 10A900 single cyl. "L" head	BR2LM	5798	0,8	310
4.0 hp 122000 single cyl. "L" head	BR2LM	5798	0,8	310
4.0 hp 114000 single cyl. "L" head	BR2LM	5798	0,8	310
4.0 hp 111000 single cyl. "L" head	BR2LM	5798	0,8	310
4.0 hp 95000 serie	BR2LM	5798	0,7	310
4.0 hp 96000 serie	BR2LM	5798	0,7	310
4.0 hp 100200,100202,100900,110700,110900 single cyl. "L" head	BR2LM	5798	0,8	310
4.0 hp 10B900 single cyl. "L" head	BR2LM	5798	0,8	310
4.0 hp 110000 single cyl. "L" head	BR2LM	5798	0,8	310
4.0 hp 112000 single cyl. "L" head	BR2LM	5798	0,8	310
4.5 hp 104000 (OHV)	BKR5ES	2460	0,8	
4.5 hp 12L000 single cyl. "L" head	BR2LM	5798	0,8	310
4.75 hp 12A000 single cyl. "L" head	BR2LM	5798	0,8	310
4.75 hp 12D000 single cyl. "L" head	BR2LM	5798	0,8	310
5.0 hp 130000 single cyl. "L" head	BR2LM	5798	0,8	310
5.0 hp 133400 single cyl. "L" head	BR2LM	5798	0,8	310

Order  
No.Quick  
No.**B & S Motoren**

5.0 hp 12G000 single cyl. "L" head	BR2LM	5798	0,8	310
5.0 hp 124700	BR2LM	5798	0,8	310
5.0 hp 104700 (OHV) Vanguard	BKR5ES	2460	0,8	
5.0 hp 124000 single cyl. "L" head	BR2LM	5798	0,8	310
5.0 hp 131000 single cyl. "L" head	BR2LM	5798	0,8	310
5.0 hp 133200 single cyl. "L" head	BR2LM	5798	0,8	310
5.0 hp 96700 serie 2 cycle Engs. Single Cyl.	BR2LM	5798	0,7	310
5.0 hp 132000 single cyl. "L" head	BR2LM	5798	0,8	310
5.0 hp OHV	BKR5ES	2460	0,8	
5.0 hp 125000 single cyl. "L" head	BR2LM	5798	0,8	310
5.0 hp 135200 single cyl. "L" head	BR2LM	5798	0,8	310
5.0 hp 136200 single cyl. "L" head	BR2LM	5798	0,8	310
5.0 hp 12U000 single cyl. "L" head	BR2LM	5798	0,8	310
5.0 hp 126000 single cyl. "L" head	BR2LM	5798	0,8	310
5.0 hp 95700 serie 2 cycle Engs. Single Cyl.	BR2LM	5798	0,7	310
5.0 hp 12F000 single cyl. "L" head	BR2LM	5798	0,8	310
5.25 hp 12B000 single cyl. "L" head	BR2LM	5798	0,8	310
5.25 hp 12C000 single cyl. "L" head	BR2LM	5798	0,8	310
5.5 hp 115400 single cyl.OHV Vanguard	BKR5ES	2460	0,7	
5.5 hp OHV	BKR5ES	2460	0,8	
5.5 hp 12M000 single cyl. "L" head	BR2LM	5798	0,8	310
5.5 hp 110400-111400-113400 single cyl.OHV Intek	BKR5ES	2460	0,7	
5.5 hp 129000 single cyl. "L" head	BR2LM	5798	0,8	310
5.5 hp 134400 single cyl. "L" head	BR2LM	5798	0,8	310
5.5 hp 137000 single cyl. "L" head	BR2LM	5798	0,8	310
6.0 hp 117400 single cyl.OHV Vanguard	BKR5ES	2460	0,7	
6.0 hp 99700 serie single cyl. OHV	BKR5ES	2460	0,7	
6.0 hp 135700 single cyl. "L" head	BR2LM	5798	0,8	310
6.0 hp 97700 serie single cyl. OHV	BCPR5ES	6130	0,7	
6.0 hp 146400,146700	BR2LM	5798	0,8	310
6.0 hp 12V000 single cyl. "L" head	BR2LM	5798	0,8	310
6.0 hp 12W000 single cyl. "L" head	BR2LM	5798	0,8	310
6.0 hp 133700 single cyl. "L" head	BR2LM	5798	0,8	310
6.0 hp 12H000 single cyl. "L" head	BR2LM	5798	0,8	310
6.0 hp 12J000 single cyl. "L" head	BR2LM	5798	0,8	310
6.5 hp 110600-111600 single cyl.OHV Intek	BKR5ES	2460	0,7	
6.5 hp 170700 single cyl. "L" head	BR2LM	5798	0,8	310
6.5 hp 120400-121400-123400 single cyl.OHV Intek	BKR5ES	2460	0,7	
6.5 hp 120600-121600-122600 single cyl.OHV Intek	BKR5ES	2460	0,7	
7.0 hp 171400 single cyl. "L" head	BR2LM	5798	0,8	310
7.0 hp 170400 single cyl. "L" head	BR2LM	5798	0,8	310
7.0 hp 17U000	BR2LM	5798	0,8	310
7.0 hp 176400 single cyl. "L" head	BR2LM	5798	0,8	310
7.5 hp 138400 serie single cyl.OHV Vanguard	BKR5ES	2460	0,7	
8.0 hp 193700 single cyl. "L" head	BR2LM	5798	0,8	310
8.0 hp 194000 single cyl. "L" head	BR2LM	5798	0,8	310
8.0 hp 190700 single cyl. "L" head	BR2LM	5798	0,8	310
8.0 hp 191700 single cyl. "L" head	BR2LM	5798	0,8	310
8.0 hp 190000	BR2LM	5798	0,8	310
8.0 hp 192400 single cyl. "L" head	BR2LM	5798	0,8	310
8.0 hp 197400 single cyl. "L" head	BR2LM	5798	0,8	310
8.0 hp 200400 single cyl. "L" head	BR2LM	5798	0,8	310

Order  
No.Quick  
No.**B & S Motoren**

8.0 hp 190400 single cyl. "L" head	BR2LM	5798	0,8	310
8.0 hp 196400 single cyl. "L" head	BR2LM	5798	0,8	310
8.0 hp 195000 single cyl. "L" head	BR2LM	5798	0,8	310
8.5 hp 160000 serie OHV	BKR5ES	2460	0,7	
8.5 hp 196700 single cyl. "L" head	BR2LM	5798	0,8	310
9.0 hp 161400 serie OHV single cyl. Vanguard	BCPR5ES	6130	0,7	
9.0 hp 233400 single cyl. "L" head	BR2LM	5798	0,8	310
9.0 hp 185400 serie OHV single cyl. Vanguard	BCPR5ES	6130	0,7	
9.0 hp 231400 single cyl. "L" head	BR2LM	5798	0,8	310
9.0 hp 19B400 serie single cyl. "L" head	BKR5ES	2460	0,7	
9.0 hp 230000	BR2LM	5798	0,8	310
9.0 hp 19C400 serie single cyl. "L" head	BKR5ES	2460	0,7	
9.0 hp 19A400 serie single cyl. "L" head	BKR5ES	2460	0,7	
10.0 hp 243400 single cyl. "L" head	BR2LM	5798	0,8	310
10.0 hp 255700 single cyl. "L" head	BR2LM	5798	0,7	310
10.0 hp 240000	BR2LM	5798	0,8	310
10.0 hp 254700 single cyl. "L" head	BR2LM	5798	0,7	310
10.0 hp 256700 single cyl. "L" head	BR2LM	5798	0,7	310
10.0 hp 220000	BR2LM	5798	0,8	310
10.0 hp 226400 single cyl. "L" head	BR2LM	5798	0,8	310
10.0 hp 222400 single cyl. "L" head	BR2LM	5798	0,8	310
10.0 hp 221400 single cyl. "L" head	BR2LM	5798	0,8	310
10.0 hp 19E400 serie single cyl. "L" head	BKR5ES	2460	0,7	
10.0 hp 19F400 serie single cyl. "L" head	BKR5ES	2460	0,7	
10.0 hp 19G400 serie single cyl. "L" head	BKR5ES	2460	0,7	
10.0 hp 28A700 single cyl. "L" head	BR2LM	5798	0,7	310
10.5 hp 28B700 single cyl. "L" head	BR2LM	5798	0,7	310
10.5 hp 257700 single cyl. "L" head	BR2LM	5798	0,7	310
11.0 hp 235400 serie single cyl. OHV Vanguard	BCPR5ES	6130	0,7	
11.0 hp 252000 single cyl. "L" head	BR2LM	5798	0,7	310
11.0 hp 251400 single cyl. "L" head	BR2LM	5798	0,8	310
11.0 hp 28C700 single cyl. "L" head	BR2LM	5798	0,7	310
11.0 hp 251700 single cyl. "L" head	BR2LM	5798	0,7	310
11.0 hp 254400 single cyl. "L" head	BR2LM	5798	0,7	310
11.0 hp 250000	BR2LM	5798	0,8	310
11.0 hp 252000 single cyl. "L" head	BR2LM	5798	0,7	310
11.0 hp 259700 single cyl. "L" head	BR2LM	5798	0,7	310
11.0 hp 256400 single cyl. "L" head	BR2LM	5798	0,7	310
11.0 hp 258700 single cyl. "L" head	BR2LM	5798	0,7	310
11.0 hp 253000 single cyl. "L" head	BR2LM	5798	0,7	310
11.0 hp 250400 single cyl. "L" head	BR2LM	5798	0,8	310
11.0 hp 255400 single cyl. "L" head	BR2LM	5798	0,7	310
11.5 hp 259700 single cyl. "L" head	BR2LM	5798	0,7	310
11.5 hp 28D700 single cyl. "L" head	BR2LM	5798	0,7	310
12.0 hp 282700 single cyl. "L" head	BR2LM	5798	0,7	310
12.0 hp 284700 single cyl. "L" head	BR2LM	5798	0,7	310
12.0 hp 301400 single cyl. "L" head	BR2LM	5798	0,7	310
12.0 hp 283700 single cyl. "L" head	BR2LM	5798	0,7	310
12.0 hp 300400 single cyl. "L" head	BR2LM	5798	0,7	310
12.0 hp 281700 single cyl. "L" head	BR2LM	5798	0,7	310
12.0 hp 280000	BR2LM	5798	0,7	310
12.0 hp 280700 single cyl. "L" head	BR2LM	5798	0,7	310



Order  
No.Quick  
No.**B & S Motoren**

12.5 hp 285700 single cyl. "L" head	BR2LM	5798	0,7	310
12.5 hp 290000 serie OHV	BCPR5ES	6130	0,7	
12.5 hp 290700 serie V-Twin OHV Vanguard	BKR5ES	2460	0,7	
12.5 hp 288700 single cyl. "L" head	BR2LM	5798	0,7	310
12.5 hp 286700 single cyl. "L" head	BR2LM	5798	0,7	310
12.5 hp 260700 serie single cyl. OHV Vanguard	BCPR5ES	6130	0,7	
12.5 hp 290400 serie V-Twin OHV Vanguard	BKR5ES	2460	0,7	
12.5 hp 260000 OHV	BCPR5ES	6130	0,7	
12.5 hp 404000 serie Twin cyl.	BP5S	3011	0,8	
12.5 hp 404700 opposed twin cyl. "L" head	BR2LM	5798	0,7	310
12.5 hp 289700 single cyl. "L" head	BR2LM	5798	0,7	310
12.5 hp 404400 opposed twin cyl. "L" head	BR2LM	5798	0,7	310
13.0 hp 302400 single cyl. "L" head	BR2LM	5798	0,7	310
13.0 hp 302430	BR2LM	5798	0,7	310
13.0 hp 28F700 single cyl. "L" head	BR2LM	5798	0,7	310
13.0 hp 28M700 single cyl. "L" head	BR2LM	5798	0,7	310
13.0 hp 245400 serie single cyl. OHV Vanguard	BCPR5ES	6130	0,7	
13.5 hp 28R700 single cyl. "L" head	BR2LM	5798	0,7	310
14.0 hp 294400 serie V-Twin OHV Vanguard	BKR5ES	2460	0,7	
14.0 hp 400400 opposed twin cyl. "L" head	BR2LM	5798	0,7	310
14.0 hp 261700 serie single cyl. OHV Vanguard	BCPR5ES	6130	0,7	
14.0 hp 320400 single cyl. "L" head	BR2LM	5798	0,7	310
14.0 hp 261700,294400,294700 OHV	BCPR5ES	6130	0,7	
14.0 hp 400000 serie Twin cyl.	BP5S	3011	0,8	
14.0 hp 28P700 serie single cyl. OHV Vanguard	BCPR5ES	6130	0,7	
14.0 hp 28E700 serie single cyl. OHV	BCPR5ES	6130	0,7	
14.0 hp 294700 serie V-Twin OHV Vanguard	BKR5ES	2460	0,7	
14.0 hp 400700 opposed twin cyl. "L" head	BR2LM	5798	0,7	310
14.5 hp 287700 serie single cyl. OHV	BCPR5ES	6130	0,7	
15.0 hp 300000 serie OHV	BCPR5ES	6130	0,7	
15.0 hp 325400 single cyl. "L" head	BR2LM	5798	0,7	310
15.5 hp 28S700 serie single cyl. OHV Vanguard	BCPR5ES	6130	0,7	
15.5 hp 28N700 serie single cyl. OHV	BCPR5ES	6130	0,7	
16.0 hp 28U700 serie single cyl. OHV	BCPR5ES	6130	0,7	
16.0 hp 28Q700 serie single cyl. OHV Vanguard	BCPR5ES	6130	0,7	
16.0 hp 402400 opposed twin cyl. "L" head	BR2LM	5798	0,7	310
16.0 hp 401700 opposed twin cyl. "L" head	BR2LM	5798	0,7	310
16.0 hp 42B700 opposed twin cyl. "L" head	BR2LM	5798	0,7	310
16.0 hp 326400 single cyl. "L" head	BR2LM	5798	0,7	310
16.0 hp 303400,303700 OHV V-Twin Vanguard	BCPR5ES	6130	0,7	
16.0 hp 320000	BR2LM	5798	0,7	310
16.0 hp 402700 opposed twin cyl. "L" head	BR2LM	5798	0,7	310
16.0 hp 402000 serie Twin cyl.	BP5S	3011	0,8	
16.0 hp 401400 opposed twin cyl. "L" head	BR2LM	5798	0,7	310
16.5 hp 28W700 serie single cyl. OHV	BCPR5ES	6130	0,7	
16.5 hp 40A700 opposed twin cyl. "L" head	BR2LM	5798	0,7	310
16.5 hp 310700 serie single cyl. OHV Intek	BCPR5ES	6130	0,7	
17.0 hp 42C700 opposed twin cyl. "L" head	BR2LM	5798	0,7	310
17.0 hp 310700-312700 serie single cyl. OHV Intek	BCPR5ES	6130	0,7	
18.0 hp 350400 serie V-Twin OHV Vanguard	BKR5ES	2460	0,7	
18.0 hp 421400 opposed twin cyl. "L" head	BR2LM	5798	0,7	310
18.0 hp 405700 serie V-Twin OHV Intek	BCPR5ES	6130	0,7	

Order  
No.Quick  
No.**B & S Motoren**

18.0 hp 422700 opposed twin cyl. "L" head	BR2LM	5798	0,7	310		
18.0 hp 350700 serie V-Twin OHV Vanguard	BKR5ES	2460	0,7			
18.0 hp 422000 serie Twin cyl.	BP5S	3011	0,8			
18.0 hp 421700 opposed twin cyl. "L" head	BR2LM	5798	0,7	310		
18.0 hp 422400 opposed twin cyl. "L" head	BR2LM	5798	0,7	310		
18.5 hp 42D700 opposed twin cyl. "L" head"	BR2LM	5798	0,7	310		
19.5 hp 42E700 opposed twin cyl. "L" head	BR2LM	5798	0,7	310		
20.0 hp 460700 opposed twin cyl. "L" head	BR2LM	5798	0,7	310		
20.0 hp 351400 serie V-Twin OHV Vanguard	BKR5ES	2460	0,7			
20.0 hp 406700 serie V-Twin OHV Intek	BCPR5ES	6130	0,7			
20.0 hp 351700 serie V-Twin OHV Vanguard	BKR5ES	2460	0,7			
20.5 hp 461700 opposed twin cyl. "L" head	BR2LM	5798	0,7	310		
21.0 hp 381400-381700 serie V-Twin OHV Vanguard	BKR5ES	2460	0,7			
22.0 hp 407700 serie V-Twin OHV Intek	BCPR5ES	6130	0,7			
23.0 hp 380400-380700 serie V-Twin OHV Vanguard	BKR5ES	2460	0,7			
23.5 hp 430400 serie DM700G Liquid Cooled 3 cyl. Vanguard	BCPR5ES	6130	0,7			
25.0 hp 445700 serie V-Twin OHV Intek	BCPR5ES	6130	0,7			
31.0 hp 580400 serie DM9500G Liquid Cooled 3 cyl. Vanguard	BCPR5ES	6130	0,7			
Classic	BR2LM	5798	0,8	310		
Diamond XTL	BR2LM	5798	0,8	310		
ES 375	BR2LM	5798	0,8	310		
Europa 99772 OHV	BCPR5ES	6130	0,7			
Intek OHV	BCPR5ES	6130	0,7			
Modell 11 Horizontal	BKR5ES	2460	0,7			
Modell 12 Horizontal	BKR5ES	2460	0,7			
Modell 12 Vertical	BKR5ES	2460	0,8			
Modell 20 Horizontal	BKR5ES	2460	0,7			
Modell 28	BKR5ES	2460	0,7			
Modell 31	BKR5ES	2460	0,7			
Modell 40	BKR5ES	2460	0,7			
Modell 44	BKR5ES	2460	0,7			
Quantum	BR2LM	5798	0,8	310		
Quattro	BR2LM	5798	0,8	310		
Sprint	BR2LM	5798	0,8	310		
Vanguard	BKR5ES	2460	0,8			
<b>BARRUS</b>						
Mot. B&S	B4LM	3410	0,5	301		
<b>BOLENS</b>						
Mot. B&S	B4LM	3410	0,5	301		
Mot. Products	B6S	3510	0,5	302		
Mot. Tecumseh	B4	3210	0,6			
<b>BRILL</b>						
102/16	B&S OHV	Aufsitzmäher	BCPR5ES	6130	0,7	
122/20	B&S OHV	Aufsitzmäher	BCPR5ES	6130	0,7	
Mot. Aspera			B4LM	3410	0,5	301
Mot. B&S		Rasenmäher	B4LM	3410	0,5	301
Mot. Honda			BPR5ES	7422	0,7	
Mot. ILO			B5HS	4210	0,5	
Mot. Tecumseh			B4LM	3410	0,5	301

Order  
No.Quick  
No.**CLINTON**

412, 413, 492, 494, 498, 499	B4LM	3410	0,5	301
A-300, C-700, D-700, VS-900	B4LM	3410	0,5	301
Chief	BR6S	3522	0,8	
Chieftan	BP5S	3011	0,8	
E-65, E-1290	B4LM	3410	0,5	301
VS-1200, VS-300	B4LM	3410	0,5	301
V-1000, VS-1000, V-1100, VS-1100, VS-1200, V-1200	B4LM	3410	0,5	301

**CONCORD**

Mot. B&S	B4LM	3410	0,5	301
----------	------	------	-----	-----

**CRAMER**

Cara 38	Vertekutierer	BR4HS	3322	0,6	
Cara 47	Vertekutierer	BR4HS	3322	0,6	
Cara 60	Vertekutierer	BR4HS	3322	0,6	

**CRESCENT**

Mot. Aspera	B4LM	3410	0,5	301
Mot. B&S	B4LM	3410	0,5	301
Mot. Suffolk	B6S	3510	0,5	302

**CROWN**

All	B4LM	3410	0,5	301
-----	------	------	-----	-----

**DOLMAR**

LT-30		BPMR7A	4626	0,5	309
MS-220		BMR7A	4226	0,6	
MS-30 C		BPMR7A	4626	0,5	309
PM-4035		B2LM	1147	0,6	
PM-4040		BR2LM	5798	0,6	310
PM-4045 SE		BR2LM	5798	0,6	310
PM-43		BR2LM	5798	0,6	310
PM-4640 HSM		BR2LM	5798	0,6	310
PM-4645		BR2LM	5798	0,6	310
PM-4645 S		BR2LM	5798	0,6	310
PM-4645 S2		BR2LM	5798	0,6	310
PM-4645 S2E		BR2LM	5798	0,6	310
PM-4645 SE		B2LM	1147	0,6	
PM-4650HS Honda GXV 140		BPR6ES	7822	0,6	
PM-48		BR2LM	5798	0,6	310
PM-48 S		BR2LM	5798	0,6	310
PM-5355 S		B2LM	1147	0,6	
PM-5355 SE		B2LM	1147	0,6	
PM-5360 S3CP		BR2LM	5798	0,6	310
PV-4034	Vertikutierer	BR2LM	5798	0,6	310
TM-102.13	Aufsitzmäher	BKR5ES	2460	0,6	
TM-102.17 H	Aufsitzmäher	BKR5ES	2460	0,6	
TM-85.13	Aufsitzmäher	BKR5ES	2460	0,6	
TM-85.13 H	Aufsitzmäher	BKR5ES	2460	0,6	

**ECHO**

A-14	B&S 10,6kW	Aufsitzmäher	BCPR5ES	6130	0,7	
------	------------	--------------	---------	------	-----	--



Order No.  Quick No.

						<b>ECHO</b>		
A-16	B&S 12,1kW	Aufsitzmäher	BCPR5ES	6130	0,7			
A-18	B&S 13,2kW	Aufsitzmäher	BCPR5ES	6130	0,7			
E-130G		Aufsitzmäher	BR2LM	5798	0,6	310		
E-130HY		Aufsitzmäher	BR2LM	5798	0,6	310		
E-150HY	B&S 11,1kW	Aufsitzmäher	BCPR5ES	6130	0,7			
E-2000HY	B&S 8,5kW	Aufsitzmäher	BR2LM	5798	0,6	310		
HO-13-93C	Honda 9,6kW	Aufsitzmäher	BPR5ES	7422	0,6			
						<b>EFCO</b>		
AR 38-AR / 2		Vertikutierer B&S	BR2LM	5798	0,6	310		
AR 47-AH 3/2		Vertikutierer Honda	BPR6ES	7822	0,6			
AR 48 PBQ	B&S		BR2LM	5798	0,6	310		
AR 48 TBX	B&S		BR2LM	5798	0,6	310		
AR 48 TBXE	B&S		BR2LM	5798	0,6	310		
AR 48 VBX	B&S		BR2LM	5798	0,6	310		
AR 53 PAL	Tecumseh		BR2LM	5798	0,5	310		
AR 53 PB	B&S		BR2LM	5798	0,5	310		
AR 53 PBV	B&S		BR2LM	5798	0,5	310		
AR 53 TAL	Tecumseh		BR2LM	5798	0,5	310		
AR 53 TALV	Tecumseh		BR2LM	5798	0,5	310		
AR 53 TB	B&S		BR2LM	5798	0,5	310		
AR 53 TBX	B&S		BR2LM	5798	0,6	310		
AR 53 TBXE	B&S		BR2LM	5798	0,6	310		
AR 53 THX	Honda		BPR6ES	7822	0,6			
AR 53 THX	Honda		BPR6ES	7822	0,6			
AR 53 VBX	B&S		BR2LM	5798	0,6	310		
AR 60-AH 1/2		Vertikutierer Honda	BPR6ES	7822	0,6			
LR 43 PA	Tecumseh		BR2LM	5798	0,5	310		
LR 43 PB	B&S		BR2LM	5798	0,5	310		
LR 44 P	B&S		BR2LM	5798	0,6	310		
LR 44 PBX	B&S		BR2LM	5798	0,6	310		
LR 47 PA	Tecumseh		BR2LM	5798	0,5	310		
LR 47 PAL	Tecumseh		BR2LM	5798	0,5	310		
LR 47 PAX	Tecumseh		BR2LM	5798	0,5	310		
LR 47 PB	B&S		BR2LM	5798	0,5	310		
LR 47 PBQ	B&S		BR2LM	5798	0,5	310		
LR 47 PBX	B&S		BR2LM	5798	0,5	310		
LR 47 PHQ	Honda		BPR6ES	7822	0,6			
LR 47 TA	Tecumseh		BR2LM	5798	0,5	310		
LR 47 TAL	Tecumseh		BR2LM	5798	0,5	310		
LR 47 TAX	Tecumseh		BR2LM	5798	0,5	310		
LR 47 TB	B&S		BR2LM	5798	0,5	310		
LR 47 TBQ	B&S		BR2LM	5798	0,5	310		
LR 47 TBX	B&S		BR2LM	5798	0,5	310		
LR 47 THQ	Honda		BPR6ES	7822	0,6			
LR 48 PBQ	B&S		BR2LM	5798	0,6	310		
LR 48 PBX	B&S		BR2LM	5798	0,6	310		
LR 48 TBQ	B&S		BR2LM	5798	0,6	310		
LR 48 TBX	B&S		BR2LM	5798	0,6	310		
LR 48 TBXE	B&S		BR2LM	5798	0,6	310		
LR 48 TH	Honda		BPR6ES	7822	0,6			
LR 53 PBX	B&S		BR2LM	5798	0,5	310		

Order  
No.Quick  
No.**EFCO**

LR 53 TBX	B&S	BR2LM	5798	0,5	310
LR 53 THX	Honda	BPR6ES	7822	0,6	
MR 474 PB	B & S	BR2LM	5798	0,5	310
MR 474 TB , TP	B & S	BR2LM	5798	0,5	310
MR 474 TBV	B&S	BR2LM	5798	0,5	310
MR 474 TBV	B & S	BR2LM	5798	0,5	310
MR 474 TK , 534 TK	Kawasaki	BPR6ES	7822	0,6	
MR 534 TB , TBE	B & S	BR2LM	5798	0,5	310
MR 534 TB / TBV	B&S	BR2LM	5798	0,5	310
MR 534 TBVE	B&S	BR2LM	5798	0,5	310
MR 534 TBVI	B&S	BR2LM	5798	0,5	310
MR 534 THV	Honda	BPR6ES	7822	0,6	
MR 534 THVX	Honda	BPR6ES	7822	0,6	
MR 534 TKV / TKF/ TKVF	Kawasaki	BPR5ES	7422	0,6	

**ERING**

5,4PS Basisgerät	Balkenmäher	B5HS	4210	0,5	
A 440 H / HV		B4LM	3410	0,7	301
A 443 H		B4LM	3410	0,7	301
A 448 H		B4LM	3410	0,7	301
A 448 H / HV		B4LM	3410	0,7	301
A 448 H-ZH		B4LM	3410	0,7	301
A 448 S		B4LM	3410	0,7	301
ABA 448 H		BR2LM	5798	0,5	310
AH 453 H Alu		B4LM	3410	0,7	301
B 448 H / HV		B4LM	3410	0,7	301
B 448 H Alu		B4LM	3410	0,7	301
BH 448 H Alu		B4LM	3410	0,7	301
CO A 448 S HV		B4LM	3410	0,7	301
G4-87	Balkenmäher	BR2LM	5798	0,5	310
GAN 3748 H ZH		B4LM	3410	0,7	301
GAN 4045 HI ZH		BR2LM	5798	0,5	310
GAN 4048 H ZH / Cat.		B4LM	3410	0,7	301
GAN 4548 H ZH /	Tecumseh	B4LM	3410	0,7	301
GAN 4548 H ZH /	Honda	BPR6ES	7822	0,7	
GAN 5048 H ZH /	B&S	B4LM	3410	0,7	301
GT B 4840 P		BR2LM	5798	0,5	310
GT B 4850 T		BR2LM	5798	0,5	310
GT B 5350 ES		BR2LM	5798	0,5	310
GT B 5350 T		BR2LM	5798	0,5	310
H 3581	Balkenmäher	BR2LM	5798	0,5	310
H 448 H HV		BR2LM	5798	0,5	310
Mot. Aspera		B4LM	3410	0,5	301
Mot. B&S		B4LM	3410	0,5	301
Muko A 448 H-ZH		B4LM	3410	0,7	301
R 7608 S	Aufsitzmäher	B4LM	3410	0,7	301
R 7612 S	Aufsitzmäher	B4LM	3410	0,7	301
T 4	Balkenmäher	B4LM	3410	0,7	301
T 1012 S	Aufsitzmäher	B4LM	3410	0,7	301
T 3581	Balkenmäher	BR2LM	5798	0,5	310
Traktor 14PS		B4LM	3410	0,7	301
VBT-40	Vertikutierer	B4LM	3410	0,7	301



Order No.  Quick No.

<b>ERING</b>					
VBT-40 H	BR2LM	5798	0,5	310	
<b>FICHTEL &amp; SACHS</b>					
SB 93	B4H	4110	0,6		
SB 102	B5HS	4210	0,6		
SB 126	B5HS	4210	0,6		
SB 151	B5HS	4210	0,6		
SB 151 A	B5HS	4210	0,6		
ST 76	B5HS	4210	0,6		
ST 96	B5HS	4210	0,6		
ST 102	B7HS	5110	0,6	204	
ST 126	B7HS	5110	0,6	204	
ST 151	B7HS	5110	0,6	204	
ST 203	A7	1110	0,6		
ST 204 mit 14mm	B7HS	5110	0,6	204	
ST 204 mit 18mm	A7	1110	0,6		
ST 251 mit 14mm	B7HS	5110	0,6	204	
ST 251 mit 18mm	A7	1110	0,6		
ST 282	A7	1110	0,6		
<b>FLANDRIA</b>					
Mot. B&S	B4LM	3410	0,7	301	
<b>FLYMO</b>					
508 Chief	B2LM	1147	0,7		
Chevron 420GL	BMR6A	7421	0,7	307	
Chevron 420GL Autodrive	BM6A	5921	0,6	303	
Contractor GCL75	BMR6A	7421	0,7	307	
F 20	B2LM	1147	0,7		
GT 2	B7HS	5110	0,5	204	
GT 2-6 Contractor	B6HS	4510	0,5	203	
GT 4S	B4LM	3410	0,6	301	
L 38 Pilot	B4LM	3410	0,5	301	
L 47 Pilot	B4LM	3410	0,5	301	
L 50 Contractor	B4LM	3410	0,5	301	
L 300	BPMR7A	4626	0,5	309	
L 400	BPMR6A	6726	0,5	308	
LT 10/36	Traktor	BMR6A	7421	0,7	307
LT 12/36	Traktor	BMR6A	7421	0,7	307
LT 12/38	Traktor	BMR6A	7421	0,7	307
RL 400	B2LM	1147	0,5		
RL 420	BMR6A	7421	0,7	307	
RL 420PD	BMR6A	7421	0,7	307	
RL 420PDE	BMR6A	7421	0,7	307	
RL 500	B2LM	1147	0,7		
RL 550	B2LM	1147	0,7		
RRL 420	B2LM	1147	0,7		
RRL 420PD	B2LM	1147	0,7		
RRL 420PDE	B2LM	1147	0,7		
<b>GARDEN</b>					
Contractor 760 B&S engine 12,5HP	BR2LM	5798	0,8	310	

Order  
No.Quick  
No.**GARDEN**

Contractor 760	Honda GVX 390 engine	BPR5ES	7422	0,8	
Sprint 950	Kohler Command 18 OHV	BPR5ES	7422	0,8	
Sprint 950	Honda GVX 610 + GVX 620	BPR5ES	7422	0,8	
Stingray	Honda GVX 620	BPR5ES	7422	0,8	
Stingray	Kohler Command 220HV	BPR5ES	7422	0,8	

**GOLF**

Mot. Aspera		B4LM	3410	0,6	301
Mot. B&S		BR4LM	4133	0,5	
Mot. Techna		B4LM	3410	0,5	301

**GUTBROD**

Sprint 3000		Aufsitzmäher	B2LM	1147	0,7	
MH 464 RVE 6			B2LM	1147	0,7	
Sprint 1012 S	B&S	Traktor	BR2LM	5798	0,6	310
1000 E	B&S	Traktor	BR2LM	5798	0,5	310
1002 E	B&S	Traktor	BR2LM	5798	0,5	310
1012 S	B&S	Traktor	BR2LM	5798	0,6	310
1114 AWS	B&S	Traktor	BCPR5ES	6130	0,6	
1400		Aufsitzmäher	BR2LM	5798	0,6	310
170 SD 4	Tecumseh	Traktor	BR4LM	4133	0,5	
370 BMR 4 Vantage 35T		Balkenmäher	BR2LM	5798	0,5	310
800		Aufsitzmäher	BR2LM	5798	0,6	310
850		Aufsitzmäher	BR2LM	5798	0,6	310
BM 91 FA130	Kawasaki	Balkenmäher	BM6A	5921	0,6	303
BM 100 2G 1431	Gutbrod	Balkenmäher	B6HS	4510	0,6	203
BM 100 2G 1433	Gutbrod	Balkenmäher	B6HS	4510	0,6	203
BM 107	Kawasaki	Balkenmäher	BM6A	5921	0,6	303
BM 700 92982	B&S	Balkenmäher	BR4LM	4133	0,5	
BM 700 Vantage	B&S	Balkenmäher	BR4LM	4133	0,5	
BM 710	B&S	Balkenmäher	BR4LM	4133	0,5	
ECO B	B&S		BR4LM	4133	0,5	
ECO BR	B&S		BR4LM	4133	0,5	
Euro Class XM35	B&S Quant.		BR2LM	5798	0,5	310
Euro Class XM50	B&S Quant.		BR2LM	5798	0,5	310
Golf BSV 143	Tecna		BR2LM	5798	0,5	310
Golf Prisma 37	Tecna		BR2LM	5798	0,5	310
Golf Prisma 40	Tecna		BR2LM	5798	0,5	310
Golf Vantage	Tecna		BR2LM	5798	0,5	310
HB 42 L	B&S		BR4LM	4133	0,5	
HB 42 LE	B&S		BR4LM	4133	0,5	
HB 42 RL	B&S		BR4LM	4133	0,5	
HB 48	B&S		BR4LM	4133	0,5	
HB 48 L	B&S		BR4LM	4133	0,5	
HB 48 REL	B&S		BR4LM	4133	0,5	
HB 48 RL	B&S		BR4LM	4133	0,5	
HB 53 RL			B2LM	1147	0,7	
HBM 50			B2LM	1147	0,7	
MH 544 R3 / RE	B&S		BR2LM	5798	0,6	310
MH 404	B&S		BR4LM	4133	0,5	
MH 454 B	B&S		BR4LM	4133	0,5	
MH 454 BE	B&S		BR4LM	4133	0,5	



Order No.  Quick No.

## GUTBROD

MH 454 RB	B&S		BR4LM	4133	0,5	
MH 454 RBE	B&S		BR4LM	4133	0,5	
MH 454 RSB	B&S		BR4LM	4133	0,5	
MH 454 RSEB	B&S		BR4LM	4133	0,5	
MH 454 RV	Kawasaki		BPR6ES	7822	0,6	
MH 454 SEB	B&S		BR4LM	4133	0,5	
MH 464 B			B2LM	1147	0,7	
MH 464 RV6			B2LM	1147	0,7	
MH 534 PR	Kawasaki		BPR6ES	7822	0,6	
MH 534 RV	Kawasaki		BPR6ES	7822	0,6	
MH 534 RVE	Kawasaki		BPR6ES	7822	0,6	
Mot. MAG			B5HS	4210	0,5	
MV 400	Tecna	Vertikutierer	B4LM	3410	0,5	301
MV 404	Tecna	Vertikutierer	B4LM	3410	0,5	301
MV 504	B&S	Vertikutierer	B4LM	3410	0,5	301
RSB 100-12	B&S	Traktor	BR2LM	5798	0,6	310
RSB 110-16H	B&S	Traktor	BCPR5ES	6130	0,6	
RSB 80-12	B&S	Traktor	BR2LM	5798	0,5	310
SB 46			B2LM	1147	0,7	
SB 48	B&S		BR4LM	4133	0,5	
Sprint 900		Aufsitzmäher	B2LM	1147	0,7	
Sprint 1002 E	B&S	Traktor	BR2LM	5798	0,6	310
Sprint 2000		Aufsitzmäher	B2LM	1147	0,7	
Sprint 3000	B&S	Aufsitzmäher	BCPR5ES	6130	0,6	
Super Class FC150V	Kawasaki		BPR6ES	7822	0,6	
Super Class XM35	B&S Quant.		BR2LM	5798	0,5	310
Super Class XM50	B&S Quant.		BR2LM	5798	0,5	310
VB 38		Vertikutierer	B2LM	1147	0,7	

## HAKO

120			B4LM	3410	0,6	301
Boy 8610			A6	1010	0,5	
Boy J10 engine			B5HS	4210	0,5	
Combinette 100			B4LM	3410	0,6	301
Combinette 3604			B5HS	4210	0,5	
Gartentrac 1100E			B4LM	3410	0,6	301
Gartentrac 1600E			B4LM	3410	0,6	301
Hakomobil 4000			BP6HS	4511	0,6	
Hakorette 150			B5HS	4210	0,5	
Hakorette 200			BM6A	5921	0,5	303
Hakorette 5003 , 5004 , 5007			A6	1010	0,5	
Hakorette 5008 , 5035			A6	1010	0,5	
Hamster 6206			B6S	3510	0,7	302
Hamster S			B4H	4110	0,7	
Jardinette 3605			B6S	3510	0,7	302
Jonas 1600			B5HS	4210	0,6	
Minette			B4LM	3410	0,6	301
Mot. B&S			B4LM	3410	0,6	301
Mot. ILO 14 mm			B5HS	4210	0,5	
Mot. ILO 18 mm			A6	1010	0,5	
Profi 92 J10 Engine			B5HS	4210	0,6	
Rasentrac 600			B6S	3510	0,7	302



Order  
No.Quick  
No.**HAKO**

Rasentrac 708 ,708E ,800,1000E		<b>B4LM</b>	<b>3410</b>	0,6	<b>301</b>
Rasetta 18L , 20H , 20L , 20N		<b>B4LM</b>	<b>3410</b>	0,6	<b>301</b>
Rasetta 20S , 22R , 22S		<b>B4LM</b>	<b>3410</b>	0,6	<b>301</b>
Trac 1200,1400		<b>B4H</b>	<b>4110</b>	0,7	
Trac 8014		<b>B6HS</b>	<b>4510</b>	0,6	<b>203</b>
Variette		<b>B5HS</b>	<b>4210</b>	0,5	
Variette 3611		<b>B6S</b>	<b>3510</b>	0,7	<b>302</b>
Variette 3615		<b>B6HS</b>	<b>4510</b>	0,5	<b>203</b>

**HARRY**

302 QZA	Tecna	<b>BR2LM</b>	<b>5798</b>	0,7	<b>310</b>
302 QZB	B&S	<b>BR2LM</b>	<b>5798</b>	0,7	<b>310</b>
302 DFB		<b>B6HS</b>	<b>4510</b>	0,6	<b>203</b>
302 EFA		<b>B4LM</b>	<b>3410</b>	0,6	<b>301</b>
302 QFA		<b>B4LM</b>	<b>3410</b>	0,6	<b>301</b>
302 QFB	B&S Quantum	<b>BM6A</b>	<b>5921</b>	0,6	<b>303</b>
313 MZB	B&S	<b>BR2LM</b>	<b>5798</b>	0,7	<b>310</b>
313 QZA	Tecna	<b>BR2LM</b>	<b>5798</b>	0,7	<b>310</b>
313 QFA		<b>B4LM</b>	<b>3410</b>	0,6	<b>301</b>
313 QFB , 314 QFB	B&S Quantum	<b>BM6A</b>	<b>5921</b>	0,6	<b>303</b>
314 EFA		<b>B4LM</b>	<b>3410</b>	0,6	<b>301</b>
322 LFB	B&S Quantum	<b>BM6A</b>	<b>5921</b>	0,6	<b>303</b>
401 LZB	B&S	<b>BR2LM</b>	<b>5798</b>	0,7	<b>310</b>
401 MZB	B&S	<b>BR2LM</b>	<b>5798</b>	0,7	<b>310</b>
401 LFB	B&S Quantum	<b>BM6A</b>	<b>5921</b>	0,6	<b>303</b>
401 QFA		<b>B4LM</b>	<b>3410</b>	0,6	<b>301</b>
411 QZA	Tecna	<b>BR2LM</b>	<b>5798</b>	0,7	<b>310</b>
411 QFA , 411 EFA		<b>B4LM</b>	<b>3410</b>	0,6	<b>301</b>
411 QFB	B&S Quantum	<b>BM6A</b>	<b>5921</b>	0,6	<b>303</b>
424 LFB	B&S Quantum	<b>BM6A</b>	<b>5921</b>	0,6	<b>303</b>
451 LZB , AZB	B&S	<b>BR2LM</b>	<b>5798</b>	0,7	<b>310</b>
451 AFB	B&S Quantum	<b>BM6A</b>	<b>5921</b>	0,6	<b>303</b>
451 DFB		<b>B6HS</b>	<b>4510</b>	0,6	<b>203</b>
451 QFA		<b>B4LM</b>	<b>3410</b>	0,6	<b>301</b>
451 QFB , 451 LFB	B&S Quantum	<b>BM6A</b>	<b>5921</b>	0,6	<b>303</b>
471 AZB	B&S	<b>BR2LM</b>	<b>5798</b>	0,7	<b>310</b>
471 PZB	B&S	<b>BR2LM</b>	<b>5798</b>	0,7	<b>310</b>
471 AFB	B&S Quantum	<b>BM6A</b>	<b>5921</b>	0,6	<b>303</b>
471 DFB		<b>B6HS</b>	<b>4510</b>	0,6	<b>203</b>
471 DFF		<b>B5HS</b>	<b>4210</b>	0,6	
471 LFB	B&S Quantum	<b>BM6A</b>	<b>5921</b>	0,6	<b>303</b>
471 VFB	B&S OHV	<b>BCPR5ES</b>	<b>6130</b>	0,8	
772 VZB	B&S	<b>BR2LM</b>	<b>5798</b>	0,7	<b>310</b>

**HERKULES**

11/30	Aufsitzmäher	<b>BR2LM</b>	<b>5798</b>	0,5	<b>310</b>
12/40	Aufsitzmäher	<b>BR2LM</b>	<b>5798</b>	0,5	<b>310</b>
14/40	Aufsitzmäher	<b>BR6S</b>	<b>3522</b>	0,7	
155 6-Speed	Aufsitzmäher	<b>BKR5ES</b>	<b>2460</b>	0,7	
16/43-4WS	Aufsitzmäher	<b>BR2LM</b>	<b>5798</b>	0,5	<b>310</b>
180 Automatic	Aufsitzmäher	<b>BKR5ES</b>	<b>2460</b>	0,7	
200 HXL Automatic	Aufsitzmäher	<b>BKR5ES</b>	<b>2460</b>	0,7	



Order No.  Quick No.

## HERKULES

400B	B&S	Vertikutierer	BR2LM	5798	0,7	310
AR 38	Tecna	Vertikutierer	B4LM	3410	0,6	301
AR 45	B&S	Vertikutierer	BM6A	5921	0,6	303
B400		Vertikutierer	BR2LM	5798	0,7	310
BM 200		Balkenmäher	BR4LM	4133	0,5	
BM200T		Balkenmäher	BR4LM	4133	0,5	
D 3 , D 6	B&S	Balkenmäher	BM6A	5921	0,6	303
E51B	B&S		BR2LM	5798	0,7	310
E51H	Honda		BPR6ES	7822	0,7	
FM 300 H		Balkenmäher	BPR6ES	7822	0,6	
FM 300 T		Balkenmäher	BR4LM	4133	0,5	
GT40T , GT42T	Tecna		BR2LM	5798	0,7	310
GT47SB	B&S		BR2LM	5798	0,7	310
GT47SBM , GT47BM	B&S		BR2LM	5798	0,7	310
GT47T	Tecna		BR2LM	5798	0,7	310
GT48B	B&S		BR2LM	5798	0,7	310
GT53SB	B&S		BR2LM	5798	0,7	310
GT56SBV , GT48SB	B&S		BR2LM	5798	0,7	310
Harry 302 MZB			BR4LM	4133	0,5	
Harry 302 QZA			BR2LM	5798	0,5	310
Harry 302 QZB			BR2LM	5798	0,5	310
Harry 313 MZB			BR2LM	5798	0,5	310
Harry 313 QZA			BR4LM	4133	0,5	
Harry 401 LZA			BR4LM	4133	0,5	
Harry 401 LZB			BR4LM	4133	0,5	
Harry 401 MZB			BR4LM	4133	0,5	
Harry 411 QZA			BR2LM	5798	0,5	310
Harry 451 AZB			BR4LM	4133	0,5	
Harry 451 LZB			BR2LM	5798	0,5	310
Harry 471 AZB			BR2LM	5798	0,5	310
Harry 471 PZB			BR2LM	5798	0,5	310
Harry 471 VZA			BR2LM	5798	0,5	310
Harry 772 VZB			BR2LM	5798	0,5	310
HTC 13 Plus		Aufsitzmäher	BR2LM	5798	0,7	310
HTC 13,5 Plus		Aufsitzmäher	BR2LM	5798	0,7	310
HTC 15,5 Plus		Aufsitzmäher	BKR5ES	2460	0,7	
HTC 16 H Plus		Aufsitzmäher	BKR5ES	2460	0,7	
HTC 16 Plus		Aufsitzmäher	BKR5ES	2460	0,7	
HTC 18 H Plus		Aufsitzmäher	BKR5ES	2460	0,7	
HTC 20 H Plus		Aufsitzmäher	BKR5ES	2460	0,7	
HTC Junior 13,00		Aufsitzmäher	BR2LM	5798	0,7	310
MB 410	B&S		BM6A	5921	0,6	303
MB 460 , MB 460S , MB 460ES	B&S		BM6A	5921	0,6	303
MB 462	B&S 2,9kW		B4LM	3410	0,5	301
MB 462 S	B&S 3,3kW		B4LM	3410	0,5	301
MB40ST			BR4LM	4133	0,5	
MB40T			BR4LM	4133	0,5	
MB482SH			BPR6ES	7822	0,7	
MB48SB			BR2LM	5798	0,5	310
MB48SBV			BR2LM	5798	0,5	310
MB48ST			BR4LM	4133	0,5	
MB48T			BR4LM	4133	0,5	

Order  
No.Quick  
No.**HERKULES**

MB532SH		<b>BPR6ES</b>	<b>7822</b>	0,7	
MB53SHV		<b>BPR5ES</b>	<b>7422</b>	0,7	
MB55SBV		<b>BR2LM</b>	<b>5798</b>	0,5	<b>310</b>
MB55SHV		<b>BPR5ES</b>	<b>7422</b>	0,7	
MCB46		<b>BR2LM</b>	<b>5798</b>	0,7	<b>310</b>
MCB46S		<b>BR2LM</b>	<b>5798</b>	0,7	<b>310</b>
MR432		<b>BR2LM</b>	<b>5798</b>	0,7	<b>310</b>
Orec FL 500	Honda GXV160	<b>BPR5ES</b>	<b>7422</b>	0,6	
Orec HR 660 B	Robin 5,5kW	<b>BP6HS</b>	<b>4511</b>	0,6	
Orec SH 60	Kawasaki 4,5kW	<b>BPR5ES</b>	<b>7422</b>	0,6	
Orec SH 70	Honda GXV270	<b>BPR5ES</b>	<b>7422</b>	0,6	
R 434 , R 484TR	B&S	<b>BM6A</b>	<b>5921</b>	0,6	<b>303</b>
TN 195SEK , TN 195SXX		<b>BP6ES</b>	<b>7811</b>	0,8	
TN 215SEK , TN 215SXKE		<b>BP6ES</b>	<b>7811</b>	0,8	
Turbo Cut HTC 120	Aufsitzmäher	<b>BR2LM</b>	<b>5798</b>	0,5	<b>310</b>
Turbo Cut HTC 150	Aufsitzmäher	<b>BCPR5ES</b>	<b>6130</b>	0,7	
Turbo Cut HTC 180 H	Aufsitzmäher	<b>BCPR5ES</b>	<b>6130</b>	0,7	
Twin-Cut 12,5 Plus	Aufsitzmäher	<b>BR2LM</b>	<b>5798</b>	0,5	<b>310</b>
Twin-Cut 15 Plus	Aufsitzmäher	<b>BCPR5ES</b>	<b>6130</b>	0,7	
Twin-Cut 15,5 H Plus	Aufsitzmäher	<b>BCPR5ES</b>	<b>6130</b>	0,7	
Twin-Cut 16 H Plus	Aufsitzmäher	<b>BCPR5ES</b>	<b>6130</b>	0,7	
Twin-Cut 16Plus	Aufsitzmäher	<b>BCPR5ES</b>	<b>6130</b>	0,7	
Twin-Cut 18 Plus	Aufsitzmäher	<b>BCPR5ES</b>	<b>6130</b>	0,7	
WM60B	Gestrüppschneider	<b>BKR5ES</b>	<b>2460</b>	0,7	
WM60BR	Gestrüppschneider	<b>BR2LM</b>	<b>5798</b>	0,7	<b>310</b>

**HOLDER**

Mot. B&S		<b>B4LM</b>	<b>3410</b>	0,5	<b>301</b>
Mot. F&S 14 mm		<b>B5HS</b>	<b>4210</b>	0,5	
Mot. F&S 18 mm		<b>A6</b>	<b>1010</b>	0,5	
Mot. ILO 14 mm		<b>B5HS</b>	<b>4210</b>	0,5	
Mot. ILO 18 mm		<b>A7</b>	<b>1110</b>	0,5	
Mot. Intermotor		<b>B4H</b>	<b>4110</b>	0,5	
Mot. Lombardini		<b>B4H</b>	<b>4110</b>	0,7	

**HOMELITE**

45STD , 45DLX		<b>B2LM</b>	<b>1147</b>	0,6	
HBM21P5-2I		<b>B2LM</b>	<b>1147</b>	0,6	
HCM20 , HCM20P5	Vertikutierer	<b>B2LM</b>	<b>1147</b>	0,6	
HCM20P5G	Vertikutierer	<b>B2LM</b>	<b>1147</b>	0,6	
HMB21P4I		<b>B2LM</b>	<b>1147</b>	0,6	
HMB21P5I		<b>B2LM</b>	<b>1147</b>	0,6	
HSB21		<b>B2LM</b>	<b>1147</b>	0,6	
HSB21P5		<b>B2LM</b>	<b>1147</b>	0,6	
HSB21P5EG		<b>B2LM</b>	<b>1147</b>	0,6	
HSD20P , HSD20V , HSD20K		<b>B2LM</b>	<b>1147</b>	0,6	

**HONDA**

GXV 120		<b>BPR5ES</b>	<b>7422</b>	0,7	
H 1011H	Aufsitzmäher	<b>BPR5ES</b>	<b>7422</b>	0,7	
H 1011S	Aufsitzmäher	<b>BPR5ES</b>	<b>7422</b>	0,7	
H 2013S	Aufsitzmäher	<b>BPR5ES</b>	<b>7422</b>	0,7	



Order No.  Quick No.

## HONDA

H 3001/H		BPR5ES	7422	0,7	
H 3009		BPR5ES	7422	0,6	
H 3011		BPR5ES	7422	0,6	
H 3013H		BPR5ES	7422	0,6	
H 4013		BPR5ES	7422	0,7	
H 4013		BPR5ES	7422	0,6	
H 4514	Aufsitzmäher	BPR4ES	7222	0,7	
H 4518	Aufsitzmäher	BPR5ES-11	4424	1,1	
HC 16		BMR4A	5728	0,6	306
HC 20 , HC 26		BPR6ES	7822	0,8	
HF 1211	Aufsitzmäher	BPR5ES	7422	0,7	
HF 1211 H	Aufsitzmäher	BPR5ES	7422	0,7	
HF 1211 S	Aufsitzmäher	BPR5ES	7422	0,7	
HF 2113 H	Aufsitzmäher	BPR6ES	7822	0,7	
HF 2113 S	Aufsitzmäher	BPR6ES	7822	0,7	
HF 2114 S/H	Aufsitzmäher	BPR5ES	7422	0,8	
HF 2200 S/H	Aufsitzmäher	ZGR5A	5839	0,8	
HF 2213	Aufsitzmäher	BPR5ES	7422	0,6	
HF 2213 H	Aufsitzmäher	BPR5ES	7422	0,6	
HF 2213S	Aufsitzmäher	BPR5ES	7422	0,7	
HF 2216 S/H	Aufsitzmäher	BPR5ES	7422	0,8	
HF 2218 HL	Aufsitzmäher	BPR5ES	7422	0,6	
HF 2218 SL	Aufsitzmäher	BPR5ES	7422	0,6	
HF 2220 HL	Aufsitzmäher	ZGR5A	5839	0,8	
HF 2220 SL	Aufsitzmäher	BPR5ES	7422	0,6	
HF 2315 HM		BPR5ES	7422	0,6	
HF 2315 SB		BPR5ES	7422	0,6	
HF 2415 SB		BPR5ES	7422	0,6	
HF 2417 HAT		BPR5ES	7422	0,6	
HF 2417 HM		BPR5ES	7422	0,6	
HF 2620 HAT		CR5HSB	6535	0,6	
HF 2620 HM		CR5HSB	6535	0,6	
HP 400		BPR4ES	7222	0,7	
HR 17 (GV110)(G100)		BMR4A	5728	0,6	306
HR 17.3 (GV100K1)		BMR4A	5728	0,7	306
HR 19.4 (GXV120)		BPR5ES	7422	0,6	
HR 21 (CDI)		BPMR6A-10	1029	1,0	
HR 21 (MAG.IGN.)		BMR6A	7421	0,6	307
HR 21 K2		BPMR6A-10	1029	1,0	
HR 21.5 (GV200)		BPMR6A	6726	0,6	308
HR 194		BP5ES	6511	0,7	
HR 214 (GXV120)		BPR5ES	7422	0,7	
HR 216 (GXV160)		BPR5ES	7422	0,6	
HR 521		BR4HS	3322	0,7	
HR 1950S		BPR5ES	7422	0,7	
HR 1950SM		BPR5ES	7422	0,7	
HR 1950SX		BPR5ES	7422	0,7	
HR 2150		BPR5ES	7422	0,7	
HR 2160 (GXV160)		BPR5ES	7422	0,7	
HRA 21		BMR6A	7421	0,6	307
HRA 173		BMR4A	5728	0,6	306
HRA 214		BPR5ES	7422	0,6	

Order  
No.Quick  
No.**HONDA**

HRA 216 (GXV160)	BPR5ES	7422	0,6	
HRA 219	BPR5ES	7422	0,7	
HRA 2150	BPR6ES	7822	0,7	
HRA 2160 (GXV160)	BPR5ES	7422	0,7	
HRA 536 HX	BPR5ES	7422	0,6	
HRB 423SX	BMR4A	5728	0,6	306
HRB 423P / PD	BMR4A	5728	0,6	306
HRB 423S / SD	BMR4A	5728	0,6	306
HRB 425C	BPR6ES	7822	0,7	
HRB 425C PD/SD	BPR6ES	7822	0,7	
HRB 425C PX/SX/QX	BPR6ES	7822	0,7	
HRB 475 HM	BPR5ES	7422	0,7	
HRB 475 SM	BPR5ES	7422	0,6	
HRB 475C PD	BPR6ES	7822	0,7	
HRB 475C SD	BPR6ES	7822	0,7	
HRB 475HX	BPR5ES	7422	0,7	
HRB 475P	BPR5ES	7422	0,7	
HRB 475PD	BPR5ES	7422	0,7	
HRB 475S	BPR5ES	7422	0,7	
HRB 475SD	BPR5ES	7422	0,7	
HRB 475SX	BPR5ES	7422	0,7	
HRB 476 C HX	BPR6ES	7822	0,6	
HRB 476 C TX	BPR6ES	7822	0,6	
HRB 476C PD/SD	BPR6ES	7822	0,7	
HRB 476C PX/SX/HX/QX	BPR6ES	7822	0,7	
HRB 476C HX	BPR6ES	7822	0,7	
HRB 476C SX	BPR6ES	7822	0,7	
HRB 535SX	BPR5ES	7422	0,7	
HRB 536C SX	BPR6ES	7822	0,7	
HRB 536C TX	BPR6ES	7822	0,7	
HRD 535 QX	BPR5ES	7422	0,8	
HRD 535 TM	BPR4ES	7222	0,6	
HRD 535 HX	BPR5ES	7422	0,7	
HRD 535 SM	BPR5ES	7422	0,7	
HRD 535 SX	BPR5ES	7422	0,7	
HRD 536 HXE	BPR5ES	7422	0,7	
HRD 536 QX	BPR5ES	7422	0,8	
HRD 536C HX	BPR6ES	7822	0,7	
HRD 536C SX	BPR6ES	7822	0,7	
HRD 536C TX	BPR6ES	7822	0,7	
HRD 536 HM	BPR5ES	7422	0,7	
HRD 536 HX	BPR5ES	7422	0,7	
HRF 465	BPR5ES	7422	0,7	
HRF 465P	BPR5ES	7422	0,7	
HRF 465S	BPR5ES	7422	0,7	
HRF 465 PD	BPR5ES	7422	0,6	
HRF 465 SD	BPR5ES	7422	0,6	
HRG 413 PD	BMR4A	5728	0,6	306
HRG 413 SD	BMR4A	5728	0,6	306
HRG 415C	BPR6ES	7822	0,7	
HRG 465C PD	BPR6ES	7822	0,7	
HRG 465C SD	BPR6ES	7822	0,7	



Order No.  Quick No.

## HONDA

HRG 465 PD		BPR5ES	7422	0,6	
HRG 465 SD		BPR5ES	7422	0,6	
HRG 536C SD		BPR6ES	7822	0,7	
HRG 536C SD		BPR6ES	7822	0,7	
HRH 536 HX		BPR6ES	7822	0,7	
HRH 536 QX		BPR5ES	7422	0,8	
HRM 535SX		BPR5ES	7422	0,7	
HRM 536 C TX		BPR6ES	7822	0,6	
HRM 536C		BPR6ES	7822	0,7	
HRM 536C SX		BPR6ES	7822	0,7	
HRS 21		BR4HS	3322	0,6	
HRS 21 (GXV110)		BR4HS	3322	0,6	
HRS 535C SD		BPR6ES	7822	0,7	
HRX 426C SD		BPR6ES	7822	0,7	
HRX 426C PX		BPR6ES	7822	0,7	
HRX 426C SD		BPR6ES	7822	0,7	
HRX 426C PD		BPR6ES	7822	0,7	
HRX 426C QX	Walzenmäher	BPR6ES	7822	0,7	
HRX 476C PX		BPR6ES	7822	0,7	
HRX 476C SD		BPR6ES	7822	0,7	
HRX 476C SX		BPR6ES	7822	0,7	
HRX 476C QX	Walzenmäher	BPR6ES	7822	0,7	
HRX 476C HX		BPR6ES	7822	0,7	
HRX 537C TD		BPR6ES	7822	0,7	
HRX 537C HX		BPR6ES	7822	0,7	
HRX 537C HM		BPR6ES	7822	0,7	
HRX 537C VYE		BPR6ES	7822	0,7	
HRZ 536C TD	Zero-Turn-Mäher	BPR6ES	7822	0,7	
HT 3810 (G400/K1)		BR4HS	3322	0,7	
HT 3813		BPR4HS	7823	0,7	
HT 4518H		BPR5ES-11	4424	1,1	
HTR 3009 (GXV270)		BPR5ES	7422	0,7	
HTR 3811		BPR5ES	7422	0,6	
UM 17		BMR4A	5728	0,6	306
UM 21 (GXV160)		BPR5ES	7422	0,7	
UM 24		BPR5ES	7422	0,6	
UM 28		BPR5ES	7422	0,6	
UM 2160B		BPR5ES	7422	0,7	
UM 516C		BPR6ES	7822	0,7	
UM 536		BPR4ES	7222	0,5	
UM 536 B		BPR4ES	7222	0,5	
UM 536 EBE		BPR5ES	7422	0,6	
UM 536 EE		BPR5ES	7422	0,6	
UM 616		BPR4ES	7222	0,5	
UM 616 B		BPR4ES	7222	0,5	
UM 616 EBE		BPR5ES	7422	0,6	
UM 616 EE		BPR5ES	7422	0,6	
UM 2160		BPR5ES	7422	0,7	
UM 2160 (GXV160)		BPR5ES	7422	0,7	
UM 2460		BPR5ES	7422	0,7	
UM 2460 (GXV160)		BPR5ES	7422	0,7	
UM 2460B		BPR5ES	7422	0,7	

Order  
No.Quick  
No.**HUSQVARNA**

46ST , 46SR , 3,5PS B&S	BR4LM	4133	0,5	
48 SEK	BPR6ES	7822	0,6	
53 SEK	BPR6ES	7822	0,6	
400B , 450P , 453D , 3,5PS B&S	BR4LM	4133	0,5	
425 S	BPMP6A	6726	0,6	308
485 K , SK , EK	BPR6ES	7822	0,6	
535 (B&S) Master Garden	BR2LM	5798	0,6	310
543S , 4,0 PS B&S	BR4LM	4133	0,5	
820-8	BM6A	5921	0,7	303
970-12 R / S	BM6A	5921	0,7	303
1200-14	BM6A	5921	0,7	303
LT 10 Q	BR2LM	5798	0,6	310
LT 100 ,LT 120	BM6A	5921	0,7	303
LT 130	BR2LM	5798	0,6	310
LT 4140 G-H	BM6A	5921	0,7	303
LT 960-12	BM6A	5921	0,7	303
Master 46	BR2LM	5798	0,6	310
Master PRO2 , PRO4	BM6A	5921	0,7	303
MK 500	BM6A	5921	0,6	303
Rider 650	B4LM	3410	0,6	301
Rider 850-8 , 850-12	BM6A	5921	0,7	303
Rider 970-12R / S	BM6A	5921	0,7	303
Rider 1000-14	BPR5ES	7422	0,6	
Rider 1200-14	BM6A	5921	0,7	303
Rider 1200-18	BPR5ES	7422	0,6	
Rider YTH 1120-14	BPR5ES	7422	0,7	
Royal 42 , 46 , 48 , 48S , 48SE	BMR6A	7421	0,6	307
Royal 43 / S /SE	BR2LM	5798	0,6	310
Royal 48 SEK /SK	BPR6ES	7822	0,6	
Royal 53 S	BR2LM	5798	0,6	310
Royal 53 SEK	BPR6ES	7822	0,6	
Royal 425	BMR6A	7421	0,6	307
Royal 535 / E	BPR6ES	7822	0,6	
Royal 535EK	BPR6ES	7822	0,6	
Royal 820-8	BM6A	5921	0,7	303
Royal Jet 50R	BR2LM	5798	0,6	310
YTH 1120-14	BPR5ES	7422	0,7	

**ILO**

alle Kurzgewinde	B6HS	4510	0,5	203
------------------	------	------	-----	-----

**IRUS**

Mot. F&S 14 mm	B7HS	5110	0,5	204
Mot. F&S 18 mm	A6	1010	0,5	
Mot. Hirth	A6	1010	0,5	
Mot. ILO	A6	1010	0,5	

**JACOBSEN**

Mot. B&S	B4LM	3410	0,6	301
Mot. Clinton	B6S	3510	0,6	302
Mot. Jacobsen	B6S	3510	0,6	302
Mot. Kohler	B6S	3510	0,6	302



Order No.  Quick No.

<b>JACOBSEN</b>				
Mot. Robin	B6HS	4510	0,6	203
Mot. Tecumseh	B6S	3510	0,6	302
<b>JET FAST</b>				
B&S engine	BMR6A	7421	0,6	307
HR 17	BMR6A	7421	0,6	307
HR 21	BMR6A	7421	0,6	307
HR 21 KS	BMR6A	7421	0,6	307
HR 21 with CDI IGN.	BPM6A-10	6026	1,0	
HR 21,5	BMR6A	7421	0,6	307
HRA 21	BMR6A	7421	0,6	307
Yamaha engine (2stroke)	B6HS	4510	0,7	203
<b>JOHN DEERE</b>				
5.0 hp. Kawasaki FC150	BP6ES	7811	0,7	
5.3 hp Kawasaki OHV	BP5ES	6511	0,5	
6.0 hp B&S	BR2LM	5798	0,5	310
6.0 hp Kawasaki OHV	BP5ES	6511	0,5	
6.5 hp B&S	BKR5ES	2460	0,7	
6.75 hp B&S	BKR5ES	2460	0,7	
12PB, 12SB	B2LM	1147	0,6	
13.0 hp Kohler CV13S	BKR5ES-11	2382	1,0	
14.0 hp Kawasaki FC420V	BPR5ES	7422	0,7	
14PZ, 14SZ, F725	B2LM	1147	0,6	
14SB, 14SX, 14SE	BP5ES	6511	0,5	
14SX, 14ST, 14PT	BP5ES	6511	0,5	
17.0 hp. Kawasaki FC540V	BP5ES	6511	0,5	
20SR7	BM6A	5921	0,6	303
56, 57, 66, 68, R72, D28, S92	B6S	3510	0,6	302
Briggs & Stratton	B2LM	1147	0,5	
JA62, JA65, JS60, JS61, JS63	B2LM	1147	0,5	
JE75, JX75, JX85	BP5ES	6511	0,5	
JS63C B&S 6.5hp	BKR5ES	2460	0,7	
Kawasaki TB480V	BM6A	5921	0,6	303
Tecumseh	BPM7A	7321	0,6	305
<b>KINGCAT</b>				
Cheeta 700 Honda GV 400	BMR6A	7421	0,6	307
Cheeta 700 Tecumseh 8HP	B6S	3510	0,8	302
Cougar B&S 16HP	B4	3210	0,6	
Panther B&S 11HP Honda GV 400	BMR6A	7421	0,6	307
Puma 1100 B&S 11HP Honda GV 400	BMR6A	7421	0,6	307
<b>KINGFISHER</b>				
Rotovac 18" B&S	BR6S	3522	0,7	
Rotovac 18" Iron Horse (C&D)	B4	3210	0,6	
Rotovac 18" Tecumseh	BR6S	3522	0,7	
Rotovac 18" Iron Horse (F)	BMR4A	5728	0,9	306
Turbo Cut B&S	BR6S	3522	0,7	
<b>KOHLER</b>				
CH 5	BCPR5ES	6130	0,7	



Order  
No.Quick  
No.**KOHLER**

CH 6	BCPR5ES	6130	0,7	
CH 18	BCPR5ES	6130	0,7	
CH 20	BCPR5ES	6130	0,7	
CH 22	BCPR5ES	6130	0,7	
CH 25	BCPR5ES	6130	0,7	
CV 11	BCPR5ES	6130	0,7	
CV 12,5	BCPR5ES	6130	0,7	
CV 14	BCPR5ES	6130	0,7	
CV 18	BCPR5ES	6130	0,7	
CV 20	BCPR5ES	6130	0,7	
CV 22	BCPR5ES	6130	0,7	
K 91	B6S	3510	0,6	302
K 141	B6S	3510	0,6	302
K 161	B6S	3510	0,6	302
K 181	B6S	3510	0,6	302
K 241	B6L	3212	0,6	
K 301	B6L	3212	0,6	
K 321	B6L	3212	0,6	
K 341	B6L	3212	0,6	
K 361	B6L	3212	0,6	
K 482	B6L	3212	0,6	
K 532	B6L	3212	0,6	
K 582	B6L	3212	0,6	
KT 17	BPR4FS	1127	0,7	
KT 19	BPR4FS	1127	0,7	
KT 21	BPR4FS	1127	0,7	
M 8	BMR6A	7421	0,7	307
M 10	B6L	3212	0,7	
M 12	B6L	3212	0,7	
M 14	B6L	3212	0,7	
M 16	B6L	3212	0,7	
M 18	BPR4FS	1127	0,7	
M 20	BPR4FS	1127	0,7	
MV 16	BPR4FS	1127	0,7	
MV 18	BPR4FS	1127	0,7	
MV 20	BPR4FS	1127	0,7	

**KYNAST**

Mot. B&S	B4LM	3410	0,6	301
Mot. F&S	B4H	4110	0,6	

**LAWNBOY**

B&S engine	B6S	3510	0,8	302
Mot. Tecumseh	BM6A	5921	0,6	303
O.M.C. engine 09.76-	B4	3210	0,6	
O.M.C. engine -09.76	BMR4A	5728	0,9	306
Solid state ignition	BMR4A	5728	0,9	306

**LAWNMASTER**

18" Rotary Johnson 2 stroke Iron Horse D401+ D500	B2	3110	0,6	
18" Rotary 92900 3,5 HP B&S	B6S	3510	0,8	302
19" Rotary B&S 3HP 500 80202	B6S	3510	0,8	302



Order No.  Quick No.

### LAWNMASTER

19" Rotary B&S 3,5HP	BMR6A	7421	0,6	307
19" Rotary B&S 3,5HP 480 Keystarter	BMR6A	7421	0,6	307
19" Rotary B&S 2HP 350 60102	B6S	3510	0,8	302
19" Rotary 500 Contractor Kawasaki KF34D	B6S	3510	0,8	302
19" Rotary B&S 480.4 110900	BMR6A	7421	0,6	307
19" Rotary B&S 3HP 500 80302	B6S	3510	0,8	302
19" Rotary Iron Horse F serie 480.2F	BMR4A	5728	0,9	306
19" Rotary B&S 2HP 400 60102	B6S	3510	0,8	302
500 Golf B&S 100202 4HP	B6S	3510	0,8	302
500 Golf 600 Kawasaki 34D 3,5HP	B6S	3510	0,8	302
V.I.C. Spezial B&S 3,5HP	BMR6A	7421	0,6	307
500 Golf Tecumseh 3.5HP TSV 661 2Ventil	B6S	3510	0,8	302

### LEOPARD

Mot. Aspera	B4LM	3410	0,6	301
Mot. B&S	B4LM	3410	0,6	301

### MARUYAMA

MC 260 / C / S / E / D	Multischneider	BPM6Y	4562	0,6
MC 261	Multischneider	BPM6Y	4562	0,6

### MONARK

Mot. Aspera	B4LM	3410	0,6	301
Mot. B&S	B4LM	3410	0,6	301
Mot. Suffolk	B6S	3510	0,6	302

### MOUNTFIELD

Mot. B & S , Tecumseh , Aspera	B6S	3510	0,5	302
Mot. Suzuki 2Takt	BPMR4A	6028	0,7	
Mot. Suzuki 4Takt	BPR6ES	7822	0,8	

### MTD

Cub Cadet B&S Intek Motoren	BKR5E	7938	0,7	
Cub Cadet B&S Standard/IC-Motoren	BR2LM	5798	0,7	310
Cub Cadet B&S Vanguard/Europa OHV Motoren	BKR5E	7938	0,7	
Cub Cadet Tecumseh Standard/Seitengesteuerte Motoren	BR2LM	5798	0,7	310
Cub Cadet Tecumseh OHV Motoren	BR7ES	5122	0,7	
Cub Cadet Kohler Comand CV/CH 11--16	BKR5E-11	6953	1,1	
Cub Cadet Kohler Comand CV/CH 18--25	BKR5E	7938	0,7	
Cub Cadet Kawasaki Typ FG 230 D CS 50	BP4HS	3611	0,6	
Cub Cadet Kawasaki Typ FE 250 D	BPR5ES	7422	0,6	
Cub Cadet B&S Graugußmotoren	BR2LM	5798	0,7	310
Gutbrod B&S Graugußmotoren	BR2LM	5798	0,7	310
Gutbrod Kawasaki Typ FE 250 D	BPR5ES	7422	0,6	
Gutbrod B&S Standard/IC-Motoren	BR2LM	5798	0,7	310
Gutbrod B&S Vanguard/Europa OHV Motoren	BKR5E	7938	0,7	
Gutbrod Tecumseh Standard/Seitengesteuerte Motoren	BR2LM	5798	0,7	310
Gutbrod Tecumseh OHV Motoren	BR7ES	5122	0,7	
Gutbrod Kohler Comand CV/CH 11--16	BKR5E-11	6953	1,1	
Gutbrod Kohler Comand CV/CH 18--25	BKR5E	7938	0,7	
Gutbrod B&S Intek Motoren	BKR5E	7938	0,7	
Gutbrod Kawasaki Typ FG 230 D CS 50	BP4HS	3611	0,6	

Order  
No.Quick  
No.**MTD**

Mot.	B&S	B4LM	3410	0,6	301
White	Kawasaki Typ FE 250 D	BPR5ES	7422	0,6	
White	B&S Graugußmotoren	BR2LM	5798	0,7	310
White	B&S Vanguard/Europa OHV Motoren	BKR5E	7938	0,7	
White	B&S Intek Motoren	BKR5E	7938	0,7	
White	Tecumseh Standard/Seitengesteuerte Motoren	BR2LM	5798	0,7	310
White	Tecumseh OHV Motoren	BR7ES	5122	0,7	
White	Kohler Comand CV/CH 11--16	BKR5E-11	6953	1,1	
White	Kohler Comand CV/CH 18--25	BKR5E	7938	0,7	
White	Kawasaki Typ FG 230 D CS 50	BP4HS	3611	0,6	
White	B&S Standard/IC-Motoren	BR2LM	5798	0,7	310
Yard Machines	B&S Vanguard/Europa OHV Motoren	BKR5E	7938	0,7	
Yard Machines	Kawasaki Typ FE 250 D	BPR5ES	7422	0,6	
Yard Machines	Kawasaki Typ FG 230 D CS 50	BP4HS	3611	0,6	
Yard Machines	Kohler Comand CV/CH 18--25	BKR5E	7938	0,7	
Yard Machines	Kohler Comand CV/CH 11--16	BKR5E-11	6953	1,1	
Yard Machines	Tecumseh OHV Motoren	BR7ES	5122	0,7	
Yard Machines	B&S Intek Motoren	BKR5E	7938	0,7	
Yard Machines	B&S Graugußmotoren	BR2LM	5798	0,7	310
Yard Machines	B&S Standard/IC-Motoren	BR2LM	5798	0,7	310
Yard Machines	Tecumseh Standard/Seitengesteuerte Motoren	BR2LM	5798	0,7	310
Yard Man	Kawasaki Typ FE 250 D	BPR5ES	7422	0,6	
Yard Man	B&S Standard/IC-Motoren	BR2LM	5798	0,7	310
Yard Man	B&S Graugußmotoren	BR2LM	5798	0,7	310
Yard Man	B&S Vanguard/Europa OHV Motoren	BKR5E	7938	0,7	
Yard Man	B&S Intek Motoren	BKR5E	7938	0,7	
Yard Man	Tecumseh Standard/Seitengesteuerte Motoren	BR2LM	5798	0,7	310
Yard Man	Tecumseh OHV Motoren	BR7ES	5122	0,7	
Yard Man	Kohler Comand CV/CH 11--16	BKR5E-11	6953	1,1	
Yard Man	Kawasaki Typ FG 230 D CS 50	BP4HS	3611	0,6	
Yard Man	Kohler Comand CV/CH 18--25	BKR5E	7938	0,7	

**NORLETT**

Mot. Aspera		B4LM	3410	0,6	301
Mot. B&S		B4LM	3410	0,6	301

**PARTNER**

11- 90 E	Aufsitzmäher	BR4LM	4133	0,5	
12- 90 EH	Aufsitzmäher	BR4LM	4133	0,5	
12-100 E	Aufsitzmäher	BR4LM	4133	0,5	
13- 90 EH	Aufsitzmäher	BR4LM	4133	0,5	
13-105 E	Aufsitzmäher	BR4LM	4133	0,5	
14-105 E	Aufsitzmäher	BR4LM	4133	0,5	
14-105 EH	Aufsitzmäher	BR4LM	4133	0,5	
146		BR2LM	5798	0,5	310
146 C		BR2LM	5798	0,5	310
146 CD		BR2LM	5798	0,5	310
146 CDE		BR2LM	5798	0,5	310
146 E		BR2LM	5798	0,5	310
147 C		BR2LM	5798	0,5	310
147 CD		BR2LM	5798	0,5	310
147 CDE		BR2LM	5798	0,5	310



Order No.  Quick No.

				<b>PARTNER</b>		
147 T			BR2LM	5798	0,7	310
148 CD			BR2LM	5798	0,5	310
15-105 EH		Aufsitzmäher	BR4LM	4133	0,5	
150			BR2LM	5798	0,5	310
150 D			BR2LM	5798	0,7	310
150 D			BR2LM	5798	0,5	310
150 H			BR2LM	5798	0,7	310
155 CD			BR2LM	5798	0,5	310
155 CDE			BR2LM	5798	0,5	310
155 D			BR2LM	5798	0,5	310
246			BR2LM	5798	0,5	310
348			BR2LM	5798	0,5	310
350			BR2LM	5798	0,5	310
445 D			BR2LM	5798	0,5	310
550			BR2LM	5798	0,5	310
555 D			BR2LM	5798	0,5	310
556 DE			BR2LM	5798	0,5	310
K12			BP6HS	4511	0,5	
K12S , K16			BPM7A	7321	0,5	305
K500			BPM7A	7321	0,5	305
K650			BPM7A	7321	0,5	305
K700			BPM7A	7321	0,5	305
K1200			BPM7A	7321	0,5	305
P 115		Aufsitzmäher	BR7ES	5122	0,6	
P 130		Aufsitzmäher	BR2LM	5798	0,5	310
P 214		Balkenmäher	BR2LM	5798	0,5	310
				<b>PHÖNIX</b>		
AM 51 B	B&S		BR2LM	5798	0,7	310
BM 104 B	Tecna	Balkenmäher	BR2LM	5798	0,7	310
BM 104 T	Tecna	Balkenmäher	BR2LM	5798	0,7	310
BM 200 T	Tecna	Balkenmäher	BR2LM	5798	0,7	310
PXR 40	B&S		BR2LM	5798	0,7	310
PXR 45 / R	Tecna		BR2LM	5798	0,7	310
PXR 48	B&S		BR2LM	5798	0,7	310
PXR 48 RHV	Honda		BPR5ES	7422	0,7	
PXR 48 RV	B&S		BR2LM	5798	0,7	310
PXR 48 RVE	B&S		BR2LM	5798	0,7	310
PXR 55 RV	B&S		BR2LM	5798	0,7	310
Twin Cut 12,5	B&S		BR2LM	5798	0,7	310
Twin Cut 15,5	B&S		BR2LM	5798	0,7	310
Twin Cut 16	B&S		BCPR5ES	6130	0,7	
				<b>QUEEN GARDEN</b>		
Mot. Aspera			B4LM	3410	0,6	301
				<b>ROBIN MOTOREN</b>		
EC02EHR			BM7A	6521	0,6	
EC08D/B			B7HS	5110	0,6	204
EC12D/B			BM6A	5921	0,6	303
EH12D/B			B6HS	4510	0,6	203
EH17D/B			B6HS	4510	0,6	203

Order  
No.Quick  
No.**ROBIN MOTOREN**

EH25D/B		<b>B6HS</b>	<b>4510</b>	0,6	<b>203</b>
EH30D/B		<b>BP6ES</b>	<b>7811</b>	0,8	
EH34D/B		<b>BP6ES</b>	<b>7811</b>	0,8	
EY08D/B		<b>BM4A</b>	<b>5628</b>	0,6	
EY15D/B		<b>B6HS</b>	<b>4510</b>	0,6	<b>203</b>
EY20D/B		<b>B6HS</b>	<b>4510</b>	0,6	<b>203</b>
EY23D/B		<b>BP4HS</b>	<b>3611</b>	0,6	
EY28D/B		<b>BP6HS</b>	<b>4511</b>	0,6	
EY35D/B		<b>B6HS</b>	<b>4510</b>	0,6	<b>203</b>
EY40D/B		<b>B6HS</b>	<b>4510</b>	0,6	<b>203</b>

**SABO**

37-2TH	Robin EC 04-3V		<b>BR6HS</b>	<b>3922</b>	0,6	
38-BV	B&S	Vertikutierer	<b>BR4LM</b>	<b>4133</b>	0,7	
43-2TH	Suzuki V140X		<b>BPMR4A</b>	<b>6028</b>	0,6	
43-4		Vertikutierer	<b>BR2LM</b>	<b>5798</b>	0,6	<b>310</b>
43-4			<b>BR2LM</b>	<b>5798</b>	0,6	<b>310</b>
43-4 A			<b>BR2LM</b>	<b>5798</b>	0,6	<b>310</b>
43-4 EA			<b>BR2LM</b>	<b>5798</b>	0,6	<b>310</b>
43-4TE m.A.	B&S 3 HP		<b>BR2LM</b>	<b>5798</b>	0,6	<b>310</b>
43-4TH	B&S 3 HP		<b>BR2LM</b>	<b>5798</b>	0,6	<b>310</b>
43-4TH m.A.	B&S		<b>BR2LM</b>	<b>5798</b>	0,6	<b>310</b>
43-4THE	Tecna BV153ES		<b>BR6S</b>	<b>3522</b>	0,6	
43-4THE m.A.	Tecna BV153ES		<b>BR6S</b>	<b>3522</b>	0,6	
43-4TS	B&S 3 HP		<b>BR2LM</b>	<b>5798</b>	0,6	<b>310</b>
43-4TSH m.A.	Suzuki V140X		<b>BPR6ES</b>	<b>7822</b>	0,8	
43-96	F&S SB93		<b>B4H</b>	<b>4110</b>	0,7	
43-96H	F&S SB93		<b>B4H</b>	<b>4110</b>	0,7	
43-130	F&S SB130		<b>BP4</b>	<b>2911</b>	0,6	
43-130H	F&S SB130		<b>BP4</b>	<b>2911</b>	0,6	
43-130H m.A.	F&S SB130		<b>BP4</b>	<b>2911</b>	0,6	
43-190	B&S Quantum 4,5 HP		<b>BR2LM</b>	<b>5798</b>	0,6	<b>310</b>
43-OHV / A			<b>BPR5ES</b>	<b>7422</b>	0,6	
43-QHE m.A.	B&S Quantum 3,5 HP		<b>BR2LM</b>	<b>5798</b>	0,6	<b>310</b>
43-S 4		Vertikutierer	<b>BR2LM</b>	<b>5798</b>	0,6	<b>310</b>
43-S 4			<b>BR2LM</b>	<b>5798</b>	0,6	<b>310</b>
43-S 4 A			<b>BR2LM</b>	<b>5798</b>	0,6	<b>310</b>
47-2A	F&S SB140SL		<b>BP4</b>	<b>2911</b>	0,6	
47-4	B&S XM 40		<b>BR2LM</b>	<b>5798</b>	0,6	<b>310</b>
47-4 BCA			<b>BR4LM</b>	<b>4133</b>	0,7	
47-4A	B&S XM 40		<b>BR2LM</b>	<b>5798</b>	0,6	<b>310</b>
47-4EA	B&S XM 40		<b>BR2LM</b>	<b>5798</b>	0,6	<b>310</b>
47-Kat A			<b>BR2LM</b>	<b>5798</b>	0,6	<b>310</b>
47-OHV	B&S Europa OHV		<b>BR6ES</b>	<b>4922</b>	0,6	
47-OHV A			<b>BPR5ES</b>	<b>7422</b>	0,6	
47-OHV A	B&S Europa OHV		<b>BR6ES</b>	<b>4922</b>	0,6	
47-OHV EA	B&S Europa OHV		<b>BR6ES</b>	<b>4922</b>	0,6	
47-OHVE A			<b>BPR5ES</b>	<b>7422</b>	0,6	
50-126 m.A.	F&S SB126		<b>B5HS</b>	<b>4210</b>	0,6	
50-126H m.A.	F&S SB126		<b>B5HS</b>	<b>4210</b>	0,6	
50-4 TH	B&S 3,5 HP		<b>BR2LM</b>	<b>5798</b>	0,6	<b>310</b>
50-4 TH m.A.	B&S 3,5 HP		<b>BR2LM</b>	<b>5798</b>	0,6	<b>310</b>



Order No.  Quick No.

<b>SABO</b>					
50-4 TL	B&S 3,5 HP		BR2LM	5798	0,6 310
50-4 TL m.A.	B&S 3,5 HP		BR2LM	5798	0,6 310
52-4 TL m.A.			BR2LM	5798	0,6 310
52-140 m.A.	F&S SB140		BP4	2911	0,6
52-140H	F&S SB140		BP4	2911	0,6
52-152 H m.A.			B5HS	4210	0,6
52-152 m.A.			B5HS	4210	0,5
52-OHV A			BPR5ES	7422	0,6
76-320			BMR6A	7421	0,6 307
Clipper 52		Aufsitzmäher	BCPR5ES	6130	0,7
<b>SABRE</b>					
Trike 31& 42	B&S 8HP		BMR6A	7421	0,6 307
Honda GV 400 11HP			BMR6A	7421	0,6 307
<b>SOLO</b>					
102			BM7A	6521	0,6
103			BM7A	6521	0,6
106			BM7A	6521	0,6
107			BM7A	6521	0,6
111			BM7A	6521	0,6
114			BM7A	6521	0,6
545			B4LM	3410	0,5 301
518		Vertikutierer	BR2LM	5798	0,5 310
520			B6HS	4510	0,5 203
522	B & S	Balkenmäher	BMR6A	7421	0,5 307
530		Balkenmäher	BR2LM	5798	0,5 310
531 1999-2000		Balkenmäher	BP6ES	7811	0,7
531 1998-1999		Balkenmäher	BR2LM	5798	0,5 310
532		Balkenmäher	BPR6ES	7822	0,7
543			B5HS	4210	0,5
543L			B5HS	4210	0,5
545			BR2LM	5798	0,5 310
545 R			BR2LM	5798	0,5 310
546 , 546R , 546ZR / 546Z	B & S		BMR6A	7421	0,5 307
546 HR			BPR5ES	7422	0,7
546S , 546RS	Tec.		BR6S	3522	0,5
548 R			BPR5ES	7422	0,7
549			B6HS	4510	0,5 203
549 Profit			B6HS	4510	0,6 203
550 / 550R / 550RS	B & S		BMR6A	7421	0,5 307
550H / 550HR	Honda		BP5ES	6511	0,5
551 , 551R	Tec.		BR6S	3522	0,5
551ZR	B & S		BMR6A	7421	0,5 307
552HR	Honda		BP5ES	6511	0,5
552R	B & S		BCPR5ES	6130	0,7
552Z , 552ZR	F & S		B5HS	4210	0,5
553 S			BKR5ES	2460	0,6
553SL	Honda		BPR5ES	7422	0,5
554	B & S		BMR6A	7421	0,5 307
554Z	B & S		BMR6A	7421	0,5 307
555 Sidevalve		Aufsitzmäher	BKR5ES	2460	0,6

Order  
No.Quick  
No.**SOLO**

555 OHV	Aufsitzmäher	BR2LM	5798	0,5	310
556 OHV	Aufsitzmäher	BR2LM	5798	0,5	310
556 Sidevalve	Aufsitzmäher	BKR5ES	2460	0,6	
557 OHV	Aufsitzmäher	BR2LM	5798	0,5	310
557 Sidevalve	Aufsitzmäher	BKR5ES	2460	0,6	
558 Sidevalve	Aufsitzmäher	BKR5ES	2460	0,6	
558 OHV	Aufsitzmäher	BR2LM	5798	0,5	310
560 OHV	Aufsitzmäher	BR2LM	5798	0,5	310
560 Sidevalve	Aufsitzmäher	BKR5ES	2460	0,6	
562 OHV	Aufsitzmäher	BR2LM	5798	0,5	310
562 Sidevalve	Aufsitzmäher	BKR5ES	2460	0,6	
563/L		B6HS	4510	0,5	203
570 Sidevalve	Aufsitzmäher	BKR5ES	2460	0,6	
570 OHV	Aufsitzmäher	BR2LM	5798	0,5	310
572 Sidevalve	Aufsitzmäher	BKR5ES	2460	0,6	
576 OHV	Aufsitzmäher	BKR5ES	2460	0,6	
575 OHV	Aufsitzmäher	BKR5ES	2460	0,6	
577		B5HS	4210	0,6	
581		B5HS	4210	0,5	
581 Piano		B5HS	4210	0,6	
582	B&S	BR2LM	5798	0,5	310
585 HM		BR2LM	5798	0,5	310
585	B & S	BMR6A	7421	0,5	307
Mot.	Aspera	B4LM	3410	0,6	301
Piano 549		B6HS	4510	0,5	203

**STARK**

Mot.	B&S	BM6A	5921	0,6	303
------	-----	------	------	-----	-----

**STIHL-STIGA**

BA20		B6S	3510	0,5	302
CB700		BM6A	5921	0,5	303
Park 20008 , Privat 8E		BM6A	5921	0,5	303
President, CB700, Pony 6, 8		BM6A	5921	0,5	303
RA Dino 2T		B6S	3510	0,5	302
RB Dino 4T		BM6A	5921	0,5	303
SB50 Vario-speed, BB800		BM6A	5921	0,5	303
Tornado TB300 , Tornado TB500		BM6A	5921	0,5	303

**SUFFOLK**

12" Colt 1959-1967		B6S	3510	0,6	302
12" Super Colt		B6S	3510	0,6	302
14" Super Punch		B6S	3510	0,6	302
14" Serie 1/1A/2/3/4/5/6/7		B6S	3510	0,6	302
16" Suffolk		B6S	3510	0,6	302
16" Demon de luxe		B6S	3510	0,6	302
17" Super Punch Serie 1/2/3/4/5/6/		B6S	3510	0,6	302
19" Demon de luxe		B6S	3510	0,6	302
19" Squire Serie 1//2/3		B6S	3510	0,6	302
19" Side Wheel Mower MK 1/ 2		B6S	3510	0,6	302
Pony 2Ventil Serie 1 / 2		BR5HS	3722	0,6	



Order No.  Quick No.

## TECUMSEH

A 220 4,8PS 95-	BR2LM	5798	0,6	310
ALN 330 7,2PS 95-	BR2LM	5798	0,6	310
BH 37	BR2LM	5798	0,6	310
BH 153	BR4LM	4133	0,6	
BH 173	BR4LM	4133	0,6	
BH 35 3,5PS 95-	BR2LM	5798	0,6	310
BH 40 4PS Konische Ausführung 95-	BR2LM	5798	0,6	310
BH 40 4PS Zylindrische Ausfüh. 95-	BR2LM	5798	0,6	310
BV 153	BR2LM	5798	0,6	310
BVL 153	BR2LM	5798	0,6	310
BVL 173	BR4LM	4133	0,6	
BVL 198	BR4LM	4133	0,6	
BVS 143	BR2LM	5798	0,6	310
BVS 153	BR2LM	5798	0,6	310
H 35	BR4LM	4133	0,6	
H 50	BR4LM	4133	0,6	
H 60	BR4LM	4133	0,6	
H 70	BR4LM	4133	0,6	
H 80	BR4LM	4133	0,6	
HH 100	B6HS	4510	0,6	203
HM 70	BR4LM	4133	0,6	
HM 80	BR4LM	4133	0,6	
HM 100	BR4LM	4133	0,6	
HM 100 10PS 95-	BR2LM	5798	0,6	310
HMXL 80 8PS 95-	BR2LM	5798	0,6	310
HS 40	BR4LM	4133	0,6	
HS 50	BR4LM	4133	0,6	
HS 50 5PS Hand+Fernbedienung 95-	BR2LM	5798	0,6	310
LAV 35	BR4LM	4133	0,6	
LAV 40	BR4LM	4133	0,6	
LAV 50	BR4LM	4133	0,6	
MV 100	BR4LM	4133	0,6	
MV 100 S	BR4LM	4133	0,6	
MV 100 S 3,5PS 95-	BR2LM	5798	0,6	310
OH 120	B6HS	4510	0,6	203
OH 140	B6HS	4510	0,6	203
OH 160	B6HS	4510	0,6	203
OH 180	B6HS	4510	0,6	203
OHV 4Takt 12,5PS 95-	B7S	3710	0,6	
OVM	B6HS	4510	0,6	203
OVRM 40	BR7ES	5122	0,6	
OVRM 50	BR7ES	5122	0,6	
OVXL 120	B6HS	4510	0,6	203
OVXL-C 125	B6HS	4510	0,6	203
Premier 45 OHV	BR4LM	4133	0,6	
Premier 55 OHV	BR7ES	5122	0,6	
Premier 153	BR4LM	4133	0,6	
Premier 173	BR4LM	4133	0,6	
Prisma	BR4LM	4133	0,6	
Prisma 3,7PS 95-	BR2LM	5798	0,6	310
Prisma 5PS 95-	BR2LM	5798	0,6	310
Prisma Elektrostart	BR4LM	4133	0,6	



Order  
No.Quick  
No.**TECUMSEH**

RV 173	BR4LM	4133	0,6	
Synergy 40	BR4LM	4133	0,6	
Synergy 40	BR2LM	5798	0,6	310
Synergy 40 4PS 95-	BR2LM	5798	0,6	310
Synergy 55 OHV	BR7ES	5122	0,6	
Synergy OHV	BR7ES	5122	0,6	
TNT 100	BR4LM	4133	0,6	
TNT 120	BR4LM	4133	0,6	
TVM 140	BR4LM	4133	0,6	
TVM 170	BR4LM	4133	0,6	
TVM 195	BR4LM	4133	0,6	
TVM 220	BR4LM	4133	0,6	
TVS 75	BR4LM	4133	0,6	
TVS 90	BR4LM	4133	0,6	
TVS 105	BR4LM	4133	0,6	
TVS 115	BR4LM	4133	0,6	
TVS 120	BR4LM	4133	0,6	
TVXL	BR4LM	4133	0,6	
TVXL 195 4Takt 8PS 95-	BR2LM	5798	0,6	310
TVXL 840 5PS 95-	BR2LM	5798	0,6	310
V 50	BR4LM	4133	0,6	
V 60	BR4LM	4133	0,6	
V 70	BR4LM	4133	0,6	
V 80	BR4LM	4133	0,6	
Vantage	BR4LM	4133	0,6	
Vantage 3,5PS 95-	BR2LM	5798	0,6	310
Vantage 35	BR4LM	4133	0,6	
Vantage 40	BR4LM	4133	0,6	
VM 70	BR4LM	4133	0,6	
VM 80	BR4LM	4133	0,6	
VM 100	BR4LM	4133	0,6	

**TORO**

Kohler K141 , K181	BR6S	3522	0,6	
Kohler K321 , K532 , K582, M14	B6L	3212	0,6	
Kohler KT17	B6L	3212	0,6	
Mot. Aspera	B4LM	3410	0,6	301
Mot. B&S	B2LM	1147	0,6	
Mot. Chev 250cu in	BR5FS	4123	0,8	
Mot. Echo	BMR6A	7421	0,6	307
Mot. Kioritz	BM6A	5921	0,6	303
Mot. Onan	BR6ES	4922	0,8	
Mot. Suzuki 2 stroke	BPMR4A	6028	0,7	
Mot. Suzuki 4 stroke	BMR6A	7421	0,6	307
Mot. Tecumseh	B4	3210	0,6	
Mot. Toro	BM6A	5921	0,6	303
Mot. Toro 18 mm	A6	1010	0,6	

**TOURNO**

95 (GCV 520 Honda)	Frontmäher	BPR5ES	7422	0,5	
115 (GCV 520 Honda)	Frontmäher	BPR5ES	7422	0,5	



Order No.  Quick No.

## VIKING

MB 650 V	OHV Motor		BKR5ES	2460	0,7	
MB 650 VM	OHV Motor		BKR5ES	2460	0,7	
MB 650 VQ	OHV Motor		BKR5ES	2460	0,7	
MB 650 VS	OHV Motor		BKR5ES	2460	0,7	
MB 655 KS	OHV Motor		BKR5ES	2460	0,7	
MB 650 T	OHV Motor		BKR5ES	2460	0,7	
FM 350		Balkenmäher	BR2LM	5798	0,6	310
FM 480		Balkenmäher	BR2LM	5798	0,6	310
FM 590		Balkenmäher	BR2LM	5798	0,6	310
MB 2 R			BR2LM	5798	0,6	310
MB 3 R			BR2LM	5798	0,6	310
MB 400			BR2LM	5798	0,6	310
MB 410			BR2LM	5798	0,6	310
MB 415			BR2LM	5798	0,6	310
MB 443			BR2LM	5798	0,6	310
MB 443 T			BR2LM	5798	0,6	310
MB 448			BR2LM	5798	0,6	310
MB 448 T			BR2LM	5798	0,6	310
MB 450 / M			BR2LM	5798	0,6	310
MB 455 / E / M			BR2LM	5798	0,6	310
MB 455 BC			BR2LM	5798	0,6	310
MB 460			BR2LM	5798	0,6	310
MB 465			BR2LM	5798	0,6	310
MB 500			BR2LM	5798	0,6	310
MB 505 / E			BR2LM	5798	0,6	310
MB 505 BS			BR2LM	5798	0,6	310
MB 505 S			BR2LM	5798	0,6	310
MB 555 / E			BR2LM	5798	0,6	310
MB 555 BS			BR2LM	5798	0,6	310
MB 555 M			BR2LM	5798	0,6	310
MB 555 S			BR2LM	5798	0,6	310
MB 6 RC			BR2LM	5798	0,6	310
MR 210		Aufsitzmäher	BCPR5ES	6130	0,7	
MR 210		Aufsitzmäher	BR2LM	5798	0,7	310
MT 410		Aufsitzmäher	BCPR5ES	6130	0,7	
MT 420		Aufsitzmäher	BR2LM	5798	0,7	310
MT 540		Aufsitzmäher	BR2LM	5798	0,7	310
MT 640		Aufsitzmäher	BCPR5ES	6130	0,7	
MT 640		Aufsitzmäher	BCPR5ES	6130	0,7	
MT 680		Aufsitzmäher	BCPR5ES	6130	0,7	
MT 680		Aufsitzmäher	BCPR5ES	6130	0,7	
RL 455 B		Vertikutierer	BR2LM	5798	0,6	310

## VOGEL & NOOT

Mot. Bombardier Rotax		A6	1010	0,5	
Mot. MAG		B4	3210	0,5	

## WOLF

Cart OHC 2		Aufsitzmäher	BPR5ES	7422	0,8	
Cart SV3		Aufsitzmäher	BR2LM	5798	0,6	310
Concept 43 BA			BR2LM	5798	0,6	310
Concept 43 BAI			BR2LM	5798	0,6	310

Order  
No.Quick  
No.**WOLF**

Concept 43 BPP		BR2LM	5798	0,6	310
Concept 47 BA		BR2LM	5798	0,6	310
Concept 47 BAM		BR2LM	5798	0,6	310
Esprit 40 B		BR7ES	5122	0,6	
Esprit 46 B		BR7ES	5122	0,6	
Esprit 46 BA		BR7ES	5122	0,6	
Mot. Aspera		B4LM	3410	0,6	301
Mot. B&S		B4LM	3410	0,6	301
Mot. F&S 14 mm		B6HS	4510	0,6	203
Mot. F&S 18 mm		A6	1010	0,5	
Mot. Hirth 14 mm		B6HS	4510	0,6	203
Mot. Hirth 18 mm		A7	1110	0,5	
PC-FEL	Aufsitzmäher	BMR6A	7421	0,7	307
PC-FL	Aufsitzmäher	BMR6A	7421	0,7	307
PG 47 SL		A6	1010	0,6	
Premio 40 B		BR7ES	5122	0,6	
Premio 40 BA		BR7ES	5122	0,6	
Premio 46 B		BR7ES	5122	0,6	
Premio 46 BA		BR7ES	5122	0,6	
Premio 46 Bai		BR7ES	5122	0,6	
PRO 46		BP4	2911	0,5	
PRO 51		BP4	2911	0,5	
PRO 61		BP4	2911	0,5	
Scooter OHV3	Aufsitzmäher	BR7ES	5122	0,6	
Scooter SV4	Aufsitzmäher	BR2LM	5798	0,6	310
TA 40 CA		BMR6A	7421	0,7	307
TA 40 CF		BP4	2911	0,5	
TA 40 S		BMR6A	7421	0,7	307
TA 40 SF		BP4	2911	0,5	
TA 40 SI		BMR6A	7421	0,7	307
TA 42 SB		BMR6A	7421	0,7	307
TA 42 SF		BP4	2911	0,5	
TA 42 SI		BMR6A	7421	0,7	307
TA 42 SI		BMR6A	7421	0,7	307
TA 42 SM		BMR6A	7421	0,7	307
TA 46 MB		BM6A	5921	0,7	303
TA 52 CB		BMR6A	7421	0,7	307
TA 52 CT		BMR6A	7421	0,7	307
TA 52 SF		BP4	2911	0,5	
TA 52 SI		BMR6A	7421	0,7	307
TA 52 SK		BPR6ES	7822	0,6	
TA 52 SM		BMR6A	7421	0,7	307
TA 52 SO		BR6ES	4922	0,6	
TA 52 ST		BMR6A	7421	0,7	307
TA 52 WB		BM6A	5921	0,7	303
TA 52 WS		B5HS	4210	0,5	
TA 70 S		BMR6A	7421	0,7	307
TA 70 SF		BP4	2911	0,5	
TA 70 SI		BMR6A	7421	0,7	307
TB 40 CBK		BMR6A	7421	0,7	307
TB 40 CFK		BP4	2911	0,5	
TB 40 CL		BMR6A	7421	0,7	307

Order  
No.Quick  
No.**WOLF**

TB 40 CN		BMR6A	7421	0,7	307
TB 40 CS		BP4	2911	0,5	
TB 40 S		BMR6A	7421	0,7	307
TB 40 SF		BP4	2911	0,5	
TB 42 CB		BMR6A	7421	0,7	307
TB 42 CF		BP4	2911	0,5	
TB 42 CT		BMR6A	7421	0,7	307
TB 42 SF		BP4	2911	0,5	
TB 42 SI		BMR6A	7421	0,7	307
TB 42 SM		BMR6A	7421	0,7	307
TB 42 ST		BMR6A	7421	0,7	307
TB 46 MB		BM6A	5921	0,7	303
TB 46 MI		BMR6A	7421	0,7	307
TB 46 RA		BMR6A	7421	0,7	307
TB 46 RB		BMR6A	7421	0,7	307
TB 46 RBL		BMR6A	7421	0,7	307
TB 46 RF		BMR6A	7421	0,7	307
TB 46 VF		BP4	2911	0,5	
TB 50 S		BMR6A	7421	0,7	307
TB 50 SF		BP4	2911	0,5	
TB 52 CB		BMR6A	7421	0,7	307
TB 52 CT		BMR6A	7421	0,7	307
TB 52 SF		BP4	2911	0,5	
TB 70 S		BMR6A	7421	0,7	307
TB 70 SF		BP4	2911	0,5	
TD 38 L		BMR6A	7421	0,7	307
TD 46 L		BMR6A	7421	0,7	307
TG 38 SLE		A6	1010	0,6	
TG 47 SLE		A6	1010	0,6	
TI 38		BMR6A	7421	0,7	307
TI 38 L		BMR6A	7421	0,7	307
TI 46 C		BMR6A	7421	0,7	307
TI 46 L		BMR6A	7421	0,7	307
TL 38 L		BMR6A	7421	0,7	307
TL 47		BMR6A	7421	0,6	307
TR 46		BMR6A	7421	0,7	307
Trac OHV 6	Aufsitzmäher	BPR5ES	7422	0,8	
Trac OHV 7	Aufsitzmäher	BPR5ES	7422	0,8	
TR-SL		BMR6A	7421	0,7	307
UV 38 BX	Vertikutierer	BR7ES	5122	0,6	

**YAMAHA**

YLM 342 P / S / SE / PR / SR / SER		BR4ES	1097	0,8	
YLM 346 P / S / SE / SR / SER		BR4ES	1097	0,6	
YLM 446 P / S / SB / SE / SBE		BPR5ES	7422	0,8	
YLM 453 P / S / SB / SE / SBE		BPR5ES	7422	0,8	
YLM 553 S / SB / SE / SBE		BPR5ES	7422	0,8	
MF 150A / S	Mehrzweckmotor	BP6HS	4511	0,6	
MF 180A / AR / S / SR	Mehrzweckmotor	BP6HS	4511	0,6	
MF 180K / AK / SK	Mehrzweckmotor	BP4HS	3611	0,6	
MF 260A / AR / S / SR	Mehrzweckmotor	BP6HS	4511	0,6	
MF 260K / AK / SK	Mehrzweckmotor	BP4HS	3611	0,6	

Order  
No.Quick  
No.**YAMAHA**

MF 410 / S / SR	Mehrzweckmotor	BP6HS	4511	0,6	
MF 410 SK	Mehrzweckmotor	BP4HS	3611	0,6	
Midori YMM 135	Balkenmäher	BR4ES	1097	0,7	
MT 110 A / AR	Mehrzweckmotor	B7HS	5110	0,6	204
MT 110 VL	Mehrzweckmotor	B7HS	5110	0,6	204
YBC 20 S / 20 D		BPMR6A	6726	0,6	308
YBC 30 D		BPMR6A	6726	0,6	308
YBC 40 D		BPMR6A	6726	0,6	308
YBC 50 D		BPMR6A	6726	0,6	308
YLM 653 S		BPR5ES	7422	0,7	
YLM 653 SB		BPR5ES	7422	0,7	
YT 2300		BCPR5ES	6130	1,0	
YT 3600 M		BR4ES	1097	0,8	
YT 3600 N		BPR4ES	7222	0,8	
YT 6800 N		BPR5HS	6222	0,8	

**YANMAR**

YL-48 (GY35V)		BR4HS	3322	0,7	
YL 480TS / TSE		BR2LM	5798	0,5	310
YL-53 (GE53)		BR4HS	3322	0,7	
YL 530TS / TSE		BR2LM	5798	0,5	310
YL 630TS		BR2LM	5798	0,5	310
YM 12 , 14 (2T75-U)		Y-116V	only OE		

**YARDMAN**

5.0 hp. B&S		BR2LM	5798	0,5	310
5.5 hp Honda		BPR6ES	7822	0,7	
6.0 hp. B&S		BR2LM	5798	0,5	310
6.5 hp. B&S - Intek OHV		BR2LM	5798	0,5	310
6.75 hp B&S Quantum		BKR5ES	2460	0,7	
Tecumseh		B6S	3510	0,6	302

**ZENOAH**

G1A , G1A6	14.9 ccm	Mehrzweckmotor	BM6A	5921	0,6	303
G1E	17.2 ccm	Mehrzweckmotor	BMR6A	7421	0,6	307
G2A	22.5 ccm	Mehrzweckmotor	BM6A	5921	0,6	303
G2A16, G2C	22.5 ccm	Mehrzweckmotor	BM7A	6521	0,6	
G2D , G2D30	22.5 ccm	Mehrzweckmotor	BM7A	6521	0,6	
G3C , G3C76	31.7 ccm	Mehrzweckmotor	B6HS	4510	0,7	203
G3D10,G3D20	31.7 ccm	Mehrzweckmotor	BPM6A	7021	0,6	304
G3E	25.4 ccm	Mehrzweckmotor	BMR6A	7421	0,6	307
G4C, G4C63	37.4 ccm	Mehrzweckmotor	B6HS	4510	0,7	203
G4C76	37.4 ccm	Mehrzweckmotor	B6HS	4510	0,7	203
G5C	52.5 ccm	Mehrzweckmotor	BR6S	3522	0,7	
G5E, G5E2	52.5 ccm	Mehrzweckmotor	B6HS	4510	0,7	203

**ZÜNDAPP**

685-015 , -025 , -045		B4	3210	0,6	
685-055 , -035		B4	3210	0,6	



Order No.  Quick No.

<b>AGRIA</b>					
0300	Rotax	A6	1010	0,5	
3400	MAG	B6HS	4510	0,6	203
3400	Rotax	B6HS	4510	0,6	203
5100	Kawasaki	BMR6A	7421	0,5	307
5200	B&S	BR2LM	5798	0,5	310
5300	B&S	BR2LM	5798	0,5	310
5400	Rotax	A6	1010	0,5	
5500	Rotax 2takt	B6HS	4510	0,6	203
5500	Rotax 4takt	A6	1010	0,5	
<b>AL-KO</b>					
18		BM6A	5921	0,6	303
24		BM6A	5921	0,6	303
33		BM6A	5921	0,6	303
40		BM6A	5921	0,6	303
250		BPM6F	5950	0,6	
BC 300	Homelite	BPMR6F	1270	0,6	
BC 330 T	Kawasaki	BM6A	5921	0,6	303
BC 400 T	Kawasaki	BM6A	5921	0,6	303
HS4300		BPMR6F	1270	0,6	
HS5300		BPMR6F	1270	0,6	
LT 250	Homelite	BPMR6F	1270	0,6	
<b>ALLEN</b>					
20 SDS		BMR6A	7421	0,5	307
BT 19		BPMR6A	6726	0,7	308
BT 22		BMR6A	7421	0,5	307
Deluxe 22		BMR6A	7421	0,5	307
Domestic 22		BMR6A	7421	0,5	307
Mini 17		BMR6A	7421	0,5	307
Mini 22		BMR6A	7421	0,5	307
Mini 23		BM7A	6521	0,7	
Mini 26		BM7A	6521	0,7	
Pro 26		BM7A	6521	0,7	
Pro 37		B6HS	4510	0,6	203
Pro 43		BPMR6A	6726	0,7	308
Reciprocator		BMR6A	7421	0,5	307
Super 22		BM7A	6521	0,7	
Super 657		BMR6A	7421	0,9	307
<b>ALPINA</b>					
160 Green		BM7A	6521	0,5	
160 Green		BM6A	5921	0,6	303
180 Jolly		BM7A	6521	0,5	
180 Jolly		BM7A	6521	0,6	
200 Prof		BPMR7A	4626	0,5	309
200 Prof		BPM7A	7321	0,6	305
210 Flex		BM7A	6521	0,5	
210 Flex		BM7A	6521	0,6	
232		BPMR7A	4626	0,5	309
232 / 238 / 332 / 338		BPM7A	7321	0,6	305
238		BPMR7A	4626	0,5	309

Order  
No.Quick  
No.**ALPINA**

332	BPMR7A	4626	0,5	309
338	BPMR7A	4626	0,5	309
540 i	BPMR7A	4626	0,5	309
540i / 600i	BPM7A	7321	0,6	305
600 i	BPMR7A	4626	0,5	309
Elite Sickle Bar	B6S	3510	0,7	302
VIP 21 NG	BPMR7A	4626	0,7	309
VIP 21 NG	BPM7A	7321	0,6	305
VIP 25 DG	BPMR7A	4626	0,7	309
VIP 25 DG	BPM7A	7321	0,6	305
VIP 34 DG	BPM7A	7321	0,6	305
VIP 34 DG	BPMR7A	4626	0,7	309
VIP 42 DG	BPMR7A	4626	0,7	309
VIP 42 DG	BPM7A	7321	0,6	305

**BLACK & DECKER**

BDP 175	BPM6F	5950	0,7	
BDP 185	BPM6F	5950	0,7	
BDP 285	BPM6F	5950	0,7	
BDP 385	BPM6F	5950	0,7	
CS 26012	BPM6F	5950	0,7	
CS 31014	BPM6F	5950	0,7	
CS 31016	BPM6F	5950	0,7	
GB 155	BPM6F	5950	0,7	

**BLITZ**

27S / D / T	BPM7A	7321	0,6	305
33S / T	BPM7A	7321	0,6	305
40S / T	BPM7A	7321	0,6	305

**DANARM**

TM 10C	BM6A	5921	0,6	303
TM 20	BM6A	5921	0,6	303
TM 30 B	BM4A	5628	0,6	
Tornado 18E / 24E / 33E / 40E / 50E	BM6A	5921	0,6	303
Whipper 16 Mk3	BM6A	5921	0,6	303
Whipper 18 E	BM6A	5921	0,6	303

**DOLMAR**

BC-210	BMR6F	2144	0,5	
BC-212	BMR6F	2144	0,5	
BC-250	BPMR6F	1270	0,5	
BC-330	BPMR6F	1270	0,5	
BC-400	BPMR6F	1270	0,5	
LT-210	BMR6F	2144	0,5	
LT-250	BMR7A	4226	0,5	
LT-30	BPMR7A	4626	0,5	309
MS-220	BMR7A	4226	0,5	
MS-2300	BMR7A	4226	0,5	
MS-25 C	BPMR7A	4626	0,5	309
MS-25 U	BPMR6A	6726	0,6	308
MS-250	BMR7A	4226	0,5	



Order No.  Quick No.

## DOLMAR

MS-250.4	CMR6A	1223	0,5	
MS-2600	BPMR7A	4626	0,5	309
MS-290 C	BPMR7A	4626	0,5	309
MS-290 U	BPMR7A	4626	0,5	309
MS-30 C	BPMR7A	4626	0,5	309
MS-30 U	BPMR7A	4626	0,5	309
MS-3100	BMR7A	4226	0,5	
MS-3200	BPMR7A	4626	0,5	309
MS-3300	BPMR7A	4626	0,5	309
MS-3310	BPMR7A	4626	0,5	309
MS-340	BPMR7A	4626	0,6	309
MS-4000	BPMR7A	4626	0,5	309
MS-4010	BPMR7A	4626	0,5	309
MS-4500	BPMR7A	4626	0,5	309
MS-4510	BPMR7A	4626	0,5	309

## ECHO

CLS-4600	BPM7A	7321	0,6	305
CSAH 302	BMR6A	7421	0,6	307
DM 9	BMR6A	7421	0,6	307
GT 160	BM6A	5921	0,6	303
GT 160A	BMR6A	7421	0,6	307
GT 200	BMR6A	7421	0,6	307
GT 2010	BPM7A	7321	0,6	305
GTL 140A / B	BMR6A	7421	0,6	307
HC 140	BMR6A	7421	0,6	307
HC 160	BMR6A	7421	0,6	307
HC 200	BMR6A	7421	0,6	307
HC 210E	BMR6A	7421	0,6	307
HT 200	BMR6A	7421	0,6	307
PB 9	BR6S	3522	0,6	
PB 200	BMR6A	7421	0,6	307
PB 202	BMR6A	7421	0,6	307
PB 400 / E	BMR6A	7421	0,6	307
PE 2400	BPM7Y	4921	0,6	
RM 303E	BM6A	5921	0,6	303
RM 310	BPM7A	7321	0,6	305
RM 380	BPM7A	7321	0,6	305
RMA 2530	BPM7A	7321	0,6	305
SRA 2190	BPM7A	7321	0,6	305
SRA 2530	BPM7A	7321	0,6	305
SRA 343SL	BPM7A	7321	0,6	305
SRM 140 D / DA	BMR6A	7421	0,6	307
SRM 141 D	BMR6A	7421	0,6	307
SRM 160	BM6A	5921	0,6	303
SRM 200 AE / DA / B / EB	BMR6A	7421	0,6	307
SRM 200BE	BM6A	5921	0,6	303
SRM 200D / DB	BM6A	5921	0,6	303
SRM 201 FA	BMR6A	7421	0,6	307
SRM 202 DA / FA	BMR6A	7421	0,6	307
SRM 210	BMR6A	7421	0,6	307
SRM 250E	BPM7A	7321	0,6	305



Order  
No.Quick  
No.**ECHO**

SRM 250EL	BPM7A	7321	0,6	305
SRM 300 ADX / AE / E	BMR6A	7421	0,6	307
SRM 302 ADX	BMR6A	7421	0,6	307
SRM 303 E	BMR6A	7421	0,6	307
SRM 310/E	BPM7A	7321	0,6	305
SRM 345SL	BPM7A	7321	0,6	305
SRM 400 AE / E	BPM7A	7321	0,6	305
SRM 501DE	BM6A	5921	0,6	303
SRM 2010	BM6A	5921	0,6	303
SRM 2090	BPM7A	7321	0,6	305
SRM 2300	BPM7A	7321	0,6	305
SRM 2450	BPM7A	7321	0,6	305
SRM 2510	BPM7A	7321	0,6	305
SRM 3150	BPMR7A	4626	0,6	309
SRM 3500	BPM7A	7321	0,6	305
SRM 3550	BPM7A	7321	0,6	305
SRM 3800	BPM7A	7321	0,6	305
SRM 4600	BPM7A	7321	0,6	305

**EFCO**

8200	BPMR7A	4626	0,6	309
8220	BPMR7A	4626	0,6	309
8250	BPMR7A	4626	0,6	309
8250 IC	BPMR7A	4626	0,6	309
8250 ICD	BPMR7A	4626	0,6	309
8260 Stark 26	BPMR7A	4626	0,6	309
8300	BPMR7A	4626	0,6	309
8350	BPMR7A	4626	0,6	309
8355	BPMR7A	4626	0,6	309
8355	BPMR7A	4626	0,6	309
8400	BPMR7A	4626	0,6	309
8405	BPMR7A	4626	0,6	309
8405	BPMR7A	4626	0,6	309
8425	BPMR7A	4626	0,6	309
8460	BPMR7A	4626	0,6	309
8460 IC	BPMR7A	4626	0,6	309
8465	BPMR7A	4626	0,6	309
8515	BPMR7A	4626	0,6	309
8530	BPMR7A	4626	0,6	309
8530 IC	BPMR7A	4626	0,6	309
8550 Boss	BPMR7A	4626	0,6	309
HC 160A	BM6A	5921	0,6	303
HC 210E	BM6A	5921	0,6	303
HC 1000	BM6A	5921	0,6	303
HC 1500	BPM6A	7021	0,6	304
HC 1600	BM6A	5921	0,6	303
Jet 200	BPM7A	7321	0,5	305
Jet 220	BPM7A	7321	0,5	305
Jet 260	BPM7A	7321	0,5	305
Jet 260D	BPM7A	7321	0,5	305
Jet 261	BPM7A	7321	0,5	305
Jet 300	BPM7A	7321	0,5	305



Order No.  Quick No.

<b>EFCO</b>					
Jet 310	BPM7A	7321	0,5	305	
Jet 400	BPM7A	7321	0,5	305	
Jet 410	BPM7A	7321	0,5	305	
Jet 460	BPM7A	7321	0,5	305	
Jet 8420	BPM7A	7321	0,5	305	
Jet 8510	BPM7A	7321	0,5	305	
Stark 26	BPMR7A	4626	0,6	309	
Stark 26 IC	BPMR7A	4626	0,6	309	
<b>FLYMO</b>					
Maxi Trim	BMR6A	7421	0,6	307	
Maxi Trim 380	BPMR6A	6726	0,5	308	
Maxi Trim 430 s	BPMR6A	6726	0,5	308	
Maxi Trim 460 s	BPMR6A	6726	0,5	308	
Super Maxi Trim	BMR6A	7421	0,6	307	
<b>FUJI-ROBIN</b>					
NB02 / NB02-2A / NB02-2B	BM7A	6521	0,6		
NB03 / NB04 / NB03-2D	B7HS	5110	0,6	204	
NB04-2D / E / F	B7HS	5110	0,6	204	
NB16 / NB16Z/ NB16F	BM7A	6521	0,6		
NB211 /A/AV/ AW/ NBF211	BM7A	6521	0,6		
NB212 / NB223/ NB232	BM7A	6521	0,6		
NB221	BM7A	6521	0,6		
NB231 / NBF231/ NBK231	BM7A	6521	0,6		
NB251	BM7A	6521	0,6		
NB26 / NB27NB31	BM7A	6521	0,6		
NB262 / NBK262 / NBKA262	BPM7A	7321	0,6	305	
NB263 / NBH263 / NB281	BPM7A	7321	0,6	305	
NB30	B7HS	5110	0,6	204	
NB320 / NB321	BM7A	6521	0,6		
NB351 / NBK351	BPM7A	7321	0,6	305	
NB40	B7HS	5110	0,6	204	
NB411 / NBK411	BPM7A	7321	0,6	305	
NB50 / NB171/ NBF171	BM7A	6521	0,6		
NBE251 / NBF251/ NBF252	BM7A	6521	0,6		
NBK232	BM7A	6521	0,6		
NBT415	BPM7A	7321	0,6	305	
<b>HERKULES</b>					
AST 250	Astschnneider	BPM6A	7021	0,5	304
TBC 2211 N		BPMR6A	6726	0,5	308
TBC 2211 SDH		BPMR6A	6726	0,5	308
TBC 2251		BPMR6A	6726	0,5	308
TBC 270 PF		BMR7A	4226	0,5	
TBC 270 PFD		BMR7A	4226	0,5	
TBC 340 SDH		BM7A	6521	0,5	
TBC 430 PFD		BPMR7A	4626	0,5	309
TBC 600 SDH		BPM6A	7021	0,5	304
<b>HOMELITE</b>					
BCH20		BM6A	5921	0,6	303

Order  
No.Quick  
No.**HOMELITE**

BCH24	BM6A	5921	0,6	303
BCH32C	BM6A	5921	0,6	303
BCH33	BM6A	5921	0,6	303
BCH33B	BM6A	5921	0,6	303
BCH40	BM6A	5921	0,6	303
BCH48	BM6A	5921	0,6	303
HBC 30	BPMR7A	4626	0,6	309
HBC 30B	BPMR7A	4626	0,6	309
HBC-30	BPMR6F	1270	0,6	
HLT-17C	BPMR6F	1270	0,6	
i 625 cd	BPMR7A	4626	0,6	309
i 725 cc	BPMR7A	4626	0,6	309
i 725 ce	BPMR7A	4626	0,6	309
i 725 cea	BPMR7A	4626	0,6	309
i 730 ca	BPMR7A	4626	0,6	309
i 730 cc	BPMR7A	4626	0,6	309
PBC 3600	BPMR7A	4626	0,6	309
PBC 3600 B	BPMR7A	4626	0,6	309
PBC 4000	BPMR7A	4626	0,6	309
PLT-3400	BPMR6F	1270	0,6	
ST80	BM6F	6221	0,6	
ST100	BM6F	6221	0,6	
ST120	BM6F	6221	0,6	
ST 155	BPMR7A	4626	0,6	309
ST160	BM6F	6221	0,6	
ST165	BM6F	6221	0,6	
ST175	BPM6F	5950	0,6	
ST180	BM6F	6221	0,6	
ST185	BPM6F	5950	0,6	
ST200	BM6F	6221	0,6	
ST210	BM6F	6221	0,6	
ST285	BPM6F	5950	0,6	
ST310	BM6F	6221	0,6	
ST 385	BPMR7A	4626	0,6	309

**HONDA**

UMK 435 UE	CR5HSB	6535	0,7	
UMK 422 D	CR5HSB	6535	0,7	
UMK 422 J	CR5HSB	6535	0,7	
UMK 422 LNC	CR5HSB	6535	0,7	
UMK 422 LNU	CR5HSB	6535	0,7	
UMK 422 LT4	CR5HSB	6535	0,7	
UMK 422 LTE	CR5HSB	6535	0,7	
UMK 422 S	CR5HSB	6535	0,7	
UMK 422 UE	CR5HSB	6535	0,7	
UMK 422 UN4C	CR5HSB	6535	0,7	
UMK 422 UNU	CR5HSB	6535	0,7	
UMK 422 UT4E	CR5HSB	6535	0,7	
UMK 425 L3E	CMR5H	7599		
UMK 425 LE	CMR5H	7599		
UMK 425 U3E	CMR5H	7599		
UMK 425 UE	CMR5H	7599		

Order  
No.Quick  
No.**HONDA**

UMK 431 D	CR5HSB	6535	0,7	
UMK 431 J	CR5HSB	6535	0,7	
UMK 431 L3E	CR5HSB	6535	0,7	
UMK 431 LE	CR5HSB	6535	0,7	
UMK 431 LEB	CR5HSB	6535	0,7	
UMK 431 U3E	CR5HSB	6535	0,7	
UMK 431 UE	CR5HSB	6535	0,7	
UMK 431 UEB	CR5HSB	6535	0,7	
UMK 435 L3E	CR5HSB	6535	0,7	
UMK 435 U3E	CR5HSB	6535	0,7	
UMR 431 LT4	CR5HSB	6535	0,7	
UMS 425 LE	CMR5H	7599		
UMT 20 S	BPMR6A	6726	0,6	308
UMT 24 D	BPMR6A	6726	0,6	308
UMT 24 S	CR5HSB	6535	0,7	
UMT 28 D	BPMR6A	6726	0,6	308
UMT 32 D	BPMR6A	6726	0,6	308
UMT 32 FX	BPMR6A	6726	0,6	308
UMT 40 DP	BPMR7A	4626	0,7	309
UMT 41 DF	BPMR6A	6726	0,6	308
UMT 45 DP	BPMR7A	4626	0,7	309
UMT 51 DF	BPMR6A	6726	0,6	308
UMT 51 FX	BPMR6A	6726	0,6	308

**HUSQVARNA**

16 H	BMR7A	4226	0,5	
16 R	BM6A	5921	0,6	303
18 H	BMR7A	4226	0,5	
18 R / RL	BMR6A	7421	0,6	307
22 R	BM6A	5921	0,6	303
22 RL	BMR6A	7421	0,6	307
23 LC	BPMR6A	6726	0,5	308
24 H	BMR7A	4226	0,5	
24 R	BMR6A	7421	0,6	307
25 GT	BM4A	5628	0,5	
25 R	BM6A	5921	0,6	303
25 RL	BMR6A	7421	0,6	307
26 L	BPMR6A	6726	0,5	308
26 LC	BPMR6A	6726	0,5	308
26 H	BMR7A	4226	0,5	
26 R	BPMR7A	4626	0,5	309
26 RJ	BMR7A	4226	0,5	
27 GTS	BM4A	5628	0,5	
32 L	BPMR6A	6726	0,6	308
32 R	BPMR6A	6726	0,6	308
36 R, RG	BPMR6A	6726	0,5	308
39 R	BPMR6A	6726	0,5	308
46 MR	BR2LM	5798	0,5	310
65 R	BPMR7A	4626	0,5	309
120 L	BPMR7A	4626	0,5	309
120L	BMR7A	4226	0,5	
122 L	BPM6Y	4562	0,6	

Order  
No.Quick  
No.**HUSQVARNA**

125 RJ		<b>BPMR6Y</b>	<b>5256</b>	0,6	
125 R,RL,RD,RB,L,LD		<b>BPM6Y</b>	<b>4562</b>	0,7	
132 HBV		<b>BMR7A</b>	<b>4226</b>	0,5	
132 R,RB,RD,L,LD		<b>BPM6Y</b>	<b>4562</b>	0,7	
140 R		<b>BPMR7A</b>	<b>4626</b>	0,5	<b>309</b>
165 R		<b>BPMR7A</b>	<b>4626</b>	0,5	<b>309</b>
165 RX		<b>BPMR6A</b>	<b>6726</b>	0,5	<b>308</b>
225 DR / RT		<b>BMR7A</b>	<b>4226</b>	0,5	
225 L / LD		<b>BPMR7A</b>	<b>4626</b>	0,5	<b>309</b>
225 L , LD		<b>BPMR7A</b>	<b>4626</b>	0,5	<b>309</b>
225 R , RD		<b>BPMR7A</b>	<b>4626</b>	0,5	<b>309</b>
225 RJ		<b>BPMR7A</b>	<b>4626</b>	0,5	<b>309</b>
232 L		<b>BPMR7A</b>	<b>4626</b>	0,5	<b>309</b>
232 L CAT		<b>BPMR7A</b>	<b>4626</b>	0,5	<b>309</b>
232 LR		<b>BMR7A</b>	<b>4226</b>	0,5	
232 R CAT		<b>BPMR7A</b>	<b>4626</b>	0,5	<b>309</b>
232 R		<b>BPMR7A</b>	<b>4626</b>	0,5	<b>309</b>
235 P	Astschneider	<b>BPMR7A</b>	<b>4626</b>	0,5	<b>309</b>
235 R		<b>BPMR7A</b>	<b>4626</b>	0,5	<b>309</b>
235 R CAT		<b>BPMR7A</b>	<b>4626</b>	0,5	<b>309</b>
240 R		<b>BPMR7A</b>	<b>4626</b>	0,5	<b>309</b>
240 RBD		<b>BPMR7A</b>	<b>4626</b>	0,5	<b>309</b>
244 GX		<b>BPMR6A</b>	<b>6726</b>	0,5	<b>308</b>
244 R / RX / RXG		<b>BPMR7A</b>	<b>4626</b>	0,5	<b>309</b>
245 R, RX		<b>BPMR7A</b>	<b>4626</b>	0,5	<b>309</b>
250 PS	Astschneider	<b>BPMR7A</b>	<b>4626</b>	0,5	<b>309</b>
250 R, RX		<b>BPMR7A</b>	<b>4626</b>	0,5	<b>309</b>
265 RX		<b>BPMR7A</b>	<b>4626</b>	0,5	<b>309</b>
268 K		<b>BPMR6A</b>	<b>6726</b>	0,5	<b>308</b>
Mondo		<b>BPM6A</b>	<b>7021</b>	0,5	<b>304</b>

**IDEAL**

SX 230S		<b>BM6A</b>	<b>5921</b>	0,6	<b>303</b>
SX 260S		<b>BM6A</b>	<b>5921</b>	0,6	<b>303</b>
SX 360S / W		<b>BM6A</b>	<b>5921</b>	0,6	<b>303</b>
SX 430S / W		<b>BM6A</b>	<b>5921</b>	0,6	<b>303</b>
SX 540W		<b>BM6A</b>	<b>5921</b>	0,6	<b>303</b>

**ISEKI**

ICD20F		<b>BM6</b>	<b>2027</b>	0,5	
ICD22		<b>BM6</b>	<b>2027</b>	0,5	
ICD25A1		<b>BM6</b>	<b>2027</b>	0,5	
ICD35A1		<b>BM6</b>	<b>2027</b>	0,5	
ICD40A1		<b>BM6</b>	<b>2027</b>	0,5	
ICD50		<b>BM6</b>	<b>2027</b>	0,5	

**ISHIKAWAJIMA**

B18 / B20 / B20DU		<b>BPMR7A</b>	<b>4626</b>	0,7	<b>309</b>
B24 / B24DU / B30 / B31 7 B31DU		<b>BPMR7A</b>	<b>4626</b>	0,7	<b>309</b>
B35 / B35DU		<b>BPMR7A</b>	<b>4626</b>	0,7	<b>309</b>
H18D / H20D / H23D / H26D / H35D		<b>BPMR7A</b>	<b>4626</b>	0,7	<b>309</b>
SB19 / SB20 / SB24 / SB30 / SB40		<b>BM6A</b>	<b>5921</b>	0,6	<b>303</b>

Order  
No.Quick  
No.**ISHIKAWAJIMA**

SCK30D	BM6A	5921	0,6	303
SCY24 / SCY24A	BM6A	5921	0,6	303

**JOHN DEERE**

80G	BM6A	5921	0,6	303
82G	BM4A	5628	0,6	
83G	BM4A	5628	0,6	
85G	B4LM	3410	0,6	301
90G	BM6A	5921	0,6	303
1032	BR6S	3522	0,5	
110G	BM6A	5921	0,6	303
210G	BM6A	5921	0,6	303
240G	BM6A	5921	0,6	303
260G	BM6A	5921	0,6	303

**JONSERED**

BP 40	BPMR7A	4626	0,5	309
BP 40 Combi	BPMR7A	4626	0,5	309
GR 24 , L	BM6A	5921	0,6	303
GR 26	BPMR7A	4626	0,5	309
GR 26 Combi	BPMR7A	4626	0,5	309
GR 26 D	BPMR7A	4626	0,5	309
GR 26 L	BPMR7A	4626	0,5	309
GR26C	BPMR6A	6726	0,5	308
GR 28 , L	BM6A	5921	0,6	303
GR 32 D	BPMR7A	4626	0,5	309
GR 32 L	BPMR7A	4626	0,5	309
GR 36	BPMR7A	4626	0,5	309
GR 41	BPMR7A	4626	0,5	309
GR 44	BPMR7A	4626	0,5	309
GR 50	BPMR7A	4626	0,5	309
GR 50 PRO	BPMR7A	4626	0,5	309
GT 21 L	BPM6A	7021	0,5	304
GT 22 L	BPM6A	7021	0,5	304
GT 24 L	BPM6A	7021	0,5	304
GT 26 L	BMR6A	7421	0,5	307
GT 32 L	BMR6A	7421	0,5	307
HP 36	BPMR7A	4626	0,5	309
RS 38	B6HS	4510	0,5	203
RS 40	BPMR7A	4626	0,5	309
RS 44	BPMR7A	4626	0,5	309
RS 45	BPMR7A	4626	0,5	309
RS 51 Pro	BPMR7A	4626	0,5	309
RS 52	BPMR7A	4626	0,5	309

**KA AZ**

J40FD	BM6A	5921	0,6	303
JL1-T200	BM6A	5921	0,6	303
JQ-50	BM6A	5921	0,6	303
JQ-G4K	BM6A	5921	0,6	303
JQ-T200	BM6A	5921	0,6	303
KLQ	BM6A	5921	0,6	303

Order  
No.Quick  
No.**KAAZ**

KQP-LS		<b>BM6A</b>	<b>5921</b>	0,6	<b>303</b>
V15		<b>BM6A</b>	<b>5921</b>	0,6	<b>303</b>
V18		<b>BM6A</b>	<b>5921</b>	0,6	<b>303</b>
V20		<b>BM6A</b>	<b>5921</b>	0,6	<b>303</b>
V25		<b>BM6A</b>	<b>5921</b>	0,6	<b>303</b>
V40		<b>BM6A</b>	<b>5921</b>	0,6	<b>303</b>

**KAWASAKI**

KBH 26A		<b>BPMR7A</b>	<b>4626</b>	0,5	<b>309</b>
KBH 33A		<b>BMR6A</b>	<b>7421</b>	0,6	<b>307</b>
KBH 34A		<b>BMR6A</b>	<b>7421</b>	0,6	<b>307</b>
KBH 43A		<b>BMR6A</b>	<b>7421</b>	0,6	<b>307</b>
KBH 48A		<b>BMR6A</b>	<b>7421</b>	0,6	<b>307</b>
KBL 23A		<b>BPMR7A</b>	<b>4626</b>	0,5	<b>309</b>
KBL 26A		<b>BPMR7A</b>	<b>4626</b>	0,5	<b>309</b>
KBL 27A		<b>BPMR7A</b>	<b>4626</b>	0,5	<b>309</b>
KBL 34A		<b>BMR6A</b>	<b>7421</b>	0,6	<b>307</b>
KBL 43A		<b>BMR6A</b>	<b>7421</b>	0,6	<b>307</b>
KBLH 48A		<b>BMR6A</b>	<b>7421</b>	0,6	<b>307</b>

**MAKITA**

RBC 220		<b>BM7A</b>	<b>6521</b>	0,7	
RBC 221		<b>BM7A</b>	<b>6521</b>	0,7	
RBC 230		<b>BM7A</b>	<b>6521</b>	0,7	
RBC 250		<b>BM7A</b>	<b>6521</b>	0,7	
RBC 251		<b>BM7A</b>	<b>6521</b>	0,7	
RBC 260		<b>BPM7A</b>	<b>7321</b>	0,7	<b>305</b>
RBC 261		<b>BPM7A</b>	<b>7321</b>	0,7	<b>305</b>
RBC 310		<b>BM7A</b>	<b>6521</b>	0,7	
RBC 311		<b>BM7A</b>	<b>6521</b>	0,7	
RBC 411		<b>BPM7A</b>	<b>7321</b>	0,7	<b>305</b>
RBC 520		<b>BM7A</b>	<b>6521</b>	0,7	
RBK 411		<b>BPM7A</b>	<b>7321</b>	0,7	<b>305</b>
RST 250		<b>BM7A</b>	<b>6521</b>	0,7	

**MARUYAMA**

BC 200 / C / C-T		<b>BPM6Y</b>	<b>4562</b>	0,6	
BC 201 / C / C-T		<b>BPM6Y</b>	<b>4562</b>	0,6	
BC 260 / C / H / T		<b>BPM6Y</b>	<b>4562</b>	0,6	
BC 320 / H / T		<b>BPM6Y</b>	<b>4562</b>	0,6	
BC 420 / H		<b>BPM6Y</b>	<b>4562</b>	0,6	
BCF 420 H		<b>BPM6Y</b>	<b>4562</b>	0,6	
M 22		<b>BPM6Y</b>	<b>4562</b>	0,6	
M 28 / F		<b>BPM6Y</b>	<b>4562</b>	0,6	
M 35 / D / F		<b>BPM6Y</b>	<b>4562</b>	0,6	
M 45 / D / F		<b>BPM6Y</b>	<b>4562</b>	0,6	
MC 260 / C / S / E / D		<b>BPM6Y</b>	<b>4562</b>	0,6	
MC 260 / C / S / E / D	Multischneider	<b>BPM6Y</b>	<b>4562</b>	0,6	
MC 261	Multischneider	<b>BPM6Y</b>	<b>4562</b>	0,6	

**McCULLOCH**

BP 26 AV		<b>BMR6F</b>	<b>2144</b>	0,6	
----------	--	--------------	-------------	-----	--

Order  
No.Quick  
No.**McCULLOCH**

BP 30 AV	BMR6F	2144	0,6	
BP 38 AV	BMR6F	2144	0,6	
BP 30 AV	BMR6A	7421	0,6	307
BP 38 AV	BMR6A	7421	0,6	307
Camargue 26	BMR6F	2144	0,6	
Kentucky 36	BMR6F	2144	0,6	
Mac 17	BMR6F	2144	0,6	
Mac 21	BMR6F	2144	0,6	
Mac 22	BM7A	6521	0,6	
Mac 23	BM7A	6521	0,6	
Mac 25	BMR6F	2144	0,6	
Mac 26	BMR6F	2144	0,6	
Mac 30 / AV	BMR6F	2144	0,6	
Mac 32	B6HS	4510	0,6	203
Mac 37	B6HS	4510	0,6	203
Mac 38 AV	BMR6F	2144	0,6	
Mac 52	B6S	3510	0,6	302
Mac 60 SX	BMR6F	2144	0,6	
Mac 80 A / SX	BMR6F	2144	0,6	
Mac 90	BMR6F	2144	0,6	
Mac 95	BMR6F	2144	0,6	
MD 290	BMR6F	2144	0,5	
MD 330 AV	BMR6F	2144	0,5	
MT 280 X	BMR6F	2144	0,5	
MT 310 X	BMR6F	2144	0,5	
MT 320	BMR6F	2144	0,5	
PM 2100	BMR6F	2144	0,5	
PM 2600	BMR6F	2144	0,5	
PM 3100	BMR6F	2144	0,5	
PM 3600	BMR6F	2144	0,5	
PM 4100	BMR6F	2144	0,5	
PM 4150	BMR6F	2144	0,5	
PMAC 38 AV	BMR6A	7421	0,6	307
Prater 31	BMR6F	2144	0,6	
Pro Mac 38 AV	BMR6F	2144	0,6	
SMAC 30, AV	BMR6A	7421	0,6	307
Super Mac 28	BMR6F	2144	0,6	
Super Mac 30 AV	BMR6F	2144	0,6	
Super Mac 38 AV	BMR6F	2144	0,6	
Trim Mac 24	BMR6F	2144	0,6	
Trim Mac 24	BMR6A	7421	0,6	307
Trim Mac 26	BMR6F	2144	0,6	
Trim Mac 26	BMR6A	7421	0,6	307
Versailles 41	BMR6F	2144	0,6	
Windsor Kit 28	BMR6F	2144	0,6	

**MOUNTFIELD**

Multi-trim 16	BMR6A	7421	0,5	307
Multi-trim 18	BMR6A	7421	0,5	307
Multi-trim 23	BMR6A	7421	0,5	307
Multi-trim 24	BMR6A	7421	0,5	307
Multi-trim 31	BR6HS	3922	0,5	



Order  
No.Quick  
No.**MOUNTFIELD**

Multi-trim 33	BMR6A	7421	0,5	307
Multi-trim 40	BMR6A	7421	0,5	307

**NAUTAC**

011F	BPMR7A	4626	0,5	309
011R	BPMR7A	4626	0,5	309
012R	BPMR7A	4626	0,5	309
026R	BPMR7A	4626	0,5	309
026RF	BPMR7A	4626	0,5	309
1100T	BPMR7A	4626	0,5	309

**OLEO - MAC**

433 BP	BPMR7A	4626	0,5	309
721	BPMR7A	4626	0,5	309
727	BPMR7A	4626	0,5	309
727 S	BPMR7A	4626	0,5	309
727 T	BPMR7A	4626	0,5	309
733	BPMR7A	4626	0,5	309
733 S	BPMR7A	4626	0,5	309

**PARTNER**

B 180	BMR6A	7421	0,5	307
B 200	BPMR7A	4626	0,5	309
B 205	BPMR7A	4626	0,5	309
B 250	BMR6A	7421	0,5	307
B 265	BPMR6A	6726	0,5	308
B 322	BPMR7A	4626	0,5	309
B 323	BPMR7A	4626	0,5	309
B 325	BPMR7A	4626	0,5	309
B 370	BPMR7A	4626	0,5	309
B 380	BPMR7A	4626	0,5	309
B 400	BPMR7A	4626	0,5	309
B 405	BPMR7A	4626	0,5	309
B 440	BPMR7A	4626	0,5	309
B 450 C	BPMR7A	4626	0,5	309
B 450 G	BPMR7A	4626	0,5	309
B 450 W	BR4LM	4133	0,5	
Colibri	BPMR7A	4626	0,5	309
Colibri Duo	BPMR7A	4626	0,5	309
Colibri Plus	BPMR7A	4626	0,5	309
Prof	BPMR7A	4626	0,5	309
T 180 Colibri	BPMR6A	6726	0,5	308
T 221	BPMR7A	4626	0,6	309
T 225	BMR6A	7421	0,6	307
T 240	BPMR6A	6726	0,5	308
T 250	BMR6A	7421	0,6	307
T 260	BMR6A	7421	0,6	307
T 285	BMR6A	7421	0,6	307
T 321	BPMR7A	4626	0,6	309

**SABRE**

B25	BPM6F	5950	0,6	
-----	-------	------	-----	--



Order No.  Quick No.

### SABRE

S25	BPM6F	5950	0,6	
S25C	BPM6F	5950	0,6	

### SHINDAIWA

B 40	BMR6A	7421	0,7	307
B 45	BMR6A	7421	0,6	307
BP 23E	BMR6A	7421	0,6	307
BP 35	BMR6A	7421	0,6	307
C 20	BMR6A	7421	0,7	307
C 23	BMR6A	7421	0,6	307
C 25	BM6A	5921	0,6	303
C 27	BPMR6A	6726	0,6	308
C 35	BM6A	5921	0,6	303
C 35	BMR6A	7421	0,6	307
C 230	BMR6A	7421	0,6	307
C 250	BMR6A	7421	0,6	307
F 18	BMR6A	7421	0,6	307
F 20	BM6A	5921	0,6	303
F 21	BMR6A	7421	0,7	307
HT2020	BM6A	5921	0,6	303
HT2030	BM6A	5921	0,6	303
LE 250	BMR6A	7421	0,6	307
RC 45	BMR6A	7421	0,6	307
T 20	BM6A	5921	0,6	303
T 23	BMR6A	7421	0,6	307
T 23E	BMR6A	7421	0,6	307
T 25	BM6A	5921	0,6	303
T 230	BMR6A	7421	0,6	307
T 250	BMR6A	7421	0,6	307

### SNAPPER

ETC 302 KW	BM6A	5921	0,6	303
------------	------	------	-----	-----

### SOLO

105 L	BPMR6A	6726	0,6	308
106 B	BPMR6A	6726	0,6	308
106 L	BPMR6A	6726	0,6	308
106 R	CMR6A	1223	0,6	
117	BPMR7A	4626	0,6	309
118	BPMR6A	6726	0,5	308
119	BPMR6A	6726	0,5	308
120	BPMR7A	4626	0,5	309
121	BPMR7A	4626	0,6	309
123	BM6F	6221	0,5	
124	BPMR7A	4626	0,5	309
125	BM6F	6221	0,5	
126	BPMR7A	4626	0,5	309
127	BPMR6A	6726	0,5	308
128	BPMR7A	4626	0,5	309
129	BPMR7A	4626	0,6	309
129 BTS	BPMR6A	6726	0,6	308
130	BPMR6A	6726	0,5	308

Order  
No.Quick  
No.**SOLO**

134		BPMR6A	6726	0,5	308
135		BM6A	5921	0,5	303
136		BM6A	5921	0,5	303
137		BPMR6A	6726	0,5	308
140		BPMR6A	6726	0,5	308
141		BPMR6A	6726	0,5	308
664		BPMR7A	4626	0,6	309

**STIHL**

FC 55		BPMR7A	4626	0,5	309
FC 72	Kantenschneider	BPMR7A	4626	0,5	309
FC 75		BPMR7A	4626	0,5	309
FC 100		CMR6H	3365	0,5	
FC 110		CMR6H	3365	0,5	
FH 75		BPMR7A	4626	0,5	309
FR 85		BPMR7A	4626	0,5	309
FR 106		BPMR7A	4626	0,5	309
FR 108		BPMR7A	4626	0,5	309
FR 350		BPMR7A	4626	0,5	309
FR 450		BPMR7A	4626	0,5	309
FR 480		BPMR7A	4626	0,5	309
FS 25-4R/25-4		CMR6H	3365	0,5	
FS 36		BMR6A	7421	0,5	307
FS 36		BMR6A	7421	0,6	307
FS 38		BMR6A	7421	0,6	307
FS 40		BMR6A	7421	0,6	307
FS 44		BMR6A	7421	0,6	307
FS 45		BPMR7A	4626	0,5	309
FS 45 C		BPMR7A	4626	0,5	309
FS 48		BPMR7A	4626	0,5	309
FS 50		BMR6A	7421	0,5	307
FS 51		BMR6A	7421	0,6	307
FS 52		BPMR7A	4626	0,5	309
FS 55 C		BPMR7A	4626	0,5	309
FS 55 RC		BPMR7A	4626	0,5	309
FS 55R/55		BPMR7A	4626	0,5	309
FS 56		BMR6A	7421	0,5	307
FS 60		BMR6A	7421	0,6	307
FS 61		BMR6A	7421	0,6	307
FS 62		BPMR7A	4626	0,5	309
FS 65		BMR6A	7421	0,6	307
FS 65-4R/65-4		CMR6H	3365	0,5	
FS 66		BMR6A	7421	0,5	307
FS 74		BPMR7A	4626	0,5	309
FS 75		BPMR7A	4626	0,5	309
FS 80		BMR6A	7421	0,6	307
FS 80R/80		BPMR7A	4626	0,5	309
FS 81		BPMR7A	4626	0,5	309
FS 85		BPMR7A	4626	0,5	309
FS 85R/85		BPMR7A	4626	0,5	309
FS 85RT/85T		BPMR7A	4626	0,5	309
FS 86 --> No.14821680		BMR6A	7421	0,6	307



Order No.  Quick No.

## STIHL

FS 86 No.15821680 -->	BPMR7A	4626	0,5	309
FS 88	BPMR7A	4626	0,5	309
FS 90 neuer Serie	CMR6H	3365	0,6	
FS 90 Typ 4117 alte Serie	BMR6A	7421	0,6	307
FS 96	BMR6A	7421	0,6	307
FS 100 R / FS 100	CMR6H	3365	0,6	
FS 100 RX	CMR6H	3365	0,5	
FS 106	BPMR7A	4626	0,5	309
FS 110	CMR6H	3365	0,5	
FS 120	BPMR7A	4626	0,5	309
FS 130	CMR6H	3365	0,5	
FS 150	BPMR7A	4626	0,5	309
FS 160	BPMR7A	4626	0,5	309
FS 200	BPMR7A	4626	0,5	309
FS 220	BPMR7A	4626	0,5	309
FS 280	BPMR7A	4626	0,5	309
FS 300	BPMR7A	4626	0,5	309
FS 300	BPMR7A	4626	0,5	309
FS 350	BPMR7A	4626	0,5	309
FS 350	BPMR7A	4626	0,5	309
FS 400	BPMR7A	4626	0,5	309
FS 400 K	BPMR7A	4626	0,5	309
FS 400K/400	BPMR7A	4626	0,5	309
FS 410	BPMR7A	4626	0,5	309
FS 420	BPMR7A	4626	0,5	309
FS 450	BPMR7A	4626	0,5	309
FS 450 K	BPMR7A	4626	0,5	309
FS 450K/450	BPMR7A	4626	0,5	309
FS 480 / K	BPMR7A	4626	0,5	309
FS 550	BPMR7A	4626	0,5	309
KM 100 FS	CMR6H	3365	0,6	
KM 100 R FS	CMR6H	3365	0,6	
KM 100 R HL	CMR6H	3365	0,6	
KM 100 R HT	CMR6H	3365	0,6	
KM 55 C FS	BPMR7A	4626	0,5	309
KM 55 FS	BPMR7A	4626	0,5	309
KM 55 R FS	BPMR7A	4626	0,5	309
KM 55 R HL	BPMR7A	4626	0,5	309
KM 55 R HT	BPMR7A	4626	0,5	309
KM 55 RC FS	BPMR7A	4626	0,5	309
KM 55 RC HL	BPMR7A	4626	0,5	309
KM 55 RC HT	BPMR7A	4626	0,5	309
KM 85 FS	BPMR7A	4626	0,5	309
KM 85 R FS	BPMR7A	4626	0,5	309
KM 85 R HL	BPMR7A	4626	0,5	309
KM 85 R HT	BPMR7A	4626	0,5	309
KW 85	BPMR7A	4626	0,5	309

## TANAKA

AST 250	BPM6A	7021	0,6	304
AST 5000	BPM6A	7021	0,6	304
AST 7000	BPM6A	7021	0,6	304

Order  
No.Quick  
No.**TANAKA**

SUM 321 , SUM 351	BM7A	6521	0,6	
SUM 421	BM6A	5921	0,6	303
TBC 220	BPM6A	7021	0,6	304
TBC 250	BPM6A	7021	0,6	304
TBC 265	BM6A	5921	0,6	303
TBC 300	BM7A	6521	0,6	
TBC 322	BM7A	6521	0,6	
TBC 355	BM7A	6521	0,6	
TBC 422	BM6A	5921	0,6	303
TBC 500	BPM6A	7021	0,6	304
TBC 2000	BPM6A	7021	0,6	304
TBC 2200	BPM6A	7021	0,6	304
TBC 2400	BPMR6A	6726	0,5	308
TBC 4000	BPM6A	7021	0,6	304
TBC 4200	BPMR6A	6726	0,5	308
TBC 4500	BPM6A	7021	0,6	304
TBC 5000	BPM6A	7021	0,6	304
TST 218	BM6A	5921	0,6	303
TUM 220	BPM6A	7021	0,6	304
TUM 250	BPM6A	7021	0,6	304

**TONDU**

M 18	BM6A	5921	0,6	303
PRO 255	BM6A	5921	0,6	303
PRO 851	BM7A	6521	0,6	
S 180	BM6A	5921	0,6	303
S 255	BM6A	5921	0,6	303
S 260	BM6A	5921	0,6	303

**WARRIOR**

E 6 (Robin)	BM6A	5921	0,6	303
E 8 (Robin)	BM6A	5921	0,6	303
E6 (Kawasaki)	BM4A	5628	0,5	
KD 18	BM6A	5921	0,6	303
KD 24 X	BM6A	5921	0,6	303
KD 33XV	BM6A	5921	0,6	303
KD 40 XV (Robin)	BM6A	5921	0,6	303
KD 50 XV (Robin)	BM6A	5921	0,6	303
SU 18 D	BM6A	5921	0,6	303

**WESTMAC**

18 / 19	BM6A	5921	0,6	303
24	BM6A	5921	0,6	303
33	BM6A	5921	0,6	303
40 / 48	BM6A	5921	0,6	303

**WHIRLYBIRD**

20 / 25	BM6A	5921	0,6	303
35	BM6A	5921	0,6	303
40	BM6A	5921	0,6	303

Order  
No.Quick  
No.**WOLF**

UV-EB	BMR6A	7421	0,6	307
UV-P	B7HS	5110	0,6	204

**WOODLORD**

BC 161 DM	BM6A	5921	0,6	303
BC 241 DX	BM6A	5921	0,6	303
BC 330 DX	BM6A	5921	0,6	303
BC 400 FX	BM6A	5921	0,6	303
BK 331 FX	BM6A	5921	0,6	303
TM 350	BM6A	5921	0,6	303

**YAMAHA**

YBC 20 D	BPMR6A	6726	0,6	308
YBC 20 S	BPMR6A	6726	0,6	308
YBC 30 D	BPMR6A	6726	0,6	308
YBC 40 D	BPMR6A	6726	0,6	308
YBC 50 D	BPMR6A	6726	0,6	308

**ZENOAH**

BC 153 E1	BM6A	5921	0,6	303
BC 174 E	BM6A	5921	0,6	303
BC 234 B	BM7A	6521	0,6	
FBC 33	B6S	3510	0,7	302

Order  
No.Quick  
No.**AGTRONIC**

B&S Engine	<b>BM6A</b>	<b>5921</b>	0,6	<b>303</b>
------------	-------------	-------------	-----	------------

**ARCTIC CAT**

AC1400G 3.8hp 119cc 4Stroke	<b>BPR6ES</b>	<b>7822</b>	0,6	
AC1800GD	<b>BPR6ES</b>	<b>7822</b>	0,6	
AC2200G	<b>BPR6ES</b>	<b>7822</b>	0,6	
AC2500G 5.3hp 162cc 4Stroke	<b>BPR6ES</b>	<b>7822</b>	0,6	
AC2500GD 5.3hp 162cc 4Stroke	<b>BPR6ES</b>	<b>7822</b>	0,6	
AC3000GD2 6.8hp 252cc 4Stroke	<b>BPR5HS</b>	<b>6222</b>	0,6	
AC4000G2 9.0hp 272cc 4Stroke	<b>BPR5ES</b>	<b>7422</b>	0,6	
AC4000GD2E 9.0hp 272cc 4Stroke	<b>BPR5ES</b>	<b>7422</b>	0,6	
AC7500GD2E 14.0hp 419cc 4Stroke	<b>BR6ES</b>	<b>4922</b>	0,5	
AC750GT 1.8hp 70cc 2 Stroke	<b>BPR5HS</b>	<b>6222</b>	0,6	

**ATLAS**

3.0 hp B&S	<b>B2LM</b>	<b>1147</b>	0,6	
5.0 hp B&S	<b>B2LM</b>	<b>1147</b>	0,6	
8.0 hp B&S	<b>B2LM</b>	<b>1147</b>	0,6	

**BRIGGS & STRATTON**

3250 6.5hp	<b>BKR5E</b>	<b>7938</b>	0,7	
5000 10.0hp	<b>B2LM</b>	<b>1147</b>	0,6	
5500 10.0hp	<b>B2LM</b>	<b>1147</b>	0,6	
6000 11.0hp	<b>B2LM</b>	<b>1147</b>	0,6	
7000 15.0hp	<b>BKR5E</b>	<b>7938</b>	0,7	
10000 18.0hp V-Twin Vanguard	<b>BKR5E</b>	<b>7938</b>	0,7	
BSQ 1000	<b>BP6HS</b>	<b>4511</b>	0,7	
Pro4000 7.5hp Vanguard OHV	<b>BKR5E</b>	<b>7938</b>	0,7	
Pro6500 13.0hp Vanguard OHV	<b>BKR5E</b>	<b>7938</b>	0,7	
Pro8000 16.0hp V-Twin Vanguard	<b>BKR5E</b>	<b>7938</b>	0,7	

**CLARKE**

5.0 hp B&S	<b>B2LM</b>	<b>1147</b>	0,6	
7.8 hp Robin	<b>B4H</b>	<b>4110</b>	0,5	
8.0 hp B&S	<b>B2LM</b>	<b>1147</b>	0,6	
8.0 hp Honda OHV	<b>BP5ES</b>	<b>6511</b>	0,8	
11.0 hp B&S	<b>B2LM</b>	<b>1147</b>	0,6	

**COLEMAN**

2.0 hp Robin	<b>BPM7A</b>	<b>7321</b>	0,7	<b>305</b>
3.1 hp Kawasaki all models	<b>BM6A</b>	<b>5921</b>	0,5	<b>303</b>
3.5 hp B&S	<b>BR2LM</b>	<b>5798</b>	0,5	<b>310</b>
3.5 hp B&S Intek	<b>BKR5E</b>	<b>7938</b>	0,7	
5.5 hp B&S	<b>BR2LM</b>	<b>5798</b>	0,5	<b>310</b>
5.5 hp Honda engine all models	<b>BP5ES</b>	<b>6511</b>	0,6	
Tecumseh Enduro 3000	<b>BR6ES</b>	<b>4922</b>	0,5	
6.0 hp B&S Intek OHV PM5300	<b>BKR5E</b>	<b>7938</b>	0,7	
10.0 hp 5000	<b>BR2LM</b>	<b>5798</b>	0,5	<b>310</b>
10.0 hp B&S	<b>BKR5E</b>	<b>7938</b>	0,7	
10.0 hp B&S GenPower OHV	<b>BR6S</b>	<b>3522</b>	0,7	
10.0 hp Tecumseh	<b>BPR6ES-11</b>	<b>4824</b>	1,1	
11.0 hp Honda OHV GX340	<b>BR6ES</b>	<b>4922</b>	0,6	



Order No.  Quick No.

### COLEMAN

11.0 hp	Tecumseh	BPR6ES	7822	0,6	
13.0 hp	Honda	BKR5E	7938	0,7	
18.0 hp	B&S OHV	BKR5E	7938	0,7	
B&S engine all models		B2LM	1147	0,6	
PM0454024, PM0454025, PM0455024		B2LM	1147	0,6	
PM0456025, PM0544202, PM0544222 8.0hp		B2LM	1147	0,6	
PM0522000, PM0524000, PM0525000		B6S	3510	0,7	302
PM0545202, PM0554222		B2LM	1147	0,6	
PM0545305		BKR5E	7938	0,7	
Tecumseh engine all models		B6S	3510	0,7	302

### ECHO

11.0hp	B&S Vanguard all models	BKR5E	7938	0,7	
14.0hp	Kohler OHV all models	BKR5E	7938	0,7	
16.0hp	B&S Vanguard v-twin all models	BKR5E	7938	0,7	
5.0hp	B&S all models	B2LM	1147	0,6	
8.0hp	Kohler all models	B2LM	1147	0,6	
9.0hp	B&S Vanguard all models	BKR5E	7938	0,7	
EG- 550		BPM4A	5928	0,6	
EG- 650 (From 1994)		BMR4A	5728	0,6	306
EG- 650 (To 1993)		BPM4A	5928	0,6	
EG- 750		BPM4A	5928	0,6	
EG-1500		BPR4HS	7823	0,6	
EG-1800		BM6A	5921	0,7	303
EG-2300		BPR4HS	7823	0,5	
EG-2400 (From 1994)		BR6HS	3922	0,6	209
EG-2400 (To 1993)		BPR4HS	7823	0,8	
EG-2600		BMR4A	5728	0,6	306
EG-3500		BPM4A	5928	0,6	
EG-3501 (From 1994)		BPR6HS	7022	0,7	214
EG-3501 (To 1993)		BPR4HS	7823	0,7	
EG-4300		BPR4HS	7823	0,8	
EG-4300E		BPR4HS	7823	0,5	
EG-4601, EG-5601, EG-7601		BKR5E	7938	0,7	
EG-5500E		BPR4HS	7823	0,5	
EG-5600E		BKR5E	7938	0,7	
EG-7600E		BKR5E	7938	0,7	

### FUJI-ROBIN

SGV4000	EH25D	BR6HS	3922	0,7	209
SG550	EY08D	BMR4A	5728	0,6	306
SGL1500-II	EY15D	BR6HS	3922	0,6	209
SG1000-II	EY15D	BR6HS	3922	0,6	209
SGV2200	EY17D	BR6HS	3922	0,6	209
SGV2600	EY17D	BR6HS	3922	0,7	209
SGL2200-II	EY17D	BR6HS	3922	0,6	209
SGL2000-II	EY20D	BR6HS	3922	0,6	209
SGL3000-II	EY28D	BPR6HS	7022	0,7	214

### HOMELITE

5.0 hp	B&S	BR2LM	5798	0,5	310
7.0 hp	B&S	BR2LM	5798	0,5	310



Order  
No.Quick  
No.**HOMELITE**

7.6 hp	Robin	<b>BPR6HS</b>	<b>7022</b>	0,7	<b>214</b>
8.0 hp	B&S	<b>BR2LM</b>	<b>5798</b>	0,5	<b>310</b>
9.0 hp	B&S Vanguard	<b>BKR5E</b>	<b>7938</b>	0,7	
10.0 hp	B&S	<b>BR2LM</b>	<b>5798</b>	0,5	<b>310</b>
11.0 hp	B&S	<b>BR2LM</b>	<b>5798</b>	0,5	<b>310</b>
11.0 hp	Robin	<b>BR6HS</b>	<b>3922</b>	0,7	<b>209</b>
176B140A		<b>B2LM</b>	<b>1147</b>	0,6	
176R142A		<b>BPR6HS</b>	<b>7022</b>	0,7	<b>214</b>
178H148		<b>BPR5ES</b>	<b>7422</b>	0,6	
178V152		<b>BKR5E</b>	<b>7938</b>	0,7	
180HIE63		<b>BPR5ES</b>	<b>7422</b>	0,6	
180R162, 180RIE162		<b>BR6HS</b>	<b>3922</b>	0,7	<b>209</b>
18mm Hd		<b>WR5</b>	<b>1071</b>	0,6	
190HY50		<b>BR2LM</b>	<b>5798</b>	0,5	<b>310</b>
CG4800/178H148, CG5200		<b>BPR5ES</b>	<b>7422</b>	0,6	
CG6300/180H163		<b>BPR5ES</b>	<b>7422</b>	0,7	
CGE6300/180HIE63		<b>BR2LM</b>	<b>5798</b>	0,5	<b>310</b>
CHY5000/190HHY50		<b>BR2LM</b>	<b>5798</b>	0,5	<b>310</b>
E300		<b>CM6</b>	<b>5812</b>	0,6	
EH2500HD		<b>BR2LM</b>	<b>5798</b>	0,5	<b>310</b>
EH4400HD, EHE4400HD		<b>BR2LM</b>	<b>5798</b>	0,5	<b>310</b>
EH550HD, EHE5500HD		<b>BR2LM</b>	<b>5798</b>	0,5	<b>310</b>
EHRL4400HD		<b>BR2LM</b>	<b>5798</b>	0,5	<b>310</b>
HG3500, HGE3500		<b>BR2LM</b>	<b>5798</b>	0,5	<b>310</b>
HG50-1400, HG50-2000		<b>BR6HS</b>	<b>3922</b>	0,6	<b>209</b>
HG50-2500		<b>BR6HS</b>	<b>3922</b>	0,6	<b>209</b>
HG600		<b>BR6HS</b>	<b>3922</b>	0,7	<b>209</b>
HL2500, HL4400, HLE4400		<b>BR2LM</b>	<b>5798</b>	0,5	<b>310</b>
Homelite		<b>BR6S</b>	<b>3522</b>	0,7	
LR2500, LR4400, LRE4400		<b>BR2LM</b>	<b>5798</b>	0,5	<b>310</b>
LR5500, LRE5500		<b>BR2LM</b>	<b>5798</b>	0,5	<b>310</b>
LRI2500, LRI4400, LRIE4400		<b>BR2LM</b>	<b>5798</b>	0,5	<b>310</b>
LRI5500, LRE5500		<b>BR2LM</b>	<b>5798</b>	0,5	<b>310</b>
LRIE5500		<b>BR2LM</b>	<b>5798</b>	0,5	<b>310</b>
Yamaha		<b>BPR6HS</b>	<b>7022</b>	0,7	<b>214</b>

**HONDA**

4500K1 (G400K1)		<b>BPR4HS</b>	<b>7823</b>	0,6	
E 80		<b>C6HSA</b>	<b>3228</b>	0,6	
E 100		<b>C6HSA</b>	<b>3228</b>	0,6	
E 300		<b>C6HSA</b>	<b>3228</b>	0,6	
E 400		<b>C6HSA</b>	<b>3228</b>	0,6	
E 1500 (G42)		<b>BR6HS</b>	<b>3922</b>	0,6	<b>209</b>
E 1500 (G200)		<b>BR4HS</b>	<b>3322</b>	0,6	
E 1500 (G200) CDI.IGN		<b>BPR4HS-10</b>	<b>5024</b>	1,0	
E 2500 (G300)		<b>BR4HS</b>	<b>3322</b>	0,6	
E 3000 (GD100) 12V		<b>YS-101</b>	<b>5825</b>		
E 3500 CDI. IGN.		<b>BPR4HS-10</b>	<b>5024</b>	1,0	
E 3500		<b>BR4HS</b>	<b>3322</b>	1,0	
E 4000		<b>YS-101</b>	<b>5825</b>		
E 4500		<b>BPR4HS-10</b>	<b>5024</b>	1,0	
EB 1200X (GX110)		<b>BPR6ES</b>	<b>7822</b>	0,6	



Order No.  Quick No.

## HONDA

EB 1400X	BPR6ES	7822	0,6	
EB 1500 (GE200)	BPR4HS-10	5024	1,0	
EB 1500X	BPR6ES	7822	0,6	
EB 1800	BPR4HS-10	5024	1,0	
EB 1800X	BPR6ES	7822	0,6	
EB 1900 (GE200)	BPR4HS-10	5024	1,0	
EB 1900X (GX140)	BPR6ES	7822	0,6	
EB 2200X	BPR6ES	7822	0,6	
EB 2800 (GE300)	BPR4HS-10	5024	1,0	
EB 3000	BR4HS	3322	0,6	
EB 3000X	BPR5ES	7422	0,6	
EB 3500X	BPR5ES	7422	0,6	
EB 3800 (G400)	BPR4HS-10	5024	1,0	
EB 4000	BPR4HS-10	5024	1,0	
EB 4500	BPR6ES	7822	0,6	
EB 5000	BPR6ES	7822	0,6	
EBK 2000	BPR4HS-10	5024	1,0	
EBK 2600	BR4HS	3322	0,6	
EBK 3600	BR4HS	3322	0,6	
EC 2100 C	BPR6ES	7822	0,6	
EC 2200	BPR6ES	7822	0,6	
EC 2200L	BPR6ES	7822	0,6	
EC 4000	BPR6ES	7822	0,6	
EC 4500P	BPR6ES	7822	0,6	
EC 6000	BPR6ES	7822	0,6	
ECM 2800	BPR6ES	7822	0,7	
ECMT 6500	BPR6ES	7822	0,7	
ECMT 6500P	BPR6ES	7822	0,7	
ECT 6500	BPR6ES	7822	0,6	
ECT 6500P	BPR6ES	7822	0,6	
ED 250	C6HSA	3228	0,6	
ED 300 Ser. -1138369	BPMR6A-10	1029	1,0	
ED 300 Ser. 1138370-	BPMR4A-10	6328	1,0	
ED 400	BMR4A	5728	0,6	306
ED 1000X	BPR6ES	7822	0,6	
EG 550	BMR4A	5728	0,6	306
EG 650	BMR4A	5728	0,6	306
EG 850X	BPR6ES	7822	0,6	
EG 850Z	BR4HS	3322	0,6	
EG 1000 (G150)	BR4HS	3322	0,6	
EG 1000X	BPR6ES	7822	0,6	
EG 1000Z (GE150)	BR4HS	3322	0,6	
EG 1200	BPR6ES	7822	0,6	
EG 1200X (GX110 , GX120K1)	BPR6ES	7822	0,6	
EG 1200Z	BR4HS	3322	0,6	
EG 1400X	BPR6ES	7822	0,6	
EG 1400Z	BR4HS	3322	0,6	
EG 1500X	BPR6ES	7822	0,6	
EG 1500Z	BR4HS	3322	0,6	
EG 1800X	BPR6ES	7822	0,6	
EG 1800Z	BR4HS	3322	0,6	
EG 1900X (GX140)	BPR6ES	7822	0,6	

Order  
No.Quick  
No.**HONDA**

EG 1900Z	BR4HS	3322	0,6	
EG 2000X	BPR6ES	7822	0,6	
EG 2200	BPR6ES	7822	0,6	
EG 2200X	BPR6ES	7822	0,6	
EG 2200Z	BR4HS	3322	0,6	
EG 3000	BPR5ES	7422	0,6	
EG 3000 (GX240)	BR4HS	3322	0,6	
EG 3000X	BPR6ES	7822	0,6	
EG 3500X	BPR6ES	7822	0,6	
EG 4000	BR4HS	3322	0,6	
EG 4500	BPR6ES	7822	0,6	
EG 4500 X	BPR5ES-11	4424	1,1	
EG 4500X (GX340 CDI)	BPR5ES	7422	0,8	
EG 5000	BPR6ES	7822	0,6	
EGK 1000	BR4HS	3322	0,6	
EGK 1200	BR4HS	3322	0,6	
EGK 1600	BR4HS	3322	0,6	
EGK 2000	BR4HS	3322	0,6	
EGK 2600	BR4HS	3322	0,6	
EGK 3600	BR4HS	3322	0,6	
EGK 600	BM4A	5628	0,6	
EJ 3	BPR6HS	7022	0,6	214
EL 80	C6HSA	3228	0,6	
EL 5000	BPR6HS	7022	0,6	214
EM 25	BPR6ES	7822	0,5	
EM 30	BPR6ES	7822	0,5	
EM 300	C6HSA	3228	0,6	
EM 400 (14MM)	C6HSA	3228	0,6	
EM 500 Ser. -1138369	BPMR6A-10	1029	1,0	
EM 500 Ser. 1138370-	BPMR4A-10	6328	1,0	
EM 600	BPMR6A-10	1029	1,0	
EM 650	BMR4A	5728	0,6	306
EM 1200X (GX110)	BPR6ES	7822	0,6	
EM 1400X	BPR6ES	7822	0,6	
EM 1500 (GE200)	BPR4HS-10	5024	1,0	
EM 1500X	BPR6ES	7822	0,6	
EM 1800	BPR4HS-10	5024	1,0	
EM 1800X	BPR6ES	7822	0,6	
EM 1900 (GE200)	BPR4HS-10	5024	1,0	
EM 1900X	BPR6ES	7822	0,6	
EM 2200	BPR6ES	7822	0,6	
EM 2200X	BPR6ES	7822	0,6	
EM 3000	BPR4HS-10	5024	1,0	
EM 3000SX	BPR5ES	7422	0,6	
EM 3000X	BPR5ES	7422	0,6	
EM 3500SX	BPR5ES	7422	0,6	
EM 3500X	BPR5ES	7422	0,6	
EM 4000	BPR4HS-10	5024	1,0	
EM 4500	BPR6ES	7822	0,6	
EM 4500 CX	BPR5ES	7422	0,6	
EM 4500 CXS	BPR5ES	7422	0,6	
EM 4500 SX	BPR5ES	7422	0,6	

Order  
No.Quick  
No.**HONDA**

EM 5000	BPR6ES	7822	0,6	
EM 5000SX	BPR6ES	7822	0,6	
EM 50iS	BPR5ES	7422	0,6	
EM 5500 CX	BPR5ES	7422	0,6	
EM 5500 CXS	BPR5ES	7422	0,6	
EM 70iS	BPR5ES	7422	0,6	
EMS 2800 (GE300)	BPR4HS-10	5024	1,0	
EMS 3000	BPR4HS-10	5024	1,0	
EMS 3800 (G400)	BPR4HS-10	5024	1,0	
EMS 4000	BPR4HS-10	5024	1,0	
ES 3500 K1 (G400K1)	BR4HS	3322	0,6	
ES 3500 (G400)	BPR4HS-10	5024	1,0	
ES 4500 (G400)	BPR4HS-10	5024	1,0	
ES 5500 K1 (GX360K1)	BPR6HS	7022	0,6	214
ES 5500 (GX360)	BPR6HS-10	2633	1,0	
ES 6500	BPR6HS	7022	0,6	214
ET 4500	BPR4HS-10	5024	1,0	
ET 4500X	BPR6ES	7822	0,6	
EU 10i	CR5HSB	6535	0,7	
EU 19i	CR5HSB	6535	0,7	
EU 20	CR4HSB	4695	0,5	
EU 20 i	CR4HSB	4695	0,5	
EU 26i	BPR5ES	7422	0,6	
EU 30i	BPR5ES	7422	0,8	
EU 30is	BPR5ES	7422	0,6	
EV 3600	BPR6HS-10	2633	1,0	
EV 3610	BPR2HS	7626	0,7	
EV 3610	BPR2HS	7626	0,7	
EV 4000	BPR6HS-10	2633	1,0	
EV 4010	BPR4HS	7823	0,7	
EV 5010	BPR6HS	7022	0,7	214
EV 6010	BPR4HS	7823	0,6	
EW 170	BR4HS	3322	0,6	
EW 171	BPR6ES	7822	0,6	
EX 7	CR5HSB	6535	0,7	
EX 100	BR4HS	3322	0,6	
EX 350	BMR6A	7421	0,6	307
EX 500 Ser. 1138370-	BPMR4A-10	6328	1,0	
EX 500 Ser. -1138369	BPMR6A-10	1029	1,0	
EX 650	BMR4A	5728	0,6	306
EX 800	BPR4HS-10	5024	1,0	
EX 900	BR4HS	3322	0,6	
EX 1000	BR4HS	3322	0,6	
EX 1900	BPR6ES	7822	0,6	
EX 2100	BPR6ES	7822	0,6	
EX 2200	BPR6ES	7822	0,6	
EX 3000	BPR5ES	7422	0,6	
EX 3000S	BPR5ES	7422	0,6	
EX 3300	BPR6ES	7822	0,6	
EX 4000	BPR5ES	7422	0,6	
EX 4000S (GX340)	BPR5ES	7422	0,8	
EX 4500	BPR6ES	7822	0,6	

Order  
No.Quick  
No.**HONDA**

EX 5500	BPR6HS	7022	0,6	214
EXT 12 D	Y-703R	3782		
EZ 2200	BPR5ES	7422	0,7	
EZ 4500	BPR5ES-11	4424	1,1	
G 150 K1	B4H	4110	0,5	
G 200 K1	B4H	4110	0,5	
GCV 520	BPR4HS	7823	0,5	
GCV 530	BPR4HS	7823	0,8	
GD 90 /100	YS-101	5825		
GX 120 /160 /240	BPR6ES	7822	0,7	
GX 270 /340	BPR6ES	7822	0,7	
GX 390 /610 /620	BPR6ES	7822	0,7	
GX 610 K1	BPR6ES	7822	0,5	
GX 620 K1	BPR6ES	7822	0,5	
GXH 50	CR5HSB	6535	0,5	
HS 522	BPR5ES	7422	0,7	
HS 1136 (GX340CDI)	BPR5ES-11	4424	1,1	
W 40	YS-101	5825		
WB 10	BMR4A	5728	0,6	306
WB 15	BMR4A	5728	0,6	306
WH 15X	BPR6ES	7822	0,6	
WH 20X	BPR6ES	7822	0,7	
WP 20	BPR6ES	7822	0,7	
WP 30	BPR6ES	7822	0,7	
WT 30X	BPR6ES	7822	0,7	
WT 40X	BPR6ES	7822	0,7	

**JOHN DEERE**

225	BMR6A	7421	0,6	307
325	BMR6A	7421	0,6	307
375	BMR6A	7421	0,6	307
500	BMR6A	7421	0,6	307
650	BMR6A	7421	0,6	307
1750W	B4LM	3410	0,6	301
3000W	B4LM	3410	0,6	301
4000W	B4LM	3410	0,6	301
5000W	BR6HS	3922	0,6	209

**KAWASAKI**

GA 550A	BMR6A	7421	0,7	307
GA 1000A	BMR6A	7421	0,7	307
GA 1400A	BMR6A	7421	0,7	307
GA 1800A	BPR4HS	7823	0,7	
GA 2300 -83	B6S	3510	0,7	302
GA 2300A	BPR4HS	7823	0,7	
GA 2300A	BPR4HS	7823	0,8	
GA 3200A	BPR4HS	7823	0,7	
GA 3200AS	BPR4HS	7823	0,7	
GB 2300A	BPR4HS	7823	0,8	
GC 550A	BMR6A	7421	0,7	307
GD 550A	BMR6A	7421	0,7	307
GD 700A	BMR6A	7421	0,7	307



Order No.  Quick No.

## KAWASAKI

GD 700AS	BMR6A	7421	0,7	307
GE 2200A	BPR5ES	7422	0,7	
GE 2900	BPR5ES	7422	0,8	
GE 2900A	BPR5ES	7422	0,7	
GE 4000	BPR5ES	7422	0,8	
GE 4300 / A	BPR5ES	7422	0,7	
GE 4500 / A	BPR5ES	7422	0,7	
GE 5000 / AS	BPR5ES	7422	0,7	
KG 500	BM6A	5921	0,7	303
KG 550	B6HS	4510	0,7	203
KG 550B	BR6HS	3922	0,7	209
KG 600	B6HS	4510	0,7	203
KG 700	B6HS	4510	0,7	203
KG 750	B6HS	4510	0,7	203
KG 750B	BR6S	3522	0,7	
KG 900	B6S	3510	0,7	302
KG 1000	B6S	3510	0,7	302
KG 1100B	BR6S	3522	0,7	
KG 1300	B6HS	4510	0,7	203
KG 1500	B6HS	4510	0,7	203
KG 1600	BR6HS	3922	0,6	209
KG 1600B	BR6HS	3922	0,7	209
KG 2300	BPR4HS	7823	0,7	
KG 2300 (-83)	B6S	3510	0,7	302
KG 2600	BPR4HS	7823	0,7	
KG 2600 (-83)	B6S	3510	0,7	302
KG 2900	BR6HS	3922	0,7	209
KG 4000A	BR6HS	3922	0,7	209
KG 4000AS	BR6HS	3922	0,6	209
KG 5000 (-83)	BM6A	5921	0,7	303
KG 5000A	BR4HS	3322	0,7	
KG 5000AS	BR4HS	3322	0,7	
KG 5000B	BR4HS	3322	0,7	
KG 5000BS	BR4HS	3322	0,7	

## KOHLER

1,1ltr Ford 8C, 10C, 12.5C - Marine	TR5	7837	0,6	
1,1ltr Ford 8C, 10C, 12.5C - Marine	TR5	7837	0,6	
1.75MBFM	BMR6A	7421	0,6	307
1.75MBM25, 1.75MFM, 1.75MM25	BR6S	3522	0,7	
K241 10.0hp 2 KW, 3.5 KW, 5 KW	B6L	3212	0,5	
K330 /331 15.5hp 1.5 KW, 3.5 KW	B6S	3510	0,6	302
13.0hp Honda L/C 3.5 CFZ, 5CFZ - Marine	BPR6HS	7022	0,7	214
13.0hp Honda L/C 4CZ, 6.5CZ - Marine	BPR6HS	7022	0,7	214
B&S 14mm head	B2	3110	0,6	
B&S 14mm head 800 Watt	BR2LM	5798	0,5	310
KT17 17.0hp	UR4	4762	0,6	
B&S 18mm	AB6	2910	0,6	
B&S 18mm head 800 Watt	WR5	1071	0,6	
KT19 19.0hp	UR4	4762	0,6	
2.25MBFM25, 2.25MBFM45, 2.225MBM25	BMR6A	7421	0,6	307
K7 2.7hp 350 Watt	BR6S	3522	0,7	

Order  
No.Quick  
No.**KOHLER**

KT21 21.0hp	UR4	4762	0,6	
K662	BR6S	3522	0,7	
3.5MBFM45, 3.5MBFM65	BMR6A	7421	0,6	307
3.5MBM25, 3.5MBM65	BMR6A	7421	0,6	307
3.5MFM45, 3.5MFM65	BR6S	3522	0,7	
3.5MM25, 3.5MM65	BR6S	3522	0,7	
3mm25	B6S	3510	0,7	302
3MMV55	BR6S	3522	0,7	
K12 4.0hp	BR6S	3522	0,7	
K90 / 91 4.0hp	B6S	3510	0,7	302
K90 / 91 4.0hp 500 Watt	B6S	3510	0,7	302
4A-23, 7.5A-23	B6S	3510	0,7	302
4cm21 4 KW	B6L	3212	0,5	
4CM21, 5CMK21	B6L	3212	0,5	
5cmk21 5 KW	B6L	3212	0,5	
5MBM25, 5MBM65	BMR6A	7421	0,6	307
5MFM45	BR6S	3522	0,7	
5MM25, 5MM65	B6L	3212	0,5	
L160 / 161 7.0hp	B6S	3510	0,7	302
K160 / 161 7.0hp 2.5MV55	BR6S	3522	0,7	
K160 / 161 7.0hp	B6S	3510	0,7	302
75R81	AB6	2910	0,6	
K181 8.0hp	B6S	3510	0,7	302
S, D, 1 KW 18mm head	AB6	2910	0,6	
Daihatsu FE	BP5ES	6511	0,8	
FC engine 18mm head 5 KW, 10 KW	AB6	2910	0,6	
25R81, 25KW Gasoline	B6S	3510	0,7	302
50 KW, 100 KW Gasoline	AB6	2910	0,6	
K160 / 161 2.5 KW	B6S	3510	0,7	302
L160, L161, 5 KW-L160	B6S	3510	0,7	302
L600 2 KW, 3.5 KW, 5 KW	BR6S	3522	0,7	
L654	B6S	3510	0,7	302
MM25 1.5 KW, 3 KW	BR6S	3522	0,7	
Propane 25R81, 25KW	B6S	3510	0,7	302
Propane 50 KW, 100 KW	AB6	2910	0,6	
Waukesha 180GLB 10kw	AB6	2910	0,6	
Waukesha 185GLB 15kw	AB6	2910	0,6	
Waukesha 195GL 35kw	AB6	2910	0,6	
Wisconsin VH4D	AB6	2910	0,6	

**KUBOTA**

A 400 (GN550)	BMR4A	5728	0,6	306
A 800 (GN130)	BPR4HS	7823	0,6	
A 1200 (GS130)	BPR4HS	7823	0,6	
A 1800 (GN1850)	BPR4HS-10	5024	1,0	
A 2500 (GN2500)	BPR4HS-10	5024	1,0	
A 3050 (GS280)	BPR4HS	7823	0,6	

**LZDP**

P-10 DU	B5HS	4210	0,7	
P-350	B5HS	4210	0,7	
P-350-1	B5HS	4210	0,7	



Order No.  Quick No.

### MAKITA

G1200R	EY15D Robin 134cc	BR6HS	3922	0,6	209
G2410R	EH17D Robin 172cc	B6HS	4510	0,6	203
G2400R	EY20D Robin 183cc	BR6HS	3922	0,7	209
G3510R, G3511R	EH25D Robin 251cc	B6HS	4510	0,6	203
G3500R, G3501R	EY28D Robin 273cc	BPR6HS	7022	0,7	214
G5710R, G5711R	EH34D Robin 338cc	BR6ES	4922	0,5	
G5500R, G5501R	EY40D Robin 388cc	BPR4HS	7823	0,8	
G1200R	Robin EY15D 143CC	BR6HS	3922	0,6	209
G2400R	Robin EY20D 183CC	BR6HS	3922	0,6	209
G2410R	Robin EH17D 172CC	B6HS	4510	0,6	203
G2800R		BR6HS	3922	0,7	209
G3500R	Robin EY28D 273CC	BPR6HS	7022	0,6	214
G3501R	Robin EY28D 273CC	BPR6HS	7022	0,6	214
G3510R	Robin EH25D 251CC	B6HS	4510	0,6	203
G3511R	Robin EH25D 251CC	B6HS	4510	0,6	203
G5500R	Robin EY40D 388CC	BPR4HS	7823	0,6	
G5501R	Robin EY40D 388CC	BPR4HS	7823	0,6	
G5710R	Robin EH34D 388CC	BR6ES	4922	0,6	
G5711R	Robin EH34D 388CC	BR6ES	4922	0,6	

### McCULLOCH

All Other Models		BM6A	5921	0,7	303
H-1500		BR6S	3522	0,7	
H-2000,H-3000		BR6S	3522	0,7	
HP-1200		BR6S	3522	0,7	
HP-2000,HP-3000		BR6S	3522	0,7	
HP-3500, HP-3500 Deluxe		BR6S	3522	0,7	
HP-5000, HP-5000 Deluxe		BR6S	3522	0,7	
Mark I, Mark II, Mark III		BR6S	3522	0,7	
MPP1500E		B4H	4110	0,5	
MPP2300E		B4H	4110	0,5	
MPP3500E		B4H	4110	0,5	
MPP600E,MPP800E		B4H	4110	0,5	
RA120, RA150		BMR6A	7421	0,6	307
RA200		BMR6A	7421	0,6	307
RA330		BMR6A	7421	0,6	307
RA400ES		BMR6A	7421	0,6	307

### MITSUBISHI

TL 26		BMR6A	7421	0,6	307
TL 33		BMR6A	7421	0,6	307
TL 43		BMR6A	7421	0,6	307
TL 52		BMR6A	7421	0,6	307

### NISSAN

D11		BR4ES	1097	0,7	
H20		BR4ES	1097	0,7	
H30		BR4HS	3322	0,7	
J15		BR4ES	1097	0,7	
MA10		BR4ES	1097	0,7	
P40		BR4ES	1097	0,7	



Order  
No.Quick  
No.**ONAN**

Pro 6000E	TR5	7837	0,6	
MAJ,MJA,MCK - Marine	B6L	3212	0,5	
Pro 5000,5000E	TR5	7837	0,6	
Pro 4000,4000E	BPR4HS	7823	0,5	
NH Gemini	B6L	3212	0,5	
MJB,MJC,MKH - Marine	B6L	3212	0,5	
Marquis I/III	TR4	4392	0,6	
2.5 MAJB - Marine	B6L	3212	0,5	
2.7 AJ Spec. K-N	BMR6A	7421	0,6	307
2.8 Micro	BPR4HS	7823	0,5	
3.0 AJ	TR5	7837	0,6	
3.0 MAJB - Marine	B6L	3212	0,5	
4.0 BGD/E	TR5	7837	0,6	
4.0 Micro	BPR5ES	7422	0,6	
9.0 MME - Marine	BPR5ES	7422	0,6	
CCK (Normal Service)	B6L	3212	0,5	
CCK (Natural Gas)	B7S	3710	0,7	
CCK (Light Service)	B4L	3112	0,5	
AJ	B6L	3212	0,5	
4.5 MCE - Marine	TR5	7837	0,6	
8.0 MME - Marine	BPR5ES	7422	0,8	
6.5NHE	TR5	7837	0,6	
6.5NHD/E	TR5	7837	0,6	
6.5NH-CR-16004P	TR5	7837	0,6	
6.5NH-CR-16004N	BR6ES	4922	0,5	
6.5NH Spec. J & K	BR6ES	4922	0,6	
6.5NH Spec. A-D	B6L	3212	0,5	
6.5 MCE - Marine	TR5	7837	0,6	
BF Gemini	B6L	3212	0,5	
0,3TL-212R/1A	B4LM	3410	0,5	301
10JC, 15JC	B6L	3212	0,5	
1B	A6	1010	0,5	
2,7AJ Spec. K-N	BMR6A	7421	0,5	307
3,0AJ	TR5	7837	0,6	
5JB	B6L	3212	0,5	
6,5NH Spec. A-D	B6L	3212	0,5	
6,5NH Spec. J+K	BR6ES	4922	0,5	
AAE / AH / AK	B6L	3212	0,5	
BF Gemini	B6L	3212	0,4	
CCK leichte Belastung	B4L	3112	0,5	
CCK normale Belastung	B6L	3212	0,5	
CK	B6L	3212	0,5	
CUA	B4L	3112	0,6	
CW	A6	1010	0,5	
EL	B6L	3212	0,5	
GO	B6S	3510	0,5	302
H60	B6L	3212	0,5	
HC	A6	1010	0,5	
HH20	B6L	3212	0,5	
HK / HN / HR	A6	1010	0,5	
IC	B6S	3510	0,5	302
J30	B6L	3212	0,5	

Order  
No.Quick  
No.**ONAN**

JA / JB / JC	B6L	3212	0,5	
JT	A6	1010	0,5	
KA / KB	B6S	3510	0,5	302
KKA	B4L	3112	0,6	
KR	B6S	3510	0,5	302
LK-LKB	B6L	3212	0,5	
MAJ / MCK	B6L	3212	0,5	
MGO	B6S	3510	0,5	302
MJA / MJB / MJC	B6L	3212	0,5	
MKH	B6L	3212	0,5	
MPG	B6S	3510	0,5	302
MTK	A6	1010	0,5	
MUK	B6S	3510	0,5	302
NB	B6L	3212	0,5	
NH Gemini	B6L	3212	0,4	
NHC	BR6ES	4922	0,5	
OTC	B6S	3510	0,5	302
V45	A6	1010	0,5	
W4A	A6	1010	0,5	
WIB	B6S	3510	0,5	302

**SUZUKI**

SE 400 / A / C / T	BPMR4A	6028	0,7	
SE 500 / A / C	BPMR4A	6028	0,7	
SE 600	BPMR4A	6028	0,6	
SE 700 / A	BPMR6A	6726	0,7	308
SE 800	BPMR4A	6028	0,6	
SE1000	BPR6HS	7022	0,7	214
SE1200 / A / L / LA	BPR6HS	7022	0,7	214
SE1500	BPR6HS	7022	0,7	214
SE1800 / A / K / KL / L / LA	BPR6ES	7822	0,7	
SE2500 / A / K	BPR6HS	7022	0,7	214
SE3000 / A	BPR6HS	7022	0,7	214
SV 1400	BPR6ES	7822	0,8	
SV 2200	BPR6ES	7822	0,8	
SV 4000	BPR5ES	7422	0,7	
SVW 140	BPR5ES	7422	0,7	
V 270	BPR6HS	7022	0,7	214
VM 140	BPMR6A	6726	0,7	308

**TANAKA**

REG-800, REG-1000	B7S	3710	0,7	
SEG-100	B6S	3510	0,7	302
DEG-600	B6S	3510	0,7	302
REG-80	B6S	3510	0,7	302
QEG-250, QEG-300	BM6A	5921	0,7	303
SEG-221	B6HS	4510	0,6	203
LEG-1200	B6S	3510	0,7	302

**YAMAHA**

EF 600	BPMR6A	6726	0,6	308
EF 1000	BPR6HS	7022	0,6	214

Order  
No.Quick  
No.**YAMAHA**

EF 1000 B	BPR6HS	7022	0,6	214
EF 1200 / DV	BPR6HS	7022	0,6	214
EF 1400	BPR6HS	7022	0,6	214
EF 1400 / A / DV	BPR6HS	7022	0,6	214
EF 1400 A	BPR4ES	7222	0,7	
EF 1400 X	BPR4ES	7222	0,7	
EF 1400K	BPR4HS	7823	0,6	
EF 1500S	B7HS	5110	0,7	204
EF 1600	BPR6HS	7022	0,7	214
EF 1700 / A / DV	BPR6HS	7022	0,7	214
EF 1800	BP6HS	4511	0,7	
EF 2000 / EF2000DV -84	BP6HS	4511	0,7	
EF 2000 / A / DV 85-	BPR6HS	7022	0,7	214
EF 2000A	BPR6HS	7022	0,7	214
EF 2000H	BP6HS	4511	0,7	
EF 2000HK	BP4HS	3611	0,7	
EF 2000K 85-	BPR4HS	7823	0,7	
EF 2000K -84	BP4HS	3611	0,7	
EF 2100	BPR6HS	7022	0,7	214
EF 2300 A	BPR4ES	7222	0,7	
EF 2300 X	BPR4ES	7222	0,7	
EF 2400 -84	BP6HS	4511	0,7	
EF 2400 A / DV	BPR6HS	7022	0,7	214
EF 2500 / R (2100R)	BPR6HS	7022	0,7	214
EF 2600	BP6HS	4511	0,7	
EF 2800 / EF2800DV -84	BP6HS	4511	0,7	
EF 2800 / DV 85-	BPR6HS	7022	0,7	214
EF 2800A	BPR6HS	7022	0,7	214
EF 2800H	BP6HS	4511	0,6	
EF 2800HK	BP4HS	3611	0,7	
EF 2800K 85-	BPR4HS	7823	0,7	
EF 2800K -84	BP4HS	3611	0,7	
EF 3200 / EF 3800	BPR6HS	7022	0,7	214
EF 3200 E	BPR6HS	7022	0,6	214
EF 3600(E) / DV(E)	BPR6HS	7022	0,7	214
EF 3800R (3200R)	BPR6HS	7022	0,7	214
EF 4000 / DV / E	BPR6HS	7022	0,7	214
EF 4000 A	BPR4ES	7222	0,7	
EF 4000 EX	BPR4ES	7222	0,7	
EF 4000 X	BPR4ES	7222	0,7	
EF 4000K	BPR4HS	7823	0,7	
EF 4300	BPR6HS	7022	0,7	214
EF 4400 (E) / EF 4400DV (E)	BPR6HS	7022	0,7	214
EF 4400	BPR6HS	7022	0,7	214
EF 5000	BPR5ES	7422	0,7	
EF 5000(E) / DV(E)	BPR6HS	7022	0,7	214
EF 5400 / E	BPR5ES	7422	0,7	
EF 5500 A	BPR4ES	7222	0,7	
EF 5500 EX	BPR4ES	7222	0,7	
EF 5500 X	BPR4ES	7222	0,7	
EF 6000	BPR5ES	7422	0,7	
EFC 1400	BP6HS	4511	0,7	



Order No.  Quick No.

## YAMAHA

EFC 2000	BP6HS	4511	0,7	
EFC 2600	BP6HS	4511	0,7	
EFC 2800	BP6HS	4511	0,7	
ET 350	B5ES	6410	0,7	
ET 500	B5ES	6410	0,7	
ET 600 (A)	B5ES	6410	0,7	
ET 800	B5ES	6410	0,7	
ET 900 (A)	B5ES	6410	0,7	
ET 1500 -80	B6HS	4510	0,7	203
ET 1500 81-	B7HS	5110	0,7	204
ET 1500D / M / S	B7HS	5110	0,7	204
MF 150A / S	BP6HS	4511	0,6	
MF 180A / AR / S / SR	BP6HS	4511	0,6	
MF 180K / AK / SK	BP4HS	3611	0,6	
MF 260A / AR / S / SR	BP6HS	4511	0,6	
MF 260K / AK / SK	BP4HS	3611	0,6	
MF 410 / S / SR	BP6HS	4511	0,6	
MF 410SK	BP4HS	3611	0,6	
MT 110A / AR	B7HS	5110	0,6	204
MT 110VL	B7HS	5110	0,6	204
YG 300S	BPR6HS	7022	0,7	214
YG 400D	BPR6HS	7022	0,7	214
YG 500D	BPR5ES	7422	0,8	
YG 600D	BPR5ES	7422	0,8	
YP 2	B7HS	5110	0,6	204
YP 3	BP6HS	4511	0,6	
YP 10	BR7HS	4122	0,7	211
YP 10G	BR7HS	4122	0,7	211
YP 15H	BP6HS	4511	0,6	
YP 20	BP4HS	3611	0,6	
YP 20G (N)	BP4HS-10	5011	1,0	
YP 20G	B7HS	5110	0,6	204
YP 20GA	BPR6HS	7022	0,7	214
YP 20GN	BP4HS	3611	0,7	
YP 20M /S /Z /H	BP6HS	4511	0,6	
YP 20MH	BP6HS	4511	0,6	
YP 20NT	BP6HS	4511	0,6	
YP 20S	BP6HS	4511	0,7	
YP 20TA	BPR6HS	7022	0,7	214
YP 30	BP5ES	6511	0,6	
YP 30E	BP4HS	3611	0,6	
YP 30G	BP6HS	4511	0,6	
YP 30GA	BPR6HS	7022	0,7	214
YP 30GK	BP4HS	3611	0,6	
YP 30GN 88-90	BP5ES	6511	0,8	
YP 30GN -87	BP6HS	4511	0,7	
YP 30MH	BP6HS	4511	0,7	
YP 30S / T / NT	BP6HS	4511	0,6	
YP 30TA	BPR6HS	7022	0,7	214
YP 40 TA	BPR6HS	7022	0,7	214



# Diverse Arbeitsgeräte / Various Tools



Order No.  Quick No.

<b>ACME</b>					
A180B	Mehrzweckmotor	BP5HS	4111	0,6	
A220B	Mehrzweckmotor	BP5HS	4111	0,6	
A230B	Mehrzweckmotor	BP5HS	4111	0,6	
A349	Mehrzweckmotor	B4H	4110	0,6	
A360	Mehrzweckmotor	B4H	4110	0,6	
ACT280 OHC	Mehrzweckmotor	BKR5E	7938	0,6	
ACT340 OHC	Mehrzweckmotor	BKR5E	7938	0,6	
AL480WB	Mehrzweckmotor	BP5HS	4111	0,6	
AL550WB	Mehrzweckmotor	BP5HS	4111	0,6	
ALN290WB	Mehrzweckmotor	BP5HS	4111	0,6	
ALN330WB	Mehrzweckmotor	BP5HS	4111	0,6	
AT220 OHV	Mehrzweckmotor	BP5HS	4111	0,6	
AT330 OHV	Mehrzweckmotor	BP5HS	4111	0,6	
VT88 OHV	Mehrzweckmotor	BP5HS	4111	0,6	
VT94 OHV	Mehrzweckmotor	BP5HS	4111	0,6	
<b>AGROS</b>					
Agros		B5HS	4210	0,7	
<b>AL-KO</b>					
750 B Tecna	Laubsauger	BR2LM	5798	0,5	310
Aspera		B4LM	3410	0,5	301
B & S 12,5-20PS mit AVS 1&2Zyl	Aufsitzmäher/Traktor-Motoren	BKR5ES	2460	0,7	
B & S 10,5-13,5PS ohne OHV	Aufsitzmäher/Traktor-Motoren	BR2LM	5798	0,5	310
B & S 12,5-17PS OHV	Aufsitzmäher/Traktor-Motoren	BKR5ES	2460	0,7	
B&S 4Takt	Rasenmäher-Motoren	BR4LM	4133	0,5	
Honda 4 Takt	Rasenmäher-Motoren	BPR5ES	7422	0,7	
Tecumseh 11-13PS OHV	Aufsitzmäher/Traktor-Motoren	BR7ES	5122	0,7	
Tecumseh 4 Takt	Rasenmäher-Motoren	BR6S	3522	0,6	
<b>AS MOTOR</b>					
AS 120 A	Mehrzweckmotor	B6HS	4510	0,6	203
AS 120 C/D	Mehrzweckmotor	B6HS	4510	0,6	203
AS 165 A	Mehrzweckmotor	B6HS	4510	0,6	203
AS 165 D/F	Mehrzweckmotor	B6HS	4510	0,6	203
AS 165 E	Mehrzweckmotor	B6HS	4510	0,6	203
AS 165 G	Mehrzweckmotor	B6HS	4510	0,6	203
AS 165 H	Mehrzweckmotor	B6HS	4510	0,6	203
AS 165 I	Mehrzweckmotor	B6HS	4510	0,6	203
AS 165 K	Mehrzweckmotor	B6HS	4510	0,6	203
AS 165 L	Mehrzweckmotor	B6HS	4510	0,6	203
AS 165 M	Mehrzweckmotor	B6HS	4510	0,6	203
AS 165 N	Mehrzweckmotor	B6HS	4510	0,6	203
S-B 6	Häcksler	B6HS	4510	0,5	203
<b>B &amp; S MOTOREN</b>					
407600 Series 2 Cly. OHV		BKR5E	7938	0,7	
402500 Series 2 Cly. OHV		BKR5E	7938	0,7	
407500 Series 2 Cly. OHV		BKR5E	7938	0,7	
28CH00 Series ELS-Extended Life Serie		BKR5E	7938	0,7	
40F700 Series ELS-Extended Life Serie		BKR5E	7938	0,7	
125400 Series ELS-Extended Life Serie		BKR5E	7938	0,7	

# Diverse Arbeitsgeräte / Various Tools



Order  
No.



Quick  
No.

## B & S MOTOREN

28AH00 Series ELS-Extended Life Serie	BKR5E	7938	0,7
446800 Series ELS-Extended Life Serie	BKR5E	7938	0,7
446700 Series ELS-Extended Life Serie	BKR5E	7938	0,7
31J700 Series ELS-Extended Life Serie	BKR5E	7938	0,7
28BH00 Series ELS-Extended Life Serie	BKR5E	7938	0,7
446900 Series ELS-Extended Life Serie	BKR5E	7938	0,7
40H700 Series ELS-Extended Life Serie	BKR5E	7938	0,7
40G700 Series ELS-Extended Life Serie	BKR5E	7938	0,7
31M700 Series ELS-Extended Life Serie	BKR5E	7938	0,7
31L700 Series ELS-Extended Life Serie	BKR5E	7938	0,7
446600 Series ELS-Extended Life Serie	BKR5E	7938	0,7
31K700 Series ELS-Extended Life Serie	BKR5E	7938	0,7
125300 Series ELS-Extended Life Serie	BKR5E	7938	0,7
12C400 Series Intek Single Cyl. OHV	BKR5E	7938	0,7
122600 Series Intek Single Cyl. OHV	BKR5E	7938	0,5
113400 Series Intek Single Cyl. OHV	BKR5E	7938	0,7
123300 Series Intek Single Cyl. OHV	BKR5E	7938	0,7
110400 Series Intek Single Cyl. OHV	BKR5E	7938	0,7
110600 Series Intek Single Cyl. OHV	BKR5E	7938	0,5
111400 Series Intek Single Cyl. OHV	BKR5E	7938	0,7
111600 Series Intek Single Cyl. OHV	BKR5E	7938	0,5
11C600 Series Intek Single Cyl. OHV	BKR5E	7938	0,5
120400 Series Intek Single Cyl. OHV	BKR5E	7938	0,7
120600 Series Intek Single Cyl. OHV	BKR5E	7938	0,5
12E300 Series Intek Single Cyl. OHV	BKR5E	7938	0,7
125600 Series Intek Single Cyl. OHV	BKR5E	7938	0,5
121A00 Series Intek Single Cyl. OHV	BKR5E	7938	0,7
12A400 Series Intek Single Cyl. OHV	BKR5E	7938	0,7
123400 Series Intek Single Cyl. OHV	BKR5E	7938	0,7
201400 Series Intek Single Cyl. OHV	BKR5E	7938	0,7
124600 Series Intek Single Cyl. OHV	BKR5E	7938	0,7
127300 Series Intek Single Cyl. OHV	BKR5E	7938	0,7
121400 Series Intek Single Cyl. OHV	BKR5E	7938	0,7
121300 Series Intek Single Cyl. OHV	BKR5E	7938	0,7
31H700 Series Intek Single Cyl. OHV	BKR5E	7938	0,7
127400 Series Intek Single Cyl. OHV	BKR5E	7938	0,5
129600 Series Intek Single Cyl. OHV	BKR5E	7938	0,5
12D400 Series Intek Single Cyl. OHV	BKR5E	7938	0,7
12B400 Series Intek Single Cyl. OHV	BKR5E	7938	0,7
12B600 Series Intek Single Cyl. OHV	BKR5E	7938	0,5
12C600 Series Intek Single Cyl. OHV	BKR5E	7938	0,5
12D600 Series Intek Single Cyl. OHV	BKR5E	7938	0,5
12C300 Series Intek Single Cyl. OHV	BKR5E	7938	0,7
12B300 Series Intek Single Cyl. OHV	BKR5E	7938	0,7
123600 Series Intek Single Cyl. OHV	BKR5E	7938	0,7
126600 Series Intek Single Cyl. OHV	BKR5E	7938	0,5
128600 Series Intek Single Cyl. OHV	BKR5E	7938	0,5
12F600 Series Intek Single Cyl. OHV	BKR5E	7938	0,5
12G600 Series Intek Single Cyl. OHV	BKR5E	7938	0,5
12H600 Series Intek Single Cyl. OHV	BKR5E	7938	0,5
129400 Series Intek Single Cyl. OHV	BKR5E	7938	0,7
12A600 Series Intek Single Cyl. OHV	BKR5E	7938	0,5

# Diverse Arbeitsgeräte / Various Tools



Order  
No.



Quick  
No.

## B & S MOTOREN

12D300 Series Intek Single Cyl. OHV	BKR5E	7938	0,7
12Z600 Series Intek Single Cyl. OHV	BKR5E	7938	0,5
20A400 Series Intek Single Cyl. OHV	BKR5E	7938	0,7
127600 Series Intek Single Cyl. OHV	BKR5E	7938	0,5
20A100 Series Intek Single Cyl. OHV	BKR5E	7938	0,7
31F700 Series Intek Single Cyl. OHV	BKR5E	7938	0,7
202400 Series Intek Single Cyl. OHV	BKR5E	7938	0,7
21A700 Series Intek Single Cyl. OHV	BKR5E	7938	0,7
210700 Series Intek Single Cyl. OHV	BKR5E	7938	0,7
20E400 Series Intek Single Cyl. OHV	BKR5E	7938	0,7
212900 Series Intek Single Cyl. OHV	BKR5E	7938	0,7
204400 Series Intek Single Cyl. OHV	BKR5E	7938	0,7
314700 Series Intek Single Cyl. OHV	BKR5E	7938	0,7
206400 Series Intek Single Cyl. OHV	BKR5E	7938	0,7
284H00 Series Intek Single Cyl. OHV	BKR5E	7938	0,7
20B400 Series Intek Single Cyl. OHV	BKR5E	7938	0,7
20E300 Series Intek Single Cyl. OHV	BKR5E	7938	0,7
203400 Series Intek Single Cyl. OHV	BKR5E	7938	0,7
20C400 Series Intek Single Cyl. OHV	BKR5E	7938	0,7
214900 Series Intek Single Cyl. OHV	BKR5E	7938	0,7
20E200 Series Intek Single Cyl. OHV	BKR5E	7938	0,7
20E100 Series Intek Single Cyl. OHV	BKR5E	7938	0,7
20D400 Series Intek Single Cyl. OHV	BKR5E	7938	0,7
215900 Series Intek Single Cyl. OHV	BKR5E	7938	0,7
205400 Series Intek Single Cyl. OHV	BKR5E	7938	0,7
217900 Series Intek Single Cyl. OHV	BKR5E	7938	0,7
128300 Series Intek Single Cyl. OHV	BKR5E	7938	0,7
128400 Series Intek Single Cyl. OHV	BKR5E	7938	0,7
12A300 Series Intek Single Cyl. OHV	BKR5E	7938	0,7
121600 Series Intek Single Cyl. OHV	BKR5E	7938	0,5
285H00 Series Intek Single Cyl. OHV	BKR5E	7938	0,7
20G400 Series Intek Single Cyl. OHV	BKR5E	7938	0,7
216900 Series Intek Single Cyl. OHV	BKR5E	7938	0,7
312700 Series Intek Single Cyl. OHV	BKR5E	7938	0,7
218700 Series Intek Single Cyl. OHV	BKR5E	7938	0,7
15B100 Series Intek Single Cyl. OHV	BKR5E	7938	0,7
15A100 Series Intek Single Cyl. OHV	BKR5E	7938	0,7
21B900 Series Intek Single Cyl. OHV	BKR5E	7938	0,7
20F400 Series Intek Single Cyl. OHV	BKR5E	7938	0,7
311700 Series Intek Single Cyl. OHV	BKR5E	7938	0,7
283H00 Series Intek Single Cyl. OHV	BKR5E	7938	0,7
219900 Series Intek Single Cyl. OHV	BKR5E	7938	0,7
21A400 Series Intek Single Cyl. OHV	BKR5E	7938	0,7
31E700 Series Intek Single Cyl. OHV	BKR5E	7938	0,7
213400 Series Intek Single Cyl. OHV	BKR5E	7938	0,7
310700 Series Intek Single Cyl. OHV	BKR5E	7938	0,7
286H00 Series Intek Single Cyl. OHV	BKR5E	7938	0,7
406700 Series Intek V-Twin OHV	BKR5E	7938	0,7
445700 Series Intek V-Twin OHV	BKR5E	7938	0,7
405700 Series Intek V-Twin OHV	BKR5E	7938	0,7
407700 Series Intek V-Twin OHV	BKR5E	7938	0,7
406500 Series Intek V-Twin OHV	BKR5E	7938	0,7



# Diverse Arbeitsgeräte / Various Tools



Order  
No.



Quick  
No.

## B & S MOTOREN

Old Series	B2LM	1147	0,7	
Old Series	A6	1010	0,7	
48A700 Series Opposed Twin Cyl. "L" Head	BR2LM	5798	0,7	310
421700 Series Opposed Twin Cyl. "L" Head	BR2LM	5798	0,7	310
462700 Series Opposed Twin Cyl. "L" Head	BR2LM	5798	0,7	310
463700 Series Opposed Twin Cyl. "L" Head	BR2LM	5798	0,7	310
404700 Series Opposed Twin Cyl. "L" Head	BR2LM	5798	0,7	310
42C700 Series Opposed Twin Cyl. "L" Head	BR2LM	5798	0,7	310
42B700 Series Opposed Twin Cyl. "L" Head	BR2LM	5798	0,7	310
402700 Series Opposed Twin Cyl. "L" Head	BR2LM	5798	0,7	310
402400 Series Opposed Twin Cyl. "L" Head	BR2LM	5798	0,7	310
401700 Series Opposed Twin Cyl. "L" Head	BR2LM	5798	0,7	310
401400 Series Opposed Twin Cyl. "L" Head	BR2LM	5798	0,7	310
42E700 Series Opposed Twin Cyl. "L" Head	BR2LM	5798	0,7	310
461700 Series Opposed Twin Cyl. "L" Head	BR2LM	5798	0,7	310
42A700 Series Opposed Twin Cyl. "L" Head	BR2LM	5798	0,7	310
42D700 Series Opposed Twin Cyl. "L" Head	BR2LM	5798	0,7	310
460700 Series Opposed Twin Cyl. "L" Head	BR2LM	5798	0,7	310
422700 Series Opposed Twin Cyl. "L" Head	BR2LM	5798	0,7	310
404400 Series Opposed Twin Cyl. "L" Head	BR2LM	5798	0,7	310
400700 Series Opposed Twin Cyl. "L" Head	BR2LM	5798	0,7	310
421400 Series Opposed Twin Cyl. "L" Head	BR2LM	5798	0,7	310
422400 Series Opposed Twin Cyl. "L" Head	BR2LM	5798	0,7	310
400400 Series Opposed Twin Cyl. "L" Head	BR2LM	5798	0,7	310
256400 Series Single Cyl. "L" Head	BR2LM	5798	0,7	310
301400 Series Single Cyl. "L" Head	BR2LM	5798	0,7	310
28F700 Series Single Cyl. "L" Head	BR2LM	5798	0,7	310
28M700 Series Single Cyl. "L" Head	BR2LM	5798	0,7	310
28T700 Series Single Cyl. "L" Head	BR2LM	5798	0,7	310
28R700 Series Single Cyl. "L" Head	BR2LM	5798	0,7	310
302400 Series Single Cyl. "L" Head	BR2LM	5798	0,7	310
28D700 Series Single Cyl. "L" Head	BR2LM	5798	0,7	310
320400 Series Single Cyl. "L" Head	BR2LM	5798	0,7	310
325400 Series Single Cyl. "L" Head	BR2LM	5798	0,7	310
326400 Series Single Cyl. "L" Head	BR2LM	5798	0,7	310
28V700 Series Single Cyl. "L" Head	BR2LM	5798	0,7	310
282700 Series Single Cyl. "L" Head	BR2LM	5798	0,7	310
221400 Series Single Cyl. "L" Head	BR2LM	5798	0,7	310
258700 Series Single Cyl. "L" Head	BR2LM	5798	0,7	310
259700 Series Single Cyl. "L" Head	BR2LM	5798	0,7	310
28C700 Series Single Cyl. "L" Head	BR2LM	5798	0,7	310
259700 Series Single Cyl. "L" Head	BR2LM	5798	0,7	310
286700 Series Single Cyl. "L" Head	BR2LM	5798	0,7	310
281700 Series Single Cyl. "L" Head	BR2LM	5798	0,7	310
257400 Series Single Cyl. "L" Head	BR2LM	5798	0,7	310
283700 Series Single Cyl. "L" Head	BR2LM	5798	0,7	310
284700 Series Single Cyl. "L" Head	BR2LM	5798	0,7	310
19B400 Series Single Cyl. "L" Head	BKR5E	7938	0,7	
285700 Series Single Cyl. "L" Head	BR2LM	5798	0,7	310
121K00 Series Single Cyl. "L" Head	BR2LM	5798	0,7	310
288700 Series Single Cyl. "L" Head	BR2LM	5798	0,7	310
280700 Series Single Cyl. "L" Head	BR2LM	5798	0,7	310

# Diverse Arbeitsgeräte / Various Tools



Order  
No.



Quick  
No.

## B & S MOTOREN

222400 Series Single Cyl. "L" Head	BR2LM	5798	0,7	310
254400 Series Single Cyl. "L" Head	BR2LM	5798	0,7	310
254400 Series Single Cyl. "L" Head	BR2LM	5798	0,7	310
253000 Series Single Cyl. "L" Head	BR2LM	5798	0,7	310
252000 Series Single Cyl. "L" Head	BR2LM	5798	0,7	310
251700 Series Single Cyl. "L" Head	BR2LM	5798	0,7	310
251400 Series Single Cyl. "L" Head	BR2LM	5798	0,7	310
250400 Series Single Cyl. "L" Head	BR2LM	5798	0,7	310
28B700 Series Single Cyl. "L" Head	BR2LM	5798	0,7	310
28A700 Series Single Cyl. "L" Head	BR2LM	5798	0,7	310
257700 Series Single Cyl. "L" Head	BR2LM	5798	0,7	310
256700 Series Single Cyl. "L" Head	BR2LM	5798	0,7	310
255700 Series Single Cyl. "L" Head	BR2LM	5798	0,7	310
200400 Series Single Cyl. "L" Head	BR2LM	5798	0,7	310
198700 Series Single Cyl. "L" Head	BR2LM	5798	0,7	310
19K400 Series Single Cyl. "L" Head	BR2LM	5798	0,7	310
289700 Series Single Cyl. "L" Head	BR2LM	5798	0,7	310
254700 Series Single Cyl. "L" Head	BR2LM	5798	0,7	310
233400 Series Single Cyl. "L" Head	BR2LM	5798	0,7	310
19A400 Series Single Cyl. "L" Head	BKR5E	7938	0,7	
19C400 Series Single Cyl. "L" Head	BKR5E	7938	0,7	
243400 Series Single Cyl. "L" Head	BR2LM	5798	0,7	310
300400 Series Single Cyl. "L" Head	BR2LM	5798	0,7	310
257700 Series Single Cyl. "L" Head	BR2LM	5798	0,7	310
19E400 Series Single Cyl. "L" Head	BKR5E	7938	0,7	
19F400 Series Single Cyl. "L" Head	BKR5E	7938	0,7	
19G400 Series Single Cyl. "L" Head	BKR5E	7938	0,7	
220400 Series Single Cyl. "L" Head	BR2LM	5798	0,7	310
220700 Series Single Cyl. "L" Head	BR2LM	5798	0,7	310
121H00 Series Single Cyl. "L" Head	BR2LM	5798	0,7	310
231400 Series Single Cyl. "L" Head	BR2LM	5798	0,7	310
137200 Series Single Cyl. "L" Head	BR2LM	5798	0,7	310
12H700 Series Single Cyl. "L" Head	BR2LM	5798	0,7	310
197400 Series Single Cyl. "L" Head	BR2LM	5798	0,7	310
134200 Series Single Cyl. "L" Head	BR2LM	5798	0,7	310
196400 Series Single Cyl. "L" Head	BR2LM	5798	0,7	310
233400 Series Single Cyl. "L" Head	BR2LM	5798	0,7	310
195700 Series Single Cyl. "L" Head	BR2LM	5798	0,7	310
195400 Series Single Cyl. "L" Head	BR2LM	5798	0,7	310
194700 Series Single Cyl. "L" Head	BR2LM	5798	0,7	310
194400 Series Single Cyl. "L" Head	BR2LM	5798	0,7	310
193700 Series Single Cyl. "L" Head	BR2LM	5798	0,7	310
193400 Series Single Cyl. "L" Head	BR2LM	5798	0,7	310
192700 Series Single Cyl. "L" Head	BR2LM	5798	0,7	310
12K800 Series Single Cyl. "L" Head	BR2LM	5798	0,7	310
191700 Series Single Cyl. "L" Head	BR2LM	5798	0,7	310
226400 Series Single Cyl. "L" Head	BR2LM	5798	0,7	310
137000 Series Single Cyl. "L" Head	BR2LM	5798	0,7	310
134400 Series Single Cyl. "L" Head	BR2LM	5798	0,7	310
142300 Series Single Cyl. "L" Head	BR2LM	5798	0,7	310
142400 Series Single Cyl. "L" Head	BR2LM	5798	0,7	310
142700 Series Single Cyl. "L" Head	BR2LM	5798	0,7	310

# Diverse Arbeitsgeräte / Various Tools



Order  
No.



Quick  
No.

## B & S MOTOREN

170700 Series Single Cyl. "L" Head	BR2LM	5798	0,7	310
171400 Series Single Cyl. "L" Head	BR2LM	5798	0,7	310
171700 Series Single Cyl. "L" Head	BR2LM	5798	0,7	310
176400 Series Single Cyl. "L" Head	BR2LM	5798	0,7	310
190400 Series Single Cyl. "L" Head	BR2LM	5798	0,7	310
190700 Series Single Cyl. "L" Head	BR2LM	5798	0,7	310
170400 Series Single Cyl. "L" Head	BR2LM	5798	0,7	310
192400 Series Single Cyl. "L" Head	BR2LM	5798	0,7	310
129700 Series Single Cyl. "L" Head	BR2LM	5798	0,7	310
12X800 Series Single Cyl. "L" Head	BR2LM	5798	0,7	310
12W800 Series Single Cyl. "L" Head	BR2LM	5798	0,7	310
12V800 Series Single Cyl. "L" Head	BR2LM	5798	0,7	310
136200 Series Single Cyl. "L" Head	BR2LM	5798	0,7	310
12R800 Series Single Cyl. "L" Head	BR2LM	5798	0,7	310
12Q800 Series Single Cyl. "L" Head	BR2LM	5798	0,7	310
12P800 Series Single Cyl. "L" Head	BR2LM	5798	0,7	310
12N800 Series Single Cyl. "L" Head	BR2LM	5798	0,7	310
12M800 Series Single Cyl. "L" Head	BR2LM	5798	0,7	310
12J800 Series Single Cyl. "L" Head	BR2LM	5798	0,7	310
12H800 Series Single Cyl. "L" Head	BR2LM	5798	0,7	310
133700 Series Single Cyl. "L" Head	BR2LM	5798	0,7	310
197700 Series Single Cyl. "L" Head	BR2LM	5798	0,7	310
12J700 Series Single Cyl. "L" Head	BR2LM	5798	0,7	310
196700 Series Single Cyl. "L" Head	BR2LM	5798	0,7	310
128H00 Series Single Cyl. "L" Head	BR2LM	5798	0,7	310
128800 Series Single Cyl. "L" Head	BR2LM	5798	0,7	310
128700 Series Single Cyl. "L" Head	BR2LM	5798	0,7	310
126H00 Series Single Cyl. "L" Head	BR2LM	5798	0,7	310
125K00 Series Single Cyl. "L" Head	BR2LM	5798	0,7	310
125H00 Series Single Cyl. "L" Head	BR2LM	5798	0,7	310
124K00 Series Single Cyl. "L" Head	BR2LM	5798	0,7	310
124H00 Series Single Cyl. "L" Head	BR2LM	5798	0,7	310
123K00 Series Single Cyl. "L" Head	BR2LM	5798	0,7	310
123J00 Series Single Cyl. "L" Head	BR2LM	5798	0,7	310
123700 Series Single Cyl. "L" Head	BR2LM	5798	0,7	310
122K00 Series Single Cyl. "L" Head	BR2LM	5798	0,7	310
129800 Series Single Cyl. "L" Head	BR2LM	5798	0,7	310
129H00 Series Single Cyl. "L" Head	BR2LM	5798	0,7	310
12A800 Series Single Cyl. "L" Head	BR2LM	5798	0,7	310
120J00 Series Single Cyl. "L" Head	BR2LM	5798	0,7	310
92400 Series Single Cyl. "L" Head	BR2LM	5798	0,7	310
135400 Series Single Cyl. "L" Head	BR2LM	5798	0,7	310
135700 Series Single Cyl. "L" Head	BR2LM	5798	0,7	310
133700 Series Single Cyl. "L" Head	BR2LM	5798	0,7	310
133400 Series Single Cyl. "L" Head	BR2LM	5798	0,7	310
133200 Series Single Cyl. "L" Head	BR2LM	5798	0,7	310
132000 Series Single Cyl. "L" Head	BR2LM	5798	0,7	310
131000 Series Single Cyl. "L" Head	BR2LM	5798	0,7	310
130000 Series Single Cyl. "L" Head	BR2LM	5798	0,7	310
12G800 Series Single Cyl. "L" Head	BR2LM	5798	0,7	310
12G700 Series Single Cyl. "L" Head	BR2LM	5798	0,7	310
135200 Series Single Cyl. "L" Head	BR2LM	5798	0,7	310

# Diverse Arbeitsgeräte / Various Tools



Order  
No.



Quick  
No.

## B & S MOTOREN

120H00 Series Single Cyl. "L" Head	BR2LM	5798	0,7	310
91200 Series Single Cyl. "L" Head	BR2LM	5798	0,7	310
9K900 Series Single Cyl. "L" Head	BR2LM	5798	0,7	310
10L900 Series Single Cyl. "L" Head	BR2LM	5798	0,7	310
90700 Series Single Cyl. "L" Head	BR2LM	5798	0,7	310
123H00 Series Single Cyl. "L" Head	BR2LM	5798	0,7	310
12E800 Series Single Cyl. "L" Head	BR2LM	5798	0,7	310
12F700 Series Single Cyl. "L" Head	BR2LM	5798	0,7	310
126000 Series Single Cyl. "L" Head	BR2LM	5798	0,7	310
12D800 Series Single Cyl. "L" Head	BR2LM	5798	0,7	310
12B000 Series Single Cyl. "L" Head	BR2LM	5798	0,7	310
12B700 Series Single Cyl. "L" Head	BR2LM	5798	0,7	310
12B800 Series Single Cyl. "L" Head	BR2LM	5798	0,7	310
12C000 Series Single Cyl. "L" Head	BR2LM	5798	0,7	310
12F800 Series Single Cyl. "L" Head	BR2LM	5798	0,7	310
95500 Series Single Cyl. "L" Head	BR2LM	5798	0,7	310
95900 Series Single Cyl. "L" Head	BR2LM	5798	0,7	310
9B900 Series Single Cyl. "L" Head	BR2LM	5798	0,7	310
96500 Series Single Cyl. "L" Head	BR2LM	5798	0,7	310
96700 Series Single Cyl. "L" Head	BR2LM	5798	0,7	310
96900 Series Single Cyl. "L" Head	BR2LM	5798	0,7	310
98900 Series Single Cyl. "L" Head	BR2LM	5798	0,7	310
9C900 Series Single Cyl. "L" Head	BR2LM	5798	0,7	310
9D900 Series Single Cyl. "L" Head	BR2LM	5798	0,7	310
9E900 Series Single Cyl. "L" Head	BR2LM	5798	0,7	310
95700 Series Single Cyl. "L" Head	BR2LM	5798	0,7	310
9G900 Series Single Cyl. "L" Head	BR2LM	5798	0,7	310
93400 w/Top Tank Single Cyl. "L" Head	BKR5E	7938	0,7	
12C800 Series Single Cyl. "L" Head	BR2LM	5798	0,7	310
9F900 Series Single Cyl. "L" Head	BR2LM	5798	0,7	310
93500 Series Single Cyl. "L" Head	BR2LM	5798	0,7	310
95200 Series Single Cyl. "L" Head	BR2LM	5798	0,7	310
94900 Series Single Cyl. "L" Head	BR2LM	5798	0,7	310
94200 Series Single Cyl. "L" Head	BKR5E	7938	0,7	
93900 Series Single Cyl. "L" Head	BR2LM	5798	0,7	310
9J900 Series Single Cyl. "L" Head	BR2LM	5798	0,7	310
93440 w/No Tank Single Cyl. "L" Head	BR2LM	5798	0,7	310
124000 Series Single Cyl. "L" Head	BR2LM	5798	0,7	310
93200 Series Single Cyl. "L" Head	BR2LM	5798	0,7	310
92900 Series Single Cyl. "L" Head	BR2LM	5798	0,7	310
92200 Series Single Cyl. "L" Head	BR2LM	5798	0,7	310
91700 Series Single Cyl. "L" Head	BR2LM	5798	0,7	310
91400 series Single Cyl. "L" Head	BR2LM	5798	0,7	310
125000 Series Single Cyl. "L" Head	BR2LM	5798	0,7	310
9H900 Series Single Cyl. "L" Head	BR2LM	5798	0,7	310
12U800 Series Single Cyl. "L" Head	BR2LM	5798	0,7	310
12C700 Series Single Cyl. "L" Head	BR2LM	5798	0,7	310
12T700 Series Single Cyl. "L" Head	BR2LM	5798	0,7	310
12S800 Series Single Cyl. "L" Head	BR2LM	5798	0,7	310
12L700 Series Single Cyl. "L" Head	BR2LM	5798	0,7	310
12E700 Series Single Cyl. "L" Head	BR2LM	5798	0,7	310
127800 Series Single Cyl. "L" Head	BR2LM	5798	0,7	310

# Diverse Arbeitsgeräte / Various Tools



Order  
No.



Quick  
No.

## B & S MOTOREN

127700 Series Single Cyl. "L" Head	BR2LM	5798	0,7	310
123000 Series Single Cyl. "L" Head	BR2LM	5798	0,7	310
122800 Series Single Cyl. "L" Head	BR2LM	5798	0,7	310
122700 Series Single Cyl. "L" Head	BR2LM	5798	0,7	310
121800 Series Single Cyl. "L" Head	BR2LM	5798	0,7	310
121000 Series Single Cyl. "L" Head	BR2LM	5798	0,7	310
112000 Series Single Cyl. "L" Head	BR2LM	5798	0,7	310
113000 Series Single Cyl. "L" Head	BR2LM	5798	0,7	310
84700 Series Single Cyl. "L" Head	BR2LM	5798	0,7	310
111900 Series Single Cyl. "L" Head	BR2LM	5798	0,7	310
111700 Series Single Cyl. "L" Head	BR2LM	5798	0,7	310
111000 Series Single Cyl. "L" Head	BR2LM	5798	0,7	310
110700 Series Single Cyl. "L" Head	BR2LM	5798	0,7	310
110000 Series Single Cyl. "L" Head	BR2LM	5798	0,7	310
10M900 Series Single Cyl. "L" Head	BR2LM	5798	0,7	310
10G900 Series Single Cyl. "L" Head	BR2LM	5798	0,7	310
10F900 Series Single Cyl. "L" Head	BR2LM	5798	0,7	310
10E900 series Single Cyl. "L" Head	BR2LM	5798	0,7	310
10D900 Series Single Cyl. "L" Head	BR2LM	5798	0,7	310
10C900 Series Single Cyl. "L" Head	BR2LM	5798	0,7	310
10B900 Series Single Cyl. "L" Head	BR2LM	5798	0,7	310
10A900 Series Single Cyl. "L" Head	BR2LM	5798	0,7	310
100700 Series Single Cyl. "L" Head	BR2LM	5798	0,7	310
104700 Series Single Cyl. "L" Head	BR2LM	5798	0,7	310
114000 Series Single Cyl. "L" Head	BR2LM	5798	0,7	310
83400 Series Single Cyl. "L" Head	BR2LM	5798	0,7	310
12S700 Series Single Cyl. "L" Head	BR2LM	5798	0,7	310
100600 Series Single Cyl. "L" Head	BR2LM	5798	0,7	310
100200 Series Single Cyl. "L" Head	BR2LM	5798	0,7	310
92500 Series Single Cyl. "L" Head	BR2LM	5798	0,7	310
90400 Series Single Cyl. "L" Head	BR2LM	5798	0,7	310
90200 Series Single Cyl. "L" Head	BR2LM	5798	0,7	310
90100 Series Single Cyl. "L" Head	BR2LM	5798	0,7	310
85900 Series Single Cyl. "L" Head	BR2LM	5798	0,7	310
85500 Series Single Cyl. "L" Head	BR2LM	5798	0,7	310
84900 Series Single Cyl. "L" Head	BR2LM	5798	0,7	310
12T800 Series Single Cyl. "L" Head	BR2LM	5798	0,7	310
84500 Series Single Cyl. "L" Head	BR2LM	5798	0,7	310
9K400 Series Single Cyl. "L" Head	BKR5E	7938	0,7	310
82900 Series Single Cyl. "L" Head	BR2LM	5798	0,7	310
82500 Series Single Cyl. "L" Head	BR2LM	5798	0,7	310
82400 Series Single Cyl. "L" Head	BR2LM	5798	0,7	310
82300 Series Single Cyl. "L" Head	BR2LM	5798	0,7	310
82200 Series Single Cyl. "L" Head	BR2LM	5798	0,7	310
80400 Series Single Cyl. "L" Head	BR2LM	5798	0,7	310
80300 Series Single Cyl. "L" Head	BR2LM	5798	0,7	310
80200 Series Single Cyl. "L" Head	BR2LM	5798	0,7	310
80100 Series Single Cyl. "L" Head	BR2LM	5798	0,7	310
60100 Series Single Cyl. "L" Head	BR2LM	5798	0,7	310
21100 Series Single Cyl. "L" Head	BPMR6F	1270	0,6	
21000 Series Single Cyl. "L" Head	BPMR6F	1270	0,6	
122H00 Series Single Cyl. "L" Head	BR2LM	5798	0,7	310

# Diverse Arbeitsgeräte / Various Tools



Order  
No.



Quick  
No.

## B & S MOTOREN

100900 Series Single Cyl. "L" Head	BR2LM	5798	0,7	310
94500 Series Single Cyl. "L" Head	BR2LM	5798	0,7	310
31C700 Series Single OHV	BKR5E	7938	0,7	
28N700 Series Single OHV	BKR5E	7938	0,7	
28U700 Series Single OHV	BKR5E	7938	0,7	
31D700 Series Single OHV	BKR5E	7938	0,7	
216700 Series Single OHV	BKR5E	7938	0,7	
31B700 Series Single OHV	BKR5E	7938	0,7	
50000 Series Single OHV	BKR5E	7938	0,7	
319700 Series Single OHV	BKR5E	7938	0,7	
28E700 Series Single OHV	BKR5E	7938	0,7	
12Y600 Series Marine Single OHV	BKR5E	7938	0,7	
31G700 Series Single OHV	BKR5E	7938	0,7	
97700 Series Single OHV	BKR5E	7938	0,7	
212400 Series Single OHV	BKR5E	7938	0,7	
12Z800 Series Single OHV	BKR5E	7938	0,7	
313700 Series Single OHV	BKR5E	7938	0,7	
219700 Series Single OHV	BKR5E	7938	0,7	
217800 Series Single OHV	BKR5E	7938	0,7	
280H00 Series Single OHV	BKR5E	7938	0,7	
21B800 Series Single OHV	BKR5E	7938	0,7	
21B700 Series Single OHV	BKR5E	7938	0,7	
21A900 Series Single OHV	BKR5E	7938	0,7	
282H00 Series Single OHV	BKR5E	7938	0,7	
219800 Series Single OHV	BKR5E	7938	0,7	
281H00 Series Single OHV	BKR5E	7938	0,7	
218700 Series Single OHV	BKR5E	7938	0,7	
217700 Series Single OHV	BKR5E	7938	0,7	
287700 Series Single OHV	BKR5E	7938	0,7	
216800 Series Single OHV	BKR5E	7938	0,7	
218800 Series Single OHV	BKR5E	7938	0,7	
31A700 Series Single OHV	BKR5E	7938	0,7	
21A800 Series Single OHV	BKR5E	7938	0,7	
214800 Series Single OHV	BKR5E	7938	0,7	
28W700 Series Single OHV	BKR5E	7938	0,7	
11A600 Series Single OHV	BKR5E	7938	0,5	
21C200 Series Single OHV	BKR5E	7938	0,7	
212700 Series Single OHV	BKR5E	7938	0,7	
212800 Series Single OHV	BKR5E	7938	0,7	
207400 Series Single OHV	BKR5E	7938	0,7	
213700 Series Single OHV	BKR5E	7938	0,7	
214700 Series Single OHV	BKR5E	7938	0,7	
215700 Series Single OHV	BKR5E	7938	0,7	
211800 Series Single OHV	BKR5E	7938	0,7	
21C100 Series Single OHV	BKR5E	7938	0,7	
126400 Series Single OHV	BKR5E	7938	0,7	
12Y800 Series Single OHV	BKR5E	7938	0,7	
11B600 Series Single OHV	BKR5E	7938	0,5	
120300 Series Single OHV	BKR5E	7938	0,7	
213800 Series Single OHV	BKR5E	7938	0,7	
126300 Series Single OHV	BKR5E	7938	0,7	
99700 Series Single OHV	BKR5E	7938	0,7	

# Diverse Arbeitsgeräte / Various Tools



Order  
No.



Quick  
No.

## B & S MOTOREN

210700 Series Single OHV	BKR5E	7938	0,7
210400 Series Single OHV	BKR5E	7938	0,7
211700 Series Single OHV	BKR5E	7938	0,7
215800 Series Single OHV	BKR5E	7938	0,7
210800 Series Single OHV	BKR5E	7938	0,7
522400 Series Vanguard Liquid Cooled Three Cyl	BKR5E	7938	0,7
437400 Series Vanguard Liquid Cooled Three Cyl	BKR5E	7938	0,7
436400 Series Vanguard Liquid Cooled Three Cyl	BKR5E	7938	0,7
433400 Series Vanguard Liquid Cooled Three Cyl	BKR5E	7938	0,7
430400 Series DM700G Vanguard Liquid Cooled Three Cyl	BKR5E	7938	0,7
432400 Series Vanguard Liquid Cooled Three Cyl	BKR5E	7938	0,7
434400 Series Vanguard Liquid Cooled Three Cyl	BKR5E	7938	0,7
582400 Series Vanguard Liquid Cooled Three Cyl	BKR5E	7938	0,7
584400 Series Vanguard Liquid Cooled Three Cyl	BKR5E	7938	0,7
58A400 Series Vanguard Liquid Cooled Three Cyl	BKR5E	7938	0,7
585400 Series Vanguard Liquid Cooled Three Cyl	BKR5E	7938	0,7
581400 Series Vanguard Liquid Cooled Three Cyl	BKR5E	7938	0,7
613400 Series Vanguard Liquid Cooled Three Cyl	BKR5E	7938	0,7
431400 Series Vanguard Liquid Cooled Three Cyl	BKR5E	7938	0,7
589400 Series Vanguard Liquid Cooled Three Cyl	BKR5E	7938	0,7
435400 Series Vanguard Liquid Cooled Three Cyl	BKR5E	7938	0,7
588400 Series Vanguard Liquid Cooled Three Cyl	BKR5E	7938	0,7
587400 Series Vanguard Liquid Cooled Three Cyl	BKR5E	7938	0,7
586400 Series Vanguard Liquid Cooled Three Cyl	BKR5E	7938	0,7
580400 Series DM950G Vanguard Liquid Cooled Three Cyl	BKR5E	7938	0,7
473100 Series Vanguard Liquid Cooled Three Cyl	BKR5E	7938	0,7
583400 Series Vanguard Liquid Cooled Three Cyl	BKR5E	7938	0,7
28S700 Series Vanguard Single Cyl. OHV	BKR5E	7938	0,7
138400 Series Vanguard Single Cyl. OHV	BKR5E	7938	0,7
118400 Series Vanguard Single Cyl. OHV	BPR6HS	7022	0,7
117400 Series Vanguard Single Cyl. OHV	BKR5E	7938	0,7
104700 Series Vanguard Single Cyl. OHV	BKR5E	7938	0,7
85400 Series Vanguard Single Cyl. OHV	BKR5E	7938	0,7
115400 Series Vanguard Single Cyl. OHV	BKR5E	7938	0,7
5000 Series Vanguard Single Cyl. OHV	BPR6HS	7022	0,7
185400 Series Vanguard Single Cyl. OHV	BKR5E	7938	0,7
260700 Series Vanguard Single Cyl. OHV	BKR5E	7938	0,7
235400 Series Vanguard Single Cyl. OHV	BKR5E	7938	0,7
245400 Series Vanguard Single Cyl. OHV	BKR5E	7938	0,7
261700 Series Vanguard Single Cyl. OHV	BKR5E	7938	0,7
312700 Series Vanguard Single Cyl. OHV	BKR5E	7938	0,7
28P700 Series Vanguard Single Cyl. OHV	BKR5E	7938	0,7
28Q700 Series Vanguard Single Cyl. OHV	BKR5E	7938	0,7
86400 Series Vanguard Single Cyl. OHV	BKR5E	7938	0,7
186400 Series Vanguard Single Cyl. OHV	BKR5E	7938	0,7
161400 Series Vanguard Single Cyl. OHV	BKR5E	7938	0,7
356400 Series Vanguard V-Twin OHC	BKR5E	7938	0,7
356700 Series Vanguard V-Twin OHC	BKR5E	7938	0,7
613400 Series Vanguard V-Twin OHC	BKR5E	7938	0,5
304400 Series Vanguard V-Twin OHC	BKR5E	7938	0,7
30A400 Series Vanguard V-Twin OHC	BKR5E	7938	0,7
354400 Series Vanguard V-Twin OHC	BKR5E	7938	0,7

# Diverse Arbeitsgeräte / Various Tools



Order  
No.



Quick  
No.

## B & S MOTOREN

290400 Series Vanguard V-Twin OHC	BKR5E	7938	0,7	
290700 Series Vanguard V-Twin OHC	BKR5E	7938	0,7	
294700 Series Vanguard V-Twin OHC	BKR5E	7938	0,7	
351700 Series Vanguard V-Twin OHC	BKR5E	7938	0,7	
303700 Series Vanguard V-Twin OHC	BKR5E	7938	0,7	
305700 Series Vanguard V-Twin OHC	BKR5E	7938	0,7	
303400 Series Vanguard V-Twin OHC	BKR5E	7938	0,7	
350400 Series Vanguard V-Twin OHC	BKR5E	7938	0,7	
357700 Series Vanguard V-Twin OHC	BKR5E	7938	0,7	
351400 Series Vanguard V-Twin OHC	BKR5E	7938	0,7	
355700 Series Vanguard V-Twin OHC	BKR5E	7938	0,7	
385400 Series Vanguard V-Twin OHC	BKR5E	7938	0,7	
541400 Series Vanguard V-Twin OHC	BKR5E	7938	0,7	
380400 Series Vanguard V-Twin OHC	BKR5E	7938	0,7	
294400 Series Vanguard V-Twin OHC	BKR5E	7938	0,7	
380700 Series Vanguard V-Twin OHC	BKR5E	7938	0,7	
386400 Series Vanguard V-Twin OHC	BKR5E	7938	0,7	
381400 Series Vanguard V-Twin OHC	BKR5E	7938	0,7	
543200 Series Vanguard V-Twin OHC	BKR5E	7938	0,5	
381700 Series Vanguard V-Twin OHC	BKR5E	7938	0,7	
474100 Series Vanguard V-Twin OHC	BKR5E	7938	0,7	
358700 Series Vanguard V-Twin OHC	BKR5E	7938	0,7	
542400 Series Vanguard V-Twin OHC	BKR5E	7938	0,5	
350700 Series Vanguard V-Twin OHC	BKR5E	7938	0,7	
613100 Series Vanguard V-Twin OHC	BKR5E	7938	0,5	
543400 Series Vanguard V-Twin OHC	BKR5E	7938	0,7	
543400 Series Vanguard V-Twin OHC	BKR5E	7938	0,5	
613100 Series Vanguard V-Twin OHC	BKR5E	7938	0,7	
386700 Series Vanguard V-Twin OHC	BKR5E	7938	0,7	
385700 Series Vanguard V-Twin OHC	BKR5E	7938	0,7	

## BOMBARDIER-ROTAX

95	Mehrzweckmotor	B6HS	4510	0,6	203
150	Mehrzweckmotor	A6	1010	0,6	
182	Mehrzweckmotor	B6HS	4510	0,6	203
232	Mehrzweckmotor	B6HS	4510	0,6	203
299	Mehrzweckmotor	A6	1010	0,6	
500	Mehrzweckmotor	A6	1010	0,6	
635	Mehrzweckmotor	A7	1110	0,6	

## CASE

Tractor-430	Gas	AB-6	2910	0,6	
Tractor-430	LPG	AB-6	2910	0,5	
Tractor-431	Gas	AB-6	2910	0,6	
Tractor-435	Gas	AB-6	2910	0,6	
Tractor-440	Gas	AB-6	2910	0,6	
Tractor-441	Gas	AB-6	2910	0,6	
Tractor-445	Gas	AB-6	2910	0,6	
Tractor-470	Gas	AB-6	2910	0,6	
Tractor-530	Gas	AB-6	2910	0,6	
Tractor-530	LPG	AB-6	2910	0,5	
Tractor-531	Gas	AB-6	2910	0,6	



# Diverse Arbeitsgeräte / Various Tools



Order  
No.



Quick  
No.

## CASE

Tractor-535	Gas	AB-6	2910	0,6	
Tractor-540	Gas	AB-6	2910	0,6	
Tractor-541	Gas	AB-6	2910	0,6	
Tractor-545	Gas	AB-6	2910	0,6	
Tractor-570	Gas	AB-6	2910	0,6	
Tractor-610	Gas	AB-6	2910	0,6	
Tractor-630	LPG	AB-6	2910	0,5	
Tractor-730	LPG	AB-6	2910	0,5	
Tractor-730	Gas	AB-6	2910	0,6	
Tractor-731	Gas	AB-6	2910	0,6	
Tractor-731	LPG	AB-6	2910	0,5	
Tractor-732	Gas	AB-6	2910	0,6	
Tractor-732	LPG	AB-6	2910	0,5	
Tractor-733	Gas	AB-6	2910	0,6	
Tractor-733	LPG	AB-6	2910	0,5	
Tractor-734	Gas	AB-6	2910	0,6	
Tractor-734	LPG	AB-6	2910	0,5	
Tractor-740	Gas	AB-6	2910	0,6	
Tractor-740	LPG	AB-6	2910	0,5	
Tractor-741	Gas	AB-6	2910	0,6	
Tractor-741	LPG	AB-6	2910	0,5	
Tractor-742	LPG	AB-6	2910	0,5	
Tractor-742	Gas	AB-6	2910	0,6	
Tractor-743	Gas	AB-6	2910	0,6	
Tractor-743	LPG	AB-6	2910	0,5	
Tractor-744	Gas	AB-6	2910	0,6	
Tractor-744	LPG	AB-6	2910	0,5	
Tractor-770	Gas	AB-6	2910	0,6	
Tractor-830	Gas	AB-6	2910	0,6	
Tractor-830	LPG	AB-6	2910	0,5	
Tractor-831	Gas	AB-6	2910	0,6	
Tractor-831	LPG	AB-6	2910	0,5	
Tractor-832	Gas	AB-6	2910	0,6	
Tractor-832	LPG	AB-6	2910	0,5	
Tractor-833	Gas	AB-6	2910	0,6	
Tractor-833	LPG	AB-6	2910	0,5	
Tractor-840	LPG	AB-6	2910	0,5	
Tractor-840	Gas	AB-6	2910	0,6	
Tractor-841	LPG	AB-6	2910	0,5	
Tractor-841	Gas	AB-6	2910	0,6	
Tractor-842	LPG	AB-6	2910	0,5	
Tractor-843	LPG	AB-6	2910	0,5	
Tractor-843	Gas	AB-6	2910	0,6	
Tractor-870	Gas	AB-6	2910	0,6	
Tractor-901	Gas	AB-6	2910	0,6	
Tractor-930	Gas	AB-6	2910	0,6	
Tractor-930	LPG	AB-6	2910	0,5	
Tractor-970	Gas	AB-6	2910	0,6	
Baler - 130		AB-6	2910	0,6	
Baler - 133		AB-6	2910	0,6	
Baler - 135		AB-6	2910	0,6	
Baler - 140		AB-6	2910	0,6	

# Diverse Arbeitsgeräte / Various Tools



Order  
No.



Quick  
No.

## CASE

Baler - 160		AB-6	2910	0,6	
Baler - 177		AB-6	2910	0,6	
Baler - 200		AB-6	2910	0,6	
Baler - 220		AB-6	2910	0,6	
Baler - 230		AB-6	2910	0,6	
Baler - 330T		AB-6	2910	0,6	
Baler - 330W		AB-6	2910	0,6	
Baler - MT		AB-6	2910	0,6	
Baler - NAP-2		B6S	3510	0,6	
Baler - NAP-3		B6S	3510	0,6	
Baler - NC		AB-6	2910	0,6	
Baler - NCM		AB-6	2910	0,6	
Baler - NL		AB-6	2910	0,6	
Baler - NT		AB-6	2910	0,6	
Combine-1000 LPG Case		AB-6	2910	0,5	
Combine-1000 Gas Case		AB-6	2910	0,6	
Combine-1000 Gas Hercules		B6S	3510	0,6	
Combine-1010 Gas Chrysler HB308 3/4" Rch.		BP5ES	6511	0,6	
Combine-1010 Gas Case		AB-6	2910	0,6	
Combine-1010 Gas Chrysler HB308 3/4" Rch.		XR5	5953	0,6	
Combine-1010 LPG Case		AB-6	2910	0,5	
Combine-1060 LPG Case		AB-6	2910	0,5	
Combine-1060 LPG Case 284 cu in.		AB-6	2910	0,5	
Combine-1060 Gas Chrysler HB308 3/4" Rch		BP5ES	6511	0,6	
Combine-1060 Gas Chrysler HB308 3/4" Rch		XR5	5953	0,6	
Combine-1060 LPG Case 284 cu in		AB-6	2910	0,5	
Combine-1665 Gas Chrysler HB308 3/4" Rch		XR5	5953	0,6	
Combine-600 Gas Case		AB-6	2910	0,6	
Combine-660 Gas Case		AB-6	2910	0,6	
Combine-700 Gas Chrysler H225		B6ES	7310	0,5	
Combine-700 Gas Chrysler H225		B6ES	7310	0,6	
Combine-77 Gas		AB-6	2910	0,6	
Combine-80 Gas		AB-6	2910	0,6	
Combine-800 LPG Case		AB-6	2910	0,5	
Combine-88 Gas		AB-6	2910	0,6	
Combine-900 Gas Chrysler H225		B6ES	7310	0,6	
Combine-960 Gas Chrysler H225		B6ES	7310	0,6	
Forage Harvester-200		AB-6	2910	0,6	
Forage Harvester-C2		AB-6	2910	0,6	
Windrower - 1050		AB-6	2910	0,6	
Windrower - 1140		AB-6	2910	0,6	
Windrower - 1150		AB-6	2910	0,6	
Windrower - 1155		AB-6	2910	0,6	
Windrower - 650		AB-6	2910	0,6	
Windrower - 655		AB-6	2910	0,6	
Windrower - 820		AB-6	2910	0,6	
Windrower - 855		AB-6	2910	0,6	
Windrower - 950		AB-6	2910	0,6	

## CRAMER

Tera Cut 3000	Häckseler	BPR6ES	7822	0,7	
Garden Cut 4000	Häckseler	BPR6ES	7822	0,7	

# Diverse Arbeitsgeräte / Various Tools



Order  
No.



Quick  
No.

## CRAMER

Combi Cut B	Häckseler	BPR6ES	7822	0,7	
CM60	Hacke	BR4HS	3322	0,6	
CM60	Hacke	BR4HS	3322	0,6	
HS 450 BE	Schredder	BPR6ES	7822	0,7	
LS3500	Laubsauger	BR4HS	3322	0,6	
LS5000	Laubsauger	BR4HS	3322	0,6	
LS5000 H	Laubsauger	BR4HS	3322	0,6	

## DOLMAR

309 Happy Start	Trennschleifer	BPMR7A	4626	0,5	309
309	Trennschleifer	BPMR7A	4626	0,5	309
343 Happy Start	Trennschleifer	BPMR7A	4626	0,5	309
HT-2256 D	Heckenschere	BMR7A	4226	0,6	
HT-2276 E	Heckenschere	BMR7A	4226	0,6	
PB-250	Gebälse	BMR7A	4226	0,7	
PC-6412	Trennschleifer	BPMR7A	4626	0,5	309
PC-7314	Trennschleifer	BPMR7A	4626	0,5	309
PD-491	Erdbohrer	BPMR7A	4626	0,6	309

## ECHO

CLS 4600	Mehrzweckmotor	BPM7A	7321	0,6	305
CLS 4610	Mehrzweckmotor	BPM7A	7321	0,6	305
CS 280 EG	Mehrzweckmotor	BMR6A	7421	0,6	307
CS 3000	Mehrzweckmotor	BPM7A	7321	0,6	305
CS 330 EVL	Mehrzweckmotor	BM6A	5921	0,6	303
CS 3400	Mehrzweckmotor	BPMR7A	4626	0,6	309
CS 3600	Mehrzweckmotor	BPM7A	7321	0,6	305
CS 3900	Mehrzweckmotor	BPM6A	7021	0,6	304
CS 400 EVL	Mehrzweckmotor	BPM6A	7021	0,6	304
CS 4000	Mehrzweckmotor	BPM7A	7321	0,6	305
CS 4200	Mehrzweckmotor	BPM6Y	4562	0,6	
CS 4400	Mehrzweckmotor	BPM7A	7321	0,6	305
CS 4500	Mehrzweckmotor	BPM7A	7321	0,6	305
CS 4601	Mehrzweckmotor	BPM7A	7321	0,6	305
CS 5100	Mehrzweckmotor	BPM8Y	2057	0,6	
CS 5501	Mehrzweckmotor	BPM7A	7321	0,6	305
CS 6701-40	Mehrzweckmotor	BPM7A	7321	0,6	305
CSG 6700	Mehrzweckmotor	BPM6A	7021	0,6	304
ES 1000	Mehrzweckmotor	BPM7A	7321	0,6	305
ES 2000	Mehrzweckmotor	BPM7Y	4921	0,6	
ES 2100	Mehrzweckmotor	BPM7Y	4921	0,6	
ES 2400	Mehrzweckmotor	BPM7Y	4921	0,6	
GT 160	Mehrzweckmotor	BM6A	5921	0,6	303
GT 2010	Mehrzweckmotor	BPM7A	7321	0,6	305
HC 140	Mehrzweckmotor	BM6A	5921	0,6	303
HC 1500	Mehrzweckmotor	BPM6A	7021	0,6	304
HC 160	Mehrzweckmotor	BM6A	5921	0,6	303
HC 1600	Mehrzweckmotor	BPM7A	7321	0,6	305
HC 210 E	Mehrzweckmotor	BM6A	5921	0,6	303
HC 2100	Mehrzweckmotor	BPM7A	7321	0,6	305
HC 2300	Mehrzweckmotor	BPM7A	7321	0,6	305
HC 2410	Mehrzweckmotor	BPM7Y	4921	0,6	

# Diverse Arbeitsgeräte / Various Tools



Order  
No.



Quick  
No.

## ECHO

HC-1500	Heckenschere	BPM6A	7021	0,6	304
HC-1600	Heckenschere	BPM7A	7321	0,6	305
HC-2300	Heckenschere	BPM7A	7321	0,6	305
HCA 2410	Mehrzweckmotor	BPM7Y	4921	0,6	
HCR 1500	Mehrzweckmotor	BPMR6A	6726	0,6	308
PB 210 E	Mehrzweckmotor	BPM7A	7321	0,6	305
PB 2405	Mehrzweckmotor	BPM7Y	4921	0,6	
PB 24LN	Mehrzweckmotor	BPM7Y	4921	0,6	
PB 4500	Mehrzweckmotor	BPM7A	7321	0,6	305
PB 46LN	Mehrzweckmotor	BPM7Y	4921	0,6	
PB 6000	Mehrzweckmotor	BPM7Y	4921	0,6	
PB-2455	Luftbesen	BPM7Y	4921	0,6	
PB-6000	Kraftgebläse	BPM7Y	4921	0,6	
REC 600	Mehrzweckmotor	BPM7A	7321	0,6	305
RM 310	Mehrzweckmotor	BPM7A	7321	0,6	305
RM 380	Mehrzweckmotor	BPM7A	7321	0,6	305
RM 385	Mehrzweckmotor	BPMR7A	4626	0,6	309
RMA 2530	Mehrzweckmotor	BPM7A	7321	0,6	305
SRA 2190	Mehrzweckmotor	BPM7A	7321	0,6	305
SRM 200BE	Mehrzweckmotor	BM6A	5921	0,6	303
SRM 2010	Mehrzweckmotor	BM6A	5921	0,6	303
SRM 2015	Mehrzweckmotor	BM6A	5921	0,6	303
SRM 2100	Mehrzweckmotor	BPM7A	7321	0,6	305
SRM 2450	Mehrzweckmotor	BPM7Y	4921	0,6	
SRM 2455	Mehrzweckmotor	BPM7Y	4921	0,6	
SRM 250 E	Mehrzweckmotor	BPM7A	7321	0,6	305
SRM 2605	Mehrzweckmotor	BPMR7A	4626	0,6	309
SRM 310 E	Mehrzweckmotor	BPM7A	7321	0,6	305
SRM 3150	Mehrzweckmotor	BPMR7A	4626	0,6	309
SRM 3155	Mehrzweckmotor	BPMR7A	4626	0,6	309
SRM 3800	Mehrzweckmotor	BPM7A	7321	0,6	305
SRM 3805	Mehrzweckmotor	BPM7A	7321	0,6	305
SRM 4600	Mehrzweckmotor	BPM7A	7321	0,6	305
SRM 4605	Mehrzweckmotor	BPM7A	7321	0,6	305
WP 1000	Mehrzweckmotor	BPM7A	7321	0,6	305
WP-1000	Wasserpumpe	BPM7A	7321	0,6	305

## EFCO

131	Mehrzweckmotor	BPMR6A	6726	0,6	308
134	Mehrzweckmotor	BPM7A	7321	0,6	305
135	Mehrzweckmotor	BPM7A	7321	0,6	305
136	Mehrzweckmotor	BPM7A	7321	0,6	305
138	Mehrzweckmotor	BPM7A	7321	0,6	305
140	Mehrzweckmotor	BPM7A	7321	0,6	305
140 S	Mehrzweckmotor	BPM7A	7321	0,6	305
142	Mehrzweckmotor	BPM7A	7321	0,6	305
146	Mehrzweckmotor	BPM7A	7321	0,6	305
151	Mehrzweckmotor	BPM7A	7321	0,6	305
156	Mehrzweckmotor	BPM7A	7321	0,6	305
162	Mehrzweckmotor	BPM7A	7321	0,6	305
170	Mehrzweckmotor	BPM7A	7321	0,6	305
171	Mehrzweckmotor	BPM7A	7321	0,6	305

# Diverse Arbeitsgeräte / Various Tools



Order  
No.



Quick  
No.

## EFCO

180	Mehrzweckmotor	BPM7A	7321	0,6	305
181	Mehrzweckmotor	BPM7A	7321	0,6	305
8200	Mehrzweckmotor	BPM7A	7321	0,6	305
8220	Mehrzweckmotor	BPM7A	7321	0,6	305
8250 / 8250 IC / D	Mehrzweckmotor	BPM7A	7321	0,6	305
8260 / 8260 D	Mehrzweckmotor	BPM7A	7321	0,6	305
8300	Mehrzweckmotor	BPM7A	7321	0,6	305
8350	Mehrzweckmotor	BPM7A	7321	0,6	305
8400 / 8400 IC	Mehrzweckmotor	BPM7A	7321	0,6	305
8405	Mehrzweckmotor	BPM7A	7321	0,6	305
8420	Mehrzweckmotor	BPM7A	7321	0,6	305
8425	Mehrzweckmotor	BPM7A	7321	0,6	305
8460	Mehrzweckmotor	BPM7A	7321	0,6	305
8465	Mehrzweckmotor	BPM7A	7321	0,6	305
8510	Mehrzweckmotor	BPM7A	7321	0,6	305
8530	Mehrzweckmotor	BPM7A	7321	0,6	305
8550 BOSS	Mehrzweckmotor	BPM7A	7321	0,6	305
AT 2050	Mehrzweckmotor	BPM7A	7321	0,6	305
AT 2080	Mehrzweckmotor	BPM7A	7321	0,6	305
PA 1030	Mehrzweckmotor	BPM7A	7321	0,6	305
PA 1040	Mehrzweckmotor	BPM7A	7321	0,6	305
STARK 26 TR	Mehrzweckmotor	BPM7A	7321	0,6	305
STARK 26/26 IC	Mehrzweckmotor	BPM7A	7321	0,6	305
TR 1540	Mehrzweckmotor	BPM7A	7321	0,6	305
TR 1581 R	Mehrzweckmotor	BPM7A	7321	0,6	305
TS 326	Mehrzweckmotor	BPM7A	7321	0,6	305
TS 326 S	Mehrzweckmotor	BPM7A	7321	0,6	305
TS 330	Mehrzweckmotor	BPM7A	7321	0,6	305
TS 355	Mehrzweckmotor	BPM7A	7321	0,6	305

## ERING

5PS RX	Motorhacke	BR2LM	5798	0,5	310
MH-H 15	Motorhacke	BR2LM	5798	0,5	310
T 102155H	Traktor	BKR5ES	2460	0,7	
T 10217 H	Traktor	BKR5ES	2460	0,7	
T 106155 S	Traktor	BKR5ES	2460	0,7	
T 7613 H	Traktor	BR2LM	5798	0,5	310
T 9612 S	Traktor	BR2LM	5798	0,5	310

## FLYMO

BVL 320	Luftbesen	BPMR7A	4626	0,5	309
HTL 170	Heckenschere	BPM6A	7021	0,6	304
HTL 480	Heckenschere	BPMR6A	6726	0,5	308

## FUJI

DW 67		Y-112T	6327		
DW 100		Y-112T	6327		
DY 40		Y-401-3	only OE		
DY 8		Y-401-3	only OE		

## GUTBROD

1100 H	B&S	Traktor	BCPR5ES	6130	0,6
--------	-----	---------	---------	------	-----

# Diverse Arbeitsgeräte / Various Tools



Order  
No.



Quick  
No.

## GUTBROD

1200 H	B&S	Traktor	BCPR5ES	6130	0,6	
250 MS 4	Vantage 35T	Motorhacke	BR2LM	5798	0,5	310
G 550	Kawasaki	Motorhacke	B4H	4110	0,6	
G 650	Kawasaki	Motorhacke	B4H	4110	0,6	
G 750	Kawasaki	Motorhacke	BPR5ES	7422	0,6	
GAB 35	B&S	Häcksler	BR2LM	5798	0,5	310
GAB 35	B&S	Häcksler	BR4LM	4133	0,5	
HAE B	B&S	Häcksler	BR2LM	5798	0,5	310
MB 50-35	B&S	Motorhacke	BR4LM	4133	0,5	
MB 62	B&S	Motorhacke	BR2LM	5798	0,5	310
MB 62-35	B&S	Motorhacke	BR4LM	4133	0,5	
MB 62-52	B&S	Motorhacke	BR4LM	4133	0,5	
MB 65-30	Kawasaki	Motorhacke	BM6A	5921	0,6	303
MK 65-30	Kawasaki	Motorhacke	BPR6ES	7822	0,6	
MK 90-50	Kawasaki	Motorhacke	BM6A	5921	0,6	303

## HERKULES

3500 Kompakt		Schredder	BPR6ES	7822	0,7	
4000 Profi		Schredder	BPR6ES	7822	0,7	
B400		Vertikutierer	BR2LM	5798	0,7	310
FM 300 H		Multitec / Einachser	BPR6ES	7822	0,7	
FM 300 T		Multitec / Einachser	BR4LM	4133	0,5	
KM 450 T		Kehrmaschine	BPMR6A	6726	0,6	307
KM 600 H		Kehrmaschine	BPR6ES	7822	0,7	
KM 600 T		Kehrmaschine	BR2LM	5798	0,7	310
KM 750		Kehrmaschine	BR2LM	5798	0,7	310
MH 202 T		Motorhacke	BPMR6A	6726	0,6	307
MH 300		Motorhacke	B4LM	3410	0,5	301
MH 325 T		Motorhacke	BR2LM	5798	0,7	310
MH 50		Motorhacke	B4LM	3410	0,5	301
MH 50 R		Motorhacke	B4LM	3410	0,5	301
MH 522 BR		Motorhacke	BR2LM	5798	0,7	310
MH 562 HR		Motorhacke	BPR6ES	7822	0,7	
MH 580		Motorhacke	BPR6ES	7822	0,7	
SF 50		Bodenfräse	BPR5ES	7422	0,6	
TBL 4600		Laubsauger / Bläser	BPM6A	7021	0,6	304
TCS 3401		Laubsauger / Bläser	BPMR6A	6726	0,6	307
THB 2510		Laubsauger / Bläser	BPMR6A	6726	0,6	307
THB 2510 V		Laubsauger / Bläser	BPMR6A	6726	0,6	307
TPH 2510		Heckenschere	BPMR6A	6726	0,6	307
TPS 2510		Heckenschere	BPMR6A	6726	0,6	307
UE 500 Super H		Multitec / Einachser	BPR6ES	7822	0,7	
UE 500 Super T		Multitec / Einachser	BR4LM	4133	0,5	
UE 510 H		Multitec / Einachser	BPR6ES	7822	0,7	
UE 510 Super I		Multitec / Einachser	BR4HS	3322	0,6	
UE 600		Multitec / Einachser	BR4HS	3322	0,6	
UE 600 A		Traktor	B4H	4110	0,6	
UE 600 H		Multitec / Einachser	BPR6ES	7822	0,7	
UE 600 i		Traktor	B4H	4110	0,6	
WM 60BR		Gestrüppschneider	BR2LM	5798	0,7	310
WM 60B		Gestrüppschneider	BKR5ES	2460	0,7	

# Diverse Arbeitsgeräte / Various Tools



Order  
No.



Quick  
No.

## HINOMOTO

C142, C144, C172, C174	Traktor	Y-112T	6327		
E2302, E2304	Traktor	Y-112T	6327		
E322, E324, E382	Traktor	Y-122	6925		
E384, E392, E394	Traktor	Y-122	6925		
E402, E404	Traktor	Y-112T	6327		
JF-1	Traktor	Y-112T	6327		
JF-1 IC Glow System	Traktor	Y-702R	1065		

## HIRTH

04	Mehrzweckmotor	BPMR6A	6726	0,5	308
08	Mehrzweckmotor	B7HS	5110	0,5	204
84	Mehrzweckmotor	A6	1010	0,5	
85	Mehrzweckmotor	A6	1010	0,5	
102	Mehrzweckmotor	B5HS	4210	0,5	
112	Mehrzweckmotor	A6	1010	0,5	
150	Mehrzweckmotor	A6	1010	0,5	
151	Mehrzweckmotor	A6	1010	0,5	
152	Mehrzweckmotor	B6HS	4510	0,5	203
241	Mehrzweckmotor	B5HS	4210	0,5	
263	Mehrzweckmotor	B7ES	1111	0,5	
1440	Mehrzweckmotor	B6HS	4510	0,5	203
1444	Mehrzweckmotor	B6HS	4510	0,5	203
2702	Mehrzweckmotor	B8HS	5510	0,5	205

## HOMELITE

ht 17	Heckenschere	BPMR7A	4626	0,6	309
ht 21	Heckenschere	BPMR7A	4626	0,6	309
HX 16	Heckenschere	BPMR7A	4626	0,6	309

## HONDA

90		YS-101	5825		
100		YS-101	5825		
F 110	Hacke	BMR4A	5728	0,6	306
F 210	Hacke	BMR4A	5728	0,6	306
F 220	Hacke	CR4HSB	4695	0,5	
F 325	Hacke	BPR6ES	7822	0,6	
F 360	Hacke	BPR5ES	7422	0,6	
F 501	Hacke	BPR5ES	7422	0,6	
F 560	Hacke	BPR5ES	7422	0,6	
F 660	Hacke	BPR5ES	7422	0,6	
F 720	Hacke	BPR5ES	7422	0,6	
F 810	Hacke	BPR5ES	7422	0,6	
FF 300	Motorhacke	CR5HSB	6535	0,7	
FF 500	Hacke	BPR6ES	7822	0,7	
FG 110	Motorhacke	CMR5H	7599	0,6	
FG 200	Hacke	CR4HSB	4695	0,5	
FG 201	Hacke	CR4HSB	4695	0,5	
FG 205	Hacke	CR4HSB	4695	0,5	
FG 220	Hacke	CR4HSB	4695	0,5	
FG 315	Hacke	BPR6ES	7822	0,7	
FG 315	Motorhacke	BPR6ES	7822	0,7	
FG 500	Hacke	BPR6ES	7822	0,7	

# Diverse Arbeitsgeräte / Various Tools



Order No.  Quick No.

**HONDA**

FG 500	Motorhacke	BPR6ES	7822	0,7	
FR 750	Hacke	BPR5ES	7422	0,7	
FU 750 Lucky		BPR6ES	7822	0,6	
G 100 K1		BMR4A	5728	0,7	306
G 100 K2		BPMR4A	6028	0,7	
G 101		BR4HS	3322	0,6	
G 150		BR4HS	3322	0,6	
G 150 CDI		BR4HS	3322	1,0	
G 150 K1		B4H	4110	0,6	
G 200		BR4HS	3322	0,6	
G 200 CDI		BPR4HS-10	5024	1,0	
G 200 K1		B4H	4110	0,6	
G 300		BR4HS	3322	0,6	
G 300 CDI		BPR4HS-10	5024	1,0	
G 400		BPR4HS-10	5024	1,0	
G 400 K1		BPR4HS	7823	0,6	
G 400 K1 CDI		BPR4HS-10	5024	1,0	
GC 135		BPR6ES	7822	0,7	
GC 160		BPR6ES	7822	0,7	
GC 190		BPR6ES	7822	0,7	
GCV 135		BPR6ES	7822	0,7	
GCV 160		BPR6ES	7822	0,7	
GCV 190		BPR6ES	7822	0,7	
GCV 520		BPR5ES	7422	0,5	
GCV 530		BPR5ES	7422	0,5	
GD90		YS-101	5825		
GD100		YS-101	5825		
GS 160		BPR6ES	7822	0,7	
GS 190		BPR6ES	7822	0,7	
GS 190		BPR6ES	7822	0,7	
GSV 160		BPR6ES	7822	0,7	
GSV 190		BPR6ES	7822	0,7	
GV 100		BMR4A	5728	0,6	306
GV 100 K1		BMR4A	5728	0,6	306
GV 100 K2		BPMR4A	6028	0,6	
GV 150		BMR6A	7421	0,9	307
GV 150 CDI		BPMR6A	6726	0,9	308
GV 200		BMR6A	7421	0,9	307
GV 200 CDI		BPMR6A	6726	0,9	308
GV 400		BMR6A	7421	0,9	307
GV 400 CDI		BPMR6A	6726	0,9	308
GX 22		CR5HSB	6535	0,7	
GX 25		CMR5H	7599	0,6	
GX 30		CR5HSB	6535	0,7	
GX 31		CR5HSB	6535	0,7	
GX 35		CMR5H	7599	0,6	
GX 100		CR5HSB	6535	0,6	
GX 100 TAMP		CR5HSB	6535	0,6	
GX 110		BPR6ES	7822	0,6	
GX 120	-->series No. 3235089	BP4ES	6928	0,7	
GX 120	3235090 -->series No.	BPR4ES	7222	0,7	
GX 120	Starke Beanspruchung / Heavy service	BPR6ES	7822	0,7	



# Diverse Arbeitsgeräte / Various Tools



Order  
No.



Quick  
No.

## HONDA

GX 140		BPR6ES	7822	0,6	
GX 160 T1		BPR4ES	7222	0,7	
GX 160 K1		BPR4ES	7222	0,7	
GX 200		BPR6ES	7822	0,7	
GX 240		BPR6ES	7822	0,7	
GX 240 K1		BPR5ES	7422	0,7	
GX 270		BPR6ES	7822	0,7	
GX 340		BPR6ES-11	4824	1,1	
GX 340 K1		BPR6ES	7822	0,7	
GX 360		BPR4HS	7823	0,6	
GX 360 K1		BPR4HS	7823	0,6	
GX 390 K1		BPR6ES	7822	0,7	
GX 390		BPR6ES	7822	0,7	
GX 610 K1		ZGR5A	5839	0,6	
GX 610		BPR6ES	7822	0,7	
GX 620 K1		ZGR5A	5839	0,6	
GX 620		BPR6ES	7822	0,7	
GX 640		BPR5ES-11	4424	1,1	
GX 670	Leichter Einsatz	BPR2ES	2264	0,6	
GX 670	Sehr schwerer Einsatz	ZGR5A	5839	0,6	
GXH 50		CR5HSB	6535	0,5	
GXV 50		CR5HSB	6535	0,7	
GXV 120		BPR5ES	7422	0,7	
GXV 140		BPR5ES	7422	0,7	
GXV 160		BPR5ES	7422	0,7	
GXV 160 K1,H2		BPR5ES	7422	0,7	
GXV 270		BPR5ES	7422	0,7	
GXV 270 K1		BPR5ES	7422	0,7	
GXV 340		BPR5ES	7422	0,7	
GXV 340 K1		BPR5ES	7422	0,7	
GXV 340 K2,T2		BPR5ES	7422	0,7	
GXV 390		BPR5ES	7422	0,7	
GXV 390 K1		BPR5ES	7422	0,7	
GXV 390 K2		BPR5ES	7422	0,7	
GXV 520		BPR5ES	7422	0,7	
GXV 530		BPR5ES	7422	0,7	
GXV 610		BPR5ES	7422	0,7	
GXV 610 K1		ZGR5A	5839	0,6	
GXV 620		BPR5ES	7422	0,7	
GXV 620 K1		ZGR5A	5839	0,6	
GXV 670	Leichter Einsatz	BPR2ES	2264	0,6	
GXV 670	Sehr schwerer Einsatz	ZGR5A	5839	0,6	
H 5518	Traktor	BPR5ES-11	4424	1,1	
H 5518	Traktor	BPR5ES-11	4424	0,6	
H 6522	Traktor	Y-703R	3782		
HHBH 25	Laubbläser	CMR5H	7599	0,6	
HHH 25D-60	Heckenschere	CMR5H	7599	0,6	
HHH 25D-75	Heckenschere	CMR5H	7599	0,6	
HHH 25S-75	Heckenschere	CMR5H	7599	0,6	
HP 250	Allwegtransporter	BMR4A	5728	0,7	306
HP 300	Allwegtransporter	BPR4ES	7222	0,7	
HP 400	Allwegtransporter	BPR4ES	7222	0,7	

# Diverse Arbeitsgeräte / Various Tools



Order  
No.



Quick  
No.

## HONDA

HP 500 BXE	Allwegtransporter	BPR6ES	7822	0,8	
HP 500 NXE	Allwegtransporter	BPR6ES	7822	0,8	
HS 550	Schneefräse	BPR5ES	7422	0,5	
HS 621	Schneefräse	BPR5ES	7422	0,6	
HS 622T	Schneefräse	BPR5ES	7422	0,6	
HS 622TS	Schneefräse	BPR5ES	7422	0,6	
HS 622W	Schneefräse	BPR5ES	7422	0,6	
HS 624T	Schneefräse	BPR5ES	7422	0,6	
HS 624TS	Schneefräse	BPR5ES	7422	0,6	
HS 624W	Schneefräse	BPR5ES	7422	0,6	
HS 624WS	Schneefräse	BPR5ES	7422	0,6	
HS 760	Schneefräse	BPR5ES	7422	0,6	
HS 828TS	Schneefräse	BPR5ES	7422	0,6	
HS 828W	Schneefräse	BPR5ES	7422	0,6	
HS 828WS	Schneefräse	BPR5ES	7422	0,6	
HS 970	Schneefräse	BPR5ES	7422	0,6	
HS 1136G	Schneefräse	BP5ES	6511	0,6	
HS 1180	Schneefräse	BPR5ES	7422	0,5	
HS 1390	Schneefräse	BPR5ES	7422	0,6	
HS 1810	Schneefräse	ZGR5A	5839	0,6	
iGX 440 4T		BKR6E	6962	0,7	
W40		YS-101	5825		
WB 10	Wasserpumpe	BMR4A	5728	0,7	306
WB 15	Wasserpumpe	BMR4A	5728	0,7	306
WB 20 XT	Frischwasserpumpw	BPR6ES	7822	0,7	
WB 30 XT	Frischwasserpumpw	BPR6ES	7822	0,7	
WH 15 X	Wasserpumpe	BPR6ES	7822	0,7	
WH 20 X	Wasserpumpe	BPR6ES	7822	0,7	
WJR 1525	Spreyer	CMR4H			
WJR 2525	Spreyer	CMR4H			
WMP 20X	Wasserpumpe	BPR6ES	7822	0,8	
WN 20	Wasserpumpen	BPR6ES	7822	0,8	
WP 20 X	Wasserpumpe	BPR6ES	7822	0,7	
WP 30 X	Wasserpumpe	BPR6ES	7822	0,7	
WT 30 X	Wasserpumpe	BPR6ES	7822	0,7	
WT 40 X	Wasserpumpe	BPR6ES	7822	0,7	
WX 10	Wasserpumpe	CR5HSB	6535	0,7	
WX 15	Wasserpumpe	CR5HSB	6535	0,7	

## ISHIKAWAJIMA-SHIBAURA

CM224(S753)		Y-701R	7464		
CM274(J823)		Y-701R	7464		
DL, LFD, MWN, LE-892		Y-401-3	only OE		
E642 For EU		Y-107V	6628		
E643 For EU		Y-107V	6628		
E643, E673 For USA,CDN		Y-701R	7464		
E672		Y-701R	7464		
H763, H843		Y-107V	6628		
J774, J774T		Y-701R	7464		
J823, J843 For EU		Y-107V	6628		
J823, J843 For USA,CDN		Y-701R	7464		
K713, K773		Y-107V	6628		

# Diverse Arbeitsgeräte / Various Tools



Order  
No.



Quick  
No.

## ISHIKAWAJIMA-SHIBAURA

LEH822, LEK752C, LEK802D	Y-107V	6628		
LEM754A, LEM754AT	Y-107V	6628		
LEP854A	Y-107V	6628		
LGT(E643)	Y-701R	7464		
LGT16(E673)	Y-701R	7464		
N843, N844 For USA,CDN	Y-701R	7464		
N843,N844,N844-T For USA,CDN	Y-701RS	2765		
N843-DI	Y-119V	only OE		
N844 For EU	Y-701R	7464		
N844L For EU	Y-107V	6628		
S723, S753 For USA,CDN	Y-701R	7464		
S723, S753, S773 For EU	Y-107V	6628		
S773L	YE01	2649		
T854B For EU	Y-107V	6628		
T854B, T854BT	Y-701R	7464		
T854B-DI, T854B-DI(T/C)	Y-119V	only OE		

## JOHN DEERE

2	Luftbesen	BM6A	5921	0,6	303
4	Luftbesen	BM6A	5921	0,6	303
5	Holzspalter	B6S	3510	0,6	302
320	Schneeräumer	B2	3110	0,6	
321	Schneeräumer	BPMR6A	6726	0,6	308
520	Schneeräumer	BPMR6A	6726	0,6	308
824	Schneeräumer	BPMR6A	6726	0,6	308
1010 LPG		B6L	3212	0,4	
1010 Gas		B6L	3212	0,6	
1020 Gas		BP5ES	6511	0,6	
1026	Schneeräumer	B4LM	3410	0,6	301
1520 Gas		BP5ES	6511	0,6	
2010 LPG		B6L	3212	0,4	
2010 Gas		B6L	3212	0,6	
2020 Gas		BP5ES	6511	0,6	
2030 Gas		BP5ES	6511	0,6	
2510 Gas		BP5ES	6511	0,6	
2520 Gas		BP5ES	6511	0,6	
2520 LPG		AB-6	2910	0,4	
3010 LPG		AB-6	2910	0,4	
3010 Gas		AB-6	2910	0,6	
3020 LPG		AB-6	2910	0,4	
3020 Gas		AB-6	2910	0,6	
320 Gas		B6L	3212	0,6	
330 Gas		B6L	3212	0,6	
3TN66-UJ Diesel		Y-702R	1065	---	
3TN66-UJ		Y-702R	1065		
3TN72-UJ		Y-702R	1065		
3TN72-UJ Diesel		Y-702R	1065	---	
40 Gas		B6L	3212	0,6	
4000 LPG		AB-6	2910	0,4	
4000 Gas		AB-6	2910	0,6	
4010 LPG		AB-6	2910	0,4	
4010 Gas		AB-6	2910	0,6	

# Diverse Arbeitsgeräte / Various Tools



Order  
No.



Quick  
No.

## JOHN DEERE

4020 LPG		AB-6	2910	0,4
4020 Gas		AB-6	2910	0,6
4030 Gas		BP5ES	6511	0,6
420 Gas		B6L	3212	0,6
4230 Gas		AB-6	2910	0,6
4230 LPG		AB-6	2910	0,4
430 Gas		B6L	3212	0,6
440 Gas		B6L	3212	0,6
50 LPG		AB-6	2910	0,4
50 Gas		AB-6	2910	0,7
520 Gas		AB-6	2910	0,7
520 LPG		AB-6	2910	0,4
530 LPG		AB-6	2910	0,4
530 Gas		AB-6	2910	0,7
60 LPG		AB-6	2910	0,4
60 Gas		AB-6	2910	0,7
620 Gas		AB-6	2910	0,7
620 LPG		AB-6	2910	0,4
630 Gas		AB-6	2910	0,7
630 LPG		AB-6	2910	0,4
70 LPG		AB-6	2910	0,4
70 Gas		AB-6	2910	0,7
720 LPG		AB-6	2910	0,4
720 Gas		AB-6	2910	0,7
730 LPG		AB-6	2910	0,4
730 Gas		AB-6	2910	0,7
A Gas		AB-6	2910	0,7
AR-AD Gas		AB-6	2910	0,7
B Gas		AB-6	2910	0,7
B&S	Beschneidemesser	B2LM	1147	0,6
B&S 116 engine	Kleintraktor	BR6S	3522	0,6
B&S engine	Schneeräumer	B2LM	1147	0,6
Baler Continental		AB-6	2910	0,6
Baler Wisconsin		AB-6	2910	0,6
Baler Deere		B6L	3212	0,6
Beet Harvester - 200		B6L	3212	0,6
Beet Harvester - 200A		B6L	3212	0,6
Combine - 105 Gas 18mm Hds.		AB-6	2910	0,6
Combine - 105 (Peanut Combine 111) Gas		B6L	3212	0,6
Combine - 11A, 12A Gas Deere		B6L	3212	0,6
Combine - 11A, 12A Gas Hercules		B6S	3510	0,6
Combine - 11A, 12A LPG		B6L	3212	0,4
Combine - 202 (1970-1974) Gas		YR5	5334	0,9
Combine - 203 (1970-1974) Gas		YR5	5334	0,9
Combine - 25, 30, 40 Gas Hercules		B6S	3510	0,6
Combine - 25, 30, 40 LPG		B6L	3212	0,4
Combine - 25, 30, 40 Gas Deere		B6L	3212	0,6
Combine - 3300 (1974-1970) Gas		YR5	5334	0,9
Combine - 3300 (To 1969) Gas		BP5ES	6511	0,6
Combine - 362 Gas 18mm Hds.		AB-6	2910	0,6
Combine - 4400 (1970-1974) Gas		YR5	5334	0,9
Combine - 4400 (To 1969) Gas		BP5ES	6511	0,6

# Diverse Arbeitsgeräte / Various Tools



Order  
No.



Quick  
No.

## JOHN DEERE

Combine - 45, 55, 65, 90 LPG 3/4" Rch.		<b>B6ES</b>	<b>7310</b>	0,4	
Combine - 45, 55, 65, 90 Gas Deere 3/4" Rch.		<b>BP5ES</b>	<b>6511</b>	0,6	
Combine - 45, 55, 65, 90 Gas Hercules		<b>B6S</b>	<b>3510</b>	0,6	
Combine - 45, 55, 65, 90 LPG 7/16" Rch.		<b>B6L</b>	<b>3212</b>	0,4	
Combine - 45, 55, 65, 90 Gas Deere 7/16" Rch.		<b>B6L</b>	<b>3212</b>	0,6	
Combine - 6600 (1970-1974) Gas		<b>YR5</b>	<b>5334</b>	0,9	
Combine - 6600 (To 1969) Gas		<b>BP5ES</b>	<b>6511</b>	0,6	
Combine - 6602 Gas 18mm Hds.		<b>AB-6</b>	<b>2910</b>	0,6	
Combine - 7700 Gas 18mm Hds.		<b>AB-6</b>	<b>2910</b>	0,6	
Combine - Other Gas 18mm Hds.		<b>AB-6</b>	<b>2910</b>	0,6	
Cotton Picker - 699 LPG		<b>B6ES</b>	<b>7310</b>	0,4	
Cotton Picker - 699 Gas		<b>BP5ES</b>	<b>6511</b>	0,6	
Cotton Picker - 8		<b>B6S</b>	<b>3510</b>	0,6	
Cotton Picker - 99, 299, 499 Gas		<b>B6L</b>	<b>3212</b>	0,6	
Cotton Picker - 99, 299, 499 LPG		<b>B6L</b>	<b>3212</b>	0,4	
Cranking Engine - 70		<b>B6S</b>	<b>3510</b>	0,6	
Cranking Engine - 720		<b>B6S</b>	<b>3510</b>	0,6	
Cranking Engine - 730		<b>B6S</b>	<b>3510</b>	0,6	
Cranking Engine - 80		<b>B6S</b>	<b>3510</b>	0,6	
Cranking Engine - 820		<b>B6S</b>	<b>3510</b>	0,6	
Cranking Engine - 830		<b>B6S</b>	<b>3510</b>	0,6	
Cranking Engine - R Series		<b>AB-6</b>	<b>2910</b>	0,6	
FE-1 Gas		<b>BP5ES</b>	<b>6511</b>	0,6	
Forage Harvester Continental		<b>AB-6</b>	<b>2910</b>	0,6	
Forage Harvester Wisconsin		<b>AB-6</b>	<b>2910</b>	0,6	
Grain Dryer Natural Gas		<b>AB-6</b>	<b>2910</b>	0,7	
H Gas		<b>AB-6</b>	<b>2910</b>	0,7	
Kawasaki FA210Y 5.2hp	Beschneidemesser	<b>BMR6A</b>	<b>7421</b>	0,6	<b>307</b>
Kawasaki FB460V 12.5hp	Beschneidemesser	<b>BMR6A</b>	<b>7421</b>	0,6	<b>307</b>
Kawasaki FB540V 17hp	Beschneidemesser	<b>BPR5ES</b>	<b>7422</b>	0,6	
Kawasaki FC290Y 9hp	Beschneidemesser	<b>BPR5ES</b>	<b>7422</b>	0,6	
	Kehrmaschine	<b>B6S</b>	<b>3510</b>	0,6	<b>302</b>
Kioritz	Beschneidemesser	<b>BM6A</b>	<b>5921</b>	0,6	<b>303</b>
Kohler K181 8hp	Beschneidemesser	<b>B6S</b>	<b>3510</b>	0,6	<b>302</b>
Kohler K241 10hp	Beschneidemesser	<b>B6L</b>	<b>3212</b>	0,6	
Kohler K301 12hp	Beschneidemesser	<b>B6L</b>	<b>3212</b>	0,6	
Kohler K321 14hp	Beschneidemesser	<b>B6L</b>	<b>3212</b>	0,6	
Kohler K341 16hp	Beschneidemesser	<b>B6L</b>	<b>3212</b>	0,6	
Kohler K532 20hp	Beschneidemesser	<b>B6L</b>	<b>3212</b>	0,6	
Kohler KT17 17hp	Beschneidemesser	<b>UR4</b>	<b>4762</b>	0,6	
Tecumseh	Beschneidemesser	<b>B6S</b>	<b>3510</b>	0,6	<b>302</b>
L Gas		<b>B6L</b>	<b>3212</b>	0,6	
LA-L1 Gas		<b>B6L</b>	<b>3212</b>	0,6	
M Gas		<b>B6L</b>	<b>3212</b>	0,6	
Onan 316 engine	Kleintraktor	<b>TR5</b>	<b>7837</b>	0,6	
Onan 318 engine	Kleintraktor	<b>TR5</b>	<b>7837</b>	0,6	
Onan 420 engine	Kleintraktor	<b>TR5</b>	<b>7837</b>	0,6	
	Spreyer	<b>B6S</b>	<b>3510</b>	0,6	<b>302</b>
Tecumseh engine	Schneeräumer	<b>B6S</b>	<b>3510</b>	0,6	<b>302</b>
Windrower Continental		<b>AB-6</b>	<b>2910</b>	0,6	
Windrower Wisconsin		<b>AB-6</b>	<b>2910</b>	0,6	
Windrower Deere 7/16" Rch.		<b>B6L</b>	<b>3212</b>	0,6	

# Diverse Arbeitsgeräte / Various Tools



Order  
No.



Quick  
No.

## JOHN DEERE

Windrower Deere 3/4" Rch.		BP5ES	6511	0,6	
Windrower (1975) Chrysler HB225		UR4	4762	0,6	
Windrower (To 1974) Chrysler HB225		BP5ES	6511	0,6	
X 575	Traktor	BPR2ES	2264	0,6	
Yanmar F912	Kleintraktor	BP5ES	6511	0,6	
Yanmar F932	Kleintraktor	BP5ES	6511	0,6	

## JONSERED

BV 32	Luftbesen	BPM6A	7021	0,4	304
HT 21	Heckenschere	BPM6A	7021	0,7	304
HT 24	Heckenschere	BPM6A	7021	0,6	304
WP 25	Wasserpumpe	BPM6A	7021	0,6	304

## KAWASAKI

FA 76 -82	Vorsatzmotor	BMR6A	7421	0,7	307
FA 76 83-	Vorsatzmotor	BM4A	5628	0,7	
FA 76, 130, 210	Vorsatzmotor	BP4HS	3611	0,7	
FA 130	Vorsatzmotor	BMR6A	7421	0,7	307
FA 210 -82	Vorsatzmotor	BM6	2027	0,7	
FA 210 83-	Vorsatzmotor	BM6A	5921	0,7	303
FB 460	Vorsatzmotor	BMR4A	5728	0,7	306
FC 150 , 180	Vorsatzmotor	BPR5ES	7422	0,7	
FC 290 V	Mehrzweckmotor	BPR5ES	7422	0,6	
FC 290, 400, 401	Vorsatzmotor	BPR5ES	7422	0,7	
FC 420 V	Mehrzweckmotor	BPR5ES	7422	0,6	
FC 420, 540	Vorsatzmotor	BPR5ES	7422	0,7	
FC 540 V	Mehrzweckmotor	BPR5ES	7422	0,6	
FC150V	Vorsatzmotor	BPR5ES	7422	0,6	
FC180V	Vorsatzmotor	BPR5ES	7422	0,6	
FD 440, 501, 590	Vorsatzmotor	BMR6A	7421	0,7	307
FD 590V	Vorsatzmotor	BMR4A	5728	0,6	306
FD 611V	Vorsatzmotor	BMR6A	7421	0,6	307
FD 620	Vorsatzmotor	BMR4A	5728	0,7	306
FD 661D	Vorsatzmotor	BMR6A	7421	0,6	307
FD 671 D	Mehrzweckmotor	BPR2ES	2264	0,6	
FD 711 D	Mehrzweckmotor	BPR2ES	2264	0,6	
FD 750 D	Mehrzweckmotor	BPR2ES	2264	0,6	
FD 791 DFI	Mehrzweckmotor	BPR4ES	7222	0,6	
FE 120, 170, 250	Vorsatzmotor	BPR5ES	7422	0,7	
FE 290, 350	Vorsatzmotor	BPR5ES	7422	0,7	
FE 400 D	Mehrzweckmotor	BPR5ES	7422	0,6	
FG 110	Vorsatzmotor	BP4HS	3611	0,7	
FG 150	Vorsatzmotor	BPR4HS	7823	0,7	
FG 200, 201, 230	Vorsatzmotor	BP4HS	3611	0,7	
FG 270, 300	Vorsatzmotor	BP4HS	3611	0,7	
FH 381 V	Mehrzweckmotor	BPMR6A	6726	0,6	308
FH 430 V	Mehrzweckmotor	BPMR6A	6726	0,6	308
FH 451 V	Mehrzweckmotor	BPMR6A	6726	0,6	308
FH 500 V	Vorsatzmotor	BPMR6A	6726	0,6	308
FH 531 V	Mehrzweckmotor	BPMR6A	6726	0,6	308
FH 601 D	Mehrzweckmotor	BPR5ES	7422	0,6	
FH 601 V	Mehrzweckmotor	BPR4ES	7222	0,6	

# Diverse Arbeitsgeräte / Various Tools



Order  
No.



Quick  
No.

## KAWASAKI

FH 641 D	Mehrzweckmotor	BPR5ES	7422	0,6	
FH 641 V	Mehrzweckmotor	BPR4ES	7222	0,6	
FH 680 D	Mehrzweckmotor	BPR5ES	7422	0,6	
FH 680 V	Mehrzweckmotor	BPR4ES	7222	0,6	
FH 721 D	Mehrzweckmotor	BPR4ES	7222	0,6	
FH 721 V	Mehrzweckmotor	BPR4ES	7222	0,6	
KEL 26A	Rasenkantenschneider	BPMR6A	6726	0,6	308
KF 24, 53,-A, 82	Vorsatzmotor	B6HS	4510	0,7	203
KF 64, 140	Vorsatzmotor	B4	3210	0,7	
KF 100	Vorsatzmotor	BR4HS	3322	0,7	
KF 150, 200	Vorsatzmotor	B4H	4110	0,7	
KHD 600 B	Heckenschere	BPMR6A	6726	0,6	308
KHD 600A	Heckenschere	BMR4A	5728	0,7	306
KHS 750 B	Heckenschere	BPMR6A	6726	0,6	308
KHS 750A	Heckenschere	BMR4A	5728	0,7	306
KHT 600 D	Heckenschere	BPMR6A	6726	0,6	308
KHT 750 D	Heckenschere	BPMR6A	6726	0,6	308
KRB 400A	Laubbläser	BPMR7A	4626	0,5	309
KRB 400B	Laubbläser	BPMR7A	4626	0,5	309
KT 12	Vorsatzmotor	BM6A	5921	0,7	303
KT 12AD	Vorsatzmotor	BMR6A	7421	0,7	307
KT 12D, -J, 15D	Vorsatzmotor	BM7	6321	0,7	
KT 15J	Vorsatzmotor	B6S	3510	0,7	302
KT 17J	Vorsatzmotor	BM7A	6521	0,7	
KT 18J -82	Vorsatzmotor	B6S	3510	0,7	302
KT 18J 83-	Vorsatzmotor	B4	3210	0,7	
KT 28 -82	Vorsatzmotor	B6S	3510	0,7	302
KT 28 83-	Vorsatzmotor	B4	3210	0,7	
KT 29	Vorsatzmotor	B6HS	4510	0,7	203
KT 30J, 35	Vorsatzmotor	B6S	3510	0,7	302
KT 33, 43	Vorsatzmotor	B6HS	4510	0,7	203
KWN 10 A	Wasserpumpe	BMR7A	4626	0,5	
KWN 15 A	Wasserpumpe	BMR6A	7421	0,5	307
KWN 20 A	Wasserpumpe	BPR5ES	7422	0,6	
KWN 30 A	Wasserpumpe	BPR5ES	7422	0,6	
KWS 20 A	Wasserpumpe	BPR5ES	7422	0,6	
KWS 30 A	Wasserpumpe	BPR5ES	7422	0,6	
KWT 20 A	Wasserpumpe	BPR5ES	7422	0,6	
KWT 30 A	Wasserpumpe	BPR5ES	7422	0,6	
KWT 40 A	Wasserpumpe	BPR5ES	7422	0,6	
TA 22, 24, 33	Vorsatzmotor	BM7	6321	0,7	
TA 36, 51	Vorsatzmotor	B7S	3710	0,7	
TA 40 -82	Vorsatzmotor	B7S	3710	0,7	
TA 40 83-	Vorsatzmotor	BM7	6321	0,7	
TD 18, 48	Vorsatzmotor	BM6A	5921	0,7	303
TD 24, 33 / -82	Vorsatzmotor	BM7	6321	0,7	
TD 24, 33 / 83-	Vorsatzmotor	BM6A	5921	0,7	303
TD 40, 51 / -82	Vorsatzmotor	BM7	6321	0,7	
TD 40, 51 / 83-	Vorsatzmotor	BM6A	5921	0,7	303
TE 27, 35, 40	Vorsatzmotor	BM7A	6521	0,7	
TE 48, 56	Vorsatzmotor	BM7A	6521	0,7	
TE 59	Vorsatzmotor	BPM7A	7321	0,6	305

# Diverse Arbeitsgeräte / Various Tools



Order No.  Quick No.

<b>KAWASAKI</b>					
TEX 45	Vorsatzmotor	BPM7A	7321	0,6	305
TEX 54	Vorsatzmotor	BM6A	5921	0,7	303
TF 22	Vorsatzmotor	BM7A	6521	0,7	
TF 24, 33	Vorsatzmotor	BM7A	6521	0,7	
TG 18, 20, 24	Vorsatzmotor	BM6A	5921	0,7	303
TG 25, 28, 33	Vorsatzmotor	BM6A	5921	0,7	303
TGX 23	Vorsatzmotor	BM6A	5921	0,7	303
TH 26	Vorsatzmotor	BPMR6A	6726	0,5	308
TH 23		BPMR6A	6726	0,6	308
TH 26		BPMR6A	6726	0,6	308
TH 34	Mehrzweckmotor	BPMR6A	6726	0,6	308
TH 43, 48	Vorsatzmotor	BM6A	5921	0,7	303
<b>KOHLER</b>					
CH11	Command OHV Horizontal Twin	BKR5E-11	6953	1,1	
CH12.5	Command OHV Horizontal Twin	BKR5E-11	6953	1,1	
CH13	Command OHV Horizontal Twin	BKR5E-11	6953	1,1	
CH14	Command OHV Horizontal Twin	BKR5E-11	6953	1,1	
CH15	Command OHV Horizontal Twin	BKR5E-11	6953	1,1	
CH18	Command OHV Horizontal Twin	BKR5E	7938	0,7	
CH20	Command OHV Horizontal Twin	BKR5E	7938	0,7	
CH22	Command OHV Horizontal Twin	BKR5E	7938	0,7	
CH23	Command OHV Horizontal Twin	BKR5E	7938	0,7	
CH25	Command OHV Horizontal Twin	BKR5E	7938	0,7	
CH26	Command OHV Horizontal Twin	BKR5E	7938	0,7	
CH27	Command OHV Horizontal Twin	BKR5E	7938	0,7	
CH5	Command OHV Horizontal Twin	BKR5E-11	6953	1,1	
CH6	Command OHV Horizontal Twin	BKR5E-11	6953	1,1	
CH730	Command OHV Horizontal Twin	BKR5E	7938	0,7	
CH740	Command OHV Horizontal Twin	BKR5E	7938	0,7	
CH745	Command OHV Horizontal Twin	BKR5E	7938	0,7	
CS10	Command Pro CS Series Horizontal Shaft	BPR4ES	7222	0,7	
CS12	Command Pro CS Series Horizontal Shaft	BPR4ES	7222	0,7	
CS13 HYDRO	Command Pro CS Series Horizontal Shaft	BPR4ES	7222	0,7	
CS4	Command Pro CS Series Horizontal Shaft	BPR4ES	7222	0,7	
CS6	Command Pro CS Series Horizontal Shaft	BPR4ES	7222	0,7	
CS8.5	Command Pro CS Series Horizontal Shaft	BPR4ES	7222	0,7	
CV11	Command OHV Vertical Twin	BKR5E-11	6953	1,1	
CV12.5	Command OHV Vertical Twin	BKR5E-11	6953	1,1	
CV13	Command OHV Vertical Twin	BKR5E-11	6953	1,1	
CV14	Command OHV Vertical Twin	BKR5E-11	6953	1,1	
CV15	Command OHV Vertical Twin	BKR5E-11	6953	1,1	
CV17	Command OHV Vertical Twin	BKR5E	7938	0,7	
CV18	Command OHV Vertical Twin	BKR5E	7938	0,7	
CV20	Command OHV Vertical Twin	BKR5E	7938	0,7	
CV22	Command OHV Vertical Twin	BKR5E	7938	0,7	
CV23	Command OHV Vertical Twin	BKR5E	7938	0,7	
CV25	Command OHV Vertical Twin	BKR5E	7938	0,7	
CV26	Command OHV Vertical Twin	BKR5E	7938	0,7	
CV460	Command OHV Vertical Twin	BKR5E	7938	0,7	
CV490	Command OHV Vertical Twin	BKR5E	7938	0,7	
CV492	Command OHV Vertical Twin	BKR5E	7938	0,7	



# Diverse Arbeitsgeräte / Various Tools



Order  
No.



Quick  
No.

## KOHLER

CV493		Command OHV Vertical Twin	BKR5E	7938	0,7	
CV730		Command OHV Vertical Twin	BKR5E	7938	0,7	
CV740		Command OHV Vertical Twin	BKR5E	7938	0,7	
CV745		Command OHV Vertical Twin	BKR5E	7938	0,7	
K12	4HP	K Series	XR5	5953	0,6	
K121	5HP	K Series	BR2LM	5798	0,7	310
K141	6,25HP	K Series	BR2LM	5798	0,7	310
K161, L161	7HP	K Series	BR2LM	5798	0,7	310
K181, L181	8HP	K Series	BR2LM	5798	0,7	310
K241	10HP	K Series	B6L	3212	0,6	
K301	12HP	K Series	B6L	3212	0,6	
K321	14HP	K Series	B6L	3212	0,6	
K330, K331	12,5HP	K Series	BR2LM	5798	0,7	310
K341	16HP	K Series	B6L	3212	0,6	
K361, K482	18HP	K Series	B6L	3212	0,6	
K532	20HP	K Series	B6L	3212	0,6	
K582 (Twin)	23HP	K Series	B6L	3212	0,6	
K660, K662	24HP	K Series	BR2LM	5798	0,7	310
K7	2.7HP	K Series	XR5	5953	0,6	
K90, K91	4HP	K Series	BR2LM	5798	0,7	310
KL25	25HP	K Series	BPR6ES	7822	0,7	
KT17 (Twin)	17HP	K Series	BPR4FS	1127	0,6	
KT19 (Twin)	19HP	K Series	BPR4FS	1127	0,6	
KT20 (Twin)	20HP	K Series	BPR4FS	1127	0,6	
KT21 (Twin)	21HP	K Series	BPR4FS	1127	0,6	
LH630	22HP	Aegis Series	BKR5E	7938	0,7	
LH685	25HP	Aegis Series	BKR5E	7938	0,7	
LV625	20HP	Aegis Series	BKR5E	7938	0,7	
LV675	23HP	Aegis Series	BKR5E	7938	0,7	
M10		Magnum Horizontal Twin	B6L	3212	0,6	
M12		Magnum Horizontal Twin	B6L	3212	0,6	
M14		Magnum Horizontal Twin	B6L	3212	0,6	
M16		Magnum Horizontal Twin	B6L	3212	0,6	
M18		Magnum Horizontal Twin	BPR4FS	1127	0,6	
M20		Magnum Horizontal Twin	BPR4FS	1127	0,6	
M8		Magnum Horizontal Twin	BR6S	3522	0,6	
MV16		Magnum Vertical Twin	BPR4FS	1127	0,6	
MV18		Magnum Vertical Twin	BPR4FS	1127	0,6	
MV20		Magnum Vertical Twin	BPR4FS	1127	0,6	
MV23		Magnum Vertical Twin	B6L	3212	0,6	
SV470		Courage OHV	BKR5E	7938	0,7	
SV480		Courage OHV	BKR5E	7938	0,7	
SV530		Courage OHV	BKR5E	7938	0,7	
SV540		Courage OHV	BKR5E	7938	0,7	
SV590		Courage OHV	BKR5E	7938	0,7	
SV600		Courage OHV	BKR5E	7938	0,7	
TH14 (Twin)		Triad OHC	BKR5E-11	6953	1,1	
TH16 (Twin)		Triad OHC	BKR5E-11	6953	1,1	
TH18 (Twin)		Triad OHC	BKR5E-11	6953	1,1	

## KUBOTA

B 1200 (D750L)		Traktor	Y-103V	2031		
----------------	--	---------	--------	------	--	--

# Diverse Arbeitsgeräte / Various Tools



Order  
No.



Quick  
No.

## KUBOTA

B 1400 (D850L)	Traktor	Y-103V	2031		
B 1402DT (D850L)	Traktor	Y-103V	2031		
B 1500 (D850M)	Traktor	Y-103V	2031		
B 1502DT (D850M)	Traktor	Y-103V	2031		
B 1600 (D950)	Traktor	Y-103V	2031		
B 1702 (D950)	Traktor	Y-103V	2031		
B 1902 (D950)	Traktor	Y-103V	2031		
B 5001 (Z5001-1)	Traktor	Y-103V	2031		
B 5100 (Z500-1A)	Traktor	Y-103K	6325		
B 6100 (D650A)	Traktor	Y-103K	6325		
B 7001 (D750A)	Traktor	Y-103K	6325		
B 7100 (D750A)	Traktor	Y-103K	6325		
B 8200 (D950)	Traktor	Y-103V	2031		
B1200 D750L		Y-103V	2031		
B1400,B1402DT D850L		Y-103V	2031		
B1500,B1502DT D850M		Y-103V	2031		
B1550 D850-5B		Y-702R	1065		
B1600,B1702,B1902 D950		Y-103V	2031		
B1750 D950-5B		Y-702R	1065		
B1902DT DM1102		Y-106V	6926		
B2150 D1200-5B		Y-702R	1065		
B4200 Z600-A		Y-103V	2031		
B5001 Z5001-1		Y-103V	2031		
B5100 Z500-1A		Y-103K	6325		
B5200 D750-LA		Y-103V	2031		
B6100 D650A		Y-103K	6325		
B6200 D850-LA-1		Y-103V	2031		
B7001 D750		Y-103K	6325		
B7100 D750A		Y-103K	6325		
B7200 D950-LAH		Y-103V	2031		
B8200 D950		Y-103V	2031		
B9200 V1200-A		Y-103V	2031		
Combine - NX1000 Z600		Y-103V	2031		
Combine - NX1100 ZB500		Y-103K	6325		
Combine - NX1300 ZB600		Y-103K	6325		
Combine - NX1500 D850C		Y-103K	6325		
Combine - NX1600 D950		Y-103V	2031		
Combine - NX1800 D850		Y-103K	6325		
Combine - NX2000 D950C		Y-103V	2031		
Combine - NX2200 D950		Y-103V	2031		
Combine - NX250 GN250		B4H	4110	1,0	
Combine - NX3000 D1301		Y-106-1	6525		
Combine - NX3000-1 V1502		Y-106V	6926		
Combine - RX1100 Z600-C1		Y-103V	2031		
Combine - RX1300 Z620C		Y-103V	2031		
Combine - RX1450 D640-C		Y-103V	2031		
Combine - RX1500 D750-C		Y-103V	2031		
Combine - RX1500 D750		Y-103K	6325		
Combine - RX1550 D750-C		Y-103V	2031		
Combine - RX1900 D850-C2		Y-103V	2031		
Combine - RX2100 D950-C		Y-103V	2031		
Combine - RX2450 V1200-C		Y-103V	2031		

# Diverse Arbeitsgeräte / Various Tools



Order  
No.



Quick  
No.

## KUBOTA

Combine - RX2800 DH1402-C		Y-103V	2031		
Combine - RX3250 DH62D1-C		Y-103V	2031		
Combine - RX3250 D1462 D1-C		Y-119V	only OE		
Combine - RX3350 V1200N-TC		Y-709R	3238		
Combine - RX3600 V1502		Y-106V	6926		
Combine - RX550 E75-C2		Y-103V	2031		
Combine - RX700 E75-C		Y-103V	2031		
Combine - RX750 ZB400-C2		Y-103V	2031		
Combine - RX900 ZB400		Y-103V	2031		
GL 240K (D1463-L-N)	Traktor	Y-716RS	4693		
GL 3500 (ZB400GL)	Traktor	Y-103V	2031		
GL 4500 (ZB500GL)	Traktor	Y-103V	2031		
GL 4500S (ZB400GL)	Traktor	Y-103V	2031		
GL 5500 (ZB600GL)	Traktor	Y-103V	2031		
GL 5500S (ZB500GL)	Traktor	Y-103V	2031		
GL 6500S (ZB600GL)	Traktor	Y-103V	2031		
GL240K D1463-L-N		Y-716RS	4693		
GL280K D1463-L-N		Y-716RS	4693		
GL3500 ZB400-GL		Y-103V	2031		
GL4500 ZB500-GL		Y-103V	2031		
GL4500S ZB400-GL		Y-103V	2031		
GL5500 ZB600-GL		Y-103V	2031		
GL5500S ZB500-GL		Y-103V	2031		
GL6500S ZB600-GL		Y-103V	2031		
L 175 (Z751)	Traktor	Y-106-1	6525		
L 185 (Z751-A)	Traktor	Y-106-1	6525		
L 245 (D1101-A)	Traktor	Y-106-1	6525		
L 295 (D1301-A)	Traktor	Y-106-1	6525		
L 345 (V1501DA)	Traktor	Y-106-1	6525		
L 1501 (Z751)	Traktor	Y-106-1	6525		
L 1501 (Z751)	Traktor	Y-106-1	6525		
L 1802 (D1102)	Traktor	Y-106V	6926		
L 2002 (D1302)	Traktor	Y-106V	6926		
L 2201 (DH1101)	Traktor	Y-106-1	6525		
L 2201 (DH1101)	Traktor	Y-106-1	6525		
L 2202 (D1402-L)	Traktor	Y-106V	6926		
L 2402 (D1402)	Traktor	Y-106V	6926		
L 245 (D1101-A)	Traktor	Y-106-1	6525		
L 2601 (V1502-L)	Traktor	Y-106V	6926		
L 2602 (VT1502)	Traktor	Y-106V	6926		
L 275 (D1302-A)	Traktor	Y-106V	6926		
L 2802 (V1502)	Traktor	Y-106V	6926		
L 295 (D1301-A)	Traktor	Y-106-1	6525		
L 3001 (V1501-A)	Traktor	Y-106-1	6525		
L 3001 (V1501-A)	Traktor	Y-106-1	6525		
L 305 (D1302-DA)	Traktor	Y-106V	6926		
L 3202 (V1502)	Traktor	Y-106V	6926		
L 345 (V1501-DA)	Traktor	Y-106-1	6525		
L 3602 DT (V1902)	Traktor	Y-106V	6926		
L 4202 (V1502)	Traktor	Y-106V	6926		
L 4202 DT (V1502)	Traktor	Y-106V	6926		
L 4212 (V1502)	Traktor	Y-106V	6926		

# Diverse Arbeitsgeräte / Various Tools



Order  
No.



Quick  
No.

## KUBOTA

L1501 Z751		Y-106-1	6525		
L175 Z751		Y-106-1	6525		
L1802 D1102-A		Y-106V	6926		
L185 Z751-A		Y-106-1	6525		
L2002 D1302		Y-106V	6926		
L2050 D1102-A		Y-106V	6926		
L2201 DH1101		Y-106-1	6525		
L2202 D1402-L		Y-106V	6926		
L2250 D1302-DI-A		Y-119V	only OE		
L235 D1102-A		Y-106V	6926		
L2350 D1102-A		Y-106V	6926		
L2402 D1402		Y-106V	6926		
L245 D1101-A		Y-106-1	6525		
L245-2 D1102-A		Y-106V	6926		
L2550 D1402-DI-A		Y-119V	only OE		
L2601 V1502-L		Y-106V	6926		
L2602 VT1502		Y-106V	6926		
L2650 D1402-DI-A		Y-119V	only OE		
L275 D1302-A		Y-106V	6926		
L2802 V1502		Y-106V	6926		
L2850 D1702-DI-A		Y-119V	only OE		
L295 D1301-A		Y-106-1	6525		
L2950 D1402-DI-A		Y-119V	only OE		
L295-2 D1302-A		Y-106V	6926		
L3001 V1502-A		Y-601-1	only OE		
L305 D1302-DA		Y-106V	6926		
L3202 V1502		Y-106V	6926		
L3250 V1902-DI-A		Y-119V	only OE		
L3350 V1902-DI-A		Y-119V	only OE		
L345 V1501-DA		Y-106-1	6525		
L3450 V1902-DI-AE		Y-119V	only OE		
L3602 V1902		Y-106V	6926		
L3750 F2302-DI-L		Y-119V	only OE		
L4150 F2302-DI		Y-119V	only OE		
L4202 VT1502		Y-106V	6926		
L4212 VT1502		Y-106V	6926		
L4350 V2303-DI		Y-119V	only OE		
L4850 F2503-DI		Y-119V	only OE		
L5450 F2803-DI		Y-119V	only OE		
M 4000 (S2600)	Traktor	Y-106-1	6525		
M 4000 (S2600)	Traktor	Y-106-1	6525		
M 4030 (S2600-DI)	Traktor	Y-119V	only OE		
M 4500 (S2600-A)	Traktor	Y-106-1	6525		
M 4500 (S2600-A)	Traktor	Y-106-1	6525		
M 4950 (S2800)	Traktor	Y-106V	6926		
M 5000 (D3000)	Traktor	Y-203	2532		
M 5030 (S2802-DI)	Traktor	Y-119V	only OE		
M 5270 (D3000-1)	Traktor	Y-203V	7728		
M 5500 (D3000-A)	Traktor	Y-203	2532		
M 5950 (D3200)	Traktor	Y-203V	7728		
M 5970 (D3200-1)	Traktor	Y-203V	7728		
M 6000 (V4000-L)	Traktor	Y-203	2532		

# Diverse Arbeitsgeräte / Various Tools



Order  
No.



Quick  
No.

## KUBOTA

M 6030 (D3200)	Traktor	Y-203V	7728		
M 6950 (V4000-2)	Traktor	Y-203V	7728		
M 6970 (V4000-3,V4000-4)	Traktor	Y-203V	7728		
M 7000 (V4000)	Traktor	Y-203	2532		
M 7030 (V3200,V4000)	Traktor	Y-203V	7728		
M 7950 (V4300)	Traktor	Y-203V	7728		
M 7970 (V4300-1)	Traktor	Y-203V	7728		
M 8030 (V4300)	Traktor	Y-203V	7728		
M 9750 (V4300-T1)	Traktor	Y-203V	7728		
M 9950 (V4300-T)	Traktor	Y-203V	7728		
M 10570 (F5400)	Traktor	Y-203V	7728		
M4000 S2600		Y-601-1	only OE		
M4030 S2602-DI		Y-119V	only OE		
M4500 S2602-A		Y-601-1	only OE		
M4950 S2800		Y-106V	6926		
M5000 D3000		Y-203	2532		
M5030 S2802-DI		Y-119V	only OE		
M5500 D3000-A		Y-203	2532		
M6000 V4000-L		Y-203	2532		
M7000 V4000		Y-203	2532		
M7500 V4000-A		Y-203	2532		
NX 1000 (Z600)		Y-103V	2031		
NX 1100 (ZB500)		Y-103K	6325		
NX 1300 (ZB600)		Y-103K	6325		
NX 1500 (D850C)		Y-103K	6325		
NX 1600 (D950)		Y-103V	2031		
NX 1800 (D850)		Y-103K	6325		
NX 2000 (D950C)		Y-103V	2031		
NX 2200 (D950)		Y-103V	2031		
NX 3000 (D1301)		Y-106-1	6525		
RX 550 (E75-C2)		Y-103V	2031		
RX 700 (E75-C)		Y-103V	2031		
RX 750 (ZB400-C2)		Y-103V	2031		
RX 900 (ZB400)		Y-103V	2031		
RX 1100 (Z600-C1)		Y-103V	2031		
RX 1300 (Z620-C)		Y-103V	2031		
RX 1450 (D640-C)		Y-103V	2031		
RX 1500 (D750)		Y-103K	6325		
RX 1500 (D750-C)		Y-103V	2031		
RX 1550 (D750-C)		Y-103V	2031		
RX 1900 (D850-C2)		Y-103V	2031		
RX 2100 (D950-C)		Y-103V	2031		
RX 2450 (V1200-C)		Y-103V	2031		
RX 2800 (DH1402-C)		Y-103V	2031		
RX 3250 (D1462DI-C)		Y-119V	only OE		
RX 3250 (DH62DI-C)		Y-103V	2031		
Tiller - AT25 GS90V		BR4HS	3322	0,6	
Tiller - AT55 GA200		BR4HS	3322	0,6	
Tiller - AT70S GS280		BR4HS	3322	0,6	
Tiller - FRT50 GS200		B4H	4110	0,6	
Tiller - FRT70 GS280		B4H	4110	0,6	
Tiller - T150, T250, T350 GS130		BP4HS-10	5011	1,0	

# Diverse Arbeitsgeräte / Various Tools



Order No.  Quick No.

<b>KUBOTA</b>				
Tiller - T2 GN100		B4H	4110	1,0
Tiller - T400 GS160		BP4HS-10	5011	1,0
Tiller - T402 GS230		B4H	4110	1,0
Tiller - T450 GS160		BP4HS-10	5011	1,0
Tiller - T5, T6, T7 GN250		B4H	4110	1,0
Tiller - T550 GS160		BP4HS-10	5011	1,0
Tiller - T602 GS280		B4H	4110	1,0
Tiller - T650 GN250		B4H	4110	1,0
Tiller - T702 GS280		B4H	4110	0,6
Tiller - T720 GN250		B4H	4110	1,0
Tiller - T750 GN250		B4H	4110	1,0
Tiller - T850 GS280		B4H	4110	0,6
Tiller - TD700 OC62		Y-709R	3238	
Tiller - TF35 GS150		BPR4HS-10	5024	1,0
Tiller - TF45 GS110		BPR4HS-10	5024	1,0
Tiller - TF55 GS110		BPR4HS-10	5024	1,0
Tiller - TG600 GH170		BP6HS	4511	0,6
Tiller - TG800-R GH250		BP6HS	4511	0,6
Tiller - TMA31 GS130		BP4HS-10	5011	1,0
Tiller - TX120 GS120		BP4HS-10	5011	1,0
Tiller - TX300 GS150		BP4HS-10	5011	1,0
Tiller - TX400 GS160		BP4HS-10	5011	1,0
Tiller - TX500 GS200		B4H	4110	0,6
Tiller - TX600 GS230		B4H	4110	0,6
Tiller - TX700 GS280		B4H	4110	0,6
Tiller - TX900 GS330		B4H	4110	0,6
ZB 600 C-I	Kühlgerät	Y-149	6766	
<b>LITTLE WONDER</b>				
2216 DE	Heckenschere	BPM6A	7021	0,6 304
2224 DE	Heckenschere	BPM6A	7021	0,6 304
2230 DE	Heckenschere	BPM6A	7021	0,6 304
2230 SE	Heckenschere	BPM6A	7021	0,6 304
2242 SE	Heckenschere	BPM6A	7021	0,6 304
9005 P	Luftbesen	B2LM	1147	0,5
9008 P / IC	Luftbesen	B2LM	1147	0,5
9333	Luftbesen	BPM7A	7321	0,6 305
9444 E	Luftbesen	BPM7A	7321	0,6 305
<b>LZDP</b>				
P-10 DU		B5HS	4210	0,7
P-350		B5HS	4210	0,7
P-350-1		B5HS	4210	0,7
<b>MAG</b>				
1014 SRL	Mehrzweckmotor	B4H	4110	0,7
1017 SRL	Mehrzweckmotor	B4H	4110	0,5
1021 SRL	Mehrzweckmotor	B4H	4110	0,7
1023 SRL	Mehrzweckmotor	B4H	4110	0,5
1026 SRL	Mehrzweckmotor	B4H	4110	0,5
1029 SRL	Mehrzweckmotor	B4H	4110	0,5
1035 SRL	Mehrzweckmotor	B4H	4110	0,5

# Diverse Arbeitsgeräte / Various Tools



Order  
No.



Quick  
No.

## MAG

1040 SRL	Mehrzweckmotor	B4H	4110	0,5	
1045 SRL	Mehrzweckmotor	B4H	4110	0,5	
2055 SRL	Mehrzweckmotor	B7HS	5110	0,5	204
2076 SRL	Mehrzweckmotor	B4H	4110	0,5	

## MARUYAMA

BL 471	Luftbesen	BPM6Y	4562	0,6	
ED 260	Kantenschneider	BPM6Y	4562	0,6	
HT 201D	Heckenschere	BPM6Y	4562	0,6	
HT 260D	Heckenschere	BPM6Y	4562	0,6	
MBS 260	Heckenschere	BPM6Y	4562	0,6	
MC 260 / C / S / E / D	Multischneider	BPM6Y	4562	0,6	
MC 261	Multischneider	BPM6Y	4562	0,6	
MS 056E	Sprayer	BPM6Y	4562	0,6	

## MASSEY-FERGUSON

101 Jr. Gas		AB-6	2910	0,6	
102 Jr. Gas		AB-6	2910	0,6	
11 Pony Gas		AB-6	2910	0,6	
16 Pacer Gas		AB-6	2910	0,6	
203 Gas		AB-6	2910	0,6	
21 Colt Gas		AB-6	2910	0,6	
22 Gas		AB-6	2910	0,6	
22K Gas		AB-6	2910	0,6	
23 Gas		AB-6	2910	0,6	
23K Gas		AB-6	2910	0,6	
30 Gas		AB-6	2910	0,6	
30K Gas		AB-6	2910	0,6	
33 Gas		AB-6	2910	0,6	
333 LPG		AB-6	2910	0,5	
333 Gas		AB-6	2910	0,6	
44 Gas		AB-6	2910	0,6	
44 Special Gas		AB-6	2910	0,6	
44 Special LPG		AB-6	2910	0,5	
444 LPG		AB-6	2910	0,5	
444 Gas		AB-6	2910	0,6	
55 Gas		AB-6	2910	0,6	
555 LPG		AB-6	2910	0,5	
555 Gas		AB-6	2910	0,6	
97 LPG		AB-6	2910	0,5	
Baler		AB-6	2910	0,6	
F35 Gas		AB-6	2910	0,6	
F40 Gas		AB-6	2910	0,6	
Forage Harvester		AB-6	2910	0,6	
MF1100 Gas Waukesha F-320G		AB-6	2910	0,6	
MF1100 LPG Waukesha F320-G		AB-6	2910	0,5	
MF135 Gas Continental Z-134		AB-6	2910	0,6	
MF135 Gas Perkins AG3-152 3/4" Rch.		BP5ES	6511	0,6	
MF135 Gas Perkins AG3-152 3/8" Rch.		B6S	3510	0,6	
MF135 Deluxe & Vineyard Gas Continental Z-145		AB-6	2910	0,6	
MF150 Gas Perkins AG3-152 3/4" Rch.		BP5ES	6511	0,6	
MF150 Gas Perkins AG3-152 3/8" Rch.		B6S	3510	0,6	

# Diverse Arbeitsgeräte / Various Tools



Order  
No.



Quick  
No.

## MASSEY-FERGUSON

MF150 Gas Continental Z-145	AB-6	2910	0,6
MF165 Gas Perkins AG4-212	B6S	3510	0,6
MF165 Gas Continental G-176	AB-6	2910	0,6
MF165 LPG Continental GB-176	AB-6	2910	0,5
MF175 Gas Continental G-206	AB-6	2910	0,6
MF175 Gas Continental GB-206	AB-6	2910	0,6
MF175 Gas Perkins AG4-236	B6S	3510	0,6
MF180 Gas Continental G-206	AB-6	2910	0,6
MF180 Gas Perkins AG4-236	B6S	3510	0,6
MF180 Gas Continental GB-206	AB-6	2910	0,6
MF225 Gas Perkins AG4-212	B6S	3510	0,6
MF230 Gas Continental Z-145	AB-6	2910	0,6
MF235 Gas Continental Z-145	AB-6	2910	0,6
MF265 Gas Perkins AG4-236	B6S	3510	0,6
MF35 Gas	AB-6	2910	0,6
MF50 Gas	AB-6	2910	0,6
MF65 Gas	AB-6	2910	0,6
MF85 Gas	AB-6	2910	0,6
MF88 Gas	AB-6	2910	0,6
MF90 Gas	AB-6	2910	0,6
Other - 26	B6S	3510	0,6
Other - 27	B6S	3510	0,6
Other - 27L	B6S	3510	0,6
Other - 35	AB-6	2910	0,6
Other - 50 Clipper	AB-6	2910	0,6
Other - 60SP	B6S	3510	0,6
Other - 70	B6S	3510	0,6
Other - 72	B6S	3510	0,6
Other - 80	B6S	3510	0,6
Other - 82	B6S	3510	0,6
Other - 90	B6S	3510	0,6
Other - 92	B6S	3510	0,6
Other - 92 Super	B6S	3510	0,6
Other - MF3000 S.P.	B6ES	7310	0,6
Other - MF410 S.P. (1970-1974) Chevrolet 292 cu in.	UR5	2139	0,9
Other - MF410 S.P. (1975) Chevrolet 292 cu in.	YR5	5334	0,9
Other - MF410 S.P. (To 1969) Chevrolet 292 cu in.	B6ES	7310	0,9
Other - MF510 S.P. Chevrolet 327 cu in.	B6S	3510	0,9
Other - MF510 S.P. (1969-1970) Chevrolet 350 cu in.	BR6ES	4922	0,9
Other - MF510 S.P. (1971-1972) Chevrolet 350 cu in.	UR4	4762	0,9
Other - MF510 S.P. (1973-1975) Chevrolet 350 cu in.	YR5	5334	0,9
Other - P	B6S	3510	0,6
Other - S	B6S	3510	0,6
Other - S.P. Clipper	AB-6	2910	0,6
Other - S.P. Cornpicker	AB-6	2910	0,6
Swather	AB-6	2910	0,6
TE20 LPG	AB-6	2910	0,5
TEA20 LPG	AB-6	2910	0,6
TO20 LPG	AB-6	2910	0,6
TO30 LPG	AB-6	2910	0,6
TO35 LPG	AB-6	2910	0,6
Windrower	AB-6	2910	0,6



# Diverse Arbeitsgeräte / Various Tools



Order  
No.



Quick  
No.

## McCULLOCH

Tivoli 45	Heckenschere	BMR6F	2144	0,5	
Tivoli 60	Heckenschere	BMR6F	2144	0,5	
Virginia MH 542	Heckenschere	BMR6F	2144	0,5	
Virginia MH 548	Heckenschere	BMR6F	2144	0,5	
Virginia MH 555	Heckenschere	BMR6F	2144	0,5	

## MITSUBISHI

G 400	Mehrzweckmotor	BM6A	5921	0,7	303
GM 131	Mehrzweckmotor	BP5ES	6511	0,7	
GM 181	Mehrzweckmotor	BP5ES	6511	0,7	
GM 291	Mehrzweckmotor	BP5ES	6511	0,7	
GM 301	Mehrzweckmotor	BP5ES	6511	0,7	
GM 91	Mehrzweckmotor	BP5ES	6511	0,7	
K2A (S)/ 2B/ C		Y-114T	6528		
K3		Y-110	6825		
K3A /B /C /D /E / F / H /M		Y-114T	6528		
K4A		Y-110	6825		
KE130 / 135		Y-160	only OE		
KE140 / 150      06.76-		Y-201	1026		
KE250 / 270		Y-251	2026		
KE31		Y-802-2	only OE		
KE55 / 80/ 95/ 130    -05.76		Y-110	6825		
KE70 / 70L / 75 / 75L		Y-110	6825		
T 200	Mehrzweckmotor	BM6A	5921	0,6	303
T 240	Mehrzweckmotor	B4	3210	0,6	
TL 20	Mehrzweckmotor	BM6A	5921	0,6	303
TL 23	Mehrzweckmotor	BM6A	5921	0,6	303
TL 26	Mehrzweckmotor	BMR6A	7421	0,6	307
TL 33	Mehrzweckmotor	BMR6A	7421	0,6	307
TL 43	Mehrzweckmotor	BMR6A	7421	0,6	307
TL 52	Mehrzweckmotor	BMR6A	7421	0,6	307
TM 18	Mehrzweckmotor	BM6A	5921	0,6	303
TM 21	Mehrzweckmotor	BM6A	5921	0,6	303
TM 24	Mehrzweckmotor	BM6A	5921	0,6	303
TM 33	Mehrzweckmotor	BM6A	5921	0,6	303

## MK

MK-1A Krot		BP6HS	4511	0,6	
MK-50		BP6HS	4511	0,6	

## MMB

MMB-4		B5HS	4210	0,7	
-------	--	------	------	-----	--

## MTD

Cub Cadet	B&S Graugußmotoren	BR2LM	5798	0,7	310
Cub Cadet	B&S Intek Motoren	BKR5E	7938	0,7	
Cub Cadet	B&S Standard/IC-Motoren	BR2LM	5798	0,7	310
Cub Cadet	Tecumseh Standard/Seitengesteuerte Motoren	BR2LM	5798	0,7	310
Cub Cadet	Kohler Comand CV/CH 11--16	BKR5E-11	6953	1,1	
Cub Cadet	Kohler Comand CV/CH 18--25	BKR5E	7938	0,7	
Cub Cadet	Kawasaki Typ FG 230 D CS 50	BP4HS	3611	0,6	
Cub Cadet	Kawasaki Typ FE 250 D	BPR5ES	7422	0,6	

# Diverse Arbeitsgeräte / Various Tools



Order  
No.



Quick  
No.

## MTD

Cub Cadet	Tecumseh OHV Motore	BR7ES	5122	0,7	
Cub Cadet	B&S Vanguard/Europa OHV Motoren	BKR5E	7938	0,7	
Gutbrod	Kawasaki Typ FE 250 D	BPR5ES	7422	0,6	
Gutbrod	B&S Vanguard/Europa OHV Motoren	BKR5E	7938	0,7	
Gutbrod	B&S Graugußmotoren	BR2LM	5798	0,7	310
Gutbrod	B&S Standard/IC-Motoren	BR2LM	5798	0,7	310
Gutbrod	Tecumseh Standard/Seitengesteuerte Motoren	BR2LM	5798	0,7	310
Gutbrod	Tecumseh OHV Motoren	BR7ES	5122	0,7	
Gutbrod	Kohler Comand CV/CH 11--16	BKR5E-11	6953	1,1	
Gutbrod	Kawasaki Typ FG 230 D CS 50	BP4HS	3611	0,6	
Gutbrod	B&S Intek Motoren	BKR5E	7938	0,7	
Gutbrod	Kohler Comand CV/CH 18--25	BKR5E	7938	0,7	
White	B&S Graugußmotoren	BR2LM	5798	0,7	310
White	B&S Vanguard/Europa OHV Motoren	BKR5E	7938	0,7	
White	B&S Intek Motoren	BKR5E	7938	0,7	
White	Tecumseh Standard/Seitengesteuerte Motoren	BR2LM	5798	0,7	310
White	Tecumseh OHV Motoren	BR7ES	5122	0,7	
White	B&S Standard/IC-Motoren	BR2LM	5798	0,7	310
White	Kawasaki Typ FE 250 D	BPR5ES	7422	0,6	
White	Kohler Comand CV/CH 11--16	BKR5E-11	6953	1,1	
White	Kohler Comand CV/CH 18--25	BKR5E	7938	0,7	
White	Kawasaki Typ FG 230 D CS 50	BP4HS	3611	0,6	
Yard Machines	Kawasaki Typ FE 250 D	BPR5ES	7422	0,6	
Yard Machines	B&S Vanguard/Europa OHV Motoren	BKR5E	7938	0,7	
Yard Machines	B&S Graugußmotoren	BR2LM	5798	0,7	310
Yard Machines	Kawasaki Typ FG 230 D CS 50	BP4HS	3611	0,6	
Yard Machines	Kohler Comand CV/CH 18--25	BKR5E	7938	0,7	
Yard Machines	Kohler Comand CV/CH 11--16	BKR5E-11	6953	1,1	
Yard Machines	Tecumseh OHV Motoren	BR7ES	5122	0,7	
Yard Machines	Tecumseh Standard/Seitengesteuerte Motoren	BR2LM	5798	0,7	310
Yard Machines	B&S Intek Motoren	BKR5E	7938	0,7	
Yard Machines	B&S Standard/IC-Motoren	BR2LM	5798	0,7	310
Yard Man	Kawasaki Typ FE 250 D	BPR5ES	7422	0,6	
Yard Man	Tecumseh OHV Motoren	BR7ES	5122	0,7	
Yard Man	B&S Intek Motoren	BKR5E	7938	0,7	
Yard Man	Tecumseh Standard/Seitengesteuerte Motoren	BR2LM	5798	0,7	310
Yard Man	B&S Graugußmotoren	BR2LM	5798	0,7	310
Yard Man	B&S Standard/IC-Motoren	BR2LM	5798	0,7	310
Yard Man	Kohler Comand CV/CH 11--16	BKR5E-11	6953	1,1	
Yard Man	Kohler Comand CV/CH 18--25	BKR5E	7938	0,7	
Yard Man	B&S Vanguard/Europa OHV Motoren	BKR5E	7938	0,7	
Yard Man	Kawasaki Typ FG 230 D CS 50	BP4HS	3611	0,6	

## NEVA

MB-2K Neva		B5HS	4210	0,7	
------------	--	------	------	-----	--

## NISSAN

LD20 / LD28		Y-204TS1	3829		
SD16 / SD22 / SD33	12V	Y-112T	6327		
SD16 / SD22 / SD33	12V QGS	Y-705RS	1249		
SD22 / SD25 / SD33	24V	Y-755RS	7771		
SD33T	24V	Y-177-1	3026		

# Diverse Arbeitsgeräte / Various Tools



Order  
No.



Quick  
No.

## NISSAN

TD23 / TD27	12V	Y-707RS	4937		
-------------	-----	---------	------	--	--

## OLEO-MAC

440 BP	Mehrzweckmotor	BPMR7A	4626	0,5	309
720	Mehrzweckmotor	BPMR7A	4626	0,5	309
730 T / S	Mehrzweckmotor	BPMR7A	4626	0,5	309
735 T / S	Mehrzweckmotor	BPMR7A	4626	0,5	309
740 T / S	Mehrzweckmotor	BPMR7A	4626	0,5	309
746 T	Mehrzweckmotor	BPMR7A	4626	0,5	309
750 Master	Mehrzweckmotor	BPMR7A	4626	0,5	309
750 T	Mehrzweckmotor	BPMR7A	4626	0,5	309
825 T / S	Mehrzweckmotor	BPMR7A	4626	0,5	309
931	Mehrzweckmotor	BPMR6A	6726	0,5	308
936	Mehrzweckmotor	BPMR7A	4626	0,5	309
940	Mehrzweckmotor	BPMR7A	4626	0,5	309
940 S	Mehrzweckmotor	BPMR7A	4626	0,5	309
942	Mehrzweckmotor	BPMR7A	4626	0,5	309
946	Mehrzweckmotor	BPMR7A	4626	0,5	309
951	Mehrzweckmotor	BPMR7A	4626	0,5	309
956	Mehrzweckmotor	BPMR7A	4626	0,5	309
962	Mehrzweckmotor	BPMR7A	4626	0,5	309
970 / 971	Mehrzweckmotor	BPMR7A	4626	0,5	309
980 / 981	Mehrzweckmotor	BPMR7A	4626	0,5	309
AM 150	Mehrzweckmotor	BPM7A	7321	0,5	305
AM 180	Mehrzweckmotor	BPM7A	7321	0,5	305
HT 26	Mehrzweckmotor	BPMR7A	4626	0,5	309
HT 26 S	Mehrzweckmotor	BPMR7A	4626	0,5	309
HT 43	Mehrzweckmotor	BPMR7A	4626	0,5	309
MTL 106	Mehrzweckmotor	BPM7A	7321	0,5	305
MTL 30	Mehrzweckmotor	BPM7A	7321	0,5	305
MTL 40	Mehrzweckmotor	BPM7A	7321	0,5	305
MTL 50	Mehrzweckmotor	BPMR7A	4626	0,5	309
MTL 80	Mehrzweckmotor	BPM7A	7321	0,5	305
MTL 81 R	Mehrzweckmotor	BPMR7A	4626	0,5	309
Sparta 26 / 26 S	Mehrzweckmotor	BPMR7A	4626	0,5	309
Sparta 26TR	Mehrzweckmotor	BPMR7A	4626	0,5	309

## PARTNER

31	Motorhacke	BR2LM	5798	0,7	310
3-20	Schneefräse	BR6S	3522	0,7	
3-51	Schneefräse	BR6S	3522	0,7	
5110	Motorhacke	BR2LM	5798	0,7	310
5112	Motorhacke	BR2LM	5798	0,7	310
511 RT	Motorhacke	BR2LM	5798	0,7	310
5510	Motorhacke	BR2LM	5798	0,7	310
GBI 32	Luftbesen	BPMR6A	6726	0,5	308
HG 55-12	Heckenschere	BPMR6A	6726	0,5	308

## PHÖNIX

PM 21H		BPMR6A	6726	0,7	308
Primo 35	B&S	BR2LM	5798	0,7	310
Primo 500 R	B&S	BR2LM	5798	0,7	310

# Diverse Arbeitsgeräte / Various Tools



Order No.  Quick No.

<b>PHÖNIX</b>						
Quatro 500 B	B&S	Motorhacke	BR2LM	5798	0,7	310
<b>ROBIN</b>						
BH 2500		Mehrzweckmotor	CM6	5812	0,5	
EC 02 EHR		Mehrzweckmotor	BM7A	6521	0,7	
EC 08 D/B		Mehrzweckmotor	B7HS	5110	0,7	204
EC 10 D/B		Mehrzweckmotor	B4	3210	0,7	
EC 12 D/B		Mehrzweckmotor	BM6A	5921	0,7	303
EH 12 D/B		Mehrzweckmotor	B6HS	4510	0,7	203
EH 17 D/B		Mehrzweckmotor	B6HS	4510	0,7	203
EH 25 D/B		Mehrzweckmotor	B6HS	4510	0,7	203
EH 30 D/B		Mehrzweckmotor	BP6ES	7811	0,7	
EH 34 D/B		Mehrzweckmotor	BP6ES	7811	0,7	
EY 08 D/B		Mehrzweckmotor	BM4A	5628	0,7	
EY 15 D/B		Mehrzweckmotor	B6HS	4510	0,7	203
EY 20 D/B		Mehrzweckmotor	B6HS	4510	0,7	203
EY 23 D/B		Mehrzweckmotor	BP4HS	3611	0,7	
EY 28 D/B		Mehrzweckmotor	BP6HS	4511	0,7	
EY 35 D/B		Mehrzweckmotor	B6HS	4510	0,7	203
EY 40 D/B		Mehrzweckmotor	B6HS	4510	0,7	203
NB 2001		Mehrzweckmotor	BPM7A	7321	0,5	305
NB 211		Mehrzweckmotor	BPM7A	7321	0,5	305
NB 221		Mehrzweckmotor	BM7A	6521	0,5	
NB 223		Mehrzweckmotor	BPM7A	7321	0,5	305
NB 251		Mehrzweckmotor	BM7A	6521	0,5	
NB 253		Mehrzweckmotor	BPM7A	7321	0,5	305
NB 26		Mehrzweckmotor	BM7A	6521	0,5	
NB 31		Mehrzweckmotor	BM7A	6521	0,5	
NB 321		Mehrzweckmotor	BPM7A	7321	0,5	305
NB 40		Mehrzweckmotor	B7HS	5110	0,5	204
NB 411		Mehrzweckmotor	BPM7A	7321	0,5	305
NBF 171		Mehrzweckmotor	BPM7A	7321	0,5	305
NBF 252		Mehrzweckmotor	BPM7A	7321	0,5	305
NBT 415		Mehrzweckmotor	BPM7A	7321	0,5	305
<b>SABO</b>						
SB 135 L		Mehrzweckmotor	BP4	2911	0,5	
SB 140 SL		Mehrzweckmotor	BP4	2911	0,5	
SB 152		Mehrzweckmotor	B5HS	4210	0,5	
<b>SALUT</b>						
Salut-5			B5HS	4210	0,7	
<b>SD</b>						
SD1012			BP7HS	5111	0,6	
<b>SOLO</b>						
101		Mehrzweckmotor	BPMR6A	6726	0,5	308
118 / 119		Mehrzweckmotor	BPMR6A	6726	0,5	308
120		Mehrzweckmotor	BPMR6A	6726	0,5	308
124		Mehrzweckmotor	BPMR6A	6726	0,5	308
126		Mehrzweckmotor	BPMR6A	6726	0,5	308

# Diverse Arbeitsgeräte / Various Tools



Order  
No.



Quick  
No.

## SOLO

127	Mehrzweckmotor	BPMR6A	6726	0,5	308
127 H	Mehrzweckmotor	C5HSB	6452	0,5	
128	Mehrzweckmotor	BPMR6A	6726	0,5	308
130	Mehrzweckmotor	BPMR6A	6726	0,5	308
130 H	Mehrzweckmotor	C5HSB	6452	0,5	
132	Mehrzweckmotor	BPMR6A	6726	0,5	308
134	Mehrzweckmotor	BPMR6A	6726	0,5	308
140	Mehrzweckmotor	BPMR6A	6726	0,5	308
141	Mehrzweckmotor	BPMR6A	6726	0,5	308
410	Sprayer	B6HS	4510	0,5	203
412	Sprayer	B6HS	4510	0,5	203
414	Luftbesen	BPMR7A	4626	0,5	309
414	Mehrzweckmotor	BPMR6A	6726	0,5	308
422	Sprayer	BPMR6A	6726	0,5	308
422	Mehrzweckmotor	BPMR6A	6726	0,5	308
423	Sprayer	B6HS	4510	0,5	203
436	Sprayer	B7HS	5110	0,5	204
437	Sprayer	B7HS	5110	0,5	204
439	Sprayer	B7HS	5110	0,5	204
441	Laubbläser	BPMR6A	6726	0,6	308
440	Laubbläser	BPMR6A	6726	0,6	308
444	Sprayer	BPMR7A	4626	0,5	309
445	Laubbläser	BPMR7A	4626	0,5	309
450	Sprayer	BPMR7A	4626	0,5	309
459	Sprayer	B7HS	5110	0,5	204
471	Laubbläser	BPMR7A	4626	0,5	309
472	Laubbläser	BPMR7A	4626	0,5	309
501-2T (Solo)	Motorhacke	BPMR6A	6726	0,6	308
501-4T (Honda)	Motorhacke	CR5HSB	6535	0,5	
502	Motorhacke	CR5HSB	6535	0,5	
503	Motorhacke	BR2LM	5798	0,5	310
504	Motorhacke	BPR6ES	7822	0,7	
508	Motorhacke	BPR6ES	7822	0,7	
603	Mehrzweckmotor	BPMR6A	6726	0,5	308
633	Mehrzweckmotor	BPMR6A	6726	0,5	308
634	Mehrzweckmotor	BPMR6A	6726	0,5	308
636	Mehrzweckmotor	BPMR6A	6726	0,5	308
639 D	Mehrzweckmotor	BPMR6A	6726	0,5	308
641	Mehrzweckmotor	BPMR6A	6726	0,5	308
644	Mehrzweckmotor	BPMR6A	6726	0,5	308
644 SP	Mehrzweckmotor	BPMR6A	6726	0,5	308
645 D	Mehrzweckmotor	BPMR6A	6726	0,5	308
647	Mehrzweckmotor	BPMR6A	6726	0,5	308
651	Mehrzweckmotor	BPMR6A	6726	0,5	308
651 SP	Mehrzweckmotor	BPMR6A	6726	0,5	308
654	Mehrzweckmotor	BPMR6A	6726	0,5	308
662	Mehrzweckmotor	BPMR6A	6726	0,5	308
667	Mehrzweckmotor	BPMR6A	6726	0,5	308
670	Mehrzweckmotor	BPMR6A	6726	0,5	308
680	Mehrzweckmotor	BPMR6A	6726	0,5	308
690	Mehrzweckmotor	BPMR6A	6726	0,5	308

# Diverse Arbeitsgeräte / Various Tools



Order  
No.



Quick  
No.

## SPERRY-NEW HOLLAND

Bale Wagon	Ford 460 cu in.	UR5	2139	0,9	
Bale Wagon	Ford 361 cu in.	AR6FS	3323	0,9	
Baler	Wisconsin VR4D	AB-6	2910	0,7	
Baler	Ford 240 cu in.	WR5	1071	0,6	
Baler	Wisconsin TJD	AB-6	2910	0,7	
Baler	Wisconsin VG4D	AB-6	2910	0,7	
Baler	Wisconsin V46D	BP5ES	6511	0,7	
Baler	Wisconsin THD	AB-6	2910	0,7	
Baler	Wisconsin VH4D	AB-6	2910	0,7	
Baler	Ford 300 cu in.	WR5	1071	0,6	
Baler	Wisconsin V461D	BP5ES	6511	0,7	
Baler	Ford 134 cu in.	B4L	3112	0,9	
Baler	Ford 172 cu in.	B4L	3112	0,9	
Baler	Wisconsin V465D	BP5ES	6511	0,7	
Combine	Ford 240 cu in.	WR5	1071	0,7	
Combine	Ford 300 cu in.	WR5	1071	0,7	
Combine	Ford 361 cu in.	AR6FS	3323	0,9	
Combine	Ford 392 cu in.	AR6FS	3323	0,9	
Harvester	Ford 392 cu in.	AR6FS	3323	0,9	
Haybine	Wisconsin VG4D	AB-6	2910	0,7	
Haybine	Ford 200 cu in.	WR5	1071	0,9	
Haybine	Ford 134 cu in.	B4L	3112	0,6	
Loader 23 hp.	Kohler K582	B4L	3112	0,6	
Loader	Wisconsin VG4D	AB-6	2910	0,7	
Loader	Wisconsin V465D	BP5ES	6511	0,7	
Loader	Wisconsin VH4D	AB-6	2910	0,7	
Loader		B6L	3212	0,9	
Loader	Wisconsin TJD	AB-6	2910	0,7	
Speedrower	Ford 173 cu in.	B4L	3112	0,6	
Speedrower	Ford 200 cu in.	WR5	1071	0,9	
Speedrower	Ford 250 cu in.	WR5	1071	0,9	
Speedrower	Ford 256 cu in.	B5ES	6410	0,6	
Tractor	Kubota 1920	Y-106V	6926	---	
Trencher 16 hp.	Kohler K341	B6L	3212	0,6	
Trencher	Wisconsin TJD	AB-6	2910	0,7	
Trencher	Wisconsin VG4D	AB-6	2910	0,7	

## STIHL

BG 45	Laubbläser	BPMR7A	4626	0,5	309
BG 55	Laubbläser	BPMR7A	4626	0,5	309
BG 72	Luftbesen	BPMR7A	4626	0,5	309
BG 75	Luftbesen	BPMR7A	4626	0,5	309
BG 85	Laubbläser	BPMR7A	4626	0,5	309
BR 320L	Laubbläser	BPMR7A	4626	0,5	309
BR 380	Laubbläser	BPMR7A	4626	0,5	309
BR 400	Laubbläser	BPMR7A	4626	0,5	309
BR 45 C	Laubbläser	BPMR7A	4626	0,5	309
BR 500	Laubbläser	CMR6H	3365	0,5	
BR 550	Laubbläser	CMR6H	3365	0,5	
BR 600	Laubbläser	CMR6H	3365	0,5	
BR 106 , BR-320 , BR-400	Luftbesen	BPMR7A	4626	0,5	309
BT 106 C	Erdborher	BPMR7A	4626	0,5	309

# Diverse Arbeitsgeräte / Various Tools



Order  
No.



Quick  
No.

## STIHL

BT 121	Erdbohrer	BPMR7A	4626	0,5	309
BT 360	Erdbohrer	BPMR7A	4626	0,5	309
BT 45	Handbohrgerät	BPMR7A	4626	0,5	309
HT 101	Hochentaster	CMR6H	3365	0,5	
HL 100	Heckenschneider	CMR6H	3365	0,5	
HL 100 K	Heckenschneider	CMR6H	3365	0,5	
HL 45	Heckenschere	BPMR7A	4626	0,5	309
HL 75	Heckenschere	BPMR7A	4626	0,5	309
HLR 85	Heckenschere	BPMR7A	4626	0,5	309
HS 246	Heckenschere	BPMR7A	4626	0,5	309
HS 45	Heckenschere	BPMR7A	4626	0,5	309
HS 75	Heckenschere	BPMR7A	4626	0,5	309
HS 80	Heckenschere	BPMR7A	4626	0,5	309
HS 81R / T	Heckenschere	CMR6H	3365	0,5	
HS 85	Heckenschere	BPMR7A	4626	0,5	309
HS 86R / T	Heckenschere	CMR6H	3365	0,5	
HT 70	Heckenschere	BPMR7A	4626	0,5	309
HT 75	Hochentaster	BPMR7A	4626	0,5	309
HTR 85	Heckenschere	BPMR7A	4626	0,5	309
KM 90	Kombisystem	CMR6H	3365	0,5	
KM 90 R	Kombisystem	CMR6H	3365	0,5	
KM 130	Kombisystem	CMR6H	3365	0,5	
KM 130 R	Kombisystem	CMR6H	3365	0,5	
MM 55	MultiWerkzeug	BPMR7A	4626	0,5	309
SH 55	Saughäcksler	BPMR7A	4626	0,5	309
SH 85	Saughäcksler	BPMR7A	4626	0,5	309
SR 340	Sprayer	BPMR7A	4626	0,5	309
SR 320 , SR400	Luftbesen	BPMR7A	4626	0,5	309
SR420	Sprayer	BPMR7A	4626	0,5	309
TS 360 S	Trennschleifer	BPMR7A	4626	0,5	309
TS 400	Trennschleifer	BPMR7A	4626	0,5	309
TS 460	Trennschleifer	BPMR7A	4626	0,5	309
TS 510	Trennschleifer	BPMR7A	4626	0,5	309
TS 700	Trennschleifer	BPMR7A	4626	0,5	309
TS 760	Trennschleifer	BPMR7A	4626	0,5	309

## TANAKA

AST 250	Mehrzweckmotor	BPM6A	7021	0,6	304
AST 7000	Mehrzweckmotor	BPM6A	7021	0,6	304
ECS 320 / 330	Mehrzweckmotor	BM6A	5921	0,6	303
ECS 3301	Mehrzweckmotor	BM6A	5921	0,6	303
ECS 3351	Mehrzweckmotor	BM6A	5921	0,6	303
ECU 3801	Mehrzweckmotor	BPM7A	7321	0,6	305
ECV 4501	Mehrzweckmotor	BM6A	5921	0,6	303
EHC 120	Mehrzweckmotor	BM7A	6521	0,6	
PM 21	Mehrzweckmotor	BPM6A	7021	0,6	304
PM 21	Heckenschere	BPMR6A	6726	0,5	308
PM 2100	Mehrzweckmotor	BPM6A	7021	0,6	304
TBC 2000	Mehrzweckmotor	BPM6A	7021	0,6	304
TBC 2200	Mehrzweckmotor	BPM6A	7021	0,6	304
TBC 2211	Mehrzweckmotor	BPMR6A	6726	0,6	308
TBC 2251	Mehrzweckmotor	BPMR6A	6726	0,6	308

# Diverse Arbeitsgeräte / Various Tools



Order No.  Quick No.

<b>TANAKA</b>					
TBC 2400	Mehrzweckmotor	BPM6A	7021	0,6	304
TBC 250	Mehrzweckmotor	BPM6A	7021	0,6	304
TBC 265	Mehrzweckmotor	BPM6A	7021	0,6	304
TBC 270 PF	Mehrzweckmotor	BMR7A	4226	0,6	
TBC 300	Mehrzweckmotor	BM6A	5921	0,6	303
TBC 355	Mehrzweckmotor	BM7A	6521	0,6	
TBC 4200	Mehrzweckmotor	BPM6A	7021	0,6	304
TBC 422	Mehrzweckmotor	BM7A	6521	0,6	
TBC 430 PF	Mehrzweckmotor	BPMR7A	4626	0,6	309
TBC 4500	Mehrzweckmotor	BPM6A	7021	0,6	304
TBC 500	Mehrzweckmotor	BPM6A	7021	0,6	304
TBH 2500	Mehrzweckmotor	BM7A	6521	0,6	
TBL 505	Mehrzweckmotor	BM6A	5921	0,6	303
TCP 25	Mehrzweckmotor	BPM6A	7021	0,6	304
TCP 381	Mehrzweckmotor	B6S	3510	0,6	302
TEA 500	Mehrzweckmotor	BM6A	5921	0,6	303
TEA 500	Erdbohrer	BM6A	5921	0,6	303
TED 262	Mehrzweckmotor	BM6A	5921	0,6	303
THB 2510	Mehrzweckmotor	BPMR6A	6726	0,6	308
THT 1800	Mehrzweckmotor	BPMR6A	6726	0,6	308
THT 210	Mehrzweckmotor	BM6A	5921	0,6	303
THT 210	Heckenschere	BPM6A	7021	0,6	304
THT 230	Mehrzweckmotor	BM6A	5921	0,6	303
THT 240	Mehrzweckmotor	BPM6A	7021	0,6	304
THT 240	Heckenschere	BPM6A	7021	0,6	304
THT 2510	Mehrzweckmotor	BPMR6A	6726	0,6	308
THT 2520	Mehrzweckmotor	BPMR6A	6726	0,6	308
THT 2530	Mehrzweckmotor	BPMR6A	6726	0,6	308
THT 262	Mehrzweckmotor	BM6A	5921	0,6	303
THT 262	Heckenschere	BM6A	5921	0,6	303
TIA 305	Mehrzweckmotor	BM7A	6521	0,6	
TIA 340	Mehrzweckmotor	BM7A	6521	0,6	
TIA 340	Erdbohrer	BMR6A	7421	0,6	307
TLE 550	Mehrzweckmotor	BM7A	6521	0,6	
TPH 2211	Mehrzweckmotor	BPMR6A	6726	0,6	308
TUM 250	Mehrzweckmotor	BPM6A	7021	0,6	304
<b>TARPAN</b>					
Tarpan		BP6HS	4511	0,6	
<b>TECNAMOTOR</b>					
BH 153		BR4LM	4133	0,6	
BH 173		BR4LM	4133	0,6	
BV 153		BR2LM	5798	0,6	310
BVL 153		BR2LM	5798	0,6	310
BVL 173		BR4LM	4133	0,6	
BVL 198		BR4LM	4133	0,6	
BVS 143		BR2LM	5798	0,6	310
BVS 153		BR2LM	5798	0,6	310
MV 100		BR4LM	4133	0,6	
MV 100 S		BR4LM	4133	0,6	
Premier 45 OHV		BR4LM	4133	0,6	



# Diverse Arbeitsgeräte / Various Tools



Order  
No.



Quick  
No.

## TECNAMOTOR

Premier 55 OHV	BR7ES	5122	0,6	
Premier 153	BR4LM	4133	0,6	
Premier 173	BR4LM	4133	0,6	
RV 173	BR4LM	4133	0,6	
Synergy 40	BR4LM	4133	0,6	
Synergy 55 OHV	BR7ES	5122	0,6	
Vantage 35	BR4LM	4133	0,6	
Vantage 40	BR4LM	4133	0,6	

## TECUMSEH

A 220 4,8PS 95-	BR2LM	5798	0,6	310
ALN 330 7,2PS 95-	BR2LM	5798	0,6	310
BH 35 3,5PS 95-	BR2LM	5798	0,6	310
BH 40 4PS Konische Ausführung 95-	BR2LM	5798	0,6	310
BH 40 4PS Zylindrische Ausfüh. 95-	BR2LM	5798	0,6	310
Centura 40	BR2LM	5798	0,5	310
Centura 40 S	BR2LM	5798	0,5	310
Centura 40 V	BR2LM	5798	0,5	310
Centura 45 S	BR2LM	5798	0,5	310
Centura 50	BR2LM	5798	0,5	310
Centura 50 DX	BR2LM	5798	0,5	310
Centura 50 LX	BR2LM	5798	0,5	310
Centura 50 V	BR2LM	5798	0,5	310
Centura 55 DX	BR2LM	5798	0,5	310
Centura 55 LX	BR2LM	5798	0,5	310
Centura 55 OHV 4Takt	BR7ES	5122	0,8	
Centura 55 V	BR2LM	5798	0,5	310
Centura 60 LX	BR2LM	5798	0,5	310
Centura 60 OHV 4Takt	BR7ES	5122	0,8	
Centura 60 V	BR2LM	5798	0,5	310
Centura 65 OHV 4Takt	BR7ES	5122	0,8	
CH 133	BR2LM	5798	0,5	310
Enduro 11-13,5 OHV 4Takt	BR7ES	5122	0,8	
Enduro 11-13 HP	BR7ES	5122	0,8	
Enduro 15-18 OHV 4Takt	BR7ES	5122	0,8	
Enduro 9-11 EC OHV 4Takt	BR7ES	5122	0,8	
Enduro OV691EA 18-22 OHV 4Takt	BR7ES	5122	0,8	
Enduro OV691EP 18-22 OHV 4Takt	BR7ES	5122	0,8	
Enduro XL OV 195 OHV 4Takt	BR7ES	5122	0,8	
Enduro XL OV691EP 23-25 OHV 4Takt	BR7ES	5122	0,8	
Formula 10-13 OHV 4Takt	BR7ES	5122	0,8	
Formula 14-17,5 OHV 4Takt	BR7ES	5122	0,8	
Formula 8-10	BR2LM	5798	0,5	310
Formula 9-11 OHV 4Takt	BR7ES	5122	0,8	
Formula OV 195 OHV 4Takt	BR7ES	5122	0,8	
Formula OV 691EA 18-20 OHV 4Takt	BR7ES	5122	0,8	
Formula OV 691EP 18-20 OHV 4Takt	BR7ES	5122	0,8	
Geotec 35	BR2LM	5798	0,5	310
Geotec 35	BR2LM	5798	0,5	310
Geotec 37	BR2LM	5798	0,5	310
Geotec 40	BR2LM	5798	0,5	310
Geotec 45 OHV 4Takt	BR7ES	5122	0,8	

# Diverse Arbeitsgeräte / Various Tools



Order  
No.



Quick  
No.

## TECUMSEH

Geotec 50	BR2LM	5798	0,5	310
Geotec 50 OHV 4Takt	BR7ES	5122	0,8	
Geotec 55 OHV 4Takt	BR7ES	5122	0,8	
Geotec 60 OHV 4Takt	BR7ES	5122	0,8	
Geotec 65 OHV 4Takt	BR7ES	5122	0,8	
H 35	BR4LM	4133	0,6	
H 50	BR4LM	4133	0,6	
H 60	BR4LM	4133	0,6	
H 70	BR4LM	4133	0,6	
H 80	BR4LM	4133	0,6	
HH 100	B6HS	4510	0,6	203
HM 70	BR4LM	4133	0,6	
HM 80	BR4LM	4133	0,6	
HM 100	BR4LM	4133	0,6	
HM 100 10PS 95-	BR2LM	5798	0,6	310
HMXL 80 8PS 95-	BR2LM	5798	0,6	310
HS 40	BR4LM	4133	0,6	
HS 50	BR4LM	4133	0,6	
HS 50 5PS Hand+Fernbedienung 95-	BR2LM	5798	0,6	310
LAV 35	BR4LM	4133	0,6	
LAV 40	BR4LM	4133	0,6	
LAV 50	BR4LM	4133	0,6	
MV 100 S 3,5PS 95-	BR2LM	5798	0,6	310
OH 120	B6HS	4510	0,6	203
OH 140	B6HS	4510	0,6	203
OH 160	B6HS	4510	0,6	203
OH 180	B6HS	4510	0,6	203
OHV 4Takt 12,5PS 95-	B7S	3710	0,6	
OVM	B6HS	4510	0,6	203
OVRM 40	BR7ES	5122	0,6	
OVRM 50	BR7ES	5122	0,6	
OVXL 120	B6HS	4510	0,6	203
OVXL-C 125	B6HS	4510	0,6	203
Prisma	BR4LM	4133	0,6	
Prisma 3,7PS 95-	BR2LM	5798	0,6	310
Prisma 37	BR2LM	5798	0,6	310
Prisma 40	BR2LM	5798	0,6	310
Prisma 45	BR2LM	5798	0,6	310
Prisma 5PS 95-	BR2LM	5798	0,6	310
Prisma Elektrostart	BR4LM	4133	0,6	
Synergy 40	BR2LM	5798	0,6	310
Synergy 40 4PS 95-	BR2LM	5798	0,6	310
Synergy OHV	BR7ES	5122	0,6	
TNT 100	BR4LM	4133	0,6	
TNT 120	BR4LM	4133	0,6	
TVM 140	BR4LM	4133	0,6	
TVM 170	BR4LM	4133	0,6	
TVM 195	BR4LM	4133	0,6	
TVM 220	BR4LM	4133	0,6	
TVS 75	BR4LM	4133	0,6	
TVS 90	BR4LM	4133	0,6	
TVS 105	BR4LM	4133	0,6	

# Diverse Arbeitsgeräte / Various Tools



Order  
No.



Quick  
No.

## TECUMSEH

TVS 115		BR4LM	4133	0,6	
TVS 120		BR4LM	4133	0,6	
TVXL		BR4LM	4133	0,6	
TVXL 195 4Takt 8PS 95-		BR2LM	5798	0,6	310
TVXL 840 5PS 95-		BR2LM	5798	0,6	310
V 50		BR4LM	4133	0,6	
V 60		BR4LM	4133	0,6	
V 70		BR4LM	4133	0,6	
V 80		BR4LM	4133	0,6	
Vantage		BR4LM	4133	0,6	
Vantage 3,5PS 95-		BR2LM	5798	0,6	310
Vantage 35 Eco-Tec		BR2LM	5798	0,6	310
Vantage 37 Eco-Tec		BR2LM	5798	0,6	310
VM 70		BR4LM	4133	0,6	
VM 80		BR4LM	4133	0,6	
VM 100		BR4LM	4133	0,6	

## TOURNO

95 (GCV 520 Honda)		BPR5ES	7422	0,5	
115 (GCV 520 Honda)		BPR5ES	7422	0,5	

## URAL

Ural-3		B5HS	4210	0,7	
--------	--	------	------	-----	--

## VIKING

VH 300	Motorhacke	BR2LM	5798	0,6	310
VH 340	Motorhacke	BR2LM	5798	0,6	310
VH 450	Motorhacke	BR2LM	5798	0,6	310
VM 550 B	Motorhacke	BR2LM	5798	0,6	310

## YAMAHA

HT 22	Heckenschere	BPM6A	7021	0,6	304
MF 150A / S	Mehrzweckmotor	BP6HS	4511	0,6	
MF 180A / AR / S / SR	Mehrzweckmotor	BP6HS	4511	0,6	
MF 180K / AK / SK	Mehrzweckmotor	BP4HS	3611	0,6	
MF 260A / AR / S / SR	Mehrzweckmotor	BP6HS	4511	0,6	
MF 260K / AK / SK	Mehrzweckmotor	BP4HS	3611	0,6	
MF 410 / S / SR	Mehrzweckmotor	BP6HS	4511	0,6	
MF 410SK	Mehrzweckmotor	BP4HS	3611	0,6	
Midori YRT 335	Motorhacke	BR4ES	1097	0,7	
Midori YRT 550	Motorhacke	BPR5ES	7422	0,7	
MT 110A / AR	Mehrzweckmotor	B7HS	5110	0,6	204
MT 110VL	Mehrzweckmotor	B7HS	5110	0,6	204
YP 10 GN	Wasserpumpe	BR7HS	4122	0,6	
YP 20 GN	Wasserpumpe	BP4HS	3611	0,9	
YP 30 GN	Wasserpumpe	BP5ES	6511	0,7	
YRT 335	Motorhacke	BR4ES	1097	0,7	
YS 624	Schneefräse	BPR4HS	7823	0,8	
YS 828	Schneefräse	BPR4HS	7823	0,8	
YSDX	Schneefräse	BPR4ES	7222	0,8	





ccm

Order  
No.Platin/  
Gold-  
PalladiumOrder  
No.

Iridium

Order  
No.**AKTIV**

A600 Spi. AB50A3		B9ES	2611	0.5	BR9EVX	1265	BR9EIX	3981
Grizzly Spi. AB50A3		B9ES	2611	0.5	BR9EVX	1265	BR9EIX	3981
SC3 Gul Hus.SM 160	160	BPM7A	7321	0,5				
Karibo Rot.277	277	B8ES	2411	0.8	BR8EVX	1262	BR8EIX	5044
A600 SA290	290	A7	1110	0,5				
Grizzly Fuj.432	432	B9ES	2611	0.5	BR9EVX	1265	BR9EIX	3981
Panther Fuj.432	432	B9ES	2611	0.5	BR9EVX	1265	BR9EIX	3981
A600 Rotax 440	440	A8	1210	0,5				
Grizzly Spi. AG440A2	440	B9ES	2611	0.5	BR9EVX	1265	BR9EIX	3981
Alaska	503	B8ES	2411	0.8	BR8EVX	1262	BR8EIX	5044
Alaska XT	503	B8ES	2411	0.8	BR8EVX	1262	BR8EIX	5044
Grizzly Rot. 503	503	B7ES	1111	0.5	B7EVX	6934		
Grizzly SE Rot. 503us	503	B8ES	2411	0.8	BR8EVX	1262	BR8EIX	5044
Grizzly XP Rot. 503Sca.	503	B8ES	2411	0.8	BR8EVX	1262	BR8EIX	5044
Panther Rot. 503	503	B7ES	1111	0.5	B7EVX	6934		
Panther Rot. 503Sca.	503	B8ES	2411	0.8	BR8EVX	1262	BR8EIX	5044

**ARCTCO/ARCTIC CAT (Kawasaki Engine)**

T5B060S(60cc)	60	BR6HS	3922	0.7			BR6HIX	3419
T1D250F1(245cc)	245	BR8ES	5422	0.7	BR8EVX	1262	BR8EIX	5044
KT150A, KT150B(292cc)	292	A8	1210	0.7				
T4B292S(292cc)	292	B9HS	5810	0.7	B9HVX	2254		
T4C292S1A(292cc)	292	BR9HS	4522	0.7				
T1A340S1(339cc)	339	B8ES	2411	0.7	B8EVX	7051	BR8EIX	5044
T1B340S(339cc)	339	B8ES	2411	0.7	B8EVX	7051	BR8EIX	5044
T1C340S1A(339cc)	339	B8ES	2411	0.7	B8EVX	7051	BR8EIX	5044
T1C340S2A(339cc)	339	B8ES	2411	0.7	B8EVX	7051	BR8EIX	5044
T1D340A2A(339cc)	339	B8ES	2411	0.7	B8EVX	7051	BR8EIX	5044
T1D340F1(339cc)	339	BR8ES	5422	0.7	BR8EVX	1262	BR8EIX	5044
T1A400S1(398cc)	398	B8ES	2411	0.7	B8EVX	7051	BR8EIX	5044
T1B400S(398cc)	398	B8ES	2411	0.7	B8EVX	7051	BR8EIX	5044
T1A440S1(436cc)	436	B8ES	2411	0.7	B8EVX	7051	BR8EIX	5044
T1B440D1A(436cc)	436	BUE	2322	-				
T1B440S(436cc)	436	B8ES	2411	0.7	B8EVX	7051	BR8EIX	5044
T1C440S1A(436cc)	436	B8ES	2411	0.7	B8EVX	7051	BR8EIX	5044
T1C440S2A(436cc)	436	B8ES	2411	0.7	B8EVX	7051	BR8EIX	5044
T1D440A2A(436cc)	436	B8ES	2411	0.7	B8EVX	7051	BR8EIX	5044

**ARCTCO/ARCTIC CAT (Racing Engine)**

AA25L2(250cc)	250	---		0.5	B10EVX	7335	BR10EIX	6801
340 Mod.Kit(340cc)	340	B10EG	3630	0.5	B10EGV	5927	BR10EIX	6801
AC34L2(340cc)	340	B10EG	3630	0.5	B10EGV	5927	BR10EIX	6801
AD34L1(340cc)	340	B10EG	3630	0.5	B10EGV	5927	BR10EIX	6801
Sno Pro 340 55HP(340cc)	340	B10EG	3630	0.5	B10EGV	5927	BR10EIX	6801
AE44L2(440cc)	440	B10EG	3630	0.5	B10EGV	5927	BR10EIX	6801
Sno Pro 440 70HP(440cc)	440	B10EG	3630	0.5	B10EGV	5927	BR10EIX	6801

**ARCTCO/ARCTIC CAT (Spirit(Suzuki)Engine)**

AA06A1(60cc)	60	BR6HS	3922	0.6			BR6HIX	3419
AA06A2(60cc)	60	BR6HS	3922	0.5			BR6HIX	3419
AA06A3(60cc)	60	BR6HS	3922	0.5			BR6HIX	3419
AA06A4(60cc)	60	BR6HS	3922	0.5			BR6HIX	3419



ccm

Order  
No.Platin/  
Gold-  
PalladiumOrder  
No.

Iridium

Order  
No.**ARCTCO/ARCTIC CAT (Spirit(Suzuki)Engine)**

AA06A5(60cc)	60	BR6HS	3922	0.5			BR6HIX	3419
AA06A7(60cc)	60	BR6HS	3922	0.5			BR6HIX	3419
AA06A9(60cc)	60	BR6HS	3922	0.6			BR6HIX	3419
A006A1(60cc)	60	BR6HS	3922	0.7			BR6HIX	3419
A006A2(60cc)	60	BR6HS	3922	0.8			BR6HIX	3419
A006A3(60cc)	60	BR6HS	3922	0.8			BR6HIX	3419
A006A4(60cc)	60	BR6HS	3922	0.8			BR6HIX	3419
A006A5(60cc)	60	BR6HS	3922	0.8			BR6HIX	3419
A006A8(60cc)	60	BR6HS	3922	0.8			BR6HIX	3419
AB25F1(250cc)	250	BR8ES	5422	0.6	BR8EVX	1262	BR8EIX	5044
AB25F3(250cc)	250	BR9ES	5722	0.5	BR9EVX	1265	BR9EIX	3981
AB25F4(250cc)	250	BR8ES	5422	0.5	BR8EVX	1262	BR8EIX	5044
AA28F1(275cc)	275	BR8ES	5422	0.6	BR8EVX	1262	BR8EIX	5044
AA28F2(275cc)	275	BR8ES	5422	0.6	BR8EVX	1262	BR8EIX	5044
AA28F3(275cc)	275	BR8ES	5422	0.5	BR8EVX	1262	BR8EIX	5044
AA28F4(275cc)	275	BR8ES	5422	0.5	BR8EVX	1262	BR8EIX	5044
AA28F5(275cc)	275	BR8ES	5422	0.5	BR8EVX	1262	BR8EIX	5044
AF34A7(339cc)	339	BR8ES	5422	0.7	BR8EVX	1262	BR8EIX	5044
AF34A8(339cc)	339	BR8ES	5422	0.8	BR8EVX	1262	BR8EIX	5044
AF34A9(339cc)	339	BR8ES	5422	0.8	BR8EVX	1262	BR8EIX	5044
AG34A1(339cc)	339	BR8ES	5422	0.5	BR8EVX	1262	BR8EIX	5044
AG34A3(339cc)	339	BR9ES	5722	0.8	BR9EVX	1265	BR9EIX	3981
AG34A3(339cc)	339	BR8HS	4322	0.6	BR8HVX	6265	BR8HIX	7001
AG34A3A(339cc)	339	BR9ES	5722	0.8	BR9EVX	1265	BR9EIX	3981
AG34A5(339cc)	339	BR9ES	5722	0.8	BR9EVX	1265	BR9EIX	3981
AG34A6(339cc)	339	BR9ES	5722	0.8	BR9EVX	1265	BR9EIX	3981
AA34F1(340cc)	340	BR8ES	5422	0.6	BR8EVX	1262	BR8EIX	5044
AA34F2(340cc)	340	BR8ES	5422	0.6	BR8EVX	1262	BR8EIX	5044
AA34F3(340cc)	340	BR8ES	5422	0.5	BR8EVX	1262	BR8EIX	5044
AA34F4(340cc)	340	BR8ES	5422	0.5	BR8EVX	1262	BR8EIX	5044
AA34F5(340cc)	340	BR8ES	5422	0.5	BR8EVX	1262	BR8EIX	5044
AB34F1(340cc)	340	BR9ES	5722	0.6	BR9EVX	1265	BR9EIX	3981
AE34L2(340cc)	340	BR9ES	5722	0.5	BR9EVX	1265	BR9EIX	3981
AF34A1(340cc)	340	BR8ES	5422	0.5	BR8EVX	1262	BR8EIX	5044
AG44A9(431cc)	431	BR9ES	5722	0.7	BR9EVX	1265	BR9EIX	3981
AJ44L1(431cc)	431	BR9ES	5722	0.8	BR9EVX	1265	BR9EIX	3981
AJ44L2(431cc)	431	BR9ES	5722	0.8	BR9EVX	1265	BR9EIX	3981
AJ44L3(431cc)	431	BR9ES	5722	0.8	BR9EVX	1265	BR9EIX	3981
AK44A1(431cc)	431	BR9ES	5722	0.8	BR9EVX	1265	BR9EIX	3981
AK44A7(431cc)	431	BR9ES	5722	0.8	BR9EVX	1265	BR9EIX	3981
AK44A8(431cc)	431	BR9ES	5722	0.8	BR9EVX	1265	BR9EIX	3981
AH44A9(436cc)	436	BR9ES	5722	0.7	BR9EVX	1265	BR9EIX	3981
AH44L6(436cc)	436	BR9ES	5722	0.8	BR9EVX	1265	BR9EIX	3981
AJ44L4(436cc)	436	BR9ES	5722	0.8	BR9EVX	1265	BR9EIX	3981
AJ44L5(436cc)	436	BR9ES	5722	0.8	BR9EVX	1265	BR9EIX	3981
AK44A1A(436cc)	436	BR9ES	5722	0.8	BR9EVX	1265	BR9EIX	3981
AK44A2(436cc)	436	BR9ES	5722	0.8	BR9EVX	1265	BR9EIX	3981
AK44A2A(436cc)	436	BR9ES	5722	0.8	BR9EVX	1265	BR9EIX	3981
AK44A3(436cc)	436	BR9ES	5722	0.8	BR9EVX	1265	BR9EIX	3981
AK44A3A(436cc)	436	BR9ES	5722	0.8	BR9EVX	1265	BR9EIX	3981
AK44A4(436cc)	436	BR9ES	5722	0.8	BR9EVX	1265	BR9EIX	3981
AK44A4A(436cc)	436	BR9ES	5722	0.8	BR9EVX	1265	BR9EIX	3981



ccm

Order  
No.Platin/  
Gold-  
PalladiumOrder  
No.

Iridium

Order  
No.**ARCTCO/ARCTIC CAT (Spirit(Suzuki)Engine)**

AK44A4B(436cc)	436	BR9ES	5722	0.8	BR9EVX	1265	BR9EIX	3981
AK44A5(436cc)	436	BR9ES	5722	0.8	BR9EVX	1265	BR9EIX	3981
AK44A5A(436cc)	436	BR9ES	5722	0.8	BR9EVX	1265	BR9EIX	3981
AK44A5B(436cc)	436	BR9ES	5722	0.8	BR9EVX	1265	BR9EIX	3981
AL44L1(436cc)	436	BR9ES	5722	0.8	BR9EVX	1265	BR9EIX	3981
AL44L2(436cc)	436	BR9ES	5722	0.8	BR9EVX	1265	BR9EIX	3981
AL44L3(436cc)	436	BR9ES	5722	0.8	BR9EVX	1265	BR9EIX	3981
AL44L5(436cc)	436	BR9ES	5722	0.8	BR9EVX	1265	BR9EIX	3981
AM44L1(436cc)	436	BR9ES	5722	0.8	BR9EVX	1265	BR9EIX	3981
AM44L2(436cc)	436	BR9ES	5722	0.8	BR9EVX	1265	BR9EIX	3981
AN44L1(436cc)	436	BR9ES	5722	0.8	BR9EVX	1265	BR9EIX	3981
AR44L1(436cc)	436	BR9ES	5722	0.8	BR9EVX	1265	BR9EIX	3981
AR44L1(438cc)	438	BR9ES	5722	0.8	BR9EVX	1265	BR9EIX	3981
AB44F1(440cc)	440	BR8ES	5422	0.5	BR8EVX	1262	BR8EIX	5044
AB44F2(440cc)	440	BR9ES	5722	0.6	BR9EVX	1265	BR9EIX	3981
AC44A1(440cc)	440	BR8ES	5422	0.6	BR8EVX	1262	BR8EIX	5044
AC44A2(440cc)	440	BR8ES	5422	0.5	BR8EVX	1262	BR8EIX	5044
AC44A3(440cc)	440	BR9ES	5722	0.5	BR9EVX	1265	BR9EIX	3981
AD44L1(440cc)	440	BR9ES	5722	0.6	BR9EVX	1265	BR9EIX	3981
AF44L1(440cc)	440	BR9ES	5722	0.5	BR9EVX	1265	BR9EIX	3981
AF44L2(440cc)	440	BR9ES	5722	0.5	BR9EVX	1265	BR9EIX	3981
AF44L3(440cc)	440	BR9ES	5722	0.5	BR9EVX	1265	BR9EIX	3981
AG44A1(440cc)	440	BR9ES	5722	0.5	BR9EVX	1265	BR9EIX	3981
AG44A2(440cc)	440	BR9ES	5722	0.5	BR9EVX	1265	BR9EIX	3981
AB50A1(500cc)	500	BR8ES	5422	0.6	BR8EVX	1262	BR8EIX	5044
AB50A2(500cc)	500	BR8ES	5422	0.6	BR8EVX	1262	BR8EIX	5044
AB50A3(500cc)	500	BR9ES	5722	0.5	BR9EVX	1265	BR9EIX	3981
AB50A4(500cc)	500	BR9ES	5722	0.5	BR9EVX	1265	BR9EIX	3981
AC50F1(500cc)	500	BR9ES	5722	0.6	BR9EVX	1265	BR9EIX	3981
AC50F2(500cc)	500	BR9ES	5722	0.6	BR9EVX	1265	BR9EIX	3981
AD50F1(500cc)	500	BR9ES	5722	0.6	BR9EVX	1265	BR9EIX	3981
AD50F2(500cc)	500	BR9ES	5722	0.6	BR9EVX	1265	BR9EIX	3981
AD50F3(500cc)	500	BR9ES	5722	0.5	BR9EVX	1265	BR9EIX	3981
AD50F4(500cc)	500	BR9ES	5722	0.5	BR9EVX	1265	BR9EIX	3981
AD50F5(500cc)	500	BR9ES	5722	0.5	BR9EVX	1265	BR9EIX	3981
AD50F6(500cc)	500	---		0.5	BR10EV	5127	BR10EIX	6801
AE50A1(500cc)	500	BR9ES	5722	0.6	BR9EVX	1265	BR9EIX	3981
AE50A2(500cc)	500	BR9ES	5722	0.5	BR9EVX	1265	BR9EIX	3981
AH50L1(500cc)	500	BR9ES	5722	0.5	BR9EVX	1265	BR9EIX	3981
AH50L2(500cc)	500	BR9ES	5722	0.5	BR9EVX	1265	BR9EIX	3981
AL50A1(500cc)	500	BR9ES	5722	0.5	BR9EVX	1265	BR9EIX	3981
AL50A2(500cc)	500	BR9ES	5722	0.5	BR9EVX	1265	BR9EIX	3981
AL50A7(500cc)	500	BR9ES	5722	0.7	BR9EVX	1265	BR9EIX	3981
AM50A4(500cc)	500	BR9ES	5722	0.7	BR9EVX	1265	BR9EIX	3981
AM50A5(500cc)	500	BR9ES	5722	0.8	BR9EVX	1265	BR9EIX	3981
AA53L3(529cc)	529	---		0.6	BR10EV	5127	BR10EIX	6801
AA53L4(529cc)	529	BR9ES	5722	0.8	BR9EVX	1265	BR9EIX	3981
AB53L5(529cc)	529	BR9ES	5722	0.8	BR9EVX	1265	BR9EIX	3981
AB53L6(529cc)	529	BR9ES	5722	0.8	BR9EVX	1265	BR9EIX	3981
AA55L1(550cc)	550	BR9ES	5722	0.8	BR9EVX	1265	BR9EIX	3981
AA55L2(550cc)	550	BR9ES	5722	0.8	BR9EVX	1265	BR9EIX	3981
AA55L3(550cc)	550	BR9ES	5722	0.8	BR9EVX	1265	BR9EIX	3981



ccm

Order  
No.Platin/  
Gold-  
PalladiumOrder  
No.

Iridium

Order  
No.**ARCTCO/ARCTIC CAT (Spirit(Suzuki)Engine)**

AA55L5(550cc)	550	BR9ES	5722	0.8	BR9EVX	1265	BR9EIX	3981
AA55L6(550cc)	550	BR9ES	5722	0.8	BR9EVX	1265	BR9EIX	3981
AB55L1(550cc)	550	BR9ES	5722	0.8	BR9EVX	1265	BR9EIX	3981
AB55L2(550cc)	550	BR9ES	5722	0.8	BR9EVX	1265	BR9EIX	3981
AA58L2(580cc)	580	BR9ES	5722	0.8	BR9EVX	1265	BR9EIX	3981
AB58L3(580cc)	580	BR9ES	5722	0.8	BR9EVX	1265	BR9EIX	3981
AB58L4(580cc)	580	BR9ES	5722	0.8	BR9EVX	1265	BR9EIX	3981
AC58L5(580cc)	580	BR9ES	5722	0.8	BR9EVX	1265	BR9EIX	3981
AA60L2(594cc)	594	BR9ES	5722	0.8	BR9EVX	1265	BR9EIX	3981
AA65L1(650cc)	650	---		0.6	BR10EV	5127	BR10EIX	6801
AA65L2(650cc)	650	---		0.7	BR9EVX	1265	BR9EIX	3981
AA65L3(650cc)	650	BR9ES	5722	0.8	BR9EVX	1265	BR9EIX	3981
AA70L5(700cc)	700	BR9ES	5722	0.8	BR9EVX	1265	BR9EIX	3981
AA70L6(700cc)	700	BR9ES	5722	0.8	BR9EVX	1265	BR9EIX	3981
AB70L1(700cc)	700	BR9ES	5722	0.8	BR9EVX	1265	BR9EIX	3981
AB70L2(700cc)	700	BR9ES	5722	0.8	BR9EVX	1265	BR9EIX	3981
AB70L3(700cc)	700	BR9ES	5722	0.8	BR9EVX	1265	BR9EIX	3981
AC70L1(700cc)	700	BR9ES	5722	0.8	BR9EVX	1265	BR9EIX	3981
AC70L2(700cc)	700	BR9ES	5722	0.8	BR9EVX	1265	BR9EIX	3981
AC70L3(700cc)	700	BR9ES	5722	0.8	BR9EVX	1265	BR9EIX	3981
AA80L1(794cc)	794	BR9ES	5722	0.8	BR9EVX	1265	BR9EIX	3981
AA80L2(794cc)	794	BR9ES	5722	0.8	BR9EVX	1265	BR9EIX	3981
AA90L1(896cc)	896	BR9ES	5722	0.8	BR9EVX	1265	BR9EIX	3981
AA90L4(896cc)	896	BR9ES	5722	0.8	BR9EVX	1265	BR9EIX	3981

**ARCTIC**

Bearcat 660 Wide Track	660	KR8AI	5477	0,8				
------------------------	-----	-------	------	-----	--	--	--	--

**BOLENS**

292, 295, R295(292cc)	292	B8HS	5510	0.6	B8HVX	2634	BR8HIX	7001
315(310cc)	310	B8HS	5510	0.6	B8HVX	2634	BR8HIX	7001
340, R340(336cc)	336	B8HS	5510	0.6	B8HVX	2634	BR8HIX	7001
399, R399(396cc)	396	B8HS	5510	0.6	B8HVX	2634	BR8HIX	7001
440, R440(438cc)	438	B8HS	5510	0.6	B8HVX	2634	BR8HIX	7001

**BOMBARDIER (BSE Engine)**

250M(247cc)	247	B7HS	5110	0.6	B7HVX	7836	BR7HIX	7067
296(294cc)	294	B8HS	5510	0.6	B8HVX	2634	BR8HIX	7001
340T, 340SS 12.7mm(1/2") Reach(336cc)	336	B7HS	5110	0.6	B7HVX	7836	BR7HIX	7067
340T, 340SS 19.0mm(3/4") Reach(336cc)	336	B8ES	2411	0.6	B8EVX	7051	BR8EIX	5044
339(399cc)	399	B8ES	2411	0.6	B8EVX	7051	BR8EIX	5044
440T, 440SS 12.7mm(1/2") Reach(435cc)	435	B7HS	5110	0.6	B7HVX	7836	BR7HIX	7067
440T, 440SS 19.0mm(3/4") Reach(435cc)	435	B8ES	2411	0.6	B8EVX	7051	BR8EIX	5044
439(437cc)	437	B8ES	2411	0.6	B8EVX	7051	BR8EIX	5044

**BOMBARDIER (Rotax Engine)**

Mini Z		BPR6ES	7822	0,7	BPR6EVX	6764	BPR6EIX	6637
250 Deluxe, 250T(247cc)	247	B7HS	5110	0.5	B7HVX	7836	BR7HIX	7067
250(10-12HP) (247cc)	247	A6	1010	0.5				
250(14HP) (247cc)	247	A7	1110	0.5				
250E(247cc)	247	A7	1110	0.5				
250SS(247cc)	247	B8HS	5510	0.5	B8HVX	2634	BR8HIX	7001





ccm

Order  
No.Platin/  
Gold-  
PalladiumOrder  
No.

Iridium

Order  
No.**BOMBARDIER (Rotax Engine)**

TNT, RV250(247cc)	247	B8ES	2411	0.5	B8EVX	7051	BR8EIX	5044
253 Safari Citation/E(248cc)	248	BR9ES	5722	0.5	BR9EVX	1265	BR9EIX	3981
247 Elan, Spirit(250cc)	250	A7	1110	0.5				
253 Citation L/S(253cc)	253	BR9ES	5722	0.5	BR9EVX	1265	BR9EIX	3981
253 Citation L/S Elec.(253cc)	253	BR9ES	5722	0.5	BR9EVX	1265	BR9EIX	3981
253 Tunda, -LT(253cc)	253	BR9ES	5722	0.5	BR9EVX	1265	BR9EIX	3981
277 Citation 3500(269cc)-->1981	269	B8ES	2411	0.5	B8EVX	7051	BR8EIX	5044
277 Citation 3500(269cc) 1983-82	269	BR8ES	5422	0.5	BR8EVX	1262	BR8EIX	5044
277 Mirage I(269cc)-->1981	269	B8ES	2411	0.5	B8EVX	7051	BR8EIX	5044
277 Mirage I(269cc) 1983-81	269	BR8ES	5422	0.5	BR8EVX	1262	BR8EIX	5044
277 Scandic(269cc) 1983-82	269	BR8ES	5422	0.5	BR8EVX	1262	BR8EIX	5044
Tundra 280F	280	BR9ES	5722	0.5	BR9EVX	1265	BR9EIX	3981
TNT292(292cc)	292	A8	1210	0.5				
TNT294, TNT300SM	292	B8HS	5510	0.5	B8HVX	2634	BR8HIX	7001
300 Citation(294cc)	294	B8HS	5510	0.5	B8HVX	2634	BR8HIX	7001
300SS, 300E, 300 Olym.(294cc)	294	B8HS	5510	0.5	B8HVX	2634	BR8HIX	7001
300(12.0HP) (299cc)	299	A6	1010	0.5				
300(15.0, 16.0HP) (299cc)	299	A7	1110	0.5				
300S(299cc)	299	A7	1110	0.5				
320E(318cc)	318	A7	1110	0.5				
320SS(318cc)	318	A8	1210	0.5				
420(318cc)	318	A7	1110	0.5				
335, 335E(335cc)	335	A7	1110	0.5				
TNT, RV340, Sonic 340(337cc)	337	---		0.5	B10EVX	7335	BR10EIX	6801
TNT340, TNT340SE	337	B8HS	5510	0.5	B8HVX	2634	BR8HIX	7001
340, 340E(339cc)	339	B8HS	5510	0.5	B8HVX	2634	BR8HIX	7001
340, 340E Olym.Ever	339	B9HS	5810	0.5	B9HVX	2254		
340SS(339cc)	339	A8	1210	0.5				
354 Blizzard 6500(339cc)	339	---		0.5	B10EVX	7335	BR10EIX	6801
354 Blizzard 7500, -Plus(339cc)	339	---		0.5	B10EVX	7335	BR10EIX	6801
354 Super Sonic/LC(339cc)	339	---		0.5	B10EVX	7335	BR10EIX	6801
Nuvik(339cc) 1979	339	B9HS	5810	0.5	B9HVX	2254		
TNT340 Free Air(339cc)	339	B9ES	2611	0.5	B9EVX	7254	BR9EIX	3981
TNT340SM(339cc)	339	B8HS	5510	0.5	B8HVX	2634	BR8HIX	7001
370(368cc)	368	B7HS	5110	0.5	B7HVX	7836	BR7HIX	7067
377 Citation 300(368cc) 1982	368	BR8ES	5422	0.5	BR8EVX	1262	BR8EIX	5044
377 Citation 4500(368cc) 1981	368	B8ES	2411	0.5	BR8EVX	1262	BR8EIX	5044
377 Citation 4500(368cc) 1983-82	368	BR8ES	5422	0.5	BR8EVX	1262	BR8EIX	5044
377 Citation 4500E(368cc) 1981	368	B8ES	2411	0.5	BR8EVX	1262	BR8EIX	5044
377 Citation 4500E(368cc) 1983-82	368	BR8ES	5422	0.5	BR8EVX	1262	BR8EIX	5044
377 Citation 4500SS(368cc) 1983-82	368	BR8ES	5422	0.5	BR8EVX	1262	BR8EIX	5044
377 Futura 300(368cc) 1983	368	BR8ES	5422	0.5	BR8EVX	1262	BR8EIX	5044
377 Mirage II(368cc) 1983-82	368	BR8ES	5422	0.5	BR8EVX	1262	BR8EIX	5044
377 Mirage II E(368cc) 1983-82	368	BR8ES	5422	0.5	BR8EVX	1262	BR8EIX	5044
377 Mirage II Special(368cc) 1982	368	BR8ES	5422	0.5	BR8EVX	1262	BR8EIX	5044
377 Nordic(368cc) 1983-82	368	BR8ES	5422	0.5	BR8EVX	1262	BR8EIX	5044
377 Safari Saga(368cc)	368	BR9ES	5722	0.5	BR9EVX	1265	BR9EIX	3981
377 Safari Scout/E(368cc)	368	BR9ES	5722	0.5	BR9EVX	1265	BR9EIX	3981
377 Skandic(368cc) 1984-83	368	BR8ES	5422	0.5	BR8EVX	1262	BR8EIX	5044
371(369cc)	369	B7HS	5110	0.5	B7HVX	7836	BR7HIX	7067
377 Formula S(377cc)	377	BR9ES	5722	0.5	BR9EVX	1265	BR9EIX	3981
377 Mirage III(377cc)	377	BR9ES	5722	0.5	BR9EVX	1265	BR9EIX	3981



ccm

Order  
No.Platin/  
Gold-  
PalladiumOrder  
No.

Iridium

Order  
No.**BOMBARDIER (Rotax Engine)**

377 Safari, -E(377cc)	377	BR9ES	5722	0.5	BR9EVX	1265	BR9EIX	3981
377 Skandic(377cc) 1985	377	BR8ES	5422	0.5	BR8EVX	1262	BR8EIX	5044
377 Skandic R(377cc) 1985	377	BR8ES	5422	0.5	BR8EVX	1262	BR8EIX	5044
377 Touring E/ELT(377cc)	377	BR9ES	5722	0.4	BR9EVX	1265	BR9EIX	3981
380 Scandic 380(380cc)	380	BR9ES	5722	0.4	BR9EVX	1265	BR9EIX	3981
Legend Fan 380F	380	BR9ES	5722	0.5	BR9EVX	1265	BR9EIX	3981
Legend GT 380F	380	BR9ES	5722	0.5	BR9EVX	1265	BR9EIX	3981
MX Z Fan	380	BR9ES	5722	0.5	BR9EVX	1265	BR9EIX	3981
399(399cc)	399	B8HS	5510	0.5	B8HVX	2634	BR8HIX	7001
400, 400E(399cc)	399	B8HS	5510	0.5	B8HVX	2634	BR8HIX	7001
400, 400E Futura(399cc) 1979	399	B8HS	5510	0.5	B8HVX	2634	BR8HIX	7001
TNT399(399cc)	399	B8HS	5510	0.5	B8HVX	2634	BR8HIX	7001
TNT400 Free Air(399cc)	399	B10ES	7928	0.5	B10EVX	7335	BR10EIX	6801
440 MX-Z 440/F(436cc)	436	BR9ES	5722	0.4	BR9EVX	1265	BR9EIX	3981
444 Elite(436cc)	436	B8ES	2411	0.5	B8EVX	7051	BR8EIX	5044
444LC Everest, Futura(436cc)	436	B8ES	2411	0.5	B8EVX	7051	BR8EIX	5044
440, 440E(437cc)	437	A8	1210	0.5				
440ER, 440R(437cc)	437	A7	1110	0.5				
447 Grand Luxe(437cc)	437	BR8ES	5422	0.5	BR8EVX	1262	BR8EIX	5044
447 Nordic 50(437cc)	437	BR9ES	5722	0.5	BR9EVX	1265	BR9EIX	3981
447 Safari 447(437cc)	437	BR8ES	5422	0.5	BR8EVX	1262	BR8EIX	5044
454 Blizzard 9500/Plus(437cc)	437	---		0.5	B10EVX	7335	BR10EIX	6801
Olympique Plus(437cc)	437	A7	1110	0.5				
TNT440(437cc)	437	A8	1210	0.5				
TNT440 Free Air 14mm Head(437cc)	437	B9ES	2611	0.5	B9EVX	7254	BR9EIX	3981
TNT440 Free Air 18mm Head(437cc)	437	A7	1110	0.5				
TNT440SE(437cc)	437	A8	1210	0.5				
TNT440SM(437cc)	437	A8	1210	0.5				
440 Touring LE(440cc)	440	BR9ES	5722	0.4	BR9EVX	1265	BR9EIX	3981
MX Zx Racing 440	440	BR9ECS	3570	0.5				
Skandic LT 440F	440	BR9ES	5722	0.5	BR9EVX	1265	BR9EIX	3981
Skandic LT(E) 440F	440	BR9ES	5722	0.5	BR9EVX	1265	BR9EIX	3981
443 Touring LE(443cc)	443	BR9ES	5722	0.5	BR9EVX	1265	BR9EIX	3981
447 Safari, -447(447cc) 1986	447	BR9ES	5722	0.5	BR9EVX	1265	BR9EIX	3981
454 MXZ 440(454cc)	454	BR9ES	5722	0.5	BR9EVX	1265	BR9EIX	3981
454 Ultra Sonic(463cc)	463	---		0.5	B10EVX	7335	BR10EIX	6801
462 SS25, SP, SS(463cc)	463	BR8ES	5422	0.5	BR8EVX	1262	BR8EIX	5044
464 Elite(463cc)-->1981	463	B8ES	2411	0.5	B8EVX	7051	BR8EIX	5044
464 Elite(463cc) 1983-82	463	BR8ES	5422	0.5	BR8EVX	1262	BR8EIX	5044
464 Everest LC(463cc) 1983-82	463	BR8ES	5422	0.5	BR8EVX	1262	BR8EIX	5044
464 Everest LC(463cc)-->1981	463	B8ES	2411	0.5	B8EVX	7051	BR8EIX	5044
464 Futura LC(463cc)-->1981	463	B8ES	2411	0.5	B8EVX	7051	BR8EIX	5044
464 Futura LC(463cc) 1983-82	463	BR8ES	5422	0.5	BR8EVX	1262	BR8EIX	5044
494 Formula SLS(494cc)	494	BR9ES	5722	0.5	BR9EVX	1265	BR9EIX	3981
494 Skandic WT LC(494cc)	494	BR8ES	5422	0.5	BR8EVX	1262	BR8EIX	5044
494 Summit 500(494cc)	494	BR9ES	5722	0.5	BR9EVX	1265	BR9EIX	3981
467 Formula MX/LT(496cc)	496	BR9ES	5722	0.5	BR9EVX	1265	BR9EIX	3981
503 Alpine II(496cc)	496	BR8ES	5422	0.5	BR8EVX	1262	BR8EIX	5044
503 Escapade(496cc)	496	BR9ES	5722	0.5	BR9EVX	1265	BR9EIX	3981
503 Nordic 60(496cc)	496	BR9ES	5722	0.5	BR9EVX	1265	BR9EIX	3981
503 Safari 503R(496cc)	496	BR9ES	5722	0.5	BR9EVX	1265	BR9EIX	3981
503 Alpine(497cc) 1986-83	497	BR7ES	5122	0.5	BR7EVX	4556		



ccm

Order  
No.Platin/  
Gold-  
PalladiumOrder  
No.

Iridium

Order  
No.**BOMBARDIER (Rotax Engine)**

503 Blizzard 5500(497cc) 1981	497	BR8ES	5422	0.5	BR8EVX	1262	BR8EIX	5044
503 Blizzard 5500MX(497cc) 1983-82	497	BR7ES	5122	0.5	BR7EVX	4556		
503 Blizzard MX(497cc) 1984	497	BR8ES	5422	0.5	BR8EVX	1262	BR8EIX	5044
503 Everest 500(497cc) 1985-84, 1982	497	BR7ES	5122	0.5	BR7EVX	4556		
503 Everest 500, -E(497cc) 1981	497	BR8ES	5422	0.5	BR8EVX	1262	BR8EIX	5044
503 Futura 500, -E(497cc) 1983-82	497	BR7ES	5122	0.5	BR7EVX	4556		
503 Grand Prix Spec.(497cc) 1982	497	BR7ES	5122	0.5	BR7EVX	4556		
503 Safari Cheyenne(497cc)	497	BR9ES	5722	0.5	BR9EVX	1265	BR9EIX	3981
503 Safari Escapade(497cc)	497	BR9ES	5722	0.5	BR9EVX	1265	BR9EIX	3981
503 Safari Voyageur(497cc)	497	BR9ES	5722	0.5	BR9EVX	1265	BR9EIX	3981
503 Sonic MX(497cc) 1983	497	BR7ES	5122	0.5	BR7EVX	4556		
500 GT 500(500cc)	500	BR9ES	5722	0.4	BR9EVX	1265	BR9EIX	3981
500 Scandic 500(500cc)	500	BR9ES	5722	0.4	BR9EVX	1265	BR9EIX	3981
GSX Sport 1+1 500 SS	500	BR9ECS	3570	0,5				
GSX Sport 500 SS	500	BR9ECS	3570	0,5				
Legend Sport 500 SS	500	BR9ECS	3570	0,5				
Legend Sport GT 500 SS	500	BR9ECS	3570	0,5				
MX Z Adrenaline 500 SS	500	BR9ECS	3570	0,5				
MX Z Adrenaline 500 SS (E)	500	BR9ECS	3570	0,5				
MX Z Trail 500 SS	500	BR9ECS	3570	0,5				
MX Z Trail 500 SS (E)	500	BR9ECS	3570	0,5				
503 Formula SL(503cc)	503	BR9ES	5722	0.5	BR9EVX	1265	BR9EIX	3981
503 Skandic SWT(503cc)	503	BR8ES	5422	0.5	BR8EVX	1262	BR8EIX	5044
503 Skandic WT503R(503cc)	503	BR9ES	5722	0.5	BR9EVX	1265	BR9EIX	3981
503 Summit 500(503cc)	503	BR9ES	5722	0.5	BR9EVX	1265	BR9EIX	3981
503 Touring SLE(503cc)	503	BR9ES	5722	0.5	BR9EVX	1265	BR9EIX	3981
534 Blizzasd 9700(521cc)-->1983	521	BR8ES	5422	0.5	BR8EVX	1262	BR8EIX	5044
536 Formula Plus/LT(521cc)	521	BR9ES	5722	0.5	BR9EVX	1265	BR9EIX	3981
537 Formula Plus(537cc)	537	BR9ES	5722	0.5	BR9EVX	1265	BR9EIX	3981
Legend Fan 550F	550	BR9ES	5722	0.5	BR9EVX	1265	BR9EIX	3981
Legend GT 550F	550	BR9ES	5722	0.5	BR9EVX	1265	BR9EIX	3981
MX Z Fan 550F	550	BR9ES	5722	0.5	BR9EVX	1265	BR9EIX	3981
Skandic Sport 550F	550	BR9ES	5722	0.5	BR9EVX	1265	BR9EIX	3981
Skandic SUV 550F	550	BR9ES	5722	0.5	BR9EVX	1265	BR9EIX	3981
Skandic SWT 550F	550	BR9ES	5722	0.5	BR9EVX	1265	BR9EIX	3981
Skandic WT 550F	550	BR9ES	5722	0.5	BR9EVX	1265	BR9EIX	3981
Summit Fan 550F	550	BR9ES	5722	0.5	BR9EVX	1265	BR9EIX	3981
583 Formula Mach I(581cc)	581	BR9ES	5722	0.5	BR9EVX	1265	BR9EIX	3981
582 GT 582(582cc)	582	BR9ES	5722	0.4	BR9EVX	1265	BR9EIX	3981
583 Formula STX/STXL/STXLT/Z 583(583cc)	583	BR9ES	5722	0.5	BR9EVX	1265	BR9EIX	3981
583 GT 583	583	BR9ES	5722	0.5	BR9EVX	1265	BR9EIX	3981
583 MX-Z 583(583cc)	583	BR9ES	5722	0.5	BR9EVX	1265	BR9EIX	3981
583 MX-Z LI 583(583cc)	583	BR9ES	5722	0.5	BR9EVX	1265	BR9EIX	3981
583 Summit 583(583cc)	583	BR9ES	5722	0.5	BR9EVX	1265	BR9EIX	3981
599 Formula III/III LT(599cc)	599	BR10ES	4832	0.5	BR10EV	5127	BR10EIX	6801
600 Formula III(600cc)	600	BR10ES	4832	0.5	BR10EV	5127	BR10EIX	6801
GSX Limited 600 HO SDI	600	BR9ECS	3570	0,8				
GSX LTD 1+1 600 HO SDI	600	BR9ECS	3570	0,8				
GSX Sport 1+1 600 HO	600	BR9ECS	3570	0,5				
GSX Sport 1+1 600HO SDI	600	BR9ECS	3570	0,8				
GSX Sport 600 HO	600	BR9ECS	3570	0,5				
GSX Sport 600 HO SDI	600	BR9ECS	3570	0,8				



ccm

Order  
No.Platin/  
Gold-  
PalladiumOrder  
No.

Iridium

Order  
No.**BOMBARDIER (Rotax Engine)**

Legend SE 600 HO SDI	600	BR9ECS	3570	0,5				
Legend SE GT 600 HO SDI	600	BR9ECS	3570	0,5				
Legend Sport 600 HO SDI	600	BR9ECS	3570	0,5				
Legend Sport GT 600 HO SDI	600	BR9ECS	3570	0,5				
MX Z Renegade X 600 HO SDI	600	BR9ECS	3570	0,8				
MX Z X 600 HO	600	BR9ECS	3570	0,5				
MX Z X 600 HO (E)	600	BR9ECS	3570	0,5				
MX Z X 600 HO SDI	600	BR9ECS	3570	0,8				
MX Z Adrenaline 600 HO	600	BR9ECS	3570	0,5				
MX Z Adrenaline 600 HO (E)	600	BR9ECS	3570	0,5				
MX Z Adrenaline 600 HO SDI	600	BR9ECS	3570	0,8				
MX Z Adrenaline 600 HO SDI (E)	600	BR9ECS	3570	0,8				
MX Z Rene. X 600 HO SDI (E)	600	BR9ECS	3570	0,8				
MX Z Renegade 600 HO	600	BR9ECS	3570	0,5				
MX Z Renegade 600 HO (E)	600	BR9ECS	3570	0,5				
MX Z Renegade X 600 HO	600	BR9ECS	3570	0,5				
MX Z Renegade X 600 HO (E)	600	BR9ECS	3570	0,5				
MX Z Trail 600 HO	600	BR9ECS	3570	0,5				
MX Z Trail 600 HO (E)	600	BR9ECS	3570	0,5				
MX Z X 600 HO SDI (E)	600	BR9ECS	3570	0,8				
Skandic SUV 600	600	BR9ECS	3570	0,5				
Skandic WT LC 600	600	BR9ECS	3570	0,5				
Summit Adrenaline 600 HO	600	BR9ECS	3570	0,5				
Summit X 600 HO	600	BR9ECS	3570	0,5				
640 ER Alpine(635cc)	635	B7HS	5110	0,5	B7HVX	7836	BR7HIX	7067
640, 640ER(635cc)	635	A7	1110	0,5				
TNT640(635cc)	635	A7	1110	0,5				
TNT669(669cc)	669	A7	1110	0,5				
670 Formula SS(670cc)	670	BR9ES	5722	0,5	BR9EVX	1265	BR9EIX	3981
670 GT SE670(670cc)	670	BR9ES	5722	0,5	BR9EVX	1265	BR9EIX	3981
670 Mach 1(670cc)	670	BR10ES	4832	0,5	BR10EV	5127	BR10EIX	6801
670 Summit 670(670cc)	670	BR9ES	5722	0,5	BR9EVX	1265	BR9EIX	3981
699 GT SE(699cc)	699	BR10ES	4832	0,4	BR10EV	5127	BR10EIX	6801
699 Mach 1(699cc)	699	BR10ES	4832	0,4	BR10EV	5127	BR10EIX	6801
Legend SE 700	700	BR9ECS	3570	0,5				
Legend SE GT 700	700	BR9ECS	3570	0,5				
Legend Sport 700	700	BR9ECS	3570	0,5				
Legend Sport GT 700	700	BR9ECS	3570	0,5				
TNT775(771cc)	771	A8	1210	0,5				
779 Mach Z/ZLT(779cc)	779	BR10ES	4832	0,5	BR10EV	5127	BR10EIX	6801
GSX Limited 1+1 800 HO	800	BR9ECS	3570	0,5				
GSX Limited 800 HO	800	BR9ECS	3570	0,5				
Legend SE 800 SDI	800	BR9ECS	3570	0,8				
Legend SE GT 800 SDI	800	BR9ECS	3570	0,8				
MX Z Renegade 800 (E)	800	BR9ECS	3570	0,5				
MX Z X Reneg. 800 HO (E)	800	BR9ECS	3570	0,5				
MX Z Adrenaline 800 (E)	800	BR9ECS	3570	0,5				
MX Z Adrenaline 800 HO	800	BR9ECS	3570	0,5				
MX Z Renegade 800 HO	800	BR9ECS	3570	0,5				
MX Z Renegade X 800 HO	800	BR9ECS	3570	0,5				
MX Z X 800 HO	800	BR9ECS	3570	0,5				
MX Z X 800 HO (E)	800	BR9ECS	3570	0,5				



ccm

Order  
No.Platin/  
Gold-  
PalladiumOrder  
No.

Iridium

Order  
No.**BOMBARDIER (Rotax Engine)**

Summit Adrenalin 800 HO	800	BR9ECS	3570	0,5				
Summit HM 800 HO	800	BR9ECS	3570	0,5				
Summit HM X 800 HO	800	BR9ECS	3570	0,5				
Summit HM Xtreme 800 HO	800	BR9ECS	3570	0,5				
Summit Sport 800 HO	800	BR9ECS	3570	0,5				
Summit X 800 HO	800	BR9ECS	3570	0,5				
809 Mach Z(809cc)	809	BR10ES	4832	0.4	BR10EV	5127	BR10EIX	6801
Legend SE GT V-1000	1000	DCPR8E	4339	0,8	DCPR8EVX	2265	DCPR8EIX	6546
Legend SE V-1000	1000	DCPR8E	4339	0,8	DCPR8EVX	2265	DCPR8EIX	6546

**BURAN**

PM3-640 20,6kW	640	BP6ES	7811	0,7	BP6EVX	5832		
----------------	-----	-------	------	-----	--------	------	--	--

**CANADIAN CURTIS WRIGHT**

KEC248(248cc)	248	A7	1110	0.6				
KEC290/2, KEC290/3(290cc)	290	B8HS	5510	0.6	B8HVX	2634	BR8HIX	7001
KEC295RS/2(290cc)	290	BUE	2322	-				
KEC340/2, KEC340/3(339cc)	339	B8HS	5510	0.6	B8HVX	2634	BR8HIX	7001
KEC340/22A(339cc)	339	B8ES	2411	0.6	B8EVX	7051	BR8EIX	5044
KEC340/4(339cc)	339	B8HS	5510	0.6	B8HVX	2634	BR8HIX	7001
KEC340/5(339cc)	339	B8ES	2411	0.6	B8EVX	7051	BR8EIX	5044
KEC340/5A(339cc)	339	B8ES	2411	0.6	B8EVX	7051	BR8EIX	5044
KEC400/2, KEC400/3(398cc)	398	B8HS	5510	0.6	B8HVX	2634	BR8HIX	7001
KEC400/21(398cc)	398	B8HS	5510	0.6	B8HVX	2634	BR8HIX	7001
KEC400/22(398cc)	398	B8ES	2411	0.6	B8EVX	7051	BR8EIX	5044
KEC400/22A(398cc)	398	B8ES	2411	0.6	B8EVX	7051	BR8EIX	5044
KEC400/4(398cc)	398	B8HS	5510	0.6	B8HVX	2634	BR8HIX	7001
KEC440/21(436cc)	436	B8HS	5510	0.6	B8HVX	2634	BR8HIX	7001
KEC440/22(436cc)	436	B8HS	5510	0.6	B8HVX	2634	BR8HIX	7001
KEC440/22A(436cc)	436	B8HS	5510	0.6	B8HVX	2634	BR8HIX	7001
KEC440/3, KEC440/4(436cc)	436	B8HS	5510	0.6	B8HVX	2634	BR8HIX	7001
KEC440/5(436cc)	436	B8ES	2411	0.6	B8EVX	7051	BR8EIX	5044

**CCW - Snowmobile Engines**

KEC 248	248	AB-7	3010	0,6			---	---
KEC 290	290	B8HS	5510	0,6	B8HVX	2634	BR8HIX	7001
KEC 290RC/2	290	BUE	2322				---	---
KEC 340	340	B8HS	5510	0,6	B8HVX	2634	BR8HIX	7001
KEC 340/22A	340	B8ES	2411	0,6	B8EVX	7051	BR8EIX	5044
KEC 340/5	340	B8ES	2411	0,6	B8EVX	7051	BR8EIX	5044
KEC 400	400	B8HS	5510	0,6	B8HVX	2634	BR8HIX	7001
KEC 400/22	400	B8ES	2411	0,6	B8EVX	7051	BR8EIX	5044
KEC 440	440	B8HS	5510	0,6	B8HVX	2634	BR8HIX	7001
KEC 440/5	440	B8ES	2411	0,6	B8EVX	7051	BR8EIX	5044

**CHAPARRAL (XENOAH)**

250(242cc)	242	B8ES	2411	0.5	B8EVX	7051	BR8EIX	5044
295(292cc)	292	BR7ES	5122	0.5	BR7EVX	4556		
340(338cc)	338	BR7ES	5122	0.5	BR7EVX	4556		
340SS(338cc)	338	B9ES	2611	0.5	B9EVX	7254	BR9EIX	3981
SSX340(338cc)	338	BR8ES	5422	0.5	BR8EVX	1262	BR8EIX	5044
400 19.0mm(3/4") Reach(394cc)	394	B8ES	2411	0.5	B8EVX	7051	BR8EIX	5044



ccm

Order  
No.Platin/  
Gold-  
PalladiumOrder  
No.

Iridium

Order  
No.**CHAPARRAL (XENOAH)**

400 12.7mm(1/2") Reach(398cc)	398	B7HS	5110	0.5	B7HVX	7836	BR7HIX	7067
400SS 12.7mm(1/2") Reach(400cc)	400	B8HS	5510	0.5	B8HVX	2634	BR8HIX	7001
400SS 19.0mm(3/4") Reach(400cc)	400	B9ES	2611	0.5	B9EVX	7254	BR9EIX	3981
440 12.7mm(1/2") Reach(438cc)	438	B7HS	5110	0.5	B7HVX	7836	BR7HIX	7067
440 19.0mm(3/4") Reach(438cc)	438	BR7ES	5122	0.5	BR7EVX	4556		
SSX440(438cc)	438	BR8ES	5422	0.5	BR8EVX	1262	BR8EIX	5044
440 Racing, 650 Racing(440cc)	440	---		0.5	B8HVX	2634	BR8HIX	7001
440SS 12.7mm(1/2") Reach(440cc)	440	B8HS	5510	0.5	B8HVX	2634	BR8HIX	7001
440SS 19.0mm(3/4") Reach(440cc)	440	B9ES	2611	0.5	B9EVX	7254	BR9EIX	3981

**ECHO (-->KIORITZ)**

ECHO (-->KIORITZ)								
-------------------	--	--	--	--	--	--	--	--

**EVINRUDE (-->OMC)**

EVINRUDE (-->OMC)								
-------------------	--	--	--	--	--	--	--	--

**HIRTH**

110R(180cc)	180	A7	1110	0.5				
60R(199cc)	199	A7	1110	0.5				
81R, 82R(246cc)	246	A7	1110	0.5				
261R, 261R3, 261R4(292cc)	292	B8ES	2411	0.5	B8EVX	7051	BR8EIX	5044
56R, 193R(292cc)	292	A7	1110	0.5				
190, 191R(300cc)	300	A7	1110	0.5				
52R, 53R, 54R, 55R(300cc)	300	A7	1110	0.5				
192R(317cc)	317	A7	1110	0.5				
194R(338cc)	338	A7	1110	0.5				
260R, 260R3, 260R4(338cc)	338	B8ES	2411	0.5	B8EVX	7051	BR8EIX	5044
160R, 200R(372cc)	372	A7	1110	0.5				
210R, 271R0(399cc)	399	A7	1110	0.5				
211R, 270R, 273R(438cc)	438	A7	1110	0.5				
180R, 220R, 275R(493cc)	493	A7	1110	0.5				
170R(600cc)	600	A7	1110	0.5				
171R(634cc)	634	A7	1110	0.5				
231R(647cc)	647	B8HS	5510	0.5	B8HVX	2634	BR8HIX	7001
280R(649cc)	649	B8ES	2411	0.5	B8EVX	7051	BR8EIX	5044
172R(650cc)	650	A7	1110	0.5				
281R0(650cc)	650	B8ES	2411	0.5	B8EVX	7051	BR8EIX	5044
230R(793cc)	793	B8HS	5510	0.5	B8HVX	2634	BR8HIX	7001

**IKAR**

PM3-320 11,8kW	320	BP6ES	7811	0,7	BP6EVX	5832		
----------------	-----	-------	------	-----	--------	------	--	--

**ILO-ROCKWELL**

L99(100cc)	100	B6HS	4510	0.5			BR6HIX	3419
L152(148cc)	148	A6	1010	0.5				
L197(192cc)	192	A6	1010	0.5				
L227, L230(223cc)	223	A7	1110	0.5				
L252(257cc)	257	A6	1010	0.5				
2F295(285cc)	285	B8ES	2411	0.5	B8EVX	7051	BR8EIX	5044
L292, L295(292cc)	292	A7	1110	0.5				
R295, L295/70(292cc)	292	B8ES	2411	0.5	B8EVX	7051	BR8EIX	5044
L297, L300(296cc)	296	A7	1110	0.5				



ccm

Order  
No.Platin/  
Gold-  
PalladiumOrder  
No.

Iridium

Order  
No.**ILO-ROCKWELL**

2F340(337cc)	337	B8ES	2411	0.5	B8EVX	7051	BR8EIX	5044
L340(337cc)	337	A7	1110	0.5				
R340, L340/70, LR340/2(337cc)	337	B8ES	2411	0.5	B8EVX	7051	BR8EIX	5044
L372, L380(372cc)	372	A7	1110	0.5				
L395(396cc)	396	A7	1110	0.5				
L399/2, LR399/2, LR400/2(398cc)	398	B8ES	2411	0.5	B8EVX	7051	BR8EIX	5044

**JOHN DEERE (Kawasaki Engine)**

TA340A(339cc)	339	BR8ES	5422	0.8	BR8EVX	1262	BR8EIX	5044
TA340A-D202(339cc)	339	BR8ES	5422	0.8	BR8EVX	1262	BR8EIX	5044
TA340A-F202(339cc)	339	BR8ES	5422	0.8	BR8EVX	1262	BR8EIX	5044
TB340A-A202(339cc)	339	BR8ES	5422	0.8	BR8EVX	1262	BR8EIX	5044
TB340A-C202(339cc)	339	BR8ES	5422	0.8	BR8EVX	1262	BR8EIX	5044
All 1981 Models(436cc)	436	BR9ES	5722	0.8	BR9EVX	1265	BR9EIX	3981
TA440A(436cc)	436	BR8ES	5422	0.8	BR8EVX	1262	BR8EIX	5044
TA440A-D202(436cc)	436	BR8ES	5422	0.8	BR8EVX	1262	BR8EIX	5044
TA440A-F202(436cc)	436	BR8ES	5422	0.8	BR8EVX	1262	BR8EIX	5044
TA440B-C202(436cc)	436	BR9ES	5722	0.8	BR9EVX	1265	BR9EIX	3981
TA440B-E202(436cc)	436	BR9ES	5722	0.8	BR9EVX	1265	BR9EIX	3981
TC440A-C202(436cc)	436	BR9ES	5722	0.8	BR9EVX	1265	BR9EIX	3981
TC440A-E202(436cc)	436	BR9ES	5722	0.8	BR9EVX	1265	BR9EIX	3981

**JOHN DEERE (Kioritz Engine)**

KEC295RS/2(290cc)	290	B10ES	7928	0.6	B10EVX	7335	BR10EIX	6801
KEC340/22A w/C.D.ig.(339cc)	339	B10ES	7928	0.6	B10EVX	7335	BR10EIX	6801
KEC340/22A w/Mag.ig.(339cc)	339	B8ES	2411	0.6	B8EVX	7051	BR8EIX	5044
KEC340/22B, -22C(339cc)	339	B10ES	7928	0.6	B10EVX	7335	BR10EIX	6801
KEC340/23ALC, -23BLC(339cc)	339	B10ES	7928	0.6	B10EVX	7335	BR10EIX	6801
KEC340/23LC(339cc)	339	B10ES	7928	0.6	B10EVX	7335	BR10EIX	6801
KEC340/5A(339cc)	339	B8ES	2411	0.6	B8EVX	7051	BR8EIX	5044
KEC340RS/2(339cc)	339	B10ES	7928	0.6	B10EVX	7335	BR10EIX	6801
KEC340RS/24LC(339cc)	339	B10ES	7928	0.6	B10EVX	7335	BR10EIX	6801
KEC440/22A w/C.D.ig.(436cc)	436	B10ES	7928	0.6	B10EVX	7335	BR10EIX	6801
KEC440/22A w/Mag.ig.(436cc)	436	B8ES	2411	0.6	B8EVX	7051	BR8EIX	5044
KEC440/22B-22C(436cc)	436	B10ES	7928	0.6	B10EVX	7335	BR10EIX	6801
KEC440/23AL, -23BLC(436cc)	436	B10ES	7928	0.6	B10EVX	7335	BR10EIX	6801
KEC440/23LC(436cc)	436	B10ES	7928	0.6	B10EVX	7335	BR10EIX	6801

**KAWASAKI - Snowmobile Engines**

TA340A	340	BR8ES	5422	0,8			BR8EIX	5044
TA340A-A201	340	BR8ES	3961	0,8			BR8EIX	6747
TA340A-D201	340	BR8ES	3961	0,8			BR8EIX	6747
TA340C-D203	340	BR9ES	3194	0,7	BR9EVX	4318	BR9EIX	3981
TC340A	340	---	---	0,6			BR9EIX	3981
TC340A-C201	340	---	---	0,6			BR9EIX	3981
TA440A	440	BR8ES	5422	0,8			BR8EIX	5044
TA440B	440	---	---	0,8			BR9EIX	3981
TA440B-C201	440	---	---	0,6			BR9EIX	3981
TA440C	440	---	---	0,6			BR9EIX	3981
TA440C-C201	440	---	---	0,6			BR9EIX	3981
TA440C-D203	440	---	---	0,6			BR9EIX	3981
TA440C-D210	440	---	---	0,6			BR9EIX	3981



ccm

Order  
No.Platin/  
Gold-  
PalladiumOrder  
No.

Iridium

Order  
No.**KAWASAKI - Snowmobile Engines**

TC440A	440	---	---	0,6			BR9EIX	3981
TC440A-C201	440	---	---	0,6			BR9EIX	3981
TC440C-A201	440	---	---	0,6			BR9EIX	3981
TC440D-A201	440	---	---	0,6			BR9EIX	3981
TC440D-A204	440	---	---	0,6			BR9EIX	3981
TC530D-B201	530	---	---	0,6			BR9EIX	3981

**KIORITZ (ECHO)**

KEC295RS(290cc)	290	BUE	2322	-				
KEC340/22A w/C.D.ig.(339cc)	339	BUE	2322	-				
KEC340/22A w/Mag.ig.(339cc)	339	B8ES	2411	0.6	B8EVX	7051	BR8EIX	5044
KEC340/22B w/C.D.ig.(339cc)	339	---		0.6	B10EVX	7335	BR10EIX	6801
KEC340/23LC, 23ALC, 23BLC(339cc)	339	---		0.6	B10EVX	7335	BR10EIX	6801
KEC340/5A(339cc)	339	B8ES	2411	0.6	B8EVX	7051	BR8EIX	5044
KEC340RS/2(339cc)	339	BUE	2322	-				
KEC340RS/24LC(339cc)	339	BUE	2322	-				
KEC440/22A w/C.D.ig.(436cc)	436	BUE	2322	-				
KEC440/22A w/Mag.ig.(436cc)	436	B8ES	2411	0.6	B8EVX	7051	BR8EIX	5044
KEC440/22B w/C.D.ig.(436cc)	436	---		0.6	B10EVX	7335	BR10EIX	6801
KEC440/23LC, -23ALC, -23BLC(436cc)	436	---		0.6	B10EVX	7335	BR10EIX	6801

**KOHLER**

K141, K161, K181(4 Cycle)		B6S	3510	0.5				
K250-1AM(220cc)	220	B8ES	2411	0.5	B8EVX	7051	BR8EIX	5044
K250-RLC(250cc)	250	BUE	2322	-				
K295-2, K295-2AX(290cc)	290	B8ES	2411	0.5	B8EVX	7051	BR8EIX	5044
K295-2SS(290cc)	290	B10ES	7928	0.5	B10EVX	7335	BR10EIX	6801
K295-2T(292cc)	292	B8ES	2411	0.5	B8EVX	7051	BR8EIX	5044
K295-1, K295-1T(294cc)	294	A7	1110	0.5				
K309-1, K309-1T(309cc)	309	A7	1110	0.5				
K335-1, K335-1T(335cc)	335	A7	1110	0.5				
K340-2, K340-2T(338cc)	338	B8HS	5510	0.5	B8HVX	2634	BR8HIX	7001
K340-2AX(338cc)	338	B8ES	2411	0.5	B8EVX	7051	BR8EIX	5044
K340-2FA(338cc)	338	BR8ES	5422	0.5	BR8EVX	1262	BR8EIX	5044
K340-2SS(338cc)	338	B10ES	7928	0.5	B10EVX	7335	BR10EIX	6801
K340-2AS, -2RS, -RLC(339cc)	339	BUE	2322	-				
SK340-2AX(339cc)	339	BUE	2322	-				
K399-2, -2T(398cc)	398	A7	1110	0.5				
K399-2AX, RK399-2AX(398cc)	398	B9ES	2611	0.5	B9EVX	7254	BR9EIX	3981
K400-2RS(398cc)	398	BUE	2322	-				
K440-2SS 12.7mm(1/2") Reach(429cc)	429	B9HS	5810	0.5	B9HVX	2254		
K440-2SS 19.0mm(3/4") Reach(429cc)	429	B10ES	7928	0.5	B10EVX	7335	BR10EIX	6801
K440-3RS 12.7mm(1/2") Reach(429cc)	429	B9HS	5810	0.5	B9HVX	2254		
K440-3RS 19.0mm(3/4") Reach(429cc)	429	B10ES	7928	0.5	B10EVX	7335	BR10EIX	6801
K440-2(436cc)	436	A7	1110	0.5				
K440-2AM(436cc)	436	B9ES	2611	0.5	B9EVX	7254	BR9EIX	3981
K440-2AM w/C.D.ig.(436cc)	436	BUE	2322	-				
K440-2AS, -2RS, -RLC(436cc)	436	BUE	2322	-				
K440-2AX(436cc)	436	B8ES	2411	0.5	B8EVX	7051	BR8EIX	5044
K440-2T(436cc)	436	A7	1110	0.5				
RK440-2T(436cc)	436	A8	1210	0.5				
SK440-2LC(436cc)	436	BUE	2322	-				





ccm

Order  
No.Platin/  
Gold-  
PalladiumOrder  
No.

Iridium

Order  
No.**KOHLER**

K539-2(539cc)	539	A7	1110	0.5				
K618-2(618cc)	618	A7	1110	0.5				
K645-3RS 12.7mm(1/2") Reach(645cc)	645	B9HS	5810	0.5	B9HVX	2254		
K645-3RS 19.0mm(3/4") Reach(645cc)	645	B10ES	7928	0.5	B10EVX	7335	BR10EIX	6801
K645-3SS 12.7mm(1/2") Reach(645cc)	645	B9HS	5810	0.5	B9HVX	2254		
K645-3SS 19.0mm(3/4") Reach(645cc)	645	B10ES	7928	0.5	B10EVX	7335	BR10EIX	6801

**MERCURY (-->CANADIAN CURTIS WRIGHT, HIRTH, KOHLER)**

Hurricane(Mark I, II) (644cc)	644	BUH	2422	-				
-------------------------------	-----	-----	------	---	--	--	--	--

**NPO SATURN**

Taiga	500	BR9ES	5722	0.5	BR9EVX	1265	BR9EIX	3981
-------	-----	-------	------	-----	--------	------	--------	------

**OCKELBO**

Sachs Wankel KM914		B6HS	4510	0.5			BR6HIX	3419
Sachs SA280	280	A6	1010	0.5				
Sachs SA290	290	A7	1110	0.5				
Sachs SA290SS	290	B8HS	5510	0.5	B8HVX	2634	BR8HIX	7001
JLO LR340/2	340	B8ES	2411	0.5	B8EVX	7051	BR8EIX	5044
Sachs SA340	340	A8	1210	0.5				
Sachs SA340RX	340	B9ES	2611	0.5	B9EVX	7254	BR9EIX	3981
JLO 2F-400	400	B7ES	1111	0.5	B7EVX	6934		
Rotax Ockelbo 400	400	B7ES	1111	0.5	B7EVX	6934		

**OMC (JOHNSON-EVINRUDE)**

M228(399cc)	399	B6S	3510	0.8				
M232, M232E, M235, M237(399cc)	399	B8S	3810	0.8				
M225, M225C(437cc)	437	B6S	3510	0.8				
M226E, M226W, M231E, M231W(437cc)	437	B6S	3510	0.8				
M227(437cc)	437	B7S	3710	0.8				
M229E, M229W, M230, M230E(437cc)	437	B8S	3810	0.8				
M233, M233E, M234E, M236(437cc)	437	B8S	3810	0.8				
M238, M239E, M241E, M245(437cc)	437	B8S	3810	0.8				

**POLARIS**

PS-06		BR8ES	5422	0.6	BR8EVX	1262	BR8EIX	5044
120 Pro X / EH122PM012 / 2005-2003	120	BR6ES	4922	0,7				
Indy 120 XC SP / / 2004-2000	121	BR6ES	4922	0,7				
/ EC16P /	164	B7ES	1111	0,5	B7EVX	6934		
EC16P(164cc)	164	B7ES	1111	0.4	B7EVX	6934		
/ EC17P /	175	B7ES	1111	0,5	B7EVX	6934		
EC17P(175cc)	175	B7ES	1111	0.4	B7EVX	6934		
EC17PM(175cc)	175	B7ES	1111	0.4	B7EVX	6934		
/ EC25PM-01 /	244	BR8ES	3961	0,7	BR8EVX	1043	BR8EIX	5044
/ EC25PT-04 /	244	BR8ES	3961	0,7	BR8EVX	1043	BR8EIX	5044
/ EC25PT-06 /	244	B9ES	2611	0,5	B9EVX	7254	BR9EIX	3981
/ EC25PT-05 /	244	B10ES	7928	0,5	B10EVX	7335	BR10EIX	6801
/ EC25PT /	244	B9ES	2611	0,5	B9EVX	7254	BR9EIX	3981
/ EC25PC /	244	B9ES	2611	0,5	B9EVX	7254	BR9EIX	3981
/ EC25PT-07 /	244	BR9ES	3194	0,7	BR9EVX	4318	BR9EIX	3981
EC25PM-01(244cc)	244	BR8ES	5422	0.5	BR8EVX	1262	BR8EIX	5044
EC25PS(244cc)	244	BR8ES	5422	0.5	BR8EVX	1262	BR8EIX	5044



ccm

Order  
No.Platin/  
Gold-  
PalladiumOrder  
No.

Iridium

Order  
No.**POLARIS**

Indy Star / / 1990-1985	244	BR8ES	3961	0,7	BR8EVX	1043	BR8EIX	5044
Indy Starlite / / 1995-1991	244	BR8ES	3961	0,7	BR8EVX	1043	BR8EIX	5044
EC25	250	BR8ES	5422	0.6	BR8EVX	1262	BR8EIX	5044
EC25PC(250cc)	250	B9ES	2611	0.5	B9EVX	7254	BR9EIX	3981
EC25PT(250cc)	250	B9ES	2611	0.5	B9EVX	7254	BR9EIX	3981
EC25PT-04(250cc)	250	B8ES	2411	0.5	B8EVX	7051	BR8EIX	5044
EC25PT-05(250cc)	250	B10ES	7928	0.5	B10EVX	7335	BR10EIX	6801
EC25PT-06(250cc)	250	B9ES	2611	0.5	B9EVX	7254	BR9EIX	3981
EC25PT-07(250cc)	250	BR9ES	5722	0.5	BR9EVX	1265	BR9EIX	3981
/ EC29P /	294	B7ES	1111	0,5	B7EVX	6934		
/ EC29PS /	294	BR8ES	3961	0,7	BR8EVX	1043	BR8EIX	5044
/ EC29PF /	294	B7ES	1111	0,5	B7EVX	6934		
/ EC29PM /	294	B7ES	1111	0,5	B7EVX	6934		
EC29P(294cc)	294	B7ES	1111	0.5	B7EVX	6934		
EC29PF(294cc)	294	B7ES	1111	0.5	B7EVX	6934		
EC29PM(294cc)	294	B7ES	1111	0.5	B7EVX	6934		
EC29PS(294cc)	294	B8ES	2411	0.5	B8EVX	7051	BR8EIX	5044
/ EC34PM-04-N /	333	B8ES	2411	0,5	B8EVX	7051	BR8EIX	5044
/ EC34PL-04 /	333	B10ES	7928	0,5	B10EVX	7335	BR10EIX	6801
/ EC34PL-03 /	333	B10ES	7928	0,5	B10EVX	7335	BR10EIX	6801
/ EC34PL-01 /	333	B9ES	2611	0,5	B9EVX	7254	BR9EIX	3981
/ EC34PM-04 /	333	BR9ES	3194	0,7	BR9EVX	4318	BR9EIX	3981
/ EC34PL-05 /	333	BR9ES	3194	0,7	BR9EVX	4318	BR9EIX	3981
/ EC34PL-02 /	333	BR9ES	3194	0,7	BR9EVX	4318	BR9EIX	3981
/ EC34PM-03 /	333	BR8ES	3961	0,7	BR8EVX	1043	BR8EIX	5044
EC34-2P-03	333	BR9ES	5722	0.6	BR9EVX	1265	BR9EIX	3981
EC34PL-01(333cc)	333	B9ES	2611	0.5	B9EVX	7254	BR9EIX	3981
EC34PL-02(333cc)	333	BR9ES	5722	0.5	BR9EVX	1265	BR9EIX	3981
EC34PL-03(333cc)	333	---		0.5	B10EVX	7335	BR10EIX	6801
EC34PL-04(333cc)	333	---		0.5	B10EVX	7335	BR10EIX	6801
EC34PL-05(333cc)	333	BR9ES	5722	0.5	BR9EVX	1265	BR9EIX	3981
EC34PM-03(333cc)	333	BR8ES	5422	0.5	BR8EVX	1262	BR8EIX	5044
EC34PM-04(333cc)	333	BR9ES	5722	0.5	BR9EVX	1265	BR9EIX	3981
EC34PM-04-N(333cc)	333	B8ES	2411	0.5	B8EVX	7051	BR8EIX	5044
/ EC34PT-05 /	335	BR9ES	3194	0,7	BR9EVX	4318	BR9EIX	3981
/ EC34PT-07 /	335	BR9ES	3194	0,7	BR9EVX	4318	BR9EIX	3981
/ EC34P /	335	B7ES	1111	0,5	B7EVX	6934		
/ EC34PC /	335	BR8ES	3961	0,7	BR8EVX	1043	BR8EIX	5044
/ EC34PF /	335	BR8ES	3961	0,7	BR8EVX	1043	BR8EIX	5044
/ EC34PQ /	335	BR8ES	3961	0,7	BR8EVX	1043	BR8EIX	5044
/ EC34PT-04 /	335	BR8ES	3961	0,7	BR8EVX	1043	BR8EIX	5044
/ EC34PT-06 /	335	B10ES	7928	0,5	B10EVX	7335	BR10EIX	6801
/ EC34PS /	335	BR8ES	3961	0,7	BR8EVX	1043	BR8EIX	5044
EC34-2P-02	335	BR9ES	5722	0.6	BR9EVX	1265	BR9EIX	3981
EC34-2PM-01	335	BR9ES	5722	0.6	BR9EVX	1265	BR9EIX	3981
EC34P(335cc)	335	B7ES	1111	0.5	B7EVX	6934		
EC34PF(335cc)	335	B8ES	2411	0.5	B8EVX	7051	BR8EIX	5044
EC34PR-06(335cc)	335	B10ES	7928	0.5	B10EVX	7335	BR10EIX	6801
EC34PS(335cc)	335	B8ES	2411	0.5	B8EVX	7051	BR8EIX	5044
EC34PT-04(335cc)	335	B8ES	2411	0.5	B8EVX	7051	BR8EIX	5044
EC34PT-05(335cc)	335	BR9ES	5722	0.5	BR9EVX	1265	BR9EIX	3981
EC34PT-06	335	B10ES	7928	0.5	B10EVX	7335	BR10EIX	6801



ccm

Order  
No.Platin/  
Gold-  
PalladiumOrder  
No.

Iridium

Order  
No.**POLARIS**

EC34PT-07(335cc)	335	BR9ES	5722	0.5	BR9EVX	1265	BR9EIX	3981
EC34PC(336cc)	336	B8ES	2411	0.5	B8EVX	7051	BR8EIX	5044
EC34PQ(336cc)	336	B8ES	2411	0.5	B8EVX	7051	BR8EIX	5044
EC34-2PM-02(339cc)	339	BR8ES	5422	0.7	BR8EVX	1262	BR8EIX	5044
EC34-2PME-02(339cc)	339	BR8ES	5422	0.7	BR8EVX	1262	BR8EIX	5044
Indy / / 2002-1999	339	BR8ES	3961	0,7	BR8EVX	1043	BR8EIX	5044
Indy / / 1990-1987	339	BR9ES	3194	0,7	BR9EVX	4318	BR9EIX	3981
Indy Lite / / 1998-1991	339	BR8ES	3961	0,7	BR8EVX	1043	BR8EIX	5044
Sprint / / 1990-1987	339	BR9ES	3194	0,7	BR9EVX	4318	BR9EIX	3981
340 Classic / EC34-2PM070 / 2005-2003	340	BR8ES	3961	0,7	BR8EVX	1043	BR8EIX	5044
340 Edge / EC34-2PM070 / 2005-2003	340	BR8ES	3961	0,7	BR8EVX	1043	BR8EIX	5044
Indy 340 Touring / EC34-2PM070 / 2005-2003	340	BR8ES	3961	0,7	BR8EVX	1043	BR8EIX	5044
/ EC37P /	372	BR8ES	3961	0,7	BR8EVX	1043	BR8EIX	5044
EC37P(372cc)	372	B8ES	2411	0.5	B8EVX	7051	BR8EIX	5044
/ EC40PL-01 /	398	BR9ES	3194	0,7	BR9EVX	4318	BR9EIX	3981
/ EC40P /	398	B7ES	1111	0,5	B7EVX	6934		
/ EC40PM /	398	B7ES	1111	0,5	B7EVX	6934		
/ EC40PS /	398	B10ES	7928	0,5	B10EVX	7335	BR10EIX	6801
EC40P(398cc)	398	B7ES	1111	0.5	B7EVX	6934		
EC40P-03	398	BR9ES	5722	0.6	BR9EVX	1265	BR9EIX	3981
EC40PL-01	398	BR9ES	5722	0.6	BR9EVX	1265	BR9EIX	3981
EC40PL-02/04(398cc)	398	BR8ES	5422	0.6	BR8EVX	1262	BR8EIX	5044
EC40PM(398cc)	398	B7ES	1111	0.5	B7EVX	6934		
EC40PS(398cc)	398	B10ES	7928	0.5	B10EVX	7335	BR10EIX	6801
Indy / / 1991-1985	398	BR9ES	3194	0,7	BR9EVX	4318	BR9EIX	3981
/ EC44-2PM-2100 /	432	BR9ES	3194	0,7	BR9EVX	4318	BR9EIX	3981
/ EC44PM-01 /	432	BR8ES	3961	0,7	BR8EVX	1043	BR8EIX	5044
/ EC44PM-02 /	432	BR8ES	3961	0,7	BR8EVX	1043	BR8EIX	5044
/ EC44PT-05 /	432	BR9ES	3194	0,7	BR9EVX	4318	BR9EIX	3981
/ EC44-2PM-3300 /	432	BR9ES	3194	0,7	BR9EVX	4318	BR9EIX	3981
/ EC44-2PM-1100 /	432	BR9ES	3194	0,7	BR9EVX	4318	BR9EIX	3981
/ EC44-2PM-5100 /	432	BR9ES	3194	0,7	BR9EVX	4318	BR9EIX	3981
/ EC44-2PM-5000 /	432	BR9ES	3194	0,7	BR9EVX	4318	BR9EIX	3981
/ EC44P /	432	B7ES	1111	0,5	B7EVX	6934		
/ EC44-2PM-3100 /	432	BR9ES	3194	0,7	BR9EVX	4318	BR9EIX	3981
/ EC44PT-04 /	432	B10ES	7928	0,5	B10EVX	7335	BR10EIX	6801
/ EC44PM-03 /	432	BR8ES	3961	0,7	BR8EVX	1043	BR8EIX	5044
/ EC44PQ /	432	BR8ES	3961	0,7	BR8EVX	1043	BR8EIX	5044
/ EC44PT-06 /	432	B9ES	2611	0,5	B9EVX	7254	BR9EIX	3981
/ EC44PT /	432	B10ES	7928	0,5	B10EVX	7335	BR10EIX	6801
EC34-2PM-02(432cc)	432	BR8ES	5422	0.7	BR8EVX	1262	BR8EIX	5044
EC44-2PM-1100(432cc)	432	BR9ES	5722	0.5	BR9EVX	1265	BR9EIX	3981
EC44-2PM-2100(432cc)	432	BR9ES	5722	0.5	BR9EVX	1265	BR9EIX	3981
EC44-2PM-3100(432cc)	432	BR9ES	5722	0.5	BR9EVX	1265	BR9EIX	3981
EC44-2PM-3300(432cc)	432	BR9ES	5722	0.5	BR9EVX	1265	BR9EIX	3981
EC44-2PM-4100(432cc)	432	BR9ES	5722	0.6	BR9EVX	1265	BR9EIX	3981
EC44-2PM-5000(432cc)	432	BR9ES	5722	0.5	BR9EVX	1265	BR9EIX	3981
EC44-2PM-5100(432cc)	432	BR9ES	5722	0.5	BR9EVX	1265	BR9EIX	3981
EC44-3PM-01(432cc)	432	BR8ES	5422	0.6	BR8EVX	1262	BR8EIX	5044
EC44PM-01(432cc)	432	BR8ES	5422	0.5	BR8EVX	1262	BR8EIX	5044
EC44PM-02(432cc)	432	BR8ES	5422	0.5	BR8EVX	1262	BR8EIX	5044
EC44PM-03(432cc)	432	BR8ES	5422	0.5	BR8EVX	1262	BR8EIX	5044



ccm

Order  
No.Platin/  
Gold-  
PalladiumOrder  
No.

Iridium

Order  
No.**POLARIS**

EC44PQ(432cc)	432	B8ES	2411	0.5	B8EVX	7051	BR8EIX	5044
EC44PT(432cc)	432	B10ES	7928	0.5	B10EVX	7335	BR10EIX	6801
EC44PT-04(432cc)	432	B10ES	7928	0.5	B10EVX	7335	BR10EIX	6801
EC44PT-05(432cc)	432	BR9ES	5722	0.5	BR9EVX	1265	BR9EIX	3981
EC44PT-06(432cc)	432	B9ES	2611	0.5	B9EVX	7254	BR9EIX	3981
Indy / / 1998-1995	432	BR8ES	3961	0,7	BR8EVX	1043	BR8EIX	5044
Indy / / 1994-1991	432	BR9ES	3194	0,7	BR9EVX	4318	BR9EIX	3981
Indy / / 1988-1985	432	BR9ES	3194	0,7	BR9EVX	4318	BR9EIX	3981
Indy SKS / / 1995-1993	432	BR9ES	3194	0,7	BR9EVX	4318	BR9EIX	3981
Indy Sport / / 1999-1998	432	BR8ES	3961	0,7	BR8EVX	1043	BR8EIX	5044
Indy Sport / / 1997-1995	432	BR9ES	3194	0,7	BR9EVX	4318	BR9EIX	3981
Indy Super Sport / / 1996-1991	432	BR9ES	3194	0,7	BR9EVX	4318	BR9EIX	3981
Indy Tran Sport / / 1997-1996	432	BR9ES	3194	0,7	BR9EVX	4318	BR9EIX	3981
Indy Tran Sport / / 1999-1998	432	BR8ES	3961	0,7	BR8EVX	1043	BR8EIX	5044
Indy XCF Edge / / 1998	432	BR8ES	3961	0,7	BR8EVX	1043	BR8EIX	5044
Indy XCF Edge / / 1997	432	BR9ES	3194	0,7	BR9EVX	4318	BR9EIX	3981
/ EC45PL-01 /	436	B10ES	7928	0,5	B10EVX	7335	BR10EIX	6801
EC44P(436cc)	436	B7ES	1111	0.5	B7EVX	6934		
EC44PS(436cc)	436	B10ES	7928	0.5	B10EVX	7335	BR10EIX	6801
440 IQ / / 2005	438	BPR9ES	7788	0,7	BPR9EVX	5576		
Indy Pro X / / 2004-2001	438	BPR9ES	7788	0,7	BPR9EVX	5576		
Indy Pro X Fan / / 2003-2002	438	BR9ES	3194	0,7	BR9EVX	4318	BR9EIX	3981
Indy XCF Edge / / 2001-1999	438	BR9ES	3194	0,7	BR9EVX	4318	BR9EIX	3981
EC45PL-07(439cc)	439	BR8ES	5422	0.7	BR8EVX	1262	BR8EIX	5044
EC45PL-08(439cc)	439	BR8ES	5422	0.7	BR8EVX	1262	BR8EIX	5044
EC45PL-08(439cc)	439	BR9ES	5722	0.6	BR9EVX	1265	BR9EIX	3981
EC45PL-09(439cc)	439	BR8ES	5422	0.7	BR8EVX	1262	BR8EIX	5044
EC45PL-09(439cc)	439	BR8ES	5422	0.6	BR8EVX	1262	BR8EIX	5044
Indy LC / / 1997	439	BR8ES	3961	0,7	BR8EVX	1043	BR8EIX	5044
Indy XC / / 1997	439	BR9ES	3194	0,7	BR9EVX	4318	BR9EIX	3981
Indy XCR / / 1998-1996	439	BR9ES	3194	0,7	BR9EVX	4318	BR9EIX	3981
Indy XCR / / 1996-1995	439	BR9ES	3194	0,7	BR9EVX	4318	BR9EIX	3981
/ EC50PL-03 /	488	BR9ES	3194	0,7	BR9EVX	4318	BR9EIX	3981
/ EC5-PM-02 /	488	BR9ES	3194	0,7	BR9EVX	4318	BR9EIX	3981
/ EC5-PM-01 /	488	BR9ES	3194	0,7	BR9EVX	4318	BR9EIX	3981
/ EC50PL-02 /	488	BR9ES	3194	0,7	BR9EVX	4318	BR9EIX	3981
/ EC50PL-01 /	488	BR9ES	3194	0,7	BR9EVX	4318	BR9EIX	3981
/ EC5-PM-03 /	488	BR9ES	3194	0,7	BR9EVX	4318	BR9EIX	3981
/ EC50P /	488	B7ES	1111	0.5	B7EVX	6934		
EC50P(488cc)	488	B7ES	1111	0.5	B7EVX	6934		
EC50PL-01/02/04/05/06/(488cc)	488	BR8ES	5422	0.6	BR8EVX	1262	BR8EIX	5044
EC50PL-16/17/18/19/20(488cc)	488	BR8ES	5422	0.6	BR8EVX	1262	BR8EIX	5044
EC50PM-01/02/03/04/05/06(488cc)	488	BR8ES	5422	0.6	BR8EVX	1262	BR8EIX	5044
Indy / / 2005	488	BR8ES	3961	0,7	BR8EVX	1043	BR8EIX	5044
Indy / / 2002-1991	488	BR8ES	3961	0,7	BR8EVX	1043	BR8EIX	5044
Indy Classic / / 2002-1995	488	BR8ES	3961	0,7	BR8EVX	1043	BR8EIX	5044
Indy RMK / / 1999-1996	488	BR8ES	3961	0,7	BR8EVX	1043	BR8EIX	5044
Indy SKS / / 1997-1995	488	BR8ES	3961	0,7	BR8EVX	1043	BR8EIX	5044
Indy Super Sport / / 1998-1997	488	BR8ES	3961	0,7	BR8EVX	1043	BR8EIX	5044
Indy Trail / / 1999-1998	488	BR8ES	3961	0,7	BR8EVX	1043	BR8EIX	5044
Indy Trail / / 1997-1995	488	BR9ES	3194	0,7	BR9EVX	4318	BR9EIX	3981
Indy Trail RMK / / 1999-1997	488	BR8ES	3961	0,7	BR8EVX	1043	BR8EIX	5044



ccm

Order  
No.Platin/  
Gold-  
PalladiumOrder  
No.

Iridium

Order  
No.**POLARIS**

Indy Widetrack GT / / 1997-1995	488	BR9ES	3194	0,7	BR9EVX	4318	BR9EIX	3981
Indy Widetrack LX / / 2002-1995	488	BR8ES	3961	0,7	BR8EVX	1043	BR8EIX	5044
/ EC51PL-01 /	500	BR9ES	3194	0,7	BR9EVX	4318	BR9EIX	3981
/ EC51PL /	500	BR9ES	3194	0,7	BR9EVX	4318	BR9EIX	3981
/ EC51PT /	500	B9ES	2611	0,5	B9EVX	7254	BR9EIX	3981
/ EC51PT-04 /	500	B8ES	2411	0,5	B8EVX	7051	BR8EIX	5044
/ EC51PS /	500	B10ES	7928	0,5	B10EVX	7335	BR10EIX	6801
500 Classic / EC50PL214 / 2005-2004	500	BR8ES	3961	0,7	BR8EVX	1043	BR8EIX	5044
500 Classic / S504403 / 2003	500	BPR9ES	7788	0,7	BPR9EVX	5576		
500 Edge / EC50PL214 / 2004-2003	500	BR8ES	3961	0,7	BR8EVX	1043	BR8EIX	5044
500 XC SP Edge / S2650-5044-PR5C / 2005-2003	500	BPR9ES	7788	0,7	BPR9EVX	5576		
EC51PL-01(500cc)	500	BR9ES	5722	0,5	BR9EVX	1265	BR9EIX	3981
EC51PL-02(500cc)	500	BR9ES	5722	0,5	BR9EVX	1265	BR9EIX	3981
EC51PS(500cc)	500	B10ES	7928	0,5	B10EVX	7335	BR10EIX	6801
EC51PT(500cc)	500	B9ES	2611	0,5	B9EVX	7254	BR9EIX	3981
EC51PT-04(500cc)	500	B8ES	2411	0,5	B8EVX	7051	BR8EIX	5044
Indy RMK / / 2002-2000	500	BR9ES	3194	0,7	BR9EVX	4318	BR9EIX	3981
Indy XC / / 2000-1999	500	BR9ES	3194	0,7	BR9EVX	4318	BR9EIX	3981
Indy XC / / 2002-2001	500	BPR9ES	7788	0,7	BPR9EVX	5576		
Indy XC SP 45 Anniv. / / 2000	500	BPR9ES	7788	0,7	BPR9EVX	5576		
Wide Trak LX / EC50PL234 / 2005-2003	500	BR8ES	3961	0,7	BR8EVX	1043	BR8EIX	5044
/ EC54PM /	530	BR8ES	3961	0,7	BR8EVX	1043	BR8EIX	5044
/ EC54P /	530	BR8ES	3961	0,7	BR8EVX	1043	BR8EIX	5044
EC54P(530cc)	530	B8ES	2411	0,5	B8EVX	7051	BR8EIX	5044
EC54PM(530cc)	530	B8ES	2411	0,5	B8EVX	7051	BR8EIX	5044
EC60PL-01(530cc)	530	BR9ES	5722	0,5	BR9EVX	1265	BR9EIX	3981
EC60PL-02	530	BR9ES	5722	0,6	BR9EVX	1265	BR9EIX	3981
Indy 550 Classic / / 2002	544	BR9ES	3194	0,7	BR9EVX	4318	BR9EIX	3981
Indy Sport Touring / EC55PM090 / 2005-2000	544	BR9ES	3194	0,7	BR9EVX	4318	BR9EIX	3981
Indy Super Sport / EC55PM061 / 1999	544	BR8ES	3961	0,7	BR8EVX	1043	BR8EIX	5044
Indy Super Sport / / 2005-2000	544	BR9ES	3194	0,7	BR9EVX	4318	BR9EIX	3981
Indy Trail RMK / EC55PM070 / 2005-1999	544	BR9ES	3194	0,7	BR9EVX	4318	BR9EIX	3981
Indy Trail Touring / / 2000	544	BR8ES	3961	0,7	BR8EVX	1043	BR8EIX	5044
Indy Trail Touring / EC55PM090 / 2005-2002	544	BR9ES	3194	0,7	BR9EVX	4318	BR9EIX	3981
550 Classic Edge / EC55PM061 / 2005-2003	550	BR9ES	3194	0,7	BR9EVX	4318	BR9EIX	3981
550 Pro X / EC55PM080 / 2004	550	BR9ES	3194	0,7	BR9EVX	4318	BR9EIX	3981
Indy XLT / / 1994-1993	579	BR9ES	3194	0,7	BR9EVX	4318	BR9EIX	3981
Indy Classic / / 2002-2001	593	BPR9ES	7788	0,7	BPR9EVX	5576		
Indy RMK / / 2002-2000	593	BPR9ES	7788	0,7	BPR9EVX	5576		
Indy RMK / / 1999-1998	593	BR9ES	3194	0,7	BR9EVX	4318	BR9EIX	3981
Indy Touring / / 2002-1998	593	BPR9ES	7788	0,7	BPR9EVX	5576		
Indy XC / / 1999-1997	593	BR9ES	3194	0,7	BR9EVX	4318	BR9EIX	3981
Indy XC / / 2002-2000	593	BPR9ES	7788	0,7	BPR9EVX	5576		
EC58PL-02/03/07(597cc)	597	BR8ES	5422	0,7	BR8EVX	1262	BR8EIX	5044
EC58PL-08/09/012(597cc)	597	BR9ES	5722	0,7	BR9EVX	1265	BR9EIX	3981
EC59PL-01(597cc)	597	BR9ES	5722	0,7	BR9EVX	1265	BR9EIX	3981
Indy / / 1987-1984	597	BR9ES	3194	0,7	BR9EVX	4318	BR9EIX	3981
Indy Triumph / / 2000	597	BR9ES	3194	0,7	BR9EVX	4318	BR9EIX	3981



ccm

Order  
No.Platin/  
Gold-  
PalladiumOrder  
No.

Iridium

Order  
No.**POLARIS**

Indy XCR / / 1998-1995	597	BR9ES	3194	0,7	BR9EVX	4318	BR9EIX	3981
Indy XLT / / 1999-1995	597	BR8ES	3961	0,7	BR8EVX	1043	BR8EIX	5044
Indy XLT SP / / 1999-1997	597	BR9ES	3194	0,7	BR9EVX	4318	BR9EIX	3981
Classic Edge / S2652-6044-PR6E / 2005-2003	600	BPR9ES	7788	0,7	BPR9EVX	5576		
Classic Touring / S2653-6044-PR6E / 2005-2003	600	BPR9ES	7788	0,7	BPR9EVX	5576		
Pro X / S2392-6044PA6E / 2004-2001	600	BPR9ES	7788	0,7	BPR9EVX	5576		
Pro X2 / S2392-6044PA6E / 2004	600	BPR9ES	7788	0,7	BPR9EVX	5576		
RMK / S2474-6044-PR6E / 2005-2003	600	BPR9ES	7788	0,7	BPR9EVX	5576		
Switchback / S2587-6044-PR6E / 2005-2004	600	BPR9ES	7788	0,7	BPR9EVX	5576		
XC SP Edge / S2652-6044-PR6E / 2005-2003	600	BPR9ES	7788	0,7	BPR9EVX	5576		
EC65PL-01/02/03/05(648cc)	648	BR9ES	5722	0.6	BR9EVX	1265	BR9EIX	3981
Indy / / 1994-1988	648	BR9ES	3194	0,7	BR9EVX	4318	BR9EIX	3981
Indy RXL / / 1997-1995	648	BR9ES	3194	0,7	BR9EVX	4318	BR9EIX	3981
EC66PL-01(679cc)	679	BR8ES	5422	0.7	BR8EVX	1262	BR8EIX	5044
EC66PL-04(679cc)	679	BR8ES	5422	0.7	BR8EVX	1262	BR8EIX	5044
EC68PL-01/03/04(679cc)	679	BR9ES	5722	0.7	BR9EVX	1265	BR9EIX	3981
Indy Ultra / / 1998-1996	679	BR9ES	3194	0,7	BR9EVX	4318	BR9EIX	3981
Indy XCR / / 1998	679	BR9ES	3194	0,7	BR9EVX	4318	BR9EIX	3981
700 Classic Edge / S2469-7070-PR7C / 2004-2003	700	BPR9ES	7788	0,7	BPR9EVX	5576		
700 Classic Touring / S2472-7070-PR7C / 2004-2003	700	BPR9ES	7788	0,7	BPR9EVX	5576		
700 Pro X / S2464-7070-PR7C / 2004-2003	700	BPR9ES	7788	0,7	BPR9EVX	5576		
700 Pro X2 / S2464-7070-PR7C / 2004-2003	700	BPR9ES	7788	0,7	BPR9EVX	5576		
700 RMK / S2471-7070-PR7C / 2005-2003	700	BPR9ES	7788	0,7	BPR9EVX	5576		
700 Switchback / S2472-7070-PR7C / 2004	700	BPR9ES	7788	0,7	BPR9EVX	5576		
700 XC SP Edge / S2469-7070-PR7C / 2005-2003	700	BPR9ES	7788	0,7	BPR9EVX	5576		
Indy XCR / / 1999	700	BR9ES	3194	0,7	BR9EVX	4318	BR9EIX	3981
Indy Classic / / 2002-2001	701	BPR9ES	7788	0,7	BPR9EVX	5576		
Indy RMK / / 1999-1997	701	BR9ES	3194	0,7	BR9EVX	4318	BR9EIX	3981
Indy RMK / / 2002-2000	701	BPR9ES	7788	0,7	BPR9EVX	5576		
Indy SKS / / 2003-2000	701	BPR9ES	7788	0,7	BPR9EVX	5576		
Indy SKS / / 1999-1997	701	BR9ES	3194	0,7	BR9EVX	4318	BR9EIX	3981
Indy XC / / 1999-1998	701	BR9ES	3194	0,7	BR9EVX	4318	BR9EIX	3981
Indy XC Edge / / 2004-2000	701	BPR9ES	7788	0,7	BPR9EVX	5576		
SN70LCDSP-01/02(701cc) / EC74P /	701 744	BR9ES B7ES	5722 1111	0.7 0,5	BR9EVX B7EVX	1265 6934	BR9EIX	3981
EC74P(744cc)	744	B7ES	1111	0.5	B7EVX	6934		
Indy Storm / / 1993	744	BR9ES	3194	0,7	BR9EVX	4318	BR9EIX	3981
Frontier Classic / S-2466-7868-PR7D / 2004-2003	780	BKR5ES	2460	0,8	BKR5EVX	2546	BKR5EIX	6341
Frontier Touring / S-2466-7868-PR7D / 2004-2003	780	BKR5ES	2460	0,8	BKR5EVX	2546	BKR5EIX	6341



ccm

Order  
No.Platin/  
Gold-  
PalladiumOrder  
No.

Iridium

Order  
No.**POLARIS**

EC80P(792cc)	792	B7ES	1111	0.5	B7EVX	6934		
EC80PL-04(794cc)	794	BR7ES	5122	0.7	BR7EVX	4556		
EC80PL-05(794cc)	794	BR7ES	5122	0.7	BR7EVX	4556		
Indy 800 SKS / / 2004-2003	794	BPR9ES	7788	0,7	BPR9EVX	5576		
Indy Frontier Touring / / 2005-2002	794	BKR7E	6097	0,7			BKR7EIX	2667
Indy LE / / 2001	794	BPR9ES	7788	0,7	BPR9EVX	5576		
Indy RMK / S2462-8070-PR8C / 2005-2000	794	BPR9ES	7788	0,7	BPR9EVX	5576		
Indy Storm / / 1998-1994	794	BR9ES	3194	0,7	BR9EVX	4318	BR9EIX	3981
Indy Storm RMK / / 1997	794	BR9ES	3194	0,7	BR9EVX	4318	BR9EIX	3981
Indy Storm SKS / / 1996-1994	794	BR8ES	3961	0,7	BR8EVX	1043	BR8EIX	5044
Indy XC SP / S2470-8070-PR8C / 2005-2001	794	BPR9ES	7788	0,7	BPR9EVX	5576		
Indy XCR / / 2003-1999	794	BR9ES	3194	0,7	BR9EVX	4318	BR9EIX	3981
800 Classic Edge / S2470-8070-PR8C / 2005-2004	800	BPR9ES	7788	0,7	BPR9EVX	5576		
800 Classic Touring / S2473-8070-PR8C / 2005-2003	800	BPR9ES	7788	0,7	BPR9EVX	5576		
800 Pro X / S2470-8070-PR8C / 2004-2003	800	BPR9ES	7788	0,7	BPR9EVX	5576		
800 Pro X2 / S2470-8070-PR8C / 2004	800	BPR9ES	7788	0,7	BPR9EVX	5576		
800 Pro XR / S2461-8070-PR8C / 2004	800	BPR9ES	7788	0,7	BPR9EVX	5576		
800 Switchback / S2473-8070-PR8C / 2005-2004	800	BPR9ES	7788	0,7	BPR9EVX	5576		
Fusion / Liberty Engine / 2005-2004	900	BPR9ES	7788	0,7	BPR9EVX	5576		
RMK / / 2005	900	BPR9ES	7788	0,7	BPR9EVX	5576		
Switchback / / 2005	900	BPR9ES	7788	0,7	BPR9EVX	5576		

**ROLL-O-FLEX (YAMAHA)**

292S(292cc)	292	---		0.4	B9EVX	7254	BR9EIX	3981
292Y(292cc)	292	B8ES	2411	0.6	B8EVX	7051	BR8EIX	5044
338S(338cc)	338	---		0.4	B9EVX	7254	BR9EIX	3981
338Y(338cc)	338	B7HS	5110	0.6	B7HVX	7836	BR7HIX	7067
396Y(396cc)	396	B7HS	5110	0.6	B7HVX	7836	BR7HIX	7067
433S(433cc)	433	---		0.4	B9EVX	7254	BR9EIX	3981
433Y(433cc)	433	B7HS	5110	0.6	B7HVX	7836	BR7HIX	7067

**ROLL-O-FLEX (YAMAHA)**

With CDI Systems 12.7mm(1/2") Reach		BUHX	2522	-				
With CDI Systems 19.0mm(3/4") Reach		BUE	2322	-				
TR-295(294cc)	294	B8HS	5510	0.5	B8HVX	2634	BR8HIX	7001
TR-295S(294cc)	294	B9HS	5810	0.5	B9HVX	2254		
TR-340(336cc)	336	B8HS	5510	0.5	B8HVX	2634	BR8HIX	7001
TR-340S(336cc)	336	B9HS	5810	0.5	B9HVX	2254		
TR-400S(339cc)	339	B8HS	5510	0.5	B8HVX	2634	BR8HIX	7001
TR-440(438cc)	438	B8HS	5510	0.5	B8HVX	2634	BR8HIX	7001
TR-440S(438cc)	438	B9HS	5810	0.5	B9HVX	2254		
TR-650(644cc)	644	B9HS	5810	0.5	B9HVX	2254		
TR-650S(644cc)	644	B9HS	5810	0.5	B9HVX	2254		

**SACHS**

SA280, SA280A(277cc)	277	A7	1110	0.5				
SA2-290 12.7mm(1/2") Reach(291cc)	291	B8HS	5510	0.5	B8HVX	2634	BR8HIX	7001
SA2-290 19.0mm(3/4") Reach(291cc)	291	B8ES	2411	0.5	B8EVX	7051	BR8EIX	5044
SA290(293cc)	293	A7	1110	0.5				



ccm

Order  
No.Platin/  
Gold-  
PalladiumOrder  
No.

Iridium

Order  
No.**SACHS**

SA290C, SA290R, SA290SS(293cc)	293	B8HS	5510	0.5	B8HVX	2634	BR8HIX	7001
KM914(300cc)	300	B7HS	5110	0.5	B7HVX	7836	BR7HIX	7067
SA320(318cc)	318	A7	1110	0.5				
SA340C, SA340R(334cc)	334	B8HS	5510	0.5	B8HVX	2634	BR8HIX	7001
SA340(336cc)	336	A7	1110	0.5				
SA340SS(336cc)	336	A8	1210	0.5				
SA2-340 12.7mm(1/2") Reach(338cc)	338	B8HS	5510	0.5	B8HVX	2634	BR8HIX	7001
SA2-340 19.0mm(3/4") Reach(338cc)	338	B8ES	2411	0.5	B8EVX	7051	BR8EIX	5044
SA2-340RX, SA2-340C(338cc)	338	B9ES	2611	0.5	B9EVX	7254	BR9EIX	3981
SA370(368cc)	368	A7	1110	0.5				
SA400(396cc)	396	A8	1210	0.5				

**SCORPION (Cuyuna Engine)**

295(290cc)	290	B8ES	2411	0.5	B8EVX	7051	BR8EIX	5044
2F295-2(294cc) 1978	294	B9ES	2611	0.5	B9EVX	7254	BR9EIX	3981
2F295-2(294cc) 1979	294	B7ES	1111	0.5	B7EVX	6934		
2F340-6(338cc)	338	B8ES	2411	0.5	B8EVX	7051	BR8EIX	5044
2F340-6(338cc) 1979	338	B7ES	1111	0.5	B7EVX	6934		
2F340-6(338cc) 1980	338	BR7ES	5122	0.5	BR7EVX	4556		
340(339cc)	339	B8ES	2411	0.5	B8EVX	7051	BR8EIX	5044
400(339cc)	339	B8ES	2411	0.5	B8EVX	7051	BR8EIX	5044
2F400-A(399cc)	399	B8ES	2411	0.5	B8EVX	7051	BR8EIX	5044
2F440-A(428cc)	428	B8ES	2411	0.5	B8EVX	7051	BR8EIX	5044
440(428cc)	428	B8ES	2411	0.5	B8EVX	7051	BR8EIX	5044

**SCORPION (Spirit Suzuki Eng)**

AF44L3(436cc)	436	BR9ES	5722	0.5	BR9EVX	1265	BR9EIX	3981
---------------	-----	-------	------	-----	--------	------	--------	------

**SKI-DOO**

Mini Z 1998-2004	120	BPR6ES	7822	0,6	BPR6EVX	6764	BPR6EIX	6637
Citation 1985-1992	250	BR9ES	3194	0,7	BR9EVX	4318	BR9EIX	3981
Citation 3500 1980-1984	277	BR8ES	3961	0,8	BR8EVX	1043	BR8EIX	5044
Skandic 1983	277	BR8ES	3961	0,8	BR8EVX	1043	BR8EIX	5044
Skandic 2002	277	BR9ES	3194	0,7	BR9EVX	4318	BR9EIX	3981
Tundra 1993-1997	277	BR9ES	3194	0,7	BR9EVX	4318	BR9EIX	3981
Tundra 1998-2000	277	BR10ES	4684	0,8			BR10EIX	6801
Tundra 2003-	277	BR9ES	3194	0,7	BR9EVX	4318	BR9EIX	3981
Skanic Tundra LC 2003-2004	280	BR9ECS	3570	0,5				
Formula 1987-2001	380	BR9ES	3194	0,7	BR9EVX	4318	BR9EIX	3981
Grand Touring 2002-2003	380	BR9ES	3194	0,7	BR9EVX	4318	BR9EIX	3981
Legend 2002-2004	380	BR9ES	3194	0,7	BR9EVX	4318	BR9EIX	3981
MXZ Fan 2001-2004	380	BR9ES	3194	0,7	BR9EVX	4318	BR9EIX	3981
Skandic 1993-2000	380	BR9ES	3194	0,7	BR9EVX	4318	BR9EIX	3981
Skanic II 1992	380	BR9ES	3194	0,7	BR9EVX	4318	BR9EIX	3981
Touring 1985-2002	380	BR9ES	3194	0,7	BR9EVX	4318	BR9EIX	3981
Alpine 1970	399	B7HS	5110	0,8	B7HVX	7836	BR7HIX	7067
Alpine 1971	399	AB-7	3010	0,5				
Nordic 1970	399	B7HS	5110	0,8	B7HVX	7836	BR7HIX	7067
Nordic 1971	399	AB-7	3010	0,5				
Blizzard 9500 1980-1982	440	BR9ES	3194	0,7	BR9EVX	4318	BR9EIX	3981
Blizzard 9500 1979	440	BR10ES	4684	0,8			BR10EIX	6801
Elite 1973-1975	440	AB-7	3010	0,5				





ccm

Order  
No.Platin/  
Gold-  
PalladiumOrder  
No.

Iridium

Order  
No.**SKI-DOO**

Everest	1974-1979	440	A8	1210	0,7				
MXZ	1995-2003	440	BR9ES	3194	0,7	BR9EVX	4318	BR9EIX	3981
Nordic	1972	440	AB-7	3010	0,5				
Nordik 50	1988-1991	440	BR9ES	3194	0,7	BR9EVX	4318	BR9EIX	3981
Olympique	1976	440	B7HS	5110	0,8	B7HVX	7836	BR7HIX	7067
Olympique	1973-1974	440	AB-7	3010	0,5				
Olympique	1977	440	A8	1210	0,7				
Safari	1990-1992	440	BR9ES	3194	0,7	BR9EVX	4318	BR9EIX	3981
Safari	1984-1986	440	BR9ES	3194	0,7	BR9EVX	4318	BR9EIX	3981
Skandic	2003-2004	440	BR9ECS	3570	0,5				
Skandic	2001-2002	440	BR9ES	3194	0,7	BR9EVX	4318	BR9EIX	3981
TNT	1971-1978	440	A8	1210	0,7				
TNT FA	1974-1977	440	BR8ES	3961	0,8	BR8EVX	1043	BR8EIX	5044
Touring LE	1995-2000	440	BR9ES	3194	0,7	BR9EVX	4318	BR9EIX	3981
Valmont	1972-1973	440	AB-7	3010	0,5				
Elite	1978-1980	444	BR8ES	3961	0,8	BR8EVX	1043	BR8EIX	5044
Everest LC	1978-1979	444	BR8ES	3961	0,8	BR8EVX	1043	BR8EIX	5044
Elite 464	1982	470	B7HS	5110	0,8	B7HVX	7836	BR7HIX	7067
Elite 464	1981	470	BR8ES	3961	0,8	BR8EVX	1043	BR8EIX	5044
Everest 464	1980-1983	470	BR8ES	3961	0,8	BR8EVX	1043	BR8EIX	5044
Formula	1987-1994	470	BR9ES	3194	0,7	BR9EVX	4318	BR9EIX	3981
Formula	1985-1986	470	BR9ES	3194	0,7	BR9EVX	4318	BR9EIX	3981
Formula SP	1985-1986	470	BR8ES	3961	0,8	BR8EVX	1043	BR8EIX	5044
Formula SS	1985-1986	470	BR8ES	3961	0,8	BR8EVX	1043	BR8EIX	5044
Grand Touring	1995	470	BR9ES	3194	0,7	BR9EVX	4318	BR9EIX	3981
MX	1994-1995	470	BR9ES	3194	0,7	BR9EVX	4318	BR9EIX	3981
MXZ	1994	470	BR9ES	3194	0,7	BR9EVX	4318	BR9EIX	3981
Safari	1990-1992	470	BR9ES	3194	0,7	BR9EVX	4318	BR9EIX	3981
SS 25th Anniversary	1984	470	BR8ES	3961	0,8	BR8EVX	1043	BR8EIX	5044
Summit 470	1994	470	BR9ES	3194	0,7	BR9EVX	4318	BR9EIX	3981
Alpine 503	1983-1987	500	BR7ES	5122	0,7	BR7EVX	4556		
Alpine II	1988-1994	500	BR8ES	3961	0,8	BR8EVX	1043	BR8EIX	5044
Alpine II	1993	500	BR9ES	3194	0,7	BR9EVX	4318	BR9EIX	3981
Alpine II	1995	500	BR8ES	3961	0,8	BR8EVX	1043	BR8EIX	5044
Alpine IV	1990	500	DR7EA	7839	0,6				
Blizzard 5500 MX	1984-	500	BR7ES	5122	0,7	BR7EVX	4556		
Blizzard 5500 MX	1979-1983	500	BR8ES	3961	0,8	BR8EVX	1043	BR8EIX	5044
Cheyenne	1989-1992	500	BR9ES	3194	0,7	BR9EVX	4318	BR9EIX	3981
Escapade	1987-1989	500	BR9ES	3194	0,7	BR9EVX	4318	BR9EIX	3981
Everest	1980-1981	500	BR8ES	3961	0,8	BR8EVX	1043	BR8EIX	5044
Everest	1982-1983	500	BR7ES	5122	0,7	BR7EVX	4556		
Formula	1997-1998	500	BR9ES	3194	0,7	BR9EVX	4318	BR9EIX	3981
Formula Deluxe	1999-2000	500	BR9ES	3194	0,7	BR9EVX	4318	BR9EIX	3981
Formula Deluxe F/C	2001-	500	BR9ES	3194	0,7	BR9EVX	4318	BR9EIX	3981
Formula Deluxe LC	2001-	500	BR9ES	3194	0,7	BR9EVX	4318	BR9EIX	3981
Formula SL	1987-1999	500	BR9ES	3194	0,7	BR9EVX	4318	BR9EIX	3981
Formula SLS	1996	500	BR9ES	3194	0,7	BR9EVX	4318	BR9EIX	3981
Formula Z	1999-2000	500	BR9ES	3194	0,7	BR9EVX	4318	BR9EIX	3981
Grand Touring	1996-2001	500	BR9ES	3194	0,7	BR9EVX	4318	BR9EIX	3981
Grand Touring Fan	2002-2003	500	BR9ES	3194	0,8	BR9EVX	4318	BR9EIX	3981
Grand Touring LC	2002-	500	BR9ECS	3570	0,5				
GSX	2004-	500	BR9ECS	3570	0,5				



ccm

Order  
No.Platin/  
Gold-  
PalladiumOrder  
No.

Iridium

Order  
No.**SKI-DOO**

Legend Fan	2002-	500	BR9ES	3194	0,7	BR9EVX	4318	BR9EIX	3981
Legend LC	2002-2004	500	BR9ECS	3570	0,5				
MXZ Fan	1998-2003	500	BR9ES	3194	0,7	BR9EVX	4318	BR9EIX	3981
MXZ LC	2022-2004	500	BR9ECS	3570	0,5				
Nordik 60	1987-1991	500	BR8ES	3961	0,8	BR8EVX	1043	BR8EIX	5044
Safari Voyager	1987-1994	500	BR9ES	3194	0,7	BR9EVX	4318	BR9EIX	3981
Skandic	1987	500	BR9ES	3194	0,7	BR9EVX	4318	BR9EIX	3981
Skandic	1993-2003	500	BR9ES	3194	0,7	BR9EVX	4318	BR9EIX	3981
Skandic LC	1997-2000	500	BR9ES	3194	0,7	BR9EVX	4318	BR9EIX	3981
Skandic LC	2002-2003	500	BR9ECS	3570	0,5				
Stratos	1987-1989	500	BR9ES	3194	0,7	BR9EVX	4318	BR9EIX	3981
Summit	1996-1999	500	BR9ES	3194	0,7	BR9EVX	4318	BR9EIX	3981
Summit Fan	2001-2003	500	BR9ES	3194	0,7	BR9EVX	4318	BR9EIX	3981
Touring Fan	1995-2001	500	BR9ES	3194	0,7	BR9EVX	4318	BR9EIX	3981
Touring LC	1995-2000	500	BR9ES	3194	0,7	BR9EVX	4318	BR9EIX	3981
Blizzard 9700	1984-1993	520	BR8ES	3961	0,7			BR8EIX	6747
Formula Mach I	1989-1990	520	BR9ES	3194	0,7	BR9EVX	4318	BR9EIX	3981
Formula Plus	1985-1992	520	BR9ES	3194	0,7	BR9EVX	4318	BR9EIX	3981
Safari LC	1985-1986	520	BR8ES	3961	0,8	BR8EVX	1043	BR8EIX	5044
Grand Touring FC	2002-2003	550	BR9ES	3194	0,7	BR9EVX	4318	BR9EIX	3981
Legend FC	2003-2004	550	BR9ES	3194	0,7	BR9EVX	4318	BR9EIX	3981
MXZ	2004-	550	BR9ECS	3570	0,5				
Skanic	2004-	550	BR9ECS	3570	0,5				
Summit FC	2003-2004	550	BR9ES	3194	0,7	BR9EVX	4318	BR9EIX	3981
Formula Deluxe	1999-2000	583	BR9ES	3194	0,7	BR9EVX	4318	BR9EIX	3981
Formula STX	1989-1998	583	BR9ES	3194	0,7	BR9EVX	4318	BR9EIX	3981
Formula Z	1989-2000	583	BR9ES	3194	0,7	BR9EVX	4318	BR9EIX	3981
Grand Touring	1993-2000	583	BR9ES	3194	0,7	BR9EVX	4318	BR9EIX	3981
MXZ	1994-1998	583	BR9ES	3194	0,7	BR9EVX	4318	BR9EIX	3981
Plus	1993	583	BR9ES	3194	0,7	BR9EVX	4318	BR9EIX	3981
Summit	1994-1998	583	BR9ES	3194	0,7	BR9EVX	4318	BR9EIX	3981
Formula	1998-2001	600	BR9ES	3194	0,7	BR9EVX	4318	BR9EIX	3981
Formula III	1996-1997	600	BR10ES	4684	0,8			BR10EIX	6801
Grand Touring	2002-2003	600	BR9ECS	3570	0,5				
Grand Touring	2000-2001	600	BR9ES	3194	0,7	BR9EVX	4318	BR9EIX	3981
GSX	2004-	600	BR9ECS	3570	0,5				
Legend	2004-	600	BR9ECS	3570	0,5				
Legend	2002-2003	600	BR9ECS	3570	0,5				
MXZ	1999-2001	600	BR9ES	3194	0,7	BR9EVX	4318	BR9EIX	3981
MXZ	2004-	600	BR9ECS	3570	0,5				
MXZ	2002-2003	600	BR9ECS	3570	0,5				
Skandic LC	2004-	600	BR9ECS	3570	0,5				
Skandic LC	-2001	600	BR9ES	3194	0,7	BR9EVX	4318	BR9EIX	3981
Skandic LC	2002-2003	600	BR9ECS	3570	0,5				
Summit	2004-	600	BR9ECS	3570	0,5				
Summit	1999-2001	600	BR9ES	3194	0,7	BR9EVX	4318	BR9EIX	3981
Summit	2002-2003	600	BR9ECS	3570	0,5				
Formula Mach I	1991-1992	620	BR9ES	3194	0,7	BR9EVX	4318	BR9EIX	3981
Alpine	1991-1992	640	BR8ES	3961	0,8	BR8EVX	1043	BR8EIX	5044
Alpine	1970-1972	640	A8	1210	0,7				
Alpine	1973-1978	640	AB-7	3010	0,5				
Alpine	1978	640	B7HS	5110	0,8	B7HVX	7836	BR7HIX	7067



ccm

Order  
No.Platin/  
Gold-  
PalladiumOrder  
No.

Iridium

Order  
No.**SKI-DOO**

Alpine	1982	640	BR8ES	3961	0,8	BR8EVX	1043	BR8EIX	5044
Alpine	1993-1995	640	BR8ES	3961	0,8	BR8EVX	1043	BR8EIX	5044
Alpine	1979-1981	640	AB-7	3010	0,5				
Nordic	1970-1972	640	A8	1210	0,7				
Nordic	1973-1974	640	AB-7	3010	0,5				
TNT	1970-1972	640	A8	1210	0,7				
Valmont	1971	640	A8	1210	0,7				
Formula	1994-1996	670	BR9ES	3194	0,7	BR9EVX	4318	BR9EIX	3981
Formula	1998-2000	670	BR9ES	3194	0,7	BR9EVX	4318	BR9EIX	3981
Formula III	1996-1997	670	BR10ES	4684	0,8			BR10EIX	6801
Grand Touring SE	1995-1997	670	BR9ES	3194	0,7	BR9EVX	4318	BR9EIX	3981
Mach I	1996-1997	670	BR10ES	4684	0,8			BR10EIX	6801
Mach I	1993-1995	670	BR9ES	3194	0,7	BR9EVX	4318	BR9EIX	3981
Mach I	1998-	670	BR9ES	3194	0,7	BR9EVX	4318	BR9EIX	3981
MXZ	1994-	670	BR9ES	3194	0,7	BR9EVX	4318	BR9EIX	3981
MXZ H.O.	1997-1999	670	BR9ES	3194	0,7	BR9EVX	4318	BR9EIX	3981
Summit	1995-1999	670	BR9ES	3194	0,7	BR9EVX	4318	BR9EIX	3981
Formula	1998-2001	700	BR9ES	3194	0,7	BR9EVX	4318	BR9EIX	3981
Grand Touring	1998-2001	700	BR9ES	3194	0,7	BR9EVX	4318	BR9EIX	3981
Grand Touring	2002-2003	700	BR9ECS	3570	0,5				
Grand Touring SE	1997-	700	BR10ES	4684	0,8			BR10EIX	6801
Grand Touring SE	1994-1995	700	BR9ES	3194	0,7	BR9EVX	4318	BR9EIX	3981
Grand Touring XTC	1994-1995	700	BR9ES	3194	0,7	BR9EVX	4318	BR9EIX	3981
Legend	2002-2004	700	BR9ECS	3570	0,5				
Mach I	1996-1997	700	BR10ES	4684	0,8			BR10EIX	6801
Mach I	1994-1995	700	BR9ES	3194	0,7	BR9EVX	4318	BR9EIX	3981
Mach I	1998-2000	700	BR9ES	3194	0,7	BR9EVX	4318	BR9EIX	3981
MXZ	1999-2001	700	BR9ES	3194	0,7	BR9EVX	4318	BR9EIX	3981
MXZ	2002-2003	700	BR9ECS	3570	0,5				
Summit	2000-2001	700	BR9ES	3194	0,7	BR9EVX	4318	BR9EIX	3981
Summit	2002-2003	700	BR9ECS	3570	0,5				
Mach Z	1993-1996	775	BR10ES	4684	0,8			BR10EIX	6801
TNT	1971-1972	775	A8	1210	0,7				
Formula III	1999-2000	800	BR9ES	3194	0,7	BR9EVX	4318	BR9EIX	3981
Grand Touring SE	2002-2003	800	BR9ECS	3570	0,5				
Grand Touring SE	2001-	800	BR9ES	3194	0,8	BR9EVX	4318	BR9EIX	3981
Grand Touring SE	1999-2000	800	BR10ES	4684	0,8			BR10EIX	6801
GSX	2005-	800	BR8ECS	3972	0,6				
GSX	2004-	800	BR9ECS	3570	0,5				
GTX	2005-	800	BR8ECS	3972	0,6				
Legend	2002-2004	800	BR9ECS	3570	0,5				
Mach Z	2000-2002	800	BR9ES	3194	0,7	BR9EVX	4318	BR9EIX	3981
Mach Z	1996-1999	800	BR10ES	4684	0,8			BR10EIX	6801
Mach Z	1994-1995	800	BR9ES	3194	0,7	BR9EVX	4318	BR9EIX	3981
Mach Z	2003-2004	800	BR9ECS	3570	0,5				
MXZ	2005-	800	BR8ECS	3972	0,6				
MXZ	2002-2003	800	BR9ECS	3570	0,5				
MXZ	-2001	800	BR9ES	3194	0,7	BR9EVX	4318	BR9EIX	3981
Summit	-2001	800	BR9ES	3194	0,7	BR9EVX	4318	BR9EIX	3981
Summit	2005-	800	BR8ECS	3972	0,6				
Summit	2002-2004	800	BR9ECS	3570	0,5				
Grand Tour Sport	2003-	1000	DCPR8E	4179	0,8	DCPR8EVX	2265	DCPR8EIX	6546



ccm

Order  
No.Platin/  
Gold-  
PalladiumOrder  
No.

Iridium

Order  
No.**SKI-DOO**

Legend	2003-2004	1000	BR9ECS	3570	0,5				
Summit Highmark	2005-	1000	BR8ECS	3972	0,6				
Elite	2004-	1500	BR9ECS	3570	0,5				

**SNO JET(KAWASAKI)**

ASTRO 340(339cc)	399	BR8ES	5422	0,7	BR8EVX	1262	BR8EIX	5044
ASTRO 440(436cc)	436	BR8ES	5422	0,7	BR8EVX	1262	BR8EIX	5044

**SNO JET(YAMAHA)**

S292(292cc)	292	---		0,4	B9EVX	7254	BR9EIX	3981
Y292(292cc)	292	B8ES	2411	0,5	B8EVX	7051	BR8EIX	5044
S338(338cc)	338	---		0,4	B8EVX	7051	BR8EIX	5044
SST340(338cc)	338	---		0,5	B9EVX	7254	BR9EIX	3981
SX338(338cc)	338	---		0,4	B9EVX	7254	BR9EIX	3981
Y338(338cc)	338	B7HS	5110	0,5	B7HVX	7836	BR7HIX	7067
S433(433cc) 1976	433	---		0,5	BR9EVX	1265	BR9EIX	3981
S433(433cc)-->1975	433	---		0,4	B8EVX	7051	BR8EIX	5044
SST440(433cc)	433	---		0,5	B9EVX	7254	BR9EIX	3981
SX433(433cc)	433	---		0,4	B9EVX	7254	BR9EIX	3981
Y433(433cc)	433	B7HS	5110	0,5	B7HVX	7836	BR7HIX	7067

**SUZUKI**

60F/C		BR6HS	3922	0,7			BR6HIX	3419
292 NOMAD(292cc)	292	B7HS	5110	0,7	B7HVX	7836	BR7HIX	7067
340 NOMAD(336cc)	336	B7HS	5110	0,7	B7HVX	7836	BR7HIX	7067
SM10(360cc)	360	B7HS	5110	0,7	B7HVX	7836	BR7HIX	7067
SM10D(360cc)	360	B7HS	5110	0,7	B7HVX	7836	BR7HIX	7067
400 Wide Track(395cc)	395	B7HS	5110	0,7	B7HVX	7836	BR7HIX	7067
SM20(395cc)	395	B7HS	5110	0,7	B7HVX	7836	BR7HIX	7067
SM20 Hop Up Kit(395cc)	395	B8ES	2411	0,7	B8EVX	7051	BR8EIX	5044
XR400(395cc)	395	B7HS	5110	0,7	B7HVX	7836	BR7HIX	7067
XR440(432cc)	432	B7HS	5110	0,7	B7HVX	7836	BR7HIX	7067
440F/C(433cc)	433	BR9ES	5722	0,6	BR9EVX	1265	BR9EIX	3981
440F/C-CI(433cc)	433	BR9ES	5722	0,6	BR9EVX	1265	BR9EIX	3981
440L/C(433cc)	433	BR9ES	5722	0,6	BR9EVX	1265	BR9EIX	3981
SM440M(433cc)	433	---		0,7	B9EVX	7254	BR9EIX	3981
500F/C(499cc)	499	BR9ES	5722	0,6	BR9EVX	1265	BR9EIX	3981
500L/C(499cc)	499	---		0,6	BR10EV	5127	BR10EIX	6801
530L/C	530	BR10ES	4832	0,7	BR10EV	5127	BR10EIX	6801
650L/C	650	BR10ES	4832	0,7	BR10EV	5127	BR10EIX	6801

**YAMAHA**

SE80	80	BR8HS	4322	0,7	BR8HVX	6265	BR8HIX	7001
SV80 Series	80	BR8HS	4322	0,7	BR8HVX	6265	BR8HIX	7001
SV125 Series	125	BR8HS	4322	0,7	BR8HVX	6265	BR8HIX	7001
BR250 Series	250	BR8HS	4322	0,7	BR8HVX	6265	BR8HIX	7001
ET250 Series(exc.ET250A/B)	250	B8HS	5510	0,7	B8HVX	2634	BR8HIX	7001
ET250A/B	250	---		0,6	BR8HVX	6265	BR8HIX	7001
CF300	300	BR8HS	4322	0,7	BR8HVX	6265	BR8HIX	7001
EC300	300	BR9ES	5722	0,8	BR9EVX	1265	BR9EIX	3981
ET300 Series(exc.ET300C)	300	BR9ES	5722	0,8	BR9EVX	1265	BR9EIX	3981
ET300C	300	---		0,6	BR9EVX	1265	BR9EIX	3981



ccm



Order No.



Platin/  
Gold-  
Palladium



Order No.

Iridium





Order No.

**YAMAHA**

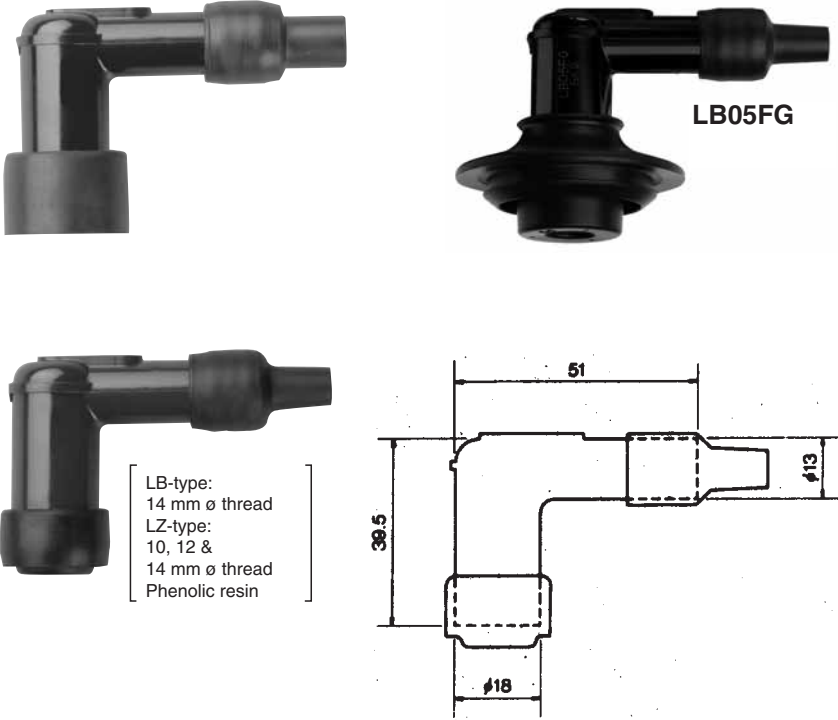

	ccm		Order No.		Order No.		Order No.	
CS340/E	340	BR9ES	5722	0.8	BR9EVX	1265	BR9EIX	3981
EC340 Series	340	BR9ES	5722	0.8	BR9EVX	1265	BR9EIX	3981
ET340 Series(exc.ET340B/C/EC)	340	BR9ES	5722	0.8	BR9EVX	1265	BR9EIX	3981
ET340B/C/EC	340	---		0.6	BR9EVX	1265	BR9EIX	3981
EX340 Series	340	---		0.6	BR9EVX	1265	BR9EIX	3981
S340	340	BR8ES	5422	0.8	BR8EVX	1262	BR8EIX	5044
ET400 Series	400	BR8ES	5422	0.8	BR8EVX	1262	BR8EIX	5044
ET410TR	410	BR9ES	5722	0.8	BR9EVX	1265	BR9EIX	3981
SS440 Series	440	BR9ES	5722	0.8	BR9EVX	1265	BR9EIX	3981
PZ480 Series	480	BR9ES	5722	0.8	BR9EVX	1265	BR9EIX	3981
VT480 Series	480	BR9ES	5722	0.8	BR9EVX	1265	BR9EIX	3981
VK500E	500	BR9ES	5722	0.8	BR9EVX	1265	BR9EIX	3981
VX500 Series	500	BR9ES	5722	0.8	BR9EVX	1265	BR9EIX	3981
SR540 Series 1994-90	540	---		0.6	BR9EVX	1265	BR9EIX	3981
SR540 Series-->1989	540	BR9ES	5722	0.8	BR9EVX	1265	BR9EIX	3981
VK540 Series	540	BR9ES	5722	0.8	BR9EVX	1265	BR9EIX	3981
VMX540 Series 1994-90	540	---		0.6	BR9EVX	1265	BR9EIX	3981
VMX540 Series-->1989	540	BR9ES	5722	0.8	BR9EVX	1265	BR9EIX	3981
XL540 Series	540	BR9ES	5722	0.8	BR9EVX	1265	BR9EIX	3981
EX570 Series	570	BR9ES	5722	0.8	BR9EVX	1265	BR9EIX	3981
VX600 Series	600	BR9ES	5722	0.8	BR9EVX	1265	BR9EIX	3981
VX750 Series	750	BR9ES	5722	0.8	BR9EVX	1265	BR9EIX	3981
VX800 Series	800	BR9ES	5722	0.8	BR9EVX	1265	BR9EIX	3981



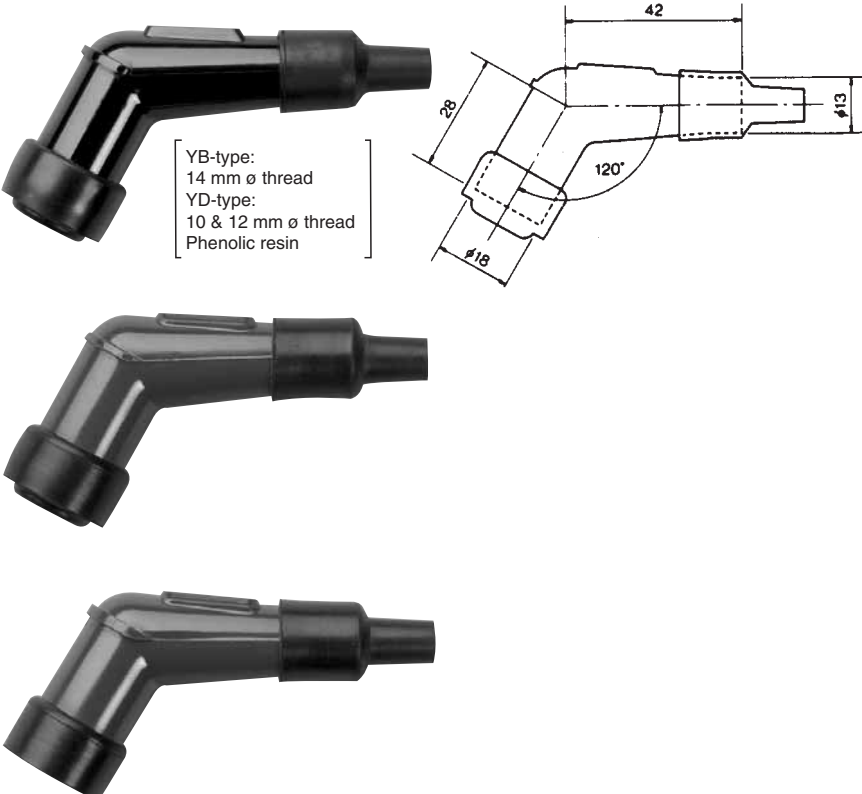

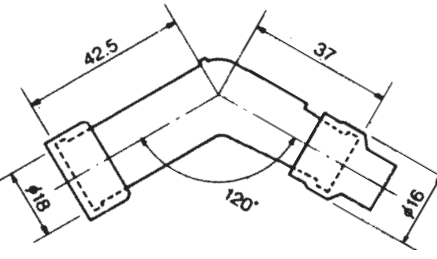

# NGK SPARK PLUG RESISTOR COVER

Configuration (applicable plug thread dia, body material) Unit: mm	Type No.	 (KΩ)
 <p data-bbox="323 801 507 936">           LB-type: 14 mm ø thread LZ-type: 10, 12 &amp; 14 mm ø thread Phenolic resin         </p>	<p data-bbox="1102 309 1177 342"><b>LBE</b></p> <p data-bbox="1102 365 1230 398"><b>LBEPK</b></p> <p data-bbox="1102 421 1214 454"><b>LB○E</b></p> <p data-bbox="1102 477 1238 510"><b>LB○EP</b></p> <p data-bbox="1102 533 1265 566"><b>LB○EPK</b></p> <p data-bbox="1102 589 1233 622"><b>LB○FF</b></p> <p data-bbox="1102 645 1262 678"><b>LB○5FG</b></p> <p data-bbox="1102 790 1214 824"><b>LB○E</b></p>	<p data-bbox="1310 309 1461 342">No resistor</p> <p data-bbox="1310 365 1461 398">No resistor</p> <p data-bbox="1310 421 1398 454">1,5,10</p> <p data-bbox="1310 477 1358 510">1,5</p> <p data-bbox="1310 533 1326 566">5</p> <p data-bbox="1310 589 1398 622">1,5,10</p> <p data-bbox="1310 645 1326 678">5</p> <p data-bbox="1310 790 1374 824">5,10</p>

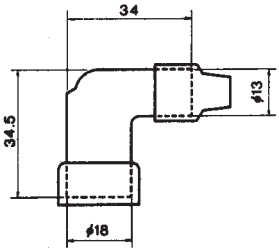

Configuration (applicable plug thread dia, body material) Unit: mm	Type No.	 (KΩ)
 <p data-bbox="363 1435 547 1547">           YB-type: 14 mm ø thread YD-type: 10 &amp; 12 mm ø thread Phenolic resin         </p>	<p data-bbox="1102 1312 1214 1346"><b>YB○F</b></p> <p data-bbox="1102 1368 1214 1402"><b>YD○F</b></p> <p data-bbox="1102 1637 1214 1671"><b>YB○F</b></p> <p data-bbox="1102 1906 1214 1939"><b>YD○F</b></p>	<p data-bbox="1310 1312 1398 1346">1,5,10</p> <p data-bbox="1310 1368 1358 1402">1,5</p> <p data-bbox="1310 1637 1326 1671">5</p> <p data-bbox="1310 1906 1326 1939">5</p>

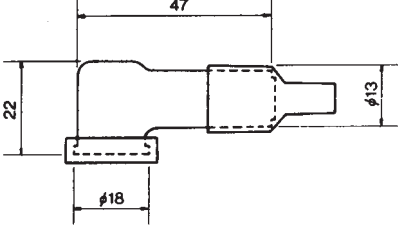
# NGK SPARK PLUG RESISTOR COVER

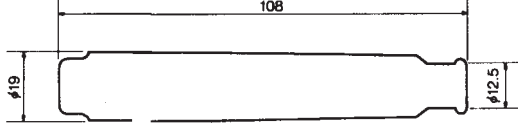
Configuration (applicable plug thread dia, body material) Unit: mm	Type No.	 (KΩ)
 <p>VB-type: 14 mm ø thread VD-type: 10 &amp; 12 ø thread Phenolic resin</p> 	VB○E VB○F VB○FP VD○F  VB○F  VD○F  VD○EG	5,1 1,5,10 5 1,5,10  5  5  5



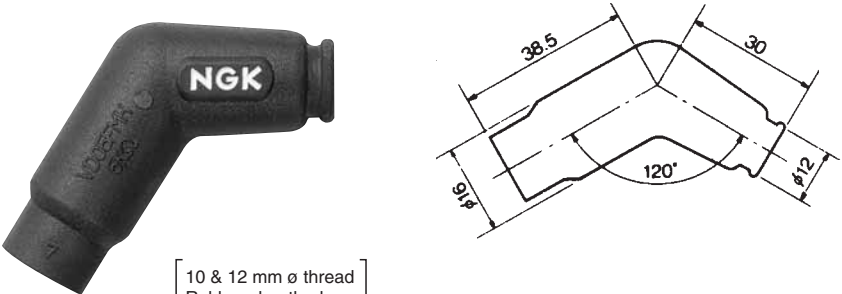
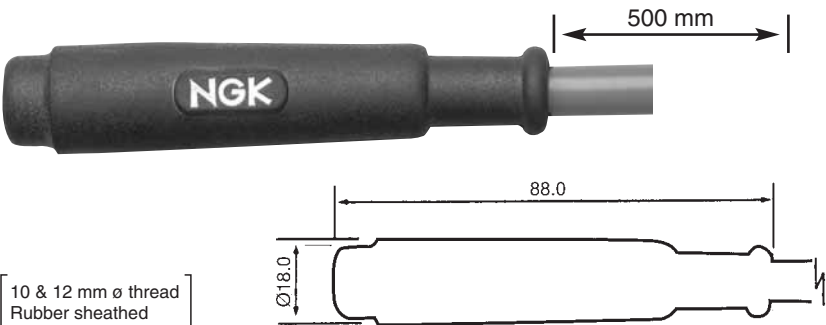

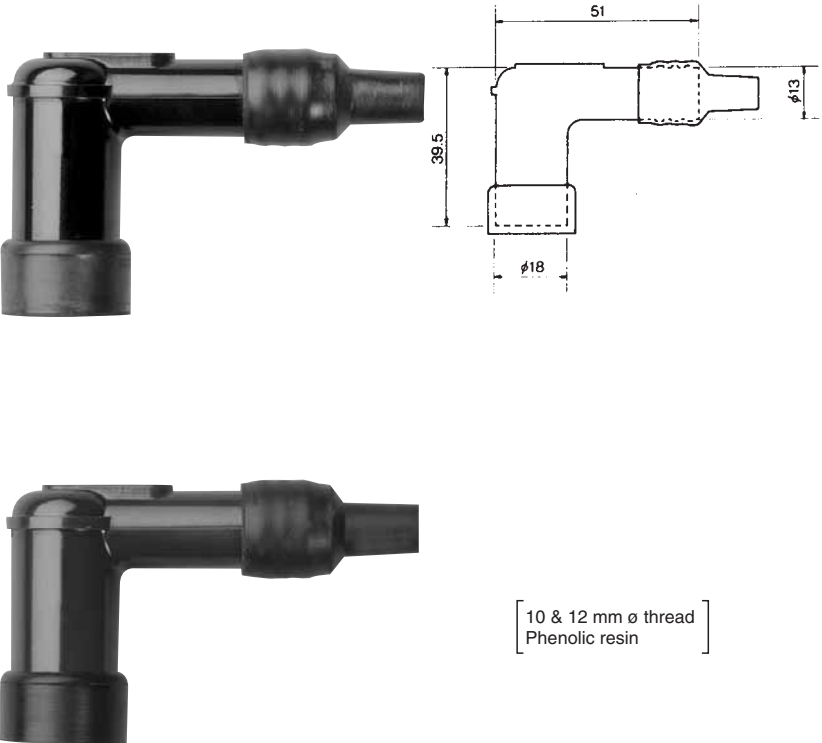



Configuration (applicable plug thread dia, body material) Unit: mm	Type No.	 (KΩ)
 <p>10, 12 &amp; 14 mm ø thread Phenolic resin</p> 	LZEH LZFH	No resistor No resistor
 <p>10 mm ø thread CM-6 only Phenolic resin</p> 	LC○EFK	5
 <p>10 &amp; 12 mm ø thread Rubber sheathed</p> 	SD○FM	5

# NGK SPARK PLUG RESISTOR COVER

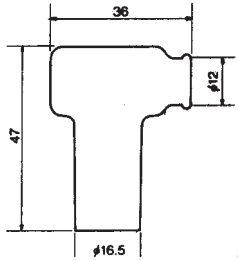

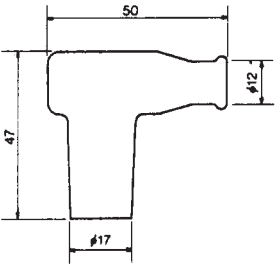
<b>Configuration</b> (applicable plug thread dia, body material) <b>Unit:</b> mm	<b>Type No.</b>	 (KΩ)
 <p data-bbox="363 573 555 629">[ 10 &amp; 12 mm ø thread Rubber sheathed ]</p>	<b>VD</b> ○ <b>FMH</b>	5
 <p data-bbox="197 1003 389 1059">[ 10 &amp; 12 mm ø thread Rubber sheathed ]</p>	<b>SD05FMC</b>	5
<b>Configuration</b> (applicable plug thread dia, body material) <b>Unit:</b> mm	<b>Type No.</b>	 (KΩ)
 <p data-bbox="724 1917 916 1973">[ 10 &amp; 12 mm ø thread Phenolic resin ]</p>	<b>LDF</b> <b>LD</b> ○ <b>F</b>  <b>LD</b> ○ <b>F</b>	No resistor 1,5,10  5

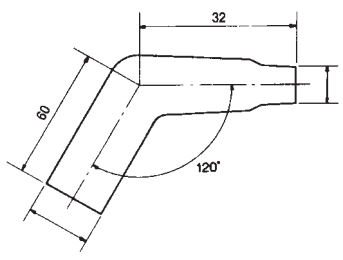

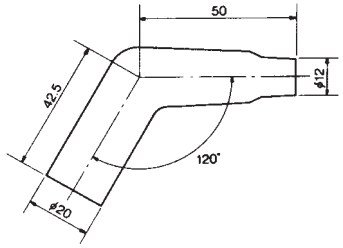

# NGK SPARK PLUG RESISTOR COVER



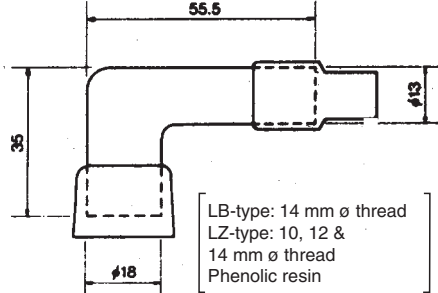

Configuration (applicable plug thread dia, body material) Unit: mm	Type No.	
 <p data-bbox="359 436 534 492">[ 14 mm ø thread Rubber sheathed ]</p> 	LB○EMH	5
 <p data-bbox="359 750 534 817">[ 14 mm ø thread Rubber sheathed (Silicon) ]</p> 	TB○EM	5
 <p data-bbox="359 1131 566 1198">[ 10 &amp; 12 mm ø thread Rubber sheathed (Silicon) ]</p> 	VD○EM	5
 <p data-bbox="359 1478 566 1545">[ 10 &amp; 12 mm ø thread Rubber sheathed (Silicon) ]</p> 	VD○FML	5

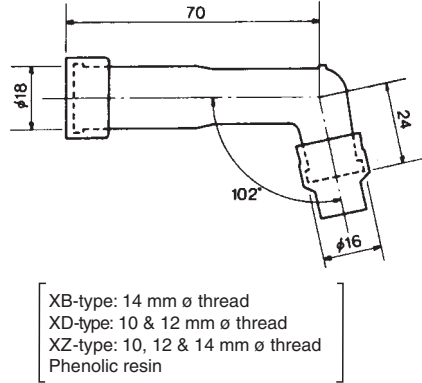



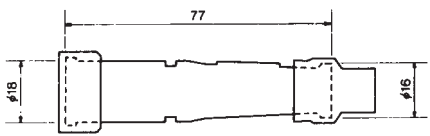

# NGK SPARK PLUG RESISTOR COVER

Configuration (applicable plug thread dia, body material) Unit: mm	Type No.	 (KΩ)
 	<b>LBF</b> <b>LB○F</b> <b>LB○FP</b> <b>LB○EZ</b>  <b>LB○F</b>   <b>LZ○F</b>	No resistor 1,5,10 1,5,10 5  5,10   5



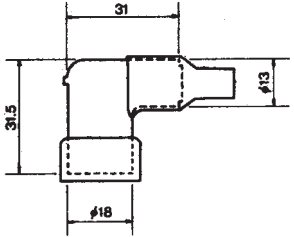

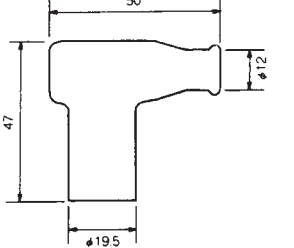
Configuration (applicable plug thread dia, body material) Unit: mm	Type No.	 (KΩ)
 	<b>XB○F</b>   <b>XB○F</b> <b>XB○FP</b> <b>XD○F</b> <b>XZ○F</b>   <b>XD○F</b>	5   1,5,10 5 1,5,10 1   1,5,

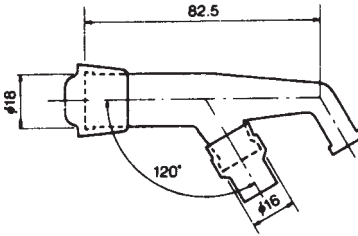

# NGK SPARK PLUG RESISTOR COVER

Configuration (applicable plug thread dia, body material) Unit: mm	Type No.	 (KΩ)
 	SB○E SB○F SD○F	1,5,10 1,5,10 1,5,10
 <p data-bbox="694 616 893 784">             SB-type:              14 mm ø thread              SD-type:              10 &amp; 12 mm ø thread              Phenolic resin              SZ-type              10, 12, 14 mm           </p>	SB○F	5,10
	SD○F SZ○F	5 5

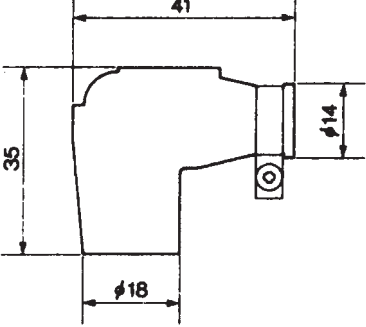

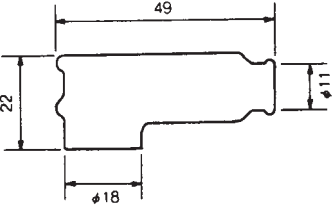

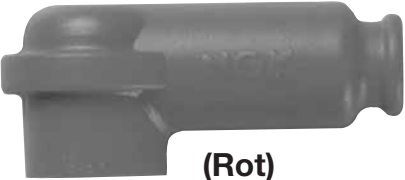
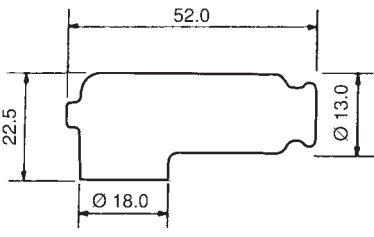

Configuration (applicable plug thread dia, body material) Unit: mm	Type No.	 (KΩ)
 <p data-bbox="446 1411 646 1534">             LB-type:              14 mm ø thread              LD-type:              10 &amp; 12 mm ø thread              Phenolic resin           </p> 	LEH LB○EH LB○EHF LDFH	No resistor 1,5,10 1,5 No resistor
 <p data-bbox="446 1724 614 1780">             [ 14 mm ø thread              Rubber sheathed ]           </p> 	TB○EMA	5
 <p data-bbox="446 2016 598 2072">             [ 14 mm ø thread              Phenolic resin ]           </p> 	VB○EYK	5



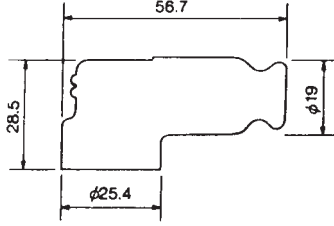

# NGK SPARK PLUG RESISTOR COVER

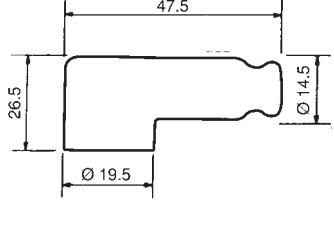
Configuration (applicable plug thread dia, body material) Unit: mm	Type No.	
 <p>14 mm ø thread Rubber sheathed (Silicon)</p> 	<b>LBER</b>	No resistor
 <p><b>(Blau)</b></p> <p>14 mm ø thread Silicon – Rubber sheathed For spark plug R6120-○, R6120A-○, R6120C-○, R6120M-○ R7282-○, R7282A-○, R7282C-○, R7282M-○ ø 8 mm Kabel</p> 	<b>TRS1225</b>	5

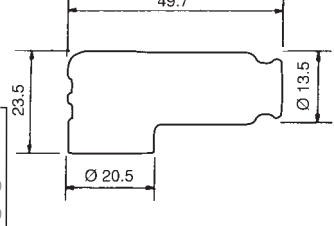

Configuration (applicable plug thread dia, body material) Unit: mm	Type No.	
 <p><b>(Gelb)</b></p>  <p><b>(Grün)</b></p>  <p><b>(Rot)</b></p> <p>14 mm ø thread Silicon – Rubber sheathed For spark plug R6120-○, R6120A-○ R6120C-○, R6120M-○ R7282-○, R7282A-○ R7282C-○, R7282M-○ ø 7 mm Kabel</p> 	<b>TRS1233 A</b> <b>TRS1233 B</b> <b>TRS1233 C</b>	5 5 5

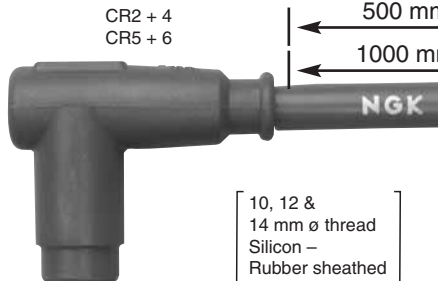
# NGK SPARK PLUG RESISTOR COVER

Configuration (applicable plug thread dia, body material) Unit: mm	Type No.	 (KΩ)
 <p><b>(Blau)</b></p> <p>14 mm ø thread Silicon – rubber sheathed For spark plug R5300A-○, R5300N-○ ø 8 mm Kabel</p>	 <p>56.7 28.5 φ25.4 φ19</p> <p><b>TRS1408F</b></p>	5
 <p><b>(Rot)</b></p> <p>14 mm ø thread Rubber sheathed Silicon For spark plug R5540F-○ ø 7 mm Kabel</p>	 <p>47.5 26.5 φ19.5 φ14.5</p> <p><b>TRS1409</b></p>	
 <p><b>(Blau)</b></p> <p>14 mm ø thread Silicon – rubber sheathed For spark plug R6120-○, R6120A-○, R6120C-○, R6120M-○ R7282-○, R7282A-○, R7282C-○, R7282M-○ ø 7 mm Kabel</p>	 <p>49.7 23.5 φ20.5 φ13.5</p> <p><b>TRS1505</b></p>	5

Configuration (applicable plug thread dia, body material) Unit: mm	Type No.	 (KΩ)
 <p>500 mm</p> <p>CR1 M4 CR3 SAE</p> <p>108(CR1), 115(CR3)</p> <p>φ19</p> <p>[ 10, 12 &amp; 14 mm ø thread Silicon – Rubber sheathed ]</p>	<p><b>CR1</b></p> <p><b>CR3</b></p>	5 5
 <p>CR2 + 4 CR5 + 6</p> <p>500 mm 1000 mm</p> <p>58(CR2,CR5) 49(CR4,CR6)</p> <p>49(CR2,CR5) 46(CR4,CR6)</p> <p>φ19.5</p> <p>CR2 + 5 M4 CR4 + 6 SAE</p> <p>[ 10, 12 &amp; 14 mm ø thread Silicon – Rubber sheathed ]</p>	<p><b>CR2</b></p> <p><b>CR4</b></p> <p><b>CR5</b></p> <p><b>CR6</b></p>	5 5 5 5
<p><b>Kabelverbinder</b></p> 	<p><b>J-1</b></p>	

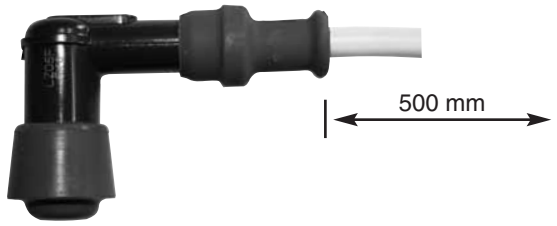
# NGK SPARK PLUG RESISTOR COVER

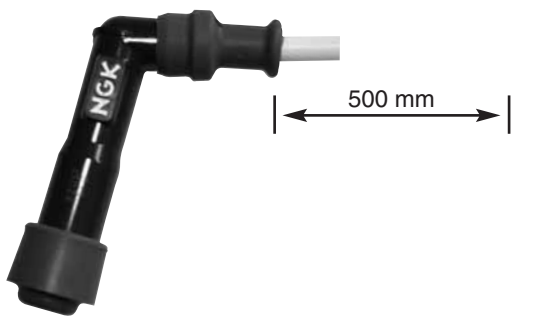
Configuration (applicable plug thread dia, body material) Unit: mm	Type No.	 (KΩ)
 <p>500 mm</p> <p>[ 10, 12 mm ø thread Phenolic resin ]</p>	LD $\bigcirc$ F	5
 <p>500 mm</p> <p>[ 10, 12 mm ø thread Phenolic resin ]</p>	SD $\bigcirc$ F	5
 <p>500 mm</p> <p>[ 10, 12 mm ø thread Phenolic resin ]</p>	XD $\bigcirc$ F	5

## Erklärung der Kurzzeichen/Symbol Explanation/Explication des symboles/Sigle commerciali

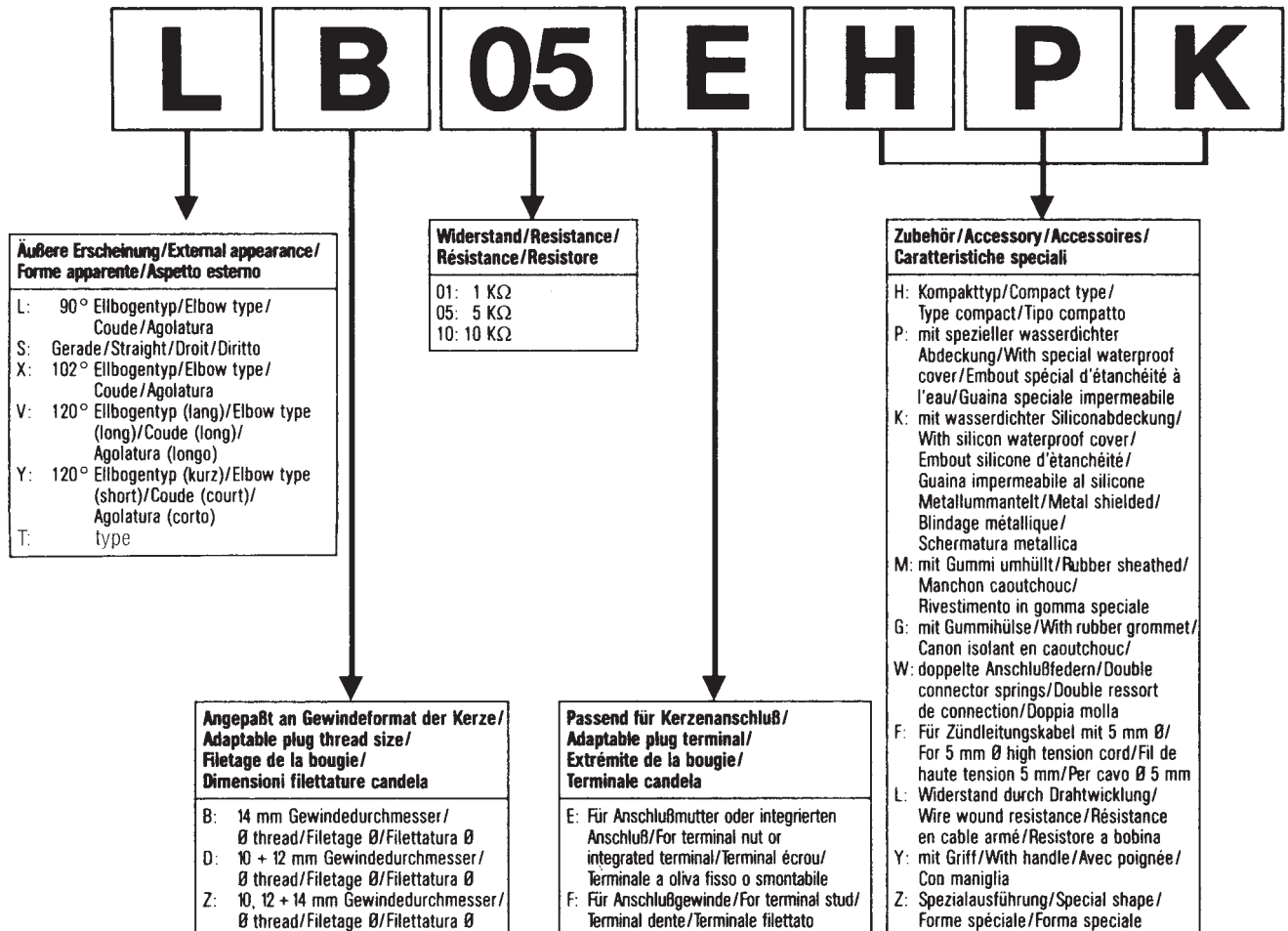

V-Line	BERU	BOSCH	YTTRIUM	CHAMPION
Nr.1 (BUR6ET)	14GH-7DTUR 14-6DTU 14-7DTU Z 51 Z 12 Z 91	W7LTCR W6DTC W6DTC	+2	N7BYC OE012 N9BYC OE044
Nr.2 (BPR6E)	14R-6DU 14R-7DU Z 27 Z 20	WR6DC WR7DC	+1 / +12	RN7YC OE018 RN9YC OE006
Nr.3 (BPR6H)	14R-6BU 14R-7BU Z 19	WR6BC WR7BC	+10	RL82YC OE064 RL87YC
Nr.4 (BP6E)	14-6DU 14-7DU Z 22 Z 10	W6DC W7DC		N9YC OE001 N7YC OE010
Nr.5 (BP6EF)	14K-6DU 14K-7DU Z 25 Z 17	H6DC H7DC		S7YC OE050 S9YC OE009
Nr.6 (BPR5E)	14R-8DU 14R-9DU Z 8 Z 82	WR8DC WR9DC	+3 / +16	RN11YC OE051 RN12YC OE042
Nr.7 (BPR6EF)	14KR-6DU 14KR-7DU Z 26 Z 95	HR6DC HR7DC	+5 / +18	RS9YC OE011 RS7YC
Nr.8 (BP5E)	14-8DU 14-9DU Z 1 Z 76	W8DC W9DC		N11YC OE065 N12YC OE015
Nr.9 (BPR5EY)	14-R-8DU Z 8	WR8DC		RN9YC OE006
Nr.10 (BPR6EY-11)	14-R-7DUX Z 21	WR7DCX		RN9YC4 OE048
Nr.11 (BCPR6E-11)	14F-6DUX 14F-7DUX Z 99	FR6DCX FR7DCX		RC9YC4 OE039
Nr.12 (BCPR6E)	14F-6DU 14F-7DU Z 63	FR6DC FR7DC		RC9YC OE005
Nr.13 (BPR6ES-11)	14R-6DUX 14R-7DUX Z 28 Z 21	WR6DCX WR7DCX		RN7YC4 OE117
Nr.14 (BKR6E-11)	14FR-7DUX Z 16	FR7DCX	+11	RC7YC4 OE080
Nr.15 (ZGR5A)	14-8LUR Z 3	W8LCR		RN9YCX
Nr.16 (BCP5E)	14F-8DU Z 71	F8DC		C9YC OE003
Nr.17 (BCP6E)	14F-6DU 14F-7DU Z 63	F6DC F7DC		C9BYC
Nr.18 (BP6H)	14-6BU 14-7BU Z 48 Z 10	W6BC W7BC		L87YC OE007
Nr.19 (BPR7E)	14R-5DU Z 47	WR5DC	+15	RN6YC OE116
Nr.20 (BKR6EK)	14F-7LDUR	F7LDCR	+7	RC8DMC OE026
Nr.21 (BUR5ET-10)	14GH-8DTURX Z 93	W8LTCR 1.0	+4	RN10VTYC4 OE027
Nr.22 (BUR5ET)	14GH-8DTUR Z 92	W8LTCR		RN10VTYC OE027
Nr.23 (BKR5EK)	14FLR-8LDUX	F8LDCR	+9	RC10DMC OE019
Nr.24 (BKUR6ET-10)	14FGH-7DTURX Z 90	F7LTCR		RC8VTYC4 OE032
Nr.25 (PTR5A-13)	14KR-6ZPPV Z 97	HR7MPP	+17	RE7YCC
Nr.26 (BKR6EKC)	14FR-7LDU Z 98	FR7LDC		RC8BYC OE030 RC7BMC OE021
Nr.27 (BKUR6ET)	14FGH-7DTUR	...		RC8VTYC4 OE032
Nr.28 (BKR6E)	14FR-7DU	F6DCOR F7DCOR FR6DC FR7DC F8KTCR	+8 / +13	RC7YC4 OE080
Nr.29 (BKUR5ET)	14FGH8DTURXO 14FGH-7DTURX 14FGR6KQU	F8KTCR		RC89TMC OE120
Nr.30 (BKR6EQUP)		FGR7KQE0 FGR7KQE FGR7DQP F7LDCR F9LCR F9LCR2 FGR6KQC	...	
Nr.31 (PTR5D-10)	14KR-7DUX 14FR-8DU	HR7DCX FR8LDC FR8DCO FR7DCO		RS9PYP4 OE131 RC12YC OE013 RC9YCC OE005 RC10YC OE088 RC9YC4 OE39 RC10YC4 OE63
Nr.32 (BCPR5E)	14FR-7DUX Z16	FR7DCX FR7DCX+ FR8DCX FR8DCX+		
Nr.33 (BKR5E-11)		FR7HPP222		KC8ZPYPB4 OE176
Nr.34 (PZFR5D-11)	14F-7HPURX2 Z176	FR7DC FR7DC+ FR7DC4 FR8DC		RC9YC OE005
Nr.35 (BKR5E)	14FR-8DU 14FR-8KU			

<b>V-Line No.</b>	<b>Car-Manufacturer</b>
1	BUR6ET Audi, Fiat, Lancia, Seat, Skoda, VW
2	BPR6E Alfa Romeo, Austin, Autobianchi, BMW, Chrysler, Daewoo, Daihatsu, Fiat, Ford, FSO, Honda, Hyundai, Innocenti, Isuzu, Lada, Lancia, Lotus, Mazda, MG, Mitsubishi, Nissan, Opel, Porsche, Renault, Rover, Seat, Subaru, Suzuki, TVR, Vauxhall, Volvo, Zastava
3	BPR6H Daewoo, Opel, Vauxhall
4	BP6E Alfa Romeo, Aston Martin, Audi, Austin, BMW, Citroen, Fiat, FSO, Innocenti, Lada, Lotus, Maserati, Mercedes, Mitsubishi, Morgan, Moskwicz, Nissan, Peugeot, Renault, Rover, Saab, Seat, Subaru, Talbot, Tofas, Volvo, VW, Wartburg, Yugo, Zastava
5	BP6EF Citroen, Mercedes, Peugeot, Renault, Rover, Talbot
6	BPR5E Asia, Daihatsu, Fiat, Honda, Innocenti, Mazda, Mitsubishi, Nissan, Opel, Renault, Rolls Royce, Rover, Seat, Suzuki, Toyota, TVR, Vauxhall
7	BPR6EF Chevrolet, Ford, Lancia, Renault, TVR, Volvo
8	BP5E BMW, Citroen, Daimler, Isuzu, Jaguar, Mitsubishi, Nissan, Renault, Rover, VW
9	BPR5EY Daihatsu, Innocenti, Suzuki, Toyota
10	BPR6EY-11 Daihatsu, Honda, Toyota
11	BCPR6E-11 Ford, Honda, Mazda, Nissan, Renault, Rover, Saab, Subaru
12	BCPR6E Aston Martin, Autobianchi, Chrysler, Citroen, Daimler, Fiat, Ford, FSO, Jaguar, Lada, Lancia, Mazda, Morgan, Nissan, Opel, Peugeot, Porsche, Rover, Skoda, TVR, Volvo
13	BPR6ES-11 Honda, Hyundai, Isuzu, Kia, Mazda, Mitsubishi, Nissan, Opel, Rover, Subaru, Suzuki, Vauxhall
14	BKR6E-11 Daewoo, Daihatsu, Honda, Hyundai, Isuzu, Kia, Lotus, Mazda, Mitsubishi, Nissan, Proton, Rover, Subaru, Suzuki
15	ZGR5A BMW, Daihatsu
16	BCP5E Citroen, Mercedes, Nissan, Peugeot, Renault, Ssangyong
17	BCP6E Alfa Romeo, Citroen, Lada, Mercedes, Nissan, Peugeot, Renault, Rover, Skoda, Ssangyong, Tatra
18	BP6H Citroen, Dacia, Renault, Seat, Skoda, Z.A.Z., Zastava
19	BPR7E Alfa Romeo, Austin, Autobianchi, Caterham, Fiat, Ford, Lancia, Lotus, Mitsubishi, Porsche, Renault, Rover, Subaru, Volvo
20	BKR6EK BMW, Citroen, Fiat, Lancia, Mercedes, Opel, Peugeot, Porsche, Renault, Vauxhall, VW, Wiesmann
21	BUR5ET-10 Audi, Seat, VW
22	BUR5ET Audi, Seat, VW
23	BKR5EK Citroen, Daewoo, Fiat, Lancia, Opel, Peugeot, Saab, Vauxhall
24	BKUR6ET-10 Audi, Mercedes, Seat, Skoda, VW
25	PTR5A-13 Ford, Mazda, Morgan
26	BKR6EKC Fiat, Lancia, Lotus
27	BKUR6ET Audi, Fiat, Lancia, Seat, Skoda, VW
28	BKR6E Caterham, Chrysler, Daihatsu, Kia, Lotus, Mazda, Nissan, Opel, Rover, Suzuki
29	BKUR5ET Mercedes, Seat, VW
30	BKR6EQUP Alpina, Audi, BMW, Bentley, Land Rover, Mini, Morgan, Porsche, Rolls Royce
31	PTR5D-10 Aston Martin, Ford, Mazda
32	BCPR5ES Citroen, Nissan, Peugeot, Reliant, Renault, Skoda
33	BKR5E-11 Chevrolet, Chrysler, Daewoo, Daihatsu, Hyundai, Kia, Mazda, Mitsubishi, Nissan, Subaru
34	PZFR5D-11 Ford, Seat, Skoda, VW
35	BKR5E Kia, Mazda, Nissan, Ssangyong, VW



# Conversion Chart

## Vergleichsliste

## Tableau de comparaison thermique

## Tabla de conversión equivalencias

## Jämförelsetabell

## Převodní tabulky

**Note:** This chart is furnished as a guide. Due to differences in design, materials, etc., plugs produced by various manufacturers do not have exactly the same heat range. See recommendations sections for specific engine application.

**Anmerkung:** Diese Liste dient nur zur Information. Wegen der Unterschiede von Konstruktion, Werkstoffen usw. haben die Zündkerzen von verschiedenen Herstellern keinen miteinander übereinstimmenden Wärmebereich. Siehe unsere Empfehlungen für die richtige Anwendung der Zündkerzen.

**Notes:** Cette liste est donnée comme guide. A cause de la différence en dessin, matériels etc., les bougies d'allumage produites par divers fabricans n'ont pas exactement la même gamme thermique. Voir section d'affectations pour utilisation exacte.

**Notas:** Este cuadro se sirve de quia. Bujías que se producen por varios fabricantes no poseen exactamente el mismo alcance térmico debido a las diferencias en diseño, materiales etc. Véase sección de aplicaciones para el uso correcto.

**Observera:** Denna tabell är endast avsedd som vägledning. På grund av avvikelser i utförande, material m.m. kan tändstift av olika fabrikat ej ha exakt samma värmetal. Se rekommendations-tabellen för respektive motor.

**Upozornění:** Převodní tabulky slouží pouze pro srovnávací účely. Zapalovací svíčky od různých výrobců nemají kvůli rozdílné konstrukci, použitému materiálu apod. srovnatelný rozsah tepelných hodnot. Pro správný výběr zapalovací svíčky je třeba se řídit doporučeními firmy NGK v aplikačních tabulkách tohoto katalogu.



<b>AC</b>	<b>→ NGK Typ</b>	<b>V-LINE</b>
41-2XLS	BP7ES	
41-4XLS	BP6ES	4
41-600	TR55	
41-601	TR55	
41-602	FR5	
41-603	FR4	
41-606	TR55	
41-608	FR45	
41-610	FR4	
41-611	FR45	
41-628	FR4	
41-900	TR5	
41-902	TR55	
41-904	TR5	
41-905	UR4	
41-906	TR5	
41-907	TR5	
41-910	TR5	
41-913	TR55	
41-919	TR55	
41-921	TR55	
41-928	TR55-1	
41-929	TR55	
41-932	TR55	
41-936	TR55	
41-940	TR55	
41-942	TR55	
41-943	TR55	
41-947	TR55	
41-985	IZTR5B11	
41TS	BP6FS	
41XL	B9ES	
41XLS	BP7ES	
420Z	B4H	
422Z	B5HS	
425Z	B6HS	
42-6FS	BP6HS	18
42F	B6HS	
42FS	BP6HS	18
42S	BP6S	
42TS	BP6FS	
42XL	B8ES	
42XLS	BP6ES	4
430Z	B7HS	
436XLS	BP9ES	
438XLS	BP8ES	
43FS	BP6HS	18
43N	B7ES	
43S	BP6S	
43TS	BP6FS	
43XL	B7ES	

<b>AC</b>	<b>→ NGK Typ</b>	<b>V-LINE</b>
43XLS	BP6ES	4
44	B6S	
440T	B7FS	
440XLS	BP8ES	
445Z	B8HS	
44F	B5HS	
44FFS	BP5HS	
44N	B6ES	
44NS	BP5ES	8
44S	BP5S	
44TS	BP5FS	
44XL	B6ES	
44XLO	BP5ES	8
44XLS	BP5ES	8
45	B4	
45F	B5HS	
45FFS	BP5HS	
45L	B4L	
45NS	BP5ES	8
45S	BP5S	
45TS	BP4FS	
45XL	B6ES	
45XLS	BP5ES	8
46	B4	
46F	B5HS	
46FFS	BP5HS	
46N	B5ES	
46S	BP5S	
46TS	BP4FS	
46XL	B5ES	
46XLS	BP4ES	
47XL	B4ES	
83CTS	AP6FS	
83TS	AP6FS	
84T	A6FS	
84TS	AP5FS	
85T	A5FS	
85TS	AP5FS	
86TS	AP5FS	
B4031	B4	
B43	B6S	
B44S	BP5S	
B45	B4	
C42-1	B6S	
C42CFS	BP6HS	18
C42CLTS	BP6EFS	5
C42CXLS	BP6ES	4
C42LTS	BP6EFS	5
C42N	B7ES	
C42XLS	BP5ES	8
C43	B6S	
C43CXLS	BP6ES	4



<b>AC</b>	<b>→ NGK Typ</b>	<b>V-LINE</b>
C43L	B6L	
C43N	B6ES	
C44	B6S	
C44N	B6ES	
C44NS	BP5ES	8
C44S	BP5S	
C44XL	B6ES	
C45	B4	
C45L	B4L	
C49	B-2	
C73	G2Z	
C75	G2Z	
C81	A8	
C82	A7	
C83	A7	
C83T	A6FS	
C84T	A6FS	
C85TS	AP5FS	
C86	A6	
C87	A6	
C88	AB2	
C88L	AB2	
CFR1CLS	BCPR7ES	
CFR2CLS	BKR6E	28
CR42CFS	BPR6FS	
CR42CXLS	BPR6ES	2
CR42N	BR7ES	
CR43	BR6S	
CR43CXLS	BPR6ES	2
CR43K	BR6S	
CR43N	BR6ES	
CR43S	BP6S	
CR43TS	BPR5FS-11	
CR43TSM	BPR5FS-11	
CR44N	BR6ES	
CR44NS	BPR5ES	6
CR44TS	BPR5FS-11	
CR83T	AR6FS	
CS40	BM7A	
CS41	BM7A	
CS41T	BM7F	
CS42	BM7A	
CS42S	BM7A	
CS42T	BM6F	
CS45	BM6A	
CS45T	BM6F	
CS49	BM4A	
CSR45	BMR6A	
FR2LS	BKR6E	28
FR2LSK	BKR6E	28
FR3CLS	BKR5ES	
FR3CLS6	BKR5ES-11	

<b>AC</b>	<b>→ NGK Typ</b>	<b>V-LINE</b>
FR3LM	ZFR5A-11	
FR3LS	BKR5ES	
FR3LS6	BKR5ES-11	
FR3LSJ	BKR4E-11	
FR3LSK	BKR5ES	
FR4LE	ZFR4F-11	
FR4LSJ	BKR4E-11	
FR5LS	BCPR5ES	32
LM46	B4LM	
LM49	B4LM	
M40FFX	B9HS-10	
M41FF	B8HS	
M41K	B8S	
M42FF	B7HS	
M42K	B7S	
M43FF	B6HS	
M43S	BP6S	
M44C	B6S	
M44L	B6L	
M45	B4	
M45FF	B5HS	
M47	B4	
MB42K	B6S	
MR42K	BR6S	
MR43LTS	BPR6EFS	7
MR43T	BR6FS	
MR44C	BR6S	
MR44T	BR5FS	
R41-5TS	BPR6FS	
R41CF	BR7HS	
R41CXL	BR9ES	
R41CXLS	BPR7ES	19
R41TS	BPR6FS	
R42-5LTS	BPR6EFS	7
R42-5TS	BPR6FS	
R42-6FS	BPR6HS	3
R42CF	BR6HS	
R42CFS	BPR6HS	3
R42CLTS	BPR6EFS	7
R42CT	BR6FS	
R42CTS	BPR6FS	
R42CXL	BR8ES	
R42CXLS	BPR6ES	2
R42FS	BPR6HS	3
R42LTS	BPR6EFS	7
R42LTSM	BPR5EFS-13	
R42S	BP6S	
R42T	BR6FS	
R42TS	BPR6FS	
R42TSM	BPR6FS	
R42TX	BR6FS-15	
R42XL	BR8ES	



<b>AC</b>	<b>→ NGK Typ</b>	<b>V-LINE</b>
R42XLS	BPR6ES	2
R42XLSM	ZGR5C	
R43	BR6S	
R43C	BR6S	
R43CFS	BPR6HS	3
R43CNTSE	TR5-1/SR5	
R43CS	BP6S	
R43CT	BR6FS	
R43CTS	BPR6FS	
R43CTS6	BPR6FS	
R43CXL	BR7ES	
R43CXL6	BPR6ES	2
R43FS	BPR6HS	3
R43LTS	BPR6EFS	7
R43LTSE	TR4-2	
R43LTSX	BPR6EFS-13	
R43N	BR7ES	
R43NTSE	TR5-1/SR5	
R43S	BP6S	
R43T	BR6FS	
R43TS	BPR6FS	
R43TSK	BPR6FS	
R43TSX	BPR6FS	
R43TX	BR6FS-15	
R43XL	BR7ES	
R43XLS	BPR6ES	2
R44	BR6S	
R44CF	BR5HS	
R44CNTSE	TR5-1	
R44CXL	BR6ES	
R44F	BR5HS	
R44LTS	BPR5EFS	
R44LTS6	BPR5EFS-13	
R44LTS6K	BPR5EFS-13	
R44LTSM	TR4-2	
R44LTSM6	TR4-2	
R44N	BR6ES	
R44NS	BPR5ES	6
R44NTSE	TR5-1	
R44S	BP5S	
R44T	BR5FS	
R44TS	BPR5FS	
R44TSX	BPR5FS-15	
R44TX	BR5FS-15	
R44XL	BR6ES	
R44XLS	BPR5ES	6
R44XLS6	BPR4ES-13	
R44XLSE	ZGR5C	
R44XLSM	ZGR5C	
R45LTS6	BPR5EFS-13	
R45LTS6K	BPR5EFS-13	
R45NS	BPR5ES	6

<b>AC</b>	<b>→ NGK Typ</b>	<b>V-LINE</b>
R45NSX	BPR5ES-13	
R45NTSE	TR5-1	
R45S	BP5S	
R45T	BR5FS	
R45TS	BPR4FS	
R45TSX	BPR4FS-15	
R45XL	BR6ES	
R45XLS	BPR5ES	6
R46	BR6S	
R46LTS	BPR5EFS	
R46N	BR5ES	
R46S	BP4	
R46T	BR5FS	
R46TS	BPR4FS	
R46TSX	BPR4FS-15	
R46TX	BR5FS-15	
R46XL	BR5ES	
R46XLS	BPR4ES	
R47S	BP4	
R83CT	AR6FS	
R83CTS	APR6FS	
R83TS	APR6FS	
R84TS	APR5FS	
R85TS	APR5FS	
S102F	C7HSA	
S104F	C6HSA	
S121F	D8HA	
S121XL	D8EA	
S122F	D8HA	
S123XL	D7EA	
S124FS	D6HA	
S404XLG	B10EG	
S408XLG	B9EG	
S40F	B9HS	
S40FR	BR9HS	
S40XL	B10ES	
S40XLG	B9ECS	
S40XLR	BR8ES	
S41F	B8HS	
S41FG	B7HCS	
S41FR	BR8HS	
S41XL	B9ES	
S41XLG	B8ECS	
S41XLR	BR9ES	
S42	B7S	
S42F	B7HS	
S42FR	BR7HS	
S42XL	B8ES	
S42XLR	BR8ES	
S43XL	B7ES	
S43XLR	BR7ES	
S44	B6S	



<b>AC</b>	<b>→ NGK Typ</b>	<b>V-LINE</b>
S44F	B5HS	
S44XL	B6ES	
S45F	B5HS	
S46	B4	
S81F	A8	
S82F	A8	
S83F	A7	
S85F	A6	
SB41	B7S	
SV41XL	BUE	
V40FFK	BUHW-2	
V40FFM	BUHW	
V40FFS	BUH	
VB40FFM	BUHXW-1	
VR40FFK	BUZHW-2	
VR40FFM	BUZHW	
<b>ALFA ROMEO</b>	<b>→ NGK Typ</b>	<b>V-LINE</b>
4644 9690	BKR6EKPA	
55182623	FR5CP	
6056 9086	PGR6A	
6056 9957	PFR6B	
6057 9903	PFR6B	
6059 9495	PMR7A	
<b>APRILIA</b>	<b>→ NGK Typ</b>	<b>V-LINE</b>
0297542	DR8EA	
0297830	BR10EG	
0297921	CR8E	
0297942	DCPR9E	
0297945	R0045J-10	
0897055	BR8ES	
2BEN000088	BPR8HS	
2BEN000181	CPR8E	
2BEN000319	ZMR7AP	
8122586	DR7EA	
8206870	BR7HS	
8206871	BR8HS	
8550352	CR7E	
8600008	BR9ECM	
<b>APS</b>	<b>→ NGK Typ</b>	<b>V-LINE</b>
A11	B5HS	
A11P	BR5HS	
A14B	BP5HS	
A14B-2	BP5HS	
A14BM	BP5HS	
A14BP	BPR5HS	
A14DB	BP5ES	8
A14DBP	BPR5ES	6
A14DBPM	BPR5ES	6
A17B	BP6HS	18

<b>APS</b>	<b>→ NGK Typ</b>	<b>V-LINE</b>
A17DB	BP6ES	4
A17DB-10	BP6ES	4
A17DBM	BP6ES	4
A17DBP	BPR6ES	2
A17DBPM	BPR6ES	2
A20D	B7ES	
A23-2	B7HS	
A23B	BP7HS	
AY17DBPM	BCPR6ES-11	11
<b>AUTOLITE/TUNER</b>	<b>→ NGK Typ</b>	<b>V-LINE</b>
12	BP7FS	
13	BP6FS	
14	BP6FS	
15	BP5FS	
16	BP4FS	
23	BPR6FS	
24	BPR6FS	
25	BPR5FS	
26	BPR4FS-15	
27	BPR4FS-15	
34	AP6FS	
35	AP5FS	
36	AP5FS	
37	AP5FS	
43	APR6FS	
44	APR6FS	
45	APR5FS	
46	APR5FS	
52	BP7ES	
53	BP6ES	4
54	BP6ES	4
55	BP5ES	8
56	BP5ES	8
57	BP4ES	
62	BP7ES	
63	BPR6ES	2
64	BPR6ES	2
65	BPR5ES	6
66	BPR5ES	6
67	BPR4ES	
74	BP6S	
75	BP5S	
76	BP5S	
77	BP4	
84	BP6S	
85	BP5S	
86	BP4	
87	BP4	
94	BP7EFS	
102	BP7EFS	
103	BPR6EFS	7



<b>AUTOLITE/TUNER</b>	<b>→ NGK Typ</b>	<b>V-LINE</b>
104	BPR6EFS	7
105	BPR5EFS	
106	BPR5EFS	
115	A6FS	
117	A6FS	
124	AR6FS	
135	B7FS	
136	B6FS	
143	BR6FS	
144	BR6FS	
145	BR6FS	
146	BR5FS	
147	BR5FS	
156	AP5FS	
166	APR5FS	
175	BP5S	
203	BPR6FS	
215	B6L	
216	B6L	
217	B4L	
218	B4L	
235	BM6A	
245	BMR6A	
253	BM7A	
254	BM6A	
255	BM6A	
258	BM4A	
273	BP6HS	18
274	BP6HS	18
275	BP5HS	
276	BP5HS	
283	BPR7HS	
284	BPR6HS	3
292	B8S	
294	B6S	
295	B4	
297	B4	
298	B2	
302	BR6S	
303	BR6S	
304	BR6S	
306	B4	
308	B2	
312	B8S	
313	B7S	
314	B6S	
315	B6S	
316	B6S	
317	B4	
318	B2	
344	AR6FS	
353	B8S	

<b>AUTOLITE/TUNER</b>	<b>→ NGK Typ</b>	<b>V-LINE</b>
354	B6S	
355	B6S	
356	B4	
357	B4	
358	B2	
363	BR6S	
372	A8	
373	A7	
374	A7	
375	A6	
376	A6	
377	A6	
378	A6	
379	AB2	
386	A6	
393	B7ES	
394	B6ES	
395	B5ES	
396	B5ES	
397	B5ES	
398	B4ES	
402	BR8ES	
403	BR6ES	
404	BR6ES	
405	BR5ES	
406	BR5ES	
411	B9HS	
413	B7HS	
414	B6HS	
415	B5HS	
416	B5HS	
417	B4H	
424	B6HS	
425	BR5HS	
426	BR5HS	
436	B6L	
437	B4L	
456	B4LM	
458	B2LM	
483	BR7EFS	
494	B6L	
495	B6L	
497	B4L	
517	BP4H	
536	B4H	
584	AR6FS	
603	BPR6EFS-13	
604	BPR6EFS-13	
605	BPR6EFS-13	
646	BPR5ES-15	
664	BPR6FS	
665	BPR5FS-15	



<b>AUTOLITE/TUNER</b>	<b>→ NGK Typ</b>	<b>V-LINE</b>
666	BPR4FS-15	
667	BPR4FS-15	
683	BR6FS-15	
684	BR6FS-15	
685	BR6FS-15	
687	BR5FS-15	
723	BPR6FS	
724	BPR6FS	
725	BPR5FS-11	
726	BPR4FS	
727	BPR4FS-11	
744	APR5FS	
746	APR5FS	
747	APR5FS	
763	TR5-1	
764	BPR6EFS	7
765	BPR5EFS	
766	BPR5EFS	
784	AR6FS	
804	AR6FS	
865	BPR5EFS	
884	BPR6EFS-13	
915	ZGR5C	
925	ZGR5C	
935	BPR5ES	6
945	BPR5ES	6
985	ZF4A-11	
996	B6L	
2413	B10EGP	
2414	B10EG	
2415	B9EG	
2416	B8EG	
2417	B7ECS	
2543	TR5-1	
2544	TR5-1	
2545	TR5-1	
2546	TR5-1	
2585	BPR5ES	6
2592	B10ES	
2593	B9ES	
2594	B9ES	
2611	B10ES	
2612	B9ES	
2613	B9ES	
2614	B8ES	
2615	B7ES	
2616	B6ES	
2634	B9HS-10	
2635	B8HS	
2636	B7HS	
2652	B9HS-10	
2653	B7HS	

<b>AUTOLITE/TUNER</b>	<b>→ NGK Typ</b>	<b>V-LINE</b>
2654	B7HS	
2655	B6HS	
2656	B5HS	
2675	B6L	
2676	B6L	
2695	A8	
2696	A7	
2697	A6	
2715	D8HA	
2716	D6HA	
2735	D6HA	
2755	D8EA	
2772	A8	
2775	A6	
2794	C8HSA	
2795	C7HSA	
2796	C6HSA	
2852	BUH	
2872	BUHW	
2892	BUHX	
2932	BUE	
2954	BM7F	
2956	BM6F	
2974	BPM7A	
2976	BPMR7A	
3013	B7S	
3014	B6S	
3035	A6	
3036	BPR4FS-15	
3055	A6FS	
3074	G2Z	
3075	G2Z	
3116	A6	
3203	BPR6ES	2
3204	BPR6ES	2
3205	BPR5ES	6
3206	BPR5ES	6
3207	BPR5ES	6
3224	BP6S	
3225	BP5S	
3226	BP5S	
3227	BP5S	
3243	BPR6EFS	7
3244	BPR6EFS	7
3245	BPR5EFS	
3246	BPR5EFS	
3264	B7FS	
3265	BR6FS	
3266	BR5FS	
3267	BR5FS	
3286	APR6FS	
3303	BPR6FS	



<b>AUTOLITE/TUNER</b>	<b>→ NGK Typ</b>	<b>V-LINE</b>
3325	B6L	
3327	B4L	
3345	BMR7A	
3364	BPR6HS	3
3382	BR6S	
3383	BR6S	
3384	BR6S	
3386	BR6S	
3388	BR6S	
3404	AR6FS	
3423	B8S	
3426	BR6S	
3446	AR6	
3462	BR7ES	
3463	BR6ES	
3464	BR6ES	
3465	BR5ES	
3466	BR5ES	
3485	BR5HS	
3486	BR5HS	
3507	B6L	
3565	BPR5EFS	
3586	BPR5ES-15	
3604	BPR5FS-15	
3605	BPR4FS-15	
3606	BPR4FS-15	
3607	BPR4FS-15	
3624	BR6FS	
3625	BR6FS-15	
3627	BR5FS-15	
3666	B4LM	
3684	BR7HS	
3686	BR6HS	
3702	BR9ES	
3703	BR9ES	
3704	BR8ES	
3705	BR6ES	
3706	BR6ES	
3724	BPR5EFS	
3885	ZGR5C	
3896	ZGR5C	
3922	BCPR7ES	
3924	BKR6E	28
3926	BKR5ES	
3954	D8EA	
3964	DR8ESL	
3985	BPR5FS-15	
4043	BPR6ES-11	13
4052	B9ES	
4053	B9ES	
4054	B8ES	
4055	B7ES	

<b>AUTOLITE/TUNER</b>	<b>→ NGK Typ</b>	<b>V-LINE</b>
4056	B6ES	
4062	BR9ES	
4063	BR9ES	
4092	B7HS	
4093	B7HS	
40TS	BP7FS	
4113	BP6HS	18
4114	BP6HS	18
4123	BPR6HS	3
4132	D8EA	
4143	DR8ESL	
4152	DP9EA-9	
4153	DP8EA-9	
4162	DPR9EA-9	
4163	DR8ESL	
4164	D7EA	
4173	D8HA	
4193	C7HSA	
4203	CR7HS	
4251	BP8ES	
4252	BP7ES	
4253	BP6ES	4
4263	BPR6ES	2
4265	BPR5ES	6
4275	BP5S	
5143	TR5-1	
9062	BP6ET	
9063	BP6ET	
9064	BP5ET	
9921	BCPR6ET	
AP63	PFR6B	
<b>BERU</b>	<b>→ NGK Typ</b>	<b>V-LINE</b>
125/14/3	B5ES	
125/14/3A	BP5ES	8
12-5DU	D7EA	
14-10A	B4H	
14-10B	BP4HS	
14-10C	B4ES	
14-10D	BP4ES	
14-10E	B4	
14-10F	BP4	
14-2AS1	B9HCS	
14-3A1	B8HS	
14-3AS1	B8HVX	
14-3AU	B8HS	
14-3CS1	B8EVX	
14-3DP2	B8EVX	
14-4A1	B8HS	
14-4A2	B7HS	
14-4AS1	B8HVX	
14-4AU	B7HS	





<b>BERU</b>	<b>→ NGK Typ</b>	<b>V-LINE</b>
14-4B2	BP7HS	
14-4C1	B8ES	
14-4C2	B7ES	
14-4CS1	B8EVX	
14-4DPO	BP7ES	
145/14	B5HS	
145/14/3	B5ES	
145/14/3A	BP5ES	8
145/14/5	B4	
145/14/5A	BP5S	
145/14/5AMX	BPM6A	
145/18	A6	
145/18K	AP5FS	
145/1A	BP5HS	
14-5A	B7HS	
14-5AU	B7HS	
14-5B	BP7HS	
14-5BU	BP7HS	
14-5C	B7ES	
14-5CS	B7ECS	
14-5D	BP7ES	
14-5D1	BP7ES	
14-5DP1	BP7ES	
14-5DTU	BP6ET	
14-5DU	BP7ES	
14-5DUO	BP7ES	
14-5E	B7S	
14-5F	BP6S	
14-6B	BP6HS	18
14-6BU	BP6HS	18
14-6C	B6ES	
14-6D	BP6ES	4
14-6D1	BP6ES	4
14-6DPO	BP6ES	4
14-6DTU	BP6ET	
14-6DU	BP6ES	4
14-6DUO	BP6ESZ	
14-7A	B6HS	
14-7AU	B6HS	
14-7B	BP6HS	18
14-7BU	BP6HS	18
14-7C	B6ES	
14-7CU	B6ES	
14-7D	BP6ES	4
14-7DTU	BP6ET	
14-7DU	BP6ES	4
14-7DUO	BP6ESZ	
14-7E	B6S	
14-7F	BP6S	
14-8A	B5HS	
14-8AU	B5HS	
14-8B	BP5HS	

<b>BERU</b>	<b>→ NGK Typ</b>	<b>V-LINE</b>
14-8BU	BP5HS	
14-8C	B5ES	
14-8C1	B6ES	
14-8D	BP5ES	8
14-8DTU	BP5ET	
14-8DTU EA1,0	BP5ET-10	
14-8DU	BP5ES	8
14-8DUO	BP5ES	8
14-8E	B4	
14-8F	BP5S	
14-8LUR	ZGR5A	15
14-9C	B5ES	
14-9D	BP5ES	8
14-9DTU	BP5ET	
14-9DU	BP5ES	8
14-9DUO	BP5ES	8
14-9EUO	B4LM	
14F-03DAR	BKR6EK	20
14F4DPUR03	PFR8B-9	
14F-5DU	BCP7ES	
14F6DPUR021	PFR7Q	
14F-6DSR	BKR6E	28
14F-6DTU	BCP6ET	
14F-6DUO	BCP6ES	17
14F-6DUOR	BKR6E	28
14F-7DU	BCP6ES	17
14F-7DUO	BCP6ES	17
14F-7DUOR	BKR6E	28
14F7HUR2	ZFR5P-G	
14F-7LDUR	BKR6EK	20
14F-7LDUR4	BKR6EK	20
14F-8DU	BCP5ES	16
14F-8DU4	BCP5ES	16
14F-8DUO	BCP5ES	16
14F-8LDUSR	BKR6EK	20
14F-8LUR	ZFR5F	
14F-9DUO	BCP5ES	16
14FGH-6DTUR	BKUR7ET	
14FGH-78DPURX2	IFR6D10	
14FGH-7DTURX	BKUR6ET-10	24
14FGH-8DPURX2	IFR5D10	
14FGH-8DTURXO	BKUR5ET	
14FGR-6DDU	BKR6EKUB	
14FGR-7CTU	BCPR7ET	
14FLR-8LDUX	BKR5EK	23
14FR-5DTU	BCPR7ET	
14FR-5DU	BCPR7ES	
14FR-6DU	BKR6E	28
14FR-6DUX	BCPR6ES-11	11
14FR6LDU	BKR6EK	20



<b>BERU</b>	<b>→ NGK Typ</b>	<b>V-LINE</b>
14FR-6LDU3	BKR6EKE	Smart
14FR-7DU	BKR6E	28
14FR-7DUX	BKR6E-11	14
14FR-7DUX	BKR6ES-11	
14FR-7HUR2	ZFR5P-G	
14FR-7KPU	BKR6EP-8	
14FR-7KPUV	BCPR6EP-11	
14FR-7KPUX	BCPR6EP-11	
14FR-7KU	BKR6EY	
14FR-7KU0	BKR6EYA	
14FR-7LDU	BKR6EKC	26
14FR-8DU	BCPR5ES	32
14FR-8DU	BKR5E	35
14FR-8DUX	BCPR5ES-11	
14FR-8HU	BCRE527Y	
14FR-8KU	BKR5EY	
14FR-8KU0	BKR5EYA	
14G-8DTU	BP6ET	
14GH-7DTUR	BUR6ET	1
14GH-8DTUR	BUR5ET	22
14GH-8DTUREA	BUR5ET	22
14GH-8DTURX	BUR5ET-10	21
14GR-8DTU	BPR5EKU	
14K-5DU	BP7EFS	
14K-5DU0	BP7EFS	
14K-6D	BP6EFS	5
14K-6DU	BP6EFS	5
14K-6DU0	BP6EFS	5
14K-7D	BP6EFS	5
14K-7DU	BP6EFS	5
14K-7DU0	BP6EFS	5
14K-8DU	BP5EFS	
14K-8DU0	BP5EFS	
14K-9DU	BP5EFS	
14K-9DU0	BP5EFS	
14KGR-6KQU	BUR6EFSZ	
14KR-6BU	BPR6FS	
14KR-6DU	BPR6EFS	7
14KR-6ZPPV	PTR5A-13	25
14KR-7DUX	BPR6EFS	7
14KR-8DPUOV	TR55	
14KR-8MUV	PTR5A-13	25
14R-11F	BP4	
14R-5DU	BPR7ES	19
14R-6B	BPR6HS	3
14R-6BU	BPR6HS	3
14R-6D	BPR6ES	2
14R-6DU	BPR6ES	2
14R-6DUX	BPR6ES-11	13
14R-6DUX	BUR6EA-11	
14R-7B	BPR6HS	3
14R-7BU	BPR6HS	3

<b>BERU</b>	<b>→ NGK Typ</b>	<b>V-LINE</b>
14R-7CU	BR6ES	
14R-7D	BPR6ES	2
14R-7DU	BPR6ES	2
14R-7DUX	BPR6EY-11	10
14R-8DU	BPR5EY	9
14R-8DUX	BPR5ES-11	
14R-9DU	GR4	
14R-9DU	BPR5ES	6
14R-9EU0	BR4LM	
14S-5A	BL6H	
14S-5F	BPM7A	
14S-7A	BL6H	
14S-7F	BPM6A	
14S-8F	BPM6A	
14SR-6F	BPMR6A	
14-XAU	B6HS	
14Z-2C1	B9EVX	
14Z-3A1	B9HS	
14Z-3AU	B8HS	
14Z-3C1	B9ES	
14Z-3CU	B8ES	
14Z-4AU	B8HS	
14Z-6A2	B6HS	
14Z-7AU	B7HS	
160/14/3	B6ES	
175/14	B6HS	
175/14/3	B6ES	
175/14/3A	BP6ES	4
175/14/5	B6S	
175/14/5A	BP6S	
175/14/5AMX	BPM6A	
175/14/UK4	BL6H	
175/14A	BP6HS	18
175/18	A6	
175/18K	AP6FS	
18-10A	A6	
18-10AU	A6	
18-12B	AB2	
18-4A1	A7	
18-4A2	A7	
18-5A	A7	
18-5AS	A7	
18-5AU	A7	
18-7A	A6	
18-7AU	A7	
18-8A	A6	
18K-12B	AP5FS	
18K-6BU	AP6FS	
18K-7B	AP6FS	
18K-7BU	AP6FS	
18K-8B	AP5FS	
18K-8BU	AP5FS	



<b>BERU</b>	<b>→ NGK Typ</b>	<b>V-LINE</b>
190/14Z	B6HS	
200/14/3	B6ES	
200/14/3A	BP6ES	4
200/14/3K	BP6EFS	5
200/14A	BP6HS	18
215/14/3A	BP6ES	4
225/14	B7HS	
225/14/3	B7ES	
225/14/3A	BP7ES	
225/14/3S	B7ECS	
225/14/5	B7S	
225/14/5A	BP6S	
225/14/5AMX	BPM7A	
225/14/UK4	BL6H	
225/14A	BP7HS	
225/18	A7	
225/18S	A7	
230/14/3A	BP7ES	
235/14/3P	BP7ES	
240/14	B7HS	
240/14/3	B7ES	
240/14A	BP7HS	
240/14S	B8HVX	
240/18	A7	
260/14	B8HS	
260/14/3	B8ES	
260/14S	B8HVX	
260/18	A8	
265/14/3P	B8EVX	
280/14	B8HS	
280/14/3S	B8EVX	
280/14/3Z	B9ES	
280/14Z	B9HS	
310/14/3Z	B9EVX	
310/14S	B9HCS	
45/18	AP5FS	
95/14	B4H	
95/14/3	B4ES	
95/14/3A	BP4ES	
95/14/5	B4	
95/14/5A	BP-4	
95/14A	BP4HS	
95/18	A6	
D 215/14/3 (14/5/C)	B7ES	
D175/14	B6HS	
D175/14/3	B6ES	
D200/14/3A	BP6ES	4
D215/14/3	BP6ES	4
D230/14/3A	BP7ES	
G 3/18	A9EFP	
G 5	---	
G 6	---	

<b>BERU</b>	<b>→ NGK Typ</b>	<b>V-LINE</b>
RS16	BP6HVX	
RS18	BP7HVX	
RS33	BPR5EVX	
RS35	BP6EVX	
RS37	BP7EVX	
RS39	BP7EVX	
Z 1	BP5ES	8
Z 2	BP5ET	
Z 3	ZGR5A	15
Z 4	ZFR5F	
Z 5	BCP5ES	16
Z 6	BP5EFS	
Z 7	BP5EFS	
Z 8	BPR5ES	6
Z 9	BPR5ES-11	
Z 10	BP6HS	18
Z 11	BP6ES	4
Z 12	BP6ET	
Z 13	BKR6E	28
Z 14	BKR6EK	20
Z 15	BKR6E	28
Z 16	BCPR6ES-11	11
Z 17	BP6EFS	5
Z 18	BP6EFS	5
Z 19	BPR6HS	3
Z 20	BPR6ES	2
Z 21	BPR6ES-11	13
Z 22	BP6ES	4
Z 23	BKR6E	28
Z 24	BKR6E	28
Z 25	BP6EFS	5
Z 26	BPR6EFS	7
Z 27	BPR6ES	2
Z 28	BPR6ES-11	13
Z 29	BCP7ES	
Z 30	BCPR7ES	
Z 31	BP7EFS	
Z 32	AP6FS	
Z 33	AP6FS	
Z 35	D7EA	
Z 36	D7EA	
Z 37	B9HS	
Z 38	B9ES	
Z 39	B8HS	
Z 40	B7HS	
Z 41	BP7HS	
Z 42	BP7ES	
Z 43	BP7ES	
Z 44	BP6ET	
Z 45	BCPR7ET	
Z 46	BP7EFS	
Z 47	BPR7ES	19



<b>BERU</b>	<b>→ NGK Typ</b>	<b>V-LINE</b>
Z 48	BP6HS	18
Z 49	BPR6FS	
Z 50	BP6ESZ	
Z 51	BP6ET	
Z 52	BCP6ET	
Z 53	BCP6ET	
Z 54	BCP6ES	17
Z 55	BP6EFS	5
Z 56	BP6EFS	5
Z 57	B6HS	
Z 58	B6ES	
Z 59	BR6ES	
Z 60	BCPR7ET	
Z 61	BP6ESZ	
Z 62	BP6ESZ	
Z 63	BCP6ES	17
Z 64	BCP6ES	17
Z 66	BP6EFS	5
Z 67	BPR6EFS-13	
Z 68	B5HS	
Z 69	BP5ESZ	
Z 70	BP5ESZ	
Z 71	BCP5ES	16
Z 72	BCPR5ES	32
Z 73	BCPR5ES-11	
Z 74	BKR5EK	23
Z 75	BUR5ET	22
Z 76	BP5ES	8
Z 77	BP5ESZ	
Z 78	BP5ET	
Z 79	BCP5ES	16
Z 80	BP5EFS	
Z 81	BP5EFS	
Z 82	BPR5ES	6
Z 83	B4LM	
Z 84	BR4LM	
Z 85	B6HS	
Z 86	A7	
Z 87	A7	
Z 88	A6	
Z 89	BKUR6ET	27
Z 90	BKUR6ET-10	24
Z 91	BUR6ET	1
Z 92	BUR5ET	22
Z 93	BUR5ET-10	21
Z 94	BPR5EKU	
Z 95	BPR6EFS	7
Z 97	PTR5A-13	25
Z 99	BCPR6ES-11	11
Z 100	BKR6ES	28
Z 101	BKR6EK	20
Z 103	BP7ES	

<b>BERU</b>	<b>→ NGK Typ</b>	<b>V-LINE</b>
Z 104	BP6ES	4
Z 105	BKR6E	28
Z 107	BP4	
Z 112	B4	
Z 144	BUR6EFSZ	
Z 145	BKR6EKUB	
Z 148	TR55	
Z 149	BCPR6EP-11	
Z 150	BCPR6EP-11	
Z 151	BKR6EP-8	
Z 152	BCRE527Y	
Z 153	BKR5EY	
Z 154	BKR5EYA	
Z 155	BKR6EY	
Z 156	BKR6EYA	
Z 157	BKR6EYA-11	
Z 158	ZFR6F-11	
<b>BM3 (Bulgaria)</b>		
<b>→ NGK Typ</b>	<b>V-LINE</b>	
L15Y	BP6ES	4
N15	B7HS	
N15Y	BP6HS	18
N17	B6HS	
<b>BM3 / VMZ</b>		
<b>→ NGK Typ</b>	<b>V-LINE</b>	
L15Y	BP6ES	4
N15	B7HS	
N15Y	BP6HS	18
N17	B6HS	
<b>BMW</b>		
<b>→ NGK Typ</b>	<b>V-LINE</b>	
11127675485	KR9CI	
11127699116	KR9CI	
12120032134	IZFR6H11	
12120032136	BKR6EQU	
12120032137	ILZFR6D11	
12120034091	PLZKBR7AP-HTU	
12120034094	R6601-9	
12120034098	PLZKBR7A-G	
12120035531	ILZKBR7A-8G	
12120035915	PLZFR6A-11S	
121200708	BKR7EQUP	
12120141871	BKR6EQUP	
12121435955	BKR6EQUP	
12122343144	D8EA	
12127526799	IZFR6H11	
12127650676	BKR7EKC	
12127653439	CR8EB	
12127653771	BKR7EKC	
12127671301	DCPR8EKC	
12127671302	BKR7EKC	
12127677560	DCPR8EKC	



<b>BMW</b>	<b>→ NGK Typ</b>	<b>V-LINE</b>
12127699116	KR9CI	
12127835198	LKR8AP	
12129061870	ZFR5F	
12129063428	BKR6EK	20
12129064617	BKR6EK	20
12129064619	BKR6EK	20
12129064656	BKR6EK	20
12129065366	BKR6EK	20
12129069048	PKR7A	
12129071003	BKR6EQUP	30
12129071003	BKR6EQUP	30
<b>BOSCH</b>	<b>→ NGK Typ</b>	<b>V-LINE</b>
D10B	AP5FS	
D10BC	AP5FS	
D6B	AP6FS	
D6BC	AP6FS	
D6BP	AP6FS	
D7A	A6FS	
D7AC	A6FS	
D7B	AP6FS	
D7BC	AP6FS	
D7BP	AP6FS	
D8A	A5FS	
D8AC	A5FS	
D8B	AP5FS	
D8BC	AP5FS	
D8BP	AP5FS	
D9B	AP5FS	
D9BC	AP5FS	
DR10B	APR5FS	
DR10BC	APR5FS	
DR6BC	APR6FS	
DR6BP	APR6FS	
DR7BC	APR6FS	
DR7BP	APR6FS	
DR8B	APR5FS	
DR8BC	APR5FS	
DR8BP	APR5FS	
DR9B	APR5FS	
DR9BC	APR5FS	
F04DAR	BKR6EK	20
F09CS	R7115-10	resitor
F09CS	R7114-10	not resitor
F2CS	R7114-9	ex R6205-9
F3CS	R7114-9	ex R6205-9
F4CS	R6205-8	
F5DC	BCP7ES	
F5DP	BCP7ES	
F5DPOR	PFR7B	
F5DTC	BCP7ET	
F6DC	BCP6ES	17

<b>BOSCH</b>	<b>→ NGK Typ</b>	<b>V-LINE</b>
F6DC0	BCP6ES	17
F6DCOR	BKR6E	28
F6DCX	BCP6ES-11	
F6DP	BCP6ES	17
F6DPOR	PFR6Q	
F6DPX	BCP6ES-11	
F6DSR	BKR6EVX	
F6DTC	BCP6ET	
F6KPP332S	PFR6Q	
F6LTCR	BKUR7ET	
F6MPP332	ILFR6A	
F7DC	BCP6ES	17
F7DC0	BCP6ES	17
F7DCOR	BKR6E	28
F7DCX	BCP6ES-11	
F7DER	BKR6E	28
F7DP	BCP6ES	17
F7DPP332	IFR6D10	
F7DTC	BCP6ET	
F7HER2	ZFR5P-G	
F7HPP22	BKUR6ET-10 / PFR6Q	24
F7HPP222	PZFR5D-11	34
F7HPP222U	PZFR6J-11	
F7KPP332U	PFR6X-11	
F7KTCR	BKUR6ET-10	24
F7LCOR2	ZFR6F-11	
F7LCR	ZFR6A-11	
F7LDCR	BKR6EK / BKR6EQUP	20
F7LTCR	BKUR6ET-10 / PFR6Q	24
F8DC	BCP5ES	16
F8DC4	BCP5ES	16
F8DC0	BCP5ES	16
F8DCOR	BCPR5ES / BKR5E	
F8DCX	BCP5ES-11	
F8DPER	IFR5D10	
F8DPP332	IFR5D10	
F8KTCR	BKUR5ET	
F8LCR	ZFR5F	
F8LCR2	ZFR5F	
F8LDCR	BKR6EK	20
F9DC0	BCP4ES	
F9LCR	ZFR4F-11	
FGR5KQEO	BKR7EQUP	
FGR6HQEO	ZFR6S-Q	
FGR6KQC	BKR6EQUP	
FGR6KQE	BKR6EQUP	
FGR7DQEO	BKR6EKUB	
FGR7DQP	BKR6EQUP	
FGR7KQC	BKR6EQUP	
FGR7KQE	BKR6EQUP	



<b>BOSCH</b>	<b>→ NGK Typ</b>	<b>V-LINE</b>
FGR7KQEO	BKR6EQUF	
FGR8KQEO	BKR5EQUPA	
FGR8MQPE	PLFR5A-11	
FLR8LDCU	BKR5EK	23
FO3DAR	BKR6EK	
FQR8LEU2	ZFR5F	
FR10DCX	BCPR4ES-11	
FR10DX	BCPR4ES-11	
FR2LS	BCPR6ES	
FR5DC	BCPR7ES	
FR5DCX	BCPR7ES-11	
FR5DP	BCPR7ES	
FR5DTC	BCPR7ET	
FR5LDC	BKR7EKC	
FR6DC	BKR6E	28
FR6DC2 0,7	BKR6E	28
FR6DC0	BKR6EK	20
FR6DCX	BCPR6ES-11	11
FR6DDC	BKR7EKC	
FR6DP	BKR6E	28
FR6DP1X	PFR6J-11	
FR6DPX	BCPR6ES-11	11
FR6DTC	BCPR6ET	
FR6DTCW	BKR5EKC	
FR6KDC	BKR6EZ	
FR6KTC	BKUR6ETB	
FR6LDC	BKR6EK	20
FR6LDC	BKR6EKC	26
FR6MPP10	LFR6AP	
FR6Mpp10	PLFR6A	
FR7DC	BKR6E	28
FR7DC2	BKR6E	28
FR7DC0	BKR6E	28
FR7DCX	BCPR6ES-11	11
FR7DE	BKR6EZ	
FR7DP	BKR6E	28
FR7DP1X	PFR6B-11	
FR7DPP10	BKR6EVX	
FR7DPX	BCPR6ES-11	11
FR7DTC	BCPR6ET	
FR7HE2	ZFR5P-G	
FR7KCW	BKR6EP-13	
FR7KDC	BKR6EZ	
FR7KPP332	IZFR6H11	
FR7LC2	BKR6E	28
FR7LCX	ZFR6F-11	
FR7LDC	BKR6EKC	26
FR7NPP332	ILZFR6D11	
FR8DC	BKR5ES	
FR8DC0	BKR5ES	
FR8DCX	BKR5ES-11	
FR8DPX	BKR5ES-11	

<b>BOSCH</b>	<b>→ NGK Typ</b>	<b>V-LINE</b>
FR8DS	BKR5EVX	
FR8DX	BKR5ES-11	
FR8HP	ZFR5F-11	
FR8KCU	BKR5EYA-11	
FR8LCX	ZFR6F-11	
FR8LDC	BKR5EK	23
FR8LDC4	BKR5EK	23
FR8ME	LFR5B	
FR9DCX	BCPR4ES-11	
FR9HC	ZFR4F-11	
H10B	BP4FS	
H10BC	BP4FS	
H2CS	B9EFS	
H3CS	B8EFS	
H5D	BP7EFS	
H5DC	BP7EFS	
H5DC0	BP7EFS	
H5DP	BP7EFS	
H6B	BP6FS	
H6BC	BP6FS	
H6D	BP6EFS	5
H6DC	BP6EFS	5
H6DC0	BP6EFS	5
H6DP	BP6EFS	5
H7CC	B6EFS	
H7CP	B6EFS	
H7D	BP6EFS	5
H7DC	BP6EFS	5
H7DC0	BP6EFS	5
H7DCY	BP6EFS-13	
H7DP	BP6EFS	5
H7DPY	BP6EFS-13	
H8B	BP5FS	
H8BC	BP5FS	
H8BP	BP5FS	
H8DC	BP5EFS	
H8DC0	BP5EFS	
H8DCX	BP5EFS-13	
H8DP	BP5EFS	
H9B	BP4FS	
H9BC	BP4FS	
H9BCY	BPR4FS-15	
H9DC	BP5EFS	
H9DC0	BP5EFS	
H9HP	BP5EFS	
HGR6KQC	BUR6EFSZ	
HGR7KQC	BUR6EFSZ	
HR10A	BR5FS	
HR10AC	BR5FS	
HR10ACY	BR5FS-15	
HR10AY	BR5FS-15	
HR10B	BPR4FS	



<b>BOSCH</b>	<b>→ NGK Typ</b>	<b>V-LINE</b>
HR10BC	BPR4FS	
HR10BCX	BPR4FS-11	
HR10BCY	BPR4FS-15	
HR10BX	BPR4FS-11	
HR10BY	BPR4FS-15	
HR6B	BPR6FS	
HR6BP	BPR6FS	
HR6D	BPR6EFS	7
HR6DC	BPR6EFS	7
HR6DP	BPR6EFS	7
HR6DS	BPR6EFS	7
HR7DC	BPR6EFS	7
HR7MPP	PTR5A-13	25
HR8A	BR5FS	
HR8AC	BR5FS	
HR8ACY	BR5FS-15	
HR8AP	BR5FS	
HR8APY	BR5FS-15	
HR8AY	BR5FS-15	
HR8B	BPR5FS	
HR8BC	BPR5FS	
HR8BCY	BPR5FS-15	
HR8BP	BPR5FS	
HR8BPX	BPR5FS-11	
HR8BPY	BPR5FS-15	
HR8BY	BPR5FS-15	
HR8LCO	TR5-1	
HR8LPO	TR5-1	
HR9A	BR5FS	
HR9AC	BR5FS	
HR9ACY	BR5FS-15	
HR9AP	BR5FS	
HR9APY	BR5FS-15	
HR9AY	BR5FS-15	
HR9B	BPR4FS	
HR9BC	BPR4FS	
HR9BCY	BPR4FS-15	
HR9BPX	BPR4FS-11	
HR9BPY	BPR4FS-15	
HR9BY	BPR4FS-15	
HR9D	BPR5EFS	
HR9DC	BPR5EFS	
HR9DCX	BPR5EFS-13	
HS5E	BM7F	
HS8E	BM6F	
M10A	A6	
M10AC	A6	
M10ACO	A6	
M10AO	A6	
M12B	A6	
M145T1	A6	
M145T5	A6	

<b>BOSCH</b>	<b>→ NGK Typ</b>	<b>V-LINE</b>
M175T1	A6	
M225P11S	A7	
M225T1	A7	
M240T1	A7	
M280T1	A8	
M45T1	A6	
M4A	A7	
M4A1	A8	
M4A2	A7	
M4AC	A7	
M5A	A7	
M5AC	A7	
M7A	A6	
M7AC	A7	
M8A	A6	
M8AC	A6	
M8AO	A6	
M95T1	A6	
M95T5	A6	
MA145T1	A5FS	
MA145T7	AP5FS	
MA145TR7	APR5FS	
MA175T1	A6FS	
MA175T7	AP6FS	
MA200T7	AP6FS	
UR2AS	CR8HS	
UR3AS	CR7HS	
UR4AS	CR6HS	
USR7AC	CMR6H	
VR8SEW	LZKAR7A	
W06AS	B10HVX	
W06CS	B11EGV	
W07AS	B10HVX	
W07CS	B10EGV	
W08AS	B9HVX	
W08CS	B10EGV	
W10A	B4H	
W10AC	B4H	
W10C	B4ES	
W10CC	B4ES	
W10D	BP4ES	
W10DC	BP4ES	
W10E	B4	
W10F	BP4	
W10FC	BP4	
W125T1	B4H	
W125T2	B4ES	
W125T3	B4	
W125T30	BP5ES	8
W125T4	B4H	
W125TR2	BR5ES	
W125TR3	BR6S	



<b>BOSCH</b>	<b>→ NGK Typ</b>	<b>V-LINE</b>
W125TR30	BPR5ES	6
W12A	B4H	
W12E	B2	
W145T1	B5HS	
W145T1.1	B5HS	
W145T2	B5ES	
W145T3	B6S	
W145T30	BP5ES	8
W145T35	BP5HS	
W145TR2	BR5ES	
W145TR3	BR6S	
W145TR30	BPR5ES	6
W175T1	B6HS	
W175T2	B6ES	
W175T3	B6S	
W175T30	BP6ES	4
W175T35	BP6HS	18
W175T6	BP6S	
W175T7	BP6HS	18
W175TR1	BR6HS	
W175TR30	BPR6ES	2
W175Z1	B6HS	
W190M11S	B6HVX	
W200T27	BP6ES	4
W200T30	BP6ES	4
W200T35	BP6HS	18
W200TR30	BPR6ES	2
W215P21	BPR7EIX	
W215T30	BP6ES	4
W225T1	B7HS	
W225T2	B7ES	
W225T3	B7S	
W225T30	BP8ES	
W225T35	BP7HS	
W225T7	BPR7HS	
W225TR30	BPR7ES	19
W230T30	BP7ES	
W235T28	BP8ES	
W240M1	B8HS	
W240MZ1	B8HS	
W240T1	B8HS	
W240T2	B8ES	
W240T28	B8ES	
W240T3	B7S	
W250P21	BP7ES	
W250T1	B8HS	
W250T2	B8ES	
W255T30	BP7ES	
W260M1	B8HS	
W260MZ1	B8HS	
W260MZ2	B9ES	
W260S1S	B8HVX	

<b>BOSCH</b>	<b>→ NGK Typ</b>	<b>V-LINE</b>
W260S2S	B8EVX	
W260T1	B8HS	
W260T2	B9ES	
W260T20	B8ES	
W265P21	BPR9EVX	
W275T1	B8HS	
W275T2	B9ES	
W280MZ1	B8HS	
W280MZ2	B9ES	
W280S1S	B9HVX	
W280S2S	B9EVX	
W280T30	BP8ES	
W2A	B9HS	
W2AC	B9HS	
W2AS	B9HVX	
W2C	B10ES	
W2CC	B10ES	
W2CO	B10ES	
W2CS	B10EVX	
W2D	BP9ES	
W300MZ2	B10ES	
W300T1	B9HS	
W300T2	B10ES	
W300T30	BP9ES	
W310S1S	B9HVX	
W310S2S	B10EVX	
W3A	B8HS	
W3AC	B8HS	
W3A0	B8HS	
W3AP	B8HS	
W3AS	B8HVX	
W3C	B9ES	
W3CC	B9ES	
W3CO	B9ES	
W3CP	B9ES	
W3CS	B9EVX	
W3D	BP8ES	
W3DP	BP8EVX	
W3DP2	BP8ES	
W3DPO	BP8EVX	
W45T1	B4H	
W4A	B8HS	
W4A1	B8HS	
W4A2	B8HS	
W4A5	B8HS	
W4AC	B8HS	
W4AP	B8HS	
W4AS	B8HVX	
W4C	B8ES	
W4C1	B8ES	
W4C2	B7ES	
W4C3	B7HS	





<b>BOSCH</b>	<b>→ NGK Typ</b>	<b>V-LINE</b>
W4CC	B8ES	
W4CP	B8EVX	
W4CPX	B8ES-11	
W4CS	B8EVX	
W4DP	BP7EVX	
W4DPO	BP8EVX	
W4E2	B7S	
W5A	B7HS	
W5AC	B7HS	
W5AP	B7HS	
W5AS	B7HVX	
W5B	BP7HS	
W5BC	BP7HS	
W5BP	BP7HS	
W5C	B7ES	
W5CC	B7ES	
W5CCX	B7ES-11	
W5CP	B7ES	
W5CPX	B7ES-11	
W5CS	B7EVX	
W5D	BP7ES	
W5D1	BP7ES	
W5DC	BP7ES	
W5DCO	BP7ES	
W5DCX	BP7ES-11	
W5DP	BP7ES	
W5DPO	BP7EVX	
W5DPX	BP7ES-11	
W5DTC	BP6ET	
W5E	B7S	
W5EC	B7S	
W5EP	B7S	
W6AS	B6HVX	
W6B	BP6HS	18
W6BC	BP6HS	18
W6BP	BP6HS	18
W6D	BP6ES	4
W6D1	BP6ES	4
W6DC	BP6ES	4
W6DC 0,8	BP6ES	4
W6DCO	BP6ES	4
W6DCO 0,8	BP6ESZ	
W6DCX	BP6ES-11	
W6DP	BP6EVX	
W6DPO	BP6EVX	
W6DPX	BP6EVX (1,1)	
W6DTC	BP6ET	
W7A	B6HS	
W7AC	B6HS	
W7AO	B6HS	
W7AP	B6HS	
W7B	BP6HS	18

<b>BOSCH</b>	<b>→ NGK Typ</b>	<b>V-LINE</b>
W7BC	BP6HS	18
W7BP	BP6HS	18
W7C	B6ES	
W7CC	B6ES	
W7CCO	B6ES	
W7CCX	B6ES-11	
W7CP	B6ES	
W7CPX	B6ES-11	
W7CX	B6ES-11	
W7D	BP6ES	4
W7D0	BP6ES	4
W7DC	BP6ES	4
W7DCO	BP6ESZ	
W7DCR	BPR6ES	2
W7DCX	BP6ES-11	
W7DO	BP6ES	4
W7DP	BP6ES	4
W7DPX	BP6ES-11	
W7DTC	BP6ET	
W7DTC 1,0	BP6ET	
W7DX	BP6ES-11	
W7E	B6S	
W7EC	B6S	
W7EP	B6S	
W7F	BP6S	
W7FC	BP6S	
W7LTCR	BUR6ET	1
W8A	B5HS	
W8AC	B5HS	
W8AO	B5HS	
W8AP	B5HS	
W8B	BP5HS	
W8BC	BP5HS	
W8BP	BP5HS	
W8C	B5ES	
W8CC	B5ES	
W8CCX	B5ES-11	
W8CO	B5ES	
W8CP	B5ES	
W8D	BP5ES	8
W8DC	BP5ES	8
W8DCO	BP5ES	8
W8DCX	BP5ES-11	
W8DCY	BP5ES-13	
W8DP	BP5ES	8
W8DPX	BP5ES-11	
W8DTC	BP5ET	
W8DX	BP5ES-11	
W8E	B6S	
W8EC	B6S	
W8F	BP5S	
W8FC	BP5S	



<b>BOSCH</b>	<b>→ NGK Typ</b>	<b>V-LINE</b>
W8LCR	ZGR5A	15
W8LDCR	BUR6ET	1
W8LPR	ZGR5A	15
W8LTCR	BUR5ET/BPR5EKU	
W8LTCR 1,0	BUR5ET-10	21
W8LTCREA	BUR5ET	22
W95T1	B4H	
W95T2	B4ES	
W95T3	B4	
W95T30	BP4ES	
W95T6	BP4	
W9A	B4H	
W9AC	B5HS	
W9AC0	B5HS	
W9A0	B4H	
W9C	B4ES	
W9CC	B4ES	
W9D	BP5ES	8
W9DC	BP5ES	8
W9DCX	BP5ES-11	
W9DP	BP5ES	8
W9DPX	BP5ES-11	
W9DTC	BP5ET	
W9E	B4	
W9EC	B4	
W9ECO	B4LM	
W9EO	B4LM	
W9F	BP5S	
W9FC	BP5S	
W9LC	ZGR5A	15
WA125TR30	BPR5EFS	
WA200T30	BP6EFS	5
WA200TR30	BPR6EFS	7
WA225T30	BP7EFS	
WAK145T3	BM6F	
WAK225T3	BM7F	
WEA	BUH	
WEC	BUE	
WET1	BUH	
WET2	BUE	
WG235T28	BP7ES	
WG250P21	BPR9EVX	
WG250T28	BP8EVX	
WG250T30	BP8ES	
WG265T2SP	BPR9EVX	
WKA145T3	BM6A	
WKA145T6	BPM6A	
WKA175T3	BM6A	
WKA175T6	BPM6A	
WKA200TR6	BPMR6A	
WKA225T3	BM7A	

<b>BOSCH</b>	<b>→ NGK Typ</b>	<b>V-LINE</b>
WKA225T6	BPM7A	
WO6CS	B11EGV	
WR10A	BR4HS	
WR10AC	BR4HS	
WR10E	BR6S	
WR10F	BP4	
WR10FC	BP4	
WR10FCY	BPR4S-15	
WR10FY	BPR4S-15	
WR10LCV	BPR4ES-13	
WR11E0	BR4LM	
WR4AC	BR8HS	
WR4CC	BR8ES	
WR4CP	BR8EVX	
WR5A	BR7HS	
WR5AC	BR7HS	
WR5CC	BR7ES	
WR5CP	BR7ES	
WR5D	BPR7ES	19
WR5DC	BPR7ES	19
WR5DP	BPR7ES	19
WR5DS	BPR7EVX	
WR6D	BPR6ES	2
WR6DC	BPR6ES	2
WR6DCX	BPR6ES-11	13
WR6DP	BPR6ES	2
WR6DPX	BPR6ES-11	13
WR6DS	BPR6EVX	
WR6DTC	BP6ET	
WR6DTC	BUR6ETB-10	
WR7A	BR6HS	
WR7AC	BR6HS	
WR7B	BPR6HS	3
WR7BC	BPR6HS	3
WR7BP	BPR6HS	3
WR7C	BR6ES	
WR7CC	BR6ES	
WR7CCX	BR6ES-11	
WR7CP	BR6ES	
WR7CPX	BR6ES-11	
WR7D	BPR6ES	2
WR7DC	BPR6ES	2
WR7DC2	BPR6ES	2
WR7DCX	BPR6ES-11	13
WR7DP	BPR6EVX	
WR7DS	BPR6EVX	
WR7F	BPR6S	
WR7F	BP6S	
WR8AC	BR5HS	
WR8C	BR5ES	
WR8CC	BR5ES	
WR8CP	BR5ES	



<b>BOSCH</b>	<b>→ NGK Typ</b>	<b>V-LINE</b>
WR8D	BPR5ES	6
WR8DC	BPR5ES	6
WR8DCO	BPR5ES	6
WR8DCX	BPR5ES-11	
WR8DP	BPR5ES	6
WR8DPX	BPR5ES-11	
WR8DPY	BPR5ES-15	
WR8DS	BPR5EVX	
WR8E	BR6S	
WR8EC	BR6S	
WR8EP	BR6S	
WR8F	BPR5S	
WR8F	BP5S	
WR8FC	BPR5S	
WR8FC	BP5S	
WR8FP	BP5S	
WR8FP	BPR5S	
WR8FPY	BPR5S-15	
WR8HP	ZGR5C	
WR9AO	BR5HS	
WR9C	BR5ES	
WR9CC	BR5ES	
WR9D	BPR5ES	6
WR9DC	BPR5ES	6
WR9DCX	BPR5ES-11	
WR9DCY	BPR5ES-15	
WR9DP	BPR5ES	6
WR9DPX	BPR5ES-11	
WR9DS	BPR5EVX	
WR9DY	BPR5ES-15	
WR9E	BR6S	
WR9EC	BR6S	
WR9ECO	BR6S / BM6A	
WR9EO	BR6S	
WR9F	BP5S	
WR9F	BPR5S	
WR9FC	BPR5S	
WR9FC	BP5S	
WR9FCY	BPR5S-15	
WR9FP	BP5S	
WR9FPY	BPR5S-15	
WR9FY	BPR5S-15	
WR9HC	ZGR5C	
WR9HP	ZGR5C	
WR9LS	ZGR5A	15
WS5E	BM7A	
WS5F	BPM7A	
WS7E	BM6A	
WS7F	BPM6A	
WS8E	BM6A	
WS8F	BPM6A	
WSR5F	BPMR7A	

<b>BOSCH</b>	<b>→ NGK Typ</b>	<b>V-LINE</b>
WSR6F	BPMR7A	
WSR8F	BPMR6A	
WSR9E	BMR4A	
X3CPO	D9EA	
X4CS	D8EA	
X5DC	D7EA	
XR2AS	DR8HS	
XR2CS	DR8ES	
XR4AS	DR8HS	
XR4CS	DR8ES	
XR5DC	DR7EA	
Y7MPP33	PLKR6A	
YR5DDE	KR9CI	
YR5LDE	DCPR8EKC	
YR6LDE	BKR7EKC	
YR7DE	DCPR8EN	
ZR8TPP15	LF5B	
<b>BRISK</b>	<b>→ NGK Typ</b>	<b>V-LINE</b>
B12YC	DP9EA-9	
B14YC	DP8EA-9	
B15YC	DP7EA-9	
D12YC	BCP7ES	
D14Y	BKR6E	28
D14YC	BCP7ES	
D15Y	BKR6E	28
D15YC	BCP6ES	17
D17Y	BKR5E	35
D17YC	BCP5ES	16
DR12YC	BKR7E	
DR14YC	BCPR7ES	
DR14ZC	ZFR7F-11	
DR14ZC-1	BCPR7ES-11	
DR15TC	BKUR5ET-10	
DR15YC	BKR6E	28
DR15Z	BKR6E	28
DR15Z-1	BCPR6ES-11	11
DR17YC	BCPR5ES	32
F14YC	AP7FS	
F15YC	AP6FS	
FR14YC	APR6FS	
FR15YC	APR6FS	
G12YC	BP7EFS	
G14Y	BP7EFS	
G14YC	BP7EFS	
G15Y	BP6EFS	5
G15YC	BP6EFS	5
G17Y	BP5EFS	
G17YC	BP5EFS	
GR12YC	BPR7EFS	
GR14YC	BPR7EFS	
GR15YC	BPR6EFS	7



<b>BRISK</b>	<b>→ NGK Typ</b>	<b>V-LINE</b>
GR17YC	BPR5EFS	
J17	B4LM	
J19	B2LM	
JR17	BR4LM	
JR19	BR2LM	
K15YC	BP6S	
K17C	B6S	
K17Y	BP5S	
K19	B4	
L08JW	B10EGV	
L08W	B11EGV	
L10JW	B8EGV	
L12W	B9EVX	
L12Y	BP9ES	
L12YC	BP9ES	
L14	B8ES	
L14C	B8ES	
L14Y	BP6ES	4
L14YC	BP7ES	
L15	B7ES	
L15C	B7ES	
L15W	B8EVX	
L15Y	BP6ES	4
L15YC	BP6ES	4
L17	B6ES	
L17C	B6ES	
L17W	B7EVX	
L17Y	BP5ES	8
L17YC	BP5ES	8
L19	B4E	
L19C	B5ES	
LR12YC	BPR8ES	
LR12ZC	BPR8ES	
LR14TXS	BUR6ET	1
LR14YC	BPR7ES	19
LR14ZC	BPR7ES	19
LR14ZC-1	BPR7ES-11	
LR15TXS	BP5ET	
LR15YC	BPR6ES	2
LR15Z	BPR6ES	2
LR15Z-1	BPR6ES-11	13
LR17YC	BPR5ES	6
N08W	B10HVX	
N12W	B9HVX	
N12Y	BP8HS	
N12YC	BP8HS	
N14	B8HS	
N14C	B9HS	
N14Y	BP6HS	18
N14YC	BP7HS	
N15	B6HS	
N15C	B7HS	

<b>BRISK</b>	<b>→ NGK Typ</b>	<b>V-LINE</b>
N15W	B8HVX	
N15Y	BP6HS	18
N15YC	BP6HS	18
N17	B5HS	
N17C	B6HS	
N17W	B7HVX	
N17Y	BP4HS	
N17YC	BP5HS	
N19	B5HS	
N19C	B5HS	
NR12YC	BPR8HS	
NR15YC	BPR6HS	3
P15	BM7A	
P15Y	BPM7A	
P17	BM6A	
P17Y	BPM6A	
PR15Y	BPMR7A	
PR17Y	BPMR6A	
U15	BM7F	
U17	BM6F	
<b>CARLTON</b>	<b>→ NGK Typ</b>	<b>V-LINE</b>
71010	BM7F	
71015	BM6F	
71020	BM7A	
71025	BPM7A	
71030	BM7A	
71035	BPM7A	
71040	BM6A	
71045	BPM6A	
71050	B6HS	
71055	B5HS	
71060	B4	
71065	B4H	
71070	BPMR6A	
C10S	B4H	
C7S	B6HS	
C8S	B5HS	
C9	B4	
CA5E	BM7A	
CA5Y	BPM7A	
CA6	BPMR6A	
CA7E	BM7A	
CA7Y	BPM7A	
CA8E	BM6A	
CA8Y	BPM6A	
CN6E	BM7F	
CN8E	BM6F	
<b>CHAMPION</b>	<b>→ NGK Typ</b>	<b>V-LINE</b>
5828 / QL77JC4	BZ7HS-10	
5838 / QL78V	BUZHW-2	



<b>CHAMPION</b>	<b>→ NGK Typ</b>	<b>V-LINE</b>
5883 / QL78C	BR7HS	
5898 / QL76V	BUZHW	
5931 / RL82C	BR6HS	
5933 / L86CC	B6HS	
5939 / QL78YC	BPR7HS	
5942 / RV15YC4	BPR4FS-11	
860	A6FS	
870	A5FS	
A10	D7EA	
A4HC	DP9EA-9	
A50R	R2525-11	
A50R	R2198-12P	
A51R	R2525-10	
A51R	R2198-11P	
A53C	R2525-11	
A53R	R2525-11	
A53R	R2198-10P	
A55C	R2525-10	
A55R	R2525-10	
A55V	R2270-11	
A57C	R2525-10	
A57G	R2525-10	
A57R	R2525-10	
A59C	D9EA	
A59C	R2525-9	
A59G	R2525-9	
A59G	D9EVX	
A59GC	DCPR9EVX	
A59GC	R2430-9 (Ducati)	
A5YC	DP9EA-9	
A6	D8EA	
A61	D9EA	
A61G	D9EVX	
A6G	D8EVX	
A6GC	D8EVX	
A6HC	DP8EA-9	
A6Y	DP8EA-9	
A6YC	DP8EA-9	
A8	D7EA	
A8Y	DP7EA-9	
A8YC	DP7EA-9	
BL11Y	BP5FS	
BL13Y	BP5FS	
BL4	B7FS	
BL5	B7FS	
BL6	B6FS	
BL7Y	BP7FS	
BL8	B6FS	
BL9Y	BP6FS	
BN12Y	BP5EFS	
BN2	B9EFS	
BN6Y	BP7EFS	

<b>CHAMPION</b>	<b>→ NGK Typ</b>	<b>V-LINE</b>
BN7Y	BP6EFS	5
BN89Y	BP6EFS	5
BN9Y	BP6EFS	5
C10YCC	BCP6ES	17
C10YCC	BCP5ES	16
C11YCC	BCP5ES	16
C281YC	BCP6ES	17
C55	R7234-10	
C55 R	R7234-10	
C57	R7234-9	
C57C	R7234-9	
C59	R7234-9	
C59C	R7234-9	
C59YC	R5672A-9	
C61	R7234-8	
C6BYC	BCP7ET	
C6VPYC	BKR7EVX-11	
C6YCC	BCP7ES	
C7Y	BCP7ES	
C7YC	BCP7ES	
C7YCC	BCP7ES	
C7YCX	BCP7ES	
C9MCC	ZFR5F	
C9Y	BCP6ES	17
C9YC	BCP6ES	17
C9YCC	BCP6ES	17
C9YCX	BCP6ES	17
CJ11	BM6A	
CJ14	BM4A	
CJ17LM	B4LM	
CJ3	BM7A	
CJ4	BM7A	
CJ6	BM7A	
CJ6Y	BPM7A	
CJ7Y	BPM7A	
CJ8	BM6A	
CJ86	BM6A	
CJ8Y	BPM6A	
D10	A6	
D14	A6	
D16	A6	
D16J	A6	
D21	A6	
D6	A8	
D9	A6	
D9J	A6	
DJ6J	BM7F	
DJ6Y	BPM7F	
DJ7J	BM6F	
DJ7Y	BPM6F	
DJ8J	BM6F	
F10	A6FS	



<b>CHAMPION</b>	<b>→ NGK Typ</b>	<b>V-LINE</b>
F10C	A6FS	
F11Y	AP5FS	
F11YC	AP5FS	
F14Y	AP5FS	
F62Y	AP8FS	
F7Y	AP7FS	
F7YC	AP7FS	
F7YCC	AP7FS	
F81Y	AP8FS	
F-82	A8F	
F83Y	AP8FS	
F9Y	AP6FS	
F9YC	AP6FS	
FN507Y	BCP7ES	
G 56 R	R 016-10	
G 63 R	R 016-8	
G1	C9E	
G2	C8E	
G54V	R0045J-10	
G55	C9E	
G58	C9E	
G59C	C7E	
G61	C8E	
G63	C8E	
H03	B6S	
H10	B6L	
H10C	B6L	
H10J	B6L	
H11	B4L	
H12	B4L	
H8	B6L	
H8C	B6L	
H8J	B6L	
J10Y	BP6S	
J11	B4	
J11C	B4	
J11J	B4	
J11Y	BP5S	
J12J	B2	
J12Y	BP5S	
J12YC	BP5S	
J13Y	BP5S	
J14J	B2	
J14Y	BP5S	
J14YC	BP5S	
J17LM	B4LM	
J18Y	BP4	
J18YC	BP4	
J19LM	B2LM	
J2J	B9S	
J4	B7S	
J4C	B7S	

<b>CHAMPION</b>	<b>→ NGK Typ</b>	<b>V-LINE</b>
J4J	B7S	
J5	B7S	
J6	B6S	
J6C	B6S	
J6J	B6S	
J7	B6S	
J7J	B6S	
J8	B6S	
J8C	B6S	
J8J	B6S	
K13	A6	
K15J	A6	
K3G	A8	
K5G	A8	
K7	A8	
K-8	A8	
K8G	A8	
K9	A7	
L10	B6HS	
L12Y	BP5HS	
L14	B4H	
L15Y	BP4HS	
L19V	BUH	
L20V	BUH	
L288	B5HS	
L2G	B9HVX	
L3G	B8HVX	
L4G	B7HVX	
L4J	B7HS	
L5	B7HS	
L55G	B10HVX	
L61Y	BP8HS	
L64Y	BP7HS	
L66Y	BP6HS	18
L6G	B7HVX	
L6VC	BU8H	
L76V	BUHW	
L77J	B7HS	
L77J4	B7HS-10	
L77JC	B7HS	
L77JC4	B7HS-10	
L77V	BUHW	
L78	B7HS	
L78C	B7HS	
L78V	BUHW-2	
L78YC	BP7HS-10	
L78YC6	BP8HS-15	
L7J	B6HS	
L81	B7HS	
L81Y	BP7HS	
L82	B6HS	
L82C	B6HS	



<b>CHAMPION</b>	<b>→ NGK Typ</b>	<b>V-LINE</b>
L82Y	BP6HS	18
L82YC	BP6HS	18
L82YCC	BP6HS	18
L85	B6HS	
L85Y	BP6HS	18
L86	B6HS	
L86C	B6HS	
L86CC	B6HS	
L87Y	BP6HS	18
L87YC	BP6HS	18
L87YCC	BP6HS	18
L89CM	BP5HS	
L90	B5HS	
L90C	B5HS	
L92LCC	BP5HA	
L92Y	BP5HS	
L92YC	BP5HS	
L95Y	BP4HS	
L9G	B6HVX	
L9J	B6HS	
N1	B10ES	
N10PY	BP6EVX	
N10Y	BP6ES	4
N10Y4	BP6ES-11	
N11Y	BP5ES	8
N11YC	BP5ES	8
N11YC4	BP5ES-11	
N11YCC	BP5ES	8
N12Y	BP5ES	8
N12YC	BP5ES	8
N12YCC	BP5ES	8
N13L	ZGR5C	
N13Y	BP5ES	8
N14LY	ZGR5C	
N14Y	BP5ES	8
N16Y	BP4ES	
N16YC	BP4ES	
N178B	B8EM	
N180B	B7EM	
N19V	BUE	
N1C	B10ES	
N2	B9ES	
N21	B4ES	
N279YC	BP7ES	
N281YC	BP6ES	4
N288	B5ES	
N2C	B9ES	
N2G	B9EVX	
N3	B8ES	
N3C	B8ES	
N3G	B8EVX	
N4	B7ES	

<b>CHAMPION</b>	<b>→ NGK Typ</b>	<b>V-LINE</b>
N4C	B7ES	
N4G	B7EVX	
N4YC	BP9ES	
N5	B6ES	
N54R	B10EG	
N55G	B105EGV	
N56R	B105EGP	
N57	B10ES	
N57G	B105EGV	
N57R	B10EG	
N59G	B95EGV	
N5C	B6ES	
N5G	B6EVX	
N6	B6ES	
N60	B9ES	
N60R	B8EG	
N60Y	BPR10EVX	
N62R	B8EG	
N63Y	BP9ES	
N64Y	BP8ES	
N65Y	BP7ES	
N66Y	BP6ES	4
N6BYC	BP6ET	
N6GY	BP8EVX	
N6Y	BP8ES	
N6YC	BP8ES	
N6YCC	BP8ES	
N7	B7ES	
N74C	BUR6EB-11/B6EB-11	
N79Y	BP6ES	4
N7BMC	BP6ET	
N7BYC	BP6ET	
N7GY	BP7EVX	
N7Y	BP7ES	
N7YC	BP7ES	
N7YCC	BP7ES	
N7YCX	BP7ES	
N8	B6ES	
N80	B10EG	
N80G	B11EGV	
N82	B10EG	
N82G	B105EGV	
N84	B9EG	
N84G	B95EGV	
N86	B9EG	
N86G	B9EGV	
N87	B8EG	
N87G	B8EGV	
N8GY	BP6EVX	
N8L	ZGR5C	
N8Y	BP6ES	4
N9BMC	BPR5EKU	



<b>CHAMPION</b>	<b>→ NGK Typ</b>	<b>V-LINE</b>
N9BYC	BP6ET	
N9BYC4	BP5ET-10	
N9Y	BP6ES	4
N9YC	BP6ES	4
N9YC4	BP6ES-11	
N9YCC	BP6ES	4
N9YCX	BP6ES	4
OBL9Y	BPR6FS	
OE001/r04	BP6ES	4
OE001/t10	BP6ES	4
OE002/r04	BKR6E	28
OE002/t10	BKR6E	28
OE003/T10	BCP6ES	17
OE004/r04	GR5	
OE004/r04	BPR6ES	2
OE004/t10	BPR6ES	2
OE004/t10	GR5	
OE005/r04	BKR6E	28
OE005/t10	BKR6E	28
OE006/r04	BPR6ES	2
OE006/r04	GR5	
OE006/t10	BPR6ES	2
OE006/t10	GR5	
OE007/T10	BP6HS	18
OE008/r04	BPR7ES	19
OE008/t10	BPR7ES	19
OE009/r04	BP7EFS	
OE009/t10	BP7EFS	
OE010/r04	BP7ES	
OE010/t10	BP7ES	
OE011/R04	BPR6EFS	7
OE011/T10	BPR6EFS	7
OE012/r04	BP6ET	
OE012/t10	BP6ET	
OE013/t10	BKR5ES	
OE014/r04	BCPR7ES	
OE014/t10	BCPR7ES	
OE015/t10	BP5ES	8
OE016/r04	BKR6E	28
OE016/t10	BKR6E	28
OE017/T10	BCP7ES	
OE018/r04	BPR7ES	19
OE018/t10	BPR7ES	19
OE019/r04	BKR5EK	23
OE019/t10	BKR5EK	23
OE020/R04	BPR6EFS	7
OE020/t10	BPR6EFS	7
OE021/r04	BCPR6ET	
OE021/t10	BCPR6ET	
OE023/R04	BCP6ES	17
OE023/T10	BCP6ES	17
OE025/r04	BUR6ET	1

<b>CHAMPION</b>	<b>→ NGK Typ</b>	<b>V-LINE</b>
OE025/t10	BUR6ET	1
OE026/r04	BKR6EK	20
OE026/t10	BKR6EK	20
OE027/r04	BUR5ET-10	21
OE027/T10	BUR5ET-10	21
OE028/r04	BP5ET-10	
OE028/t10	BP5ET-10	
OE030/t10	BKR6EKC	26
OE031/r04	PTR5A-13	25
OE031/t10	PTR5A-13	25
OE032/r04	BUR6ET-10	
OE032/r04	BKUR6ET-10	24
OE032/t10	BUR6ET-10	
OE032/t10	BKUR6ET-10	24
OE033/t10	PFR6G-9	
OE033/t10	BKR6EZ	
OE034/t10	BKR6ES	28
OE035/t10	LFR5B	
OE036/r04	BP7EFS	
OE036/t10	BP7EFS	
OE037/T10	B6HS	
OE038/T10	BP6HS	18
OE039/t10	BCPR6ES-11	11
OE040/t10	B9ES	
OE041/t10	ZFR5F	
OE042/t10	BPR5ES	6
OE043/r04	BCPR7ES	
OE043/t10	BCPR7ES	
OE044/t10	BP6ET	
OE045/t10	BPR5ES	6
OE048/r04	BPR6ES-11	13
OE048/t10	BPR6ES-11	13
OE049/t10	BPR5ES-11	
OE050/r04	BP7EFS	
OE050/t10	BP7EFS	
OE051/t10	BPR5ES	6
OE054/t10	APR6FS	
OE056/r04	BKR7ES-11	
OE056/t10	BKR7ES-11	
OE057/T10	BCP5ES	16
OE058/T10	BCP7ES	
OE059/T10	BP5HS	
OE060/t10	ZGR5B	
OE063/t10	BCPR6ES-11	11
OE064/r04	BPR6HS	3
OE064/T10	BPR6HS	3
OE065/T10	BP5ES	8
OE066/r04	ZFR6F	
OE066/t10	ZFR6F	
OE067/t10	BP7EFS	
OE068/t10	B8ES	
OE072/t10	BPR5EFS	





<b>CHAMPION</b>	<b>→ NGK Typ</b>	<b>V-LINE</b>
OE073/t10	DCPR9E 16er Hex / Schlüsselweite	
OE074/t10	B6ES	
OE075/T10	BCP7ES	
OE076/T10	BCP7ET	
OE077/t10	BCPR6ET	
OE078/t10	B8EVX	
OE079/t10	B7ES	
OE080/t10	BKR7ES-11	
OE083/t10	DCPR8E	
OE083/t10	DPR8EA-9	
OE084/R04	BP8ES	
OE084/t10	BP8ES	
OE085/t10	BKR5EKU	
OE086/t10	BR6HS	
OE087/r04	BP8ES	
OE087/t10	BP8ES	
OE090/t10	BP7EFS	
OE091/t10	BR9ES	
OE092/t10	CR9E	
OE093/t10	BKR5EZ	
OE095/r04	BP6ET	
OE095/T10	BP6ET	
OE098/t10	BR7ES	
OE099/t10	BPR5EFS	
OE100/t10	BPR5EKU	
OE103/T10	DCPR9EVX	
OE103/T10	R2430-9 (Ducati)	
OE105/t10	GR4	
OE108/T10	BR8ES	
OE109/t10	BP6ET	
OE110/t10	BCPR7ES	
OE112/T10	D8EVX	
OE116/t10	BPR8ES	
OE122/t10	PMR8A	
OE124/t10	PFR5J-11	
OE124/t10	PFR5G	
OE125/t10	B9EVX	
OE129/T10	BKR7EVX-11	
OE130/t10	LZKAR7A	
OE132/T10	DP8EA-9	
OE134/t10	PFR5J-11	
OE136/t10	PFR6J-11	
OE141/t10	BKR6EVX	
OE143/t10	PFR6G-9	
OE144/t10	BKUR6ET-10	24
OE145/t10	BKUR6ET-10	24
OE146/t10	PFR5G-13E	
OE151/T06	TR4	
OE151/T06	BPR5EFS	
OE152/t10	BKR5E-11	33
OE155/t10	APR6FS	

<b>CHAMPION</b>	<b>→ NGK Typ</b>	<b>V-LINE</b>
OE156/t10	ZGR5C	
OE160/t06	ZFR4F-11	
OE161/t04	GR4	
OE162/t06	BR6ES	
OE163/t04	LZTR4A-11	
OE165/T04	R7234-9	
OE166/T04	C7E	
OE169/t04	R5724-9	
OE171/t04	UR6	
OE171/t04	BPR6FS	
OE173/T04	R2525-10	
OE175/t10	LF5AP-11	
OJ11Y	BP6S	
OJ12Y	BP5S	
OJ13Y	BP5S	
ON11Y	BPR5ES	6
ON12Y	BPR5ES	6
ON3	BR8ES	
P10Y	D6HA	
P7	D8HA	
P7G	DR8HS	
P8Y	D6HA	
PG2PHP	PMR8A	
PG4PHP	PMR7A	
PRZ9HC	CR7HSA	
PZ7HC	C7HSA	
QC12PEP	PZFR6H	
QC12YC	BKR5ES	
QC59YC	BKR8E	
QJ17LM	BR4LM	
QJ19LM	BR2LM	
QL16V	BUZ8H	
QL6VC	BU8H	
QL76V	BUZHW	
QL77CC	BR8HS	
QL77J4	BZ7HS-10	
QL77JC4	BZ7HS-10	
QL78C	BR7HS	
QL78V	BUZHW-2	
QL78YC	BPR7HS	
QL7J5	BR6HS	
QL81Y	BPZ7HS-10	
QL82C	BR6HS	
QL82YC	BPR6HS	3
QL86	BR6HS	
QL87YC	BPR6HS	3
QL92LCC	BP8HS-10	
QN2	BR9ES	
QN2C	BR9ES	
QN2G	BR9EVX	
QN3	BR8ES	



<b>CHAMPION</b>	<b>→ NGK Typ</b>	<b>V-LINE</b>
QN3C	BR8ES	
QN84	BR9EG	
QN86	BR8EG	
R10	D6EA	
R44CXLS	BPR5ES	6
R54G	R 217-11	
R6	D8EA	
R6G	D8EVX	
R8	D7EA	
RA2HC	DPR9EA-9	
RA4HC	DPR9EA-9	
	18er Hex / Schlüsselweite	
RA4HC	DCPR9E	
	16er Hex / Schlüsselweite	
RA4HCC	DCPR8E	
RA4HCX	DCPR9EVX	
RA59GC	DCPR9EVX	
RA59PP	D9EVX	
RA6	DR8ESL	
RA6HC	DPR8EA-9	
RA6HC	DCPR8E	
RA6Y	DPR8EA-9	
RA6YC	DPR8EA-9	
RA8HC	DCPR7E	
RA8Y	DPR7EA-9	
RA8YC	DPR7EA-9	
RBL11Y	BPR5FS	
RBL11Y6	BPR5FS-15	
RBL12	BR5FS	
RBL12-6	BR5FS-15	
RBL13Y	BPR5FS	
RBL13Y6	BPR5FS-15	
RBL15Y	BPR4FS	
RBL15Y4	BPR4FS-11	
RBL15Y6	BPR4FS-15	
RBL16Y	BPR4FS	
RBL17Y	BPR4FS	
RBL17Y6	BPR4FS-15	
RBL8	BR6FS	
RBL8-6	BR6FS-15	
RBL9Y	BPR6FS	
RBN12Y	BPR5EFS	
RBN13Y	BPR5EFS	
RBN14Y	BPR5EFS	
RBN9Y	BPR6EFS	7
RC10DMC	BKR5EK	23
RC10ECC	ZFR6F-11	
RC10PYC	BKR6EVX 0,8	
RC10PYP4	PFR5G	
RC10PYP4	PFR5J-11	
RC10VTYC4	BPR5EKUP	
RC10YC4	BCPR6ES-11	11

<b>CHAMPION</b>	<b>→ NGK Typ</b>	<b>V-LINE</b>
RC10YCC	BKR6E	28
RC11LCC4	BRE527Y-11	
RC12LYC	ZFR5F	
RC12MC4	PZFR5F-11	
RC12MC5	ZFR5F-11	
RC12PYP	PFR5J-11	
RC12YC	BKR5ES	
RC12YC5	FR45	
RC14YC	BKR5ES	
RC14YC4	BKR5E-11	33
RC6VPYC	BKR7EVX-11	
RC6YC	BCPR7ES	
RC6YCC	BCPR7ES	
RC7BMC	BCPR6ET	
RC7BYC4	BCPR6ET	
RC7GYC	BKR7EVX-11	
RC7Y	BCPR7ES	
RC7YC	BCPR7ES	
RC7YC4	BKR7ES-11	
RC7YCC	BCPR7ES	
RC7YCC4	BKR7ES-11	
RC87PYC	BKUR6ET-10	24
RC87YCC	BKR6EZ	
RC87YCL	PFR6G-9	
RC87YCL	BKR6EZ	
RC89PYC	BKUR5ET-10	
RC89TMC	BKUR5ET-10	
RC89YCC	BKR5EZ	
RC8BYC	BKR6EKC	26
RC8DMC	BKR6EK	20
RC8PYCB	PFR6G-9	
RC8PYP	PFR6J-11	
RC8PYPB4	PFR5G-13E	
RC8PYX	FR7KDC	
RC8VTYC4	BKUR5ET	
RC8YC4	BKR5E-11	33
RC8YCL	BKR6ES	28
RC9BMC	BKR5EKU	
RC9MC4	ZFR5F-11	
RC9MCC	ZFR6F	
RC9MCC4	ZFR6F-11	
RC9Y	BKR6E	28
RC9YC	BKR6E	28
RC9YC4	BCPR6ES-11	11
RC9YCC	BKR6E	28
RC9YCC4	BKR6E-11	
RCJ4	BMR7A	
RCJ6	BMR7A	
RCJ6Y	BPMR7A	
RCJ7Y	BPMR7A	
RCJ8	BMR6A	
RCJ8Y	BPMR6A	



<b>CHAMPION</b>	<b>→ NGK Typ</b>	<b>V-LINE</b>
RD14	A6	
RD16	A6	
RD16J	A6	
RD9	A6	
RDJ6J	BM7F	
RDJ7J	BMR6F	
RDJ7Y	BPMR6F	
RDJ8J	BMR6F	
RE10LC	SR5	
RE14MCC5	LZTR4A-11	
RE14PLP5	PLZTR5a-13	
RE7PYC5	PTR5A-13	25
RE7YCC	PTR5A-13	25
REA8MCL	LZKAR7A	
REA8MCL	LZKAR7A	
REC10PYC4	LFR5AP-11	
REC14PYC	LFR4AP-11	
REC9MCLX	LFR5B	
REC9YCL	LFR5B	
RES9YCC4	PTR5A-13	25
RF10	AR6FS	
RF10C	AR6FS	
RF11Y	APR6FS	
RF11YC	WR5	
RF11YC	APR6FS	
RF12-5	AR5FS-11	
RF14Y	APR5FS	
RF7YC	APR6FS	
RF7YCC	APR6FS	
RF9Y	APR6FS	
RF9Y5	APR6FS	
RF9YC	WR5	
RF9YC	APR6FS	
RFN14LY	ZFR4F-11	
RG2PHP	CR8EVX	
RG4HC	CR9E	
RG4PHP	PMR7A	only Ferrari
RG4PHP	PMR8A	
RG6YC	CR8EB	
RG6YCH	CPR8E	
RG94C	CR8E	
RH10C	B6L	
RH10C	B6L	
RJ10Y	BP6S	
RJ11	BR6S	
RJ11Y	BP5S	
RJ12C	BR6S	
RJ12Y	BP5S	
RJ12YC	BP5S	
RJ12YC	XR5	
RJ14CC	XR4	
RJ14Y	BP5S	

<b>CHAMPION</b>	<b>→ NGK Typ</b>	<b>V-LINE</b>
RJ14YC	BP5S	
RJ14YC	XR4	
RJ14YC	XR4	
RJ17LM	BR4LM	
RJ18Y	BP4	
RJ18YC	BP4	
RJ18YC	XR4	
RJ19LM	BR2LM	
RJ20Y	BP4	
RJ6	BR6S	
RJ6C	BR6S	
RJ6J	BR6S	
RJ7	BR6S	
RJ8	BR6S	
RJ8C	BR6S	
RJ8J	BR6S	
RL12Y	BPR6HS	3
RL19	BR5HS	
RL4J	BR7HS	
RL77J	BR7HS	
RL78	BR7HS	
RL78C	BR7HS	
RL7J	BR6HS	
RL82	BR6HS	
RL82C	BR6HS	
RL82Y	BPR6HS	3
RL82YC	BPR6HS	3
RL82YCC	BPR6HS	3
RL85	BR6HS	
RL85G	---	
RL86	BR6HS	
RL86C	BR6HS	
RL87Y	BPR6HS	3
RL87YC	BPR6HS	3
RL90	BR5HS	
RL95YC	BPR5HS	
RN10GY	BPR6EVX	
RN10VTYC	BUR5ET	22
RN10VTYC4	BUR5ET-10	21
RN10Y	BPR6ES	2
RN10Y4	BPR6ES-11	13
RN10YC	BPR6ES	
RN11Y	BPR5ES	6
RN11YC	BPR5ES	6
RN11YC4	BPR5ES-11	
RN11YCC	BPR5ES	6
RN12GY	BPR5EVX	
RN12MC4	BPR4EY-11	
RN12Y	BPR5ES	6
RN12YC	BPR5ES	6
RN12YC4	BPR5ES-11	
RN12YC6	BPR5ES-13	



<b>CHAMPION</b>	<b>→ NGK Typ</b>	<b>V-LINE</b>
RN12YCC	BPR5ES	6
RN13L	ZGR5C	
RN13LYC	ZGR5C	
RN14LY	ZGR5C	
RN14MC5	BPR4EY-11	
RN14PMP5	GR4	
RN14Y	BPR5ES	6
RN14Y6	BPR5ES-13	
RN14YC	GR4	
RN16Y	BPR4ES	
RN16YC5	BPR4ES-13	
RN180B	BR7EM	
RN1C	BR10ES	
RN2	BR9ES	
RN2C	BR9ES	
RN2G	BR9EVX	
RN3	BR8ES	
RN3C	BR8ES	
RN3G	BR8EVX	
RN4	BR7ES	
RN49G	---	
RN4C	BR7ES	
RN5	BR6ES	
RN57YC	BR10EG	
RN5C	BR6ES	
RN6	BR6ES	
RN6Y	BPR8ES	
RN6YC	BPR8ES	
RN74C	BR6EB-11	
RN79G	---	
RN7GY	BPR7EVX	
RN7Y	BPR7ES	19
RN7YC	BPR7ES	19
RN7YCC	BPR7ES	19
RN7YCC4	BPR7ES-11	
RN8	BR5ES	
RN8L	ZGR5C	
RN8VTYC4	BUR6ET	1
RN9GY	BPR6EVX	
RN9LCC	ZGR5B	
RN9LCC	---	
RN9Y	BPR6ES	2
RN9YC	GR5	
RN9YC	BPR6ES	2
RN9YC4	BPR6ES-11	13
RN9YCC	GR5	
RN9YCC	BPR6ES	2
RP10HC	DR5HS	
RP7	DR8HS	
RS10LC	TR5-1	
RS12YC	TR4	
RS12YC	BPR5EFS	

<b>CHAMPION</b>	<b>→ NGK Typ</b>	<b>V-LINE</b>
RS12YC6	BPR5EFS-13	
RS13LYC	TR4-2	
RS14LC	TR5-1	
RS14LYC	TR4-2	
RS14YC	BPR5EFS	
RS15LYC	TR4-2	
RS17YX	TR4	
RS5C	BR7EFS	
RS7YC	BPR7EFS	
RS9YC	BPR6EFS	7
RS9YCC	BPR6EFS	7
RV12C	BR5FS	
RV12C6	BR5FS-15	
RV12YC	UR5	
RV12YC	BPR5FS	
RV12YC6	BPR5FS-15	
RV15YC	BPR4FS	
RV15YC4	BPR4FS-11	
RV15YC4	UR4	
RV15YC6	BPR4FS-15	
RV17YC	BPR4FS	
RV17YC6	BPR4FS-15	
RV8C	BR6FS	
RV8C6	BR6FS-15	
RV91MC	BR6FS	
RV92YC	BPR5FS	
RV9YC	BPR6FS	
RV9YC	UR6	
RZ7C	CMR7H	
RZN12Y	BPR5EFS	
RZN12Y5	BPR5EFS	
S10YCC	BP5EFS	
S12YC	BP5EFS	
S279YC	BP6EFS	5
S281YC	BP6EFS	5
S379YC	BP7EFS	
S59C	R5724-9	
S6YC	BP7EFS	
S7YC	BP7EFS	
S7YCC	BP7EFS	
S9YC	BP6EFS	5
S9YCC	BP6EFS	5
UD16	A6	
UJ12	B2	
UJ2J	B8S	
UJ4J	B7S	
UJ6	B6S	
UJ8	B6S	
UJ81C	B7S	
UJ81J	B7S	
UK10	A6	
UL17V	BUHXW-1	



<b>CHAMPION</b>	<b>→ NGK Typ</b>	<b>V-LINE</b>
UL18V	BUHX	
UL4J	B7HS	
UL77V	BUHXW-1	
UL81C	B7HS	
UL81J	B7HS	
UN19V	BUE	
UN79Y	BP6ES	4
UY6	---	
V12YC	BP5FS	
V4C	B7FS	
V63C	R5673-7	
V9YC	BP6FS	
W16Y	---	
XC12PEPB	PZFR6H	
XJ10Y	BP6S	
Y82	CM6	
Z10	C6HSA	
Z10G	C7HVX	
Z12	C6HSA	
Z6	C8HSA	
Z7G	C7HVX	
Z8	C7HSA	
Z9Y	C7HSA	

<b>CHRYSLER</b>	<b>→ NGK Typ</b>	<b>V-LINE</b>
04606402AB	LZTR4A-11	

<b>CITROEN</b>	<b>→ NGK Typ</b>	<b>V-LINE</b>
59622A	BPR6ES	2
59622T	BKR6EKC	26
59622X	BKR6E	28
5962IA	BP5ET	
5962IK	BKR6EK	20
5962IL	BKR5EK	23
5962OE	BKR6EK	20
5962S7	BP5ES	8
5962TO	BKR6E	28
5962W1	BCPR5ES	32
5962X8	BCP6ES	17
5962Z1	BKR6EK	20
5962Z6	BKR5EK	23
95496692	BP6HS	18
95605398	B6HS	
95611941	BP6EFS	5
95619043	BP6ES	4
96000090	BCP5ES	16
96037952	BCP5ES	16
96039962	BCP6ET	
96064890	BCPR5ES	32
96097486	BCP7ET	
96145071	BCPR6ET	
97533994	BP7EFS	

<b>CITROEN</b>	<b>→ NGK Typ</b>	<b>V-LINE</b>
AM212207A	B6HS	
MKP00073	BP7ES	
ZC9862090U	BP5ES	8
ZCT000011	BP6HS	18
ZCT000012	BP7ES	

<b>DAIHATSU</b>	<b>→ NGK Typ</b>	<b>V-LINE</b>
90048-51006-000	B8ES	
90048-51008-000	B7ES	
90048-51015-000	B6ES	
90048-51020-000	B4H	
90048-51022-000	B6HS	
90048-51033-000	B5ES	
90048-51034-000	BP6ES	4
90048-51034-010	BP6ES	4
90048-51040-000	BP6EK	
90048-51047-010	BP5EAL	
90048-51048-000	BPR5EAL	
90048-51050-000	BPR5EA-11	
90048-51053-000	BP5EY	
90048-51054-000	BPR5EY	9
90048-51058-000	BE527Y-11	
90048-51059-000	BPR6EY	
90048-51063-000	BP5EJ	
90048-51068-000	BP6EJ	
90048-51069-000	BP6EY	
90048-51072-000	BP5ES	8
90048-51074-000	BP6EKA	
90048-51077-000	BPR6EKN	
90048-51081-000	BPR5EA-11	
90048-51087-000	BPR6EKA	
90048-51093-000	BPR5EY-11	
90048-51096-000	BPR6ES	2
90048-51097-000	BP2E	
90048-51100-000	BKR6E-11	14
90048-51101-000	BP5EKN	
90048-51102-000	BP6EKN	
90048-51103-000	BP7EKN	
90048-51104-000	BPR6EKN	
90048-51105-000	BPR7EKN	
90048-51108-000	BPR6EKBL	
90048-51112-000	BCPR7EKD	
90048-51113-000	BCPR6ED	
90048-51114-000	BPR5ES	6
90048-51116-000	BPR6EKB	
90048-51118-000	PFR6B-11	
90048-51121-000	BPR4EY	
90048-51123-000	BKR6EY-11	
90048-51126-000	BPR5EJ	
90048-51128-000	R6469-9	
90048-51131-000	BPR5EKB	
90048-51134-000	BCPR6EKD	



<b>DAIHATSU</b>	<b>→ NGK Typ</b>	<b>V-LINE</b>
90048-51136-000	BKUR6EK	
90048-51137-000	BKUR6EK	
90048-51144-000	BKUR7EK	
90048-51147-000	R6809-9	
90048-51152-000	BKR6E	28
90048-51155-000	BKR6EKC	
90048-51158-000	BKR5E-11	33
90048-51160-000	BKUR6EK-9	
90048-51161-000	BKR7E	
90048-51162-000	IFR7F-6D	
90048-51165-000	BKR5EKC	
90048-51166-000	PFR6G	
90048-51168-000	BKUR6ETB-10	
90048-51169-000	BKUR6ETB-10	
90048-51173-000	IFR6J11	
90048-51174-000	BKUR6EKPA	
90048-51178-000	IFR6J	
90048-51184-000	BKUR6E	
90048-51185-000	ILFR6C11	
90048-51192-000	LKR7C	
90048-51196	DCPR7EA-9	
90048-51200	IKR7D	
90919-01026-000	BP5ESL	
90919-01042-000	BP5EZ	
90919-01060-000	BP5EA	
90919-01061-000	BP5EAL	
90919-01086-000	BP5EA-11	
90919-01087-000	BP5EKA	
90919-01106-000	BP4EY-11	
90919-01116-000	BPR5EP-11	
90919-01118-000	BE529Y-11	
90919-01177-000	BKR5EYA	
90919-01181-000	BKR6EP-8	
90919-01202-000	BKR6EKB-11	
991-1339-2361-0	AB6	
991-2311-2361-00	AB7	
992-5130-2001-00	B4	
995-2021-2361-32	B8HS	
999-06910-P9-002	BR6HS	
999-06910-P9-003	BR8HS	
999-06910-P9-004	BPR5HS	
999-06910-P9-005	BPR6HS	
999-06910-P9-006	BR5ES	
999-06910-P9-007	BR6ES	
999-06910-P9-008	BR7ES	
999-06910-P9-009	BR8ES	
999-06910-P9-011	BPR5ES-11	
999-06910-P9-012	BPR6ES-11	
999-06910-P9-013	BPR5EK-A	
999-06910-P9-015	BPR4EY-11	
999-06910-P9-017	BPR6EY-11	
999-06910-P9-020	BPR6E	

<b>DAIHATSU</b>	<b>→ NGK Typ</b>	<b>V-LINE</b>
999-06910-P9-021	BCPR5E-11	
999-06910-P9-022	BCPR5EY-11	
999-06910-P9-023	BCPR6E-11	
999-06910-P9-024	BCPR6EY-11	
999-06910-X9-001	BPR5EIX-11	
999-06910-X9-002	BPR6EIX-11	
999-06910-X9-003	BPR7EIX	
999-06910-X9-004	BCPR5EIX-11	
999-06910-X9-005	BCPR6EIX-11	
999-06910-X9-006	BKR5EIX-11	
999-06910-X9-007	BKR6EIX-11	
999-06910-X9-008	BPR6HIX	
999-06910-X9-009	BPR7HIX	
999-06910-X9-010	BR6HIX	
999-06910-X9-011	BR7HIX	
999-06910-X9-012	BR8EIX	
999-06910-X9-013	BR9EIX	
999-06910-X9-014	DR8EIX	
999-06910-X9-015	DR9EIX	
999-06910-X9-016	DPR8EIX-9	
999-06910-X9-017	DPR9EIX-9	
999-06910-X9-018	DCPR7EIX	
999-06910-X9-019	ZFR5FIX-11	
999-06910-X9-020	ZFR6FIX-11	
999-06910-X9-021	CR8EHIX-9	
999-06910-X9-022	CR9EHIX-9	
999-06910-X9-023	CR8EIX	
999-06910-X9-024	CR9EIX	
999-06910-X9-025	IRIWAY7	
999-06910-X9-025	IRIWAY7	
999-06910-X9-026	BPR5EIX	
999-06910-X9-027	BPR6EIX	
999-06910-X9-028	BKR5EIX	
999-06910-X9-029	BKR6EIX	
999-06910-X9-030	BKR7EIX-11	
999-06910-X9-031	BCPR7EDIX	
999-06910-X9-032	BKR5EIX-P	
999-06910-X9-033	BKR5EIX-11P	
999-06910-X9-034	BKR6EIX-P	
999-06910-X9-035	BKR6EIX-11P	
999-3400-6911-00	BP6EVX	
999-3401-6911-00	BP5EVX	
999-3402-6911-00	B6EVX	
999-3403-6911-00	B7EVX	
999-3405-6911-00	BP5ES-11	
999-3406-6911-00	BP6ES-11	
999-3407-6911-00	BP5HS	
999-3408-6911-00	BP5ES-13	
999-3409-6911-00	BP6HS	18
999-3410-6911-00	BP4EY	



<b>DENSO</b>	<b>→ NGK Typ</b>	<b>V-LINE</b>
9807B-5615P	ZFR6K-11	
9807B-5615W	IZFR6K-11	
J16AR-U11	BRE527Y-11	
J16A-U11	BE527Y-11	
J16AY	BP5EJ	
J16AYR	BPR5EJ	
J16BR-U	BRE529Y	
J16B-U11	BE529Y-11	
J16CRU	ZGR5A	
K14PRU-11	BKR4E-11	
K14P-U11	BKR5E-11	33
K16PRP11	BKR5EVX	
K16PR-U	BKR5E	35
K16PR-U11	BKR5E-11	33
K16R-U	BKR5EYA	
K16R-U11	BKR5EYA-11	
K16TNR9	BKR5EKC	
K16TR-11	BKR5EKB-11	
K20DTR-S11	ZFR6G	
K20HR-U11	LFR6C-11	
K20PBR-S10	BKUR6ET-10	24
K20PR-L11	BKR6EN-11	
K20PR-TP11	BKR6EVX-11	
K20PR-U	BKR6E	28
K20PR-U11	BKR6E-11	14
K20P-U	BK6E	
K20P-U11	BK6E-11	
K20R-U	BKR6EYA	
K20R-U11	BKR6EY-11	
K20TMR11	BKR6EKC-N-11	
K20TNR-S	BKUR6EK	
K20TR-11	BKR6EKB-11	
K20TRX	BKR6EJU	
K22PB	BCP7ET	
K22PR-L11	BKR7EN-11	
K22PR-U	BKR7E	
K22PR-U11	BKR7E-11	
K22P-U11	BK7E-11	
K22TM11	BK7EK-N-11	
K22TMR	BKR7EKC-N	
K22TMR11	BKR7EKC-N-11	
K22TNR-S	BKUR7EK	
K29A-Z	R7117-10	
KJ16CR-L11	ZFR5J-11	
KJ16CR-L11	ZFR5F-11 / ZFR5J-11	
KJ206CR-L11	ZFR6F-11	
KJ20CR-L11	ZFR6F-11/ZFR6J-11	
KJ20DR-M11	ZFR6K-11	
KJ20DR-M11	ZFR6K-11	
KJ22CR-L11	ZFR7F-11 / ZFR7J-11	
KJ22CRL8	ZFR7F	
L14-U	A6	

<b>DENSO</b>	<b>→ NGK Typ</b>	<b>V-LINE</b>
M17	A6	
M22	A7	
M24S	A8	
MA14P-U	AP5FS	
MA16PR-U	APR5FS	
MA16PR-U11	APR5FS	
MA16PR-U15	APR5FS	
MA16P-U	AP5FS	
MA17P-U	AP6FS	
MA20PR-U	APR6FS	
MA20P-U	AP6FS	
MA20R-U	AR6FS	
MA20R-U11	AR6FS	
MA9P-U	AP4FS	
MW17	AB6	
MW22	AB7	
MW9	AB2	
P16R	BPR5EP-11	
P16R-13	BPR5EP-13	
P20PR11	PGR6A-11	
P20R8	BPR6EP-8	
PK16PR11	PFR5B-11	
PK16PR-P11	PFR5J-11	
PK16R11	BKR5EP-11	
PK16R-8	BKR5EP-8	
PK16TR11	BKR5EKP-11	
PK20GR8	BKR6EPA-8	
PK20PR11	PFR6B-11	
PK20PR-L11	PFR6G-11	
PK20PR-P	PFR6J	
PK20PR-P11	PFR6J-11	
PK20PR-TP	PFR6M	
PK20R11	BKR6EP-11	
PK20R-13	BKR6EP-13	
PK20R-13	PFR6G-13	
PK20R8	BKR6EP-8	
PK20R-P8	BKR6EP-N-8	
PK20TR11	BKR6EKP-11	
PK22PR11	PFR7B-11	
PK22PR-L11	PZFR6F-11	
PK22PR-L11	PFR7G-11	
PK22PR-L11	PFR7G-11	
PK22PR-TP	PFR7M	
PKJ16CR8	PZFR5F	
PKJ16CR-L11	PZFR5F-11	
PKJ20CR8	PZFR6F	
PKJ20CR-L11	PZFR6F-11	
PQ16R	BCPR5EP-11	
PQ16R13	BCPR5EP-13	
PQ16R8	BCPR5EP-8	
PQ20R	BCPR6EP-11	



<b>DENSO</b>	<b>→ NGK Typ</b>	<b>V-LINE</b>
PQ20R13	BCPR6EP-13	
PQ20R8	BCPR6EP-8	
PQ20R-P11	BCPR6EP-N-11	
PQ20R-P8	BCPR6EP-N-8	
Pq20RP-8	BCPR6EPN-8	
PT16EPRL13	PTR5D-10	
PT16VR-13	PTR5A-13	25
Q14R-U11	BCPR4EY-11	
Q16PR-U	BCPR5E	
Q16PR-U11	BCPR5EY-11	
Q16P-U11	BCP5EY-11	
Q16RU	BCPR5EY	
Q16RU-11	BCPR5EY-11	
Q16-U	BCP5EY	
Q20PR-P11	BCPR6EVX-11	
Q20PR-U	BKR6E	28
Q20PR-U11	BCPR6EY-11	
Q20P-U	BCP6ES	17
Q20P-U11	BCP6E-11	
Q20R-U	BCPR6EY	
Q20R-U11	BCPR6EY-11	
Q22PR-U	BCPR7ES	
Q22PR-U11	BCPR7ES-11	
Q22P-U	BCP7ES	
Q22P-U11	BCP7ES-11	
Q27A-Z	R7232-9	
QJ16AR-U	BCRE527Y	
QJ20CR-11	ZFR6A-11	
S27	SD9A	
S29	SD10A	
S29A	SD10A	
SD29A	SD10A	
SF-10	BUHX	
SF-50	BUHW	
SF-51	BUHW-2	
SK16PR-E11	IFR5E-11/ BKR5EIX-11P	
SK16PR-L11	IFR5G-11K	
SK16RP8	IFR5T-8N	
SK20BR11	IFR6A-11T	
SK20R-11	IFR6T-11	
SK20R-11	IFR6A11	
SK22PR-M11	IFR7G-11K	
SKJ20DRM11	IZFR6K11	
SKJ20DR-M11	IZFR6K-11	
SVK20R-Z8	BKR6EP-8	
T14PR-U	BPR4FS	
T14PR-U15	BPR4FS-15	
T16EPR-U	BPR5EFS	
T16EX-U	BP5EFS	
T16PR-U	BPR5FS	
T16PR-U11	BPR5FS-11	

<b>DENSO</b>	<b>→ NGK Typ</b>	<b>V-LINE</b>
T16PR-U15	BPR5FS-15	
T16P-U	BP5FS	
T16R-U	BR5FS	
T16R-U15	BR5FS-15	
T20EPR-U	BPR6EFS	7
T20EP-U	BP6EFS	5
T20EX-U	BP6EFS	5
T20MP-U	BPM6F	
T20M-U	BM6F	
T20PR-U	BPR6FS	
T20PR-U11	BPR6FS-11	
T20PR-U15	BPR6FS	
T20P-U	BP6FS	
T20R-U	BR6FS	
T22EP-U	BP7EFS	
T22MP-U	BPM7F	
T22M-U	BM7F	
TR20	B6HS	
TR22	B7HS	
TR22-10	B7HS-10	
TR24	B8HS	
TR24-10	B8HS-10	
U14FSRUB	CR4HSB	
U16FS-L	C5HSA	
U16FSR-L	CR5HSA	
U16FSR-U	CR5HSA	
U16FSR-UB	CR5HSB	
U16FS-U	C5HSA	
U16FS-UB	C5HSB	
U17F	C5HSA	
U20FS	C6HSA	
U20FS-L	C6HSA	
U20FSR-U	CR6HSA	
U20FS-U	C6HSA	
U20M-U	CM6	
U22ESR-N	CR7E	
U22FS	C7HSA	
U22FS-GU	C7HVX	
U22FS-L	C7HSA	
U22FSR-L	CR7HS	
U22FS-U	C7HSA	
U24ES-N	C8E	
U24ESR-N	CR8E	
U24ETR	CR8EK	
U24FE9	C8EH-9	
U24FER9	CR8EH-9	
U24FS	C8HSA	
U24FS-C	L8A	
U24FS-L	C8HSA	
U24FSR-C	LR8A	
U24FSR-U	CR8HS	
U24FS-U	C8HSA	





<b>DENSO</b>	<b>→ NGK Typ</b>	<b>V-LINE</b>
U27ES-N	C9E	
U27ESR-N	CR9E	
U27ETR	CR9EK	
U27FE9	C9EH-9	
U27FER-9	CR9EH-9	
U31ESR-N	CR10E	
U31ETR	CR10EK	
VUH27D	IMR9C-9H	
W14	B4	
W14E	B4ES	
W14EPR-U	BPR4ES	
W14EP-U	BP4ES	
W14EXR-U	BPR5EA	
W14EXR-U	BPR4EY	
W14EXR-U11	BPR4EY-11	
W14EX-U	BP4EY	
W14EX-U11	BP4EY-11	
W14F	B4H	
W14FP	BP4H	
W14FP-L	BP4HS	
W14FPR	BPR4H	
W14FPR-L	BPR4HS	
W14FPR-UL	BPR4HS	
W14FPR-UL10	BPR4HS-10	
W14FP-U	BP4H	
W14FP-UL	BP4HS	
W14FP-UL10	BP4HS-10	
W14FR-U	BR4HS	
W14F-U	B4H	
W14F-U10	B4H-10	
W14L	B4L	
W14LMR-US	BR4LM	
W14LM-U	B4LM	
W14LM-US	B4LM	
W14MPR-U10	BPMR4A	
W14MP-U10	BPM4A-10	
W14MR-U	BMR4A	
W14M-U	BM4A	
W14M-US	BM4A	
W14P	BP5S	
W14PR-U	BP4	
W14-U	B4	
W14-US	B4	
W16EKR-S11	BUR5EB-11	
W16EK-S11	BUR5EB-11/BU5EB-11	
W16EP-GU	BP5EVX	
W16EPR-S11	BUR5EA-11	
W16EPR-U	BPR5ES	6
W16EPR-U11	BPR5ES-11	
W16EPU	BP5ES	
W16EP-U	BP5ES	8
W16EP-U10	BP5ES-11	

<b>DENSO</b>	<b>→ NGK Typ</b>	<b>V-LINE</b>
W16EP-ZU	BP5EVX	
W16ES	B5ES	
W16ES-L	BR5ES/BR5EB	
W16ES-L11	BUR5EB-11/BR5EB-11	
W16ESR-U	BR5ES	
W16ES-U	B5ES	
W16ETR-S	BPR5EKA	
W16ET-S	BP5EKA	
W16EXR-U	BPR5EY	9
W16EXR-U11	BPR5EY-11	
W16EXU	BP5EY	
W16EX-U	BP5EAL	
W16EX-U11	BP5EA-L-11	
W16EX-U13	BP5ES-13	
W16FP	BP5HS	
W16FP-L	BP5HA	
W16FPR	BPR5HS	
W16FPR-U	BPR5HS	
W16FP-U	BP5HS	
W16FP-U10	BP5HS-10	
W16FP-UL	BP5HA	
W16FS	B5HS	
W16FSR	BR5HS	
W16FS-U	B5HS	
W16LS	B6L	
W16PR-U	BPR5S	
W16P-U	BP5S	
W17P	BP6S	
W17PR-U	BP6S	
W20DTR-S	BKR6EKB	
W20DTR-SA	BPR6EKB-L	
W20EA	B6EM	
W20EAR	BR6EM	
W20EKR-S11	BUR6EB-11	
W20EK-S11	BUR6EB-11/BU6EB-11	
W20EP	B6ES	
W20EPB	BP6ET	
W20EPBRS	BUR6ET	1
W20EP-GU	BP6EVX	
W20EPRS-11	BUR6EA-11	
W20EPR-U	BPR6ES	2
W20EPR-U10	BPR6ES-11	13
W20EPR-U11	BPR6ES-11	13
W20EP-S11	BU6EA-11	
W20EP-U	BP6ES	4
W20EP-U11	BP6ES-11	
W20EP-ZU	BP6EVX	
W20ES	B6ES	
W20ES-GU	B6EVX	
W20ES-L	BR6ES/B6EB	
W20ES-L11	BUR6EB-11/B6EB-11	
W20ESR	BR6ES	



<b>DENSO</b>	<b>→ NGK Typ</b>	<b>V-LINE</b>
W20ESR-L	BR6ES/BR6EB	
W20ESR-L11	BUR6EB-11/BR6EB-11	
W20ES-U	B6ES	
W20ES-U11	B6ES-11	
W20ES-ZU	B6EVX	
W20ET	BP6EK	
W20ET-L	BP6EKN	
W20ETR-L	BPR6EKN	
W20ETR-S	BPR6EK-A	
W20ET-S	BP6EK-A	
W20EXR-U	BPR6EY	
W20EXR-U11	BPR6EY-11	10
W20EX-U	BP6EY	
W20EX-U11	BP6EY-11	
W20EX-U13	BP6ES-13	
W20FP	BP6HS	18
W20FP-L	BP6HSA	
W20FPR	BPR6HS	3
W20FPR-U	BPR6HS	3
W20FP-U	BP6HS	18
W20FP-U10	BP6HS-10	
W20FS	B6HS	
W20FS-GU	B6HVX	
W20FSR	BR6HS	
W20FSR-U	BR6HS	
W20FS-U	B6HS	
W20FS-ZU	B6HVX	
W20M	BM6A	
W20MP-U	BPM6A	
W20MP-U10	BPM6A-10	
W20MR-U	BMR6A	
W20M-U	BM6A	
W20M-US	BM6A	
W20S	B6S	
W20SR-U	BR6S	
W20S-U	B6S	
W21ES-L11	BR6EB-L-11/B6EB-L-11	
W21ESR-L11	BR6EB-L-11	
W22EA	B7EM	
W22EAR	BR7EM	
W22EB	BR7ET/B7ET	
W22EBR	BR7ET	
W22EDR	BR7EQ	
W22EDR14	BR7EQ-14	
W22EK-S11	BUR7EB-11/BU7EB-11	
W22EP	BP7ES	
W22EP11	BP7ES-11	
W22EP-GU	BP7EVX	
W22EPR-U	BPR7ES	19
W22EP-S11	BU7EA-11	
W22EP-U	BP7ES	
W22EP-ZU	BP7EVX	

<b>DENSO</b>	<b>→ NGK Typ</b>	<b>V-LINE</b>
W22ES	B7ES	
W22ES-GU	B7EVX	
W22ES-L	B7EB	
W22ES-L11	B7EB-11	
W22ESR	BR7ES	
W22ESR-L	BR7EB	
W22ESR-L11	BR7EB-11	
W22ESR-U	BR7ES	
W22ES-U	B7ES	
W22ES-U11	B7ES-11	
W22ES-ZU	B7EVX	
W22FP	BP7HS	
W22FPR-U	BPR7HS	
W22FP-U	BP7HS	
W22FP-U10	BP7HS-10	
W22FS	B7HS	
W22FS-GU	B7HVX	
W22FSR	BR7HS	
W22FS-U	B7HS	
W22FS-ZU	B7HVX	
W22M	BM7A	
W22MP-U	BPM7A	
W22MP-US	BPM7A	
W22M-U	BM7A	
W22M-US	BM7A	
W22S	B7S	
W22S-U	B7S	
W24EP	BP8ES	
W24EP-11	BP8ES	
W24EP-U	BP8ES	
W24ES	B8ES	
W24ES-GU	B8EVX	
W24ESR	BR8ES	
W24ESR-U	BR8ES	
W24ES-U	B8ES	
W24ES-U11	B8ES-11	
W24ES-V	B8EG	
W24ES-ZU	B8EGV	
W24FP-L	BP8HSA	
W24FP-U	BP8HS	
W24FS	B8HS	
W24FS-GU	B8HVX	
W24FSR	BR8HS	
W24FS-U	B8HS	
W24FS-U10	B8HS-10	
W24FS-ZU	B8HVX	
W24S	B8S	
W24S-U	B8S	
W25EA	B8EM	
W25EAR	BR8EM	
W25EB	BR8ET/B8ET	
W25EBR	BR8ET	



<b>DENSO</b>	<b>→ NGK Typ</b>	<b>V-LINE</b>
W25EDR	BR8EQ	
W25EDR14	BR8EQ-14	
W25EN	B8EG	
W25EPT	B8EGP	
W25FC	B8HCS	
W25FN	B8HVX	
W27EBR	BR9ET	
W27EDR14	BR9EQ-14	
W27EMR-C	BR9ECM	
W27EN	B9EG	
W27EPT	B9EGP	
W27ES	B9ES	
W27ES-GU	B9EVX	
W27ESR	BR9ES	
W27ES-U	B9ES	
W27ES-V	B9EG	
W27ES-ZU	B9EGV	
W27FC	B9HCS	
W27FS	B9HS	
W27FS-GU	B9HVX	
W27FSR	BR9HS	
W27FS-U	B9HS	
W27FS-U10	B9HS-10	
W27FS-ZU	B9HVX	
W27S	B9S	
W27S-U	B9S	
W29EPT	B95EGP	
W29ES-GU	B95EGV	
W29ES-ZU	B95EGV	
W31EN	B10EG	
W31EPT	B10EGP	
W31ES	B10ES	
W31ES-GU	B10EVX	
W31ES-U	B10ES	
W31ES-ZU	B10EGV	
W31FS	B10HS	
W31FS-GU	B10HVX	
W31FS-ZU	B10HVX	
W32EPT	B105EGP	
W34ES-ZU	B11EGV	
W9	B2	
W9EP	BP2E	
W9EXR-U	BPR2ES	
W9EX-U	BP2E	
W9FP	BP2H	
W9FP-L	BP2HS	
W9FP-UL	BP2HS	
W9LMR-US	BR2LM	
W9LM-US	B2LM	
W9P	BP4	
W9-U	B2	
WA20M	BM6F	

<b>DENSO</b>	<b>→ NGK Typ</b>	<b>V-LINE</b>
WA20M-U	BM6F	
WA22M	BM7F	
WA22M-U	BM7F	
X16FSR-U	DR5HS	
X20EPR-GL	PJR6A	
X20FS-GU	D6HVX	
X20FSR-U	DR6HS	
X20FS-U	D6HA	
X22EPR-GL	PJR7A	
X22EPR-U9	DPR7EA-9	
X22EP-U9	DP7EA-9	
X22ES-GU	D7EVX	
X22ESR-U	DR7ES	
X22ES-U	D7EA	
X24EPR-GL	PJR8A	
X24EPR-U9	DPR8EA-9	
X24EP-U9	DP8EA-9	
X24ES-GU	D8EVX	
X24ESR-U	DR8ESL	
X24ES-U	D8EA	
X24FSR-U	DR8HS	
X24FS-U	D8HA	
X24GPR-U	DPR8Z	
X24GP-U	DP8Z	
X27EPR-U9	DPR9EA-9	
X27EP-U9	DP9EA-9	
X27ESR-U	DR8ES	
X27ES-U	D9EA	
X27GPR-U	DPR9Z	
X27GP-U	DP9Z	
X31ES-U	D10EA	
XE20HRU9	LZKAR7A	
XU20EPR-U	DCPR6E	
XU20EP-U	DCP6E	
XU22EPR-U	DCPR7E	
XU22EPR-ZU	DCPR7EVX	
XU22EP-U	DCP7E	
XU22EP-ZU	DCP7EVX	
XU24EPR-U	DCPR8E	
XU24EPR-ZU	DCPR8EVX	
XU24EP-U	DCP8E	
XU24EP-ZU	DCP8EVX	
Y27FER	ER9EH	
Z20ES-U	D6EA	
<b>DUCATI</b>	<b>→ NGK Typ</b>	<b>V-LINE</b>
67040381A	MAR10A-J	
<b>ENKER / BOSNA</b>	<b>→ NGK Typ</b>	<b>V-LINE</b>
F100C	B8HS	
F45CP	BP4HS	
F50C	B5HS	



<b>ENKER / BOSNA</b>	<b>→ NGK Typ</b>	<b>V-LINE</b>
F55CP	BP5HS	
F65CP	BP6HS	18
F75C	B6HS	
F80C	B7HS	
F85CP	BP7HS	
FA50	B4L	
FA70	B6L	
FE100C	B9ES	
FE30C	B4ES	
FE35CP	BP4ES	
FE45CP	BP5ES	8
FE50C	B5ES	
FE55CP	BP5ES	8
FE55CPD	BP5ET	
FE65CP	BP6ES	4
FE65CPD	BP6ET	
FE70C	B6ES	
FE75C	B7ES	
FE80C	B8ES	
FE85CP	BP7ES	
FE85CPD	BP7ET	
FE85CPU	BP7ET	
FE95CP	BP8ES	
FET65CP	BP5EFS	
FET75CP	BP6EFS	5
FS20	B2	
FS30	B4	
FS35CP	BP4S	
FS50CP	BP5S	
FS55CP	BP6S	
FS70	B6S	
FS75C	B7S	
FS80	B8S	
FSC50C	BM6A	
FSC50P	BPM6A	
FSC70P	BPM6A	
FSC75CP	BPM7A	
FT45CP	BP5FS	
FT55CP	BP6FS	
FT85CP	BP7FS	
M30	AB2	
M60	A6	
M75	A7	
M80	A8	
MT45CP	AP5FS	
MT55CP	AP6FS	
MT65CP	AP7FS	
SFE55CP	BCPR5ES	32
SFE65CP	BCPR6ES	
SFE65CPD	BCP6ET	
SFE85CP	BCPR7ES	
SFE85CPD	BCP7ET	

<b>ENKER / BOSNA</b>	<b>→ NGK Typ</b>	<b>V-LINE</b>
T70	C6HSA	
T90	C7HSA	
<b>EVINRUDE</b>	<b>→ NGK Typ</b>	<b>V-LINE</b>
204470091	BR7ES	
278000237	BR7ES	
278000608	BR7ES	
278000609	BR8ES	
MCBR10EG	BR10EG	
MCBR8EG	BR8EG	
MCBR8HS	BR8HS	
MCBR9EG	BR9EG	
MCBR9ES	BR9ES	
<b>EYQUEM</b>	<b>→ NGK Typ</b>	<b>V-LINE</b>
1000	B8HS	
1000 MOTO	B8HS	
1000CM	B7S	
1000L	B8ES	
1000L MOTO	B8HS	
1000M	B8HS	
100M	B8HS	
1100	B9HS	
1100L	B8ES	
1100L MOTO	B8ES	
1150L	B9ES	
200	B4H	
202CT	B2LM	
300AM	B4L	
30AM	B4L	
400J	BR5FS	
406	BP6HS	18
450JS	BPR4FS-15	
450L	B5ES	
480CS	BP5S	
500AM	B6L	
500C	B6S	
500CJT	BM6F	
500CM	B6S	
500CS	BP5S	
500CT	BM6A	
500J	BR6FS	
500JS	BPR4FS	
500M	B5HS	
502 MOTO	B4H	
502CT	B4LM	
505JS	BP5FS	
50AM	B-6L	
50M	B5HS	
520CS	BP5S	
550CS	BP5S	
550JS	BPR5FS	



<b>EYQUEM</b>	<b>→ NGK Typ</b>	<b>V-LINE</b>
550LS	BP5ES	8
550S	BP4HS	
580LS	BP5ES	8
580S	BP4HS	
600CS	BP5S	
600JS	BPR6FS	
600L	B6ES	
600LS	BP6ES	4
600S	BP5HS	
700	B6HS	
700 MOTO	B6HS	
700CM	B6S	
700CTS	BPM6A	
705JS	BP7FS	
705L	B6ES	
705L MOTO	B6ES	
705S	BP6HS	18
705S MOBY MOTO	B5HS	
707LS	BP6ES	4
70M	B6HS	
750	BP6HS	18
750L	B6ES	
750LJS	BP6EFS	5
750LS	BP6ES	4
753LJS	BP6EFS	5
755	B6HS	
755 MOTO	B6HS	
755CJT	BM7F	
755CM	B6S	
755CT	BM7A	
755L	B6ES	
755L MOTO	B6ES	
755LJS	BP6EFS	5
755LS	BP6ES	4
755LS MOTO	BP6ES	4
755M	B6HS	
755S	BP6HS	18
75LM	B6ES	
75M	B6HS	
775SX	BP6HS	18
775X	B6HS	
800L	B6ES	
800LJS	BP6EFS	5
800LS	BP6ES	4
800LS MOTO	BP6ES	4
802L	B6ES	
803LJS	BP6EFS	5
805L	B6ES	
805L MOTO	B6ES	
805LJS	BP7EFS	
805LJSP	BP7EFVX	
805LP	B8EVX	

<b>EYQUEM</b>	<b>→ NGK Typ</b>	<b>V-LINE</b>
850	B7HS	
850 MOTO	B7HS	
850LS	BP7ES	
883LJP	B8EFS	
C32	B5HS	
C32LS	BP5ES	8
C32S	BP5HS	
C42LJS3	BP6EFS	5
C42S	BP6HS	18
C52LS	BP5ES	8
C62	B7HS	
C62LJS	BP6EFS	5
C62LJS	BP6EF	
C62LS	BP6ES	4
C62LS	BP6E	
C62LS3X	BP5ET	
C62S	BP7HS	
C72LJS	BP7EFS	
C72LS	BP7ES	
C72LS3X	BP6ET	
C82LJS	BP7EFS	
C82LS	BP7ES	
C82LS3X	BP7ET	
C92LS	BP8ES	
D1000	D8HA	
D1000 MOTO	D8HA	
D1000L	D9EA	
D1050L	D9EA	
D755 MOTO	D6HA	
D775	D6HA	
D800L	D7EA	
D800L MOTO	D7EA	
D900L	D8EA	
FC42LS	BCP5ES	16
FC52LS	BCP5E	
FC52LS	BCP5ES	16
FC58LS	BCP6ES	17
FC62LS	BCP6ES	17
FC62LS2	BCP6ES	17
FC62LS3	BCP6ET	
FC62LS3X	BCP6ET	
FC72LS	BCP7ES	
FC82LS	BCP7E	
FC82LS1	BCP7ES	
FC82LS2	BCP7ES	
FN52LS	BK5ESZ	
K200M	A6	
K300J	A5FS	
K300JS	AP5FS	
K300M	A6	
K350JS	AP5FS	
K450JS	AP5FS	



<b>EYQUEM</b>	<b>→ NGK Typ</b>	<b>V-LINE</b>
K500M	A6	
K550JS	AP6FS	
K600M	A6	
K750M	A7	
KC62JS	AP6FS	
R1000	BR8HS	
R1000L	BR8ES	
R850	BR7HS	
RC32LS5	BPR4ES-11	
RC42S	BPR6HS	3
RC52LS	BPR5EA	
RC52LS5	BPR5EA-11	
RC52LZ3EX	BUR5ET	22
RC52LZE	ZGR5A	15
RC58LZ3EX	BUR6ET	1
RC62HJSDP	PTR5A-13	25
RC62LJS	BPR6EFS	7
RC62LS	BPR6ES	2
RC62LS5	BPR6ES-11	13
RC62S	BPR7HS	
RC82LS	BPR7ES	19
RC82LS5	BPR7EY-11	
RFC42LS	BCPR5ES	32
RFC42LS2E	BKR5EK	23
RFC50LZ2E	BKR5EK	23
RFC52LS	BCPR5ES	32
RFC52LS3	BCPR5ET	
RFC52LS5	BKR5E-11	33
RFC52LS5	BCPR5ES-11	
RFC52LSP	BKR6EK	20
RFC52LZE	ZFR5F	
RFC52LZK	BKR5EZ	
RFC57LS3	BCPR6ET	
RFC58LS	BKR6E	28
RFC58LS2E	BKR6EK	20
RFC58LS3	BCPR6ET	
RFC58LS5	BKR6ES-11	
RFC58LS5	BCPR6ES-11	11
RFC58LSP	BKR6EZ	
RFC58LZ	BKR6EY	
RFC58LZ2	BKR6EKC	26
RFC58LZ2E	BKR5EZ	
RFC58LZ3EX	BKUR6ET	27
RFC58LZ5	BKR6EY-11	
RFC58LZE5	ZFR6F-11	
RFC62LS3X	BCPR6ET	
RFC62LS5	BCPR6ES-11	11
RFC62LZ3X	BKUR7ET	
RFC82LS	BCPR7ES	
RFC82LS5	BCPR7ES-11	
RFN52HZ	LFR5B	
RFN58HZ	LFR6B	

<b>EYQUEM</b>	<b>→ NGK Typ</b>	<b>V-LINE</b>
RFN58LZ	BKR6EK	20
T850	C7HSA	
XKC62JS	APR6FS	
<b>FERRARI</b>	<b>→ NGK Typ</b>	<b>V-LINE</b>
192637	PMR8B	
<b>FIAT</b>	<b>→ NGK Typ</b>	<b>V-LINE</b>
46144731	DCPR8E	
46229251	BP6ES	4
46417010	BKR6E	28
46449690	BKR6EKPA	
46463801	BKR6EKC	26
46471078	BKUR6ETB	
46472021	BKR6EKC	26
46475164	BCPR7ET	
46521529	BKR6EKPA	
46521530	PMR7A	
46531917	DCPR8EKC	
46550992	CR7EKC	
55188857	DCPR7E-N-10	
55190788	ZKR7A-10	
5894585	BPR7ES	19
5894586	BKR6E	28
5894588	BCPR7ES	
5896824	BKR6EKC	26
5984036	BPR6ES	2
60504563	BP6ES	4
60512848	BCP6ET	
60512929	B7ES	
60569957	PFR6B	
60597490	BCP7ES	
60800325	BPR7ES	19
60806024	BP6ET	
60810689	PFR6B	
71711638	BKR6E	28
71711639	BPR6ES	2
71711640	BPR6ES	2
71711806	BPR6ES	2
71711808	BKR6E	28
7546519	BKR6E	28
7554436	BPR7ES	19
7554442	BP6ES	4
7554444	BPR6ES	2
7554445	BP6HS	18
7565476	BR8ES	
7686643	BP6ET	
7760381	BPR7ES	19
7760382	BPR6ES	2
7760383	BKR6E	28
7760384	BCPR7ES	
7769243	BCPR6ET	



<b>FIAT</b>	<b>→ NGK Typ</b>	<b>V-LINE</b>
7772453	BKR6E	28
7772515	BPR7ES	19
7910247204	BPR6EFS	7
7FYSR	BPR7ES	19
7FYSSR	BPR7ES	19
7GBYSR4	BCPR7ET	
7GYSSR	BCPR7ES	
9614738680	BKR6EK	20
9618494580	BKR5EK	23
9618571880	BKR6EK	20
9619624580	BKR5EK	23
9FYSSR	BPR6ES	2
9GYSSR	BKR6E	28
<b>FORD</b>	<b>→ NGK Typ</b>	<b>V-LINE</b>
1032705	BKR5EKUP	
1077002	PTR5A-13	25
1120170	PZFR5D-11	34
1202935	PLTR6A-10G	
1202935	PLTR6A-10G	
1204572	PTR6F-13	
1219309	TR5B-13	
1255464	TR5B-13	
AGFS22FE13J	PTR6F-13	
AGPR32PD	BKR5EKUP	
AGPS44F	PZFR5D-11	34
AGSF32FM	TR55IX	
AYFS22FE1J	PLTR6A-10G	
AYFS32CJ	TR5B-13	
<b>FUJI</b>	<b>→ NGK Typ</b>	<b>V-LINE</b>
065-01400-10	B4	
065-01400-20	B4H	
065-01400-31	B6HS	
065-01400-41	B7HS	
065-01400-50	B7ES	
065-01400-60	B6HS	
065-01400-80	B4	
065-01400-90	B7HS	
065-01401-00	B6ES	
065-01401-10	B4H	
065-01401-30	B7ES	
065-01401-40	B8ES	
065-01401-50	BR6HS	
065-01401-60	B9ES	
065-01401-70	BP4H	
065-01401-80	BR7HS	
065-01401-90	BP4HS	
065-01402-10	BP6HS	18
065-01402-20	B10EVX	
065-01402-30	BP5ES	8
065-01402-40	BR8ES	

<b>FUJI</b>	<b>→ NGK Typ</b>	<b>V-LINE</b>
065-01402-50	BR9ES	
065-01402-60	BP5HS	
065-01402-70	BPR4HS	
065-01402-80	BPR5ES	6
065-01403-00	BP6ES	4
065-01403-10	BR4HS	
065-01403-20	BPR4HS-10	
065-01403-30	BPR4ES	
065-01403-40	BP2HS	
065-01403-60	BP2H	
065-01403-70	BM4A	
065-01403-80	BMR4A	
065-01403-90	BP4HS	
065-01404-10	B2H	
065-01404-20	BPR6HS	3
065-01404-30	BPM6A	
065-01404-60	BM6A	
065-01404-70	BMR6A	
065-01405-00	B9HS	
065-01405-10	BR6HS	
932-05410-00	B5ES	
942-05449-00	B4E	
982-05486-00	B6ES	
<b>GUTBROD</b>	<b>→ NGK Typ</b>	<b>V-LINE</b>
000.80.071	B6HS	
000.81.345	B4LM	
090.33.668	B4H	
090.50.572	B4HS	
090.50.805	BPR6ES	2
092.05.406	BR2LM	
092.05.900	B6S	
092.13.609	BR4LM	
092.25.081	BP5ES	8
092.32.278	BCPR5ES	32
092.38.072	BPR5ES	6
092.38.467	BM6A	
092.40.182	BPR5EFS	
<b>HARLEY-DAVIDSON</b>	<b>→ NGK Typ</b>	<b>V-LINE</b>
10R12A	DCPR9E	
3	B6L	
3-4	BP5S	
4	B6L	
4-5	BP7HS	
4R	B6L	
4R5	BPR7HS-10	
5	B6S	
5A6	BP5EY	
5R6	BPR5EY	9
5R6A	BPR5EY-11	
5RL	ZGR5C	



<b>HARLEY-DAVIDSON</b>	<b>→ NGK Typ</b>	<b>V-LINE</b>
6R12	DPR7EA-9	
8	B10EGV	
<b>HONDA</b>		
	<b>→ NGK Typ</b>	<b>V-LINE</b>
12290-PHM-003	ILZFR6A11(A)	
12290-PNE-0030	ZFR6K-11	
12290-PPD-003	LZFR6AT-S	
12290-PRB-A01	IFR7G-11K	
12290-RMX-003	ILFR6J-11K	
12291-PHM-003	ILZFR6A11(B)	
12292-PHM-003	ILZFR6A11(C)	
12293-PHM-003	ILZFR6A11(D)	
31908-KTW-9010-M1	LMAR8A-9	
31911-HW1-671	IMR9D-9H	
31911-KRN-731	R0409B-8	
31911-KSK-731	BR9EG-N-8	
31911-mbt-f21	IJR8B9	
31911-MBW-E11	IMR8C-9H	
31911-MBW-E11	IMR8C-9H	
31911-mcw-003	IMR8B-9H	
31912-KRN-731	R0409B-9	
31912-MBW-E11	IMR9C-9H	
31912-MCW-0030	IMR9B-9H	
31912-MEE-671	IMR9C-9HE	
31912-MEE-J01	IMR8C-9HES	
31912-MEL-003	IMR9C-9HES	
31914-ZOH-003	CMR4H	
31914-ZOH-801	CM4H	
31914-ZOH-003	CMR4H	
31915-ZOH-003	CMR5H	
31915-ZOH-801	CM5H	
31915-ZOH-003	CMR5H	
31916-KRM-841	CPR8EA-9	
31916-ZOH-003	CMR6H	
31916-ZOH-801	CM6H	
31916-ZOH-003	CMR6H	
31916-ZY3-003	IZFR6F11	
31918-MEB-671	IFR8H11	
31919-MEB-671	IFR9H11	
31988-GEV-761	ER8EH-N	
31989-GEV-761	ER9EH-N	
94701-00408	CR9EIA-9	
98049-58716	ER8EH	
98049-59716	ER9EH	
98049-60716	ER10EH	
98052-56471	CM6	
98056-54717	C4HA	
98056-54718	CR4HSA	
98056-54770	C4HSB	
98056-55713	C5HSA	
98056-55717	C5HA	
98056-55718	CR5HSA	

<b>HONDA</b>	<b>→ NGK Typ</b>	<b>V-LINE</b>
98056-55770	C5HSB	
98056-55777	CR5HSB	
98056-56713	C6HSA	
98056-56716	CR6HS	
98056-56717	C6HA	
98056-56718	CR6HSA	
98056-57713	C7HSA	
98056-57716	CR7HS	
98056-57717	C7HA	
98056-57718	CR7HSA	
98056-57918	CR7HSA-9	
98056-58713	C8HSA	
98056-58716	CR8HS	
98056-58717	C8HA	
98056-58718	CR8HSA	
98059-55916	CR5EH-9	
98059-56916	CR6EH-9	
98059-57910	C7EH-9	
98059-57916	CR7EH-9	
98059-58910	C8EH-9	
98059-58916	CR8EH-9	
98059-5891F	CR8EHVX-9	
98059-5891U	IMR8A-9H	
98059-589J6	CR8EH-9S	
98059-59910	C9EH-9	
98059-59916	CR9EH-9	
98059-5991F	CR9EHVX-9	
98059-5991U	IMR9A-9H	
98059-599J6	CR9EH-9S	
98059-599U	CR9EHI-9	
98059-60916	CR10EH-9	
98061-57611	DP7Z	
98061-57616	DPR7Z	
98061-58611	DP8Z	
98061-58616	DPR8Z	
98061-59611	DP9Z	
98061-59616	DPR9Z	
98066-54710	D4H	
98066-54716	DR4HS	
98066-55710	D5HS	
98066-55716	DR5HS	
98066-55740	D5HS	
98066-56710	D6HS	
98066-56716	DR6HS	
98066-56717	D6HA	
98066-58714	D8HS	
98066-58716	DR8HS	
98066-58717	D8HA	
98066-60710	D10HS	
98069-38716	DR8ESL	
98069-55911	DP5EA-9	
98069-55916	DPR5EA-9	





<b>HONDA</b>	<b>→ NGK Typ</b>	<b>V-LINE</b>
98069-56716	DR6ES	
98069-56717	D6EA	
98069-56718	DR6EA	
98069-56911	DP6EA-9	
98069-56916	DPR6EA-9	
98069-5691U	IJR6A9	
98069-5697Q	DCPR6E	
98069-57716	DR7ES	
98069-57717	D7EA	
98069-57719	DR7ES	
98069-5771P	DR7EA	
98069-57726	DR7EA	
98069-57911	DP7EA-9	
98069-57912	DPR7EVX-9	
98069-57916	DPR7EA-9	
98069-5791U	IJR7A9	
98069-5791U	IJR7A9	
98069-5797Q	DCPR7E	
98069-58716	DR8ES	
98069-58717	D8EA	
98069-58719	DR8ES	
98069-5871P	DR8EA	
98069-58911	DP8EA-9	
98069-58912	DPR8EVX-9	
98069-58916	DPR8EA-9	
98069-5891F	DPR8EVX-9	
98069-59717	D9EA	
98069-59911	DP9EA-9	
98069-59912	DPR9EVX-9	
98069-59916	DPR9EA-9	
98069-5991F	DPR9EVX-9	
98069-60711	D10ES	
98069-60717	D10EA	
98069-63410	D13E	
98073-52710	B2	
98073-54710	B4	
98073-54740	BM4A	
98073-54744	BMR4A	
98073-54771	BPM4A	
98073-54776	BPMR4A	
98073-54941	BPM4A-10	
98073-54944	BPMR4A-10	
98073-56740	BM6A	
98073-56741	BPM6A	
98073-56744	BMR6A	
98073-56941	BPM6A-10	
98073-56944	BPMR6A-10	
98076-52711	BP2HS	
98076-52716	BPR2HS	
98076-52717	BPR2HS	
98076-52719	BP2HS	
98076-5401G	BR4HSA-10	

<b>HONDA</b>	<b>→ NGK Typ</b>	<b>V-LINE</b>
98076-54112	BP4HK	
98076-54710	B4H	
98076-54711	BP4HS	
98076-54713	BP4HSA	
98076-54715	BPR4HSA	
98076-54716	BR4HS	
98076-54717	BPR4HS	
98076-54719	BP4HS	
98076-5471G	BR4HSA	
98076-54746	BR4HS	
98076-54747	BPR4HS	
98076-54770	B4H	
98076-54911	BP4HS-10	
98076-54914	BPR4HS-10	
98076-54917	BPR4HS-10	
98076-54919	BP4HS-10	
98076-5491G	BR4HSA-9	
98076-54944	BPR4HS-10	
98076-54947	BPR4HS-10	
98076-55711	BP5HS	
98076-55716	BR5HS	
98076-55717	BPR5HS	
98076-55719	BP5HS	
98076-55747	BPR5HS	
98076-5601G	BR6HSA-10	
98076-56112	BP6HK	
98076-56710	B6HS	
98076-56711	B6HS	
98076-56713	BP6HSA	
98076-56715	BPR6HSA	
98076-56716	BR6HS	
98076-56717	BPR6HS	3
98076-56719	BP6HS	18
98076-5671G	BR6HSA	
98076-5671M	B6HSA	
98076-56740	B6HS	
98076-56741	B6HS	
98076-56747	BPR6HS	3
98076-56917	BPR6HS-10	
98076-5691G	BR6HSA-9	
98076-57710	B7HS	
98076-57711	BP7HS	
98076-57716	BR7HS	
98076-57717	BPR7HS	
98076-57719	BP7HS	
98076-57740	B7HS	
98076-5801G	BR8HSA-10	
98076-58112	BP8HK	
98076-58710	B8HS	
98076-58711	BP8HS	
98076-58713	BP8HSA	
98076-58715	BPR8HSA	



<b>HONDA</b>	<b>→ NGK Typ</b>	<b>V-LINE</b>
98076-58716	BR8HS	
98076-58717	BPR8HS	
98076-58719	BP8HS	
98076-5871G	BR8HSA	
98076-5871M	B8HSA	
98076-58740	B8HS	
98076-58747	BPR8HS	
98076-5891G	BR8HSA-9	
98076-59710	B9HS	
98076-59716	BR9HS	
98076-59740	B9HS	
98079-52876	BPR2ES	
98079-54148	BCPR4E-11	
98079-5414G	ZFR4F-11	
98079-54173	BUR4EB-11	
98079-54817	BPR4ES	
98079-54841	BP4ES	
98079-54846	BPR4ES	
98079-55140	BCP5EY-11	
98079-55141	BP5EY-11	
98079-55144	BP5ES-11	
98079-55145	BPR5ES-11	
98079-55146	BPR5EY-11	
98079-55147	BCPR5ES-11	
98079-55148	BCPR5E-11	
98079-55149	BCPR5EY-11	
98079-5514A	BCPR5EYN-11	
98079-5514B	BCP5E-11	
98079-5514E	BKR5E-11	33
98079-5514F	BCPR5EVX-11	
98079-5514G	ZFR5F-11	
98079-5514H	PFR5G-11	
98079-5514J	BKR5EN-11	
98079-5514N	PZFR5F-11	
98079-5514P	ZFR5J-11	
98079-5515G	ZFR6F-11	
98079-55173	BUR5EB-11	
98079-55174	BU5EB-11	
98079-55176	BR5EB-11	
98079-55178	B5EB-11	
98079-5517S	PFR5L-11	
98079-5517U	IFR5L11	
98079-5517V	IFR5G-11K	
98079-5517W	IZFR5F11	
98079-5547V	ZGR5A-4	
98079-55810	B5ES	
98079-55811	BP5ES	8
98079-55816	BR5ES	
98079-55817	BPR5ES	6
98079-55840	B5ES	
98079-55841	BP5ES	8
98079-55844	BP5EVX	

<b>HONDA</b>	<b>→ NGK Typ</b>	<b>V-LINE</b>
98079-55846	BPR5ES	6
98079-55847	BR5ES	
98079-55848	B5EB	
98079-55849	BR5EB	
98079-5585V	ZGR5A	
98079-5587G	ZFR5F	
98079-5587V	ZGR5A	15
98079-55941	BP5EY	
98079-55946	BPR5EY	9
98079-55A4N	PZFR5F-13	
98079-56140	BCP6EY-11	
98079-56144	BP6ES-11	
98079-56145	BPR6ES-11	13
98079-56146	BPR6EY-11	10
98079-56147	BCPR6ES-11	11
98079-56148	BCPR6E-11	11
98079-56149	BCPR6EY-11	
98079-5614A	BCPR6EYN-11	
98079-5614B	BCP6E-11	
98079-5614E	BKR6E-11	14
98079-5614F	BCPR6EVX-11	
98079-5614G	ZFR6F-11	
98079-5614H	PFR6G-11	
98079-5614J	BKR6EN-11	
98079-5614N	PZFR6F-11	
98079-5614P	ZFR6J-11	
98079-5615G	ZFR6F-11	
98079-5615N	PZFR6F-11	
98079-56173	BUR6EB-11	
98079-56174	BU6EB-11	
98079-56175	BP6EY-11	
98079-56178	B6EB-11	
98079-56179	BR6EB-11	
98079-5617S	PFR6L-11	
98079-5617T	PFR6N-11	
98079-5617U	IFR6L11	
98079-5617V	IFR6G-11K	
98079-56614	B6EVX	
98079-56614	B6EV	
98079-56810	B6ES	
98079-56811	BP6ES	4
98079-56817	BR6ES	
98079-56840	B6ES	
98079-56841	BP6ES	4
98079-56841	BP6ES	
98079-56844	BP6EVX	
98079-56846	BPR6ES	2
98079-56847	BR6ES	
98079-56848	B6EB	
98079-56849	BR6EB	
98079-56874	B6EV	
98079-56941	BP6EY	



<b>HONDA</b>	<b>→ NGK Typ</b>	<b>V-LINE</b>
98079-56946	BPR6EY	
98079-5697U	IFR6C	
98079-569BE	BKR6E-9S	
98079-569BU	IFR6C-S	
98079-56A7H	PFR6G-13	
98079-56A7S	PFR6L-13	
98079-57140	BCP7EY-11	
98079-57144	BP7ES-11	
98079-57145	BPR7ES-11	
98079-57146	BPR7EY-11	
98079-57147	BCPR7ES-11	
98079-57148	BCPR7E-11	
98079-57149	BCPR7EY-11	
98079-5714A	BCPR7EYN-11	
98079-5714B	BCP7E-11	
98079-5714E	BKR7E-11	
98079-5714F	BCPR7EVX-11	
98079-5714G	ZFR7F-11	
98079-5714H	PFR7G-11	
98079-5714J	BKR7EN-11	
98079-5714P	ZFR7J-11	
98079-5715H	PFR7G-11	
98079-57173	BUR7EB-11	
98079-57174	BU7EB-11	
98079-57175	BR6EBL-11	
98079-57176	B6EBL-11	
98079-57177	BR7EB-11	
98079-57178	B7EB-11	
98079-57179	BP7EY-11	
98079-5717U	IFR7L11	
98079-5717U	IFR7L11	
98079-5717V	IFR7G-11K	
98079-571BH	PFR7G-11S	
98079-571BV	IFR7G-11KS	
98079-5747U	6G	
98079-57614	B7EVX	
98079-57614	B7EV	
98079-57810	B7ES	
98079-57811	BP7ES	
98079-57816	BR7ES	
98079-57840	B7ES	
98079-57841	BP7ES	
98079-57846	BPR7ES	19
98079-57847	BR7ES	
98079-57848	B7EB	
98079-57849	BR7EB	
98079-5785G	ZFR7F	
98079-57874	B7EV	
98079-57876	BR7ES	
98079-57877	BR7ES	
98079-5787G	ZFR7F	
98079-5787T	PFR7N-D	

<b>HONDA</b>	<b>→ NGK Typ</b>	<b>V-LINE</b>
98079-57941	BP7EY	
98079-57946	BPR7EY	
98079-5814E	BKR8E-11	
98079-5817U	FR8BI-11	
98079-58644	B8EVX	
98079-58644	B8EV	
98079-58646	BR8EVX	
98079-58648	B8EG	
98079-58649	BR8EG	
98079-58678	B8EG	
98079-58679	BR8EG	
98079-58810	B8ES	
98079-58812	B9ECS	
98079-58816	BR8ES	
98079-58819	BR8ECS	
98079-58840	B8ES	
98079-58842	B8ECS	
98079-58845	BR8ECM	
98079-58846	BR8ES	
98079-58847	BPR8ES	
98079-58870	B8ES	
98079-58872	B8ECS	
98079-58875	BR8ECM	
98079-58876	BR8ES	
98079-5917U	FR9BI-11	
98079-59644	B9EVX	
98079-59646	BR9EVX	
98079-59648	B9EG	
98079-59649	BR9EG	
98079-59678	B9EG	
98079-59679	BR9EG	
98079-59810	B9ES	
98079-59811	B9ES	
98079-59816	BR9ES	
98079-59819	BR9ECS	
98079-59840	B9ES	
98079-59842	B9ECS	
98079-59845	BR9ECM	
98079-59847	BR9ES	
98079-59870	B9ES	
98079-59872	B9ECS	
98079-59875	BR9ECM	
98079-59876	BR9ES	
98079-60616	BR10EVX	
98079-60646	BR10EV	
98079-60646	BR10EVX	
98079-60648	B10EG	
98079-60649	BR10EG	
98079-60676	BR10EVX	
98079-60678	B10EG	
98079-60679	BR10EG	
98079-60817	BR10ES	



<b>HONDA</b>	<b>→ NGK Typ</b>	<b>V-LINE</b>
98079-60819	BR10ECS	
98079-60842	B10ECS	
98079-60845	BR10ECM	
98079-60872	B10ECS	
98079-60875	BR10ECM	
9807B-5517W	IZFR5K11	
9807B-5615W	IZFR6K11	
9807B-5617P	ZFR6K-11	
9807B-5617W	IZFR6K11	
9807B-561BP	ZFR6K-11S	
9807B-56A7W	IZFR6K13	
98179-56841	BP6ES	4
H9851-5517J	ZFR5FI-11G	
H9851-5517K	FR5CI-11G	
H9851-5517Q	FR5DI-11G	
H9851-5617J	ZFR6FI-11G	
H9851-5617K	FR6CI-11G	
H9851-5617Q	FR6DI-11G	
H9851-5717K	FR7CI-11G	
H9853-5617L	ZFR6KI-11G	
H9858-5617K	FR6CI-11G	
<b>HYUNDAI</b>	<b>→ NGK Typ</b>	<b>V-LINE</b>
18814-08061	BKR6ES	28
18814-11051	BKR5ES-11	
27400-85011	IFR7F-4D	
<b>IRIBUS</b>	<b>→ NGK Typ</b>	<b>V-LINE</b>
504096815	IGR7E-3D	
<b>ISKRA</b>	<b>→ NGK Typ</b>	<b>V-LINE</b>
F100RS	BR8HS	
F100S	B8HS	
F20	B4H	
F50	B5HS	
F55PS	BP5HS	
F65PRS	BPR6HS	3
F65PS	BP6HS	18
F70	B5HS	
F75RS	BR6HS	
F75S	B6HS	
F805RS	BR7HS	
F80S	B7HS	
F85PS	BP7HS	
F95PS	BP7HS	
FE100RS	BR9ES	
FE100S	B9ES	
FE145P	BP9ES	
FE155P	BP8EVX	
FE45P	BP5ES	8
FE50	B5ES	
FE55LRS	ZGR5A	15

<b>ISKRA</b>	<b>→ NGK Typ</b>	<b>V-LINE</b>
FE55LTXS	BUR5ET	22
FE55LXS	ZGR5A	15
FE55PRS	BPR5ES	6
FE55PS	BP5ES	8
FE55PTS	BP5ET	
FE65LTXS	BUR6ET	1
FE65PP2	BP6EVX	
FE65PRP2	BPR6ES	2
FE65PRS	BPR6ES	2
FE65PS	BP6ES	4
FE65PTRS	BPR6ET	
FE65PTS	BP6ET	
FE75RS	BR7ES	
FE75S	B7ES	
FE80RS	BR8ES	
FE80S	B8ES	
FE85PRS	BPR7ES	19
FE85PS	BP7ES	
FE85PTRS	BP7ET	
FE85PTS	BP7ET	
FET55PRS	BPR5EFS	
FET55PS	BP5EFS	
FET65PRS	BPR6EFS	7
FET65PS	BP6EFS	5
FET75PRS	BPR7EFS	
FET75PS	BP7EFS	
FS50KR	BR2LM	
FS55P	BP6S	
FS70	B6S	
FS70C	BPM6A	
FS75	B7S	
FS75C	BPM7A	
FT65PS	BP6FS	
FT95PS	BP8FS	
FUT55PRP2-13	PTR5A-13	25
M60	A6	
M75	A7	
M80	A8	
MT65PRS	APR6FS	
MT65PS	AP6FS	
SFE55LRS	ZFR5F	
SFE55LXS	ZFR5F	
SFE55PRS	BKR5ES	
SFE55PRS	BCPR5ES	32
SFE55PS	BCP5ES	16
SFE55PTRS	BCPR5ET	
SFE55PTS	BCP5ET	
SFE65LDRS	BKR5EK	23
SFE65LRS	ZFR6A-11	
SFE65LTXS	BKUR6ET	27
SFE65LXS	ZFR6A-11	
SFE65PDRS	BKR6EKC	26



<b>ISKRA</b>	<b>→ NGK Typ</b>	<b>V-LINE</b>
SFE65PRS	BKR6E	28
SFE65PRS	BKR6ES	28
SFE65PS	BCP6ES	17
SFE65PTRS	BCPR6ET	
SFE65PTS	BCP6ET	
SFE85LDRS	BKR6EK	20
SFE85LTRS	BKUR7ET	
SFE85PR5	BKR7ES	
SFE85PRS	BCPR7ES	
SFE85PS	BCP7ES	
SFE85PTRS	BCPR7ET	
SFE85PTS	BCP7ET	
T90	C7HSA	
TWE85PRS	DCPR8E	
TWE85PS	DCP7E	
<b>ISOLATOR</b>	<b>→ NGK Typ</b>	<b>V-LINE</b>
6B	BP6HS	18
7A	B6HS	
7B	BP6HS	18
7D	BP6ES	4
A5D	BP7EFS	
A7D	BP6EFS	5
FM14-145/2	BP5ES	8
FM14-175/2	BP6ES	4
FM14-200/2	BP6ES	4
FM14-225/2	BP7ES	
M14-145	B5HS	
M14-175	B6HS	
M14-175/2	B6ES	
M14-225	B7HS	
M14-240	B8HS	
M14-260	B9HS	
M14-95	B4H	
M18-225	A7	
M18-240	A7	
PM14-225	BP7HS	
U7D	BCP6ES	17
U8D	BCP5ES	16
ZM14-260	B8HS	
<b>ISUZU</b>	<b>→ NGK Typ</b>	<b>V-LINE</b>
5-81380001-0	BPR5ES	6
5-81380003-0	BP5EVX	
5-81380004-0	BP6EVX	
5-81380012-0	BP5EY	
5-81380013-0	BP6EY	
5-86003122-0	ZFR5F-11	
5-86003124-0	ZFR6F-11	
5-86007635-0	BKR5E-11	33
5-86007636-0	ZFR5J -11	
5-86007639-0	ZFR6J -11	

<b>ISUZU</b>	<b>→ NGK Typ</b>	<b>V-LINE</b>
5-86007642-0	ZFR7J -11	
5-86013957-0	PZFR5F-13	
5-86103379-0	BPR4ES-11	
5-86103380-0	BPR5ES-11	
5-86103381-0	BPR6ES-11	
5-86103382-0	BPR7ES-11	
5-86103385-0	PFR5B-11	
5-86103386-0	PFR6B-11	
5-86103387-0	PFR7B-11	
5-86103388-0	PGR4A-11	
5-86103389-0	PGR5A-11	
5-86103390-0	PGR6A-11	
5-86103391-0	PGR7A-11	
5-86121748-0	BKR4ES-11	
5-86121749-0	BKR5ES-11	
5-86121750-0	BKR6ES-11	
5-86123951-0	BKR5E-11	33
5-86123952-0	BKR6E-11	
5-86123953-0	BKR7E-11	
8-94120560-0	BPR5ES-11	
8-94217232-0	BPR6ES-11	13
8-94219943-0	BPR6ES	2
8-94235966-0	BP5ES-11	
8-94241059-0	BP6ES-11	
8-94328372-0	BKR6E-11	
8-94328373-0	BKR7E-11	
8-97012928-0	BKR6E	28
8-97315500-0	IZFR7E-D	
8-97350555-0	IZFR7E-D	
9-82513103-0	BP6ES	4
9-82513105-0	B6ES	
9-82513106-0	BP5ES	8
9-82513107-0	B5ES	
9-82513113-0	B7ES	
<b>ITALJET</b>	<b>→ NGK Typ</b>	<b>V-LINE</b>
94004	BR7HS	
94015	DR8EA	
94025	BR8HS	
94029	BR9ES	
94032	CR7E	
<b>JAPCAR</b>	<b>→ NGK Typ</b>	<b>V-LINE</b>
123762	BP5ES	8
123770	BP6ES	4
123778	BPR5ES	6
123789	BPR6ES	2
123801	BPR7ES	19
123825	BPR5ES-11	
123834	BPR6ES-11	13
123887	BPR5ES	6
123899	BPR6ES	2



<b>JAPCAR</b>	<b>→ NGK Typ</b>	<b>V-LINE</b>
123908	BPR7ES	19
123932	BPR5ES-11	
123940	BPR6ES-11	13
123993	BPR7ES-11	
123996	BR7ES	
124040	BPR7ES-11	
124144	BPR6ES-11	13
166573	BPR6ES	2
167605	PFR6J-11	
170006	BPR6ES-11	13
172988	BPR5ES	6
172994	PGR6A-11	
172996	PGR6B	
172998	PGR6A-11	
173939	BKR6E-11	14
177391	BKR6E-11	14
207417	PFR6J-11	
239214	PFR5J-11	
277200	BKR5E-11	33
277201	BKR5E-11	33
279427	PFR5J-11	
<b>JOHNSON</b>	<b>→ NGK Typ</b>	<b>V-LINE</b>
204470091	BR7ES	
278000237	BR7ES	
278000608	BR7ES	
278000609	BR8ES	
MCBR10EG	BR10EG	
MCBR8EG	BR8EG	
MCBR8HS	BR8HS	
MCBR9EG	BR9EG	
MCBR9ES	BR9ES	
<b>K &amp; N</b>	<b>→ NGK Typ</b>	<b>V-LINE</b>
XP422	PFR6G-11	
<b>KAWASAKI</b>	<b>→ NGK Typ</b>	<b>V-LINE</b>
92070-0020	CPR8EB-9	
92070-2077	BPR6ES	2
92070-3707	PMR9B	
E92070001	B7HS	
E92070014	B6ES	
E92070015	B7ES	
	4mm connector / Anschluß	
E92070036	B9HS	
E92070037	B8ES	
E92070037	B8ES	
E92070054	B9ES	
E92070054	B9ES	
E920701002	B7ES	
	SAE connector / Anschluß	
E920701019	DR8ES	

<b>KAWASAKI</b>	<b>→ NGK Typ</b>	<b>V-LINE</b>
E920701019	DR8ES	
E920701024	BP6ES	4
E920701025	BPR6ES	2
E920701025	BPR6ES	2
E920701026	BP7ES	
E920701027	BPR7ES	19
E920701034	D9EA	
E920701034	D9EA	
E920701044	BPR8ES	
E920701065	DPR8EA-9	
E920701065	DPR8EA-9	
E920701066	DP8EA-9	
E920701068	DPR9EA-9	
E920701068	DPR9EA-9	
E920701109	BR9ES	
E920701109	BR9ES	
E920701113	DR7ES	
E920701114	C6HSA	
E920701116	DR8ESL	
E920701116	DR8ESL	
E920701125	DPR7EA-9	
E920701125	DPR7EA-9	
E920701138	DPR6EA-9	
E920701143	CR9E	
E920701143	CR9E	
E920701145	CR9EK	
E920701145	CR9EK	
E920701154	CR7HSA	
E920701155	CR8HSA	
E920701155	CR8HSA	
E920701158	CR8EK	
E920701158	CR8EK	
E920701169	CR8E	
E920701169	CR8E	
E920701173	BR10ES	
E920701189	DR9EA	
E920701189	DR9EA	
E920701199	DR8EA	
E920701199	DR8EA	
E920701209	CR7E	
E920701209	CR7E	
E920701250	DPR5EA-9	
E920701250	DPR5EA-9	
E920701254	CR9EKPA	
E920701255	CR8EKPA	
E920702078	BR8ES	
E920702078	BR8ES	
<b>KIA</b>	<b>→ NGK Typ</b>	<b>V-LINE</b>
18814-11051	BKR5ES-11	
OK558 18110	PFR6N-11	



<b>KIORITZ</b>	<b>→ NGK Typ</b>	<b>V-LINE</b>
159010-00130	B6S	
159010-00131	B7S	
159010-00830	BM7A	
159010-01110	BR6S	
159010-01820	B-4	
159010-03520	B5HS	
159010-03920	BP-2H	
159010-04120	B6HS	
159010-04530	D5HS	
159010-10050	B4H	
159026-00830	BM7A	
159026-12330	BPM6A	
A425213-0010	BM6A	
A425300-0210	BPM6Y	
A425303-0010	BPM7Y	
A425306-0310	BMR6A	
A425306-0311	BMR6A	
A425306-0400	BPMR6A	
A425306-0401	BPMR6A	
A425307-0010	BPM6A	
A425308-0010	BM6A	
A425309-0010	BPM7A	
A425309-0210	BPMR7A	
A425309-0211	BPMR7A	
A425309-0301	BPMR7A	
A425312-0010	BPM7A	
A425314-0010	BPM8Y	
<b>KLG</b>	<b>→ NGK Typ</b>	<b>V-LINE</b>
F100	B8HS	
F20	B4H	
F220	B9HS	
F50	B5HS	
F55P	BP5HS	
F65P	BP6HS	18
F70	B5HS	
F75	B6HS	
F80	B7HS	
F85P	BP6HS	18
F95P	BP7HS	
FA50	B4L	
FA70	B6L	
FE100	B8ES	
FE125P	BP6ES	4
FE135P	BP7ES	
FE145P	BP8ES	
FE155P	BP8ES	
FE220	B9ES	
FE30	B4ES	
FE45P	BP5ES	8
FE50	B5ES	
FE55P	BP5ES	8

<b>KLG</b>	<b>→ NGK Typ</b>	<b>V-LINE</b>
FE65P	BP6ES	4
FE70	B5ES	
FE75	B6ES	
FE80	B7ES	
FE85P	BP6ES	4
FE95P	BP7ES	
FS100	B8S	
FS100H	B9S	
FS20	B2	
FS30	B4	
FS35P	BP4	
FS45P	BP5S	
FS50	B6S	
FS55P	BP6S	
FS70	B6S	
FS75	B7S	
FS75H	B7S	
FT55P	BP5FS	
FT65P	BP5FS	
FT85P	BP6FS	
FT95P	BP7FS	
GT4S	BP5S	
GT4T	AP5FS	
GT5	BP5HS	
GT5L	BP5ES	8
GT5T	AP5FS	
GT6	BP6HS	18
GT6L	BP6ES	4
GT6T	AP6FS	
GT7	BP7HS	
GT7L	BP7ES	
GT8L	BP8ES	
M30	AB2	
M50	A6	
M60	A6	
M75	A7	
M80	A8	
MT45P	AP5FS	
MT55P	AP5FS	
MT65P	AP5FS	
MT75P	AP6FS	
MT85P	AP6FS	
T90	C7HSA	
TMT50	A5FS	
TW270	D6HA	
TW275	D6HA	
TW280	D8HA	
TWE270	D8EA	
TWE275	D9EA	
<b>KTM</b>	<b>→ NGK Typ</b>	<b>V-LINE</b>
61139093000	KR8DI	



<b>KTM</b>	<b>→ NGK Typ</b>	<b>V-LINE</b>
78039093000	LKAR8A-9	
<b>KUBOTA</b>		
	<b>→ NGK Typ</b>	<b>V-LINE</b>
07909-2225-0	BM6A	
07909-2226-0	BM7A	
10101-6771-6	G27	
10202-6771-6	AB6	
10261-6771-6	G2Z	
12168-6771-1	BP4HS-10	
12268-6771-1	BP2E	
12273-6771-1	BP5HM	
12366-6771-6	BR4HS	
12392-6771-1	BP5ES	8
12581-6771-1	BCP6ES-11	
12647-6771-1	BPR6HS	3
12681-6774-1	BR5ES	
12691-6771-1	BCP4ES-11	
12863-6771-1	BP5ES	8
12866-6771-1	BP5ES	8
12992-6771-1	BPR5ES	6
13078-6771-6	BP6ES	4
13157-6771-2	BM4A	
13173-6771-6	B4H-10	
13193-6771-1	B4H-10	
13211-6771-6	B4	
13281-6771-6	B4H	
13301-6771-6	AB2	
13373-6774-1	BMR4A	
13374-6774-1	BPR4HS	
13375-6774-0	BP5ES	8
13375-6774-1	BPR4HS-10	
13401-6771-6	B6S	
13412-6771-6	B7S	
13451-6771-6	B6HS	
13581-6771-6	B7HS	
13582-6771-1	B6HS	
13641-6771-1	B4H	
13711-6771-6	B4-10	
13742-6771-6	BP4HS-10	
13901-6771-6	BP6HS	18
13979-6771-1	BP4HS	
<b>LODGE</b>		
	<b>→ NGK Typ</b>	<b>V-LINE</b>
15HLNY	BP6ES	4
25HLD	BCP6ET	
25HLNY	BP7ES	
25XL	BP6ES	4
2BTNY	AP5FS	
2H	B7HS	
2H12	D8HA	
2HA	B6S	
2HL	B7ES	

<b>LODGE</b>	<b>→ NGK Typ</b>	<b>V-LINE</b>
2HL10	C7HSA	
2HLD	BCP6ES	17
2HL-E	B7ES	
2HLN	B7ES	
2HLNY	BP7ES	
2HN	B7HS	
2HNY	BP7HS	
2H-TNY	AP7FS	
2HTY	BP6FS	
2HV	A8	
2XL	BP6ES	4
3B-TY	BP4FS	
3HAN	B8S	
3HAN/M	B9S	
3HLN	B8ES	
3HLNY	BP7ES	
3HN	B8HS	
3HNY	BP8ES	
4HLNY	BP8ES	
5HLNY	BP8ES	
BAN	B4	
BANY	BP5S	
BBANY	BP4	
BBNY	BP4H	
BLN	B4ES	
BLNY	BP5ES	8
BLTY	BPR5EFS	
BN	B4H	
BTNY	AP5FS	
B-TY	BP5FS	
BV	AB2	
C3	A5FS	
CAN	B6S	
CANB	BPM6A	
CANC	BM6A	
CANY	BP6S	
CL14	B5ES	
CLN	B6ES	
CLN14P	B5ES	
CLNH	B5ES	
CLNY	BP5ES	8
CN	B5HS	
CNY	BP5HS	
CSN	B4L	
CTN18	A5FS	
CTNY	AP5FS	
CTY	BP5FS	
CV	A6	
H	B6HS	
H12	D6HA	
H18	A7	
HA	B7S	





<b>LODGE</b>	<b>→ NGK Typ</b>	<b>V-LINE</b>
HAN	B7S	
HAN/M	B7S	
HB12	D6HA	
HBAN	B6S	
HBL12	D8EA	
HBLN	B5ES	
HBN	B5HS	
HBSN	B6L	
HBTNY	AP6FS	
HBTY	BP5FS	
HBV	A6	
HL	B6ES	
HL12	D9EA	
HL14	B6ES	
HL-E	B6ES	
HLN	B6ES	
HLNP	B6ES	
HLNY	BP6ES	4
HN	B6HS	
HNY	BP6HS	18
HT14	BP5FS	
HT18	AP6FS	
HTNY	AP6FS	
H-TY	BP6FS	
HV	A7	
<b>MARCHAL/VALEO</b>	<b>→ NGK Typ</b>	<b>V-LINE</b>
17C	A7	
19C	A7	
19E	A7	
19L	A7	
2/13	A8	
2/32	B8HS	
2/32H	B8ES	
2/33	B8HS	
2/33H	B7ES	
20C	A6	
20E	A6	
20L	A6	
21C	A6	
21E	A6	
21L	A6	
22L	AB2	
22LM	AB2	
23F	A6FS	
34/5HS	BP6ES	4
34C	B7S	
34CM	B7S	
34HS	B7ES	
34HSM	B7ES	
34S	B7HS	
35	B6HS	

<b>MARCHAL/VALEO</b>	<b>→ NGK Typ</b>	<b>V-LINE</b>
35/1	BP6HS	18
35/1B	BP6HS	18
35/1D	BP6HS	18
35/36D	B6HS	
35/36P	B6HS	
35/36R	B6HS	
35B	B6HS	
35C	B6S	
35CM	B6S	
35HA	BP6ES	4
35HS	B6ES	
35M	B6HS	
35P	B6HS	
36	B5HS	
36B	B5HS	
36C	B4	
36CM	B4	
36D	B5HS	
36HS	B5ES	
36M	B5HS	
36P	B5HS	
37S	B5HS	
4N	B7HS	
5H	B7ES	
5N	BP6HS	18
5N CYCLO	BP6HS	18
64H	BP7ES	
67HP	B8EVX	
6H	BP7ES	
6N	BP5HS	
70H	BP6ES	4
76H	BP5ES	8
7H	BP6ES	4
84H	BP5ES	8
88N	B5HS	
8H	BP6ES	4
9H	BP5ES	8
C64H	BP6EFS	5
C68H	BP6EFS	5
C7H	BP6EFS	5
F70H	BCP7ES	
F74H	BCP6ES	17
F80H	BCP7ES	
GT34	BP7HS	
GT34/2H	BP6ES	4
GT34/5	BP6HS	18
GT34/5D	BP6HS	18
GT34/5H	BP6ES	4
GT34/5HA	BP6ES	4
GT34/5HD	BP6ES	4
GT34D	BP7HS	
GT34H	BP7ES	



<b>MARCHAL/VALEO</b>	<b>→ NGK Typ</b>	<b>V-LINE</b>
GT34HD	BP6ES	4
GT35	BP5HS	
GT35D	BP5HS	
GT35H	BP5ES	8
GT35HD	BP5ES	8
H32RG	B9EG	
H33RG	B8EG	
H34F	B8ES	
HA32/2	B8ES	
HA32RS	B9EG	
HF34	B7ES	
HF34F	B8ES	
RR31HS	B10EG	
RR32HS	B9EGV	
RR33HSS	B8EGV	
SCGT34/5H	BP6EFS	5
SCGT35H	BP6EFS	5
V36A	B5HS	
V6N SOLEX	B5HS	

<b>MARELLI</b>	<b>→ NGK Typ</b>	<b>V-LINE</b>
7LCR	BKR6E	28
7LPR	BKR6E	28
8LCR	BCPR7ES	
8LDCR	PTR5A-13	25
8LPR	BCPR7ES	
AW56C	BM7A	
AW5C	BM6A	
CM1N	AB2	
CM2N	AB2	
CM3N	A6	
CM4N	A6	
CM5N	A6	
CM6N	A7	
CU7N	C7HSA	
CW101L	B85EGV	
CW10L	B8EG	
CW112L	B9EG	
CW11L	B9EG	
CW12L	B9EG	
CW12NV	BUH	
CW13L	B10EG	
CW14L	B10EG	
CW225A	B6HS	
CW250A	B7HS	
CW25N	B4H	
CW260N	B7HS	
CW2C	B2	
CW2CJ	B2	
CW2L	B4ES	
CW2N	B4H	
CW3C	B4	

<b>MARELLI</b>	<b>→ NGK Typ</b>	<b>V-LINE</b>
CW3CJ	B4	
CW3CP	BP4	
CW3L	B4ES	
CW3N	B4H	
CW4A	B5ES	
CW4C	B4	
CW4CJ	B4	
CW4CP	BP4	
CW4L	B4ES	
CW4LP	BP4ES	
CW4N	B4H	
CW4NJ	B4H	
CW55N	B5HS	
CW5C	B4	
CW5CP	BP5S	
CW5L	B5ES	
CW5LJ	B5ES	
CW5LP	BP5ES	8
CW5LS	B5ES	
CW5LSZ	B5ES	
CW5N	B5HS	
CW5NJ	B5HS	
CW5NP	BP5HS	
CW5NR	BR5HS	
CW5NS	B5HS	
CW5NSZ	B5HS	
CW67L	B6ES	
CW67LP	BP6ES	4
CW67N	BP6HS	18
CW67NJ	B6HS	
CW67NR	BR6HS	
CW67P	BP5ES	8
CW6C	B6S	
CW6CE	BM6A	
CW6CJ	B6S	
CW6L	B5ES	
CW6LJ	B5ES	
CW6LP	BP5ES	8
CW6LR	BR5ES	
CW6LS	B5ES	
CW6LSZ	B5ES	
CW6N	B6HS	
CW6NE	BM6A	
CW6NJ	B6HS	
CW6NP	BP6HS	18
CW6NPR	BPR6HS	3
CW6NR	BR6HS	
CW75LP	BP6ES	4
CW78L	B6ES	
CW78LP	BP6ES	4
CW78LPR	BPR6ES	2
CW78LPS	BP6ES	4



<b>MARELLI</b>	<b>→ NGK Typ</b>	<b>V-LINE</b>
CW7C	B6S	
CW7L	B6ES	
CW7LCR	BKR6E	28
CW7LJ	B6ES	
CW7LP	BP6ES	4
CW7LPH	BP6ES	4
CW7LPR	BPR6ES	2
CW7LR	BR6ES	
CW7N	B6HS	
CW7NJ	B6HS	
CW7NP	BP6HS	18
CW7NPR	BPR6HS	3
CW7NR	BR6HS	
CW89LP	BP7ES	
CW8CJ	B7S	
CW8L	B7ES	
CW8LCR	BCPR7ES	
CW8LJ	B7ES	
CW8LP	BP7ES	
CW8LPR	BPR7ES	19
CW8LPS	BP7ES	
CW8N	B7HS	
CW8NP	BP7HS	
CW8NR	BR7HS	
CW9L	B8ES	
CW9LJ	B8ES	
CW9LP	BP8ES	
CW9N	B8HS	
CWC12NJ	B8HS	
CWC67NJ	B6HS	
CWC6NJ	B6HS	
CWC7NJ	B6HS	
CWC9NJ	B7HS	
CWF11L	B8EVX	
CWP10L	B9EVX	
CWP10N	B9HVX	
CWP11L	B10EGV	
CWP5N	B6HVX	
CWP6N	B6HVX	
CWP7L	B6EVX	
CWP7N	B6HVX	
CWP8L	B7EVX	
CWP8N	B7HVX	
CWP9L	B8EVX	
CWP9N	B8HVX	
CX6N	D6HA	
CX8L	D8EA	
CX8N	D8HA	
DW4CJR	BR6S	
F6NC	BP5HS	
F6NCR	BPR5HS	
F7LC	BP6ES	4

<b>MARELLI</b>	<b>→ NGK Typ</b>	<b>V-LINE</b>
F7LCR	BPR6ES	2
F7NC	BP6HS	18
F7NCR	BPR6HS	3
F8LC	BP7ES	
F8LCR	BPR7ES	19
FC6N	B5HS	
FC7N	B6HS	
FC9L	BP8ES	
SW5C	BM6F	
T7LC	BP6EFS	5
T7LCR	BPR6EFS	7
T8LC	BP7EFS	
T8LCR	BPR7EFS	
TM2NP	AP5FS	
TM3N	A5FS	
TM3NP	A5FS	
TM4N	A5FS	
TM4NP	AP6FS	
TW4LP	BP5EFS	
TW5NP	BP5FS	
TW6NP	BP6FS	
TW78LP	BP6EFS	5
TW78LPR	BPR6EFS	7
TW78NPR	BPR6FS	
TW7LP	BP6EFS	5
TW7LPR	BPR6EFS	7
TW7NP	BP6FS	
<b>MAZDA</b>	<b>→ NGK Typ</b>	<b>V-LINE</b>
0000-18-1690	BPR6ES	
0000-18-3648	BR7ET	
0000-18-3649	BR8ET	
0000-18-8914	BPR5ES	
0000-18-B601	BPR5ES-11	
0000-18-BP01	BKR5E-11	33
0000-18-BP03	BKR6E-11	
0000-18-BP47	BKR5E	35
0000-18-F201	ZFR6A-11	
0000-18-F203	ZFR5A-11	
0000-18-F285	ZFR6F-11	
0000-18-F287	ZFR5F-11	
0000-18-JE41	BKR5EVX-11	
0000-18-KJ11	PZFR6F	
0000-18-KJ13	PZFR5F	
0000-18-KJ15	PZFR7F	
0000-18-N201	BR8EQ-14	
0000-18-N203	BR9EQ-14	
0000-18-N328	BUR8EQ	
0000-18-N329	BUR6EQ	
0000-18-N342	BUR9EQ	
0000-18-N343	BUR7EQ	
0000-18-N3A1	BUR9EQP	



<b>MAZDA</b>	<b>→ NGK Typ</b>	<b>V-LINE</b>
0000-18-N3A2	BUR7EQP	
0000-18-N3A3	BUR8EQP	
0000-18-N3A4	BUR6EQP	
0000-18-N3Y1	RE9B-T	
0000-18-N3Y8	RE7C-L	
0000-18-N3Y9	RE6C-L	
0190 18 110	B6HS	
0190-18-110	B6HS	
0243 18 110	C6HA	
0243 18 110	C6M	
0243-18-110	C6HA	
0259 18 110	BP6ES	4
0259-18-110	BP6ES	
0370 18 110	BP6EVX	
0370-18-110	BP6EV	
0371 18 110	BP5EVX	
0371-18-110	BP5EV	
0376 18 110	BP7EVX	
0376-18-110	BP7EV	
0419 18 110	B7ES	
0419-18-110	B7ES	
0420 18 110	B8ES	
0420-18-110	B8ES	
0512 18 110	B6ES	
0512-18-110	B6ES	
0660 18 110	BP5ES	8
0660-18-110	BP5ES	
0745 18 110	BP7ES	
0745-18-110	BP7ES	
0801 18 600	BR6EM	
0801-18-600	BR6EM	
0802 18 600	BR7EM	
0802-18-600	BR7EM	
0803 18 600	BR8EM	
0803-18-600	BR8EM	
0822 78 455	B10EPD	
0822 78 456	B105EPD	
0822 78 457	B11EPD	
0865 18 600	B6EM	
0865-18-600	B6EM	
0866 18 600	B7EM	
0866-18-600	B7EM	
0867 18 600	B8EM	
0867-18-600	B8EM	
0868 18 600	B9EM	
0868-18-600	B9EM	
1001 77 550	BP4EY	
1001-77-550	BP4EY	
1002 77 550	BP5EY	
1002-77-550	BP5EY	
1003 77 550	BP6EY	
1003-77-550	BP6EY	

<b>MAZDA</b>	<b>→ NGK Typ</b>	<b>V-LINE</b>
1410 18 110	BP5ES-13	
1410-18-110	BP5ES-13	
1482 18 600A	BR8EQ	
1482-18-600A	BR8EQ	
1690 18 110	BPR6ES	2
1690-18-110	BPR6ES	
1757 18 600	B7EMV	
1757-18-600	B7EMV	
1A01-18-110	PGR5A	
1A02-18-110	KR7AI	
1A03-18-110	IKR7A	
1A04-18-110	DCPR6E	
1A06-18-110	DCPR8E	
1A08-18-110	ZGR5A	
1A10-18-110	GR5AI-10	
1A50-18-110	BKR6E	
1A53-18-110	BKR6E-11	
1A61-18-110	DCPR7EVX	
1N00-18-110	BKR4E-11	
1N04-18-110	BKR5EY-11	
1N05-18-110	BKR4EY-11	
1N06-18-110	BKR6EY-11	
1N07-18-110	PFR4G-11	
1N08-18-110	PFR5G-11	
1N09-18-110	PFR6G-11	
1N11-18-110	FR7AI-D	
1N13-18-110	LFR4A-11	
1N15-18-110	LFR5A-11	
1N17-18-110	LFR6A-11	
1UN0-18-110	BPR5EIX	
1UN1-18-110	BPR6EIX	
1UN2-18-110	BPR7EIX	
1UN3-18-110	BPR5EIX-11	
1UN4-18-110	BPR6EIX-11	
1UN6-18-110	BKR5EIX	
1UN7-18-110	BKR6EIX	
1UN9-18-110	BKR5EIX-11	
1UNA-18-110	BKR6EIX-11	
1UNC-18-110	BCPR5EIX-11	
1UND-18-110	BCPR6EIX-11	
1UNF-18-110	DCPR7EIX	
1UNG-18-110	ZFR5FIX-11	
1UNH-18-110	ZFR6FIX-11	
1UX0-18-110	BPR5EIX-P	
1UX1-18-110	BPR6EIX-P	
1UX3-18-110	BPR5EIX-11P	
1UX4-18-110	BPR6EIX-11P	
1UX6-18-110	BKR5EIX-P	
1UX7-18-110	BKR6EIX-P	
1UX9-18-110	BKR5EIX-11P	
1UXA-18-110	BKR6EIX-11P	
1UXC-18-110	BCPR5EIX-11P	



<b>MAZDA</b>	<b>→ NGK Typ</b>	<b>V-LINE</b>
1UXD-18-110	BCPR6EIX-11P	
1UXF-18-110	DCPR7EIX-P	
1UXG-18-110	ZFR5FIX-11P	
1UXH-18-110	ZFR6FIX-11P	
1UXJ-18-110	BPR5EFIX-13P	
2182 18 600	BR8EM	
2182-18-600	BR7EM	
2183-18-600	BR8EM	
2328 18 600	B7EM	
2328-18-600	B7EM	
2359 18 600	B8EM	
2359-18-600	B8EM	
2996-18-600	B9EPD	
3648 18 600	BR7ET	
3648-18-600	BR7ET	
3649 18 600	BR8ET	
3649-18-600	BR8ET	
3710 18 110	BP6ES-13	
3710-18-110	BP6ES-13	
3743 18 600	B7ET	
3743-18-600	B7ET	
3744 18 600	B8ET	
3744-18-600	B8ET	
4075 18 110	BP4ES	
4075-18-110	BP4ES	
4885 18 110	BPR2E	
4885-18-110	BPR-2E	
4894 18 110	BP2E	
4894-18-110	BP-2E	
8182 18 600	BR7EQ	
8182-18-600	BR7EQ	
8248 18 600	BRE813L	
8344 18 600	BR9ET	
8344-18-600	BR9ET	
8526-18-600	B6EMV	
8527-18-600	B7EMV	
8914 18 110	BPR5ES	6
8914-18-110	BPR5ES	
A501 18 110	BP6E	
A501-18-110	BP6E	
AY02 18 110	DCP7E	
AY02-18-110	DCP7E	
AZ08 18 110	BPR5E	
AZ08-18-110	BPR5E	
AZ28-18-110	DCP7EVX	
B601 18 110	BPR5ES-11	
B601-18-110	BPR5ES-11	
B64N 18 110	BRE527Y-11	
B64N-18-110	BRE527Y-11	
B660 18 110	BCP6E-11	
B660-18-110	BCP6E-11	
B695 18 110	BCPR6E	12

<b>MAZDA</b>	<b>→ NGK Typ</b>	<b>V-LINE</b>
B695-18-110	BCPR6E	
B6B3 18 110	BCPR5E-11	
B6B3-18-110	BCPR5E-11	
BBYV-18-110	R5687-10	
BBYV-18-11Z	R5687-9	
BP01 18 110	BKR5E-11	33
BP01-18-110	BKR5E-11	33
BP03 18 110	BKR6E-11	14
BP03-18-110	BKR6E-11	
BP05 18 110	BKR7E-11	
BP05-18-110	BKR7E-11	
BP47 18 110	BKR5E	35
BP47-18-110	BKR5E	35
BP49 18 110	BKR6E	28
BP49-18-110	BKR6E	
BP51 18 110	BKR7E	
BP51-18-110	BKR7E	
E356 18 110	BE527Y-11	
F201 18 110	ZFR6A-11	
F201-18-110	ZFR6A-11	
F203 18 110	ZFR5A-11	
F203-18-110	ZFR5A-11	
F205 18 110	ZFR7A-11	
F205-18-110	ZFR7A-11	
F210 18 110	BCPR5E	
F210-18-110	BCPR5E	
F220 18 110	BCPR6E-11	11
F220-18-110	BCPR6E-11	
F285 18 110	ZFR6F-11	
F285-18-110	ZFR6F-11	
F287 18 110	ZFR5F-11	
F287-18-110	ZFR5F-11	
F289 18 110	ZFR7F-11	
F289-18-110	ZFR7F-11	
F293-18-110	ZFR5F-11	
F806-18-110	BP4ES-13	
F8B1-18-110	ZF6A-11	
F8B3-18-110	ZF5A-11	
F8B5-18-110	ZF7A-11	
F8B7-18-110	ZF4A-11	
F8L6-18-110	ZFR4F-11	
F8L8-18-110	BPR4ES-13	
FE3N-18-110	BCP7E-11	
FE6E 18 110	BCPR7E-11	
FE6E-18-110	BCPR7E-11	
FE79 18 110	BPR6ES-11	13
FE79-18-110	BPR6ES-11	
FEDK-18-110	BPR5ES-13	
FEEG-18-110	BPR6ES-13	
FEFB-18-110	BPR6ES-11	
JE03 18 110	BCPR7E	
JE03-18-110	BCPR7E	



<b>MAZDA</b>	<b>→ NGK Typ</b>	<b>V-LINE</b>
JE26-18-110	BCPR5EVX-11	
JE27-18-110	BCPR6EVX-11	
JE41 18 110	BKR5EVX-11	
JE41-18-110	BKR5EVX-11	
JE43 18 110	BKR6EVX-11	
JE43-18-110	BKR6EVX-11	
JE45 18 110	BKR7EVX-11	
JE45-18-110	BKR7EVX-11	
JF03-18-110	BCP5E-11	
KJ11 18 110	PZFR6F	
KJ11-18-110	PZFR6F	
KJ13 18 110	PZFR5F	
KJ13-18-110	PZFR5F	
KJ15-18-110	PZFR7F	
L303-18-110	ITR5F13	
L341-18-110	ITR6F13	
L3Y1-18-110	ILTR6A-13G	
L3Y2-18-110	ILTR5A-13G	
L3Y3-18-110	ILTR6A-8G	
L3Y4-18-110	ITR6F13	
L813 18 110	ITR6F13	
L814-18-110	BPR6EF-13	
N201 18 600	BR8EQ-14	
N201-18-600	BR8EQ-14	
N203-18-600	BR9EQ-14	
N212 18 600	BR7EQ-14	
N212-18-600A	BR7EQ-14	
N218-18-600	BR8EQ-14	
N246-18-600	BR9EQ-14	
N322 18 110	BR10ET	
N322-18-110	BR10ET	
N328-18-110	BUR8EQ	
N329 18 110	BUR6EQ	
N329-18-110	BUR6EQ	
N333 18 110	SD11A	
N335-18-110	SD9A	
N338 18 110	SD11A	
N338-18-110	SD11A	
N339 18 110	SD10A	
N339-18-110	SD10A	
N342 18 110	BUR9EQ	
N342-18-110	BUR9EQ	
N343 18 110	BUR7EQ	
N343-18-110	BUR7EQ	
N390 18 110	BUR5EQ	
N390-18-110	BUR5EQ	
N3A1 18 110	BUR9EQP	
N3A1-18-110	BUR9EQP	
N3A2-18-110	BUR7EQP	
N3A3 18 110	BUR8EQP	
N3A3-18-110	BUR8EQP	
N3A4-18-110	BUR6EQP	

<b>MAZDA</b>	<b>→ NGK Typ</b>	<b>V-LINE</b>
N3Y1-18-110	RE9B-T	
N3Y2-18-110	RE7A-L	
N3Y3-18-110	RE6A-L	
N3Y4-18-110	RE9B-T	
N3Y5-18-110	RE8A-L	
N3Y6-18-110	RE7A-L	
N3Y7-18-110	RE9A-T	
N3y8-18-110	RE7C-L	
N3Y8-18-110	RE7C-L	
N3Y9-18-110	RE6C-L	
N3Z1-18-110	RE8C-L	
N3Z1-18-110	RE8C-L	
N3Z2-18-110	RE7C-L	
TF50-18-110	BKR6EVX	
ZR03-18-110	R4468A-115	
ZZS3-18-110	ZGR5E	
ZZSI-18-110	DCPR7E	
<b>MCC / Smart</b>	<b>→ NGK Typ</b>	<b>V-LINE</b>
000 3085 V005	BKR6EKE	
001 2468 V001	LKR8A	
A 003 159 82 03	BKR6EZA	
A 003 159 92 03	BKR6EKE	
<b>MEGA FIRE</b>	<b>→ NGK Typ</b>	<b>V-LINE</b>
SE17JC	BM4A	
SE8JC	BM6A	
<b>MERCEDES</b>	<b>→ NGK Typ</b>	<b>V-LINE</b>
002 159 18 03	BP7ES	
002 159 22 03	BP5ES	8
002 159 24 03	BP6ES	4
002 159 27 03	BP7ES	
002 159 28 03	BP6ES	4
002 159 29 03	BP5ES	8
002 159 31 03	BP5ES	8
002 159 41 03	BP6ES	4
002 159 42 03	BP6ES	4
002 159 48 03	BP5ES	8
002 159 49 03	BP6EFS	5
002 159 56 03	BP6EFS	5
002 159 57 03	BP5EFS	
002 159 58 03	BP5EFS	
002 159 64 03	BP7EFS	
002 159 65 03	BP7EFS	
002 159 68 03	BP6EFS	5
002 159 69 03	BP6EFS	5
002 159 76 03	BP5EFS	
002 159 77 03	BCP5ES	16
003 159 04 03	BP5EFS	
003 159 05 03	BP5EFS	
003 159 06 03	BP6EFS	5



<b>MERCEDES</b>	<b>→ NGK Typ</b>	<b>V-LINE</b>
003 159 07 03	BP6EFS	5
003 159 08 03	BP7EFS	
003 159 10 03	BP5ESZ	
003 159 11 03	BP5ESZ	
003 159 12 03	BP6ESZ	
003 159 13 03	BP6ESZ	
003 159 14 03	BP7ES	
003 159 16 03	BCP6ES	17
003 159 30 03	BCP5ES	16
003 159 31 03	BCP6ES	17
003 159 33 03	BP7EFS	
003 159 34 03	BP6EFS	5
003 159 35 03	BP6EFS	5
003 159 36 03	BP5EFS	
003 159 37 03	BCP5ES	16
003 159 40 03	BP5EFS	
003 159 41 03	BP5EFS	
003 159 42 03	BCP5ES	16
003 159 45 03	BP6ESZ	
003 159 46 03	BP5ESZ	
003 159 47 03	BP5ESZ	
003 159 56 03	BP7ES	
003 159 57 03	BP6ESZ	
003 159 78 03	BKR6ES	28
003 159 94 03	PFR5R-11	
003 159 96 03	IFR5D10	
003 159 97 03	IFR6D10	
004 159 13 03	ILFR6A	
004 159 19 03	IFR5D10	
004 159 36 03	BKR6EZB	
004 159 39 03	ILZKAR7A10	
004 159 49 03	PLKR7A	
<b>MERCRUISER</b>	<b>→ NGK Typ</b>	<b>V-LINE</b>
33-104	BR7ES	
33-11458M	B6HS-10	
33-12127	BP6HS-10	
33-123	BR6ES	
33-12343	BP8HS-10	
33-12343B	BP8HS-10	
33-129	AR6FS	
33-136862	BU8H	
33-136862B	BU8H	
33-14	BP5S	
33-14103550	BUZHW	
33-14103568	BUZ8H	
33-14103570	BUZHW-2	
33-14814548	BPZ8HS-10	
33-14814568	BPZ8HS-15	
33-17719547	BPR7HS-10	
33-18	BPR4FS-11	
33-18S	BPR4FS-11	

<b>MERCRUISER</b>	<b>→ NGK Typ</b>	<b>V-LINE</b>
33-19424	BP8HS-15	
33-19796	BPR6HS-10	
33-306	B6HS	
33-312	BP6HS-10	
33-327	BPR6HS	3
33-328	BP7HS	
33-400	BR6FS	
33-400	UR5	
33-400S	BR6FS	
33-401	BP6EFS	5
33-406	BPR6FS	
33-41263B	B7HS-10	
33-41263M	B7HS-10	
33-592	BR6S	
33-59571	BR6FS	
33-59571B	BR6FS	
33-63	BP5S	
33-670	R5673-8	
33-802	R5673-7	
33-803507	DCPR6E	
33-807C	B8HS	
33-807S	B8HS	
33-809679	BR9ES	
33-809679B	BR9ES	
33-809680	BR8ES	
33-809680B	BR8ES	
33-811	B7HS	
33-811S	B7HS	
33-8134101	UR5	
33-813413	B7S	
33-8134141	BP7HS	
33-813415	B8S	
33-813421	R5673-8	
33-813423	BPR6HS	3
33-813425	AR6FS	
33-813469	B6S	
33-8134711	BR6ES	
33-814	BPR7HS-10	
33-816336	BPR6EFS	7
33-8167372	BP8HN-10	
33-8167372B	BP8HN-10	
33-8168372	BPZ8HN-10	
33-8168372B	BPZ8HN-10	
33-818	BR9ES	
33-818S	BR9ES	
33-821916	BR7HS	
33-821C	B9HS-10	
33-821S	B9HS-10	
33-823	B6S	
33-82370M1	B6HS	
33-82371B	B7HS	
33-82371M	B7HS	



<b>MERCURISER</b>	<b>→ NGK Typ</b>	<b>V-LINE</b>
33-82372M	B8HS	
33-823S	B6S	
33-824	BUHX	
33-825C	B7S	
33-825S	B7S	
33-827858	DPR6EA-9	
33-827859	CR6HS	
33-827C	BUHW	
33-827S	BUHW	
33-828C	BZ7HS-10	
33-828S	BZ7HS-10	
33-833C	BUHW-2	
33-833S	BUHW-2	
33-838	BUZHW-2	
33-841C	B6S	
33-84409B	B8HS-10	
33-84409M	B8HS-10	
33-84675M	B5HS	
33-8556721	PZFR5F-11	
33-8557171	ZFR5F-11	
33-859495	LFR5A-11	
33-874	BR7HS	
33-876	BUZ8H	
33-880	BR8ES	
33-881284	LFR6A-11	
33-883	BR7HS	
33-885C	BU8H	
33-885S	BU8H	
33-886	BUZ8H	
33-896	B5HS	
33-898	BUZHW	
33-918	ZFR6F-11	
33-924	BP8HS-15	
33-936C	BP8HS-10	
33-936S	BP8HS-10	
33-938	BPZ8HS-10	
33-939	BPZ8HS-15	
33-941	BR8HS	
33-97180	BUHW	
33-97180B	BUHW	
33-97182	BUHW-2	
33-97182B	BUHW-2	
33-97184	BP7HS-10	
33-97186	B9HS-10	
33-97186B	B9HS-10	
33-97389	BPR6FS	
33-97389	UR5	
<b>MERCURY</b>	<b>→ NGK Typ</b>	<b>V-LINE</b>
8M0006613	ILFR6G-E	
8M0007919	IZFR7M	

<b>MITSUBISHI</b>	<b>→ NGK Typ</b>	<b>V-LINE</b>
1822A002	IFR6B-K	
1822A005	ILZFR6C-K	
1822A022	ILFR7H	
1822A022	ILFR7H	
JM60042	BS-42R	
MD 313 442	PFR5G-11	
MD 313 443	PFR6G-11	
MD 314 766	BKR7EKC-N	
MD 320 543	BKR7EKC-N-11	
MD 321 150	BKR6EKC-N-11	
MD 331 057	ZFR5F-11	
MD 336 367	PZFR6B	
MD 338 991	PGR7A	
MD 342 386	PZFR5F-11	
MD 343 277	PGR6A	
MD 348 296	PZFR5B	
MD 351 467	PZFR5C	
MD 355 067	BKR6EKUC	
MD 358 200	ZFR6F-11	
MD 360 019	IZFR6B	
MD 360 383	IZFR5B	
MD 362 097	ZFR5F-11	
MD 362 902	BKR5EKUC	
MD 365 108	BPR5EKU	
MD 366 819	IZFR5C	
MD 370 906	DCPR6EKU	
MD 371 434	IGR7A	
MD 372 421	BKR5EKUD	
MD 372 422	BKR6EKUD	
MD 372 553	IFR5E11	
MD 372 588	IFR6E11	
MD 374 841	IGR7A-G	
MD 375 642	BKR5ETUA	
MD 378 582	IFR6B	
ME 220 826	IFR7F-D	
ME 352 430	IGR7B-D	
MN 119 256	ILZFR5B	
MN 119 487	IFR6S	
MN 119 489	IGR6A	
MN 119 500	IGR6A11	
MN 119 942	BKR6ETUB	
MN 122 494	IKR7B	
MN 158 596	LZFR6AI	
MN 163 235	FR5EI	
MN 163 236	FR6EI	
MS 851 022	BP5ES	8
MS 851 023	BP6ES	4
MS 851 024	BP7ES	
MS 851 027	BP5ES-11	
MS 851 028	BP6ES-11	
MS 851 029	BP7ES-11	
MS 851 102	BP5EY	





<b>MITSUBISHI</b>	<b>→ NGK Typ</b>	<b>V-LINE</b>
MS 851 104	BP6EY	
MS 851 111	B4	
MS 851 113	B6S	
MS 851 121	BP4	
MS 851 126	BPR6E	
MS 851 126	BPR6E	
MS 851 132	B5HS	
MS 851 133	B6HS	
MS 851 134	B7HS	
MS 851 162	B5ES	
MS 851 163	B6ES	
MS 851 164	B7ES	
MS 851 165	B8ES	
MS 851 174	BR7ES	
MS 851 181	BP4ES	
MS 851 182	BP5ES	8
MS 851 183	BP6ES	4
MS 851 184	BP7ES	
MS 851 187	BP5ES-11	
MS 851 188	BP6ES-11	
MS 851 189	BP7ES-11	
MS 851 192	BP6ES	4
MS 851 230	BPR4ES-11	
MS 851 232	BPR5ES	6
MS 851 233	BPR6ES	2
MS 851 234	BPR7ES	19
MS 851 235	BPR5ES	6
MS 851 236	BPR6ES	2
MS 851 237	BPR5ES-11	
MS 851 238	BPR6ES-11	13
MS 851 239	BPR7ES-11	
MS 851 242	BP5EA	
MS 851 243	BP5EAL	
MS 851 244	BP6EA	
MS 851 246	BP5EA-11	
MS 851 247	BP5EAL-11	
MS 851 248	BP6EA-11	
MS 851 253	BU6EA-11	
MS 851 254	BU7EA-11	
MS 851 263	G2Z	
MS 851 272	BUR5EA-11	
MS 851 273	BUR6EA-11	
MS 851 274	BUR7EA-11	
MS 851 283	BP6E	
MS 851 286	BP5EY	
MS 851 287	BP6EY	
MS 851 292	PGR6B	
MS 851 301	PGR5A-11	
MS 851 302	PGR6A-11	
MS 851 316	DCPR6E	
MS 851 317	DCPR7E	
MS 851 327	DCPR7EVX	

<b>MITSUBISHI</b>	<b>→ NGK Typ</b>	<b>V-LINE</b>
MS 851 332	PFR6B-11	
MS 851 335	PFR5J-11	
MS 851 336	PFR6J-11	
MS 851 346	PFR6M	
MS 851 347	PFR7M	
MS 851 351	BK5E	
MS 851 352	BK6E	
MS 851 357	BKR5E-11	33
MS 851 358	BKR6E-11	14
MS 851 359	BKR7E-11	
MS 851 361	BK5E-11	
MS 851 362	BK6E-11	
MS 851 363	BK7E-11	
MS 851 367	BKR5E	35
MS 851 368	BKR6E	28
MS 851 403	BPR6ES-11	13
MS 851 408	BPR6ES-11	13
MS 851 412	BPR5ES	6
MS 851 413	BPR6ES	2
MS 851 414	BPR7ES	19
MS 851 417	BPR5ES-11	
MS 851 418	BPR6ES-11	13
MS 851 419	BPR7ES-11	
MS 851 454	BR7ES	
MS 851 463	PGR6B	
MS 851 473	PFR6J-11	
MS 851 473	PFR6B-11	
MS 851 478	BPR6ES-11	13
MS 851 502	PFR6J-11	
MS 851 721	BK5E	
MS 851 722	BK6E	
MS 851 727	BKR5E-11	33
MS 851 728	BKR6E-11	14
MS 851 732	BK6E-11	
MS 851 737	BKR5E	35
MS 851 738	BKR6E	28
MS 851 861	PFR6J	
MS 851 872	BK7EK-N-11	
MS 851 881	BPR6EKN	
MS 851 882	BPR7EKN	
MS 851 882	BPR7EKN	
MZ 602 060	BPR5EIX-11	
MZ 602 061	BPR6EIX-11	
MZ 602 062	BPR7EIX	
MZ 602 063	BCPR5EIX-11	
MZ 602 064	BCPR6EIX-11	
MZ 602 065	BKR5EIX-11	
MZ 602 066	BKR6EIX-11	
MZ 602 067	DCPR7EIX	
MZ 602 068	ZFR5FIX-11	
MZ 602 069	ZFR6FIX-11	
MZ 602 070	BPR5EIX	



<b>MITSUBISHI</b>	<b>→ NGK Typ</b>	<b>V-LINE</b>
MZ 602 071	BPR6EIX	
MZ 602 072	BKR5EIX	
MZ 602 073	BKR6EIX	
MZ 602 074	BPR6EIX-LPG	
MZ 602 075	BKR6EIX-LPG	
MZ 602 076	BKR5EIX-11P	
MZ 602 077	BKR6EIX-11P	
MZ 602 078	BCPR5EIX-11P	
MZ 602 079	BCPR6EIX-11P	
MZ 602 080	DCPR7EIX-P	
MZ 602 081	BKR7EIX-11	
MZ 602 082	BKR5EIX-P	
MZ 602 083	BKR6EIX-P	
MZ 602 084	ZFR5FIX-11P	
MZ 602 085	ZFR6FIX-11P	
Z 2152 944	BPR6ES-11	13
Z 2152 945	BPR6ES	2
Z 2152 946	BR7ES	
Z 2152 947	BPR7ES	19
Z 2152 948	BPR7ES-11	
Z 2152 949	BCPR7ES-11	
Z 2152 950	BCPR6ES-11	11

<b>MOTORCRAFT</b>	<b>→ NGK Typ</b>	<b>V-LINE</b>
A11	B2	
A11NX	BM4A	
A11U	B2	
A11X	B2	
A1CU	B8S	
A21X	B8S	
A22	BP6S	
A22CU	BP6S	
A22NX	BPM7A	
A2NX	BM7A	
A32	BP6S	
A3CU	B6S	
A3NX	BM6A	
A3X	B6S	
A42	BP5S	
A42CU	BP5S	
A5	B6S	
A52	BP5S	
A52CU	BP5S	
A5CU	B6S	
A5X	B6S	
A7	B4	
A7LM	B4LM	
A7N	BM6A	
A7NU	BM6A	
A7NX	BM6A	
A7U	B4	
A7X	B4	

<b>MOTORCRAFT</b>	<b>→ NGK Typ</b>	<b>V-LINE</b>
A82	BP4	
A9	B4	
A901	B8S	
A9X	B4	
AE1C	B7HS	
AE1X	B7HS	
AE2	B7HS	
AE22	BP6HS	18
AE22C	BP6HS	18
AE2C	B7HS	
AE2X	B7HS	
AE3	B6HS	
AE32	BP6HS	18
AE32C	BP6HS	18
AE3C	B6HS	
AE3X	B6HS	
AE4	B5HS	
AE42	BP5HS	
AE4X	B5HS	
AE6	B5HS	
AE62	BP5HS	
AE7	B4H	
AE901	B9HS	
AE901X	B9HS-10	
AER32	BPR6HS	3
AER4	BR5HS	
AER4X	BR5HS	
AF12	BP7FS	
AF-2	B7FS	
AF22	BP6FS	
AF-3	B6FS	
AF32	BP6FS	
AF3NX	BM7F	
AF42	BP5FS	
AF52	BP4FS	
AF5NX	BM6F	
AG1	B8ES	
AG12	BP7ES	
AG12C	BP7ES	
AG12CU	BP7ES	
AG1C	B8ES	
AG1X	B8ES	
AG2	B7ES	
AG203	B11EGP	
AG22	BP6ES	4
AG22-4	BP6ES-11	
AG22C	BP6ES	4
AG22CU	BP6ES	4
AG23	B7ECS	
AG252	BP6ES	4
AG252C	BP6ES	4
AG25C	B7EM	



<b>MOTORCRAFT</b>	<b>→ NGK Typ</b>	<b>V-LINE</b>
AG2C	B7ES	
AG2CU	B7ES	
AG2X	B7ES	
AG3	B6ES	
AG32A	BP6ES	4
AG32C	BP6ES	4
AG32CU	BP6ES	4
AG34CU	BP6EA	
AG34CU11	BP6EA-11	
AG3C	B6ES	
AG3X	B6ES	
AG4	B5ES	
AG403	B10EGP	
AG403C	B10EGP	
AG42	BP5ES	8
AG42CU	BP5ES	8
AG44	ZGR5C	
AG44CU	BP5EA-L	
AG5	B5ES	
AG501	B10ES	
AG501X	B10EGV	
AG52	BP5ES	8
AG54	ZGR5C	
AG54CU	BP5EA	
AG5CU	B5ES	
AG603	B9EGP	
AG603C	B9EGP	
AG7	B5ES	
AG701	B9ES	
AG701C	B9ES	
AG701CU	B9ES	
AG701X	B9EGV	
AG82	BP4ES	
AG9	B4ES	
AG901	B9ES	
AG901C	B9ES	
AG901CU	B9ES	
AG901X	B8EGV	
AG902	BP8ES	
AG903	B8EG	
AG9U	B4ES	
AGF12	BP7EFS	
AGF12C	BP7EFS	
AGF22C	BP6EFS	5
AGF32CU	BP6EFS	5
AGFS22C1	BPR6EFS	7
AGFS22IPJ	ITR6F-13	
AGFS22YPC	ITR6F-13	
AGFS32C1	BPR6EFS	7
AGKO	BUE	
AGN42	BP5ES	8
AGP12C	BCP7ES	

<b>MOTORCRAFT</b>	<b>→ NGK Typ</b>	<b>V-LINE</b>
AGP22C	BCP6ES	17
AGP701C	R7234-10	
AGPR12C	BCPR7ES	
AGPR12P 1,0	BKR7EVX-11	
AGPR12PP 1,0	PFR7B-11	
AGPR12PP11	PFR7B-11	
AGPR12PP8	PFR7B	
AGPR22C	BCPR6ES	
AGPR22C	BKR6E	28
AGPR22C1	BCPR6ES-11	11
AGPR22CD	BKR6E	28
AGPR22CD1	BCPR6ES-11	11
AGPR22P 1,0	BKR6EVX-11	
AGPR22PP	PFR6B-11	
AGPR22PPJ	PFR6B-11	
AGPR32C	BKR6E	28
AGPR32CD1	BCPR6ES-11	11
AGPR32PD	BKR5EKUP	
AGPR602P	----	
AGPR901C	BCR8ES	
AGPR902C	BCPR9ES-11	
AGPR902P	R7234-9	
AGPS12C	BCPR7ES	
AGPS12P1	BKR7EVX-11	
AGPS22C	BCPR6ES	
AGPS22C1	BCPR6ES-11	11
AGPS22P	BKR6EVX-11	
AGPS22P1	BKR6EVX-11	
AGPS22PP1	PFR6B-11	
AGPS32C	BCPR6ES	
AGPS32C1	BCPR6ES-11	11
AGPS44F11J	PZFR5D-11	34
AGR12C	BPR7ES	19
AGR16C	BR8ET	
AGR1X	BR8ES	
AGR21	BR6ES	
AGR22	BPR6ES	2
AGR22C	BPR6ES	2
AGR22CU	BPR6ES	2
AGR2C	BR7ES	
AGR31	BR6ES	
AGR32	BPR6ES	2
AGR32C	BPR6ES	2
AGR32CU	BPR6ES	2
AGR34CU	BPR6EY	
AGR3X	BR6ES	
AGR41	BR5ES	
AGR42	BPR5ES	6
AGR42C	BPR5ES	6
AGR42CU	BPR5ES	6



<b>MOTORCRAFT</b>	<b>→ NGK Typ</b>	<b>V-LINE</b>
AGR44CU	BPR5EY	9
AGR44CU-11	BPR5EY-11	
AGR47CU11	ZGR5B-11	
AGR51	BR5ES	
AGR52	BPR5ES	6
AGR54CU	BPR5EA	
AGR701X	BR9EVX	
AGR82	BPR4ES	
AGR901X	BR8EVX	
AGRF22	BPR6EFS	7
AGRF22-6	BPR6EFS-13	
AGRF22C	BPR6EFS	7
AGRF22C1	BPR6EFS	7
AGRF22PP1	PTR5D-10	
AGRF32	BPR6EFS	7
AGRF32-6	BPR6EFS-13	
AGRF32C1	BPR6EFS	7
AGRF42	BPR5EFS	
AGRF52	BPR5EFS	
AGRP52	ZFR4F-11/ZF4A-11	
AGS22C	BPR6ES	2
AGS32C	BPR5ES	6
AGS32C-11	BPR5ES-11	
AGSF22FSCM	PTR6D-13G	
AGSF22PPJ	PTR6F-13	
AGSF24C	TR5-1	
AGSF32C	BPR5EFS	
AGSF32WM	ITR6F-13	
AGSF34C	TR5-1	
AGSP32	BCPR6ES-11	11
AGSP32C	BCPR6ES-11	11
AGSP33C	ZFR6F-11	
AGSP52	BKR5ES	
AL11	B4L	
AL5	B6L	
AL5X	B6L	
AL7	B6L	
AL7U	B6L	
AL7X	B6L	
AL9	B4L	
AL9X	B4L	
AR21X	BR6S	
AR31	BR6S	
AR32	BP6S	
AR41	BR6S	
AR42	BP5S	
AR51	BR6S	
AR52	BP5S	
AR7N	BMR6A	
AR82	BP4	
ARF2	BR6FS	
ARF22	BPR6FS	

<b>MOTORCRAFT</b>	<b>→ NGK Typ</b>	<b>V-LINE</b>
ARF22C	BPR6FS	
ARF22CU	BPR6FS	
ARF2-6	BR6FS-15	
ARF3	BR6FS	
ARF32	BPR6FS	
ARF32-6	BPR6FS	
ARF32C-6	BPR6FS	
ARF32M	BPR6FS	
ARF3-6	BR6FS-15	
ARF4	BR5FS	
ARF41CU15	BR5FS-15	
ARF42	BPR5FS	
ARF42-6	BPR5FS-15	
ARF42CU	BPR5FS	
ARF4-6	BR5FS-15	
ARF52	BPR4FS	
ARF52-6	BPR4FS-15	
ARF6	BR5FS	
ARF62	BPR4FS	
ARF62-6	BPR4FS-15	
ARF8	BR5FS	
ARF8-6	BR5FS-15	
ASF32	BPR6FS	
ASF32C	BPR6FS	
ASF32M	BPR6FS	
ASF42	BPR5FS-11	
ASF42-6C	BPR5FS-15	
ASF42C	BPR5FS-11	
ASF52	BPR4FS	
ASF52-6	BPR4FS-15	
AT1	B8S	
AT10	B2	
AT2	B7S	
AT3	B6S	
AT4	B6S	
AT42	BP5S	
AT6	B6S	
AT8	B4	
ATL3	B6L	
ATL4	B6L	
ATL8	B4L	
AV1X	B8HS	
AV22CU	BP6HS	18
AV2CU	B7HS	
AV2X	B7HS	
AV3CU	B6HS	
AV4	B5HS	
AV42	BP5HS	
AV52	BP5HS	
AV6	B4H	
AV6CU	B4H	
AV701CU10	B9HS-10	



<b>MOTORCRAFT</b>	<b>→ NGK Typ</b>	<b>V-LINE</b>
AV82	BP4H	
AV901CU	B9HS	
AV901X-4	B9HS-10	
AVKO	BUH	
AVKOD	BUHW	
AVZKO	BUHX	
AWRF32	BPR6EFS	7
AWRF32-5	BPR6EFS-13	
AWRF42	BPR5EFS	
AWSF22C	BPR6EFS	7
AWSF22F	PTR6D-13	
AWSF22F	PTR6D-13G	
AWSF22FS	PTR6D-13G	
AWSF24C	TR5-1	
AWSF32	BPR6EFS	7
AWSF32C	BPR6EFS	7
AWSF32F	TR55	
AWSF32PP	---	
AWSF34	TR5-1	
AWSF34C	TR5-1	
AWSF42	BPR5EFS	
AWSF42C	BPR5EFS	
AWSF42PP	TR55IX	
AWSF44C	TR5-1	
AWSF52C	BPR5EFS	
AWSF54	TR5-1	
AWSF54C	TR5-1	
AWSFA32C	BPR5EFS	
AYFS22C	PTR5A-13 / TR5A-13	
AYFS22FE1J	PLTR6A-10G	
AYFS22FPM1	PTR5A-13	25
AYFS22PP	PTR5A-13	25
AYFS22PP1	PTR5A-13	25
AYFS32CJ	PTR5A-13	25
AYRF22PP	PTR5A-13	25
AZ2	B7S	
AZ3	B6S	
AZ9	B4	
AZ901	B8S	
AZFS22C	PTR5A-13	25
AZFS32FE	PTR5A-13	25
B2W	A8	
B3W	A7	
B3X	A7	
B4X	A7	
B6W	A6	
B8X	A6	
BF12	AP8FS	
BF22	AP6FS	
BF22C	AP6FS	
BF22CU	AP6FS	
BF22CX	AP6FS	

<b>MOTORCRAFT</b>	<b>→ NGK Typ</b>	<b>V-LINE</b>
BF22X	AP6FS	
BF32	AP6FS	
BF32CU	AP6FS	
BF32CX	AP6FS	
BF32X	AP6FS	
BF42	AP5FS	
BF42CU	AP5FS	
BF82	AP5FS	
BF92	AP5FS	
BFS22C	APR6FS	
BFS32C	APR6FS	
BFS32C1	APR6FS	
BR8	A6	
BRF22	APR6FS	
BRF22C	APR6FS	
BRF31	AR6FS	
BRF31-4	AR6FS	
BRF32	APR6FS	
BRF3M	AR6FS	
BRF42	APR5FS	
BRF82	APR5FS	
BSF31	AR6FS	
BSF31-4	AR6FS	
BSF82	APR5FS	
BSF92	APR5FS	
BT10	A6	
BT15	AB2	
BT2	A8	
BT3	A7	
BT4	A7	
BT6	A6	
BT8	A6	
BT9	A6	
BTF3	A6FS	
BTF31	A6FS	
BTF42	AP5FS	
BTF6	A6FS	
BTRF42	APR5FS	
BZ8	A6	
HG2	D8EA	
HG22	D8EA	
HG2CU	D8EA	
HGR2C	DR8ESL	
HV2	D8HA	
HV22	D6HA	
HV3	D6HA	
PV2	C7HSA	
PV3	C6HSA	
TT4	G2Z	
TT8	G2Z	



<b>MV Agusta</b>	<b>→ NGK Typ</b>	<b>V-LINE</b>
7699116	CR9EKB	
<b>NISSAN</b>	<b>→ NGK Typ</b>	<b>V-LINE</b>
22401-2H015	PLFR5A-11D	
22401-AH415	FR5BP-11	
22401-CK81B	PLZKAR6A-11	
22401-ED875	LZKAR6AP-11	
22401-KA460	BKR6ETP	
22401-N8785	BP5ES-11	
22401-N8786	BP6ES-11	
22401-N8789	BP6ES-11	
22401-N8790	BP5ES-11	
22401-N8791	BP6ES-11	
22401-P8385-PC	BPR5ES-11	
22401-P8386-PC	BPR6ES-11	
22401-P8390	BPR5ES-11	
22401-P8391	BPR6ES-11	
22401-V1484-PC	BPR4ES	
22401-V1485-PC	BPR5ES	
22401-V1486-PC	BPR6ES	
22401-V1490	BPR5ES	
22401-V1491	BPR6ES	
22401-V5085	BCP5ES-11	
22401-V5086	BCP6ES-11	
22401-W8985	BP5ES	
22401-W8985-PC	BP5ES	
22401-W8986	BP6ES	
22401-W8986-PC	BP6ES	
22401-W8990	BP5ES	
22401-W8991	BP6ES	
B2401-89906	BCP5EV-11	
B2401-89907	BCP6EV-11	
B2401-V1415	BPR5ES	
B2401-V1416	BPR6ES	
B2401-W8914	BP4ES	
B2401-W8915	BP5ES	
B2401-W8916	BP6ES	
B2401-W8917	BP7ES	
BY480-BKR5E	BKR5EIX	
BY480-BKR6E	BKR6EIX	
BY480-BPR5E	BPR5EIX	
BY480-BPR6E	BPR6EIX	
BY480-BPR7E	BPR7EIX	
BY480-BPR8E	BPR8EIX	
BY480-BPR9E	BPR9EIX	
BY480-DCPR7	DCPR7EIX	
BY481-BCPR5	BCPR5EIX-11	
BY481-BCPR6	BCPR6EIX-11	
BY481-BKR5E	BKR5EIX-11	
BY481-BKR6E	BKR6EIX-11	
BY481-BKR7E	BKR7EIX-11	
BY481-BPR5E	BPR5EIX-11	

<b>NISSAN</b>	<b>→ NGK Typ</b>	<b>V-LINE</b>
BY481-BPR6E	BPR6EIX-11	
BY481-LFR5A	LFR5AIX-11	
BY481-LFR6A	LFR6AIX-11	
BY481-ZFR5F	ZFR5FIX-11	
BY481-ZFR6F	ZFR6FIX-11	
BY482-BKR6E	BKR6EIX-LPG	
BY482-BPR6E	BPR6EIX-LPG	
BY483-BCPR5	BCPR5EIX-11P	
BY483-BCPR6	BCPR6EIX-11P	
BY483-BKR5E	BKR5EIX-11P	
BY483-BKR6E	BKR6EIX-11P	
BY483-BPR5E	BPR5EIX-11P	
BY483-BPR6E	BPR6EIX-11P	
BY483-HB6AI	HB6AIX-11P	
BY483-HB6BI	HB6BIX-11P	
BY483-LFR5A	LFR5AIX-11P	
BY483-LFR6A	LFR6AIX-11P	
BY483-ZFR5F	ZFR5FIX-11P	
BY483-ZFR6F	ZFR6FIX-11P	
BY484-BKR5E	BKR5EIX-P	
BY484-BKR6E	BKR6EIX-P	
BY484-BKR7E	BKR7EIX-P	
BY484-BPR5E	BPR5EIX-P	
BY484-BPR6E	BPR6EIX-P	
BY484-DCPR7	DCPR7EIX-P	
BY484-LFR6A	LFR6AIX-P	
BY484-LFR7A	LFR7AIX-P	
<b>OMC</b>	<b>→ NGK Typ</b>	<b>V-LINE</b>
115206	BP6HS	18
387694	B7HS	
437929	BPR7HS	
445098	D6HA	
502177	B6HS	
502194	B7HS-10	
502196	BR6S	
502894	BUZ8H	
503948	BPR6HS	3
503949	BR6HS	
503950	BR6HS	
504082	BR6HS	
509921	BUHW	
509922	BUHW-2	
509924	BUZ8H	
509925	BZ7HS-10	
509926	BUHXW-1	
509928	B6S	
509929	B7HS	
584918	DCPR7E	
771770	BUZHW-2	



<b>OPEL</b>	<b>→ NGK Typ</b>	<b>V-LINE</b>
55562534	PFR6T-G	
90 239 568	BPR6ES	2
90 239 569	BPR6HS	3
90 336 461	BKR6ES	28
90 338 179	BCPR6ET	
90 355 136	BPR6ES	2
90 356 323	BPR5ES	6
90 357 729	BKR6EK	20
90 357 780	BKR6ES	28
90 423 215	BKR6ES	28
90 512 989	BKR5EK	23

<b>OREGON</b>	<b>→ NGK Typ</b>	<b>V-LINE</b>
ODR17YC	BCPR5ES	32
OJ17	B4LM	
OJ19	B2LM	
OJR17	BR4LM	
OK17C	B6S	
OK19	B4	
OL15YC	BP6ES	4
OL17YC	BPR5ES	6
OL17YC	BP5ES	8
OLY15YC	BPR6ES	2
ON17C	B6HS	
ON17YC	BP5HS	
ONR15YC	BPR6HS	3
OP15	BM7A	
OP15Y	BPM7A	
OP17	BM6A	
OP18Y	BPM6A	
OPR15	BMR7A	
OPR15Y	BPMR7A	
OPR17	BMR6A	
OPR18Y	BPMR6A	
ORJ19	BR2LM	
OU17	BM6F	

<b>PAL</b>	<b>→ NGK Typ</b>	<b>V-LINE</b>
14-5	B4H	
14-5Y	BP4H	
14-7	B5HS	
14-7Y	BP5HS	
14-8	B6HS	
14-8R	BR6HS	
14-8Y	BP6HS	18
14-9	B8HS	
14-9R	BR7HS	
14-9Y	BP7HS	
14K-5	B4	
14K-5Y	BP4	
14K-7Y	BP5S	
14K-8	B6S	

<b>PAL</b>	<b>→ NGK Typ</b>	<b>V-LINE</b>
14L-5	B5ES	
14L-5R	BR5ES	
14L-5Y	BP5ES	8
14L-7	B6ES	
14L-7R	BR6ES	
14L-7Y	BP6ES	4
14L-8	B6ES	
14L-8Y	BP6ES	4
14L-9	B7ES	
14L-9Y	BP7ES	
17-9	B7HS	
18-5	A6	
18-5R	A6	
18-7	A7	
18-8W	A8	
18F-5	A5FS	
B12YC	DP9EA-9	
B14YC	DP8EA-9	
B15YC	DP7EA-9	
D14YC	BCP7ES	
D15YC	BCP6ES	17
D17YC	BCP5ES	16
DR14YC	BCPR7ES	
DR15YC	BKR6E	28
DR17YC	BCPR5ES	32
G14YC	BP7EFS	
G15YC	BP6EFS	5
G17YC	BP5EFS	
K15YC	BP6S	
K17C	B6S	
K17Y	BP5S	
K19	B4	
L08JW	B11EN	
L08W	B11EGV	
L10JW	B95EN	
L12W	B9EVX	
L12YC	BP9ES	
L14C	B8ES	
L14YC	BP7ES	
L15C	B7ES	
L15W	B8EVX	
L15YC	BP6ES	4
L17C	B6ES	
L17Y	BP4E	
L17YC	BP5ES	8
L19	B4E	
L19C	B5ES	
L5Y	BP5ES	8
L7Y	BP6ES	4
L8	B6ES	
L8Y	BP6ES	4
L9Y	BP7ES	



<b>PAL</b>	<b>→ NGK Typ</b>	<b>V-LINE</b>
LR12YC	BPR8ES	
LR14YC	BPR7ES	19
LR15YC	BPR6ES	2
N12YC	BP8ES	
N14C	B9HS	
N14YC	BP7HS	
N15C	B7ES	
N15YC	BP6HS	18
N17C	B6HS	
N17Y	BP4H	
N17YC	BP5HS	
N19	B4H	
N19C	B5HS	
N7	B6HS	
N7Y	BP6HS	18
N8	B7HS	
N8Y	BP7HS	
NR12YC	BPR8HS	
NR15YC	BPR6HS	3
P15	BM7A	
P15Y	BPM7A	
P17	BM6A	
P17Y	BPM6A	
PR15Y	BPMR7A	
PR17Y	BPMR6A	
S14L-13	B8EG	
S14L-15	B9EG	
S14L-17	B10EG	
U17	BM6F	
<b>PEUGEOT</b>	<b>→ NGK Typ</b>	<b>V-LINE</b>
1173702700	BPR5HS	
5962.05	BP6EFS	5
5962.09	BP6EFS	5
5962.13	BP6ES	4
5962.14	BP6EFS	5
5962.15	BP6EFS	5
5962.16	BP6ES	4
5962.21	BP6ET	
5962.22	BPR6EVX	
5962.71	BKR6ES	28
5962.72	BP6EFS	5
5962.80	BP6HS	18
5962.82	BP6ES	4
5962.87	BP6EFS	5
5962.88	BP8ES	
5962.90	BP6HS	18
5962.94	BP7ES	
5962.98	BP7ES	
5962.A1	BP7ES	
5962.A2	BP6ES	4
5962.A3	BP6HS	18

<b>PEUGEOT</b>	<b>→ NGK Typ</b>	<b>V-LINE</b>
5962.A0	BP7ES	
5962.C5	BKR6ES	28
5962.C6	BKR6ES	28
5962.C0	BP5EFS	
5962.E2	BCP6ES	17
5962.F7	BCP6ES	17
5962.F8	BCP6ES	17
5962.G8	BP7ES	
5962.H2	BKR6ES	28
5962.H8	BKR5ES	
5962.H9	BCPR5ES	32
5962.J9	BKR6ES	28
5962.J0	BCP6ES	17
5962.K1	BCPR7ES	
5962.K3	BCP7ET	
5962.K4	BKR6ES	28
5962.K6	BKR6ES	28
5962.K7	BCPR6ET	
5962.K0	BCPR7ES	
5962.R5	BCPR6ET	
5962.R9	BKR6ES	28
5962.S2	BKR6E	28
5962.S4	BKR5ES	
5962.T8	BKR6ES	28
5962.V6	BKR5ES	
5962.V7	BKR6ES	28
5962.V8	BCPR7ES	
5962.W4	BCPR6ET	
5962.W6	BCPR7ES	
5962.W7	BCPR7ES	
5962.W9	BKR5EK	23
5962.X5	BCP6ES	17
5962.Y2	BKR5EK	23
5962.Y8	BKR6EK	20
5962.Z0	BKR6EK	20
726752	BR6HSA	
734371	BR8HS	
735592	BPR6HS	
736954	BR7HS	
736975	CR7EB	
737027	BPR5HS	
738155	BR8ES	
742380	CR7E	
744361	CPR8E	
754050	BR9ES	
756756	DPR7EA-9	
756757	B6HS	
756758	BP5HS	
756759	B7HS	
756760	B8HS	
756761	BP6HS	
756762	B9ES	





<b>PEUGEOT</b>	<b>→ NGK Typ</b>	<b>V-LINE</b>
756763	B9HS	
756766	B8ES	
756767	CPR8EB-9	
756768	BR9HS	
756770	B6ES	
760464	BPR7ES	
761605	CR9EB	
766420	CR7EKA	
768228	CR8EKB	
<b>PRESTOLITE</b>	<b>→ NGK Typ</b>	<b>V-LINE</b>
10E2	C7HSA	
10E3	C7HSA	
10E4	C6HSA	
12E2	D8HA	
12E22	D6HA	
12E3	D8HA	
12E42	D6HA	
12G2	D8EA	
12G3	D8EA	
14-01	B9S	
14-11	B2	
14-11N	BPM6A	
14-11X	B2	
14-2X	B6S	
14-3	B6S	
14-32	BP6S	
14-3N	BM7A	
14-3X	B6S	
14-4	B6S	
14-42	BP5S	
14-5	B6S	
14-52	BP5S	
14-5X	B6S	
14-7	B4	
14-7N	BM6A	
14-7X	B4	
14-82	BP4	
14-9	B4	
14-9X	B4	
14E01	BUH	
14E1	B8HS	
14E2	B7HS	
14E22	BP7HS	
14E3	B6HS	
14E32	BP6HS	18
14E4	B5HS	
14E42	BP6HS	18
14E52	BP5HS	
14E6	B5HS	
14E62	BP5HS	
14E82	BP4H	

<b>PRESTOLITE</b>	<b>→ NGK Typ</b>	<b>V-LINE</b>
14ER4	BR6HS	
14ER6	BR6HS	
14F22	BP6FS	
14F32	BP6FS	
14F3N	BM7F	
14F42	BP5FS	
14F52	BPR4FS	
14F7N	BM6F	
14G01	BUE	
14G1	B8ES	
14G12	BP8ES	
14G2	B7ES	
14G22	BP6ES	4
14G3	B6ES	
14G32	BP5ES	8
14G4	B6ES	
14G42	BP5ES	8
14G5	B5ES	
14G52	BP5ES	8
14G7	B5ES	
14G82	BP4ES	
14G902	BP8ES	
14GF22	BP6EFS	5
14GR22	BPR6ES	2
14GR32	BPR5ES	6
14GR4	BR6ES	
14GR42	BPR5ES	6
14GR52	BPR4ES	
14GR52-6	BPR4ES-11	
14GR52A	BPR4ES-11	
14GR53	ZGR5C	
14GR7	BR5ES	
14GRF22	BPR6EFS	7
14GRF32	BPR5EFS	
14GRF52	BPR5EFS	
14L4	B6L	
14L7	B6L	
14L9	B4L	
14R3	BR6S	
14R32	BP5S	
14R4	BR6S	
14R42	BP5S	
14R5	BR6S	
14R52	BP4	
14R53	BP4	
14R7N	BM6A	
14R8	B6S	
14RF22	BPR6FS	
14RF32	BPR5FS	
14RF32-6	BPR5FS-15	
14RF32A	BPR5FS-15	
14RF42	BPR5FS	



<b>PRESTOLITE</b>	<b>→ NGK Typ</b>	<b>V-LINE</b>
14RF42-6	BPR5FS-15	
14RF42A	BPR5FS-15	
14RF52	BPR4FS	
14RF52-6	BPR4FS-15	
14RF52A	BPR4FS-15	
14RF62	BPR4FS	
14RF62-6	BPR4FS-15	
14RF62A	BPR4FS-15	
18-10	A6	
18-3	A6	
18-4	A6	
18-8	A6	
18-9	A6	
18F22	AP6FS	
18F3	A6FS	
18F32	AP6FS	
18F42	AP5FS	
18F6	A6FS	
18F82	AP5FS	
18RF3	AR6FS	
18RF32	APR6FS	
18RF42	APR6FS	
18RF82	APR6FS	
78-10	G2Z	
78-8	G2Z	
<b>PROTECNICA</b>	<b>→ NGK Typ</b>	<b>V-LINE</b>
4708	BR2LM	
4843	BPM7A	
<b>RENAULT</b>	<b>→ NGK Typ</b>	<b>V-LINE</b>
74 39 146 775	BCPR5ET	
77 00 101 401	BCPR5ES	32
77 00 103 502	BPR5ES	6
77 00 103 503	BPR5ES	6
77 00 103 533	BKR5EK	23
77 00 107 916	BKR5EK	23
77 00 107 916	BKR5EK	
77 00 260 637	BCP7ET	
77 00 266 295	BPR6EFS	7
77 00 267 140	BPR6EFS	7
77 00 267 805	BP7EFVX	
77 00 273 462	BKR6E	28
77 00 273 698	BKR6EVX	
77 00 553 622	BP6ES	4
77 00 565 155	B9EVX	
77 00 587 168	BP6HS	18
77 00 714 540	BPR6EFS	7
77 00 722 095	BP6EFS	5
77 00 724 821	BP6ES	4
77 00 725 302	BPR5ES	6
77 00 726 503	BP7EFS	

<b>RENAULT</b>	<b>→ NGK Typ</b>	<b>V-LINE</b>
77 00 727 383	BPR6ES	2
77 00 731 583	BP7EFS	
77 00 732 626	BP8ES	
77 00 733 422	BP5HS	
77 00 736 149	BP7EFS	
77 00 736 150	BP7EFS	
77 00 737 457	BP7EFS	
77 00 737 458	BP6EFS	5
77 00 737 459	BP7ES	
77 00 737 612	BCP5ES	16
77 00 742 094	BPR7ES	19
77 00 743 137	BCP5ES	16
77 00 743 920	BP5ES	8
77 00 749 163	BCP5ES	16
77 00 824 821	BP6ES	4
77 00 852 522	BP6EFS	5
77 00 852 543	BP7EFVX	
77 00 855 463	BCP6ET	
77 00 855 918	BP5EFS	
77 00 856 342	BCP6ET	
77 00 859 910	BCP5ES	16
77 00 859 967	BP5ES	8
77 00 860 235	BP5ESZ	
77 00 860 235	BP5ESZ	
77 00 861 471	BP7ES	
77 00 861 472	BP6ESZ	
77 00 862 054	BP5ES	8
77 00 868 864	BPR7ES	19
77 00 869 200	BK5ESZ	
77 00 871 617	BCPR6ET	
77 01 021 767	BP6EFS	5
77 01 041 0214	BP5ES	
77 01 041 214	BP5ES	8
77 01 041 215	BP6EFS	5
77 01 042 816	BKR6E	28
77 01 043 624	BCPR6ET	
77 01 045 018	BP7EFS	
77 01 366 057	BP6HS	18
77 01 366 084	B8EVX	
77 01 366 085	B7EVX	
77 01 366 086	BP6ES	4
77 01 366 087	BP7ES	
77 01 366 137	BP6EFS	5
77 01 366 267	BP6HS	18
77 01 366 268	BP7ES	
77 01 366 269	BP6ES	4
77 01 366 270	BP6EFS	5
77 01 366 513	BP5HS	
77 01 366 514	BP6EFS	5
77 01 366 515	BP6HS	18
77 01 366 516	BP6ES	4
77 01 366 533	B6HS	



<b>RENAULT</b>	<b>→ NGK Typ</b>	<b>V-LINE</b>
77 01 366 539	BP5ES	8
77 01 366 903	BP5ES	8
77 01 414 022	BP5HS	
77 01 414 025	BP6ES	4
77 01 414 026	BP7EFS	
77 01 414 027	BP7EFS	
77 01 414 031	BPR6ES	2
77 01 414 105	BP5ESZ	
82 00 027 363	BKR5EK	
82 00 239 321	PFR6E-10	
82 00 239 321	PFR6E-10	
82 00 314 928	PFR7G-9	
82 00 314 928	PFR7G-9	
82 00 363 364	PFR6G-9	
82 00 363 384	PFR6G-9	
82 00 492 426	PFR7Z-TG	
82 00 492 426	PFR7Z-TG	
82 00 592 215	LZKAR7B	
83 04 504 277	ZFR5F	
89 33 003 862	BKR6ES	28
96 26 575 480	BKR6EK	20
96 32 182 880	PFR6E-10	
96 32 182 880	BKR6EK	20

<b>SAAB</b>	<b>→ NGK Typ</b>	<b>V-LINE</b>
55564215	BKR7ESC-11	
9116385	BCP5ES	

<b>SEAT</b>	<b>→ NGK Typ</b>	<b>V-LINE</b>
101 000 000AB	BP6ESZ	
101 000 001AB	BP6ET	
101 000 001AC	BP6ET	
101 000 001AD	BP5ET-10	
101 000 001AE	BP5ET	
101 000 002AB	BP6ESZ	
101 000 003AA	BCP7ET	
101 000 004AA	BCP7ET	
101 000 005AA	BP6ET	
101 000 005AB	BP6ET	
101 000 005AD	BP5ET-10	
101 000 005AE	BP5ET	
101 000 006AC	BP6ESZ	
101 000 007AA	BP6ET	
101 000 007AB	BP6ET	
101 000 007AC	BP5ET-10	
101 000 007AD	BP6ET	
101 000 017AA	BCP7ET	
101 000 026AA	BPR5EKU	
101 000 026AB	BUR6ET	1
101 000 027AA	BP6ET	
101 000 027AB	BP5ET	
101 000 027AC	BP5ET-10	

<b>SEAT</b>	<b>→ NGK Typ</b>	<b>V-LINE</b>
101 000 028AA	BCP7ET	
101 000 029AA	BU6EFSZ	
101 000 029AB	BUR6EFSZ	
101 000 033AA	BKUR6ET-10	24
101 000 033AB	BKUR7ET	
101 000 033AC	BKUR5ET	
101 000 033AF	BKUR6ET	27
101 000 034AA	BP6ESZ	
101 000 035HJ	BKR6EKUB	
101 000 035AA	BK5EKU	
101 000 035AB	BKR5EKU	
101 000 035AE	BK7EKU	
101 000 035AF	BKR7EKU	
101 000 035AH	BKR5EKUP	
101 000 036AA	BUR6ET	1
101 000 036AB	BUR5ET	22
101 000 036AC	BUR5ET-10	21
101 000 038AA	BPR5EKU	
101 000 038AB	BPR5EKU	
101 000 039AA	BPR5EKU	
101 000 039AB	BPR5EKU	
101 000 040AC	BUR5ET	22
101 000 040AD	BUR6ET	1
101 000 040AE	BUR5ET-10	21
101 000 041AC	BKUR6ET-10	24
101 000 041AD	BKUR6ET	27
101 000 041AE	BKUR7ET	
101 000 050AA	BPR5EKU	
101 000 050AB	BUR5ET	22
101 000 050AC	BUR6ET	1
101 000 051AA	BKUR6ET-10	24
101 000 051AB	BKUR7ET	
101 000 055AA	BKR6EK	20

<b>SPLITFIRE</b>	<b>→ NGK Typ</b>	<b>V-LINE</b>
TP006A	BP8EVX	
TP006B	BP7EVX	
TP006C	BP6EVX	
TP006D	BP5EVX	
TP006E	BP5EVX	
TP406B	BR9EVX	
TP406B	B9EVX	
TP406C	BR8EVX	
TP406C	B8EVX	
TP416B	DP9EVX-9	
TP416C	DP8EVX-9	
TP430B	CR9EVX	
TP430C	CR8EVX	

<b>SUBARU</b>	<b>→ NGK Typ</b>	<b>V-LINE</b>
22401AA000	BP5ES-11	
22401AA010	BP6ES-11	



<b>SUBARU</b>	<b>→ NGK Typ</b>	<b>V-LINE</b>
22401AA020	BP6ES	4
22401AA090	BP7ES	
22401AA100	BE527Y-11	
22401AA120	BPR6ES-11	13
22401AA220	BPR6ES	2
22401AA230	BPR7E	19
22401AA310	BKR6E-11	14
22401AA360	PFR7B	
22401AA370	PFR6B-11	
22401AA380	BRE527Y-11	
22401AA400	PFR6B	
22401AA480	BPR5ES-11	
22401AA500	BKR6EVX-11	
22401AA510	BKR6EVX	
22401AA520	PFR6G-11	
22401AA530	PFR6G	
22401AA570	PFR5B-11	
22401AA580	PLFR6A-11	
22401AA600	PFR7G	
22401AA630	ILFR6B	
22401AA650	FR5AP-11	
22401AA65A	FR5AP-11	
22401AA670	SILFR6A	
22401KA000	BU6EA-11	
22401KA010	BCP6E-11	
22401KA050	BUR6EA-11	
22401KA050	BUR6EA11	
22401KA080	BKR6E	28
22401KA100	BCPR6E	12
22401KA140	ZFR6G	
22401KA170	ZFR5G	
22401KA210	BKR5E-11	33
22401KA240	DCPR7E	
22401KA290	BKR4E-11	
22401KA310	DCPR8E	
22401KA320	DCPR8EVX	
22401KA330	ZFR6MP	
22401KA340	KR8BI	
22401KA430	BKR6EKPA	
22401KA440	BKR5E	35
22401KA450	LKR7AI	
22401KA460	BKR6ETP	
320540800	B6ES	
320541110	B7ES	
320541120	B7EVX	
320541320	B6EVX	
320545700	BR6ES	
382420800	B5ES	
420543200	BP5ES	8
420545800	BE529Y-11	
490010003	BP5EVX	
490010013	BP6EVX	

<b>SUBARU</b>	<b>→ NGK Typ</b>	<b>V-LINE</b>
490010023	BP7EVX	
490010033	BPR5ES	6
490010043	BP5EY	
490010053	BP6EY	
820541810	B6HS	
820546010	B8HS	
820547820	B6HVX	
820548020	B8HVX	
820548600	B6ES	
820549310	B7HS	
820549320	B7HVX	
882417800	B5HS	
890573400	B6S	
<b>SUZUKI</b>	<b>→ NGK Typ</b>	<b>V-LINE</b>
09482-00006	B-4	
09482-00011	B4H	
09482-00036	BP-4H	
09482-00051	B6S	
09482-00053	B7S	
09482-00054	B6ES	
09482-00059	BP6HS	
09482-00064	B6HV	
09482-00065	B7HV	
09482-00066	B9ES	
09482-00074	BP6HS	
09482-00079	BR6ES	
09482-00082	B7HS	
09482-00084	BP6HS	18
09482-00088	BR6HS	
09482-00089	B7ES	
09482-00091	B8ES	
09482-00095	B6HS	
09482-00096	B8EV	
09482-00097	B9EV	
09482-00098	BR9ES	
09482-00102	BR8HS	
09482-00105	BP7HS	
09482-00111	AU10EFP + n. m. L.	
09482-00115	BR9EV	
09482-00115	BR9EVX	
09482-00116	BR7HS	
09482-00117	BR7ES	
09482-00118	BP6ES	4
09482-00121	BR8ES	
09482-00124	BP5HS	
09482-00127	BR9ES	
09482-00129	BP5EA	
09482-00131	BP5ES	8
09482-00136	BPR-4H	
09482-00139	BP7ES	
09482-00141	BPR6HS	3



<b>SUZUKI</b>	<b>→ NGK Typ</b>	<b>V-LINE</b>
09482-00142	B4H	
09482-00143	BR5HS	
09482-00144	D8EA	
09482-00147	BPR5HS	
09482-00148	BP-4E	
09482-00149	DR8ESL	
09482-00151	B8HS	
09482-00153	B7HS	
09482-00155	BPR5ES	6
09482-00157	BR8HS	
09482-00161	BP4HS	
09482-00163	BP5HA	
09482-00167-000	BPR5EAL	
09482-00167-001	BPR5ES	6
09482-00170	BP4HA	
09482-00172	BP2HA	
09482-00175	BP8ES	
09482-00177	BP6ES	4
09482-00181	BR10EV	
09482-00182	D7EA	
09482-00184	D9EA	
09482-00198	B8HS	
09482-00205	BPR4HS	
09482-00208	B8EGV	
09482-00209	B9EGV	
09482-00210	B10EGV	
09482-00218	BP5EA-11	
09482-00219	BP5EA-L-11	
09482-00220	DR7ES	
09482-00221	DR8ES	
09482-00225	B8ES	
09482-00226	BP7ES	
09482-00227	CM-6	
09482-00228	BP5HS	
09482-00229	BPR6HS	
09482-00230	BR8HS	
09482-00237	B8HS	
09482-00239	BPR8ES	
09482-00255	BPR7HS	
09482-00258	BPMR6A	
09482-00259	BP6HS	18
09482-00260	BPM4A	
09482-00261	BPMR4A	
09482-00262	BP5HS-10	
09482-00264	BP6HS-10	
09482-00268	BP8HS	
09482-00269	B7HS-10	
09482-00277	BR7HS-10	
09482-00278	B8HS-10	
09482-00279	B8HS-10	
09482-00280	BR8HS-10	
09482-00281	BPR6HS	

<b>SUZUKI</b>	<b>→ NGK Typ</b>	<b>V-LINE</b>
09482-00282	B5HS	
09482-00285	BPR6ES-11	13
09482-00287	BP5ES-11	
09482-00288	BP4ES	
09482-00289	B4H	
09482-00290	BP-4H	
09482-00291	BP4HS	
09482-00294	C6HA	
09482-00299	BPR6ES	2
09482-00309	B5HS	
09482-00310	C7HA	
09482-00316	BPR5HS	
09482-00317	C8HA	
09482-00321	C8HSA	
09482-00322	BP5EV	
09482-00325	BR8EV	
09482-00327	BR6HS-10	
09482-00328	DP9EA-9	
09482-00330	DPR9EA-9	
09482-00332	DP8EA-9	
09482-00334	DPR8EA-9	
09482-00338	B6HS-10	
09482-00339	B6HS-10	
09482-00340	CR6HS	
09482-00341	BR6HS-10	
09482-00348	BR8ES	
09482-00349	BR9ES	
09482-00351	B9ES	
09482-00352	DP7EA-9	
09482-00354	DPR7EA-9	
09482-00358	BR4HS	
09482-00359	BPR5HS	
09482-00360	BR10ES	
09482-00362	ZGR5A	
09482-00365	J9A	
09482-00366	JR9A	
09482-00367	BPR4HS	
09482-00369	DCP7E	
09482-00370	BR8HS-10	
09482-00371	J10A	
09482-00372	JR10A	
09482-00373	L8A	
09482-00375	B8HS-10	
09482-00376	B8HS	
09482-00379	DCP8E	
09482-00380	PJR6A	
09482-00381	PJR7A	
09482-00382	PJR8A	
09482-00384	DCP8EVX	
09482-00385	BP7ES	
09482-00386	DCP7EVX	
09482-00388	J9B	



<b>SUZUKI</b>	<b>→ NGK Typ</b>	<b>V-LINE</b>
09482-00389	JR9B	
09482-00390	J10B	
09482-00391	JR10B	
09482-00394	DCP6E	
09482-00395	ZG5E	
09482-00397	JR9C	
09482-00398	DR7EA	
09482-00399	DR8EA	
09482-00400	DR9EA	
09482-00401	JR8C	
09482-00404	LR8A	
09482-00406	CR6HSA	
09482-00406-000	CR6HSA	
09482-00408	CR7HSA	
09482-00409	BPR6ES	2
09482-00410	CR9EK	
09482-00412	CR8EK	
09482-00414	CR7EK	
09482-00417	R2198-10P	
09482-00418	R2198-11P	
09482-00419	R2198-12P	
09482-00422	R5184-95	
09482-00423	R5184-10	
09482-00424	R5184-105	
09482-00426	BK6E	
09482-00427	BKR6E	28
09482-00429	BKR6E	28
09482-00430	R017-10	
09482-00431	R017-11	
09482-00432	BPR5E	
09482-00433	BPR5EY-11	
09482-00446	DCPR6E	
09482-00448	DCPR7E	
09482-00450	DCPR8E	
09482-00452	ZGR5A	
09482-00454	ZGR5E	
09482-00456	CR8E	
09482-00458	CR9E	
09482-00460	CR10E	
09482-00462	CR10EK	
09482-00463	CR10EK	
09482-00464	BR8HCS-10	
09482-00467	BR9HS-10	
09482-00470	BR8ECM	
09482-00472	BR9ECM	
09482-00474	BR10ECM	
09482-00477	BKR5E	35
09482-00478	B10ES	
09482-00479	DCPR7EVX	
09482-00481	DCPR8EVX	
09482-00485	CR8HSA	
09482-00486	BR8HCS-10	

<b>SUZUKI</b>	<b>→ NGK Typ</b>	<b>V-LINE</b>
09482-00487	BPR6ES	2
09482-00491	JR8B	
09482-00493	BPR5E-11	
09482-00494	BKR6E-11	14
09482-00495	BPR7ES	19
09482-00499	R4118S-8	
09482-00500	R4118S-9	
09482-00502	BP5EY	
09482-00504	BPR5EY	9
09482-00509	R6918B-8	
09482-00511	R6918B-7	
09482-00513	R0045J-10	
09482-00514	R0045J-11	
09482-00516	CR7E	
09482-00519	BR9EYA	
09482-00521	PGR5A	
09482-00522	BPR7HS-10	
09482-00523	BPR8HS	
09482-00525	IKR7A	
09482-00526	BR10EYA	
09482-00527	KR7AI	
09482-00528	CR6E	
09482-00530	BPR6HS	3
09482-00531	BP6HS	18
09482-00532	B7HS-10	
09482-00533	BR7HS-10	
09482-00534	B6HS-10	
09482-00535	BR6HS-10	
09482-00537	DCPR9EVX	
09482-00546	GR5AI-10	
09482-00547	IFR5E11	
09482-00548	IFR6E11	
09482-00549	IFR5J11	
09482-00550	IFR6J11	
09482-00556	CR8EIA-9	
09482-00561	BR8EG	
09482-00564	BR9EYA	
09482-00565	KR8AI	
09482-00566	BKR5E-11	33
09482-00584	CR8EIB-10	
09482-00597	CR8EIA-10	
09482-00600-000	DIMR8B10	
09482-69001	BPR6HS	3
99000-69257-000	R0161-10	
99000-69257-001	R216-11	
99000-69257-002	R4630A-95	
99000-69571	C7HSA	
99000-69835-B6R	BR6HIX	
99000-69835-B7R	BR7HIX	
99000-69835-B8R	BR8HIX	
99000-69835-BP6	BPR6HIX	
99000-69835-BP7	BPR7HIX	



<b>SUZUKI</b>	<b>→ NGK Typ</b>	<b>V-LINE</b>
99000-69835-BR1	BR10EIX	
99000-69835-BR8	BR8EIX	
99000-69835-BR9	BR9EIX	
99000-69835-C6R	CR6HIX	
99000-69835-C7R	CR7HIX	
99000-69835-C8R	CR8HIX	
99000-69835-CR7	CR7EIX	
99000-69835-CR8	CR8EIX	
99000-69835-CR9	CR9EIX	
99000-69835-DC7	DPR7EIX-9	
99000-69835-DC8	DCR8EIX	
99000-69835-DR8	DR8EIX	
99000-69835-DR9	DR9EIX	
99000-69835-PR8	DPR8EIX-9	
99000-69835-PR9	DPR9EIX-9	
99000-79A45-B0E	B10EVX	
99000-79A45-B6H	B6HVX	
99000-79A45-B7E	B7EVX	
99000-79A45-B7H	B7HVX	
99000-79A45-B8E	B8EVX	
99000-79A45-B8H	B8HVX	
99000-79A45-B9E	B9EVX	
99000-79A45-P8E	BP8EVX	
99000-79K60-BP6	BPR6EIX-11	
99000-79K60-DC7	DCPR7EIX	
99000-79K60-K5R	BKR5EIX	
99000-79K60-K6R	BKR6EIX	
99000-79K60-KR6	BKR6EIX-11	
99000-79K60-P5R	BPR5EIX	
99000-79K60-P6R	BPR6EIX	
99000-79K60-P7R	BPR7EIX	
99000-79K60-PR5	BPR5EIX-11	
99000-79L65-001	BKR6EIX-11P	
99000-79L65-002	BKR5EIX-P	
99000-79L65-003	BKR6EIX-P	
99000-79L65-004	DCPR7EIX-P	
99000-79L65-005	BKR5EIX-11P	
99000-79L65-006	BKR7EIX-P	
99000-79L65-007	BPR5EIX-P	
99000-79L65-008	BPR5EIX-11P	
99000-79L65-009	BPR6EIX-P	
99000-79L65-010	BPR6EIX-11P	
<b>TORCH</b>	<b>→ NGK Typ</b>	<b>V-LINE</b>
A6RTC	CR6HSA	
A6TC	C6HSA	
A7RTC	C7HSA	
A7TC	C7HSA	
D6RTC-9	DPR6EA-9	
D7RTC-9	DPR7EA-9	
D8RTC	DPR8EA-9	
F6RTC	BPR6ES	

<b>TORCH</b>	<b>→ NGK Typ</b>	<b>V-LINE</b>
F6TC	BP7ES	
K6RF	BKR5E	
L6RTC	BPMR6A	
L6TC	BPM6A	
L7RTC	BPMR7A	
L7T	BM6A	
L7TC	BPM7A	
T1137C	C7HSA	
<b>TOYOTA</b>	<b>→ NGK Typ</b>	<b>V-LINE</b>
04195-34140	BP5ES	
04195-34150	BP6ES	
08922-01017-83	BPR6EY-11	
08922-01019-83	BP5EY	
08922-01019-83	BPR5EY-11	
08922-01020-83	BCPR6EY-11	
08922-1016-83	BPR5EY	
90048-51158	BKR5E-11	33
90919-01051	BPR5ES	
90919-01063	BP6EK	
90919-01064	BPR5EY	
90919-01065	BPR5EA	
90919-01084	BPR6EY	
90919-01087	BP5EK-A	
90919-01088	BP6EK-A	
90919-01091	BPR5EY	
90919-01092	BPR6EK-A	
90919-01096	BPR5EK-A	
90919-01098	BPR6EY	
90919-01102	BPR5EY	
90919-01103	BPR4EY	
90919-01104	BPR5EY-11	
90919-01109	BPR4EY-11	
90919-01114	BRE527Y-11	
90919-01115	BPR5EP-11	
90919-01116	BPR5EP-11	
90919-01118	BE529Y-11	
90919-01120	BRE529Y	
90919-01122	BCPR5EP-11	
90919-01125	BPR6EY-11	
90919-01126	BPR6EY-11	
90919-01127	BCPR6EP-11	
90919-01128	BCPR6EP-11	
90919-01129	BCPR5EY-11	
90919-01131	BCPR6EY-11	
90919-01134	BPR5EP-13	
90919-01136	BCPR6EP-N-11	
90919-01144	BPR5EP-11	
90919-01145	BCPR6EPN-8	
90919-01146	BCPR6EP-N-8	
90919-01148	BPR6EP-8	
90919-01149	BCPR6EY	



<b>TOYOTA</b>	<b>→ NGK Typ</b>	<b>V-LINE</b>
90919-01151	BCPR5EP-8	
90919-01152	BCPR5EP-8	
90919-01153	BCPR5EY-11	
90919-01155	BCRE527Y	
90919-01157	BCPR6EP-13	
90919-01158	BCPR5EP-13	
90919-01162	BCPR6EP-8	
90919-01165	BKR5EYA-11	
90919-01166	BKR6EYA-11	
90919-01168	BKR5EP-11	
90919-01169	BKR5EP-11	
90919-01173	BKR6EP-N-8	
90919-01176	BKR5EYA	
90919-01177	BKR5EYA	
90919-01179	BKR6EP-11	
90919-01180	BKR6EP-8	
90919-01181	BKR6EP-8	
90919-01184	BKR6EY-11	
90919-01187	PFR6G-13	
90919-01187	BKR6EP-13	
90919-01188	BKR6EP-13	
90919-01192	BKR5EKB-11	
90919-01193	BKR5EKB-11	
90919-01194	BKR6EKP-11	
90919-01195	BKR6EKP-11	
90919-01197	BKR5EKP-11	
90919-01198	BKR6EKB-11	
90919-01201	BKR5EKP-13	
90919-01202	BKR6EKB-11	
90919-01205	BKR5EP-8	
90919-01206	BKR5EP-8	
90919-01210	IFR6T11	
90919-01211	IFR6T11	
90919-01213	BKR6EPA-8	
90919-01215	IFR5T-8N	
90919-01218	IFR5A11	
90919-01224	BPR5EP-8	
90919-01238	IFR6T11	
90919-01248	ILFR6D11	
90999-09006	BP5EY	
90999-09007	BP6EY	
<b>UNIPART</b>	<b>→ NGK Typ</b>	<b>V-LINE</b>
GSP130	B5ES	
GSP131	BP5ES	8
GSP141	BP5ES	8
GSP151	BP6ES	4
GSP160	B6ES	
GSP163	BP6ES	4
GSP171	BP6ES	4
GSP181	BP7ES	
GSP191	BP8ES	

<b>UNIPART</b>	<b>→ NGK Typ</b>	<b>V-LINE</b>
GSP244	BPR5ES	6
GSP263	BPR6ES	2
GSP264	BPR5ES	6
GSP281	BPR7ES	19
GSP30	B6S	
GSP331	BP5EFS	
GSP351	BP5EFS	
GSP361	BP6EFS	5
GSP381	BP7EFS	
GSP4154	AP6FS	
GSP4266	B5HS	
GSP4352	BP6ES	4
GSP4356	BP6HS	18
GSP4362	BP6ES	4
GSP4366	BP6HS	18
GSP4372	BP5ES	8
GSP4376	BP5HS	
GSP4382	BP5ES	8
GSP4452	BPR7ES	19
GSP4462	BPR6ES	2
GSP4472	BPR5ES	6
GSP4552	BCP7ES	
GSP4562	BCP6ES	17
GSP4563	BP6EFS	5
GSP4573	BP5EFS	
GSP461	BPR6EFS	7
GSP4652	BCPR7ES	
GSP4662	BKR6E	28
GSP4663	BPR6EFS	7
GSP531	BP5HS	
GSP540	B5HS	
GSP541	BP6HS	18
GSP550	B6HS	
GSP560	B7HS	
GSP571	BP7HS	
GSP634	BCPR5ES	32
GSP664	BKR6E	28
GSP665	BCP6ES	17
GSP6652	BKR6E	28
GSP6662	BKR6E	28
GSP684	BCPR7ES	
GSP685	BCP7ES	
GSP761	BP6FS	
GSP881	BPR6FS	
GSP96SZ	PFR6N-11	
GSP981	AP6FS	
<b>VOLVO</b>	<b>→ NGK Typ</b>	<b>V-LINE</b>
13 67 528	BPR6ES	2
13 67 529	BPR6ES	2
271 603	BKR6E	28
271 727	BKR6E	28





271 758	BKR7EVX-11	
30650843	LFR6D	
<b>VOLVO</b>	<b>→ NGK Typ</b>	<b>V-LINE</b>
35 17 980	BKR6E	28
<b>VW</b>	<b>→ NGK Typ</b>	<b>V-LINE</b>
101 000 000AB	BP6ESZ	
101 000 001AA	-----	
101 000 001AB	BP6ET	
101 000 001AC	BP6ET	
101 000 001AD	BP5ET-10	
101 000 001AE	BP5ET	
101 000 002AB	BP6ESZ	
101 000 003AA	BCP7ET	
101 000 004AA	BCP7ET	
101 000 005AA	BP6ET	
101 000 005AB	BP6ET	
101 000 005AC	BP7ET	
101 000 005AD	BP5ET-10	
101 000 005AE	BP5ET	
101 000 005AF	BP5ET	
101 000 006AB	BP6ESZ	
101 000 006AC	BP6ESZ	
101 000 007AA	BP6ET	
101 000 007AB	BP6ET	
101 000 007AC	BP5ET-10	
101 000 007AD	BP6ET	
101 000 016AA	PFR7B	
101 000 016AB	PFR6Q	
101 000 017AA	BCP7ET	
101 000 026AA	BUR5ET	22
101 000 026AA	BPR5EKU	AAF engine
101 000 026AB	BUR6ET	1
101 000 027AA	BP6ET	
101 000 027AB	BP5ET	
101 000 027AC	BP5ET-10	
101 000 028AA	BCP7ET	
101 000 029AB	BUR6EFSZ	
101 000 033AA	BKUR6ET-10	24
101 000 033AB	BKUR7ET	
101 000 033AC	BKUR5ET	
101 000 033AF	BKUR6ET	27
101 000 033AG	BKUR5ET-10	
101 000 034AA	BP6ESZ	
101 000 035AB	BKR5EKU	
101 000 035AH	BKR5EKUP	
101 000 035HJ	BKR6EKUB	
101 000 036AA	BUR6ET	1
101 000 036AB	BUR5ET	22
101 000 036AC	BUR5ET-10	21
101 000 038AA	BPR5EKU	
101 000 038AB	BPR5EKU	
101 000 039AA	BPR5EKU	

<b>VW</b>	<b>→ NGK Typ</b>	<b>V-LINE</b>
101 000 039AB	BPR5EKU	
101 000 040AC	BUR5ET	22
101 000 040AD	BUR6ET	1
101 000 040AE	BUR5ET-10	21
101 000 041AC	BKUR6ET-10	24
101 000 041AD	BKUR6ET	27
101 000 041AE	BKUR7ET	
101 000 044AA	----- nur für USA	
101 000 047AA	BP5ESA	
101 000 047AB	PGR6D	
101 000 049AD	BKR6ETA-10	
101 000 050AA	BUR5ET	22
101 000 050AB	BUR5ET-10	21
101 000 050AC	BUR6ET	1
101 000 051AA	BKUR6ET-10	24
101 000 051AB	BKUR7ET	
101 000 052AA	BUR6EFSZ	
101 000 054AC	BKR6EQUA	
101 000 055AA	BKR6EK	20
101 000 060AA	BKUR5ET-10	
101 000 062AA	PZFR6D-11	
101 000 062AB	PZFR5D-11	34
101 000 063AA	PFR6Q	
101 000 063AC	PFR7Q	
101 000 065AA	BKR6ETA-10	
101 000 067AA	BKR6EQUA	
101 100 068AA	ZFR6S-Q	
101 905 600	PZFR5J-11	
101 905 600 A	PZFR6J-11	
101 905 600A	PZFR6J-11	
101 905 600C	PZFR5Q-11	
101 905 601	PZFR5D-11	34
101 905 606	IZKR7B	
101 905 606A	IZKR7B	
101 905 607	BKR6EKUE	
101 905 611	PFR6U-11G	
101 905 611	PFR6U-11G	
101 905 611A	PFR6X-11	
101 905 611B	PFR6S-8E	
101 905 616	BKR6EQUA	
101 905 616	BKR6EQUA	
101 905 617	ZFR5P-G	
101 905 617C	ZFR6T-11G	
101 905 620	PZFR5N-11TG	
101 905 621A	PFR6W-T	
101 905 622	ILZKR7A	
101 905 624	ZKR7AP-Q	
101 905 626	PZFR6R	
<b>WOLF</b>	<b>→ NGK Typ</b>	<b>V-LINE</b>
1015 306	A6	
1018 301	BM6A	



<b>WOLF</b>	<b>→ NGK Typ</b>	<b>V-LINE</b>
1022 304	A6	
2000 305	BMR6A	
2012 310	BPR4S	
2016 301	B7HS	
2050 324	BMR6A	
2085 300	BR6ES	
2090 306	BPR6ES	2
<b>YAMAHA</b>	<b>→ NGK Typ</b>	<b>V-LINE</b>
90793 20029	B95EGV	
90793 20030	B105EGV	
90793 20032	B10EG	
90793-20001	B7EVX	
90793-20002	B8EVX	
90793-20003	B9EVX	
90793-20004	B10EVX	
90793-20005	B6HVX	
90793-20006	B7HVX	
90793-20007	B8HVX	
90793-20008	BP8EVX	
90793-20010	D7EVX	
90793-20011	D8EVX	
90793-20012	D9EVX	
90793-20013	DP8EVX-9	
90793-20014	DP9EVX-9	
90793-20015	C7HVX	
90793-20016	C8HVX	
90793-20017	B10HV	
90793-20018	B10EV	
90793-20021	D7EV	
90793-20022	D8EV	
90793-20023	D9EV	
90793-20024	BP5EV	
90793-20025	BP8EV	
90793-20026	BP9EV	
90793-20027	BP10EV	
90793-20028	B85EGV	
90793-20029	B95EGV	
90793-20030	B105EGV	
90793-20031	B11EGV	
90793-20032	B10EG	
90793-20035	BP-4H	
90793-20036	BP4HSA	
90793-20037	BP4HS-10	
90793-20038	BP5HS-10	
90793-20039	BP6HSA	
90793-20040	BP5ES-11	
90793-20045	BP6ES-11	
90793-20051	D8HA	
90793-20053	D10EA	
90793-20054	DP6EA-9	
90793-20055	C4HA	

<b>YAMAHA</b>	<b>→ NGK Typ</b>	<b>V-LINE</b>
90793-20056	L8A	
90793-20057	BR6HS	
90793-20058	BR7HS-10	
90793-20060	BR6ES	
90793-20062	BPR8ES	
90793-20065	BPR5EY	
90793-20066	BPR5EY-11	
90793-20067	BPR6EY	
90793-20068	BPR6EY-11	
90793-20069	BPR7EY-11	
90793-20071	CR7HS	
90793-20072	CR8HS	
90793-20075	DR8HS	
90793-20076	DR7ES	
90793-20077	DR8ES	
90793-20080	DPR9EA-9	
90793-20081	C7HV	
90793-20082	C8HV	
90793-20083	DP8EV-9	
90793-20084	DP9EV-9	
90793-20085	BP6HV	
90793-20086	BP7HV	
90793-20090	BPM7A	
90793-20091	BPM4A	
90793-20092	BPM4A-10	
90793-20093	BPM6A-10	
90793-20094	BPMR4A	
90793-20095	BPMR4A-10	
90793-20096	BPMR6A-10	
90793-20098	BPMR7A	
90793-20099	B9HVX	
90793-20100	B10HVX	
90793-20101	BP6HVX	
90793-20102	BP7HVX	
90793-20103	BP8HVX	
90793-20104	BP9HVX	
90793-20105	B6EVX	
90793-20106	BP5EVX	
90793-20107	BP6EVX	
90793-20108	BP5EVX-11	
90793-20109	BP6EVX-11	
90793-20110	BP7EVX	
90793-20111	BP7EVX-11	
90793-20112	BR8EVX	
90793-20113	BP8HS-10	
90793-20115	BR10EV	
90793-20116	BPR5EVX	
90793-20117	BPR6EVX	
90793-20118	BR9EVX	
90793-20119	DPR8EVX-9	
90793-20120	DPR9EVX-9	
90793-20121	BR6FS	



<b>YAMAHA</b>	<b>→ NGK Typ</b>	<b>V-LINE</b>
90793-20122	C8EVX	
90793-20123	C9EVX	
90793-20124	CR8EVX	
90793-20125	CR9EVX	
90793-20127	BPR7ES-11	
90793-20128	BR4ES	
90793-20129	BPR7HS-10	
90793-20130	BR4HS	
90793-20131	BR5HS	
90793-20132	CR6HSA	
90793-20133	CR7HSA	
90793-20134	BR8EG	
90793-20135	BR9EG	
90793-20136	BR10EG	
90793-20138	BPR6EV	
90793-20139	BR8ECM	
90793-20140	BR10ECM	
90793-20149	R0256R-10	
90793-20150	CR8EIX	
90793-20151	CR9EIX	
90793-20152	DR8EIX	
90793-20153	DR9EIX	
90793-20154	DPR8EIX-9	
90793-20155	DPR9EIX-9	
90793-20156	BPR6HIX	
90793-20157	BPR7HIX	
90793-20158	BR6HIX	
90793-20159	BR7HIX	
90793-20160	BR8EIX	
90793-20161	BR9EIX	
90793-20162	CR8EHIX-9	
90793-20163	CR9EHIX-9	
90793-20164	BR8HIX	
90793-20165	BR10EIX	
90793-20166	BPR8HIX	
90793-20167	BPR5EIX	
90793-20168	BPR6EIX	
90793-20169	CR5HIX	
90793-20170	CR6HIX	
90793-20171	CR7HIX	
90793-20172	CR7EIX	
90793-20173	DPR7EIX-9	
90793-20174	CR8HIX	
90793-20175	BPR7EIX	
9079E-NG001	B8EVX	
9079E-NG002	B9EVX	
9079E-NG003	B10EVX	
9079E-NG004	BR8EVX	
9079E-NG005	BR9EVX	
90890 78082	B10EGV	
90890-78063	C5HA	
90890-78064	C8HA	

<b>YAMAHA</b>	<b>→ NGK Typ</b>	<b>V-LINE</b>
90890-78065	D6HA	
90890-78066	D6EA	
90890-78068	DP9EA-9	
90890-78070	B9HS-10	
90890-78071	BP8HS	
90890-78072	BP9ES	
90890-78073	BP4HA	
90890-78074	BM6A	
90890-78075	BM7A	
90890-78076	BPM6A	
90890-78077	BR9HS	
90890-78078	BP7EV	
90890-78079	BP6EV	
90890-78081	B5EV	
90890-78082	B10EGV	
94700-00394	R0256R-10	
94701 00039	B6HS	
94701 00040	B7HS	
94701 00041	B8HS	
94701 00042	B9HS	
94701 00043	B6ES	
94701 00044	B7ES	
94701 00045	B8ES	
94701 00046	B9ES	
94701 00048	B8HCS	
94701 00050	BP7HS	
94701 00061	B8EVX	
94701 00063	B9EVX	
94701 00069	B5HS	
94701 00078	B5ES	
94701 00108	BP6HS	18
94701 00110	BR7HS	
94701 00111	BR6ES	
94701 00112	BR7ES	
94701 00113	BR8EVX	
94701 00116	BP6ES	4
94701 00117	BP7ES	
94701 00118	BP8ES	
94701 00148	B8HVX	
94701 00157	D8EA	
94701 00159	BP4HS	
94701 00160	B8HS-10	
94701 00168	BP5HS	
94701 00188	BR9ES	
94701 00189	D7EA	
94701 00190	BP5HA	
94701 00193	BR9EVX	
94701 00194	BPR5HS	
94701 00195	BR8HS	
94701 00198	BPR6HS	3
94701 00203	DR8ESL	
94701 00204	BR8ES	



<b>YAMAHA</b>	<b>→ NGK Typ</b>	<b>V-LINE</b>
94701 00208	DR7ES	
94701 00217	B7HS-10	
94701 00218	BPR7ES	19
94701 00219	BPR8ES	
94701 00227	BPR7HS	
94701 00232	BP6HS-10	
94701 00234	BPR6ES	2
94701 00237	BP8HS-10	
94701 00241	DPR8EA-9	
94701 00248	BR6HS	
94701 00250	CR7HS	
94701 00251	BR9HS	
94701 00254	C7HSA	
94701 00256	C6HSA	
94701 00258	BPR4HS	
94701 00262	DPR7EA-9	
94701 00263	DP7EA-9	
94701 00264	BP7HS-10	
94701 00266	D9EA	
94701 00267	BP8ES-11	
94701 00268	BP8HS	
94701 00273	B6HS-10	
94701 00274	BR6HS-10	
94701 00275	DP8EA-9	
94701 00280	BPR8HS	
94701 00282	CR6HS	
94701 00284	BP6EVX	
94701 00285	BPR6EVX	
94701 00287	DR8ES	
94701 00292	BPR6HS-10	
94701 00300	CR5HS	
94701 00301	B6EVX	
94701 00309	BR9HS-10	
94701 00311	BR5ES	
94701 00318	CR9E	
94701 00328	BPR5ES	6
94701 00330	CR8E	
94701 00332	R5184-105	
94701 00333	DR8EA	
94701 00340	DR9EA	
94701 00345	DR7EA	
94701 00353	CR7E	
94701 00354	CR4HSA	
94701 00358	C7E	
94701 00361	DPR9EA-9	
94701 00365	BR6FS	
94701 00372	CR6HSA	
94701 00375	DPR6EA-9	
94701 00395	CR9EK	
94701 00403	CR9EK	
94701 00406	DPR5EA-9	
94701 00408	CR9EIA-9	

<b>YAMAHA</b>	<b>→ NGK Typ</b>	<b>V-LINE</b>
94701-00315	C9E	
94701-00386	CR10EK	
94701-00402	CR10EK	
94701-00403	CR9EK	
94701-00406	DPR5EA-9	
94701-00408	CR9EIA-9	
94701-00410	CR9E	
94701-00411	CR8E	
94701-00420	CPR7EA-9	
94701-00422	LMAR7A-9	
94701-00422	LMAR7A-9	
94702 00044	B7ES	
94702 00045	B8ES	
94702 00046	B9ES	
94702 00149	B7HS	
94702 00188	BR9ES	
94702 00193	BR9EVX	
94702 00195	BR8HS	
94702 00204	BR8ES	
94702 00211	BPMR6A	
94702 00247	BR8HS-10	
94702 00248	BR6HS	
94702 00248	BR6HS	
94702 00249	BR5HS	
94702 00271	BR7HS-10	
94702 00272	BR7HS	
94702 00274	BR6HS-10	
94702 00309	BR9HS-10	
94702 00317	B9HS-10	
94702 00323	B8EG	
94702 00324	BR9EG	
94702 00325	B9EG	
94702 00326	BR8EG	
94702 00331	BPR4ES	
94702 00343	BR4ES	
94702 00348	BPR2ES	
94702 00349	BR7ES	
94702 00357	BR9ECM	
94702 00367	B10EG	
94702 00391	LFR5A-11	
94702 00400	LFR6A-11	
94702 00404	BKR7EKU	
94702 00405	BKR6EKU	
94702 00409	CR9EB	
94702 00418	DPR6EB-9	
94702 00419	CR4HSB	
94702 00N01	BP5HM	
94702-00193	BR9EVX	
94702-00234	BPR6ES	
94702-00372	CR6HSB	
94702-00374	R6179A-105P	
94702-00383	BR9ECS	



<b>YAMAHA</b>	<b>→ NGK Typ</b>	<b>V-LINE</b>
94702-00384	BR10ECS	
94702-00404	BKR7EKU	
94702-00405	BKR6EKU	
94702-00409	CR9EB	
94702-00418	DPR6EB-9	
94702-00419	CR4HSB	
94703 00277	B9EGV	
94703 00420	CPR7EA-9	
94703-00001	B4H	
94703-00039	B6HS	
94703-00040	B7HS	
94703-00041	B8HS	
94703-00042	B9HS	
94703-00043	B6ES	
94703-00044	B7ES	
94703-00045	B8ES	
94703-00046	B9ES	
94703-00050	BP7HS	
94703-00059	B7HV	
94703-00060	B9HV	
94703-00062	B6HV	
94703-00065	B7EV	
94703-00069	B5HS	
94703-00074	B8EV	
94703-00075	B9EV	
94703-00078	B5ES	
94703-00108	BP6HS	
94703-00109	BP-2E	
94703-00110	BR7HS	
94703-00112	BR7ES	
94703-00113	BR8EV	
94703-00114	BR9EV	
94703-00116	BP6ES	
94703-00117	BP7ES	
94703-00118	BP8ES	
94703-00133	BP5ES	
94703-00143	BR8HV	
94703-00148	B8HV	
94703-00157	D8EA	
94703-00159	BP4HS	
94703-00160	B8HS-10	
94703-00168	BP5HS	
94703-00188	BR9ES	
94703-00189	D7EA	
94703-00190	BP5HA	
94703-00191	BP4ES	
94703-00194	BPR5HS	
94703-00198	BPR6HS	
94703-00203	DR8ESL	
94703-00204	BR8ES	
94703-00207	B4ES	
94703-00213	C6HA	

<b>YAMAHA</b>	<b>→ NGK Typ</b>	<b>V-LINE</b>
94703-00215	C7HA	
94703-00217	B7HS-10	
94703-00218	BPR7ES	
94703-00221	BP2HS	
94703-00227	BPR7HS	
94703-00232	BP6HS-10	
94703-00234	BPR6ES	
94703-00241	DPR8EA-9	
94703-00254	C7HSA	
94703-00256	C6HSA	
94703-00258	BPR4HS	
94703-00262	DPR7EA-9	
94703-00263	DP7EA-9	
94703-00264	BP7HS-10	
94703-00266	D9EA	
94703-00267	BP8ES-11	
94703-00273	B6HS-10	
94703-00275	DP8EA-9	
94703-00277	B9EGV	
94703-00279	B8EGV	
94703-00282	CR6HS	
94703-00301	B6EV	
94703-00310	C2H	
94703-00311	BR5ES	
94703-00314	C8E	
94703-00315	C9E	
94703-00318	CR9E	
94703-00320	BP7ES-11	
94703-00323	B8EG	
94703-00325	B9EG	
94703-00328	BPR5ES	
94703-00330	CR8E	
94703-00332	R5184-105	
94703-00333	DR8EA	
94703-00334	B-2H	
94703-00340	DR9EA	
94703-00345	DR7EA	
94703-00353	CR7E	
94703-00370	DR2HS	
94703-00381	CR6E	
94703-00406	DPR5EA-9	
94703-00410	CR9E	
94703-00411	CR8E	
94703-00420	CPR7EA-9	
94709-00193	BR9EVX	
94709-00195	BR8HS	
94709-00211	BPMR6A	
94709-00247	BR8HS-10	
94709-00274	BR6HS-10	
94709-00309	BR9HS-10	
94709-00324	BR9EG	
94709-00326	BR8EG	





<b>ALFA ROMEO</b>	<b>→ NGK</b>
60507123	Y-909R
<b>BERU</b>	
<b>→ NGK</b>	
0100101305	DG-237
0100101306	DG-237
0100220113	Y-204RS
0100220114	Y-112M1
0100220115	Y-112R1
0100220118	Y-705RS
0100220206	Y-403T
0100221101	Y-302
0100221102	Y-208T
0100221103	Y-208T
0100221106	Y-208T
0100221107	Y-902R
0100221125	Y-902R
0100221132	Y-902R
0100221133	Y-902R
0100221135	Y-908R
0100221141	Y-909R
0100221144	Y-911R
0100221145	Y-902R
0100221146	Y-910R
0100221147	Y-115T1
0100221148	Y-128T
0100221149	Y-117RS
0100221151	Y-118T1
0100221152	Y-204TS1
0100221154	Y-107R
0100221163	Y-917U
0100221206	Y-404
0100221210	Y-405
0100221301	Y-811
0100222101	Y-118R
0100222102	Y-168R
0100222301	Y-810
0100222301	Y-403-1
0100222302	Y-810
0100226129	Y-729U
0100226163	Y-913M
0100226173	Y-918R
0100226180	Y-146R
0100226182	Y-147T
0100226183	Y-115R1
0100226184	Y-730U
0100226185	Y-922R
0100226186	Y-923U
0100226188	Y-731U
0100226189	Y-914U
0100226194	Y-707RS
0100226198	Y-935U
0100226227	Y-732U

<b>BERU</b>	<b>→ NGK</b>
0100226227	Y-732U
0100226229	Y-924U
0100226234	Y-916R
0100226235	Y-925R
0100226391	Y-939J
0100230101	Y-181T
0100230102	Y-162R1
0100231104	Y-157R
0100231107	Y-197R
0100231109	Y-757RS
0100231114	Y-197T
0100276004	YE04
105MJ	Y-403-1
107M	Y-810
130MJ	Y-405
141MJ	Y-207T
151MJ	Y-208T
155MJ	Y-404
161MJ	Y-208T
162MJ	Y-207T
170MJ	Y-811
171MJ	Y-810
601MJ	Y-918R
609MJ	Y-902R
613MJ	Y-902R
624MJ	Y-902R
633MJ	Y-902R
950MJ	Y-732U
G 1	---
G 2	Y-902R
G 3	Y-902R
G 4	Y-907R
G 5	---
G 6	---
GD348	DG-237
GD368	DG-237
GD382	DG-237
GE100	Y-607AS
GE101	YE14
GE108	Y-609AS
GN003	Y-745U
GN005	Y-701J
GN007	Y-741U
GN008	Y-501U
GN010	Y-746R
GN012	Y-502R
GN013	Y-938R
GN015	Y-534J
GN016	Y-503R
GN017	Y-747U
GN018	Y-515J
GN019	Y-516J



<b>BERU</b>	<b>→ NGK</b>
GN022	Y-937R
GN024	Y-507R
GN026	Y-517J
GN027	Y-504R
GN030	Y-939J
GN033	Y-523J
GN035	Y-749J
GN039	Y-530J
GN041	Y-534J
GN043	Y-532J
GN044	Y-755RS
GN045	YE12
GN046	Y-741U
GN047	YE04
GN053	YE06
GN058	YE13
GN059	YE07
GN853	Y-712RS
GN854	Y-712RS
GN855	Y-732U
GN857	Y-918R
GN858	Y-916R
GN860	Y-930U
GN905	Y-730U
GN908	Y-922R
GN909	Y-923U
GN912	Y-731U
GN917	Y-914U
GN925	Y-926U
GN927	Y-935U
GN939	Y-525J
GN944	Y-604J
GN948	Y-925R
GN954	Y-924U
GN959	Y-932R
GN961	Y-929U
GN963	Y-506R
GN964	Y-738U
GN970	Y-928U
GN985	Y-605J
GN991	Y-927R
GN992	Y-748U
GN993	Y-524J
GN999	Y-740U
GV105	Y-208T
GV106	Y-403-1
GV107	Y-810
GV108	Y-810
GV112	Y-302
GV130	Y-405
GV137	Y-403T
GV151	Y-208T

<b>BERU</b>	<b>→ NGK</b>
GV155	Y-404
GV602	Y-208T
GV603	Y-902R
GV624	Y-902R
GV631	Y-907R
GV636	Y-902R
GV642	Y-908R
GV657	Y-909R
GV661	Y-911R
GV663	Y-920R
GV666	Y-910R
GV673	Y-115T1
GV678	Y-128T
GV685	Y-117RS
GV688	Y-118T1
GV689	Y-204TS1
GV705	Y-107R
GV719	Y-917U
GV730	Y-739R
GV749	Y-306R not Opel/Isuzu
GV783	Y-729U
GV844	Y-933R
GV852	Y-913M
GV880	Y-157R
GV886	Y-146R
GV887	Y-181T
GV888	Y-204RS
GV889	Y-112M1
GV890	Y-162R1
GV892	Y-112R1
GV894	Y-118R
GV895	Y-197R
GV896	Y-168R
GV897	Y-147T
GV898	Y-115R1
GV920	Y-705RS
GV921	Y-707RS
GV921	Y-722J
GV922	Y-757RS
GV945	Y-307R
GV946	Y-742U
GV947	Y-711J
GV968	Y-715R
<b>BMW</b>	<b>→ NGK</b>
12 23 1 288 245	Y-902R
12 23 2 241 389	Y-917U
12 23 2 248 059	Y-507R
12 23 7 786 869	Y-547AS
<b>BOSCH</b>	<b>→ NGK</b>
0250001008	DG-237





<b>BOSCH</b>	<b>→ NGK</b>
0250001012	DG-237
0250001016	DG-237
0250001416	DG-237
0250200013	Y-811
0250200014	Y-810
0250200020	Y-810
0250200035	Y-302
0250200037	Y-404
0250200046	Y-403-1
0250200048	Y-405
0250200049	Y-207T
0250200051	Y-403T
0250200052	Y-207T
0250200053	Y-909R
0250200054	Y-208T
0250200055	Y-810
0250200056	Y-208T
0250200058	Y-208T
0250200059	Y-208T
0250200060	Y-208T
0250200063	Y-207T
0250200065	Y-208T
0250200068	Y-208T
0250200069	Y-908R
0250200420	Y-810
0250200451	Y-403T
0250200454	Y-208T
0250200456	Y-208T
0250200465	Y-208T
0250200468	Y-208T
0250201001	Y-902R
0250201004	Y-918R
0250201005	Y-902R
0250201006	Y-908R
0250201008	Y-902R
0250201009	Y-902R
0250201011	Y-918R
0250201012	Y-909R
0250201013	Y-902R
0250201015	Y-918R
0250201017	Y-907R
0250201019	Y-902R
0250201021	Y-918R
0250201026	Y-916R
0250201027	Y-917U
0250201029	Y-913M
0250201032	Y-918R
0250201033	Y-923U
0250201034	Y-909R
0250201035	Y-930U
0250201038	Y-925R
0250201039	Y-908R

<b>BOSCH</b>	<b>→ NGK</b>
0250201039	Y-924U
0250201039	Y-902R
0250201039	Y-914U
0250201039	Y-920R
0250201039	Y-923U
0250201039	Y-208T
0250201041	Y-916R
0250201042	Y-938R
0250201043	Y-913M
0250201049	Y-937R
0250201050	Y-932R
0250201053	Y-939J
0250201405	Y-902R
0250201415	Y-918R
0250202001	Y-907R
0250202001	Y-922R
0250202002	Y-739R
0250202003	Y-115T1
0250202004	Y-128T
0250202005	Y-117RS
0250202006	Y-118T1
0250202007	Y-107T
0250202007	Y-107R
0250202008	Y-306R
0250202009	Y-732U
0250202013	Y-204RS
0250202015	Y-103
0250202017	Y-112R1
0250202018	Y-910R
0250202020	Y-731U
0250202022	Y-732U
0250202023	Y-741U
0250202024	Y-927R
0250202025	Y-730U
0250202026	Y-929U
0250202028	Y-504R
0250202029	Y-745U
0250202032	Y-504R
0250202033	Y-935U
0250202034	Y-928U
0250202035	Y-506R
0250202036	Y-534J
0250202040	Y-729U
0250202041	Y-746R
0250202042	Y-748U
0250202043	Y-523J
0250202051	Y-146R
0250202054	Y-118R
0250202058	Y-147T
0250202064	Y-755RS
0250202065	Y-904M1
0250202069	Y-112M1



<b>BOSCH</b>	<b>→ NGK</b>
0250202069	Y-162R1
0250202071	Y-181T
0250202076	Y-197R
0250202077	Y-705RS
0250202085	Y-710J
0250202085	Y-742U
0250202086	Y-307R
0250202086	Y-306R
0250202087	Y-711J
0250202089	Y-701R
0250202089	Y-701J
0250202092	Y-733J
0250202093	Y-712RS
0250202094	Y-115T1
0250202094	Y-707RS
0250202094	Y-733J
0250202094	Y-722J
0250202094	Y-733J
0250202095	Y-703R
0250202095	Y-532J
0250202096	Y-715R
0250202096	Y-118T1
0250202097	Y-197T
0250202102	Y-501U
0250202103	Y-507R
0250202107	Y-157R
0250202110	Y-112T
0250202119	Y-178T
0250202125	Y-531J
0250202128	Y-517J
0250202129	Y-516J
0250202131	Y-524J
0250203001	YE07
0250203002	YE06
0250203004	YE12
0250204001	YE04
0250312001	CY51
0250312002	CY52
0250312003	CY53
0250312007	CY57
0250402002	Y-547AS
<b>BRISK</b>	<b>→ NGK</b>
21N01	Y-204TS
21N21	Y-208T
21N22	Y-208T
21N51	Y-909R
21R01	Y-901R
21R02	Y-907R
21R06	Y-918R
21R21	Y-902R
21R22	Y-908R

<b>BRISK</b>	<b>→ NGK</b>
21R23	Y-902R
21R26	Y-913M
21R51	Y-909R
21R71	Y-910R
21R71	Y-911R
41N71	Y-403T
81P71	Y-810
81P71	Y-811
<b>CASE</b>	<b>→ NGK</b>
MM 431439	Y-142T
<b>CATERPILLAR/MITSUBIS</b>	<b>→ NGK</b>
3S9624X	Y-171
4N360X	Y-159
9N194X	Y-109
<b>CHAMPION</b>	<b>→ NGK</b>
AG32	Y-302
AG44	Y-811
CH 32/002	Y-302
CH 44	Y-811
CH 60/002	Y-207T
CH 61/002	DG-237
CH 63/002	Y-208T
CH 63/003	Y-208T
CH 64/002	Y-404
CH 65/002	Y-810
CH 66/002	Y-403T
CH 68/002	Y-902R
CH 68/002	Y-523J
CH 69/002	Y-901R
CH 70/002	Y-909R
CH 79/002	Y-907R
CH 87/002	Y-208T
CH 88	Y-902R
CH 90/002	Y-739R
CH 94/002	Y-115T1
CH 95/002	Y-146R
CH 95/002	Y-703R
CH 96/002	Y-204RS
CH 97/002	Y-107R
CH 98/002	Y-117RS
CH 99/002	Y-117SS
CH101/002	Y-115R1
CH102/002	Y-112M1
CH103/002	Y-118T1
CH103/002	Y-118T1
CH104/002	Y-197R
CH105/002	Y-204SS
CH110/002	Y-104R
CH121/002	Y-118T1



<b>CHAMPION</b>	<b>→ NGK</b>
CH137/002	Y-908R
CH147/002	Y-910R
CH154/002	Y-715R
CH158/002	Y-711J
CH159/002	Y-917U
CH160/002	Y-918R
CH161/002	Y-755RS
CH162/002	Y-707RS
CH163/002	Y-405
CH163/002	Y-923U
CH166/002	Y-747U
CH167/002	Y-928U
CH169/002	Y-730U
CH170/002	Y-504R
CH171/002	Y-732U
CH172/002	Y-740U
CH173/002	Y-913M
CH174/002	Y-914U
CH175/002	Y-930U
CH176/002	Y-916R
CH177/002	Y-925R
CH178/002	Y-729U
CH179/002	Y-932R
CH181/002	Y-741U
CH184/002	Y-515J
CH185/002	Y-503R
CH189/002	Y-938R
CH196/002	Y-524J
CH203/002	Y-507R
CH204/002	Y-929U
CH205/002	Y-937R
CH206/002	Y-927R
CH207/002	Y-748U
CH208/002	Y-738U
CH215/002	Y-501U
CH216/002	Y-502R
CH217/002	Y-506R
CH218/002	Y-745U
CH219/002	Y-746R
CH223002	YE06
CH224002	YE07
CH600/002	CY52
CH601/002	CY53
CH602/002	CY57
<b>CITROEN</b>	<b>→ NGK</b>
5960..A0	YE08
5960.19	YE04
596077	YE12
596079	YE05
5962.2Z	Y-503R
5962.5A	Y-739R

<b>CITROEN</b>	<b>→ NGK</b>
95493206	Y-208T
95534788	Y-208T
HG2621	Y-810
5960.79	YE05
<b>DAIHATSU</b>	<b>→ NGK</b>
19850-54030-000	Y-118T
19850-54050-000	Y-118R
19850-54070-000	* only O/E
19850-54071-000	Y-146R
19850-54090-000	Y-715R
19850-56010-000	Y-178
19850-56012-000	Y-178T
19850-58030-000	Y-128T
19850-58040-000	Y-178T
19850-64010-000	Y-146R
19850-64020-000	Y-703R
19850-68010-000	Y-147T
19850-68040-000	Y-178T
19850-68060-000	Y-197R
19850-87303-000	Y-108
19850-87309-000	Y-128T
19850-87311-000	Y-178TS1
19850-87312-000	Y-178TS2
19850-87701-000	Y-146R
19850-87702-000	Y-703R
19850-87703-000	* only O/E
<b>DENSO</b>	<b>→ NGK</b>
067100-0160	DG-211
067100-1042	Y-402-2
067100-1043	Y-452-1
067100-1070	Y-176
067100-1071	Y-176
067100-1090	Y-108
067100-1120	Y-178
067100-1130	Y-128
067100-1161	Y-178T
067100-1170	Y-128T
067100-1171	Y-128T
067100-1270	Y-118T1
067100-1330	Y-147T
067100-1340	Y-197T
067100-1350	Y-128T
067100-1360	Y-178T
067100-1370	Y-118R
067100-1380	Y-168R
067100-1430	Y-146R
067100-1460	Y-197R
067100-1530	Y-146R
067100-1630	Y-118T1
DG001	Y-924J

\* only by car dealer



<b>DENSO</b>	<b>→ NGK</b>
DG002	Y-204TS
DG002	Y-918R
DG003	Y-503J
DG003	Y-731U
DG004	Y-910R
DG005	Y-732U
DG006	Y-913M
DG007	Y-937R
DG008	Y-506R
DG009	Y-927R
DG010	Y-916R
DG101	Y-730U
DG101	Y-740U
DG102	Y-928U
DG103	Y-932R
DG104	Y-711RS
DG105	Y-722J
DG105	Y-115T1
DG106	Y-925R
DG110	Y-929U
DG111	Y-502R
DG113	YE04
DG115	Y-729U
DG116	Y-504R
DG117	Y-925U
DG118	Y-748U
DG119	Y-930U
DG120	Y-707RS
DG123	Y-907R
DG124	Y-710R
DG126	Y-517J
DG127	Y-747U
DG137	Y-712RS
DG143	Y104R
DG144	Y-732U
DG145	Y-507R
DG146	Y-701J
DG155	Y-746R
DG159	Y-307R
DG161	Y-923U
DG170	YE07
DG171	YE06
DG202	Y-909R
DG211	Y-715R
DG214	Y-532J
DG215	Y-118R
DG216	Y-703R
DG221	Y-118T1
DG222	Y-197R
DG223	Y-146R
DG232	Y-147T
DG233	Y-197T

<b>DENSO</b>	<b>→ NGK</b>
DG234	Y-128T
DG235	Y-178T
DG239	Y-168R
DG240	Y-542J
DG245	Y-531J
DG300	CY53
DG301	CY57
DG302	CZ22
DG304	CY52
<b>EIKO</b>	
<b>→ NGK</b>	
GD-901	Y-108
GF-101	Y-175-2
GF-102	Y-201
GF-103	Y-274
GF-104	Y-172
GF-105	Y-172
GF-106	Y-102
GF-108	Y-251
GF-109	Y-251
GF-110	Y-180
GF-111	Y-802-2
GF-112	Y-115T1
GH-401	Y-173
GH-402	Y-176
GI-001	Y-874-1
GI-002	Y-808-1
GI-003	Y-104
GI-005	Y-104R
GI-006	Y-154R
GI-007	Y-154
GI-008	Y-271-2
GI-009	Y-154R
GM-501	Y-107T
GM-502	Y-107R
GM-503	Y-157R
GM-504	Y-172
GN-301	Y-803-1
GN-302	Y-103
GN-303	Y-103-2
GN-304	Y-202
GN-305	Y-252
GN-306	Y-112T
GN-307	Y-117-1
GN-308	Y-181T
GN-309	Y-204TS1
GN-310	Y-103-1
GN-311	Y-272R1
GT-201	Y-402-2
GT-202	Y-452-1
GT-203	Y-128
GT-204	Y-178



<b>EIKO</b>	<b>→ NGK</b>
GT-205	Y-118T
GT-207	Y-178T
GT-208	Y-128T
GT-211	DG-211
GT-212	Y-146R
<b>EUROCARB</b>	<b>→ NGK</b>
111	Y-918R
<b>FIAT</b>	<b>→ NGK</b>
46447610	Y-928U
46451951	Y-504R
46751764	Y-939J
46754154	Y-534J
46792359	YE07
46796050	YE06
500316493	Y-502R
60812292	Y-922R
60814613	Y-747U
71719015	Y-920R
7735920	Y-922R
9633214380	Y-938R
9638985980	Y-504R
98462492	Y-926U
<b>FORD</b>	<b>→ NGK</b>
4025139	Y-701J
<b>FUJI</b>	<b>→ NGK</b>
211-72802-00	Y-401-3
233-72801-00	Y-113V
<b>HINO</b>	<b>→ NGK</b>
191101040	Y-176
1985A56010	Y-178
1985A56012	Y-178T
1985A56022	Y-128T
1985A68060	Y-197R
6054330901	Y-173
6301330010	Y-176
<b>HKT</b>	<b>→ NGK</b>
CP-01	CY51
CP-02	CY52
PD-190	Y-146R
PD-191	Y-703R
PD-99	Y-108
PH-20	Y-173
PH-21	Y-176
PI-12	DG-200A-1
PI-13	DG-205
PI-40	Y-874-1

<b>HKT</b>	<b>→ NGK</b>
PI-41	Y-808-1
PI-42	Y-104
PI-43	Y-154
PI-44	Y-271-2
PI-46	Y-104R
PI-47	Y-154R
PI-48	Y-154RS
PI-49	Y-904M
PI-50	Y-954M
PI-57	Y-711RS
PI-58	Y-710R
PK-111	Y-159
PK-98	Y-171
PM-160	Y-274R
PM-161	Y-115R1
PM-60	Y-172
PM-61	Y-175-2
PM-61	Y-175S2
PM-62	Y-102
PM-63	Y-201
PM-64	Y-802-2
PM-65	Y-251
PM-66	Y-180
PM-71	Y-172
PM-73	Y-274
PM-75	Y-115T1
PM-78	Y-971M
PM-79	Y-114T
PN- 81	Y-103
PN- 82	Y-252
PN- 84	Y-202
PN- 85	Y-103-1
PN- 86	Y-103-2
PN- 87	Y-112T
PN- 88	Y-177-1
PN- 89	Y-204TS1
PN-120	Y-181T
PN-121	Y-204RS
PN-122	Y-202-2
PN-123	Y-112M1
PN-124	Y-162R1
PN-125	Y-272R1
PN-126	Y-117RS
PN-127	Y-117SS
PN-128	Y-112R1
PN-129	Y-204SS
PN-130	Y-272T
PN-131	Y-755RS
PN-132	Y-705RS
PN-133	Y-144SS
PN-134	Y-144RS
PN-135	Y-707RS



<b>HKT</b>	<b>→ NGK</b>
PN-136	Y-757RS
PN-137	Y-955RS
PN-138	Y-712RS
PS-201	Y-103V
PS-202	Y-106V
PS-204	Y-106-1
PS-206	YE01
PS-207	Y-709R
PS-209	Y-119V
PS-210	Y-702U
PT- 90	Y-402-2
PT- 93	Y-128
PT- 94	Y-178
PT-100	Y-128T
PT-101	Y-178T
PT-103	Y-118T1
PT-104	Y-128T
PT-107	Y-146R
PT-108	Y-197T
PT-109	Y-178T
PT-140	Y-118R
PT-141	Y-197R
PT-142	Y-168R
PT-144	Y-118T1
PT-145	Y-147T
PT-147	Y-146R
PT-150	Y-703R
PT-151	Y-715R
PZ-30	Y-107T
PZ-31	Y-157R
PZ-33	Y-107R
PZ-34	Y-122
<b>HONDA</b>	<b>→ NGK</b>
31800-706-000	YS101
31800-706-000	YS-101
ZA8-97044037-0	Y-719RS
<b>HYUNDAI</b>	<b>→ NGK</b>
36710-27000	Y-749J
36710-42000	Y-722J
36710-42020	Y-722J
36710-42500	CY57
36710-42510	CY57
<b>ISEKI</b>	<b>→ NGK</b>
6281-410-023-0A	Y-510R
<b>ISHIKAWAJIMA SHIBAU</b>	<b>→ NGK</b>
18536-6010	Y-401-3
18536-6020	Y-122
18536-6040	Y-107-1

<b>ISHIKAWAJIMA SHIBAU</b>	<b>→ NGK</b>
18536-6060	Y-107V
18536-6080	Y-107R
<b>ISUZU</b>	<b>→ NGK</b>
5-81410055-2	Y-154R
5-81410056-3	Y-154RS
5-81410057-2	Y-154R
5-81410058-3	Y-154RS
5-86101642-0	CY58
5-86101643-0	Y-712RS
5-86101644-0	Y-707RS
5-86115977-0	Y-757RS
5-86123110-0	CZ21
8-84402303-1	Y-711R
8-94135377-3	Y-954M1
8-94175158-0	Y-904M
8-94175158-1	Y-904M
8-94241449-0	Y-104R
8-94241449-1	Y-104R
8-94255588-0	Y-104R
8-94319700-1	Y-710R
8-94319700-2	Y-710R
8-94390777-2	Y-784M
8-94439218-1	Y-104R
8-94481972-0	Y-711RS
8-97028369-0	Y-718RS
8-97043744-0	Y-719R
8-97044037-0	Y-719RS
8-97047604-0	Y-954R
8-97073641-0	Y-904R
8-97080554-0	CY53
8-97106549-1	Y-720U
8-97126257-0	Y-778U
8-97166332-0	CX04
9-4175158	Y-904M1
9-82511945-0	Y-874-1
9-82511978-0	Y-104
9-82511978-1	Y-104
9-82511994-0	Y-874-1
9-82513928-2	Y-271-2
9-82513959-0	Y-154
<b>KIA</b>	<b>→ NGK</b>
OK04S-18140A	Y-721J
OK054 18140	Y-701J
36710-27010	Y-749J
36710-4A000	Y-508J
36710-4A100	Y-508J
<b>KOMATSU</b>	<b>→ NGK</b>
6004-50-4111	Y-872 S
6004-50-5001	YS-871T



<b>KOMATSU</b>	<b>→ NGK</b>
6008-15-2110	DG-183 F
6008-15-2180	DG-183 FH
6008-15-2310	Y-174S
6008-15-2320	Y-174S1
6008-15-2650	Y-174TS
6008-15-2660	Y-174TS1
<b>KUBOTA</b>	
	<b>→ NGK</b>
11000-4313-1	DG-235-1
15014-6551-1	DG-205
15101-6551-1	DG-220 A
15109-6559-1	Y-809-1
15204-6551-1	Y-110
15221-6551-3	Y-106-1
15231-6551-2	Y-107-1
15261-6551-2	Y-103K
15261-6551-4	Y-103K
15451-6551-1	Y-203
15521-6551-0	Y-106V
15521-6551-1	Y-106
15521-6551-2	Y-106V
15571-6551-1	Y-203V
15571-6551-2	Y-203V
15694-6551-2	Y-702R
15806-6551-2	Y-706R
15806-6551-3	Y-706R
15951-6551-1	Y-103V
15951-6551-2	Y-103V
15951-6551-3	Y-103V
16241-6551-1	Y-709R
16241-6551-2	Y-709R
16292-6551-1	Y-709RS
16415-6551-1	Y-713R
16665-6551-2	Y-766MS
16851-6551-0	YE01
16851-6551-2	YE01
17331-6551-1	Y-119V
17529-6551-1	YA01
19077-6551-1	Y-716RS
19077-6551-3	Y-716RS
19215-6551-1	Y-149
19215-6551-3	Y-149
19821-6551-1	Y-301V
19872-6551-1	Y-756M
19883-6551-1	Y-752M
8412	Y-103K
YF04 / 95Y4	Y-E01
<b>KYATAPIRA</b>	
	<b>→ NGK</b>
9N-0194	Y-108

<b>LUCAS</b>	<b>→ NGK</b>
DS001	Y-902R
DS002	Y-901R
DS003	Y-902R
DS006	Y-208T
DS101	DG-237
HDS217	Y-901R
HDS218	Y-907R
HDS218	Y-902R
HDS220	Y-403T
HDS221	Y-206T
HDS221	Y-208T
HDS224	Y-405
HDS225	Y-810
HDS225	Y-908R
HDS226	Y-204
HDS226	Y-404
HDS227	Y-302
HDS230	Y-117RS
HDS231	Y-204RS
HDS232	Y-115T
HDS232	Y-115T1
HDS233	Y-146R
HDS234	Y-118T
HDS235	Y-118R
HDS236	Y-178
HDS237	Y-197T
HDS238	Y-178T
HDS239	Y-112M1
HDS240	Y-162R1
HDS241	Y-107R
HDS242	Y-197R
HDS243	Y-112T
HDS244	Y-157R
HDS245	Y-128T
HDS246	Y-181T
HDS247	Y-104R
HDS248	Y-103K
HDS248	Y-103
HDS249	Y-104
HDS250	Y-251
HDS250	Y-160
HDS251	Y-203
HDS252	Y-128
HDS253	Y-117SS
HDS254	Y-204SS
HDS256	Y-103-1
HDS256	Y-301-1
HDS257	Y-103-2
HDS258	Y-204TS1
HDS259	Y-144RS
HDS262	Y-128T
HDS262	Y-715R



<b>LUCAS</b>	<b>→ NGK</b>
HDS267	Y-909R
HDS268	Y-147T
HDS269	Y-274
HDS270	Y-115R1
HDS272	Y-107T
HDS273	Y-910R
HDS275	Y-703R
HDS276	Y-707RS
HDS280	Y-112R1
HDS282	Y-108
HDS283	Y-705RS
HDS284	Y-168R
HDS291	Y-177-1
HDS294	Y-757RS
HDS295	Y-920R
HDS316	DG-237
HDS337	Y-907R
HDS338	Y-711R
HDS339	Y-911R
HDS340	Y-755RS
HDS343	Y-204V
HDS343	Y-207TS
HDS343	Y-207T
HDS343	Y-901R
HDS345	Y-710R
HDS346	Y-711RS
HDS347	Y-913M
<b>MARELLI → NGK</b>	
TIX1A	Y-207T
TIX2A	Y-208T
TIX4A	Y-208T
TIX6A	Y-208T
UX1A	Y-901R
UX2A	Y-902R
UX4A	Y-902R
<b>MAZDA → NGK</b>	
1353-18140A	Y-107T
1456-18101A	YD-802
1456-18101B(1456-18-101C)	YD-803
1470-18101	YD-802B
1470-18101A	YD-803B
1N01-18601A	CY51
1N02-18601	CY52
4869-18140	Y-122
4869-18140A	Y-122
R2L2-18601	Y-721RS
RF2A-18-601	Y-529J
RFG1-18601	Y-701J
RFJ5-18601	Y-701R
S201-18140	Y-107R

<b>MAZDA</b>	<b>→ NGK</b>
S210-18140	Y-701J
S501-18140A	Y-107R
SE01-18140A	Y-157R
SEM1 18601	Y-771R
US01-18601	Y-721R
VS01-18601	Y-721RS
WL03-18601	Y-701J
WLE7-18601	CZ27
Y701-18601	CY53
<b>MCC → NGK</b>	
0004562V003000000	Y-543J
A0011594610	YE13
<b>MERCEDES → NGK</b>	
000 159 61 01	DG-237
000 159 81 01	Y-902R
001 159 15 01	Y-930U
001 159 20 01	Y-925R
001 159 21 01	Y-925R
001 159 26 01	Y-929U
001 159 27 01	Y-746R
001 159 28 01	Y-745U
001 159 35 01	Y-923U
001 159 36 01	Y-916R
<b>MITSUBISHI → NGK</b>	
30666-57301	Y-114T
30L66-00300	Y-723R
30L66-00301	Y-723R
30L66-00302	Y-723R
30L66-00400	Y-723U
30L66-00400	Y-723U
30L66-00401	Y-723U
30L66-00402	Y-723U
31366-02100	Y-251
31366-02109	Y-251
31366-14300	Y-201
31366-14301	Y-201
31366-14302	Y-201
31366-14701	Y-251
31A66-03100	Y-701U
32A66-07200	Y-954M1
34466-21301	Y-182T
34466-31301	Y-182T1
36710-42500	CY57
M 816 732	Y-932R
MD 014 997	Y-115R1
MD 050 212	Y-115T1
MD 050 212	Y-115T1
MD 077167	Y-707RS
MD 092 392	---





<b>MITSUBISHI</b>	<b>→ NGK</b>
MD 197 511	CY57
MD 301 950	Y-733J
MD 344 469	Y-733J
MD 344 469	Y-733J
ME 007 649	---
ME 017 009	Y-274R
ME 017 010	Y-274
ME 017 013	Y-274
ME 017 057	Y-971M
ME 200 970	CY55
ME 200 970	CY55
ME 201 638	CY55
ME 201 638	CY55
ME 202 785	---
ME 203 539	Y-532J
ME 203 754	CY55
ME 215 093	Y-737M
MM 105 560	Y-251
MM 401 621	Y-110
MM 432 148	Y-145T
MN960270	YE13
MR 577 131	Y-733J
<b>MITSUBISHI HEAVY INDUSTRIES → NGK</b>	
30666-57301	Y-114T
30L66-00300	Y-723R
317110-0(317110)	DG-200A
31A66-03200	Y-724U
32A66-07100	Y-904M
32A66-07200	Y-954M
3446621300	Y-182T
3446631301	Y-182T1
91304-04300	Y-701R
EE96001	Y-173
EE96002	Y-104
EE96032	YD-451B
EE96039	Y-154
EE96609	YD-471
JP9407362	Y-856
K417120	Y-801
K417131-3	Y-802-2
K417133-1	Y-806
K4171363	Y-852-2
K6571330	Y-826
K657134-2	Y-876-2
K9670240	Y-201
MD050212	Y-115T1
MM401625	Y-160
MM409510(3066657301)	Y-114T
MM431439	Y-142T
MM432148	Y-145T
MM435172	Y-195

<b>MITSUBISHI HEAVY INDUSTRIES</b>	<b>→ NGK</b>
NM105560(3176601100)	Y-251
<b>MOTORCRAFT → NGK</b>	
1 037 204	Y-732U
1 056 857	Y-937R
1 079 401	Y-524J
1 096 527	Y-525J
1 148 105	YE04
1 690 048	Y-741U
1148105	YE04
2S6Q 6M090 AA	YE04
3 252 725	Y-107R
4 025 139	Y-701J
5 023 372	Y-208T
5 031 006	Y-923U
6 132 246	Y-907R
6 154 593	Y-902R
7 088 988	Y-910R
84BB 6M090 AA	Y-902R
84FF 6M090 B2A	Y-907R
93 FF 6M090 AA	Y-910R
95VW 6M090 AB	Y-732U
96FF 6M090 CA	Y-937R
EZD 1	Y-810
EZD 5	Y-902R
EZD10	Y-901R
EZD18	Y-115T1
EZD19	Y-128T
EZD20	Y-117RS
EZD21	Y-118T1
EZD22	Y-107T
EZD24	Y-104R
EZD30	Y-923
EZD30	Y-923U
EZD30	Y-924J
EZD40	YE04
EZD41	Y-504R
EZD41	Y-504R
V94DX 6M090 AA	Y-923U
V95DD 6M090 AA	Y-741U
XM34 12A342 BA	Y-701J
XS4U 6M090 AB	Y-524J
XS7U 6M090 BA	Y-525J



<b>NISSAN</b>	<b>→ NGK</b>
11065-02T00	Y-955RS
11065-0W801	CY08
11065-10G00	Y-705RS
11065-10T01	Y-757RS
11065-16A00	Y-117SS
11065-16A01	Y-144SS
11065-16A05	Y-117RS
11065-16A06	Y-144RS
11065-16A10	Y-117SS
11065-16A11	Y-144SS
11065-16A15	Y-117RS
11065-16A16	Y-144RS
11065-29W00	Y-112RS1
11065-2W202	CZ21
11065-2W204	CZ21
11065-31N00	Y-712RS
11065-31W00	Y-112T
11065-31W01	Y-112T
11065-31W02	Y-112TS
11065-34W00	Y-112M1
11065-37501	Y-803
11065-37503	Y-805
11065-37506	Y-103
11065-37507	Y-103
11065-43G01	Y-707RS
11065-51N00	Y-762RS
11065-57J00	CY52
11065-5C900	CY52
11065-63G00	Y-707RS
11065-65N01	CY58
11065-7C000	Y-530J
11065-89TA1	Y-954M1
11065-89TA2	Y-719R
11065-89TA6	Y-784M
11065-9C600	Y-712RS
11065-AD200	Y-519J
11065-C0300	Y-177
11065-C8600	Y-755RS
11065-D2800	Y-120RS
11065-DB000	Y-522J
11065-G2400	Y-712RS
11065-G2460	Y-712RS
11065-G5501	CY51
11065-HC200	Y-701R
11065-HC251	Y-721RS
11065-J2000	Y-202
11065-J5500	Y-202-1
11065-J5501	Y-202-2
11065-J5502	Y-202-2
11065-J5503	Y-252-1
11065-J5504	Y-252-1
11065-J5570	Y-222T

<b>NISSAN</b>	<b>→ NGK</b>
11065-J6500	Y-272T
11065-K6700	Y-160
11065-0W801	CY58
11065-Q4000	Y-103-2A
11065-Q4001	Y-112T1
11065-T3400	Y-177-1
11065-T3401	Y-177-1
11065-T3470	Y-181T
11065-T8200	Y-112R1
11065-T8201	Y-162R1
11065-T8202	Y-112R1
11065-T8203	Y-162R1
11065-T9000	Y-272R1
11065-T9001	Y-272R1
11065-V0700	Y-204TS1
11065-V0710	Y-204TS1
11065-V7202	CX51
11065-V7203	CZ51
11065-VC700	Y-712JS
11065-W2500	Y-204RS
11065-W2510	Y-204RS
11065-W3400	Y-204SS
11065-W3410	Y-204SS
11065-Y1400	Y-103-1
11065-Y1401	Y-103-1
11065-Y1402	Y-103-2
11065-Y1403	Y-103-2
11065-Y1404	Y-103-2
11065-Z5000	Y-252
8200012099	Y-517J
RFJ518 601	Y-701R
<b>OPEL</b>	<b>→ NGK</b>
12 14 311	Y-710J
1214032	YE06
1214034	YE07
1214300	Y-810
1214301	*
1214302	Y-403-1
1214303	Y-403T
1214304	Y-208T
1214305	Y-523J
1214308	Y-306R
1214309	Y-307R
1214310	Y-719RS1
1214311	Y-742U
1214315	Y-719RS
1214316	CY53
1214319	Y-924U
1214321	Y-904M
1214324	Y-917U
1214427	Y-741U



<b>OPEL</b>	<b>→ NGK</b>
1214457	Y-748U
4403145	Y-935U
90093897	Y-208T
93178047	YE06
93178411	YE07
94133759	Y-904M1
94481972	Y-719RS1
97044037	Y-719RS1
97080554	CY53
<b>Opel (CZ22)</b>	<b>→ NGK</b>
1214301	Y-541J
<b>PEUGEOT</b>	<b>→ NGK</b>
5960.12	YE04
5960.99	YE08
596076	YE12
596078	YE05
5961.16	Y-404
596122	Y-810
596135	Y-810
596139	Y-902R
596153	Y-208T
596154	Y-208T
596158	Y-208T
5962.03	Y-503R
5962.1Q	Y-738U
5962.2Y	Y-731U
5962.3C	Y-504R
5962.3H	Y-938R
5962.J3	Y-911R
5962.T1	Y-911R
5962.T2	Y-933R
7932565882	Y-810
7932567718	Y-208T
9150860280	Y-902R
9190861080	Y-902R
<b>PROTON</b>	<b>→ NGK</b>
MD 197511	Y-733J
MD197511	CY57
<b>RENAULT</b>	<b>→ NGK</b>
08 54 997 100	Y-810
50 01 001 587	Y-208T
77 00 100 558	Y-506R
77 00 100 586	Y-740U
77 00 100 635	Y-516J
77 00 105 290	Y-927R
77 00 111 323	Y-515J
77 00 662 199	Y-208T
77 00 733 076	Y-908R

<b>RENAULT</b>	<b>→ NGK</b>
77 00 741 144	Y-902R
77 00 855 865	Y-913M
77 00 856 238	Y-913M
77 00 856 292	Y-933R
77 00 861 906	Y-730U
77 01 039 387	Y-914U
77 01 349 475	Y-902R
7701057806	CZ24
82 00 012 099	Y-517J
82 00 090 817	Y-913M
8200546885	CZ24
<b>ROVER</b>	<b>→ NGK</b>
ETC8847	Y-729U
<b>SUZUKI</b>	<b>→ NGK</b>
09900-F8Q01	Y-516J
09900-RF001	Y-701R
<b>TOYOTA</b>	<b>→ NGK</b>
19850-0W010	Y-542J
19850-27010	Y-531J
19850-30010	Y-531J
19850-54030	Y-118T1
19850-54031	Y-118T1
19850-54050	Y-118R
19850-54060	Y-168R
19850-54070	*
19850-54071	*
19850-54090	Y-715R
19850-56012	Y-178T
19850-56021	Y-128T
19850-56022	Y-128T
19850-64010	Y-146R
19850-64020	Y-703R
19850-64031	Y-532J
19850-64040	*
19850-64050	Y-532J
19850-68010	Y-147T
19850-68020	Y-197T
19850-68030	Y-128T
19850-68040	Y-178T
19850-68060	Y-197R
<b>VOLVO</b>	<b>→ NGK</b>
8631607	YE12
<b>VW</b>	<b>→ NGK</b>
059 963 319 A	Y-501U
N 101 401 04	Y-732U
N 102 130 01	Y-918R
N 102 130 02	Y-918R

\* only by car dealer





<b>A6</b>	AUTOUNION, DELAHAYE, FSM, LLOYD
<b>A7</b>	ALLARD, AUTOUNION, DKW, GLAS
<b>A8</b>	MESSERSCHMITT, MESSERSCHMITT FMR
<b>AP6FS</b>	FORD
<b>APR6FS</b>	FORD
<b>B10EG</b>	ABARTH
<b>B4</b>	CITROEN
<b>B4L</b>	CITROEN
<b>B5ES</b>	LAND ROVER, VW
<b>B5HS</b>	ALVIS, MERCEDES, RENAULT, ROSENGART, UAZ, VW
<b>B6EFS</b>	JAGUAR
<b>B6ES</b>	ALFA ROMEO, ALLARD, ARMSTRONG SIDDELEY, BENTLEY, GLAS, LANCIA, LAND ROVER, MG, NSU, PANHARD, ROLLS ROYCE, ROVER, VW, ROVER
<b>B6HS</b>	A.C.BRISTOL, ABARTH, BARKAS, BORGWARD, CITROEN, DAF, FORD, LLOYD, NSU-FIAT, OPEL, PEUGEOT, RENAULT, VW, WARTBURG AWE
<b>B6S</b>	BEDFORD, OPEL, RENAULT, VOLVO
<b>B7ECS</b>	TVR
<b>B7ES</b>	ALFA ROMEO, AUDI, BMW, FIAT, LANCIA, NSU, PANHARD
<b>B7HS</b>	AUTOBIANCHI, BMW, BORGWARD, CITROEN, FIAT, NSU, NSU-FIAT, PORSCHE, RENAULT, STEYR
<b>B7S</b>	VOLVO
<b>B8ECS</b>	CATERHAM
<b>B8EFS</b>	RENAULT
<b>B8EG</b>	RENAULT



<b>B8EGV</b>	PORSCHE
<b>B8ES</b>	ABARTH, BMW, JAGUAR, LANCIA
<b>B8EVX</b>	ALPINE, LAMBORGHINI, RENAULT
<b>B8HS</b>	BMW
<b>B95EGP</b>	RENAULT
<b>B95EGV</b>	RENAULT
<b>B9EG</b>	RENAULT
<b>B9EVX</b>	PORSCHE
<b>BCP5ES</b>	CITROEN, DAEWOO, MERCEDES, NISSAN, PEUGEOT, RENAULT, SSANGYONG
<b>BCP5EVX</b>	SAAB
<b>BCP6ES</b>	ALFA ROMEO, CITROEN, LADA (AVTOVAZ), MERCEDES, NISSAN, PEUGEOT, ROVER
<b>BCP6ES-11</b>	NISSAN
<b>BCP6ET</b>	CITROEN, PEUGEOT, RENAULT
<b>BCP6EVX</b>	SAAB
<b>BCP7ES</b>	SEAT
<b>BCP7ET</b>	AUDI, VW
<b>BCP7EVX</b>	SAAB
<b>BCPR5EP-11</b>	TOYOTA
<b>BCPR5EP-8</b>	TOYOTA
<b>BCPR5ES</b>	CITROEN, PEUGEOT, RENAULT, SKODA
<b>BCPR5ES-11</b>	NISSAN
<b>BCPR5ES-11 + BCPR6ES-11</b>	NISSAN
<b>BCPR5EY</b>	TOYOTA
<b>BCPR6E</b>	MAZDA, VOLVO



<b>BCPR6E-11</b>	HONDA, MAZDA, NISSAN, ROVER
<b>BCPR6EP-11</b>	TOYOTA
<b>BCPR6EP-13</b>	TOYOTA
<b>BCPR6ES</b>	AUTOBIANCHI, CHRYSLER, CITROEN, DAIMLER, FIAT, FORD, JAGUAR, LADA (AVTOVAZ), LANCIA, MORGAN, NISSAN, PEUGEOT, ROVER, TVR, VOLVO
<b>BCPR6ES-11</b>	FORD, LADA (AVTOVAZ), NISSAN, SAAB
<b>BCPR6ET</b>	CITROEN, LANCIA, PEUGEOT, RENAULT, VOLVO
<b>BCPR6EY</b>	TOYOTA
<b>BCPR6EY-11</b>	TOYOTA
<b>BCPR6EYN-11</b>	HONDA
<b>BCPR7ES</b>	ASTON MARTIN, CATERHAM, FIAT, FORD, LANCIA, SAAB, VOLVO
<b>BCPR7ES-11</b>	FORD, SAAB
<b>BCPR7ET</b>	FIAT, PORSCHE
<b>BCR8ES</b>	ASTON MARTIN, FORD
<b>BCRE527Y</b>	TOYOTA
<b>BK5ESZ</b>	RENAULT
<b>BK6E</b>	MINISUBISHI
<b>BKR4EVX</b>	BENTLEY, ROLLS ROYCE
<b>BKR5E</b>	KIA, MAZDA, NISSAN, VW
<b>BKR5E-11</b>	CHRYSLER, HYUNDAI, MAZDA, MITSUBISHI, NISSAN, SUBARU
<b>BKR5EIX</b>	SSANGYONG
<b>BKR5EK</b>	CHEVROLET, CITROEN, DAEWOO, OPEL, PEUGEOT, RENAULT, SAAB, TOFAS / FIAT, VAUXHALL
<b>BKR5EKB-11</b>	TOYOTA
<b>BKR5EKC</b>	DAIHATSU, PERODUA



<b>BKR5EKU</b>	MERCEDES, VW
<b>BKR5EKUP</b>	FORD, SEAT, VW
<b>BKR5EP-11</b>	LEXUS, TOYOTA
<b>BKR5EQUPA</b>	OPEL, VAUXHALL
<b>BKR5ES</b>	KIA
<b>BKR5ES-11</b>	HYUNDAI, KIA
<b>BKR5EVX</b>	BENTLEY, RENAULT, ROLLS ROYCE, VW
<b>BKR5EVXA-13</b>	DAIMLER, JAGUAR
<b>BKR5EY</b>	NISSAN
<b>BKR5EY-11</b>	NISSAN
<b>BKR5EYA</b>	TOYOTA
<b>BKR5EYA-11</b>	TOYOTA
<b>BKR5EZ</b>	CITROEN, FIAT, LANCIA, RENAULT, TOFAS / FIAT
<b>BKR6E</b>	AUDI, CATERHAM, CHRYSLER, DACIA, DAIHATSU, KIA, LADA (AVTOVAZ), NISSAN, RENAULT, ROVER, SUZUKI, VW
<b>BKR6E-11</b>	CHEVROLET, DAEWOO, DAHATSU, HONDA, ISUZU, KIA, MAZDA, MITSUBISHI, NISSAN, PROTON, SUBARU, SUZUKI
<b>BKR6EIX-LPG</b>	OPEL
<b>BKR6EK</b>	ALPINA, BMW, CITROEN, OPEL, PEUGEOT, PORSCHE, RENAULT, LANCIA, VAUXHALL
<b>BKR6EKB-11</b>	TOYOTA
<b>BKR6EKC</b>	FIAT, LANCIA, TOFAS / FIAT
<b>BKR6EKE</b>	SMART
<b>BKR6EKPA</b>	ALFA ROMEO
<b>BKR6EKPA+ PMR7A</b>	ALFA ROMEO



<b>BKR6EKP-11</b>	LEXUS, TOYOTA
<b>BKR6EKUB</b>	AUDI, SKODA, VOLVO, VW
<b>BKR6EKUE</b>	VW
<b>BKR6EN-11</b>	HONDA
<b>BKR6EP-11</b>	LEXUS, TOYOTA
<b>BKR6EP-13</b>	TOYOTA
<b>BKR6EP-8</b>	TOYOTA
<b>BKR6EQUA</b>	AUDI, VW
<b>BKR6EQUP</b>	ALPINA, AUDI, BENTLEY, BMW, MINI, PORSCHE, ROLLS ROYCE, VAUXHALL
<b>BKR6ES</b>	HYUNDAI, PEUGEOT, RENAULT, ROVER, SKODA, VOLVO
<b>BKR6ES-11</b>	KIA
<b>BKR6ETA-10</b>	SEAT, SKODA
<b>BKR6EVX</b>	SUBARU, VOLVO
<b>BKR6EVX-11</b>	DODGE, FORD
<b>BKR6EVXA-11</b>	JAGUAR
<b>BKR6EVXA-13</b>	JAGUAR
<b>BKR6EY</b>	NISSAN
<b>BKR6EYA</b>	LEXUS, TOYOTA
<b>BKR6EYA-11</b>	TOYOTA
<b>BKR6EZ</b>	CITROEN, FIAT, LANCIA, PEUGEOT, RENAULT, TOFAS / FIAT
<b>BKR6EZB</b>	MERCEDES
<b>BKR7E</b>	LOTUS, VOLVO
<b>BKR7EN-11</b>	HONDA
<b>BKR7EQUP</b>	PORSCHE
<b>BKR7EVX</b>	LDV, VOLVO



<b>BKR7EVX-11</b>	FORD
<b>BKUR5ET</b>	MERCEDES, SEAT, VW
<b>BKUR5ET-10</b>	AUDI, MERCEDES, SEAT, SKODA
<b>BKUR6EK</b>	DAIHATSU
<b>BKUR6ET</b>	SEAT
<b>BKUR6ET-10</b>	AUDI, MERCEDES, SEAT, SKODA, VW
<b>BKUR6ETB</b>	CHEVROLET, LANCIA
<b>BKUR6ETB-10</b>	DAIHATSU
<b>BKUR7ET</b>	AUDI, PEUGEOT, RENAULT, SEAT, VW
<b>BP5E</b>	JAGUAR, LAND ROVER, VOLVO
<b>BP5EFS</b>	MERCEDES, ROVER
<b>BP5ES</b>	AUSTIN, BMW, DAIMLER, HYUNDAI, JAGUAR, LAND ROVER, MITSUBISHI, NISSAN, PANTHER, PEUGEOT, RENAULT, ROLLS ROYCE, ROVER, TRIUMPH, VW
<b>BP5ES-11</b>	ISUZU
<b>BP5ESZ</b>	RENAULT
<b>BP5ET</b>	SEAT
<b>BP5EY</b>	DAIHATSU, TOYOTA
<b>BP5HS</b>	MG, ROVER
<b>BP6EF</b>	AUSTIN, LEYLAND DAF
<b>BP6EFS</b>	CITROEN, MERCEDES, PEUGEOT, RENAULT, ROVER, TALBOT
<b>BP6ES</b>	ALFA ROMEO, ASTON MARTIN, AUDI, AUSTIN, AZLK (MOSKWITCZ), BEDFORD, BMW, BOND, CITROEN, FIAT, FISSORE, FORD, FSO, GLAS, INNOCENTI, ISUZU, KIA, LADA (AVTOVAZ), LANCIA, LAND ROVER, LEYLAND DAF, LOTUS, MASERATI, MATRA, MERCEDES, MG, MITSUBISHI, MORGAN, NISSAN, PEUGEOT, RENAULT, ROVER, SAAB, SEAT, TALBOT, TOFAS, TRIUMPH, VAUXHALL, VOLVO, VW, YUGO, Z.A.Z., ZASTAVA



<b>BP6ES-11</b>	HYUNDAI, MITSUBISHI
<b>BP6ESZ</b>	AUDI, RENAULT, VW
<b>BP6ET</b>	FIAT, FSO, LANCIA
<b>BP6FS</b>	VAUXHALL
<b>BP6HS</b>	CITROEN, DACIA, DAF, FORD, GAZ (VOLGA), MERCEDES, OPEL, RENAULT, SKODA, TALBOT, TRIUMPH, VAUXHALL, VOLVO, Z.A.Z., ZASTAVA
<b>BP6S</b>	MONTEVERDI
<b>BP7EFS</b>	CITROEN, PEUGEOT, RENAULT, SKODA, VOLVO
<b>BP7EFVX</b>	RENAULT, VENTURI
<b>BP7ES</b>	ALFA ROMEO, AUDI, AZLK (MOSKWICZ), CATERHAM, DAIMLER, FERRARI, FIAT, JAGUAR, LANCIA, LOTUS, MERCEDES, MOSKWICZ, PEUGEOT, RENAULT, SAAB, SEAT, TALBOT, VW
<b>BP7EVX</b>	AUDI, LAMBORGHINI, PORSCHE
<b>BP7HS</b>	FORD, PORSCHE, SKODA, VOLVO
<b>BP8ES</b>	ABARTH, ALFA ROMEO, LANCIA, MASERATI, MATRA
<b>BP8EVX</b>	ALFA ROMEO, FERRARI, LAMBORGHINI, MASERATI, MERCEDES, PORSCHE
<b>BPR4EVX</b>	BENTLEY, ROLLS ROYCE
<b>BPR4EY</b>	TOYOTA
<b>BPR4FS-11</b>	PONTIAC
<b>BPR5E</b>	NISSAN, VOLVO
<b>BPR5EA-L</b>	DAIHATSU, TOYOTA
<b>BPR5EFS-13</b>	CADILLAC, PONTIAC
<b>BPR5EKU</b>	AUDI, VW
<b>BPR5EP-11</b>	TOYOTA



<b>BPR5ES</b>	BENTLEY, BRISTOL, DAEWOO, DAIHATSU, FIAT, GAZ (VOLGA), HONDA, INNOCENTI, MAZDA, MITSUBISHI, NISSAN, OPEL, PROTON, RELIANT, RENAULT, ROLLS ROYCE, ROVER, SEAT, SUZUKI, TOYOTA, UAZ, VAUXHALL, VOLVO
<b>BPR5ES-11</b>	CHRYSLER, DAEWOO, HYUNDAI, ISUZU, KIA, MAZDA, MITSUBISHI, NISSAN, PROTON
<b>BPR5EV</b>	ASTON MARTIN, BENTLEY, ROLLS ROYCE
<b>BPR5EVX-11</b>	DODGE
<b>BPR5EY</b>	DAIHATSU, INNOCENTI, LUBLIN (Daewoo), SUZUKI, TOYOTA
<b>BPR5EY-11</b>	CHEVROLET, DAEWOO, DAIHATSU, HONDA, KIA, TOYOTA, VW
<b>BPR5FS-11</b>	AC
<b>BPR6E</b>	ALFA ROMEO
<b>BPR6EFS</b>	FORD, TVR, VOLVO
<b>BPR6EKN</b>	DAIHATSU, LOTUS
<b>BPR6ES</b>	AUSTIN, AUTOBIANCHI, BEDFORD, BMW, CHRYSLER, DAEWOO, DAIHATSU, FIAT, FORD, HONDA, HYUNDAI, INNOCENTI, ISUZU, LADA (AVTOVAZ), LANCIA, LAND ROVER, LOTUS, MAZDA, MITSUBISHI, MORGAN, NISSAN, OPEL, PORSCHE, PROTON, RELIANT, RENAULT, ROVER, SEAT, SUBARU, SUZUKI, TALBOT, TOFAS, TVR, VAUXHALL, VOLVO, YUGO, ZASTAVA
<b>BPR6ES-11</b>	HONDA, HYUNDAI, ISUZU, KIA, LADA (AVTOVAZ), MAZDA, MITSUBISHI, NISSAN, OPEL, SUBARU, SUZUKI
<b>BPR6EY</b>	DAEWOO, DAIHATSU, HONDA, INNOCENTI, TOYOTA, INNOCENTI
<b>BPR6EY-11</b>	HONDA, TOYOTA
<b>BPR6FS</b>	BEDFORD, VAUXHALL





<b>BPR6HS</b>	BEDFORD, DAEWOO, FORD, OPEL, VAUXHALL
<b>BPR7ES</b>	ALFA ROMEO, CATERHAM, FIAT, FORD, LANCIA, LOTUS, MITSUBISHI, SUBARU, VOLVO
<b>BPR7ES-11</b>	mitsubishi
<b>BPR7HS</b>	FIAT, PORSCHE
<b>BPR8ES</b>	ASTON MARTIN
<b>BPR8EVX</b>	PORSCHE
<b>BPR9EVX</b>	PORSCHE
<b>BR6EF</b>	DAIMLER, JAGUAR
<b>BR6ES</b>	HONDA
<b>BR7EF</b>	DAIMLER, JAGUAR, PEUGEOT
<b>BR7EFS</b>	DAIMLER, JAGUAR
<b>BR7ES</b>	MITSUBISHI
<b>BR8EVX</b>	PORSCHE
<b>BRE527Y-11</b>	TOYOTA
<b>BUR5ET</b>	SEAT, VW
<b>BUR5ET-10</b>	AUDI, VW
<b>BUR6EA-11</b>	MITSUBISHI
<b>BUR6EFSZ</b>	AUDI
<b>BUR6ET</b>	AUDI, FIAT, LANCIA, SEAT, SKODA, VW
<b>CR8EVX</b>	FERRARI
<b>CX51+CZ51</b>	NISSAN
<b>CY03</b>	MAZDA, OPEL, VAUXHALL
<b>CY51</b>	NISSAN
<b>CY52</b>	NISSAN
<b>CY57</b>	HYUNDAI, MITSUBISHI



<b>CZ101</b>	AUDI, SKODA, VW
<b>CZ24</b>	OPEL, RENAULT * only by Cardealer
<b>CZ301</b>	AUDI, VW
<b>CZ302</b>	MERCEDES
<b>CZ71</b>	NISSAN
<b>D8EVX</b>	FERRARI
<b>D9EVX</b>	LAMBORGHINI
<b>DCPR7E</b>	MASERATI, SUZUKI
<b>DCPR7E-N</b>	FIAT, LANCIA
<b>DCPR7EN-10</b>	FIAT, LANCIA, FIAT
<b>DCPR7EVX</b>	SUZUKI
<b>DCPR8E</b>	TVR, FIAT, LANCIA, MASERATI
<b>DCPR8EKC</b>	FIAT
<b>DCPR8EKP</b>	BMW
<b>DCPR8E-N</b>	FIAT, LANCIA, TOFAS / FIAT
<b>DCPR9E</b>	MASERATI
<b>DCPR9EVX</b>	FERRARI
<b>DG237</b>	MERCEDES <b>Discontinued</b>
<b>FR4</b>	CHEVROLET, DODGE, JEEP
<b>FR45</b>	CHRYSLER
<b>FR5</b>	DODGE, JEEP, PLYMOUTH
<b>FR5-1</b>	CHRYSLER, DODGE, JEEP
<b>FR5CP</b>	ALFA ROMEO
<b>GR4</b>	CADILLAC, CHEVROLET, CHRYSLER, DODGE, JEEP, PLYMOUTH, PONTIAC
<b>GR45</b>	CADILLAC, CHRYSLER, DODGE
<b>GR5</b>	CHEVROLET, DODGE, PLYMOUTH



<b>IFR5A-11</b>	TOYOTA
<b>IFR5E-11</b>	MAZDA, SUZUKI
<b>IFR5G-11</b>	KIA
<b>IFR5G-11K</b>	HONDA
<b>IFR5J-11</b>	SUZUKI
<b>IFR5N10</b>	DAIMLER, JAGUAR, LAND ROVER
<b>IFR6A-11</b>	TOYOTA
<b>IFR6A-11T</b>	TOYOTA
<b>IFR6D10</b>	MERCEDES
<b>IFR6E-11</b>	SUZUKI
<b>IFR6J-11</b>	SUZUKI, DAIHATSU, SUZUKI
<b>IFR6Q-G</b>	MAYBACH, MERCEDES
<b>IFR6T-11</b>	LEXUS, TOYOTA
<b>IFR7G-11KS</b>	HONDA
<b>IGR6A-11</b>	MITSUBISHI
<b>IGR7A</b>	MITSUBISHI
<b>IGR7A-G</b>	MITSUBISHI
<b>IKR7D</b>	DAIHATSU
<b>IKR9F8</b>	FIAT
<b>ILFR5B-11</b>	KIA
<b>ILFR6A</b>	MERCEDES
<b>ILFR6B</b>	SUBARU
<b>ILFR7H</b>	MITSUBISHI
<b>ILKAR7A-7</b>	RENAULT
<b>ILZFR6C-K</b>	MITSUBISHI
<b>ILZFR6D11</b>	BMW
<b>ILZKAR7A10</b>	MERCEDES



<b>ILZKR7A</b>	VW
<b>ITR5F-13</b>	MAZDA
<b>ITR6F-13</b>	FORD, MAZDA, VOLVO
<b>IZFR5B</b>	MITSUBISHI
<b>IZFR5C</b>	MITSUBISHI
<b>IZFR6B</b>	MITSUBISHI, VOLVO
<b>IZFR6H-11</b>	BMW
<b>IZFR6K-11</b>	HONDA
<b>IZFR6K-11S</b>	HONDA
<b>IZKR7B</b>	AUDI, VW
<b>KR8BI</b>	SUBARU
<b>LFR5A-11</b>	NISSAN
<b>LFR5AP-11</b>	NISSAN
<b>LFR5B</b>	CITROEN, PEUGEOT
<b>LFR6B</b>	CITROEN, PEUGEOT
<b>LFR6C-11</b>	MITSUBISHI, TOYOTA
<b>LFR6D</b>	VOLVO
<b>LKR7C</b>	DAIHATSU
<b>LKR8A</b>	SMART
<b>LKR8AP</b>	BMW
<b>LTR6B-10T</b>	OPEL
<b>LZFR6AI</b>	MITSUBISHI
<b>LZKAR7A</b>	CITROEN, PEUGEOT, RENAULT
<b>LZKAR7B</b>	RENAULT
<b>LZTR4A-11</b>	CHRYSLER, JEEP
<b>LZTR5A-13</b>	CHRYSLER, DODGE
<b>PFR5B</b>	AUDI



<b>PFR5B-11</b>	INFINITI, SUBARU
<b>PFR5G-11</b>	ACURA, CHRYSLER, DODGE, FORD (USA), INFINITI, SAM SUNG
<b>PFR5G-11E</b>	DAIMLER, JAGUAR
<b>PFR5G-13E</b>	DAIMLER, JAGUAR
<b>PFR5J-11</b>	HYUNDAI, MITSUBISHI
<b>PFR5N-11</b>	HYUNDAI, KIA
<b>PFR5P-11</b>	NISSAN, MERCEDES
<b>PFR6A-11</b>	NISSAN
<b>PFR6B</b>	ALFA ROMEO, LANCIA, SUBARU, VOLVO
<b>PFR6B-11</b>	FORD, NISSAN
<b>PFR6E-10</b>	RENAULT
<b>PFR6G</b>	SUBARU, VOLVO
<b>PFR6G-11</b>	HONDA, MITSUBISHI, NISSAN
<b>PFR6G-13E</b>	DAIMLER, JAGUAR
<b>PFR6G-9</b>	RENAULT
<b>PFR6H-10</b>	SAAB
<b>PFR6J</b>	MITSUBISHI
<b>PFR6J-11</b>	DODGE, MITSUBISHI
<b>PFR6N-11</b>	HYUNDAI, KIA, LAND ROVER, LOTUS, MG, MORGAN, ROVER
<b>PFR6Q</b>	AUDI, BENTLEY, SEAT, SKODA, VW
<b>PFR6S-8E</b>	AUDI
<b>PFR6T-10G</b>	OPEL, SAAB, VAUXHALL
<b>PFR6T-G</b>	OPEL
<b>PFR6W-T</b>	AUDI
<b>PFR6X-11</b>	AUDI
<b>PFR7B</b>	ALPINA, AUDI, MG



<b>PFR7B-11</b>	FORD
<b>PFR7G</b>	LAMBORGHINI
<b>PFR7G-11</b>	HONDA
<b>PFR7H-10</b>	SAAB
<b>PFR7Q</b>	AUDI
<b>PFR7W-T</b>	AUDI
<b>PFR7Z-TG</b>	RENAULT
<b>PGR6A</b>	ALFA ROMEO
<b>PGR6A-11</b>	MITSUBISHI
<b>PGR7A</b>	MITSUBISHI
<b>PKR7A</b>	BMW
<b>PKR9B</b>	FERRARI
<b>PLFR5A-11</b>	CITROEN, INFINITI, NISSAN, PEUGEOT, RENAULT
<b>PLFR6A-11</b>	SUBARU, VOLVO
<b>PLFR6A-9</b>	NISSAN
<b>PLFR6C-10G</b>	VAUXHALL
<b>PLKR7A</b>	MERCEDES
<b>PLZKAR6A-11</b>	NISSAN
<b>PLZKBR7A-G</b>	MINI, PEUGEOT
<b>PMR7A</b>	FERRARI
<b>PMR8A</b>	FERRARI, MASERATI
<b>PMR8B</b>	FERRARI, MASERATI
<b>PTR4B-15</b>	BUICK, CHEVROLET, OLDSMOBILE, PONTIAC
<b>PTR5A-10</b>	VAUXHALL
<b>PTR5A-13</b>	FORD, MAZDA
<b>PTR5D-10</b>	FORD, MAZDA



<b>PTR5D-13</b>	ASTON MARTIN
<b>PTR6D-13</b>	ASTON MARTIN, JAGUAR
<b>PTR6D-13G</b>	FORD
<b>PTR6F-13</b>	FORD
<b>PZFR5D-11</b>	SEAT, SKODA, VW
<b>PZFR5F-11</b>	DODGE
<b>PZFR5J-11</b>	VW
<b>PZFR5N-11T</b>	AUDI, SEAT, SKODA, VW
<b>PZFR5N-11TG</b>	SEAT, SKODA
<b>PZFR5Q-11</b>	VW
<b>PZFR6F</b>	MAZDA
<b>PZFR6F-11</b>	HONDA, JEEP
<b>PZFR6J-11</b>	AUDI, VW
<b>PZFR6R</b>	VW
<b>PZTR5A-15</b>	AM GENERAL, CHEVROLET
<b>R5724-9</b>	VENTURI
<b>RE8C-L + RE9B-T</b>	MAZDA
<b>TR4</b>	BUICK
<b>TR5</b>	BUICK, FORD (USA)
<b>TR5-1</b>	FORD (USA)
<b>TR55</b>	BUICK, CADILLAC, CHEVROLET, FORD, FORD (USA), OLDSMOBILE, PONTIAC
<b>TR55-1</b>	FORD (USA)
<b>TR55IX</b>	BUICK, CADILLAC
<b>TR5A-10</b>	FORD
<b>TR5B-13</b>	FORD
<b>TR5IX</b>	FORD, MAZDA



<b>UR4</b>	BUICK, CHEVROLET, CHRYSLER, DODGE, FORD (USA), JEEP, LINCOLN, MERCURY, PONTIAC
<b>UR40</b>	BUICK, CHEVROLET, OLDSMOBILE, PONTIAC
<b>UR45</b>	BUICK, CADILLAC, CHEVROLET, FORD (USA), LINCOLN, MERCURY, OLDSMOBILE, PONTIAC
<b>UR5</b>	BUICK, CHEVROLET, FORD (USA), PONTIAC
<b>UR5IX</b>	CHEVROLET
<b>UR6</b>	CHEVROLET
<b>WR5</b>	FORD (USA), LINCOLN, MERCURY
<b>XR4</b>	BUICK, CHEVROLET, CHRYSLER, DODGE, OLDSMOBILE, PLYMOUTH, PONTIAC
<b>XR40</b>	BUICK, OLDSMOBILE, PONTIAC, BUICK, CADILLAC, OLDSMOBILE, PONTIAC
<b>XR5</b>	BUICK, CADILLAC, CHEVROLET, CHRYSLER, DODGE, OLDSMOBILE, PLYMOUTH, PONTIAC
<b>Y-103</b>	NISSAN
<b>Y-103-1</b>	NISSAN
<b>Y-103-2</b>	NISSAN
<b>Y-107R</b>	MAZDA
<b>Y-107T</b>	KIA, MAZDA
<b>Y-112M1</b>	NISSAN
<b>Y-112R1</b>	NISSAN
<b>Y-112T</b>	NISSAN
<b>Y-115R1</b>	MITSUBISHI
<b>Y-115T1</b>	HYUNDAI, MITSUBISHI
<b>Y-117RS</b>	NISSAN



Y-117SS	NISSAN
Y-118R	TOYOTA
Y-118T1	TOYOTA
Y-128	TOYOTA
Y-128T	DAIHATSU, TOYOTA
Y-146R	DAIHATSU, INNOCENTI, TOYOTA
Y-147T	DAIHATSU, TOYOTA
Y-157R	MAZDA
Y-162R1	NISSAN
Y-168R	TOYOTA
Y-172	MAZDA
Y-177-1	NISSAN
Y-178	TOYOTA
Y-178T	TOYOTA
Y-181T	NISSAN
Y-197R	HINO, TOYOTA
Y-197T	TOYOTA
Y-202	NISSAN
Y-202-2	NISSAN
Y-204RS	NISSAN
Y-204SS	NISSAN
Y-204TS-1	NISSAN
Y-208T	ALFA ROMEO, AVIA, BEDFORD, CARBODIES, CITROEN, FIAT, FORD, IVECO, LAND ROVER, MAHINDRA, OPEL, PEUGEOT, RENAULT, ROVER, SEAT, TALBOT
Y-222T	NISSAN
Y-271-2	ISUZU



Y-272R-1	NISSAN
Y-302	LEYLAND, LEYLAND <b>Discontinued</b>
Y-306R	ISUZU, OPEL, VAUXHALL
Y-307R	BEDFORD, ISUZU, VAUXHALL
Y-403T	OPEL, ZUK
Y-404	PEUGEOT
Y-405	CITROEN
Y-452-1	TOYOTA
Y-501U	AUDI, SKODA, VW
Y-502R	RENAULT
Y-503R	CITROEN, PEUGEOT
Y-504J	CITROEN
Y-504R	CITROEN, FIAT, LANCIA, PEUGEOT, SUZUKI
Y-506R	RENAULT
Y-507R	BMW, LAND ROVER, MG, ROVER
Y-515J	MITSUBISHI, NISSAN, OPEL, RENAULT, SUZUKI, VAUXHALL, VOLVO, RENAULT
Y-516J	RENAULT
Y-517J	OPEL, RENAULT, VAUXHALL
Y-519J	NISSAN
Y-523J	OPEL, VAUXHALL
Y-524J	FORD
Y-525J	FORD, LDV
Y-527J	KIA
Y-529J	MAZDA
Y-531J	TOYOTA
Y-532J	TOYOTA



<b>Y-534J</b>	ALFA ROMEO, FIAT, LANCIA, VAUXHALL
<b>Y-541J</b>	OPEL, VAUXHALL
<b>Y-542J</b>	TOYOTA
<b>Y-543J</b>	FIAT, SMART
<b>Y-547AS</b>	BMW
<b>Y-607AS</b>	AUDI, SKODA, VW
<b>Y-609AS</b>	AUDI, VW
<b>Y-701J</b>	FORD, KIA, MAZDA
<b>Y-701R</b>	KIA, SUZUKI
<b>Y-703R</b>	DAIHATSU, TOYOTA
<b>Y-705RS</b>	NISSAN
<b>Y-707RS</b>	NISSAN
<b>Y-710J</b>	ISUZU, VAUXHALL
<b>Y-711J</b>	ISUZU, OPEL
<b>Y-711RS</b>	BEDFORD, VAUXHALL
<b>Y-712RS</b>	NISSAN
<b>Y-715R</b>	TOYOTA
<b>Y-719RS1</b>	OPEL
<b>Y-721RS</b>	MAZDA
<b>Y-729U</b>	LAND ROVER
<b>Y-730U</b>	HONDA, MG, RENAULT, ROVER
<b>Y-731U</b>	CITROEN, LADA (AVTOVAZ), PEUGEOT
<b>Y-732U</b>	AUDI, FORD, SEAT, SKODA, VOLVO, VW
<b>Y-733J</b>	MITSUBISHI
<b>Y-738U</b>	CITROEN
<b>Y-739R</b>	FIAT
<b>Y-740U</b>	HONDA, RENAULT



<b>Y-741U</b>	ALFA ROMEO, AUDI, CHRYSLER, FORD, JEEP, OPEL, SKODA, VW
<b>Y-745U</b>	CHRYSLER, JEEP, MERCEDES, SSANGYONG
<b>Y-746R</b>	MERCEDES
<b>Y-747U</b>	ALFA ROMEO, FIAT, LANCIA
<b>Y-748U</b>	KIA, OPEL, SAAB, VAUXHALL
<b>Y-749J</b>	HYUNDAI, KIA
<b>Y-755RS</b>	NISSAN
<b>Y-757RS</b>	NISSAN
<b>Y-771R</b>	MAZDA
<b>Y-810</b>	OPEL, PEUGEOT
<b>Y-902R</b>	ARO, AUVERLAND, BEDFORD, BMW, CITROEN, FIAT, FORD, FREIGHTROVER, LANCIA, MAHINDRA, MERCEDES, NISSAN (Spain), OPEL, PEUGEOT, ROVER, SEAT, TALBOT, UAZ, VAUXHALL
<b>Y-904M</b>	ISUZU
<b>Y-904M1</b>	OPEL, VAUXHALL
<b>Y-907R</b>	FORD, LAND ROVER
<b>Y-908R</b>	FIAT, JEEP, RENAULT
<b>Y-909R</b>	ALFA ROMEO, LAND ROVER, UAZ
<b>Y-910R</b>	FORD, LADA (AVTOVAZ)
<b>Y-911R</b>	ROVER
<b>Y-913M</b>	RENAULT, VOLVO
<b>Y-914U</b>	FIAT, RENAULT
<b>Y-916R</b>	DAEWOO, MERCEDES, SSANGYONG, STEYR
<b>Y-917U</b>	BMW, LAND ROVER, OPEL, VAUXHALL
<b>Y-918R</b>	AUDI, MITSUBISHI, NISSAN, SEAT, SKODA, VOLVO, VW





<b>A.C.BRISTOL</b>	B6HS
<b>ABARTH</b>	B10EG, B6HS, B8ES, BP8ES
<b>AC</b>	BPR5FS-11
<b>ACURA</b>	PFR5G-11
<b>ALFA ROMEO</b>	B6ES, B7ES, BCP6ES, BKR6EKPA, BKR6EKPA+PMR7A, BP6ES, BP7ES, BP8ES, BP8EVX, BPR6E, BPR7ES, PFR6B, PGR6A, Y-208T, Y-534J, Y-741U, Y-747U, Y-909R, Y-922R
<b>ALLARD</b>	A7, B6ES
<b>ALPINA</b>	BKR6EK, BKR6EQUP, PFR7B
<b>ALPINE</b>	B8EVX
<b>ALVIS</b>	B5HS
<b>AM GENERAL</b>	PZTR5A-15
<b>ARMSTRONG SIDDELEY</b>	B6ES
<b>ARO</b>	Y-902R
<b>ASTON MARTIN</b>	BCPR7ES, BCR8ES, BP6ES, BPR5EV, BPR8ES, PTR5D-13, PTR6D-13
<b>AUDI</b>	B7ES, BCP7ET, BKR6E, BKR6EKUB, BKR6EQUA, BKR6EQUP, BKUR5ET-10, BKUR6ET-10, BKUR7ET, BP6ES, BP6ESZ, BP7ES, BP7EVX, BPR5EQU, BUR5ET-10, BUR6EFSZ, BUR6ET, IZKR7B, PFR5B, PFR6Q, PFR7B, PFR7Q, PZFR5N-11T, PZFR6J-11, Y-501U, Y-607AS, Y-609AS, Y-732U, Y-741U, Y-918R, YE14, ZFR6S-Q
<b>AUSTIN</b>	BP5ES, BP6EF, BP6ES, BPR6ES
<b>AUTOBIANCHI</b>	B7HS, BCPR6ES, BPR6ES
<b>AUTOUNION</b>	A6, A7
<b>AUVERLAND</b>	Y-902R, Y-923U
<b>AVIA</b>	Y-208T
<b>AZLK (MOSKWITCZ)</b>	BP6ES, BP7ES



<b>BARKAS</b>	B6HS
<b>BEDFORD</b>	B6S, BP6ES, BPR6ES, BPR6FS, BPR6HS, Y-208T, Y-307R, Y-711RS, Y-902R
<b>BENTLEY</b>	B6ES, BKR4EVX, BKR5EVX, BKR6EQUP, BPR4EVX, BPR5ES, BPR5EV, PFR6Q
<b>BERTONE</b>	ZGR5A
<b>BMW</b>	B7ES, B7HS, B8ES, B8HS, BKR6EK, BKR6EQUP, BP5ES, BP6ES, BPR6ES, DCPR8EKP, ILZFR6D11, IZFR6H11, LKR8AP, PKR7A, Y-507R, Y-547AS, Y-902R, Y-917U, ZFR5F, ZGR5A
<b>BOND</b>	BP6ES
<b>BORGWARD</b>	B6HS, B7HS
<b>BRISTOL</b>	BPR5ES
<b>BUICK</b>	PTR4B-15, TR4, TR5, TR55, TR55IX, UR4, UR40, UR45, UR5, XR4, XR40, XR45, XR5
<b>CADILLAC</b>	BPR5EFS-13, GR4, GR45, TR55, TR55IX, UR45, XR45, XR5
<b>CARBODIES</b>	Y-208T
<b>CATERHAM</b>	B8ECS, BCPR7ES, BKR6E, BP7ES, BPR7ES
<b>CHEVROLET</b>	BKR5EK, BKR6E-11, BKUR6ETB, BPR5EY-11, FR4, GR4, GR5, PTR4B-15, PZTR5A-15, TR55, UR4, UR40, UR45, UR5, UR5IX, UR6, XR4, XR5, YR5, YR55
<b>CHRYSLER</b>	BCPR6ES, BKR5E-11, BKR6E, BPR5ES-11, BPR6ES, FR45, FR5-1, GR4, GR45, LZTR4A-11, LZTR5A-13, PFR5G-11, UR4, XR4, XR5, Y-741U, Y-745U, Y-923U, ZFR5F-11, ZFR5LP-13G
<b>CITROEN</b>	B4, B4L, B6HS, B7HS, BCP5ES, BCP6ES, BCP6ET, BCPR5ES, BCPR6ES, BCPR6ET, BKR5EK, BKR5EZ, BKR6EK, BKR6EZ, BP6EFS, BP6ES, BP6HS, BP7EFS, LFR5B, LFR6B, LZKAR7A, PLFR5A-11, Y-208T, Y-405, Y-503R,





	Y-504J, Y-504R, Y-731U, Y-738U, Y-902R, Y-923U, Y-938R, YE04, YE05, YE08
<b>DACIA</b>	BKR6E, BP6HS
<b>DAEWOO</b>	BCP5ES, BKR5EK, BKR6E-11, BPR5ES, BPR5ES-11, BPR5EY-11, BPR6ES, BPR6EY, BPR6HS, Y-916R
<b>DAF</b>	B6HS, BP6HS
<b>DAIHATSU</b>	BKR5EKC, BKR6E, BKR6E-11, BKUR6EK, BKUR6ETB-10, BP5EY, BPR5EA-L, BPR5ES, BPR5EY, BPR5EY-11, BPR6EKN, BPR6ES, BPR6EY, IFR6J-11, IKR7D, LKR7C, Y-128T, Y-146R, Y-147T, Y-703R
<b>DAIMLER</b>	BCPR6ES, BKR5EVXA-13, BP5ES, BP7ES, BR6EF, BR7EF, BR7EFS, IFR5N10, PFR5G-11E, PFR5G-13E, PFR6G-13E
<b>DELAHAYE</b>	A6
<b>DKW</b>	A7
<b>DODGE</b>	BKR6EVX-11, BPR5EVX-11, FR4, FR5, FR5-1, GR4, GR45, GR5, LZTR5A-13, PFR5G-11, PFR6J-11, PZFR5F-11, UR4, XR4, XR5
<b>FERRARI</b>	BP7ES, BP8EVX, CR8EVX, D8EVX, DCPR9EVX, PKR9B, PMR7A, PMR8A, PMR8B
<b>FIAT</b>	B7ES, B7HS, BCPR6ES, BCPR7ES, BCPR7ET, BKR5EZ, BKR6EKC, BKR6EZ, BP6ES, BP6ET, BP7ES, BPR5ES, BPR6ES, BPR7ES, BPR7HS, BUR6ET, DCPR7E-N, DCPR7EN-10, DCPR7EN-10, DCPR8E, DCPR8EKC, DCPR8E-N, Y-208T, Y-504R, Y-534J, Y-543J, Y-739R, Y-747U, Y-902R, Y-908R, Y-914U, Y-922R, Y-923U, Y-928U, Y-935U, ZKR7A-10
<b>FISSORE</b>	BP6ES
<b>FORD</b>	AP6FS, APR6FS, B6HS, BCPR6ES, BCPR6ES-11, BCPR7ES, BCPR7ES-11, BCR8ES, BKR5EKUP, BKR6EVX-11,

	BKR7EVX-11, BP6ES, BP6HS, BP7HS, BPR6EFS, BPR6ES, BPR6HS, BPR7ES, ITR6F-13, PFR6B-11, PFR7B-11, PTR5A-13 *, PTR5D-10, PTR6D-13G, PTR6F-13, TR55, TR5A-10, TR5B-13, TR5IX, Y-208T, Y-524J, Y-525J, Y-701J, Y-732U, Y-741U, Y-902R, Y-907R, Y-910R, Y-937R, YE04, ZFR5E-11, ZFR6F-11
<b>FORD (USA)</b>	PFR5G-11, TR5, TR5-1, TR55, TR55-1, UR4, UR45, UR5, WR5
<b>FREIGHTROVER</b>	Y-902R
<b>FSM</b>	A6
<b>FSO</b>	BP6ES, BP6ET
<b>GAZ (VOLGA)</b>	BP6HS, BPR5ES
<b>GLAS</b>	A7, B6ES, BP6ES
<b>HINO</b>	Y-197R
<b>HONDA</b>	BCPR6E-11, BCPR6EYN-11, BKR6E-11, BKR6EN-11, BKR7EN-11, BPR5ES, BPR5EY-11, BPR6ES, BPR6ES-11, BPR6EY, BPR6EY-11, BR6ES, IFR5G-11K, IFR7G-11KS, IZFR6K-11, PFR6G-11, PFR7G-11, PZFR6F-11, Y-730U, Y-740U, ZFR5F-11, ZFR5J-11, ZFR6F-11, ZFR6J-11, ZFR6K-11
<b>HYUNDAI</b>	BKR5E-11, BKR5ES-11, BKR6ES, BP5ES, BP6ES-11, BPR5ES-11, BPR6ES, BPR6ES-11, CY57, PFR5J-11, PFR5N-11, PFR6N-11, Y-115T1, Y-749J
<b>INFINITI</b>	PFR5B-11, PFR5G-11, PLFR5A-11
<b>INNOCENTI</b>	BP6ES, BPR5ES, BPR5EY, BPR6ES, BPR6EY, BPR6EY, Y-146R
<b>ISUZU</b>	BKR6E-11, BP5ES-11, BP6ES, BPR5ES-11, BPR6ES, BPR6ES-11, Y-271-2, Y-306R, Y-307R, Y-710J, Y-711J, Y-904M
<b>IVECO</b>	Y-208T
<b>JAGUAR</b>	B6EFS, B8ES, BCPR6ES, BKR5EVXA-13, BKR6EVXA-11, BKR6EVXA-13, BP5E,



	BP5ES, BP7ES, BR6EF, BR7EF, BR7EFS, IFR5N10, PFR5G-11E, PFR5G-13E, PFR6G-13E, PTR6D-13
<b>JEEP</b>	FR4, FR5, FR5-1, GR4, LZTR4A-11, PZFR6F-11, UR4, Y-741U, Y-745U, Y-908R, Y-923U, ZFR5A-11
<b>KIA</b>	BKR5E, BKR5ES, BKR5ES-11, BKR6E, BKR6E-11, BKR6ES-11, BP6ES, BPR5ES-11, BPR5EY-11, BPR6ES-11, PFR5N-11, PFR6N-11, Y-107T, Y-701J, Y-701R, Y-748U, Y-749J, ZFR5F
<b>LADA (AVTOVAZ)</b>	BCP6ES, BCPR6ES, BCPR6ES-11, BKR6E, BP6ES, BPR6ES, BPR6ES-11, Y-731U, Y-910R
<b>LAMBORGHINI</b>	B8EVX, BP7EVX, BP8EVX, D9EVX
<b>LANCIA</b>	B6ES, B7ES, B8ES, BCPR6ES, BCPR6ET, BCPR7ES, BKR5EZ, BKR6EK****, BKR6EKC, BKR6EZ, BKUR6ETB, BP6ES, BP6ET, BP7ES, BP8ES, BPR6ES, BPR7ES, BUR6ET, DCPR7E-N, DCPR7EN-10, DCPR8E, DCPR8E-N, PFR6B, Y-504R, Y-534J, Y-747U, Y-902R, Y-922R, Y-923U, Y-928U
<b>LAND ROVER</b>	B5ES, B6ES, BP5E, BP5ES, BP6ES, BPR6ES, IFR5N10, PFR6N-11, Y-208T, Y-507R, Y-729U, Y-907R, Y-909R, Y-917U, Y-923U
<b>LDV</b>	BKR7EVX, Y-525J, Y-924J
<b>LEXUS</b>	BKR5EP-11, BKR6EKP-11, BKR6EP-11, BKR6EYA, IFR6T-11
<b>LEYLAND</b>	Y-302, Y-302 no longer produced
<b>LEYLAND DAF</b>	BP6EF, BP6ES, Y-923U
<b>LINCOLN</b>	UR4, UR45, WR5
<b>LLOYD</b>	A6, B6HS
<b>LOTUS</b>	BKR7E, BP6ES, BP7ES, BPR6EKN, BPR6ES, BPR7ES, PFR6N-11
<b>LUBLIN (Daewoo)</b>	BPR5EY



<b>MAHINDRA</b>	Y-208T, Y-902R
<b>MASERATI</b>	BP6ES, BP8ES, BP8EVX, DCPR7E, DCPR8E, DCPR9E, PMR8A, PMR8B
<b>MATRA</b>	BP6ES, BP8ES
<b>MAZDA</b>	BCPR6E, BCPR6E-11, BKR5E, BKR5E-11, BKR6E-11, BPR5ES, BPR5ES-11, BPR6ES, BPR6ES-11, CY03, IFR5E-11, ITR5F-13, ITR6F-13, PTR5A-13 *, PTR5D-10, PZFR6F, RE8C-L + RE9B-T, TR5IX, Y-107R, Y-107T, Y-157R, Y-172, Y-529J, Y-701J, Y-721RS, Y-771R, ZFR5F-11, ZFR6A-11, ZFR6F-11
<b>MERCEDES</b>	Y-930U, B5HS, BCP5ES, BCP6ES, BKR5EKU, BKUR5ET, BKUR5ET-10, BKUR6ET-10, BP5EFS, BP6EFS, BP6ES, BP6HS, BP7ES, BP8EVX, DG237, IFR6D10, IFR6A, PFR5R-11, PLKR7A, Y-745U, Y-746R, Y-902R, Y-916R, Y-923U, Y-925R, Y-929U
<b>MERCURY</b>	UR4, UR45, WR5
<b>MESSERSCHMITT</b>	A8
<b>MESSERSCHMITT FMR</b>	A8
<b>MG</b>	B6ES, BP5HS, BP6ES, PFR6N-11, PFR7B, Y-507R, Y-730U
<b>MINI</b>	BKR6EQU
<b>MITSUBISHI</b>	BK6E, BKR5E-11, BKR6E-11, BP5ES, BP6ES, BP6ES-11, BPR5ES, BPR5ES-11, BPR6ES, BPR6ES-11, BPR7ES, BPR7ES-11, BR7ES, BUR6EA-11, CY57, IGR6A-11, IGR7A, IGR7A-G, ILFR7H, ILZFR6C-K, IZFR5B, IZFR5C, IZFR6B, LFR6C-11, LZFR6AI, PFR5J-11, PFR6G-11, PFR6J, PFR6J-11, PGR6A-11, PGR7A, Y-115R1, Y-115T1, Y-515J, Y-733J, Y-918R
<b>MONTEVERDI</b>	BP6S
<b>MORGAN</b>	BCPR6ES, BP6ES, BPR6ES, PFR6N-11
<b>MOSKWICZ</b>	BP7ES



<b>NISSAN</b>	BCP5ES, BCP6ES, BCP6ES-11, BCPR5ES-11, BCPR5ES-11 + BCP6ES-11, BCPR6E-11, BCPR6ES, BCPR6ES-11, BKR5E, BKR5E-11, BKR5EY, BKR5EY-11, BKR6E, BKR6E-11, BKR6EY, BP5ES, BP6ES, BPR5E, BPR5ES, BPR5ES-11, BPR6ES, BPR6ES-11, CX51+CZ51, CY51, CY52, CZ71, LFR5A-11, LFR5AP-11, PFR5P-11, PFR6A-11, PFR6B-11, PFR6G-11, PLFR5A-11, PLFR6A-9, PLZKAR6A-11, Y-103, Y-103-1, Y-103-2, Y-112M1, Y-112R1, Y-112T, Y-117RS, Y-117SS, Y-162R1, Y-177-1, Y-181T, Y-202, Y-202-2, Y-204RS, Y-204SS, Y-204TS-1, Y-222T, Y-272R-1, Y-515J, Y-519J, Y-705RS, Y-707RS, Y-712RS, Y-755RS, Y-757RS, Y-918R, Y-955RS, ZFR5E-11
<b>NISSAN (Spain)</b>	Y-902R
<b>NSU</b>	B6ES, B7ES, B7HS
<b>NSU-FIAT</b>	B6HS, B7HS
<b>OLDSMOBILE</b>	PTR4B-15, TR55, UR40, UR45, XR4, XR40, XR45, XR5
<b>OPEL</b>	B6HS, B6S, BKR5EK, BKR5EQUPA, BKR6EIX-LPG, BKR6EK, BP6HS, BPR5ES, BPR6ES, BPR6ES-11, BPR6HS, CY03, PFR6T-10G, PFR6T-G, Y-208T, Y-306R, Y-403T, Y-515J, Y-517J, Y-523J, Y-541J, Y-711J, Y-719RS1, Y-741U, Y-748U, Y-810, Y-902R, Y-904M1, Y-917U, Y-924U, YE06, YE07, ZFR5F, ZFR5F-11, ZFR6F-11
<b>PANHARD</b>	B6ES, B7ES
<b>PANTHER</b>	BP5ES
<b>PERODUA</b>	BKR5EKC
<b>PEUGEOT</b>	B6HS, BCP5ES, BCP6ES, BCP6ET, BCPR5ES, BCPR6ES, BCPR6ET, BKR5EK, BKR6EK, BKR6ES, BKR6EZ, BKUR7ET, BP5ES, BP6EFS, BP6ES, BP7EFS, BP7ES, BR7EF, LFR5B, LFR6B, LZKAR7A, PLFR5A-11, Y-208T, Y-404, Y-503R, Y-504R, Y-731U, Y-810, Y-902R,

	Y-923U, Y-938R, YE04, YE05, YE08
<b>PLYMOUTH</b>	FR5, GR4, GR5, XR4, XR5
<b>PONTIAC</b>	BPR4FS-11, BPR5EFS-13, GR4, PTR4B-15, TR55, UR4, UR40, UR45, UR5, XR4, XR40, XR45, XR5
<b>PORSCHE</b>	B7HS, B8EGV, B9EVX, BCPR7ET, BKR6EK, BKR6EQUP, BKR7EQUP, BP7EVX, BP7HS, BP8EVX, BPR6ES, BPR7HS, BPR8EVX, BPR9EVX, BR8EVX
<b>PROTON</b>	BKR6E-11, BPR5ES, BPR5ES-11, BPR6ES
<b>RELIANT</b>	BPR5ES, BPR6ES
<b>RENAULT</b>	B5HS, B6HS, B6S, B7HS, B8EFS, B8EG, B8EVX, B95EGP, B95EGV, B9EG, BCP5ES, BCP6ET, BCPR5ES, BCPR6ET, BK5ESZ, BKR5EK, BKR5EVX, BKR5EZ, BKR6E, BKR6EK, BKR6ES, BKR6EZ, BKUR7ET, BP5ES, BP5ESZ, BP6EFS, BP6ES, BP6ESZ, BP6HS, BP7EFS, BP7EFVX, BP7ES, BPR5ES, BPR6ES, LZKAR7A, PFR6E-10, PFR6G-9, PLFR5A-11, Y-208T, Y-502R, Y-506R, Y-515J, Y-515J, Y-516J, Y-517J, Y-730U, Y-740U, Y-908R, Y-913M, Y-914U, Y-927R, Y-932R, Y-935U
<b>ROLLS ROYCE</b>	B6ES, BKR4EVX, BKR5EVX, BKR6EQUP, BP5ES, BPR4EVX, BPR5ES, BPR5EV
<b>ROSENGART</b>	B5HS
<b>ROVER</b>	B6ES, B6ES, BCP6ES, BCPR6E-11, BCPR6ES, BKR6E, BKR6ES, BP5EFS, BP5ES, BP5HS, BP6EFS, BP6ES, BPR5ES, BPR6ES, PFR6N-11, Y-208T, Y-507R, Y-730U, Y-902R, Y-911R, ZFR6F-11
<b>SAAB</b>	BCP5EVX, BCP6EVX, BCP7EVX, BCPR6ES-11, BCPR7ES, BCPR7ES-11, BKR5EK, BP6ES, BP7ES, PFR6H-10, PFR6T-10G, PFR7H-10, Y-748U, YE07
<b>SAM SUNG</b>	PFR5G-11
<b>SEAT</b>	BCP7ES, BKR5EKUP, BKR6ETA-10, BKUR5ET, BKUR5ET-10, BKUR6ET, BKUR6ET-10, BKUR7ET, BP5ET, BP6ES,



	BP7ES, BPR5ES, BPR6ES, BUR5ET, BUR6ET, PFR6Q, PZFR5D-11, PZFR5N-11T, Y-208T, Y-732U, Y-902R, Y-918R
<b>SKODA</b>	BCPR5ES, BKR6EKUB, BKR6ES, BKR6ETA-10, BKUR5ET-10, BKUR6ET-10, BP6HS, BP7EFS, BP7HS, BUR6ET, PFR6Q, PZFR5D-11, PZFR5N-11T, Y-501U, Y-607AS, Y-732U, Y-741U, Y-918R, YE14, ZFR5P-G, ZFR6T-11G
<b>SMART</b>	BKR6EKE, LKR8A, Y-543J, YE13
<b>SSANGYONG</b>	BCP5ES, BKR5EIX, Y-745U, Y-916R
<b>STEYR</b>	B7HS, Y-916R
<b>SUBARU</b>	BKR5E-11, BKR6E-11, BKR6EVX, BPR6ES, BPR6ES-11, BPR7ES, ILFR6B, KR8BI, PFR5B-11, PFR6B, PFR6G, PLFR6A-11
<b>SUZUKI</b>	BKR6E, BKR6E-11, BPR5ES, BPR5EY, BPR6ES, BPR6ES-11, DCPR7E, DCPR7EVX, IFR5E-11, IFR5J-11, IFR6E-11, IFR6J11, IFR6J-11, Y-504R, Y-515J, Y-701R, Y-923U, YE06
<b>TALBOT</b>	BP6EFS, BP6ES, BP6HS, BP7ES, BPR6ES, Y-208T, Y-902R
<b>TOFAS</b>	BP6ES, BPR6ES
<b>TOFAS / FIAT</b>	BKR5EK, BKR5EZ, BKR6EKC, BKR6EZ, DCPR8E-N
<b>TOYOTA</b>	BCPR5EP-11, BCPR5EP-8, BCPR5EY, BCPR6EP-11, BCPR6EP-13, BCPR6EY, BCPR6EY-11, BCRE527Y, BKR5EKB-11, BKR5EP-11, BKR5EYA, BKR5EYA-11, BKR6EKB-11, BKR6EKP-11, BKR6EP-11, BKR6EP-13, BKR6EP-8, BKR6EYA, BKR6EYA-11, BP5EY, BPR4EY, BPR5EA-L, BPR5EP-11, BPR5ES, BPR5EY, BPR5EY-11, BPR6EY, BPR6EY-11, BRE527Y-11, IFR6T-11, LFR6C-11, Y-118R, Y-118T1, Y-128, Y-128T, Y-146R, Y-147T, Y-168R, Y-178, Y-178T, Y-197R, Y-197T, Y-452-1, Y-531J, Y-532J, Y-542J, Y-703R, Y-715R, Y-928U



<b>TRIUMPH</b>	BP5ES, BP6ES, BP6HS
<b>TVR</b>	B7ECS, BCPR6ES, BPR6EFS, BPR6ES, DCPR8E
<b>UAZ</b>	B5HS, BPR5ES, Y-902R, Y-909R
<b>VAUXHALL</b>	BKR5EK, BKR5EQUPA, BKR6EK****, BKR6EQUP, BP6ES, BP6FS, BP6HS, BPR5ES, BPR6ES, BPR6FS, BPR6HS, CY03, PFR6T-10G, PLFR6C-10G, PTR5A-10, Y-306R, Y-307R, Y-515J, Y-517J, Y-523J, Y-534J, Y-541J, Y-710J, Y-711RS, Y-748U, Y-902R, Y-904M1, Y-917U, Y-924U, Y-935U, ZFR5F
<b>VENTURI</b>	BP7EFVX, R5724-9
<b>VOLVO</b>	B6S, B7S, BCPR6E, BCPR6ES, BCPR6ET, BCPR7ES, BKR6EKUB, BKR6ES, BKR6EVX, BKR7E, BKR7EVX, BP5E, BP6ES, BP6HS, BP7EFS, BP7HS, BPR5E, BPR5ES, BPR6EFS, BPR6ES, BPR7ES, ITR6F-13, IZFR6B, LFR6D, PFR6B, PFR6G, PLFR6A-11, Y-515J, Y-732U, Y-913M, Y-918R, Y-932R, Y-933R, YE04, YE12, ZGR5B
<b>VW</b>	B5ES, B5HS, B6ES, B6HS, BCP7ET, BKR5E, BKR5EKU, BKR5EKUP, BKR5EVX, BKR6E, BKR6EKUB, BKR6EKUE, BKR6EQUA, BKUR5ET, BKUR6ET-10, BKUR7ET, BP5ES, BP6ES, BP6ESZ, BP7ES, BPR5EKU, BPR5EY-11, BUR5ET, BUR5ET-10, BUR6ET, ILZKR7A, IZKR7B, PFR6Q, PZFR5D-11, PZFR5J-11, PZFR5N-11T, PZFR6J-11, Y-501U, Y-607AS, Y-609AS, Y-732U, Y-741U, Y-918R, YE14, ZFR5P-G, ZFR6S-Q, ZFR6T-11G
<b>WARTBURG AWE</b>	B6HS
<b>YUGO</b>	BP6ES, BPR6ES
<b>Z.A.Z.</b>	BP6ES, BP6HS
<b>ZASTAVA</b>	BP6ES, BP6HS, BPR6ES
<b>ZUK</b>	Y-403T

**DISCONTINUED SPARK PLUGS**  
**NICHT MEHR PRODUZIERTE ZÜNDKERZEN**  
**RÉFÉRENCES PLUS FABRIQUÉES**  
**BUJÍAS FUERA DE PRODUCCIÓN**  
**TÄNDSTIFT SOM UTGÅTT UR SORTMENTET**

Note : This list contains spark plug types that have been discontinued since 1989. Please make an inquiry concerning these discontinued plugs to our Authorized Representative in your country.

Anmerkung : Diese Liste enthält Zündkerzen, die im Zeitraum von 1989 bis heute nicht mehr produziert werden. Bei Fragen bzgl. dieser Typen kontaktieren Sie bitte Ihren autorisierten NGK-Fachhändler.

Notes : Cette liste contient les références de bougies qui ne sont plus fabriquées depuis 1989. Merci de vous renseigner auprès de notre représentant NGK dans votre pays concernant ces références.

Notas : Esta lista, contiene bujías cuya producción fue interrumpida en 1989. Rogamos consulte a nuestros distribuidores autorizados.

Observera : Denna lista innehåller tändstifts typer som utgått ur produktion och sortiment sedan 1989. Var vänlig vänd Dig till den auktoriserade representanten i Ditt land med eventuella förfrågningar.

Discontinued Plug	Replaced Plug
A-7F	A7FS
A-8F	A8FS
A-9F	A9FS
A5FS	-
A8V	A-8
A9EFP	-
A9V	A-8
AP7FVX	-
APR5FS-11	APR5FS
APR5FS-15	APR5FS
APR6F(Resistor Type)	AP6FS(Non-resistor Type)
AR5FS	-
AU10EFP	-
B-8HN	R5525-8/R5530-8
B-9HN	R5525-9/R5530-9
B-10H	B10HS
B-10HN	R5525-10/R5530-10
B-105HN	R5525-10/R5530-10
B-11HN	R5525-11/R5530-11
B6HV	B6HVX
B7HV	B7HVX
B9HV	B9HVX
B10HV	B10HVX
B4ES-11	B4ES
B4HV	B-4H
B5EB	BR5ES
B5EB-11	BUR5EB-11
B5ES-11	B5ES
B5EV	B5EVX
B6EV	B6EVX
B7EV	B7EVX
B6EB	BR6ES
B6EB-11	BUR6EB-11
B6EB-L-11	BR6EB-L-11
B6EMV	B6EM
B6ET	B6EM
B7EB	BR7ES
B7EB-11	BUR7EB-11
B7EMV	BR7ET
B7ET	BR7ET
B8EMV	BR8ET
B8ES-11	B8ES
B8ET	BR8ET

Discontinued Plug	Replaced Plug
B9S	-
BC9ECS	-
BCP5EV-11	BCP5EVX-11
BCP6EV-11	BCP6EVX-11
BCPR4E-11	BCPR4ES-11
BCPR4ES	BCPR4ES-11
BCPR6ER	BKR6EK
BCPR7ER	BKR6EK
BK5EKU	BKR5EKU
BKR7EY-11	BKR7E-11
BM4A-10	BM4A
BMR7F(Resistor Type)	BM7F(Non-resistor Type)
BP2HA	BP2HS
BP4EQ-13	BP4ES-11/BPR4ES-13
BP4ES-13	BPR4ES-13
BP4HK	BP4HSA
BP5EQ-13	BP5ES-13
BP5ES-L	BP5EY
BP6EQ-13	BP6ES-11/BP6ES-13
BP6HK	BP6HSA
BP7EFS-13	BP7EFS
BP7EQ-13	BP7ES-11
BP7EY-11	BPR7EY-11
BP7HV	BP7HVX
BP6HV	BP6HVX
BP8ES-11	BP8ES
BP5EV	BP5EVX
BP7EV	BP7EVX
BP8EV	BP8EVX
BP8HK	BP8HSA
BP9EV	BPR9EVX
BP10ES	BPR10EVX
BP10EV	BPR10EVX
BPM7	BPM7A
BPR4ES-L-11	BPR5ES-11
BPR4FS-20	BPR4FS-15
BPR4S(Resistor Type)	BP-4(Non-resistor Type)
BPR4S-15(Resistor Type)	BP-4(Non-resistor Type)
BPR4S-20	-
BR8HV	BR8HVX
BPR5EV	BPR5EVX
BPR6EV	BPR6EVX
BPR5ES-15	BPR5ES-13

Discontinued Plug	Replaced Plug
BPR5ES-15	BPR5ES-13
BPR5S(Resistor Type)	BP5S(Non-resistor Type)
BPR5S-15(Resistor Type)	BP5S(Non-resistor Type)
BPR6ES-N-11	BPR6ES-11
BPR6FS-10	BPR6FS
BPR6FS-15	BPR6FS
BPR6S(Resistor Type)	BP6S(Non-resistor Type)
BPS-6E	-
BPZ9H-N-10	-
BR4ES-11	BR4ES
BR5EB	BR5ES
BR5EB-11	BUR5EB-11
BR5ES-11	BR5ES
BR6EB	BR6ES
BR6EB-11	BUR6EB-11
BR6EB-L	BR7ES
BR7EB	BR7ES
BR7EB-11	BUR7EB-11
BR7ES-11	BR7ES
BS-7HR	-
BU5EB-11	BUR5EB-11
BU6EB-11	BUR6EB-11
BU7EB-11	BUR7EB-11
BU8ET-Q	BP8ES
BU10H	-
BUEW	BUE
BZ8ES	BR8ES
BZ9ES	BR9ES
BZ9EV	BR9EVX
C-6M(Thread reach 13.7mm)	C6HSA(Thread reach 12.7mm)
C-10H	-
C-12H	-
C-13H	-
C-14H	-
C7HV	C7HVX
C8HV	C8HVX
D-12E	R216-12/R217-12
D-12H	-
D-13E	-
D-14E	-
D7EV	D7EVX
D8EV	D8EVX
D9EV	D9EVX



**PS/HP ↔ kW**

<b>PS/HP</b>	<b>kW</b>	<b>kW</b>	<b>PS/HP</b>
1	0,736	1	1,360
30	22,065	20	27,192
35	25,742	25	33,991
40	29,420	30	40,789
45	33,097	35	47,587
50	36,775	40	54,385
55	40,452	45	61,183
60	44,130	50	67,981
65	47,807	55	74,779
70	51,485	60	81,577
75	55,162	65	88,375
80	58,840	70	95,173
85	62,517	75	101,972
90	66,195	80	108,770
95	69,872	85	115,568
100	73,550	90	122,366
105	77,227	95	129,162
110	80,905	100	135,962
115	84,582	105	142,760
120	88,260	110	149,558
125	91,937	115	156,356
130	95,615	120	163,154
135	99,292	125	169,953
140	102,970	130	176,751
145	106,647	135	183,549
150	110,325	140	190,347
155	114,002	145	197,145
160	117,680	150	203,943
165	121,357	155	210,741
170	125,035	160	217,539
175	128,712	165	224,337
180	132,390	170	231,135
185	136,067	175	237,934
190	139,745	180	244,732
195	143,422	185	251,530
200	147,100	190	258,328
205	150,777	195	265,126
210	154,455	200	271,924
215	158,132	205	278,722
220	161,810	210	285,520
225	165,487	215	292,318
230	169,165	220	299,116
235	172,842	225	305,915
240	176,520	230	312,713
245	180,197	235	319,511
250	183,875	240	326,309
255	187,552	245	333,107
260	191,230	250	339,905
265	194,907	255	346,703
270	198,585	260	353,501
275	202,263	265	360,299









# INFO

## Übersetzung/Translation

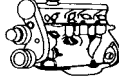
(D)	(GB)	(D)	(GB)
* nur über Vertragshändler	only by car dealer	Langgewinde	3/4 Reach
◆ ohne Wegfahrsperre	without immobilizer	Laubsauger	Vacuum Cleaners
△ mit Wegfahrsperre	with immobilizer	Luftbesen	Air Blower
<b>AGR</b> (Abgasrückführung)	exhaust-gas recirculation	Magermix	Lean Burn
alle Modelle	all Models	Mehrzweckmotor	Multiengine
Allwegtransporter	Allwaytransporters	mit	with
<b>APS</b> (Klopffregelung)	knock control	mit 3 Wege Cat.	with 3 way cat.
Astschneider	Treecutter	Modell	Model
Aufsitzmäher	Ride-on-mower	Mot./Motor	engine
Balkenmäher	Brush cutter	Motorhacke	Cultivators
Cat.	Catalytic converter	Multischneider	Multicutter
<b>DI</b> (Stecker-Spulen-Einheit)	direct ignition	o. Cat.	without Catalyst
<b>EGR</b> (Abgasrückführung)	exhaust-gas recirculation	ohne	without
Erdbohrer	Earthbore	ohne 3 Wege Cat.	without 3 way cat.
Fernbedienung	Remote Control	PS	horse power
Fgst (Fahrgestellnummer)	Chassis No.	QGS Typ	quick glow system
Gartentraktor	Power-Cart	Rasentraktor	Turf-Tractor
Gebläse	Power Blowers	Schneefräse	Snow Thrower
Hacke	Motor Hoe	Sprayer	Sprayer
Häcksler	Grinder	Traktor	Tractor
Heckenschere	Hedgwe trimmer	Trennsäge	Cut Off Saw
Holzspalter	Wood Splitters	Trennschleifer	Cut Off Saw
Kantenschneider	Edge Trimmers	Vertikutierer	Lawn Scanifiers
Katalysator	Catalytic converter	Vorsatzmotor	Multiengine
Konisch	Conical seat	Wasserpumpe	Waterpump
Kraftgebläse	Power Blowers	Wiesenmäher	Turf-Cutters
Kühlaggregat	Refrigeration engine	Zylinder	cylinder
Kurzwende	1/2 Reach	Zylindrisch	Flat seat







## Last Info

										
	l	KW			Cyl.		Order- No.	No.	Bic <sup>1)</sup>	Order- No.
<b>ALFA ROMEO</b>										
Spider MY06	2.2	136	01.06 -	939A5000	4		FR5CP	6368		
<b>AUDI</b>										
A 4	1.8	118	11.07 -	CABB	4	0,8	PFR6S-8E			
A 4	1.8	118	11.07 -	CABB	4	0,8	PFR6S-8E			
A 5	1.8	125	10.07 -	CABD	4	0,8	PFR6S-8E			
Q 7 TDI	3.0	155	11.07 -	CASB	6	☑	Y-609AS	5849	D-POWER 49	5849
Q 7 TDI	3.0	155	11.07 -	CASB	6	☑	Y-609AS	5849	D-POWER 49	5849
Q 7 TDI	3.0	177	11.07 -	CASA	6	☑	Y-609AS	5849	D-POWER 49	5849
<b>BMW</b>										
118 i E81	2.0	105	04.07 -	N46 B20	4	1,1	IZFR6H11	4294		
Z 4 E85	2.5	130	07 -	N52 B25	6	1,1	ILZFR6D11	1208		
<b>CHEVROLET</b>										
Alero	3.4		03.99 -	LA1	6	1,5	TR55	1048	TR55IX	7164
<b>CHRYSLER</b>										
300 M	2.7	150	08.00 -09.04	V6 EER	6	1,3	LZTR5A-13	4612		
<b>FIAT</b>										
500	1.4	102	05.08 -	198A1000	4	0,8	IKR9F-8	5756		
Bravo 1.4 T-jet	1.4	110	04.07 -	198A1000	4	0,8	IKR9F-8	5756		
Grande Punto	1.4	70	09.05 -	199A6000	4	1,0	ZKR7A-10	1691		
Grande Punto	1.4	88	06.07 -	198A4000	4	0,8	IKR9F-8	5756		
Panda 100 HP	1.4	74	06.07 -	169A3000	4	1,0	DCPR7EN-10	4983		
Punto Natural Power	1.2	44	02.05 -	188A4000	4	1,0	DCPR7EN-10	4983		
Sedici	1.6	79	09.05 -	M16A	4	1,1	IFR6J11	7658		
<b>LAMBORGHINI</b>										
Gallardo Coupé	5.0	382	05.05 -	L140	10		PFR7G			
Gallardo Coupé Superleggera	5.0	390	06.07 -	L140	10		PFR7G			
Gallardo Spider	5.0	382	05.05 -	L140	10		PFR7G			
<b>MERCEDES</b>										
SL 350 (230)	3.5	200	05.05 -	M 272.966	6	0,8	PLKR7A	4288		
<b>NISSAN</b>										
Cedric	2.5		06.00 -	VQ25DD	4	1,1	FR5BP-11	6247		
Cefiro	2.5		06.00 -	VQ25DD	4	1,1	FR5BP-11	6247		
Gloria	2.5		06.00 -	VQ25DD	4	1,1	FR5BP-11	6247		
Qashqai 1.6	1.6	84	02.07 -	HR16DE	4	1,1	PLZKAR6A-11	5118		
Qashqai 2.0	2.0	104	02.07 -	MR20DE	4	1,1	PLZKAR6A-11	5118		
Tiida 1.6	1.6	81	01.08 -	HR16DE	4	1,1	PLZKAR6A-11	5118		
Tiida 1.8	1.8	93	01.08 -	MR18DE	4	1,1	PLZKAR6A-11	5118		
<b>OPEL</b>										
Astra G	2.2	108	09.00 - 06	Z22SE	4	1,0	LTR6B-10T	5948		
Signum	2.2	108	05.03 -	Z22SE	4	1,0	LTR6B-10T	5948		
Speedster	2.2	108	04.00 - 06	Z22SE	4	1,0	LTR6B-10T	5948		
Vectra B	2.2	108	08.00 -	Z22SE	4	1,0	LTR6B-10T	5948		
Vectra C 16V	2.2	108	08.02 -	Z22SE	4	1,0	LTR6B-10T	5948		
Vivaro DTI	2.5	98	05.03 -	G9U - 730	4	☑	Y-517J	3319		
Zafira 16V	2.2	108	08.00 - 06	Z22SE	4	1,0	LTR6B-10T	5948		
Zafira B CNG	1.6	69	05 -	Y16YNG	4		BKR6EIX-LPG	3356		

<sup>1)</sup> Bic = Best in class (siehe Seite 3) / (see page 3)

## Last Info

	<i>l</i>	kW			Cyl.		Order- No.		Bic <sup>1)</sup>	Order- No.
<b>OPEL</b>										
Zafira B CNG	1.6	69	05 -	Y16YNG	4		BKR6EIX-LPG	3356		
<b>SAAB</b>										
9-3 Turbo Bio Power	1.8	129	09.06 -		4	1,1	BCPR7ES-11	1095		BCPR7EVX-11 4485
9-3 Turbo Bio Power	2.0	147	07.07 -	Z20NFL	4	1,1	BKR7ESC-11	6313		
9-3 Turbo Bio Power	2.0	147	07.07 -	Z20NFL	4	1,1	BKR7ESC-11	6313		
9-5 Bio Power	2.0	132	07.07 -	A20NHL	4	1,1	BKR7ESC-11	6313		
9-5 Bio Power	2.0	132	07.07 -	A20NHL	4	1,1	BKR7ESC-11	6313		
9-5 Bio Power	2.3	155	09.06 -		4	1,1	BCPR7ES-11	1095		BCPR7EVX-11 4485
9-5 Bio Power	2.3	155	09.06 -		4	1,1	BCPR7ES-11	1095		BCPR7EVX-11 4485
<b>SEAT</b>										
León FSI	2.0	110	07.05 - 11.05	BLR	4	1,1	PZFR5N-11TG			
León FSI	2.0	110	11.05 -	BVZ	4	1,1	PZFR5N-11TG			
León FSI	2.0	110	11.05 - 05.06	BVY	4	1,1	PZFR5N-11TG			
León FSI	2.0	110	07.05 - 11.05	BLY	4	1,1	PZFR5N-11TG			
<b>SUBARU</b>										
Impreza 1.5R	1.5	79	09.07 -	EJ15	4	0,8	ILFR6B	6481		
Impreza 2.0R	2.0	110	09.07 -	EK20	4	0,8	ILFR6B	6481		
Impreza 2.5	2.5	169	08 -	N/A	4	0,8	ILFR6B	6481		
Impreza WRX Sti	2.5	206	06 -	EJ25	4	0,8	ILFR6B	6481		
Impreza WRX Turbo	2.0	169	06 -	EJ25	4	0,8	ILFR6B	6481		
Justy 1.0	1.0	52	07 -	1KR-FE engine daihatsu	3	1,1	LFR6C-11	5788		
Justy 1.0	1.0	52	07 -	1KR-FE engine daihatsu	3	1,1	LFR6C-11	5788		
<b>VOLVO</b>										
S 60 Bi-Fuel CNG (DK)	2.4	103	06.00 -	B5244SG	5		BKR6EIX-LPG	3356		
S 60 Bi-Fuel LPG	2.4	103	06.02 -	B5244SG2	5		BKR6EIX-LPG	3356		
<b>VW</b>										
Eos FSI	1.6	85	05.06 -	BLF	4		ZFR6S-Q	6449		
Golf 5	1.6	75	11.07 -	CCSA	4	1,0	BKUR6ET-10	2397	24	PFR6Q 6458
Golf 5 GTI	2.0	169	09.06 -	BYD	4	0,8	PFR6S-8E			
Jetta (New)	1.4	90	07.07 -	CAXA	4	0,9	PZFR6R	5758		
Passat 5 TFSI (Typ 3C)	1.4	90	05.07 -	CAXA	4	0,9	PZFR6R	5758		
Polo 4 (Typ 9N)	1.2	52	05.07 -	BZG	3	0,9	ZFR5P-G	6893		
Polo 4 (Typ 9N) TDI	1.9	74	05.06 -	BMT	4	█	Y-607AS	9776		D-POWER 50
Tiguan FSI	1.4	110	11.07 -	BWK	4	0,9	PZFR6R	5758		
Tiguan FSI	1.4	110	11.07 -	BWK	4	0,9	PZFR6R	5758		
Tiguan TDI	2.0	100	11.07 -	CBAA	4	█	Y-609AS	5849		D-POWER 49 5849
Tiguan TDI	2.0	100	11.07 -	CBAA	4	█	Y-609AS	5849		D-POWER 49 5849

<sup>1)</sup> Bic = Best in class (siehe Seite 3) / (see page 3)



# D-POWER<sup>NGK</sup>



[www.ngk.de](http://www.ngk.de)  
[www.ngk.es](http://www.ngk.es)  
[www.ngk.fi](http://www.ngk.fi)  
[www.ngkntk.fr](http://www.ngkntk.fr)  
[www.ngkntk.it](http://www.ngkntk.it)  
[www.ngkntk.nl](http://www.ngkntk.nl)  
[www.ngkntk.pl](http://www.ngkntk.pl)  
[www.ngk.ru](http://www.ngk.ru)  
[www.ngk.com.tr](http://www.ngk.com.tr)  
[www.ngk-europe.com](http://www.ngk-europe.com)

NGK SPARK PLUG EUROPE GMBH  
Harkortstr. 41  
40880 Ratingen  
Germany  
Tel. ++49(0)2102/974-000  
Fax ++49(0)2102/974-149  
[www.ngk.de](http://www.ngk.de)



\*A379\*

